



**APPENDIX 2
CONE PENETRATION TEST (CPT) RESULTS
GEOTECHNICAL EXPLORATION PROGRAM
CENTRAL AREA GUIDEWAY**

**SILICON VALLEY RAPID TRANSIT (SVRT) PROJECT
SAN JOSE, CALIFORNIA**

Prepared for:
HMM/Bechtel

JANUARY 2008

Fugro Project No. 1637.001

Disclaimer:

VTA makes no representation or warranty regarding the accuracy of the information provided in this document. VTA provides this information for reference purposes only. You may not rely on this information for any purpose, including but not limited to the preparation of any bids or proposals to VTA. By reviewing this information, you and your employees, agents, representatives, consultants, or contractors assume the risk of use or reliance on the information being provided and bear the sole responsibility for verifying any materials used or relied upon. Neither VTA nor its employees, agents, representatives, consultants or contractors shall be liable for any damages for the use of this information or the viewing or copying of such information.

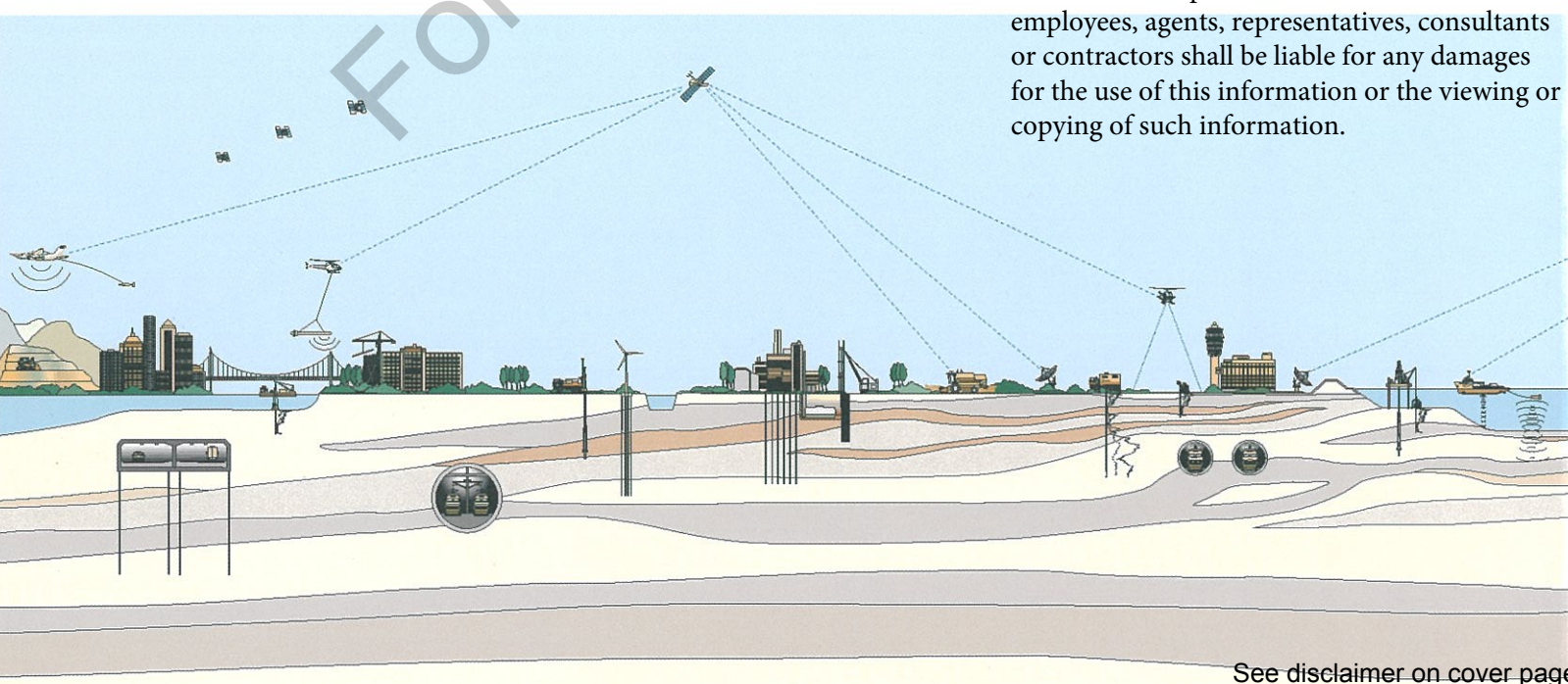





REPORT DOCKET

APPROVAL

This document is approved by the following:

Name	Title	Signature	Issue Date
Michael Paquette, P.E.	Project Engineer		1/21/08
Edwin Woo, P.E., G.E.	Principal Engineer		1/21/08

REVISION HISTORY

Revision	Date	Change	Approval
0	November 12, 2007	Draft Report: Appendix 8 Cone Penetration Test (CPT) Results. Incorporating Phase 2 (2007) CPTs	MP
1	January 21, 2008	Appendix 2 Cone Penetration Test (CPT) Results. Incorporating Phase 2 (2007) CPTs	MP





January 21, 2008
Project No. 1637.001

HMM/Bechtel
3103 North First Street
San Jose, California 95134

Attention: Mr. Thomas Hunt, P.E.

Subject: Appendix 2 – Cone Penetration Test (CPT) Results, Central Area Guideway of SVRT Project, San Jose, California

Dear Mr. Hunt:

Fugro is pleased to submit this copy of "Appendix 2 – Cone Penetration Test (CPT) Results," describing the CPT test equipment, procedures and results for the Central Area Guideway of the SVRT Project in San Jose, California.

We appreciate this opportunity to be of continued service to HMM/Bechtel. Please contact Michael Paquette at (510) 267-4441 if you have any questions regarding the information presented in this appendix.

Sincerely,

FUGRO WEST, INC.

A handwritten signature in black ink, appearing to read "Michael Paquette".

Michael Paquette, P.E.
Project Engineer

A handwritten signature in blue ink, appearing to read "Edwin P. Woo".

Edwin P. Woo, P.E., G.E.
Principal Engineer

MP/EW:ej

Copies Submitted: (PDF) Addressee





CONTENTS

	Page
REPORT DOCKET	1
1.0 INTRODUCTION.....	1
1.1 Project Description	1
1.2 Geotechnical Exploration Program Overview.....	1
1.3 CPT Program Overview	2
2.0 CPT TEST EQUIPMENT AND PROCEDURES	3
2.1 CPT Equipment.....	3
2.1.1 CPT Rig.....	3
2.1.2 Piezocone.....	3
2.1.3 Cone Rods and Casing	3
2.1.4 Data Acquisition System	4
2.1.5 Support Equipment.....	4
2.2 Field Procedures	4
2.3 CPT Completion and Abandonment.....	5
3.0 CPT SOUNDING RESULTS AND DISCUSSION	5
3.1 Introduction.....	5
3.2 Estimation of Total In Situ Stress from CPT Data	6
3.3 Evaluation of Soil behavior Type (SBT)	7
3.4 Evaluation of Undrained Shear Strength from CPT Data.....	8
3.4.1 Evaluation of Cone Bearing Factor (N_k)	8
4.0 LIMITATIONS.....	8
5.0 REFERENCES.....	9

TABLES

	Table
Summary of Cone Penetration Test (CPT) Program	A2-1
Summary of Site-Specific Unit Weight/CPT Correlations	A2-2

LOGS OF CPTS

Key to CPT Logs	
CPT Logs	CPT 158 to CPT 179



1.0 INTRODUCTION

This appendix describes the equipment, procedures and results of cone penetration tests (CPTs) conducted by Fugro West, Inc. (Fugro) for the proposed Central Area Guideway of the Silicon Valley Rapid Transit (SVRT) Project. The CPTs were conducted at locations along the Central Area Guideway alignment, as shown on Figure 3-1 of the main report.

1.1 PROJECT DESCRIPTION

The Santa Clara Valley Transportation Authority (VTA) intends to construct the SVRT Project in San Jose, California. This will be a 26.2-km (16.3-mile) extension of the Bay Area Rapid Transit (BART) heavy rail rapid transit system from the planned terminus at the end of the Warm Springs Extension in Fremont, to San Jose. The proposed alignment currently includes several new stations and vehicle storage and maintenance facilities. The alignment is composed of two major segments:

- 1) The "Northern Area" that will be approximately 11.5 miles of at-grade, elevated and cut-and-cover track from Warm Springs to San Jose; and
- 2) The "Central Area Guideway", a 5.1-mile-long tunnel, consisting of twin bored tunnels and cut-and-cover structures through downtown San Jose.

As currently planned, the Central Area Guideway includes at-grade and open cut track, cut-and-cover stations, and a cut-and-cover track crossover structure. The cut-and-cover stations and the crossover structures have a cumulative length of approximately 4,970 feet. The remaining 4.14 miles of the alignment will be twin 19.5-foot-diameter tunnels.

This investigation and report cover the 5.1-mile-long Central Area Guideway only.

1.2 GEOTECHNICAL EXPLORATION PROGRAM OVERVIEW

The joint venture of Hatch Mott MacDonald T & T, Inc., and Bechtel Infrastructure Corporation (HMM/Bechtel) is providing engineering design services for the Central Area Guideway of the SVRT Project to the VTA. HMM/Bechtel has subcontracted with a number of companies to conduct the geotechnical field exploration program for the project. HMM/Bechtel's primary subcontractors for the geotechnical exploration program include: Fugro, Parikh Consultants (Parikh) and Pitcher Drilling Company (Pitcher).

The three companies, Fugro, Parikh, and Pitcher, conducted the majority of the geotechnical field exploration program for the Central Area Guideway of the SVRT Project from October 2004 to March 2005. This supplementary geotechnical field investigation was performed between March 2007 and August 2007. The intent of the field investigation program was to obtain geotechnical data that would aid in the design and construction of the proposed tunnel and cut-and-cover structures.



In general, the geotechnical field investigations explored subsurface conditions along the proposed Central Area Guideway. The explorations were within the vicinity of the proposed Eastern and Western Portals, at the two proposed ventilation structures, and at the proposed stations, including Alum Rock Station, Downtown San Jose Station and Diridon/Arena Station. The geotechnical exploration program included:

- 2004 / 2005 Investigation
 - 76 Rotary Wash Borings (by others); and
 - 146 CPTs (by Fugro).
- 2007 Investigation
 - 18 Rotary Wash Borings (by others); and
 - 22 CPTs (by Fugro).

Figure 3-1 in the main report provides a map of the exploration locations. These locations were selected by HMM/Bechtel based on the following considerations: 1) the requirements of the tunnel designer, 2) the location of existing geotechnical data, 3) reducing impacts on private property, and 4) the avoidance of existing underground and overhead utilities. The locations of the 2007 explorations were chosen to fill in gaps in the data along the tunnel alignment. A subcontractor to HMM/Bechtel surveyed the CPT locations. HMM/Bechtel provided the surveyed coordinates to Fugro.

1.3 CPT PROGRAM OVERVIEW

Fugro West, Inc. and Fugro Consultants, Inc. (formerly Fugro Geosciences, Inc.) conducted the CPTs using a Fugro truck-mounted 25-ton cone apparatus. The CPTs were performed in general accordance with ASTM D5778. The continuous CPT soundings were typically advanced to refusal, which ranged from approximately 34 to 116 feet in depth. In addition to continuous CPT soundings, Fugro also performed downhole seismic shear wave velocity measurements. Downhole seismic shear (S) wave velocity measurements were successfully conducted at 12 CPT locations during the 2007 investigation to obtain profiles of shear wave velocity versus depth. Detailed information regarding the downhole seismic CPTs, including field procedures, data interpretation and results are discussed in Appendix 3 – Seismic Cone Testing.

Detailed procedures and equipment specifications on the CPT operations are discussed in the following sections. Table 1 summarizes the 2007 CPT field testing program and indicates the test location, date of completion, termination depth and additional tests performed for each CPT.



2.0 CPT TEST EQUIPMENT AND PROCEDURES

2.1 CPT EQUIPMENT

Equipment used in conducting CPTs includes:

- A self-contained 25-ton CPT rig. The rig contains the hydraulic pushing system, a power supply unit and other tools, equipment and necessary materials;
- A piezocone (CPTu) capable of measuring tip resistance, sleeve resistance, probe inclination and dynamic pore pressure;
- Cone rods pre-strung with electrical 10-pin copper cable and casing;
- A data acquisition system including an Analog-Digital (A/D) Conversion System and a data logging laptop computer; and
- A support truck and trailer containing a grout pump and mixer, steam cleaning equipment, and a pressure washer.

2.1.1 CPT Rig

The CPTs were performed using a Fugro 25-ton capacity truck-mounted rig with a self-contained power supply unit. The rig was equipped with hydraulic jacking systems to lift and level the pushing platform. The “dead weight” of the rig provided the reaction weight necessary to advance the CPT into the ground.

2.1.2 Piezocone

The conventional instrumented piezocone assembly used for this project included a cone tip with a 60-degree apex and a base area of 15 square centimeters (cm²), a sleeve segment with a surface area of 200 cm², an area ratio of 0.59 to 0.61, and a pore pressure transducer near the base (shoulder) of the cone tip (designated the u2 location).

2.1.3 Cone Rods and Casing

Fugro's CPT cone rods are manufactured from high tensile strength steel and have a cross sectional area adequate to sustain, without buckling, the thrust required to advance the penetrometer tip. Prior to testing, a 10-pin electrical cable is pre-strung through the cone rods, and is connected by a crossover cable to the data acquisition system. Push rods are 1-meter long, and are secured together to bear against one another at the joints to form a rigid jointed string.

The push rods were protected from bending by a steel casing (2 1/8-inch outside diameter and 1 7/8-inch inside diameter), when needed. The casing was used to ensure that the maximum possible depth of testing was reached. The steel casing was generally placed in the upper clayey strata and was extended to depths of 5 to 27 feet, when used.



2.1.4 Data Acquisition System

The data acquisition system used in conducting the CPTs consisted of an electronic signal conditioner, a three-pen analog strip chart recorder, a portable laptop computer, and a printer.

The data acquisition system converts the analog signal from the cone penetrometer to a digital signal. The signal is monitored, recorded and presented in near-real time on the laptop computer. As stipulated in ASTM D-5778-95, a three-pen strip chart recorder monitors and displays in real time the analog signals directly from the cone penetrometer. This provides an accurate recording of the collected data, regardless of the analog to digital conversion. Upon completion of testing, the strip chart record of the analog readings is compared to the digital readings recorded on the laptop computer. This comparison of analog to digital signals provides a quality control system that ensures accurate and highly reliable data including the initial and final calibration zeros.

2.1.5 Support Equipment

The support equipment consisted of a pickup truck and trailer containing the following necessities:

- Grout pump and mixer, to properly abandon the CPT holes after completion;
- Pressure wash system, for cleaning work area when appropriate and maintaining clean equipment throughout exploration program;
- Steam cleaning system, for environmental protocol (as needed); and
- Tools and supplies, for daily operations.

2.2 FIELD PROCEDURES

Prior to the start of testing, the truck was jacked up and leveled on four pads to provide a stable reaction for the cone thrust. During the test, the instrumented cone was hydraulically pushed into the ground at a rate of about 2 centimeters per second (cm/s), and readings of cone tip resistance, sleeve friction, and pore pressure were digitally recorded every second. As the cone advanced, additional cone rods were added such that a "string" of rods continuously advanced through the soil. As the test progressed, the CPT operator monitored the cone resistance and the deviation from vertical alignment.

Information collected during a push was stored digitally as ASCII formatted data on magnetic disks readable by MS-DOS or Windows-based programs that read text files. The data files include project description, location, operator, data format information, and other pertinent information about the sounding.

Following each push, the data collected are presented in a graphical format. The preliminary field logs include:



- Cone tip resistance in tons per square foot (tsf) versus depth in feet;
- Friction sleeve resistance in tsf versus depth in feet;
- Friction ratio in percentage versus depth in feet; and
- Pore pressure in tsf versus depth in feet.

As stipulated in ASTM D-5778-95, the vertical axis on the plots is designated for depth, and the horizontal axis displays the magnitude of the test values recorded. Final plotting scales are determined after all the tests are completed, and takes into consideration maximum test values and depths recorded for the project.

2.3 CPT COMPLETION AND ABANDONMENT

Upon completion of the CPTs, the CPT rig was moved off the location. The holes were backfilled with cement-bentonite grout by the tremie method, starting from the bottom of the hole and filling upward using the grout pump and mixer. When grout approached the surface, the tremie pipe was removed, and the sounding holes were topped off with rapid setting "quickcrete". Grout mix and grouting procedures were completed in accordance with Santa Clara Valley Water District regulations. The work area was then cleaned per City of San Jose requirements and left in about the same or better condition than prior to testing.

3.0 CPT SOUNDING RESULTS AND DISCUSSION

3.1 INTRODUCTION

The CPT logs are attached to this appendix. The CPT logs provide graphical plots versus depth showing:

- Measured cone tip resistance, in tsf;
- Measured sleeve friction, in tsf;
- Friction ratio, in percentage, including color coding denoting the Soil Behavior Type according to Robertson (1990) (see CPT correlation chart);
- Measured pore pressure at the u2 location, in tsf;
- Estimated soil undrained shear strength, in ksf. The sounding logs show the range of undrained shear strengths calculated from CPT cone tip resistance (corrected for unequal end area effects) based on cone bearing capacity factors (N_k) of 12 and 15.

Please note that some of the data presented on the CPT logs are interpreted and based on assumptions that need to be verified with the data from the boring program. The interpreted data presented on the CPT logs include the soil behavior type and the estimated soil undrained shear strength. The estimated soil behavior type and undrained shear strength are influenced by the soil unit weight (and resulting total stress condition). Undrained shear strength is also influenced by the N_k value. These items are discussed in detail below.



3.2 ESTIMATION OF TOTAL IN SITU STRESS FROM CPT DATA

As discussed above, a reasonable estimate of the in situ total stress is required to evaluate the soil behavior type and undrained shear strength using CPT data. To reasonably estimate total stress, a site-specific CPT correlation with unit weight was developed during the 35 percent study. The basic approach to developing the site-specific correlation was to compare measured unit weight from all correlation borings (borings that were located directly adjacent to a CPT) with the CPT zone as determined from the Robertson et al. (1986) soil behavior chart. The unit weight data from the borings were then sorted by zone and averaged to determine a reasonable estimate of unit weight for each zone on the chart. For CPT zones where no laboratory data were available, the zone was assigned a unit weight based on modified estimates of the unit weight correlations provided in Lunne et al. (1997). The following table provides a summary of the site-specific unit weight correlations for each zone of the Robertson et al. (1986) CPT tip resistance-based chart.

Table A8-2. Summary of Site-Specific Unit Weight/CPT Correlations from 35 Percent Study – Fugro (2005)

Zone Number	Material Description	Site-Specific Unit Weight Correlation (lbs/ft ³)
1	Sensitive fine grained	115
2	Organic material	85
3	Clay	122
4	Silty clay to clay	124
5	Clayey silt to silty clay	124
6	Sandy silt to clayey silt	126
7	Silty sand to sandy silt	127
8	Sand to silty sand	127
9	Sand	130
10	Gravelly sand to sand	135
11	Very stiff fine grained	127
12	Sand to clayey sand	127

Note: Zone number and material description are based on Robertson et al. (1986) proposed soil behavior classification system (tip resistance and friction ratio).

The unit weight correlations above were used to develop a unit weight profile for each CPT from which the total stress profile was developed. To verify the above unit weight correlation and confirm that these values resulted in reasonable estimates of total stress, profiles of unit weight and total stress were developed as part of the 35 percent study, and summarized in Fugro (2005).



3.3 EVALUATION OF SOIL BEHAVIOR TYPE (SBT)

The Soil Behavior Type (SBT) shown on the CPT logs was evaluated using the Robertson (1990) correlation. The Robertson (1990) correlation requires two corrections be applied to the recorded cone data. The first correction is for pore pressures behind the cone and the second correction is for overburden.

The first correction is calculated using the following expression:

$$q_t = q_c + u(1 - a)$$

Where: q_t = Corrected cone resistance, tsf
 q_c = Measured cone resistance, tsf
 u = Measured pore pressure, tsf
 a = Cone area ratio, dimensionless

The second correction calculates a normalized cone penetration resistance and a normalized friction ratio. The normalized cone penetration resistance is calculated using the following expression:

$$Q_t = \frac{q_t - \sigma_{vo}}{\sigma'_{vo}}$$

Where: Q_t = Normalized cone penetration resistance, dimensionless
 q_t = Corrected cone resistance, tsf
 σ_{vo} = Estimated in situ total vertical stress, tsf
 σ'_{vo} = Estimated in situ effective vertical stress, tsf

The normalized friction ratio is calculated using the following expression:

$$F_r = \left(\frac{f_s}{q_t - \sigma_{vo}} \right) \times 100\%$$

Where F_r = Normalized friction ratio, percent
 f_s = Measured sleeve friction, tsf
 q_t = Corrected cone resistance, tsf
 σ_{vo} = Estimated in situ total vertical stress, tsf

The normalized tip resistance and friction ratio are plotted on the Robertson (1990) chart, as shown on the attached Key to CPT Logs, to estimate the Soil Behavior Type.



3.4 EVALUATION OF UNDRAINED SHEAR STRENGTH FROM CPT DATA

Undrained shear strength has been estimated from the CPT measurements using the following expression:

$$S_u = \frac{q_t - \sigma_{vo}}{N_k}$$

- Where:
- S_u = Undrained shear strength, ksf
 - q_t = Cone tip resistance, ksf
 - σ_{vo} = Estimated in situ total vertical stress, ksf
 - N_k = Empirical cone bearing factor, dimensionless

In order to estimate the soil's undrained shear strength using the above relationship, the cone bearing factor (N_k) and in situ total stress (σ_{vo}) need to be determined. The following discussion summarizes the approaches used to reasonably estimate these quantities.

3.4.1 Evaluation of Cone Bearing Factor (N_k)

A range of interpreted undrained shear strength (S_u) from CPT tip resistances for empirical cone bearing factor (N_k) ranging from 12 to 15, are plotted on the CPT logs. The range of selected N_k values was based on a comparison of S_u estimated from the CPT tip resistance and the S_u determined from vane shear testing in the borings. This comparison was completed as part of the 35 percent study, as summarized in Fugro (2005).

4.0 LIMITATIONS

Our services consist of subsurface field explorations and data evaluations that are made in accordance with generally accepted geotechnical engineering principles and practices. This warranty is in lieu of all other warranties, either expressed or implied.

The data provided in this appendix are based on the subsurface explorations conducted for this study. These explorations indicate subsurface conditions only at specific locations and times, and only to the depths penetrated. Variations may exist and conditions not observed or described in this report could be encountered during construction. Our results are based on our standard practices and specific data obtained.

This appendix has been prepared for the exclusive use of HMM/Bechtel and their consultants for specific application to the SVRT project as described herein. In the event that there are any changes in the ownership, nature, design, or location of the proposed project, or if any future additions are planned, the results contained in this appendix should not be considered valid unless: 1) the project changes are reviewed by Fugro, and 2) results presented



in this appendix are modified or verified in writing. Reliance on this report by others must be at their risk unless we are consulted on the use or limitations. We cannot be responsible for the impacts of any changes in geotechnical standards, practices, or regulations subsequent to performance of services without our further consultation. We can neither vouch for the accuracy of information supplied by others, nor accept consequences for unconsulted use of segregated portions of this report.

5.0 REFERENCES

Fugro West, Inc. (2005), "Appendix 8 Cone Penetration Test (CPT) Results, Geotechnical Exploration Program, Tunnel Segment of Silicon Valley Rapid Transit (SVRT) Project, San Jose, California" Prepared for HMM/Bechtel, Fugro Project No. 1637.001

Lunne, Robertson & Powell (1997), *Cone Penetration Testing in Geotechnical Practice*, Blackie Academic & Professional, London, UK.

Robertson, P.K., Campanella, R.G., Gillespie, D. and Greig, J. (1986), "Use of Piezocone Data," Proceedings of the ASCE Specialty Conference In Situ 1986: Use of In Situ Tests in Geotechnical Engineering, Blacksburg, pp.1263-80.

Robertson, P.K., (1990), "Soil Classification using the Cone Penetration Test," *Canadian Geotechnical Journal*, 27



CPT No.	Station	Offset		Coordinates			In-Situ Test	Insitu Test Depths (ft)	CPT Completed	Casing Depth (ft)	Final Depth (ft)	Comments
		(ft)	R/L	Northing	Easting	Elev.						
CPT - 158	562+47	30	L	1956837	6162889	91.6	Seismic	Every 3 ft.	4/3/2007		45.0	
CPT - 159	563+48	29	L	1956741	6162916	91.1			4/4/2007		45.4	
CPT - 160	565+39	37	L	1956567	6162986	89.4			4/4/2007		45.4	
CPT - 161	568+89	26	L	1956251	6163128	87.3	Seismic	Every 3 ft.	4/3/2007		105.0	
CPT - 162	600+72	140	L	1953716	6164945	87.1	Seismic	Every 3 ft.	8/13/2007		73.2	
CPT - 163	636+50	66	L	1950985	6163027	93.4			3/31/2007		95.1	
CPT - 164	639+64	50	L	1950828	6162753	94.9			3/28/2007		86.0	
CPT - 165	642+21	41	L	1950703	6162527	96.1	Seismic	Every 3 ft.	8/16/2007		77.4	
CPT - 166	649+12	48	L	1950358	6161926	85.6			3/29/2007		89.2	
CPT - 167	701+09	11	R	1947883	6157354	86.7	Seismic	Every 5 ft.	4/1/2007		90.7	
CPT - 168	734+51	100	L	1946017	6154586	87.8	Seismic	Every 3 ft.	4/5/2007		149.9	
CPT - 169	706+79	145	L	1947464	6156937	89.0	Seismic	Every 3 ft.	8/17/2007		85.4	
CPT - 170	793+77	48	R	1949598	6150886	76.5			3/30/2007	5 ft.	43.7	
CPT - 171	794+96	42	R	1949684	6150804	75.1	Seismic	Every 3 ft.	3/30/2007		74.8	
CPT - 172	607+63	66	R	1953024	6164741	88.0	Seismic	Every 3 ft.	8/16/2007		113.4	
CPT - 173	828+06	91	L	1951765	6148281	69.9	Seismic	Every 3 ft.	3/29/2007		38.4	CPT redone due to early refusal.
CPT - 173A	828+02	92	L	1951762	6148283	69.8			3/31/2007		33.8	
CPT - 173B	Not Surveyed								3/31/2007		81.5	Piezo Cone used after refusal of Seismic Cone
CPT - 174	834+47	21	L	1952160	6147771	67.4	Seismic	Every 3 ft.	3/31/2007		55.6	
CPT - 174A	Not Surveyed								3/31/2007	27 ft.	69.4	Piezo Cone used after refusal of Seismic Cone
CPT - 175	835+68	20	L	1952223	6147669	67.3			3/28/2007		80.5	
CPT - 176	837+51	16	L	1952322	6147514	66.8			3/28/2007		45.5	
CPT - 177	838+86	19	L	1952391	6147398	66.4			3/30/2007		45.5	
CPT - 178	841+50	15	L	1952479	6147259	66.1			3/29/2007		45.5	
CPT - 179	740+58	109	L	1945918	6153987	91.5	Seismic	Every 3 ft.	8/14/2007		115.5	

Table A2-1

SUMMARY OF CONE PENETRATION TEST (CPT) PROGRAM
 Central Area Guideway of Silicon Valley Rapid Transit (SVRT) Project
 San Jose, California



For Reference Only

LOGS OF CPTs

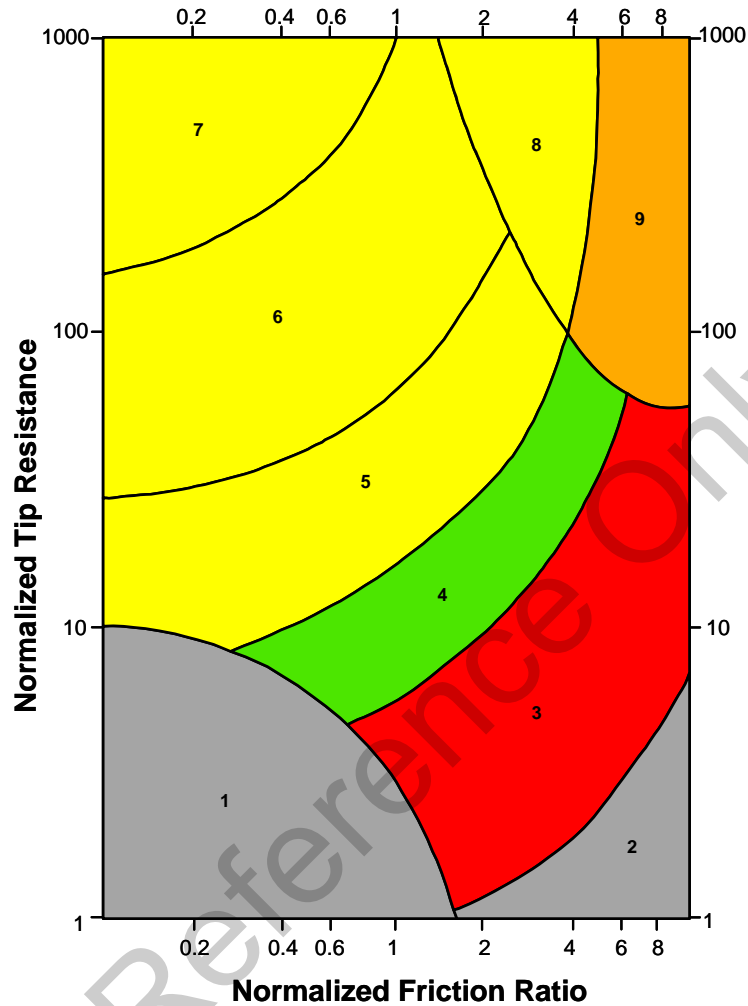

Zone	Soil Behavior Type
1	Sensitive Fine-grained
2	Organic Material
3	Clay to Silty Clay
4	Clayey Silt to Silty Clay
5	Silty Sand to Sandy Silt
6	Clean Sands to Silty Sands
7	Gravelly Sand to Sand
8	Very Stiff Sand to Clayey Sand *
9	Very Stiff Fine-grained *

*overconsolidated or cemented

CPT CORRELATION CHART
(Modified from Robertson, 1990)

KEY TO CPT LOGS
Central Area Guideway of SVRT Project
San Jose, California

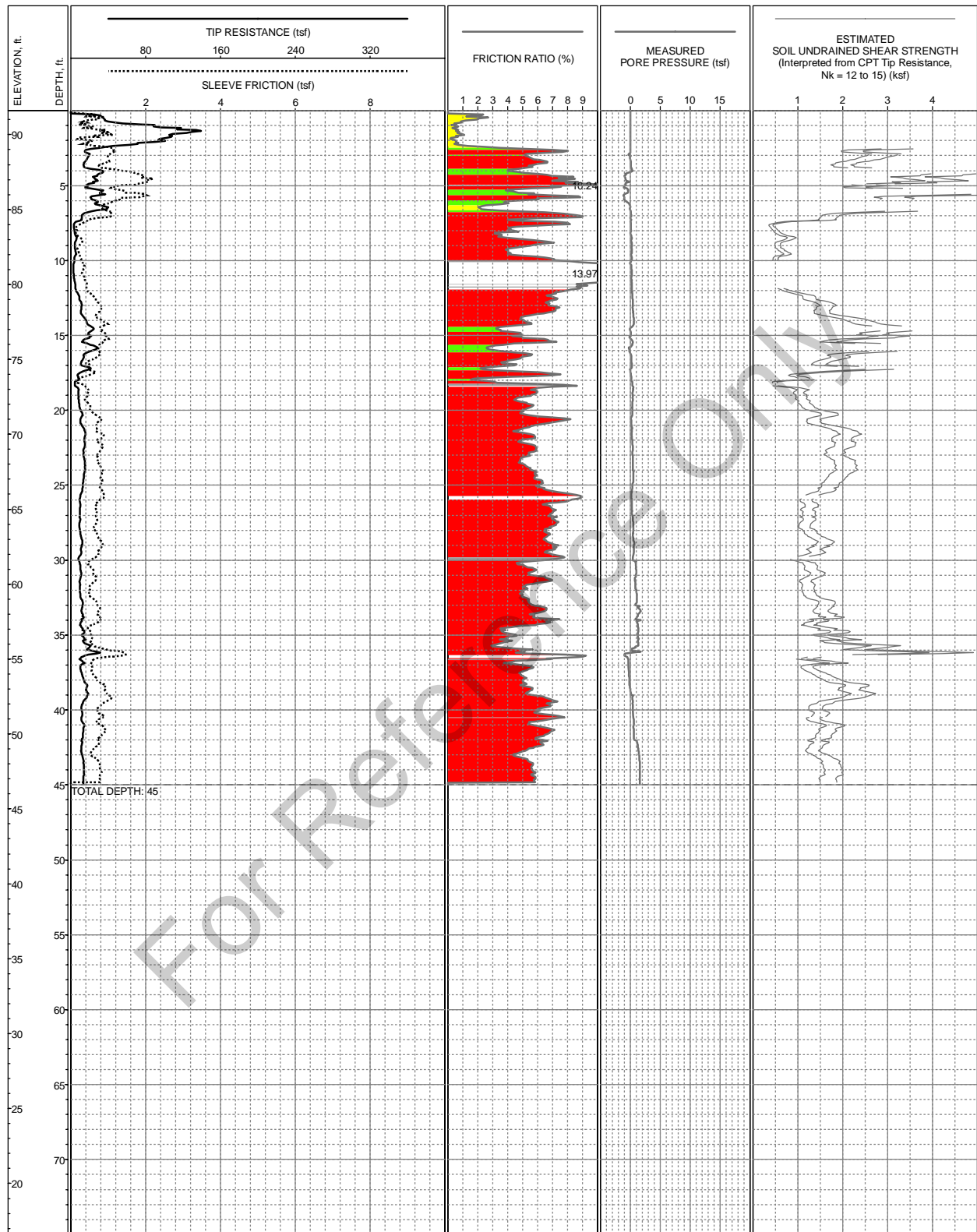

LOCATION: E6162888.9 N1956837.2 (NAD83, CA State Plane Zone III, Feet)
 SURFACE EL: 91.6ft (NAVD88)
 COMPLETION DEPTH: 45ft
 TEST DATE: 4/3/2007

CONE: F7.5CKESW1645
 PERFORMED BY: Fugro Consultants, Inc.
 OPERATOR: D Garza & R Norris
 REVIEWED BY: M Paquette

LOG OF CPT-158
 Central Area Guideway of SVRT Project
 San Jose, California

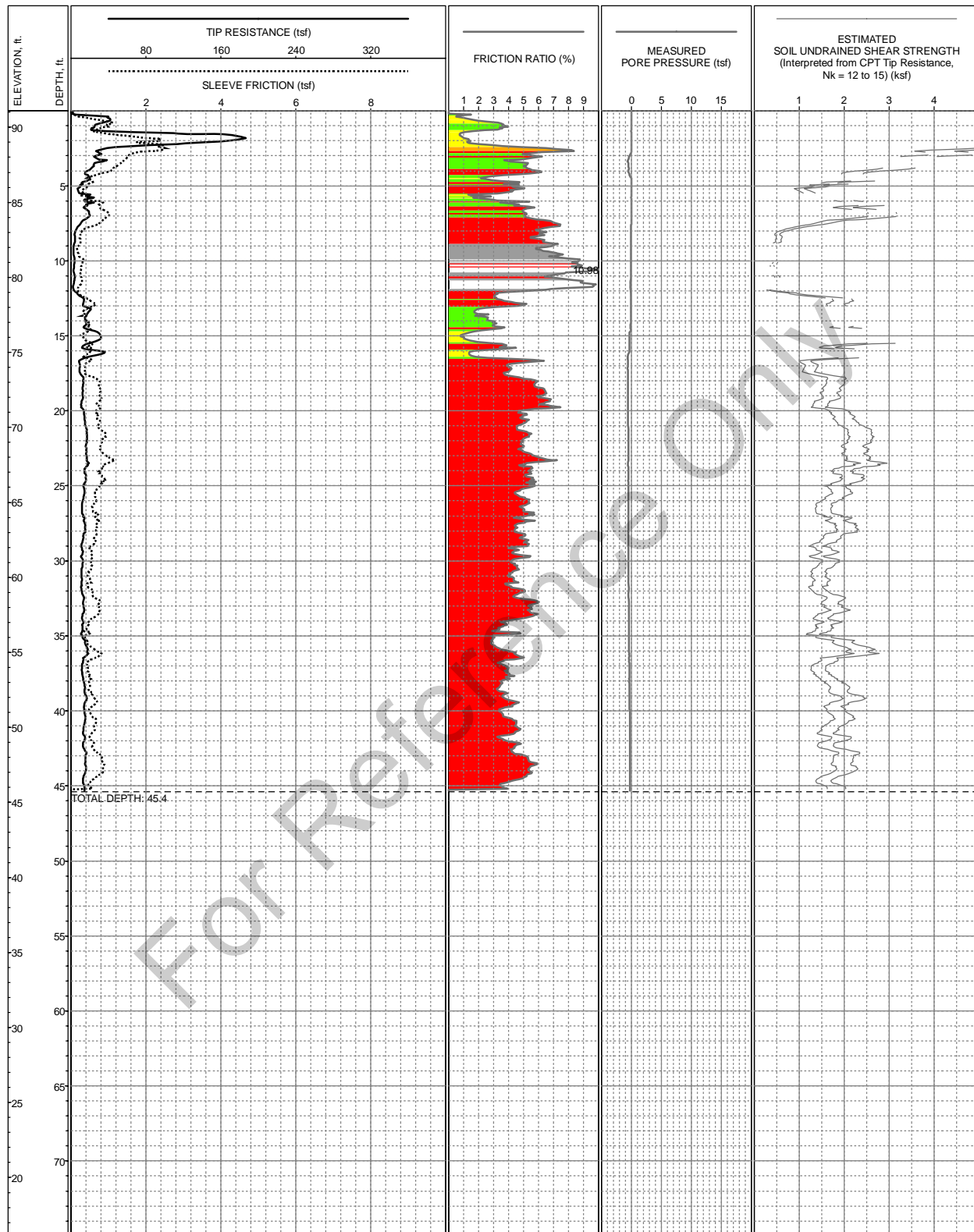

LOCATION: E6162916.2 N1956740.9 (NAD83, CA State Plane Zone III, Feet)
 SURFACE EL: 91.1ft (NAVD88)
 COMPLETION DEPTH: 45.4ft
 TEST DATE: 4/4/2007

CONE: F7.5CKEW1689
 PERFORMED BY: Fugro Consultants, Inc.
 OPERATOR: D Garza & R Norris
 REVIEWED BY: M Paquette

LOG OF CPT-159
 Central Area Guideway of SVRT Project
 San Jose, California

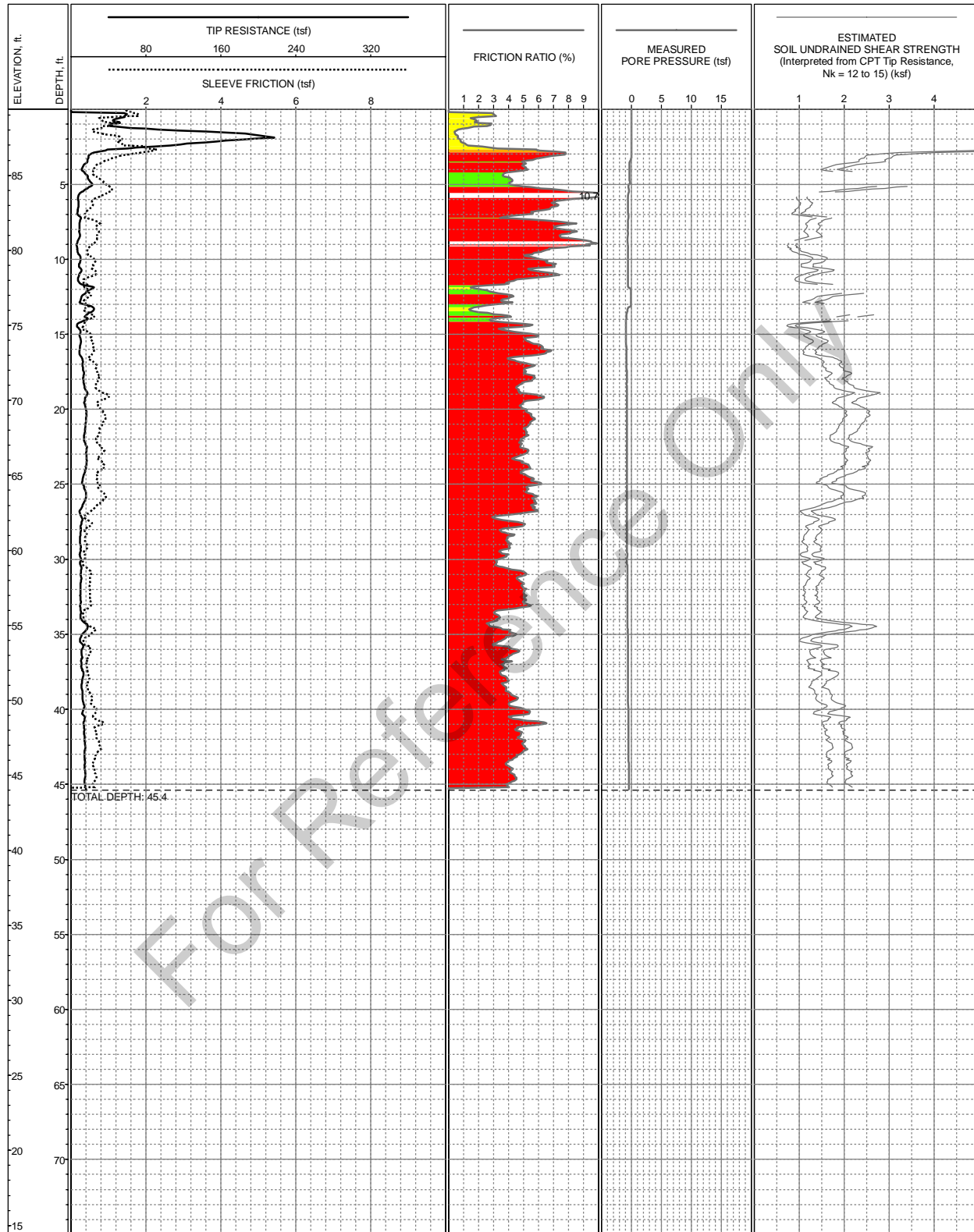

LOCATION: E6162986.4 N1956566.5 (NAD83, CA State Plane Zone III, Feet)
 SURFACE EL: 89.4ft (NAVD88)
 COMPLETION DEPTH: 45.4ft
 TEST DATE: 4/4/2007

CONE: F7.5CKEW1689
 PERFORMED BY: Fugro Consultants, Inc.
 OPERATOR: D Garza & R Norris
 REVIEWED BY: M Paquette

LOG OF CPT-160
 Central Area Guideway of SVRT Project
 San Jose, California

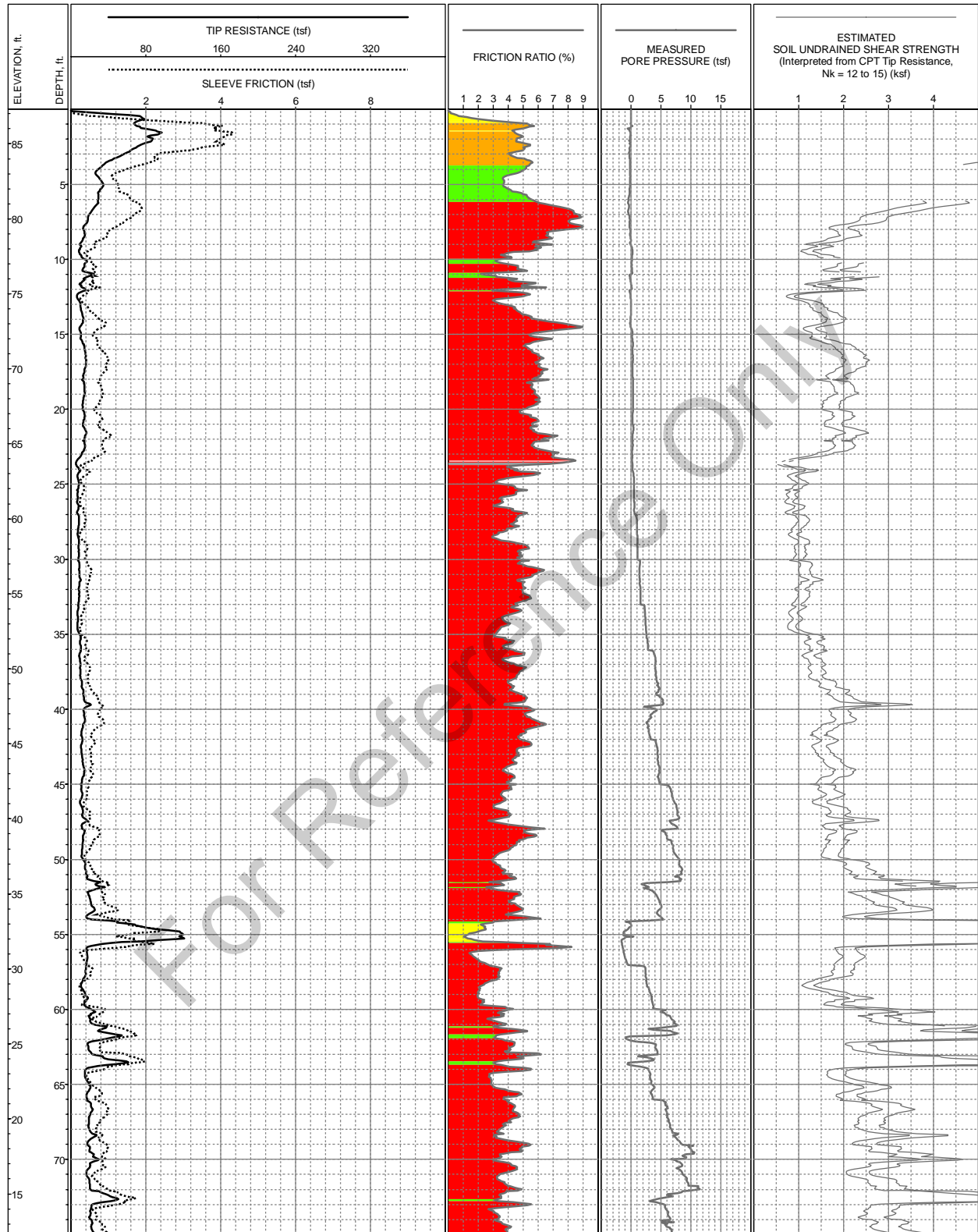

LOCATION: E6163128.3 N1956250.6 (NAD83, CA State Plane Zone III, Feet)
 SURFACE EL: 87.3ft (NAVD88)
 COMPLETION DEPTH: 105ft
 TEST DATE: 4/3/2007

CONE: F7.5CKESW1645
 PERFORMED BY: Fugro Consultants, Inc.
 OPERATOR: D Garza & R Norris
 REVIEWED BY: M Paquette

LOG OF CPT-161
 Central Area Guideway of SVRT Project
 San Jose, California

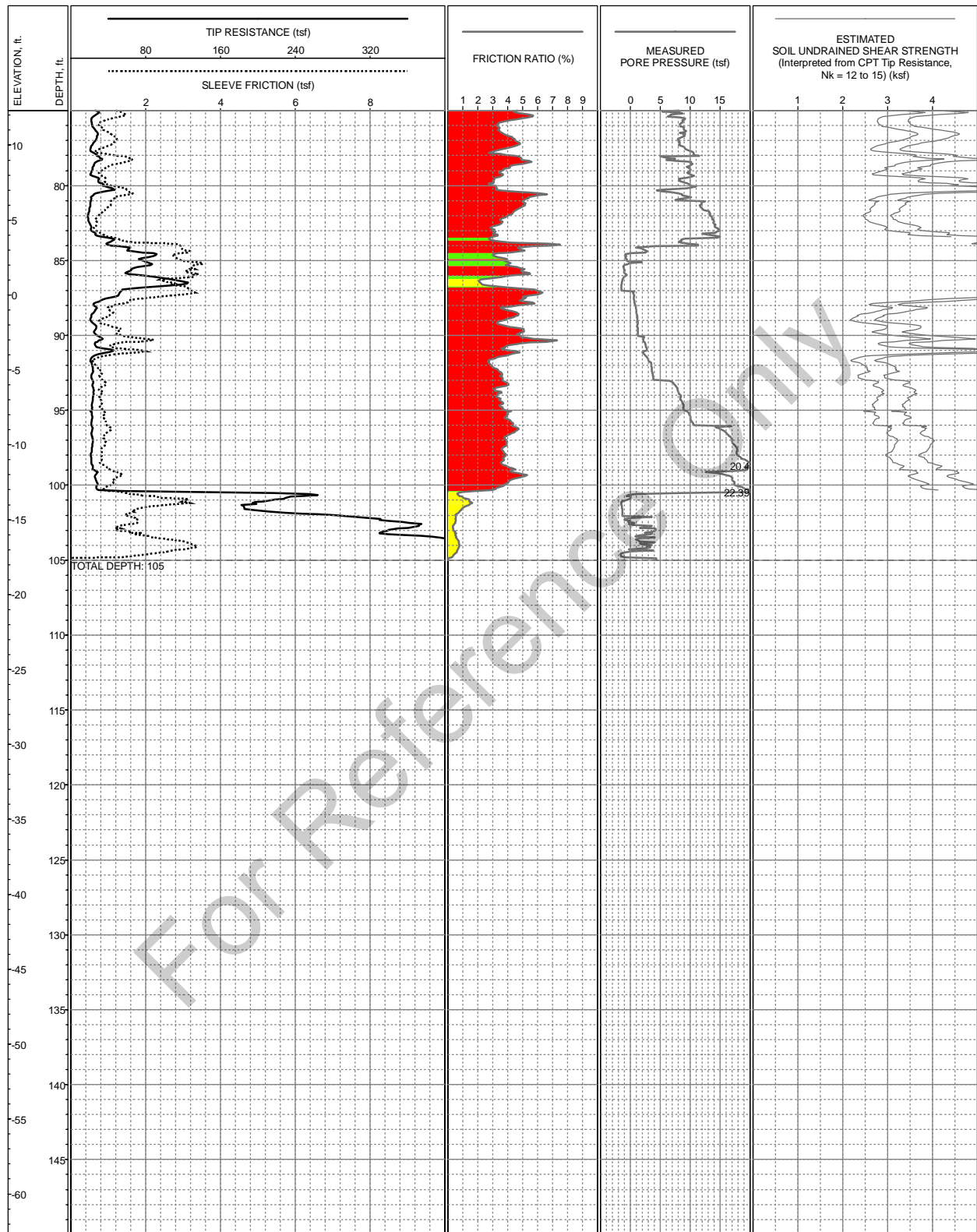

LOCATION: E6163128.3 N1956250.6 (NAD83, CA State Plane Zone III, Feet)
 SURFACE EL: 87.3ft (NAVD88)
 COMPLETION DEPTH: 105ft
 TEST DATE: 4/3/2007

CONE: F7.5CKESW1645
 PERFORMED BY: Fugro Consultants, Inc.
 OPERATOR: D Garza & R Norris
 REVIEWED BY: M Paquette

LOG OF CPT-161
 Central Area Guideway of SVRT Project
 San Jose, California

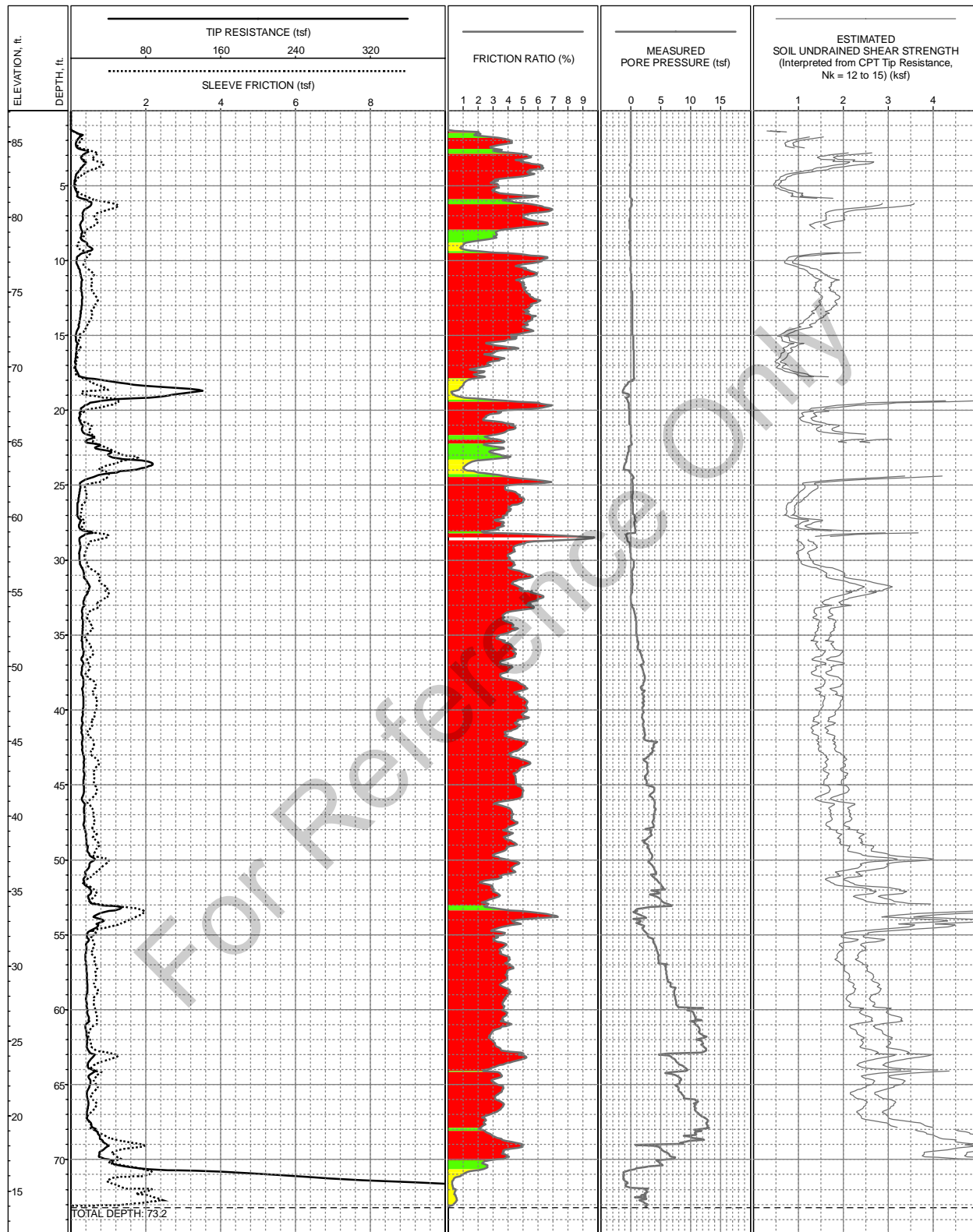

LOCATION: E6164944.9 N1953715.9 (NAD83, CA State Plane Zone III, Feet)
 SURFACE EL: 87.1ft (NAVD88)
 COMPLETION DEPTH: 73.2ft
 TEST DATE: 8/13/2007

CONE: F7.5CKEGW1645
 PERFORMED BY: Fugro Consultants, Inc.
 OPERATOR: D Garza
 REVIEWED BY: M Paquette

LOG OF CPT-162
 Central Area Guideway of SVRT Project
 San Jose, California

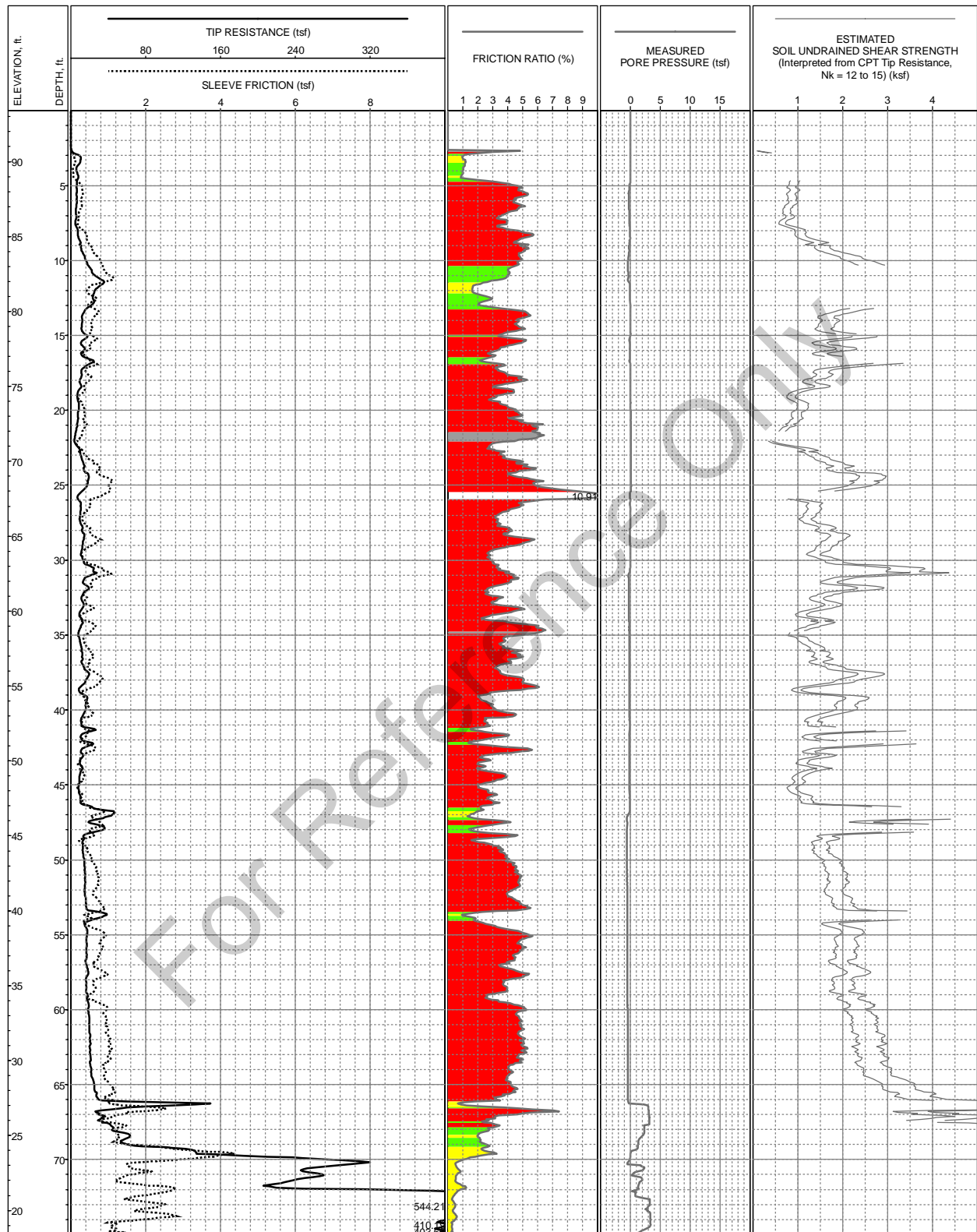

LOCATION: E6163027.2 N1950984.9 (NAD83, CA State Plane Zone III, Feet)
 SURFACE EL: 93.4ft (NAVD88)
 COMPLETION DEPTH: 95.1ft
 TEST DATE: 3/31/2007

CONE: F7.5CKEW1689
 PERFORMED BY: Fugro Consultants, Inc.
 OPERATOR: D Garza & R Norris
 REVIEWED BY: M Paquette

LOG OF CPT-163
 Central Area Guideway of SVRT Project
 San Jose, California

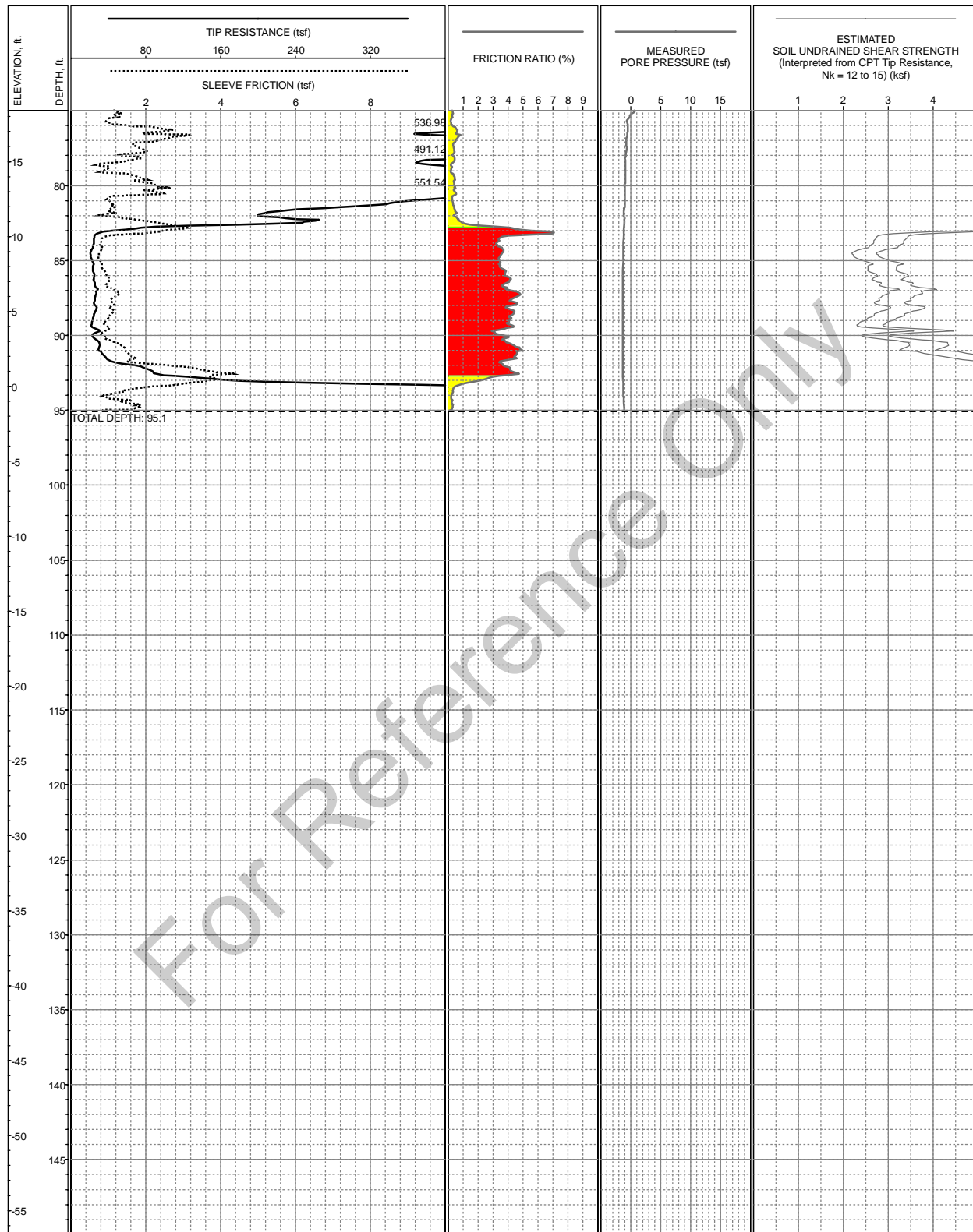

LOCATION: E6163027.2 N1950984.9 (NAD83, CA State Plane Zone III, Feet)
 SURFACE EL: 93.4ft (NAVD88)
 COMPLETION DEPTH: 95.1ft
 TEST DATE: 3/31/2007

CONE: F7.5CKEW1689
 PERFORMED BY: Fugro Consultants, Inc.
 OPERATOR: D Garza & R Norris
 REVIEWED BY: M Paquette

LOG OF CPT-163
 Central Area Guideway of SVRT Project
 San Jose, California

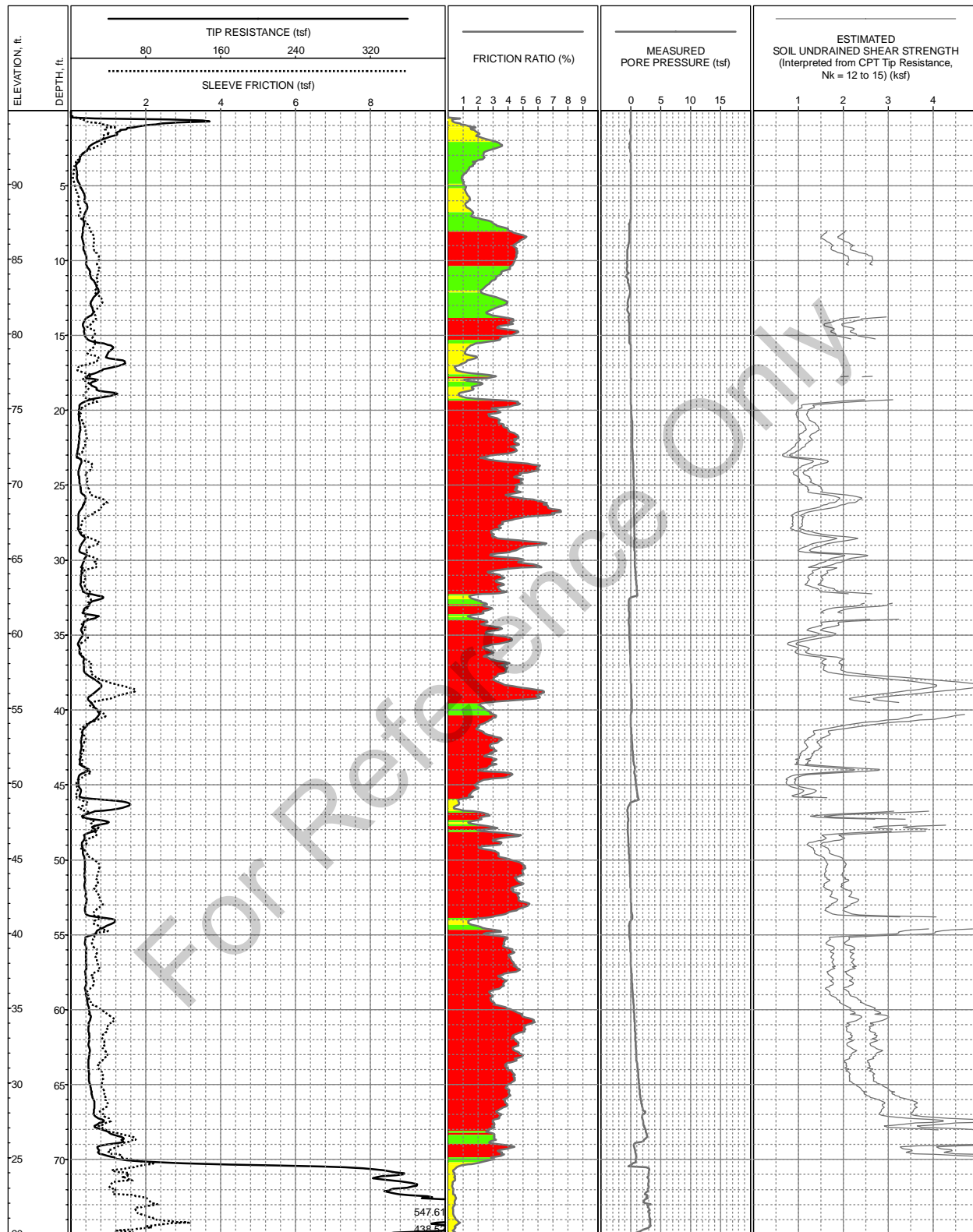

LOCATION: E6162753.1 N1950828.5 (NAD83, CA State Plane Zone III, Feet)
 SURFACE EL: 94.9ft (NAVD88)
 COMPLETION DEPTH: 86ft
 TEST DATE: 3/28/2007

CONE: F7.5CKEW1689
 PERFORMED BY: Fugro Consultants, Inc.
 OPERATOR: D Garza & R Norris
 REVIEWED BY: M Paquette

LOG OF CPT-164
 Central Area Guideway of SVRT Project
 San Jose, California

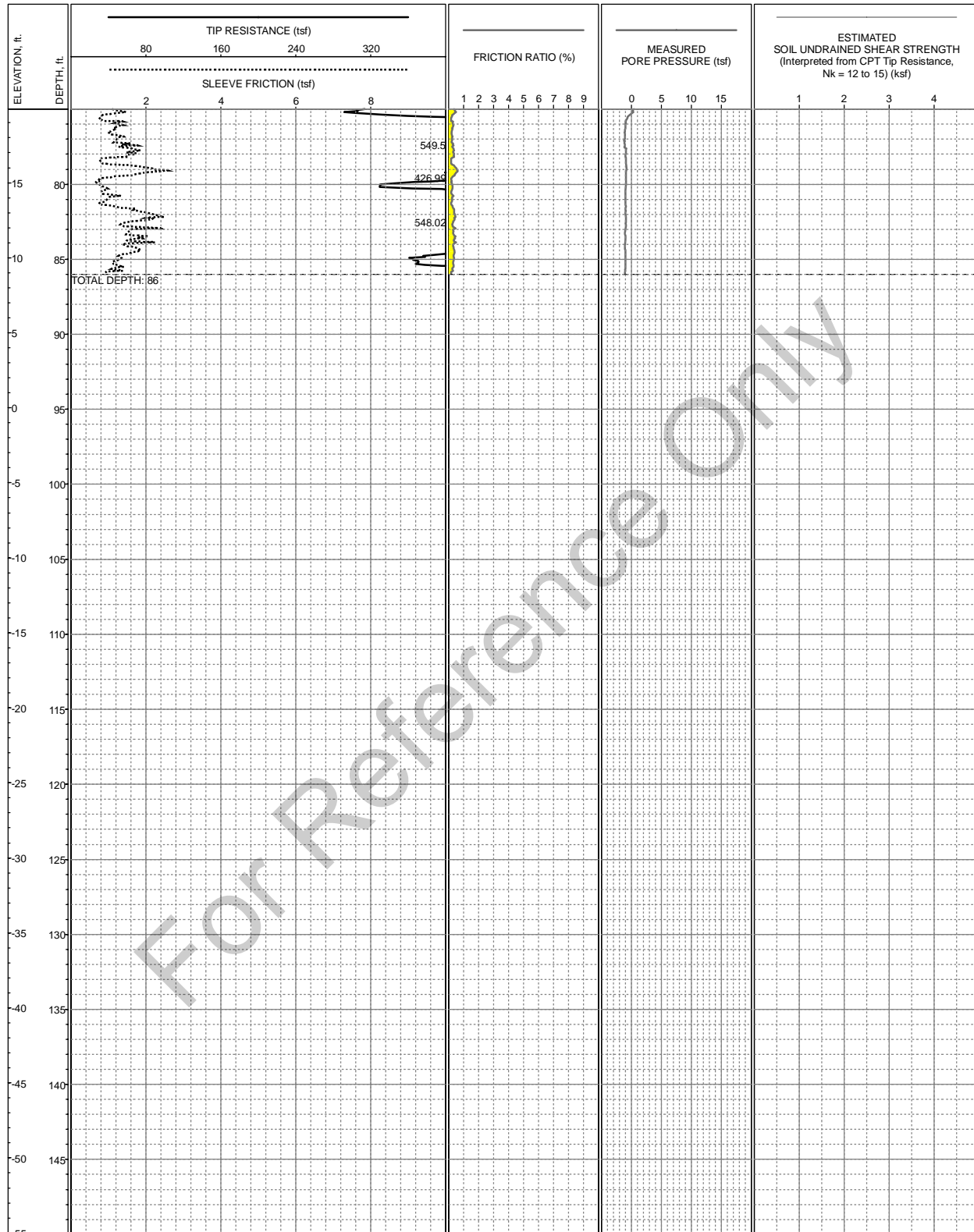

LOCATION: E6162753.1 N1950828.5 (NAD83, CA State Plane Zone III, Feet)
 SURFACE EL: 94.9ft (NAVD88)
 COMPLETION DEPTH: 86ft
 TEST DATE: 3/28/2007

CONE: F7.5CKEW1689
 PERFORMED BY: Fugro Consultants, Inc.
 OPERATOR: D Garza & R Norris
 REVIEWED BY: M Paquette

LOG OF CPT-164
 Central Area Guideway of SVRT Project
 San Jose, California

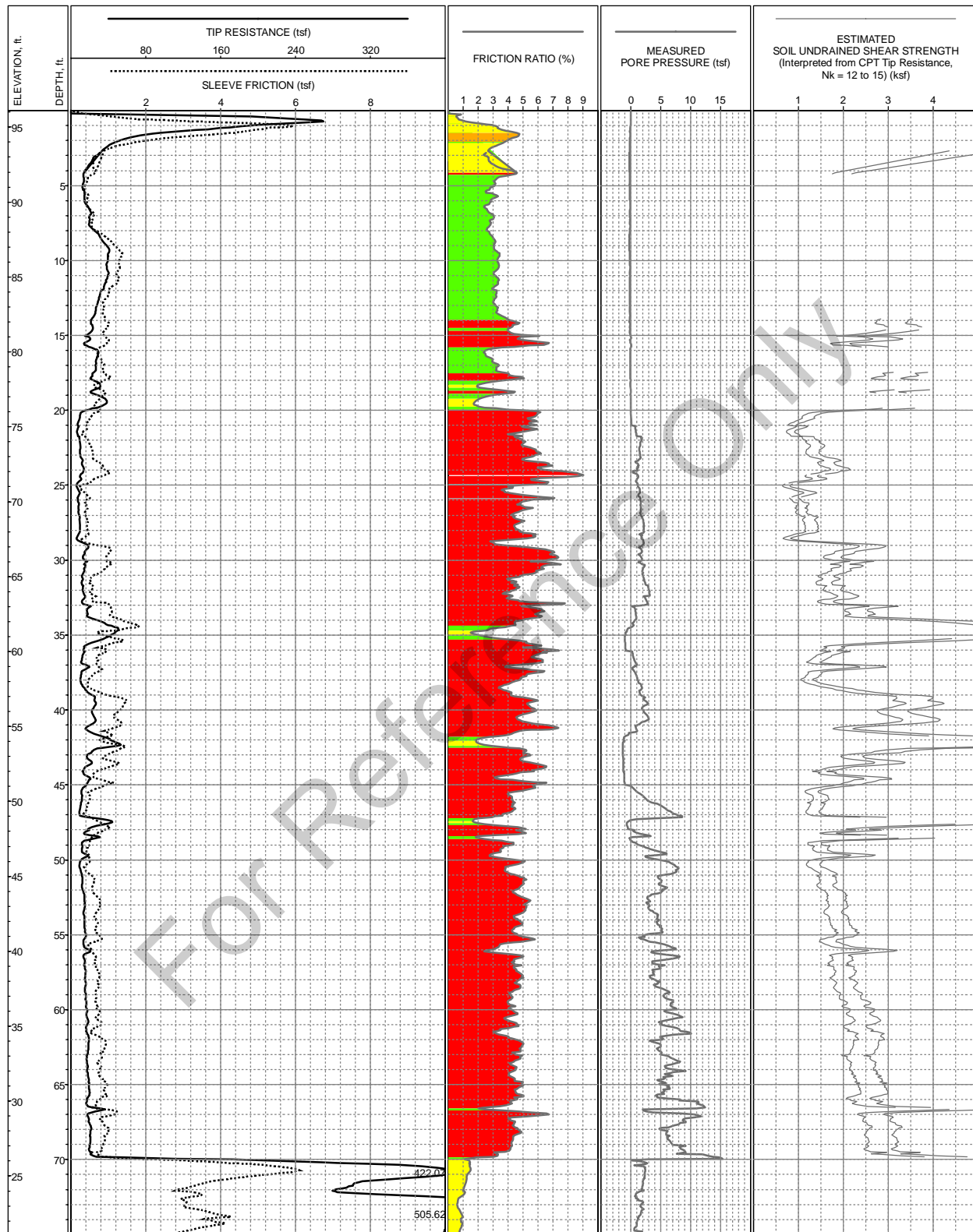

LOCATION: E6162527.2 N1950703.4 (NAD83, CA State Plane Zone III, Feet)
 SURFACE EL: 96.1ft (NAVD88)
 COMPLETION DEPTH: 77.4ft
 TEST DATE: 8/16/2007

CONE: F7.5CKEGW1645
 PERFORMED BY: Fugro Consultants, Inc.
 OPERATOR: D Garza
 REVIEWED BY: M Paquette

LOG OF CPT-165
 Central Area Guideway of SVRT Project
 San Jose, California

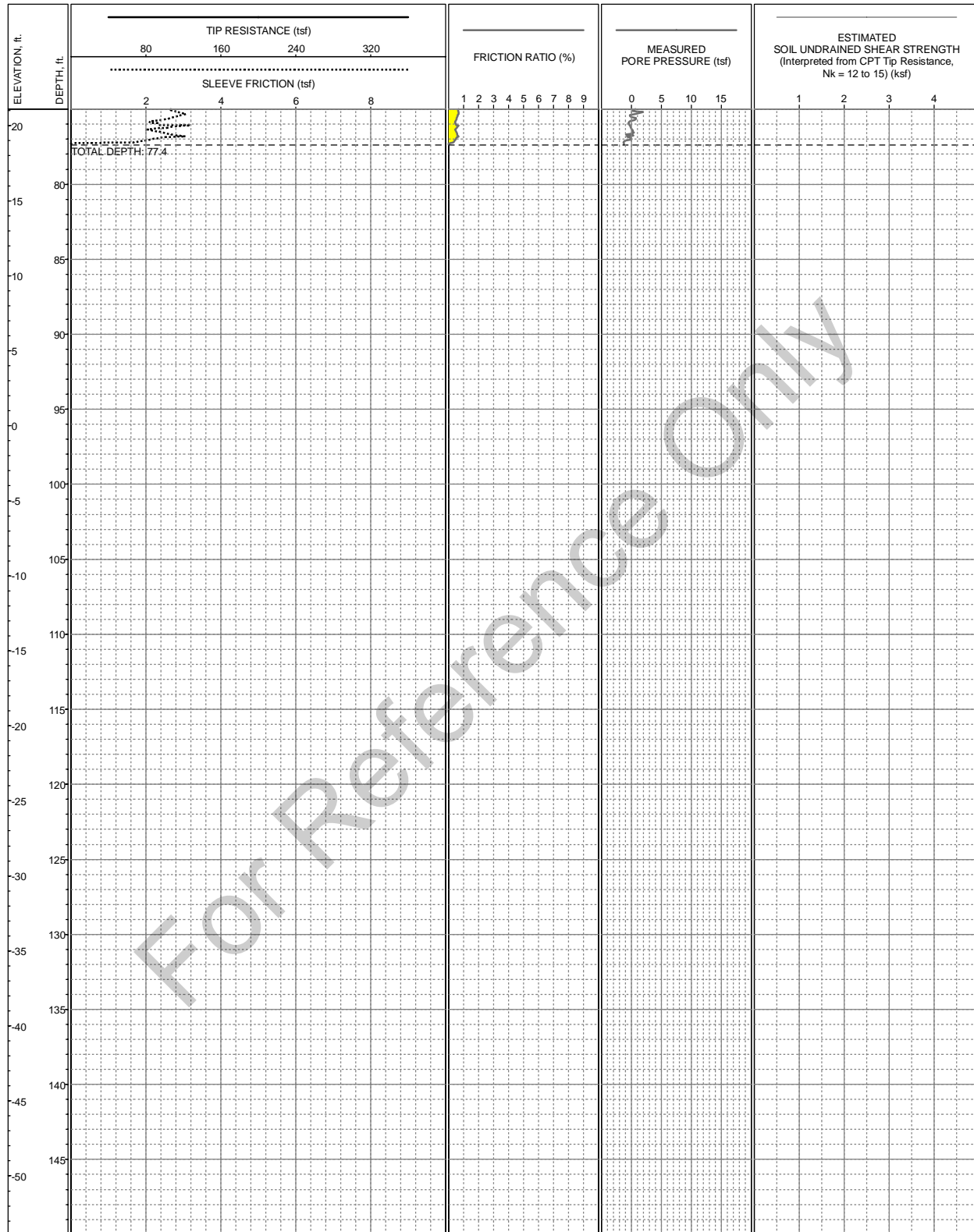

LOCATION: E6162527.2 N1950703.4 (NAD83, CA State Plane Zone III, Feet)
 SURFACE EL: 96.1ft (NAVD88)
 COMPLETION DEPTH: 77.4ft
 TEST DATE: 8/16/2007

CONE: F7.5CKEGW1645
 PERFORMED BY: Fugro Consultants, Inc.
 OPERATOR: D Garza
 REVIEWED BY: M Paquette

LOG OF CPT-165
 Central Area Guideway of SVRT Project
 San Jose, California

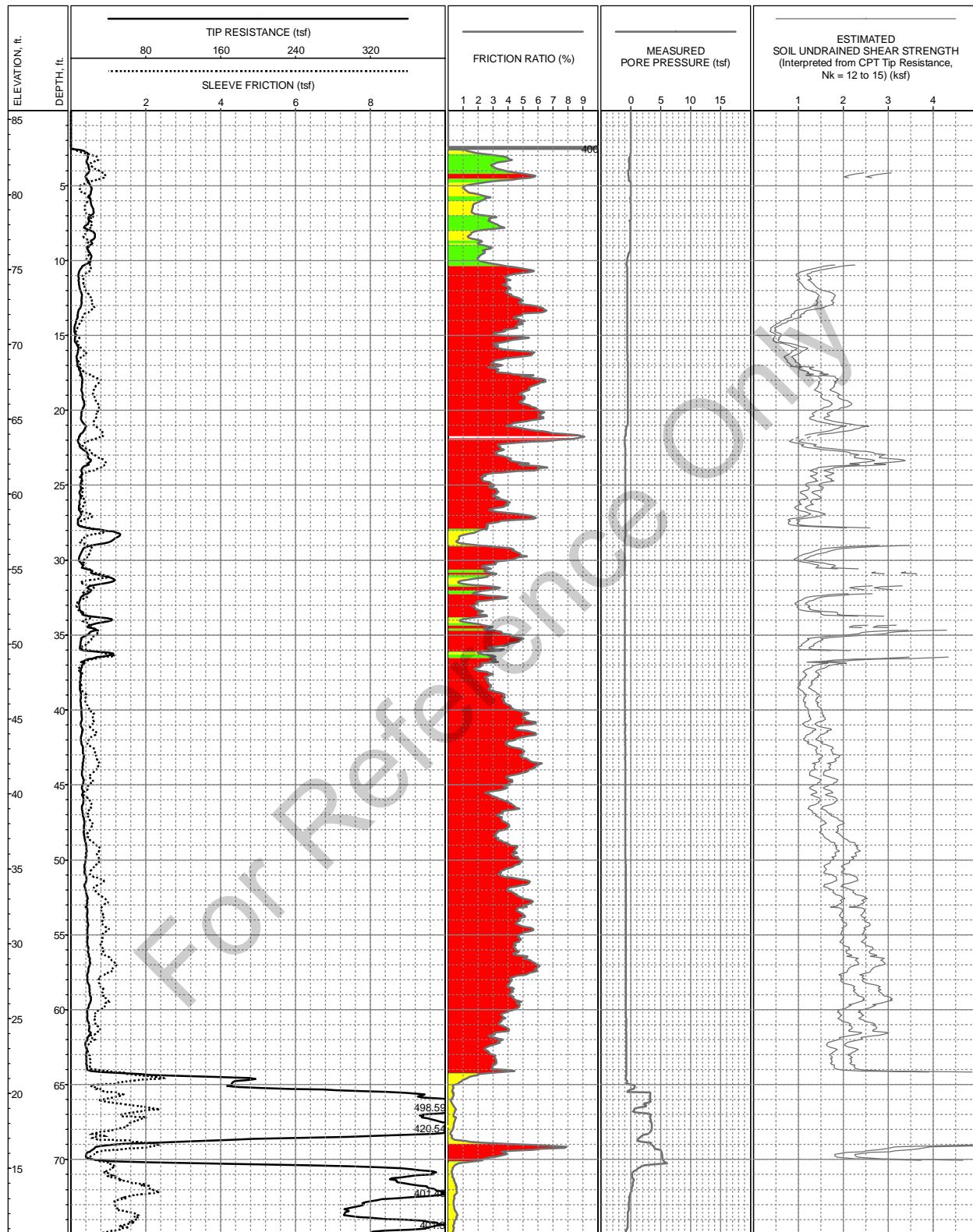

LOCATION: E6161925.6 N1950357.8 (NAD83, CA State Plane Zone III, Feet)
 SURFACE EL: 85.6ft (NAVD88)
 COMPLETION DEPTH: 89.2ft
 TEST DATE: 3/29/2007

CONE: F7.5CKEW1689
 PERFORMED BY: Fugro Consultants, Inc.
 OPERATOR: D Garza & R Norris
 REVIEWED BY: M Paquette

LOG OF CPT-166
 Central Area Guideway of SVRT Project
 San Jose, California

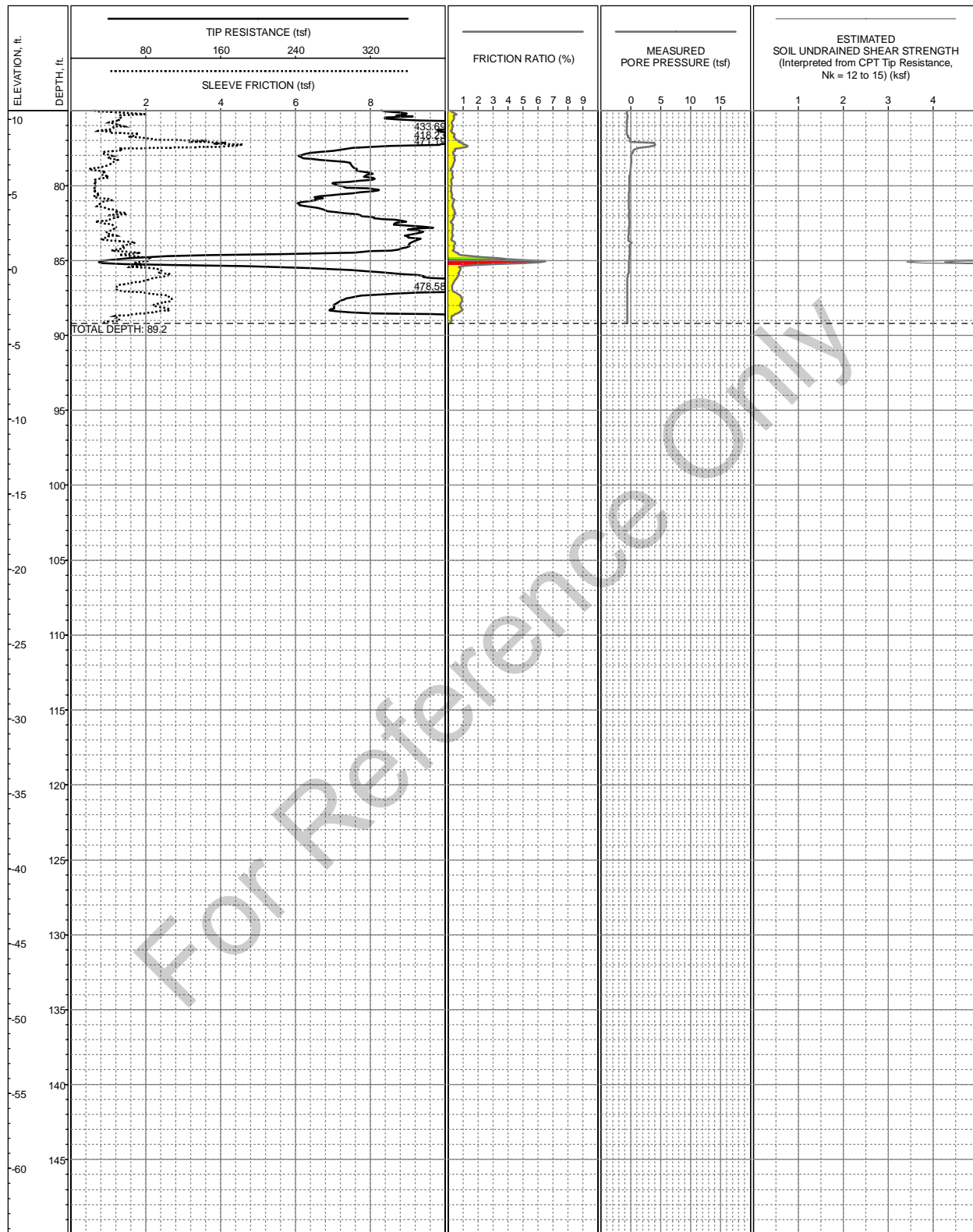

LOCATION: E6161925.6 N1950357.8 (NAD83, CA State Plane Zone III, Feet)
 SURFACE EL: 85.6ft (NAVD88)
 COMPLETION DEPTH: 89.2ft
 TEST DATE: 3/29/2007

CONE: F7.5CKEW1689
 PERFORMED BY: Fugro Consultants, Inc.
 OPERATOR: D Garza & R Norris
 REVIEWED BY: M Paquette

LOG OF CPT-166
 Central Area Guideway of SVRT Project
 San Jose, California

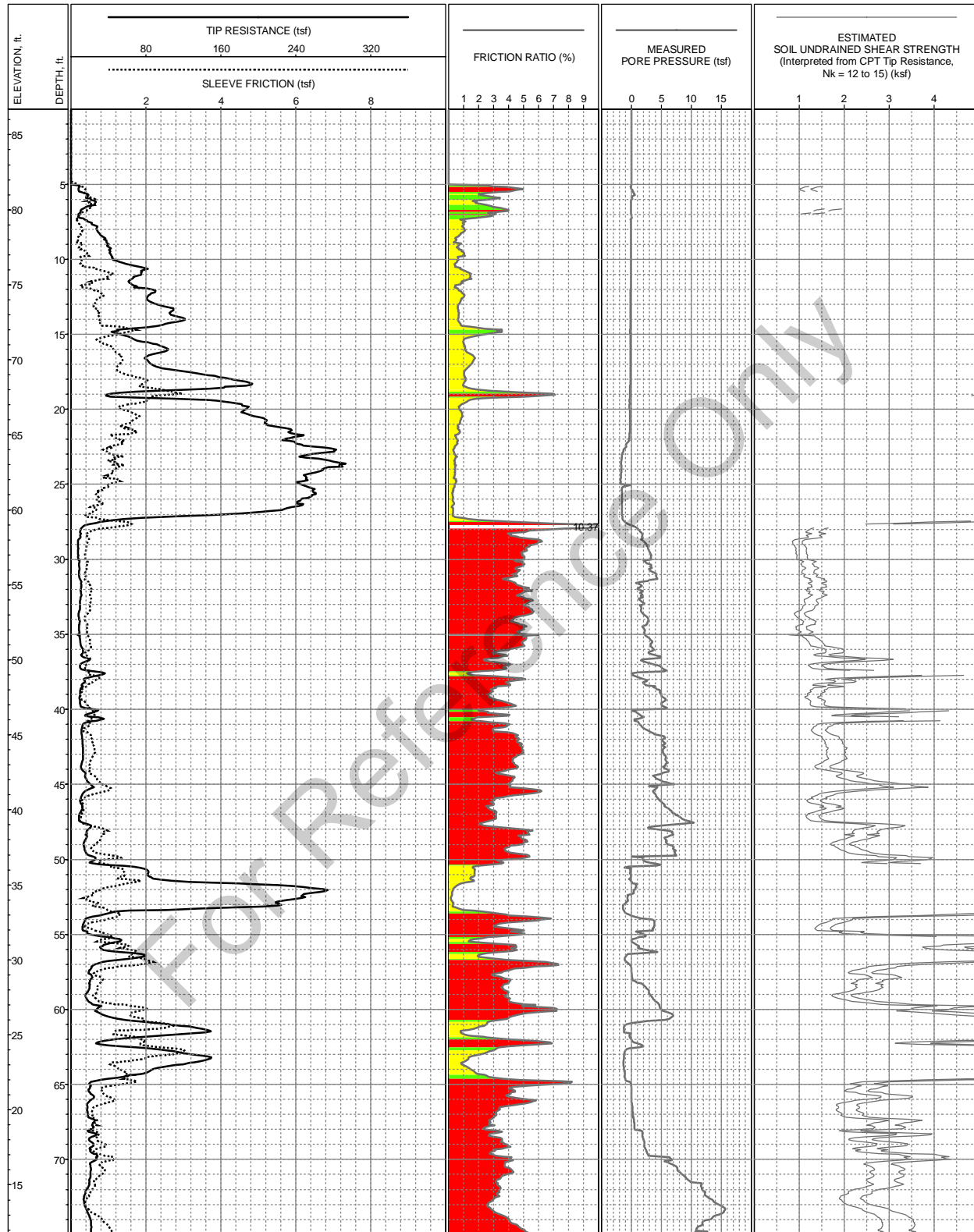

LOCATION: E6157353.8 N1947883.5 (NAD83, CA State Plane Zone III, Feet)
 SURFACE EL: 86.7ft (NAVD88)
 COMPLETION DEPTH: 90.7ft
 TEST DATE: 4/1/2007

CONE: F7.5CKESW1645
 PERFORMED BY: Fugro Consultants, Inc.
 OPERATOR: D Garza & R Norris
 REVIEWED BY: M Paquette

LOG OF CPT-167
 Central Area Guideway of SVRT Project
 San Jose, California

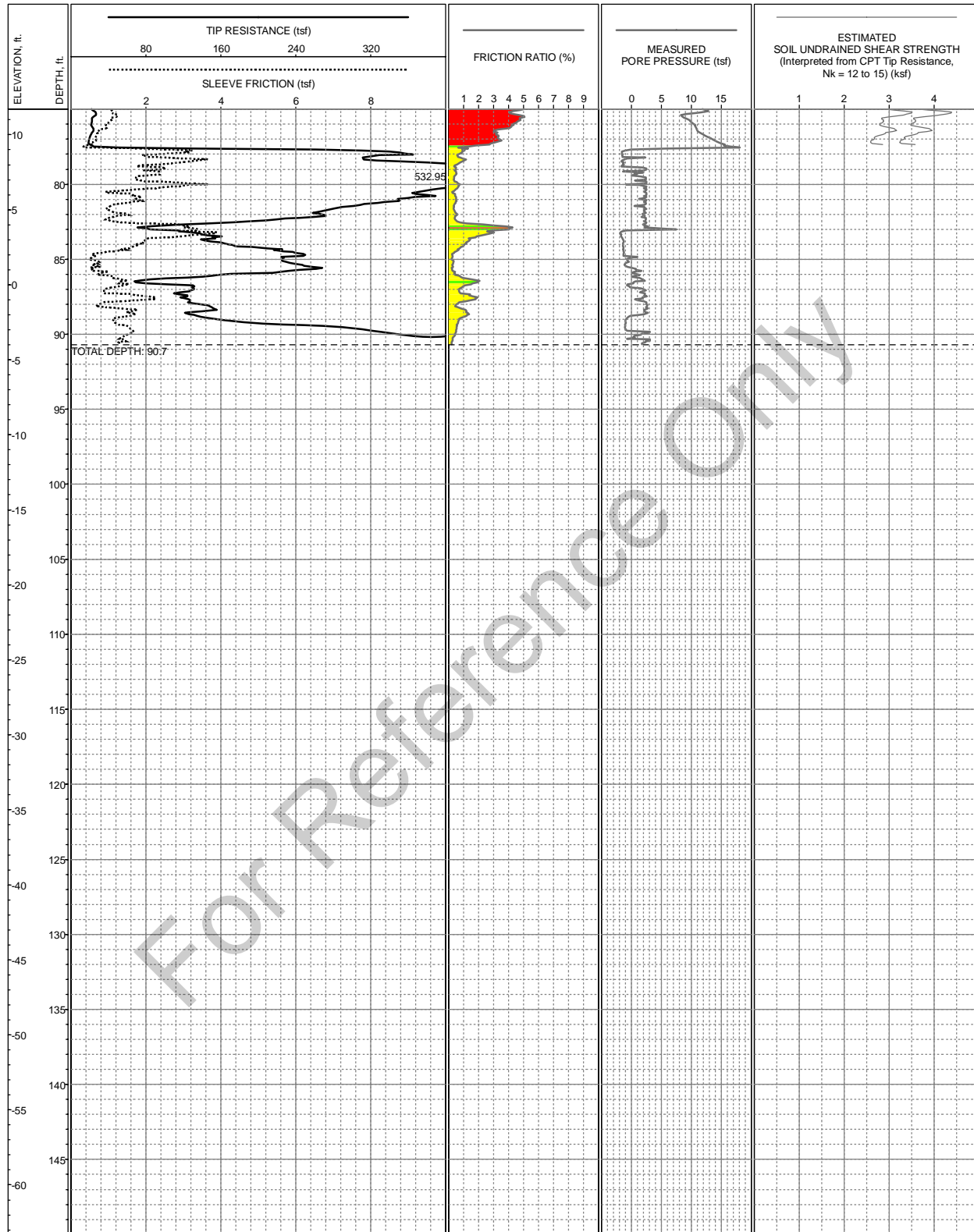

LOCATION: E6157353.8 N1947883.5 (NAD83, CA State Plane Zone III, Feet)
 SURFACE EL: 86.7ft (NAVD88)
 COMPLETION DEPTH: 90.7ft
 TEST DATE: 4/1/2007

CONE: F7.5CKESW1645
 PERFORMED BY: Fugro Consultants, Inc.
 OPERATOR: D Garza & R Norris
 REVIEWED BY: M Paquette

LOG OF CPT-167
 Central Area Guideway of SVRT Project
 San Jose, California

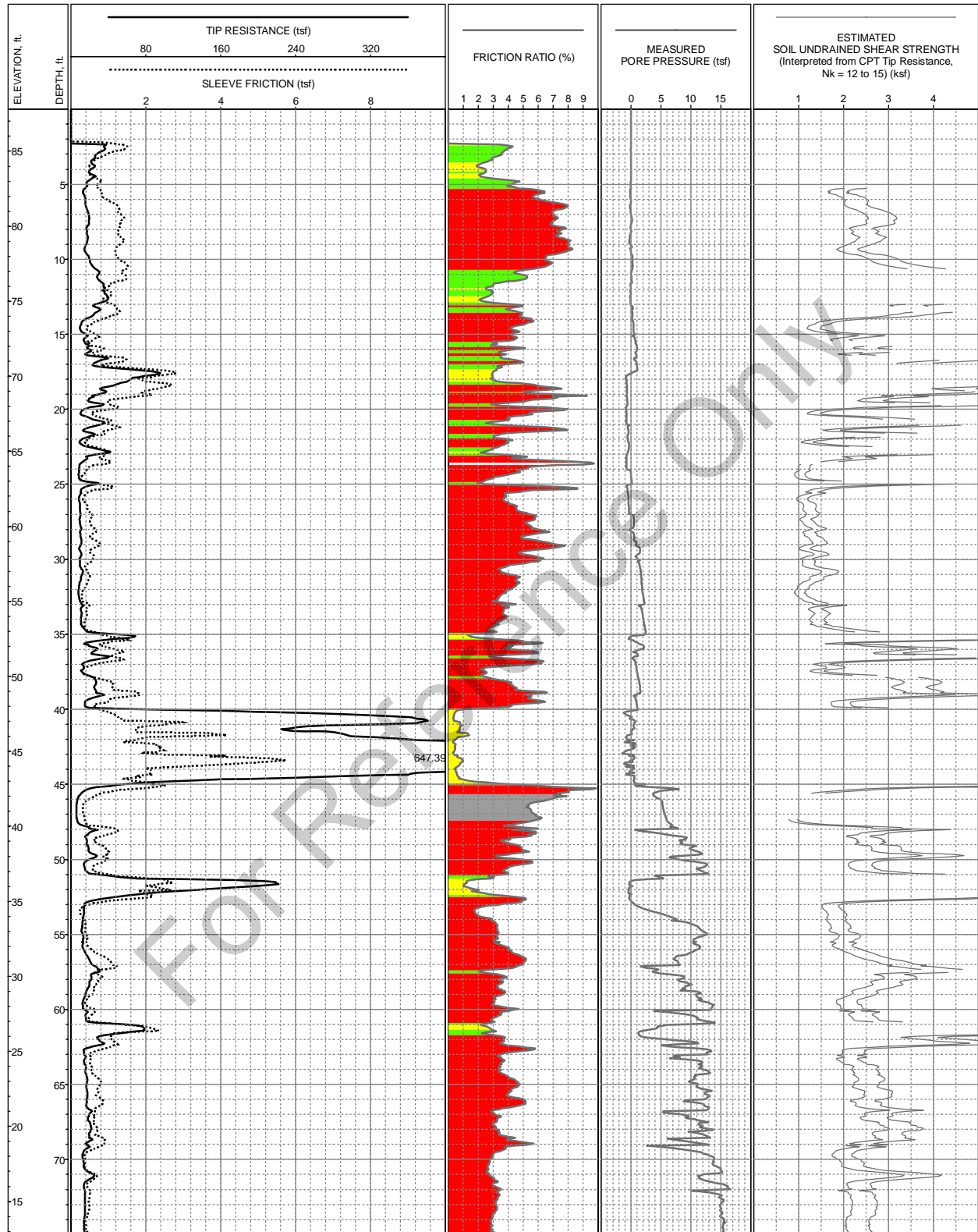

LOCATION: E6154586 N1946016.7 (NAD83, CA State Plane Zone III, Feet)
 SURFACE EL: 87.8ft (NAVD88)
 COMPLETION DEPTH: 149.9ft
 TEST DATE: 4/5/2007

CONE: F7.5CKESW1645
 PERFORMED BY: Fugro Consultants, Inc.
 OPERATOR: D Garza & R Norris
 REVIEWED BY: M Paquette

LOG OF CPT-168
 Central Area Guideway of SVRT Project
 San Jose, California

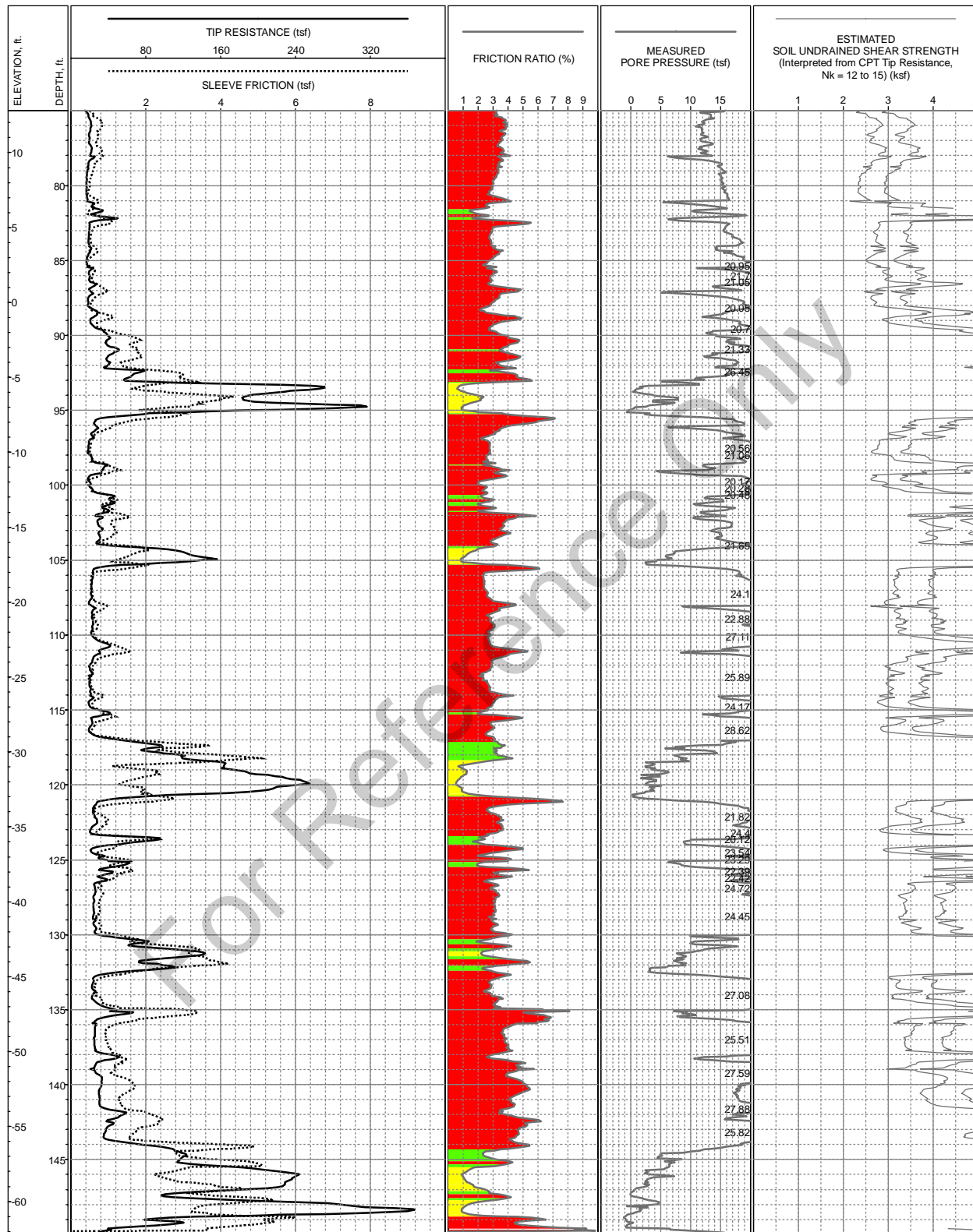

TOTAL DEPTH: 149.9
 LOCATION: E6154586 N1946016.7 (NAD83, CA State Plane Zone III, Feet)
 SURFACE EL: 87.8ft (NAVD88)
 COMPLETION DEPTH: 149.9ft
 TEST DATE: 4/5/2007

CONE: F7.5CKESW1645
 PERFORMED BY: Fugro Consultants, Inc.
 OPERATOR: D Garza & R Norris
 REVIEWED BY: M Paquette

LOG OF CPT-168
 Central Area Guideway of SVRT Project
 San Jose, California

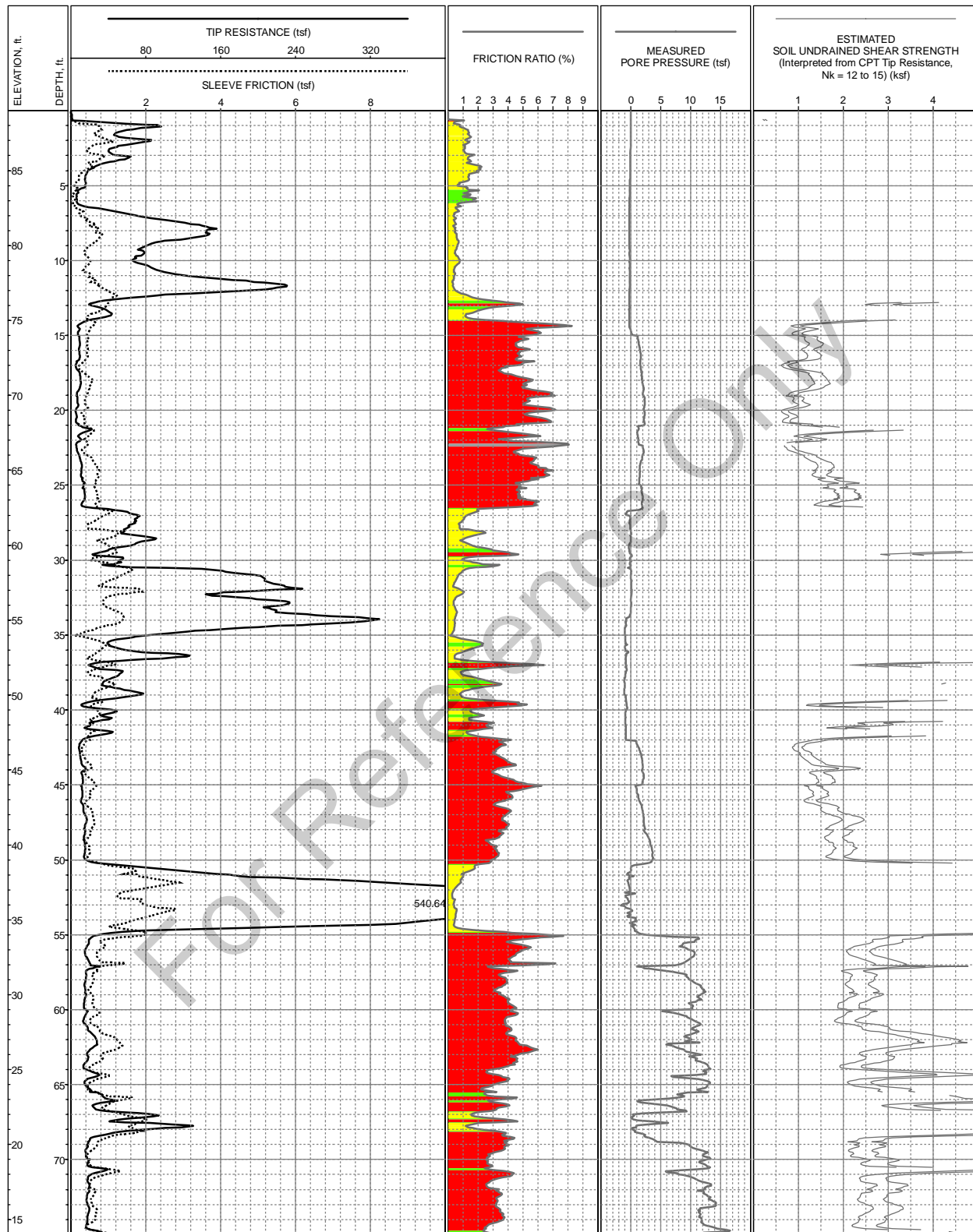

LOCATION: E6156936.7 N1947464 (NAD83, CA State Plane Zone III, Feet)
 SURFACE EL: 89ft (NAVD88)
 COMPLETION DEPTH: 85.4ft
 TEST DATE: 8/17/2007

CONE: F7.5CKEGW1645
 PERFORMED BY: Fugro Consultants, Inc.
 OPERATOR: D Garza
 REVIEWED BY: M Paquette

LOG OF CPT-169
 Central Area Guideway of SVRT Project
 San Jose, California

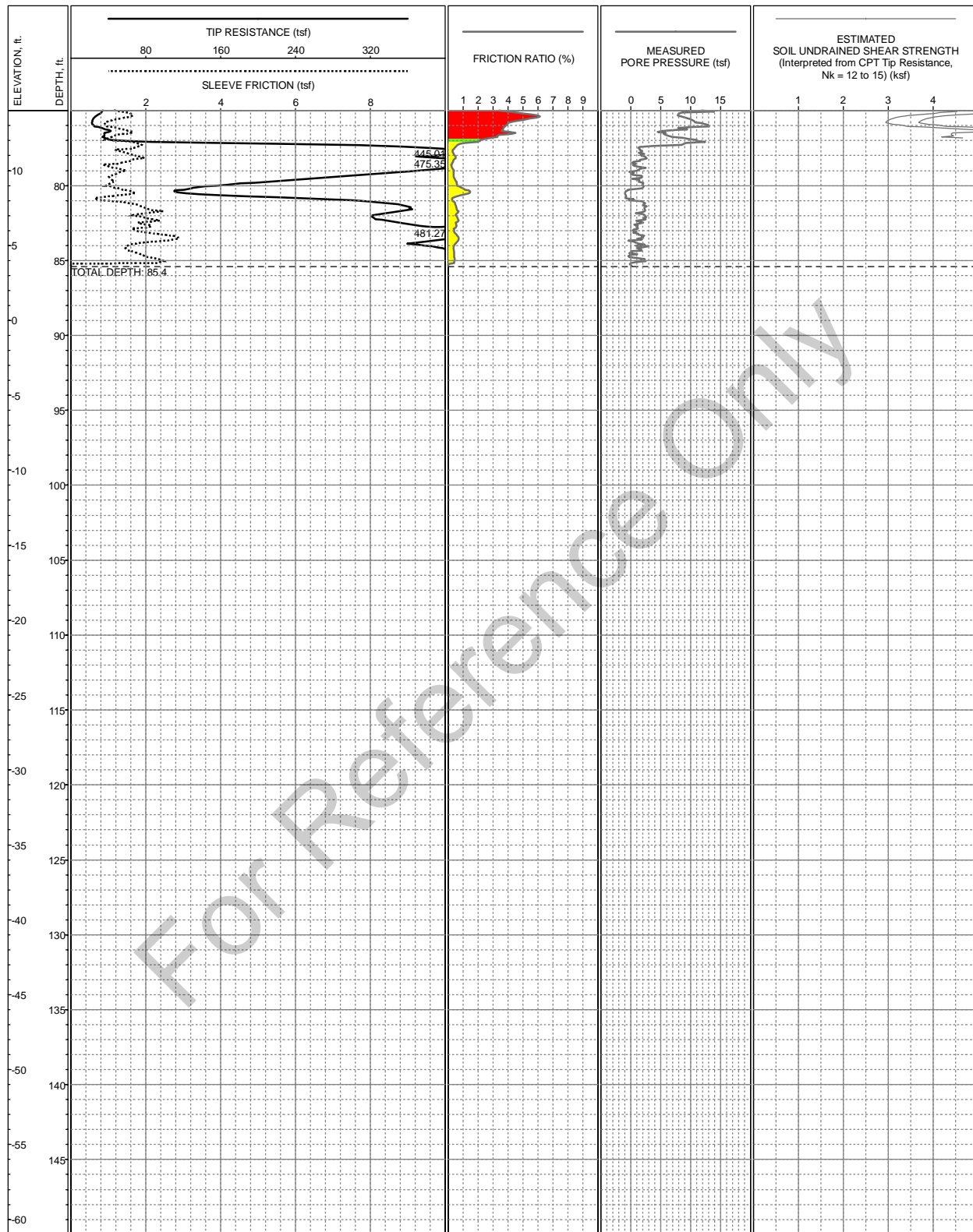

LOCATION: E6156936.7 N1947464 (NAD83, CA State Plane Zone III, Feet)
 SURFACE EL: 89ft (NAVD88)
 COMPLETION DEPTH: 85.4ft
 TEST DATE: 8/17/2007

CONE: F7.5CKEGW1645
 PERFORMED BY: Fugro Consultants, Inc.
 OPERATOR: D Garza
 REVIEWED BY: M Paquette

LOG OF CPT-169
 Central Area Guideway of SVRT Project
 San Jose, California

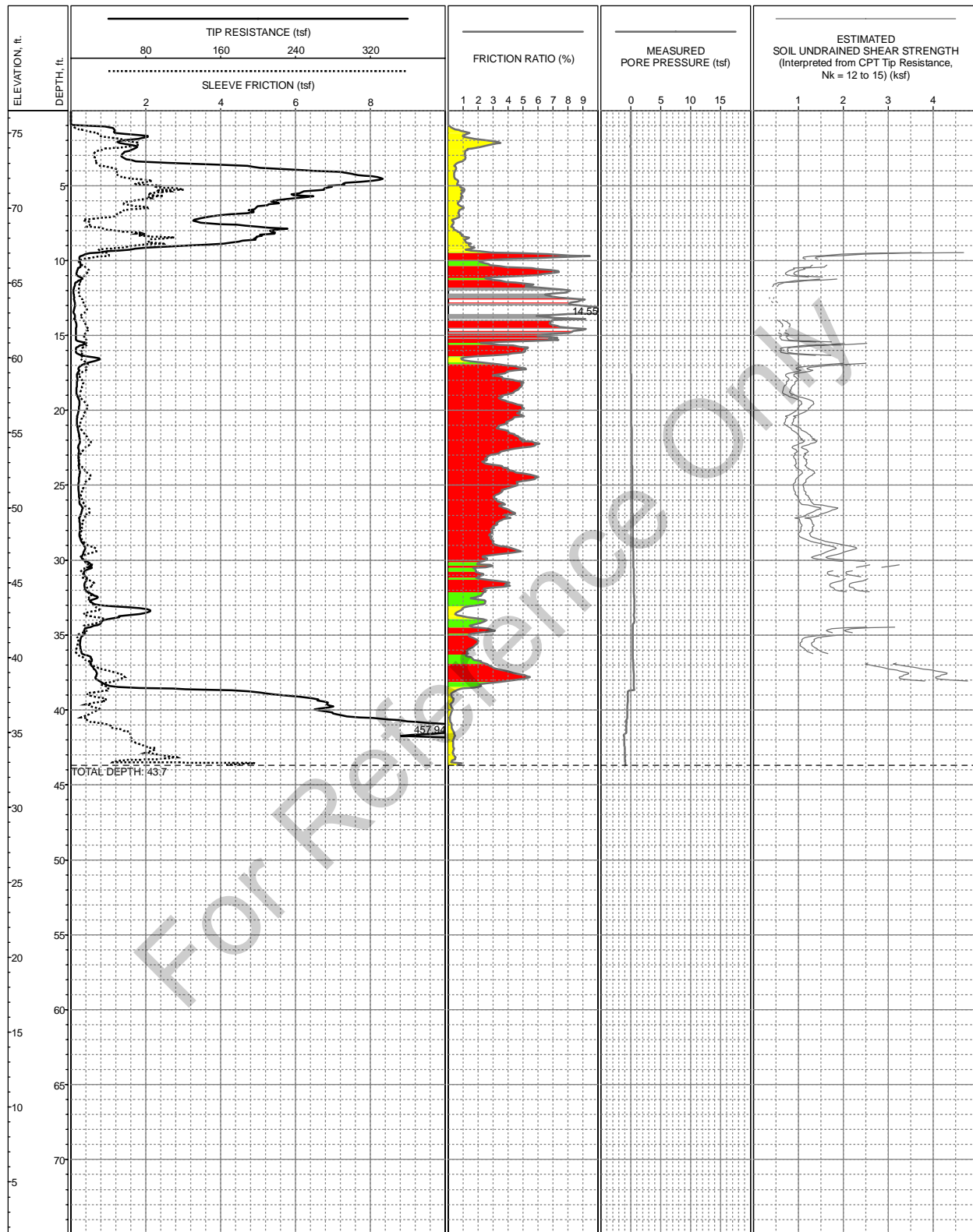

LOCATION: E6150886 N1949597.6 (NAD83, CA State Plane Zone III, Feet)
 SURFACE EL: 76.5ft (NAVD88)
 COMPLETION DEPTH: 43.7ft
 TEST DATE: 3/30/2007

CONE: F7.5CKEW1689
 PERFORMED BY: Fugro Consultants, Inc.
 OPERATOR: D Garza & R Norris
 REVIEWED BY: M Paquette

LOG OF CPT-170
 Central Area Guideway of SVRT Project
 San Jose, California

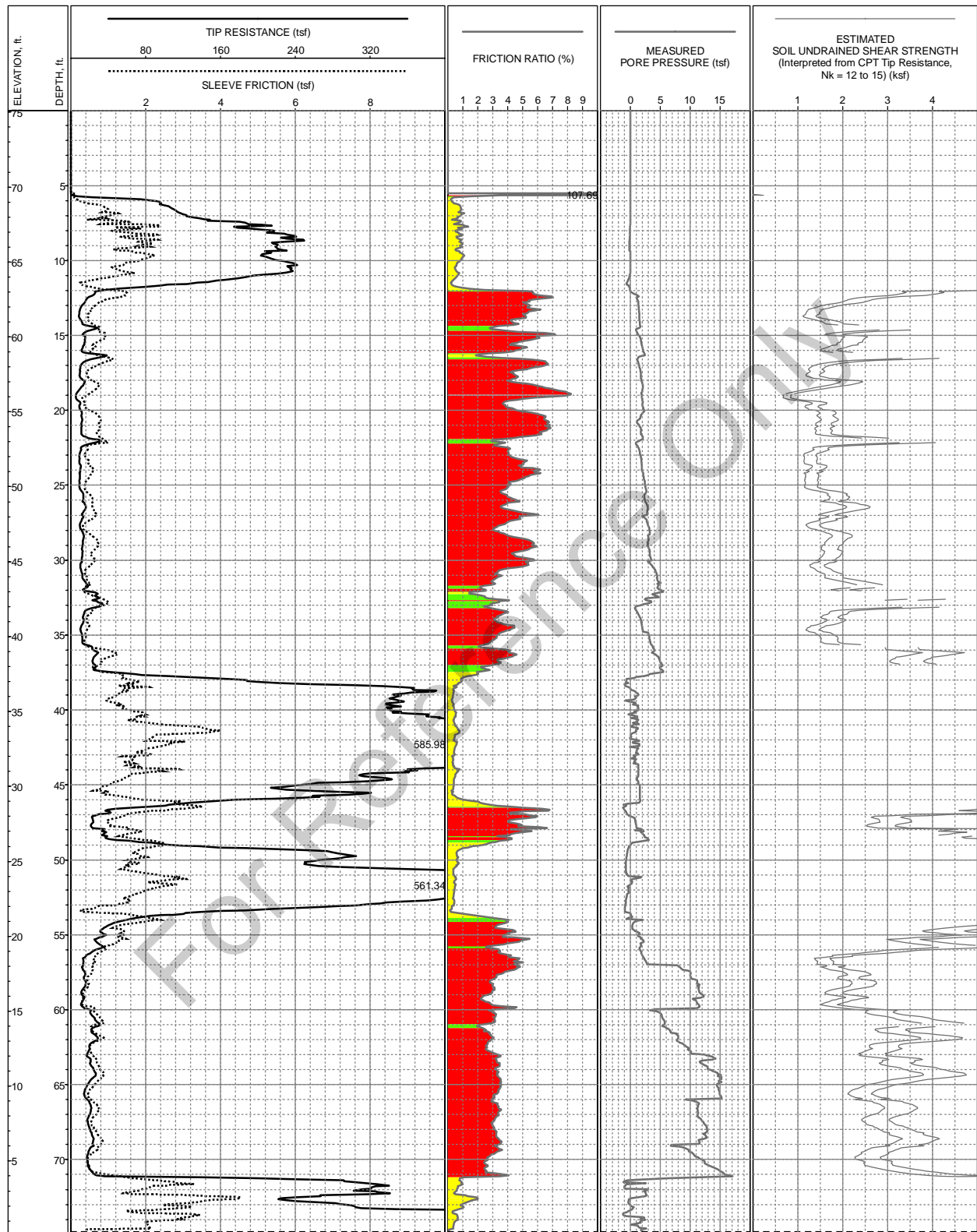

TOTAL DEPTH: 74.8
 LOCATION: E6150804.4 N1949684.3 (NAD83, CA State Plane Zone III, Feet)
 SURFACE EL: 75.1ft (NAVD88)
 COMPLETION DEPTH: 74.8ft
 TEST DATE: 3/30/2007

CONE: F7.5CKESW1645
 PERFORMED BY: Fugro Consultants, Inc.
 OPERATOR: D Garza & R Norris
 REVIEWED BY: M Paquette

LOG OF CPT-171
 Central Area Guideway of SVRT Project
 San Jose, California

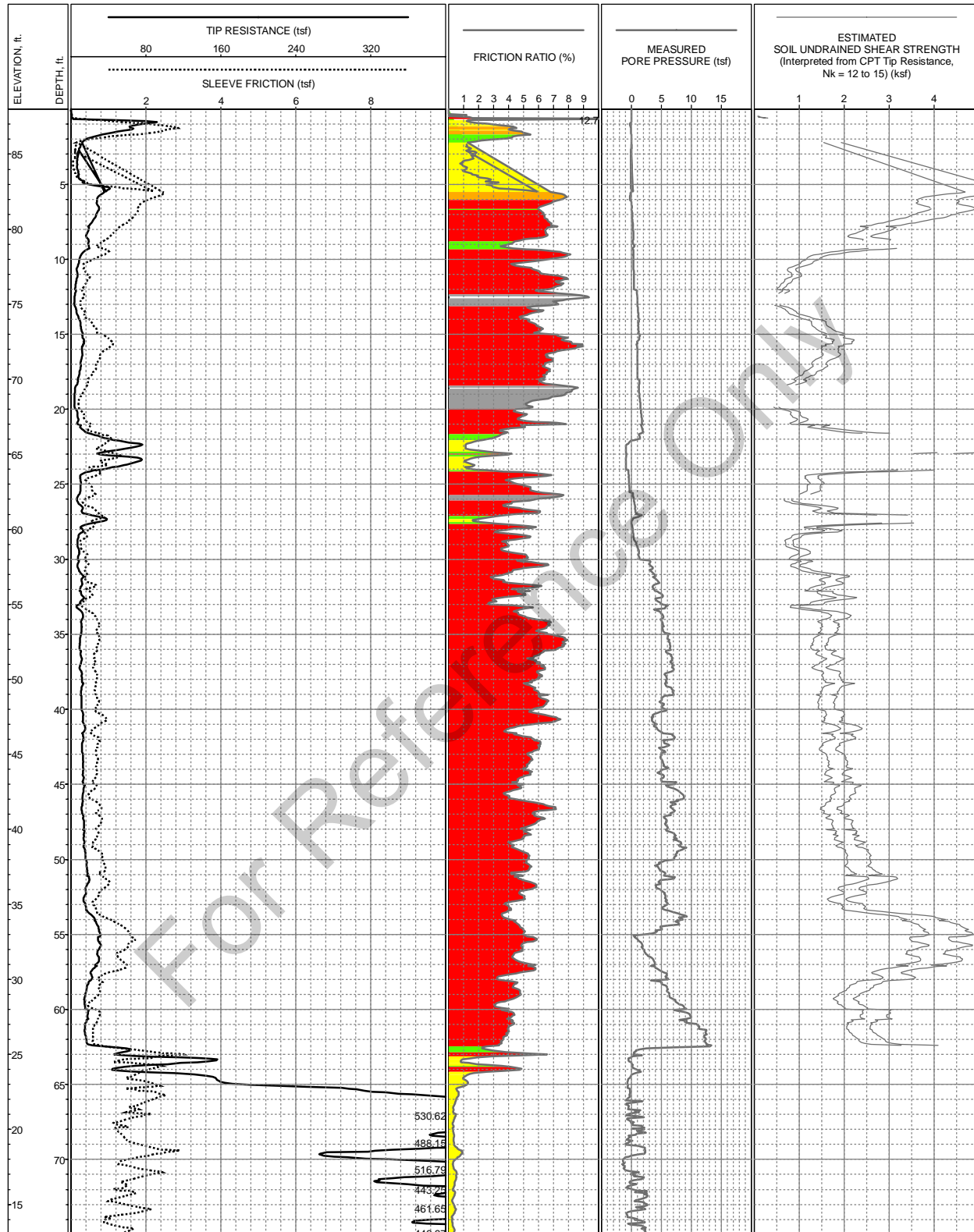

LOCATION: E6164740.58 N1953023.9 (NAD83, CA State Plane Zone III, Feet)
 SURFACE EL: 88ft (NAVD88)
 COMPLETION DEPTH: 113.4ft
 TEST DATE: 8/16/2007

CONE: F7.5CKEGW1645
 PERFORMED BY: Fugro Consultants, Inc.
 OPERATOR: D Garza
 REVIEWED BY: M Paquette

LOG OF CPT-172
 Central Area Guideway of SVRT Project
 San Jose, California

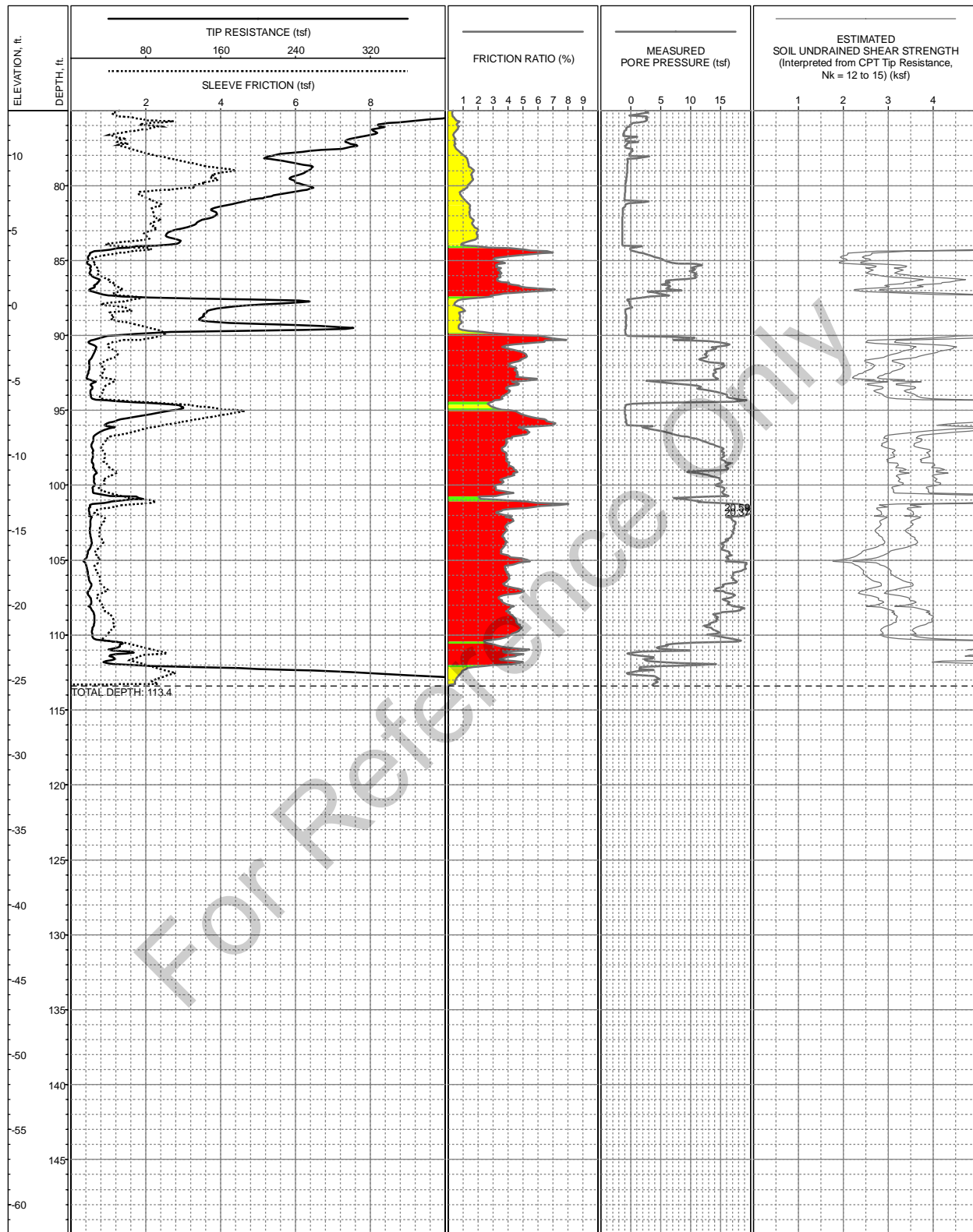

LOCATION: E6164740.58 N1953023.9 (NAD83, CA State Plane Zone III, Feet)
 SURFACE EL: 88ft (NAVD88)
 COMPLETION DEPTH: 113.4ft
 TEST DATE: 8/16/2007

CONE: F7.5CKEGW1645
 PERFORMED BY: Fugro Consultants, Inc.
 OPERATOR: D Garza
 REVIEWED BY: M Paquette

LOG OF CPT-172
 Central Area Guideway of SVRT Project
 San Jose, California

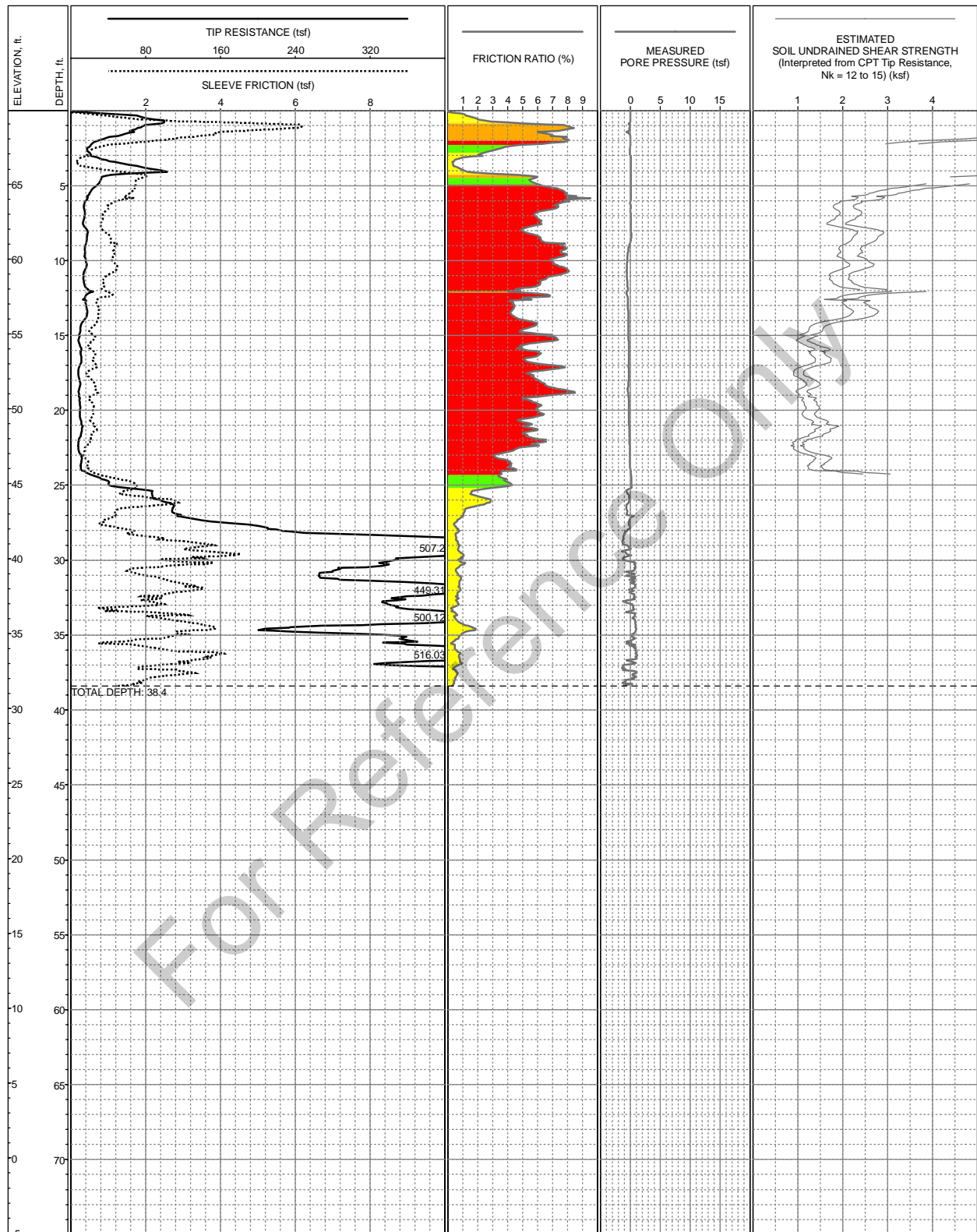

LOCATION: E6148281.4 N1951764.6 (NAD83, CA State Plane Zone III, Feet)
 SURFACE EL: 69.9ft (NAVD88)
 COMPLETION DEPTH: 38.4ft
 TEST DATE: 3/29/2007

CONE: F7.5CKESW1645
 PERFORMED BY: Fugro Consultants, Inc.
 OPERATOR: D Garza & R Norris
 REVIEWED BY: M Paquette

LOG OF CPT-173
 Central Area Guideway of SVRT Project
 San Jose, California

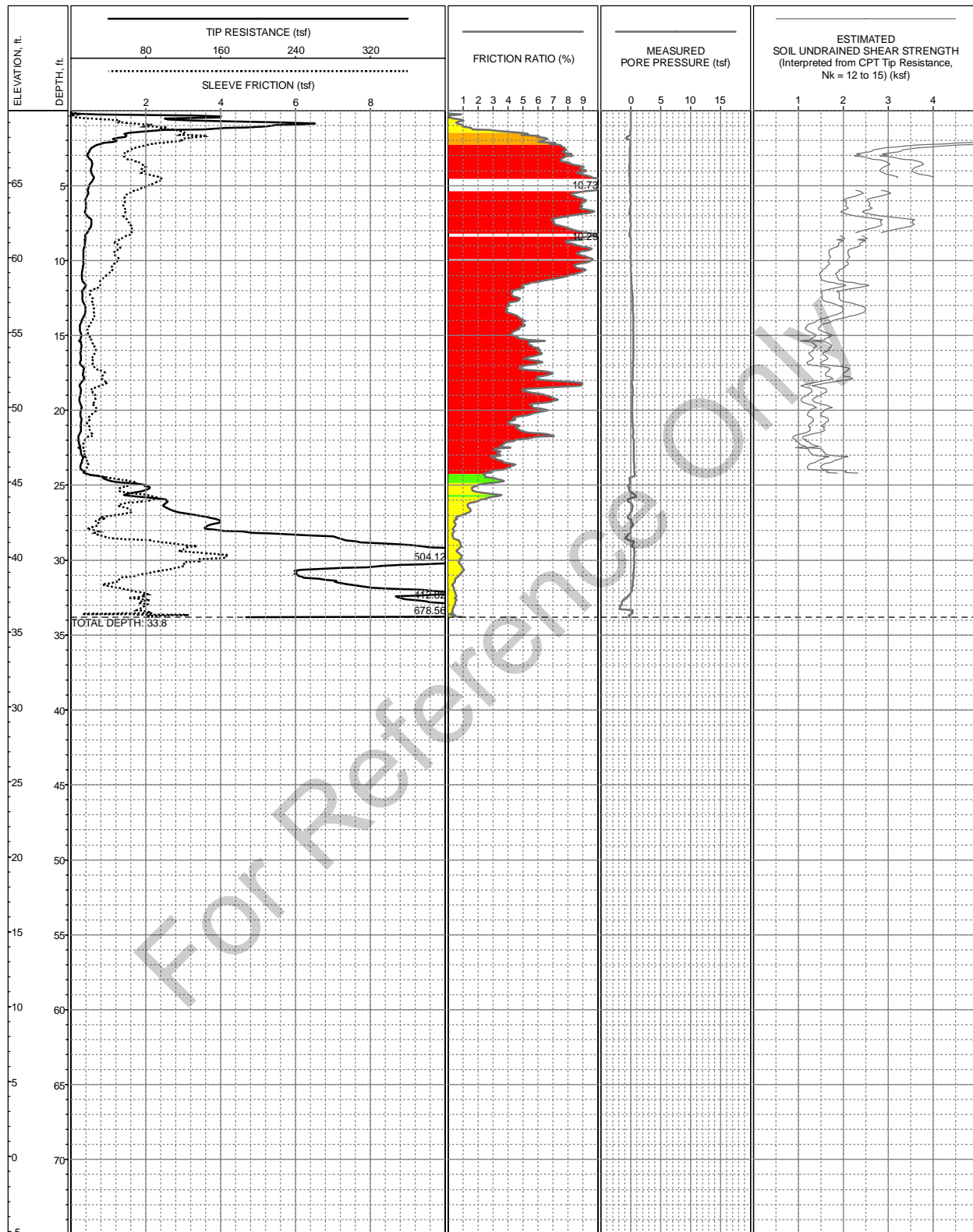

LOCATION: E6148283.5 N1951761.8 (NAD83, CA State Plane Zone III, Feet)
 SURFACE EL: 69.8ft (NAVD88)
 COMPLETION DEPTH: 33.8ft
 TEST DATE: 3/31/2007

CONE: F7.5CKESW1645
 PERFORMED BY: Fugro Consultants, Inc.
 OPERATOR: D Garza & R Norris
 REVIEWED BY: M Paquette

LOG OF CPT-173a
 Central Area Guideway of SVRT Project
 San Jose, California

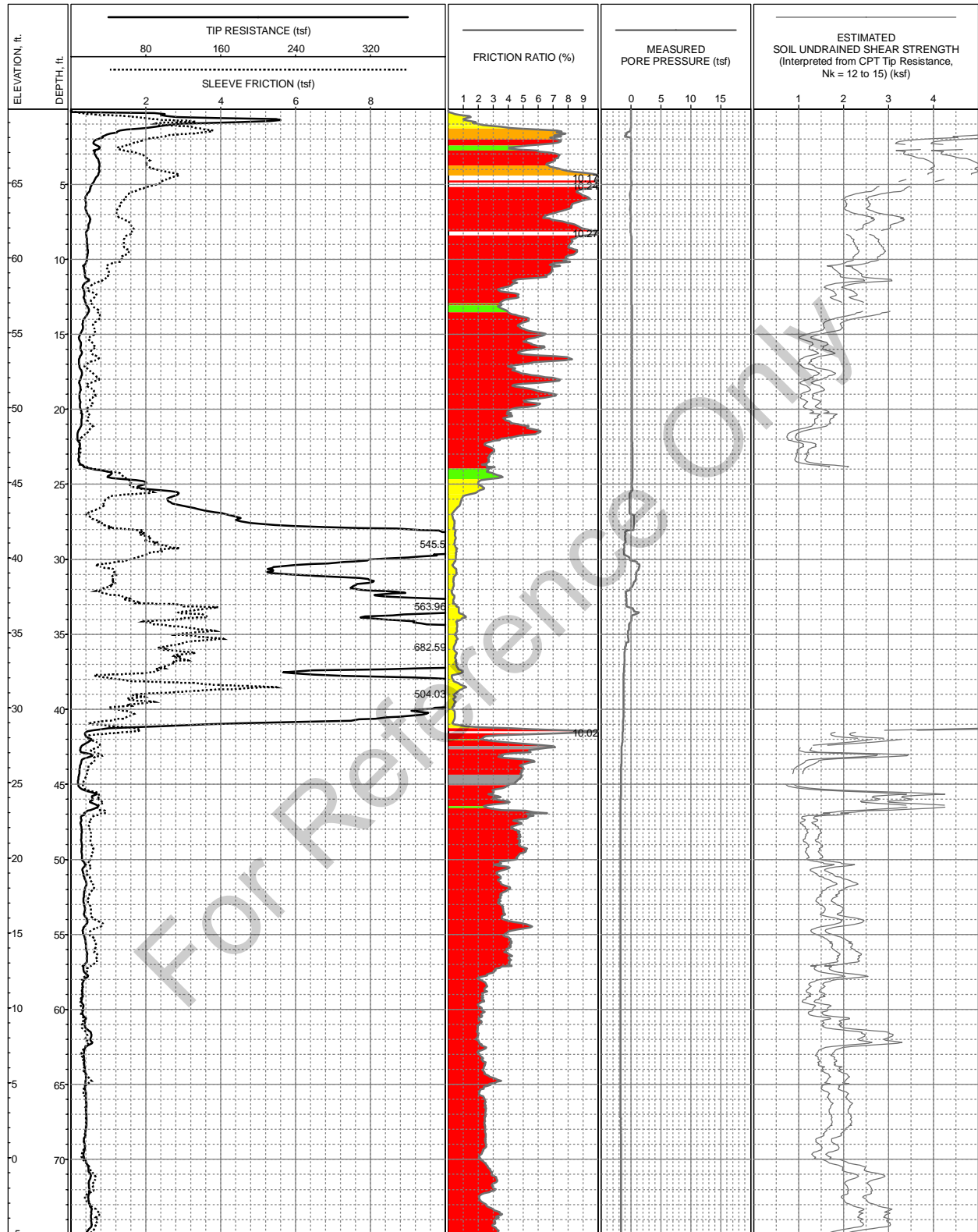

LOCATION: E6148259 N1951737 (NAD83, CA State Plane Zone III, Feet)
 SURFACE EL: 69.9ft (NAVD88)
 COMPLETION DEPTH: 81.5ft
 TEST DATE: 3/31/2007

CONE: F7.5CKEW1689
 PERFORMED BY: Fugro Consultants, Inc.
 OPERATOR: D Garza & R Norris
 REVIEWED BY: M Paquette

LOG OF CPT-173b
 Central Area Guideway of SVRT Project
 San Jose, California

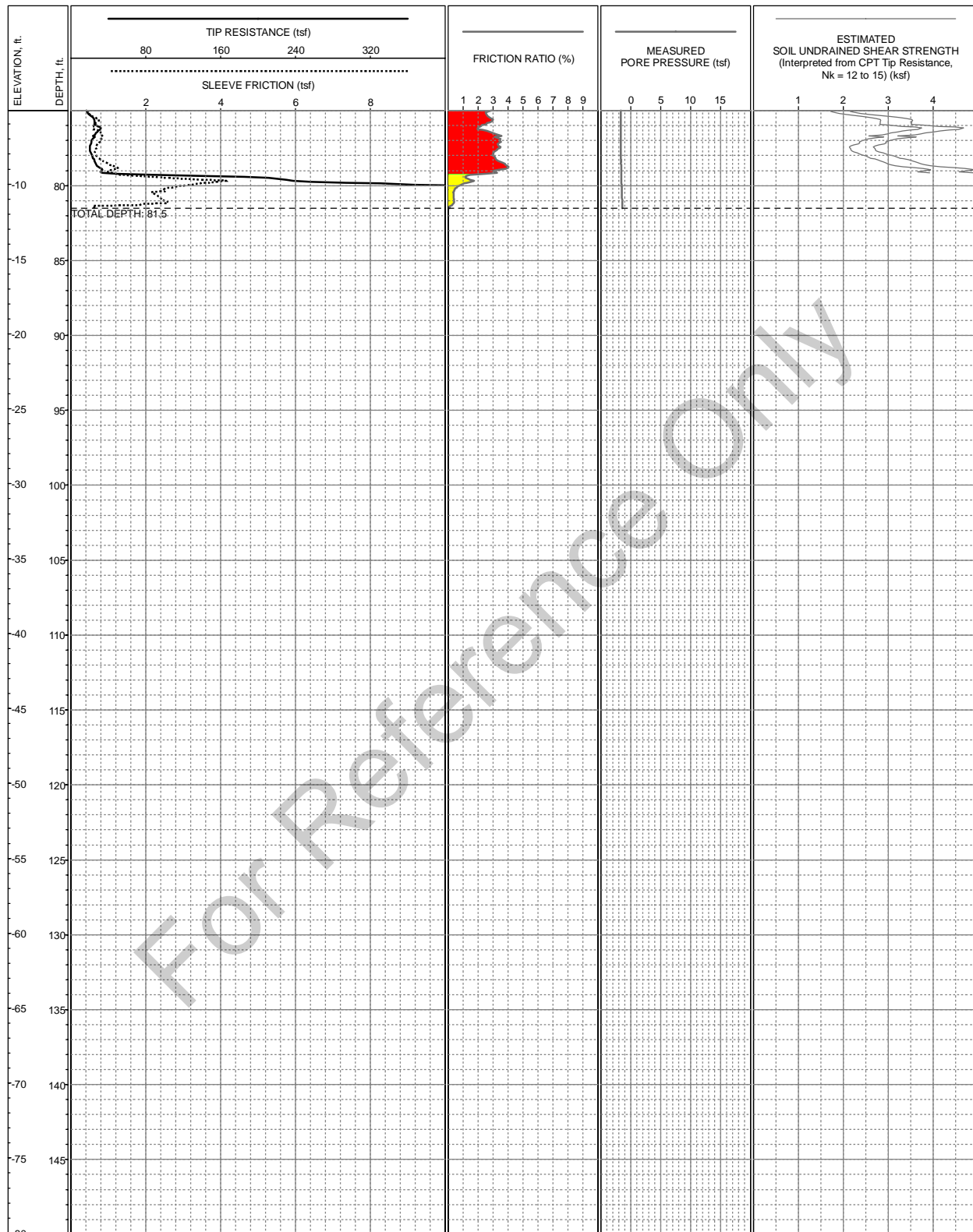

LOCATION: E6148259 N1951737 (NAD83, CA State Plane Zone III, Feet)
 SURFACE EL: 69.9ft (NAVD88)
 COMPLETION DEPTH: 81.5ft
 TEST DATE: 3/31/2007

CONE: F7.5CKEW1689
 PERFORMED BY: Fugro Consultants, Inc.
 OPERATOR: D Garza & R Norris
 REVIEWED BY: M Paquette

LOG OF CPT-173b
 Central Area Guideway of SVRT Project
 San Jose, California

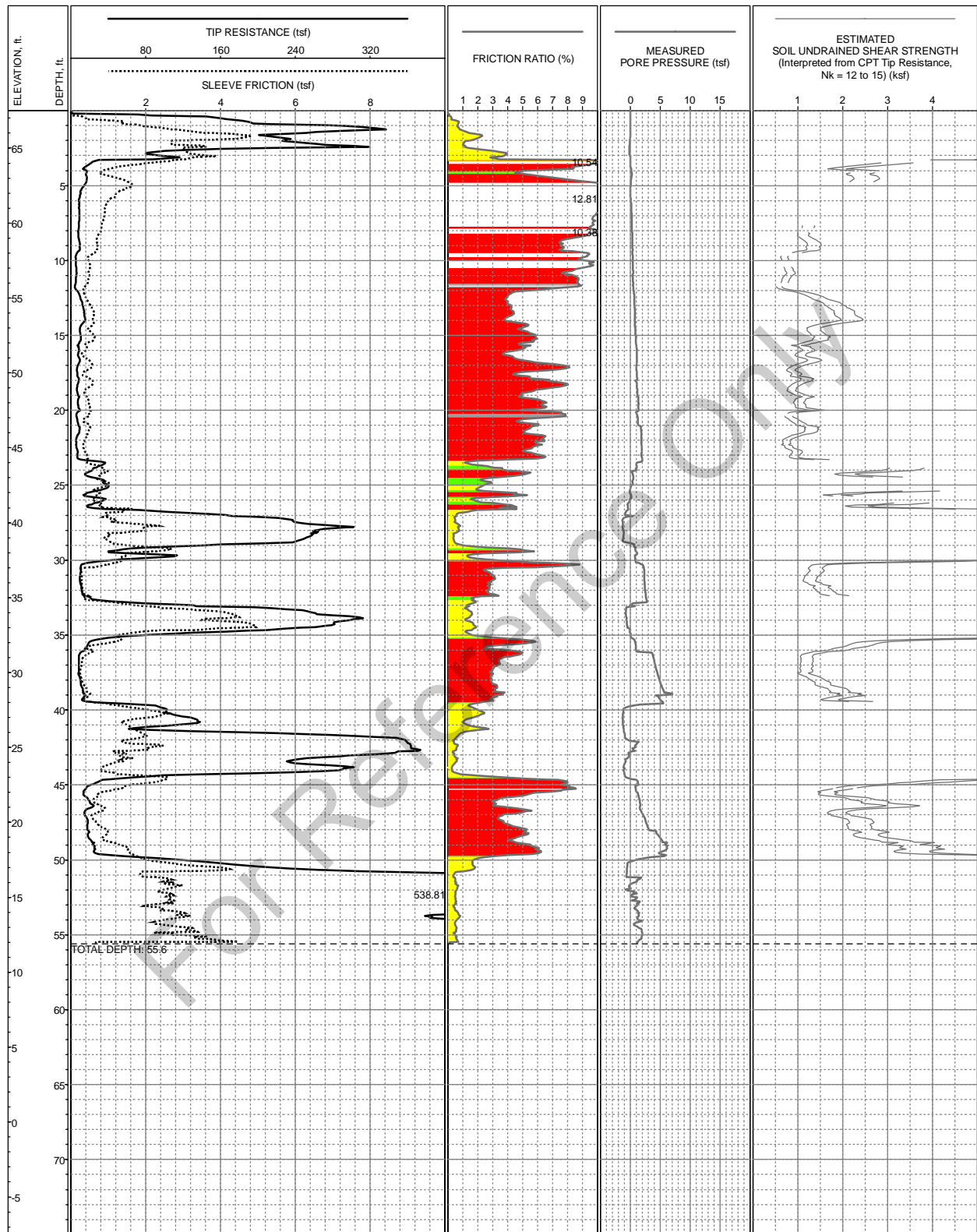

LOCATION: E6147771.2 N1952159.6 (NAD83, CA State Plane Zone III, Feet)
 SURFACE EL: 67.5ft (NAVD88)
 COMPLETION DEPTH: 55.6ft
 TEST DATE: 3/31/2007

CONE: F7.5CKESW1645
 PERFORMED BY: Fugro Consultants, Inc.
 OPERATOR: D Garza & R Norris
 REVIEWED BY: M Paquette

LOG OF CPT-174
 Central Area Guideway of SVRT Project
 San Jose, California

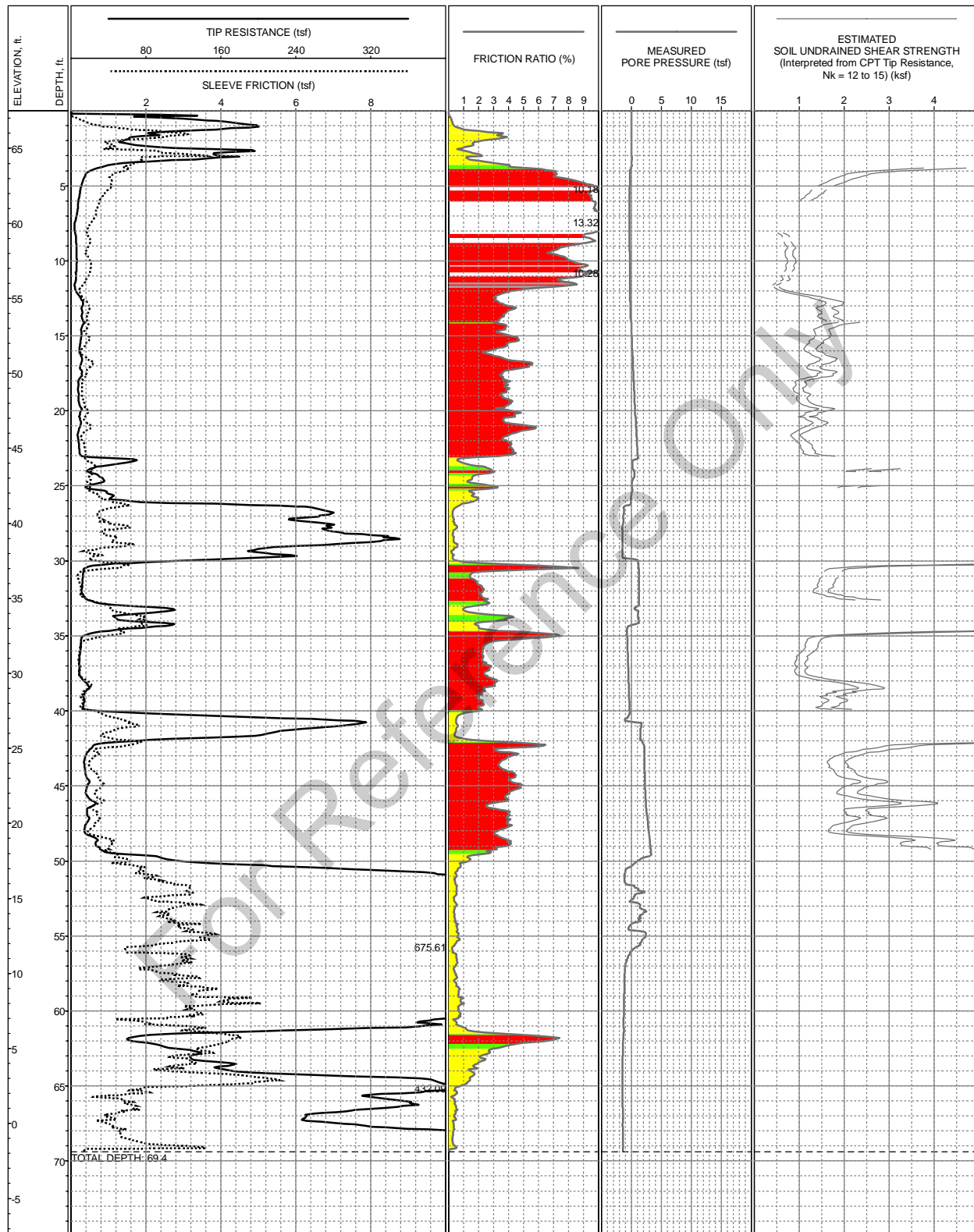

LOCATION: E6147774.2 N1952162.6 (NAD83, CA State Plane Zone III, Feet)
SURFACE EL: 67.5ft (NAVD88)
COMPLETION DEPTH: 69.4ft
TEST DATE: 3/31/2007

CONE: F7.5CKEW1689
PERFORMED BY: Fugro Consultants, Inc.
OPERATOR: D Garza & R Norris
REVIEWED BY: M Paquette

LOG OF CPT-174a
Central Area Guideway of SVRT Project
San Jose, California

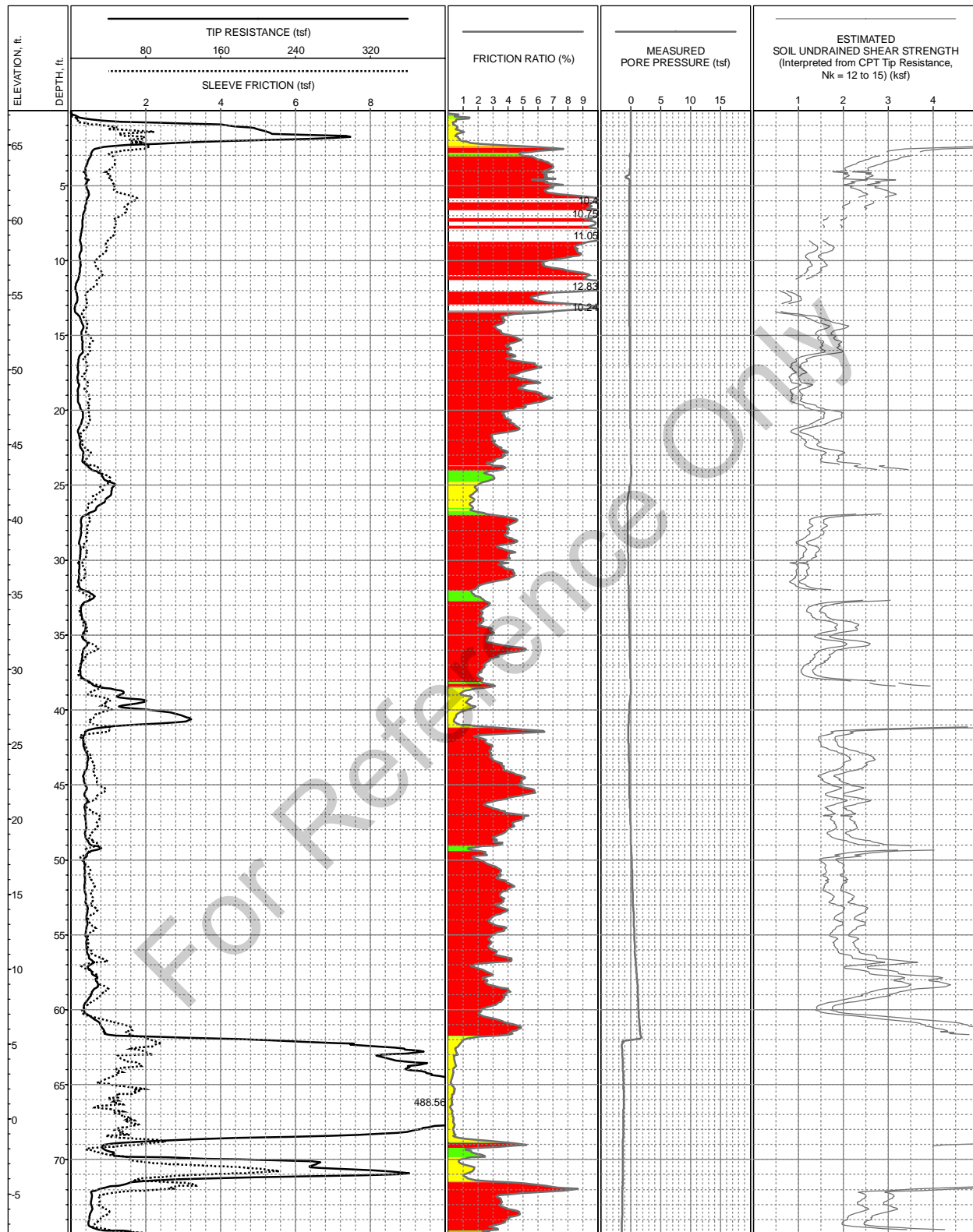

LOCATION: E6147668.7 N1952223.4 (NAD83, CA State Plane Zone III, Feet)
 SURFACE EL: 67.3ft (NAVD88)
 COMPLETION DEPTH: 80.5ft
 TEST DATE: 3/28/2007

CONE: F7.5CKEW1689
 PERFORMED BY: Fugro Consultants, Inc.
 OPERATOR: D Garza & R Norris
 REVIEWED BY: M Paquette

LOG OF CPT-175
 Central Area Guideway of SVRT Project
 San Jose, California

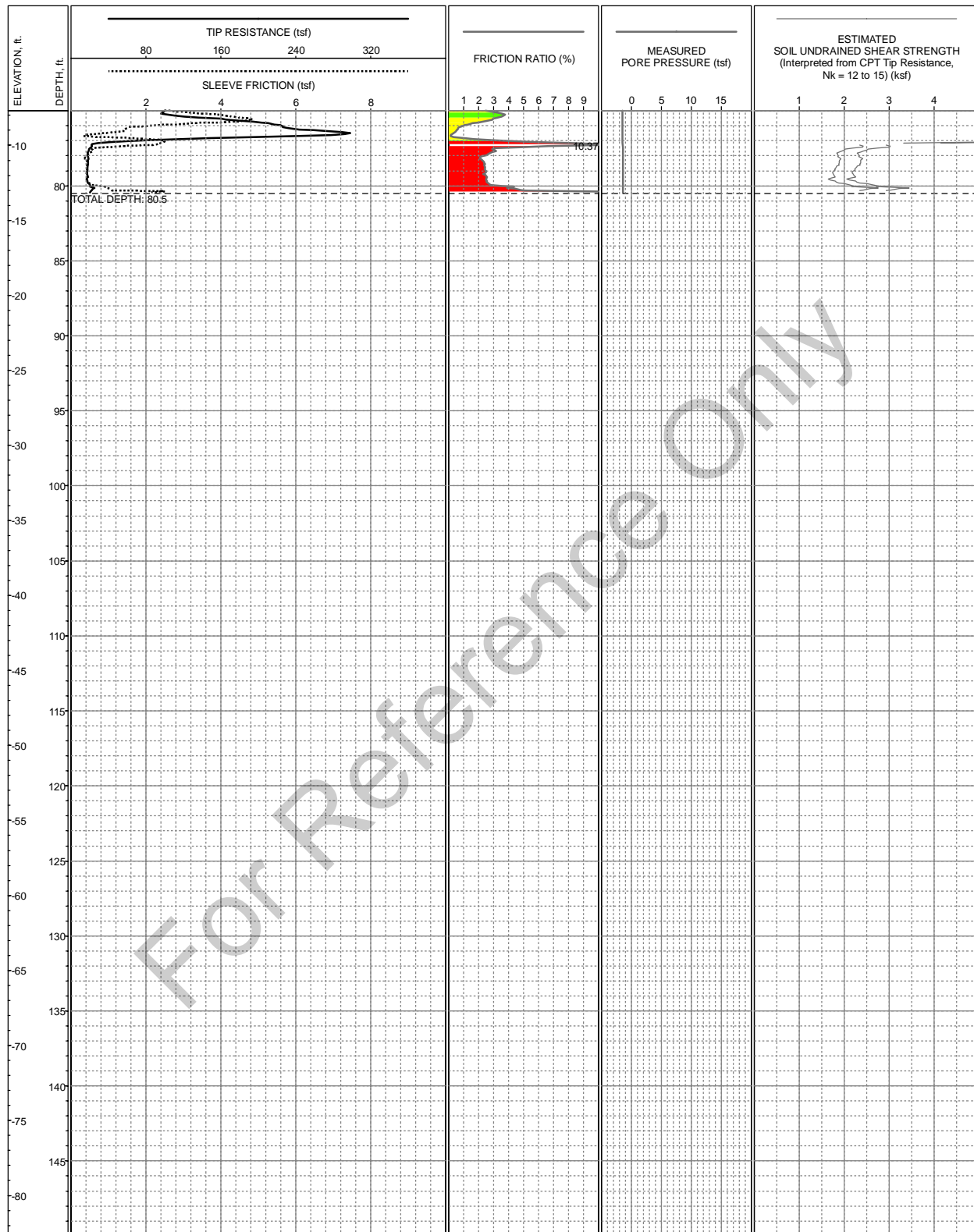

LOCATION: E6147668.7 N1952223.4 (NAD83, CA State Plane Zone III, Feet)
 SURFACE EL: 67.3ft (NAVD88)
 COMPLETION DEPTH: 80.5ft
 TEST DATE: 3/28/2007

CONE: F7.5CKEW1689
 PERFORMED BY: Fugro Consultants, Inc.
 OPERATOR: D Garza & R Norris
 REVIEWED BY: M Paquette

LOG OF CPT-175
 Central Area Guideway of SVRT Project
 San Jose, California

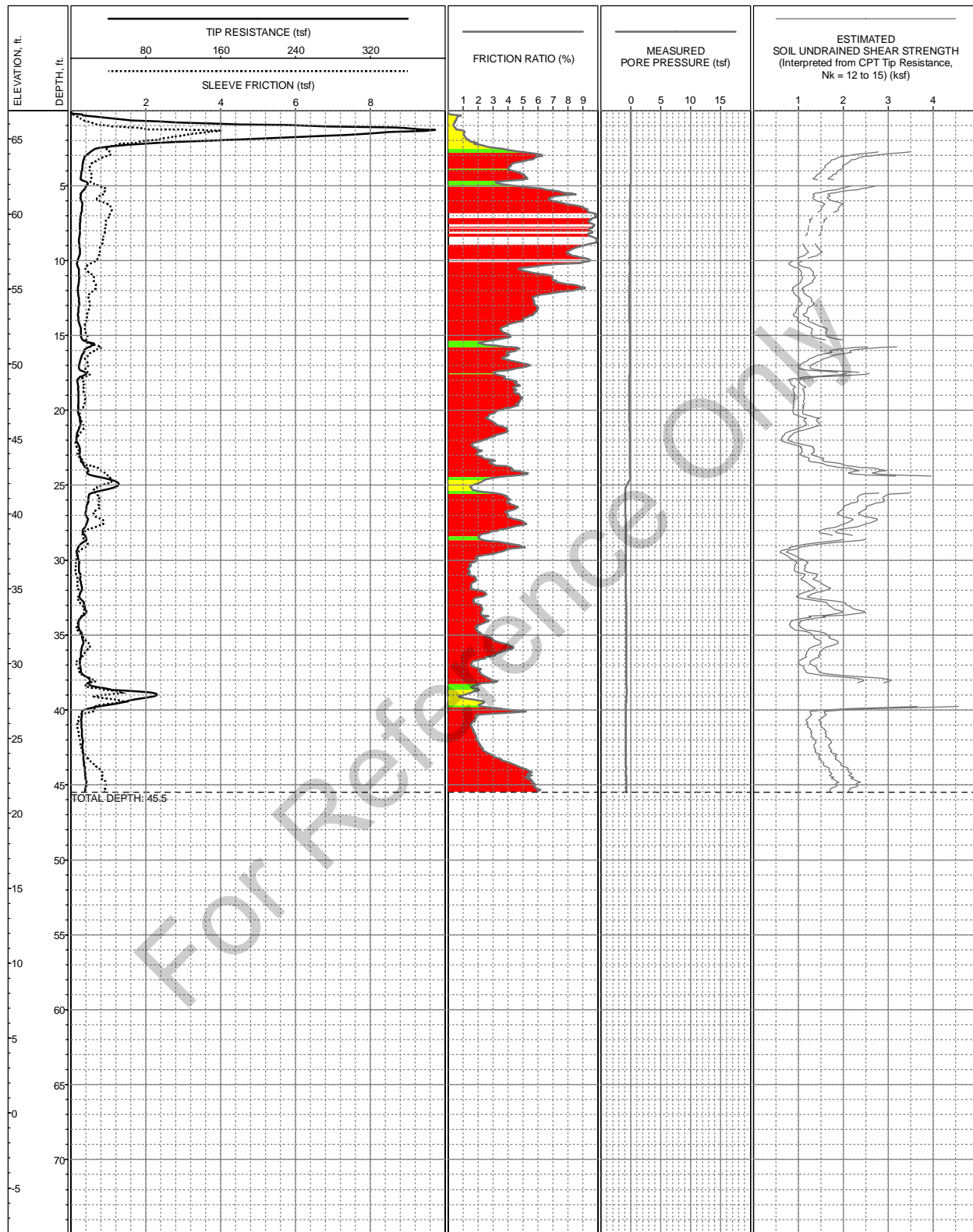

LOCATION: E6147514 N1952322.3 (NAD83, CA State Plane Zone III, Feet)
 SURFACE EL: 66.9ft (NAVD88)
 COMPLETION DEPTH: 45.5ft
 TEST DATE: 3/28/2007

CONE: F7.5CKEW1689
 PERFORMED BY: Fugro Consultants, Inc.
 OPERATOR: D Garza & R Norris
 REVIEWED BY: M Paquette

LOG OF CPT-176
 Central Area Guideway of SVRT Project
 San Jose, California

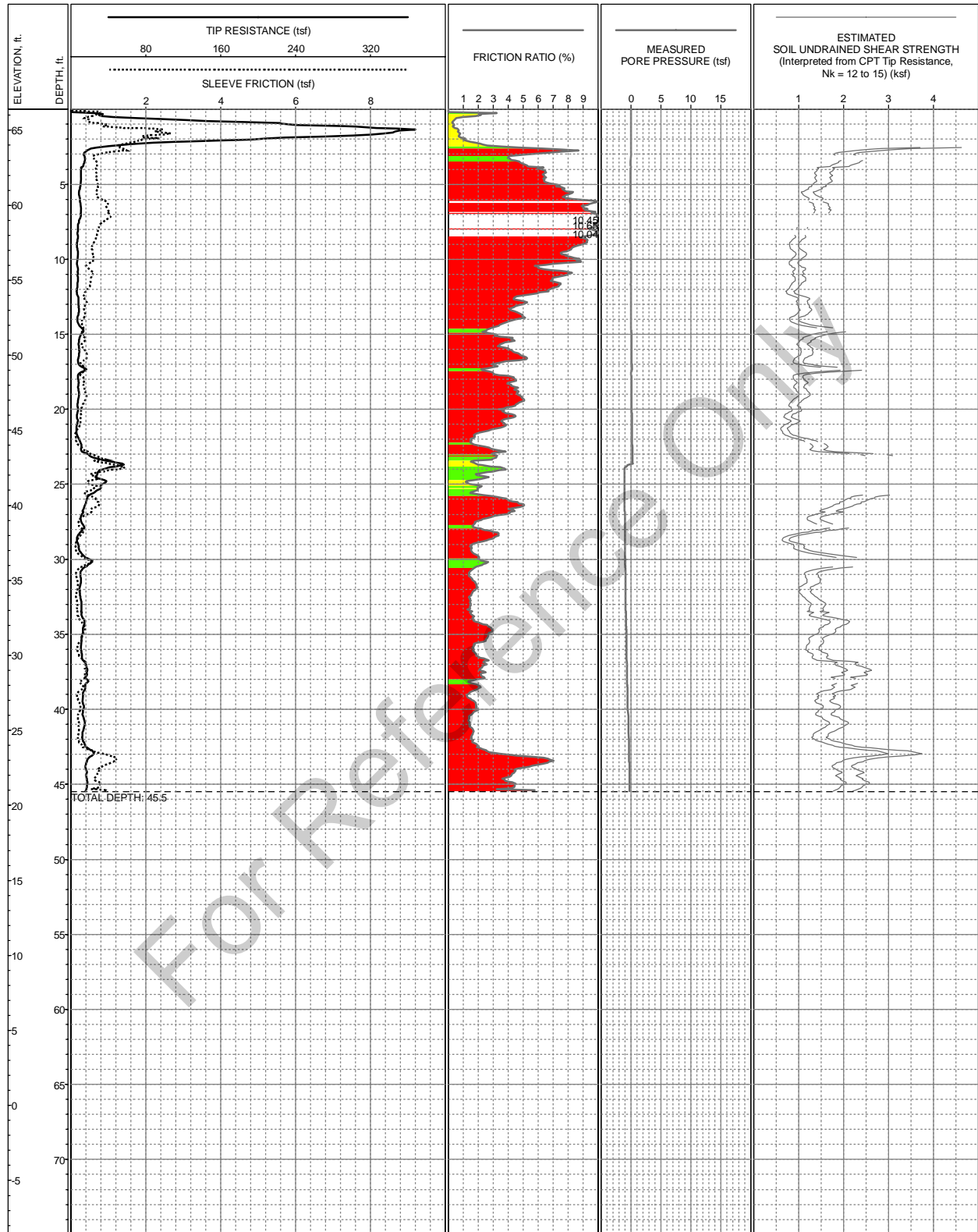

LOCATION: E6147398.2 N1952390.6 (NAD83, CA State Plane Zone III, Feet)
 SURFACE EL: 66.4ft (NAVD88)
 COMPLETION DEPTH: 45.5ft
 TEST DATE: 3/30/2007

CONE: F7.5CKEW1689
 PERFORMED BY: Fugro Consultants, Inc.
 OPERATOR: D Garza & R Norris
 REVIEWED BY: M Paquette

LOG OF CPT-177
 Central Area Guideway of SVRT Project
 San Jose, California

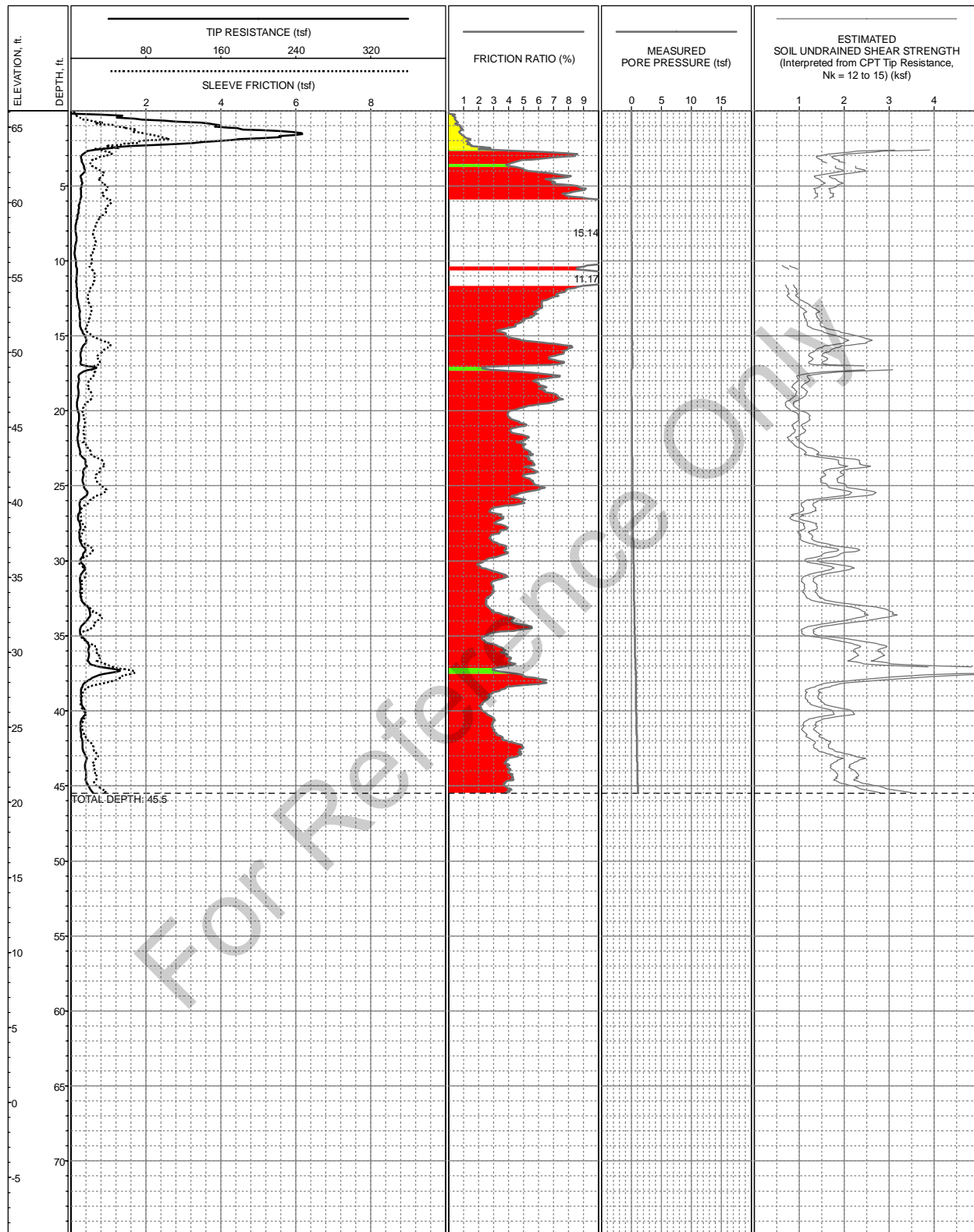

LOCATION: E6147259.5 N1952479.4 (NAD83, CA State Plane Zone III, Feet)
 SURFACE EL: 66.1ft (NAVD88)
 COMPLETION DEPTH: 45.5ft
 TEST DATE: 3/29/2007

CONE: F7.5CKEW1689
 PERFORMED BY: Fugro Consultants, Inc.
 OPERATOR: D Garza & R Norris
 REVIEWED BY: M Paquette

LOG OF CPT-178
 Central Area Guideway of SVRT Project
 San Jose, California

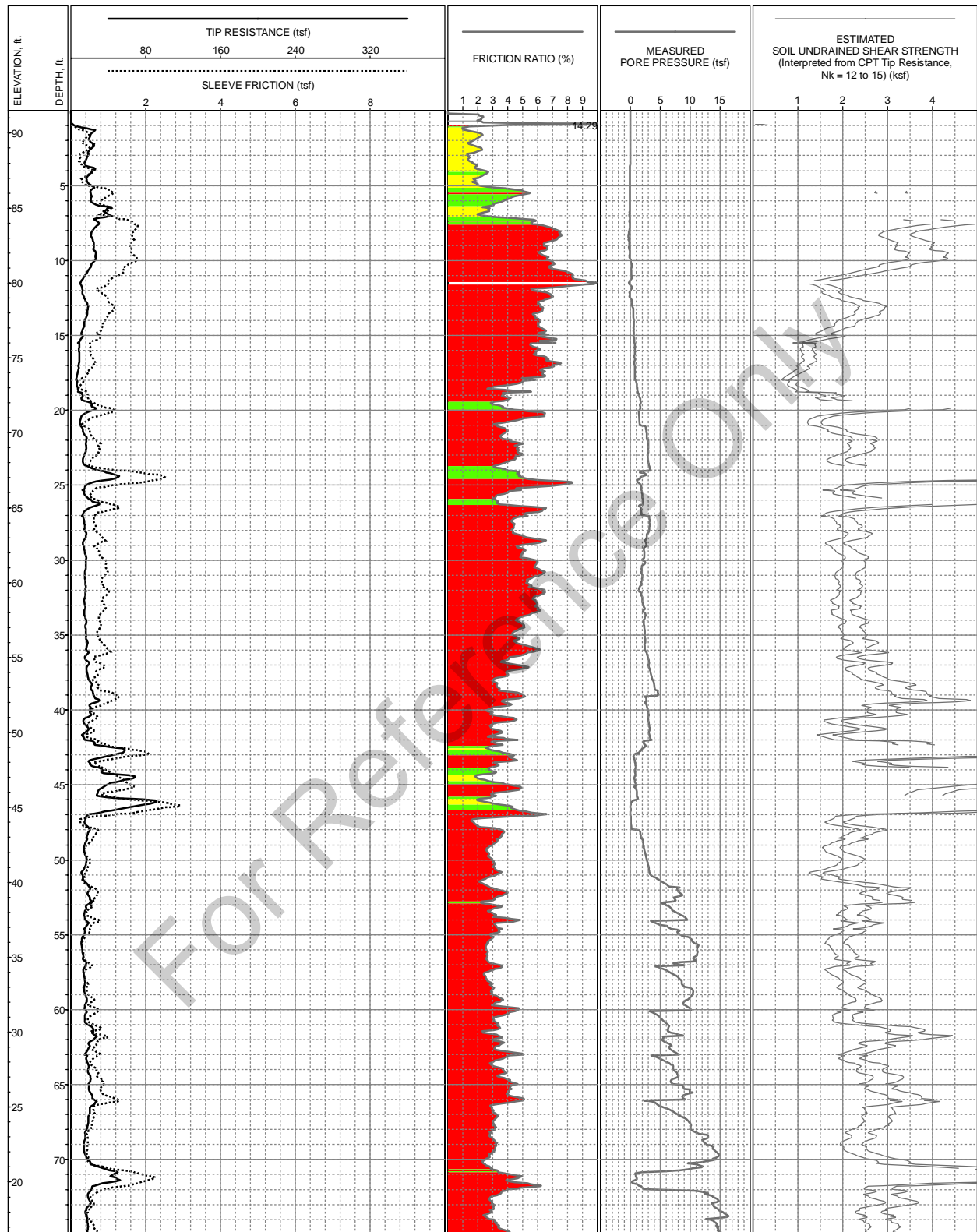

LOCATION: E6153986.9 N1945918.4 (NAD83, CA State Plane Zone III, Feet)
 SURFACE EL: 91.5ft (NAVD88)
 COMPLETION DEPTH: 115.5ft
 TEST DATE: 8/14/2007

CONE: F7.5CKEGW1645
 PERFORMED BY: Fugro Consultants, Inc.
 OPERATOR: D Garza
 REVIEWED BY: M Paquette

LOG OF CPT-179
 Central Area Guideway of SVRT Project
 San Jose, California

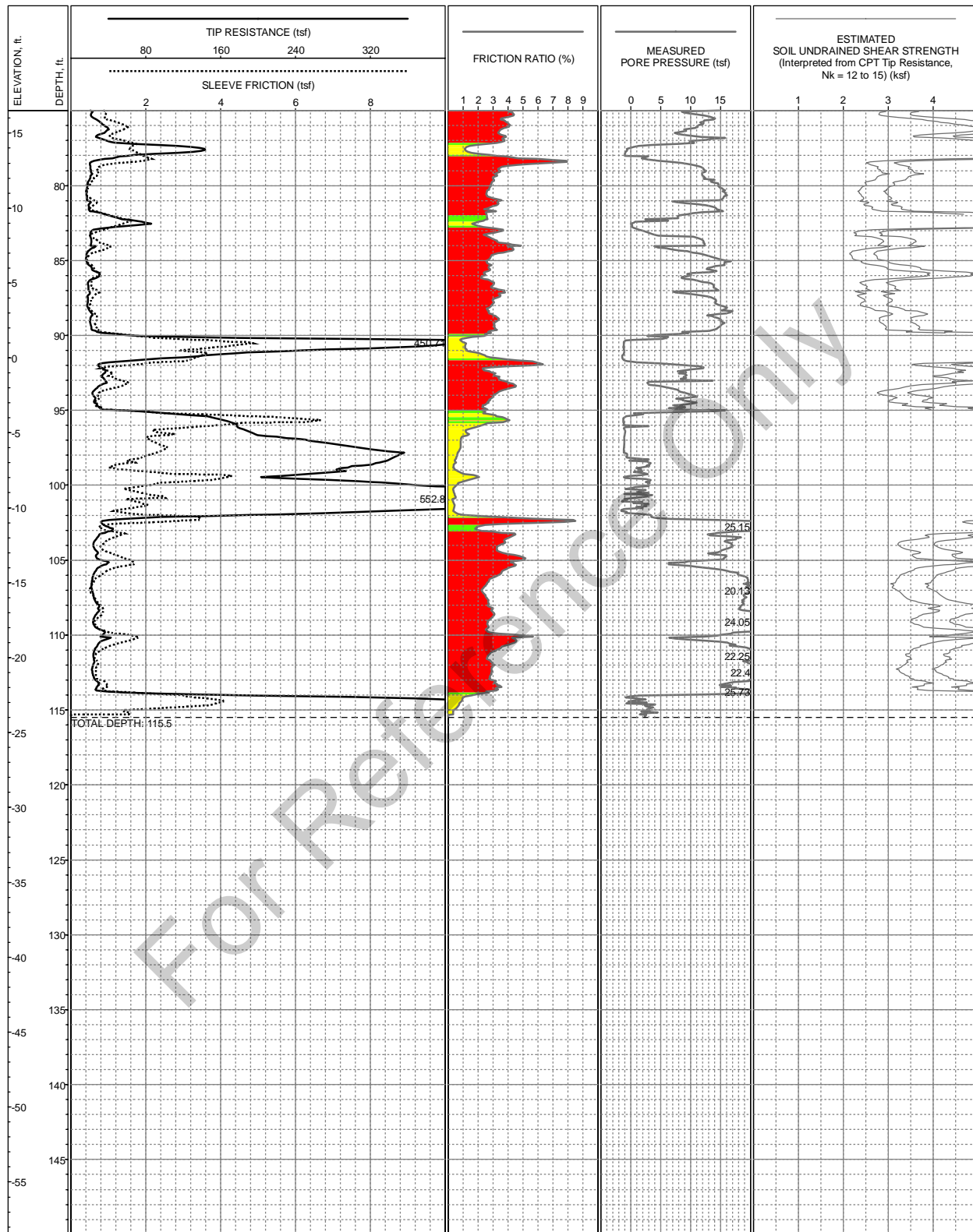

LOCATION: E6153986.9 N1945918.4 (NAD83, CA State Plane Zone III, Feet)
 SURFACE EL: 91.5ft (NAVD88)
 COMPLETION DEPTH: 115.5ft
 TEST DATE: 8/14/2007

CONE: F7.5CKEGW1645
 PERFORMED BY: Fugro Consultants, Inc.
 OPERATOR: D Garza
 REVIEWED BY: M Paquette

LOG OF CPT-179
 Central Area Guideway of SVRT Project
 San Jose, California

Appendix 3: Seismic Cone Penetration Test (SCPT) Results

For Reference Only

**APPENDIX 3
SEISMIC CONE PENETRATION TEST (SCPT)
RESULTS**

**GEOTECHNICAL EXPLORATION PROGRAM
CENTRAL AREA GUIDEWAY**

**SILICON VALLEY RAPID TRANSIT (SVRT) PROJECT
SAN JOSE, CALIFORNIA**

Prepared for:
HMM/Bechtel

JANUARY 2008

Fugro Project No. 1637.001

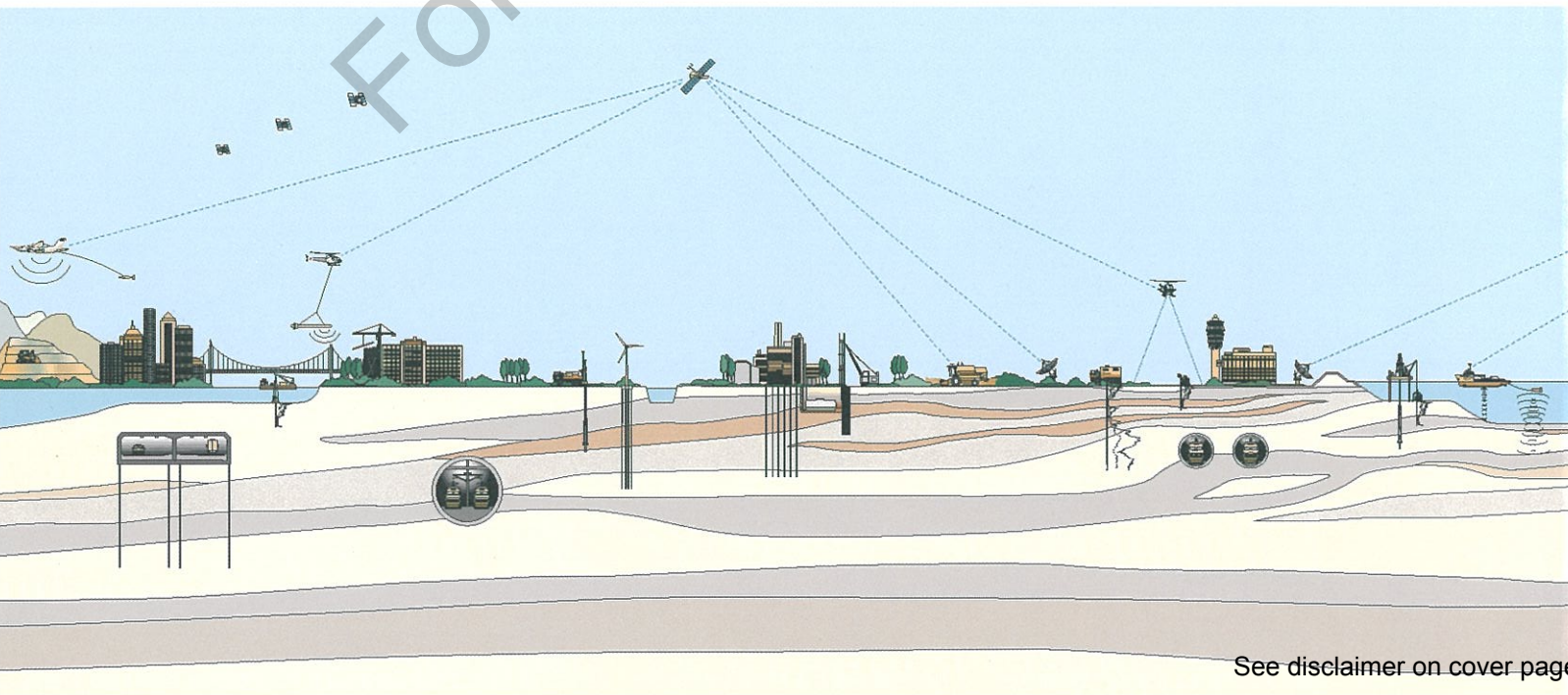

REPORT DOCKET

APPROVAL

This document is approved by the following:

Name	Title	Signature	Issue Date
Michael Paquette, P.E.	Project Engineer	<i>Michael Paquette</i>	1/21/08
Edwin Woo, P.E., G.E.	Principal Engineer	<i>Edwin P. Woo</i>	1/21/08

REVISION HISTORY

Revision	Date	Change	Approval
0	November 26, 2007	Draft Report: Appendix 9 Seismic Cone Penetration Test (SCPT) Results. Incorporating Phase 2 (2007) SCPTs	MP
1	January 21, 2008	Appendix 3 Seismic Cone Penetration Test (SCPT) Results Incorporating Phase 2 (2007) SCPTS	MP



January 21, 2008
Project No. 1637.001

HMM/Bechtel
3103 North First Street
San Jose, California 95134

Attention: Mr. Thomas Hunt, P.E.

Subject: Appendix 3 – Seismic Cone Penetration Test (SCPT) Results, Central Area
Guideway of SVRT Project, San Jose, California

Dear Mr. Hunt:

Fugro is pleased to submit this copy of "Appendix 3 – Seismic Cone Penetration Test (SCPT) Results," describing the seismic CPT test equipment, procedures and results for the Central Area Guideway of the SVRT Project in San Jose, California.

We appreciate this opportunity to be of continued service to HMM/Bechtel. Please contact Michael Paquette at (510) 267-4441 if you have any questions regarding the information presented in this appendix.

Sincerely,

FUGRO WEST, INC.

A handwritten signature in black ink that reads "Michael Paquette".

Michael Paquette, P.E.
Project Engineer

A handwritten signature in blue ink that reads "Edwin P. Woo".

Edwin P. Woo, P.E., G.E.
Principal Engineer

MP/EW:ej

Copies Submitted: (PDF) Addressee





CONTENTS

	Page
REPORT DOCKET	1
1.0 INTRODUCTION.....	1
1.1 Project Description	1
1.2 Geotechnical Exploration Program Overview.....	1
1.3 CPT Program Overview	2
1.4 Seismic Cone Penetration Test (SCPT) Program Overview	2
2.0 SCPT TEST EQUIPMENT AND PROCEDURES	3
2.1 Field Equipment	3
2.2 Field Procedures	4
2.3 Interpretation of Seismic Data	4
3.0 RESULTS AND DISCUSSION.....	5
3.1 Data Plots.....	5
4.0 LIMITATIONS.....	5
5.0 ADDITIONAL REFERENCE MATERIAL	6

TABLES

	Table
Summary of Seismic CPT Program	A3-1

LOGS OF CPTS

Key to SCPT Logs

SCPT Logs



1.0 INTRODUCTION

This appendix describes the equipment, procedures and results of the seismic cone penetration testing (SCPT) conducted by Fugro West, Inc., (Fugro) for the Central Area Guideway of the Silicon Valley Rapid Transit (SVRT) Project. The SCPTs were conducted at locations along the Central Area Guideway alignment of the SVRT Project, as shown on Figure 3-1 of the main report.

1.1 PROJECT DESCRIPTION

The Santa Clara Valley Transportation Authority (VTA) intends to construct the SVRT Project in San Jose, California. This will be a 26.2-km (16.3-mile) extension of the Bay Area Rapid Transit (BART) heavy rail rapid transit system from the planned terminus at the end of the Warm Springs Extension in Fremont, to San Jose. The proposed alignment currently includes several new stations and vehicle storage and maintenance facilities. The alignment is composed of two major segments:

- 1) The “Northern Area” that will be approximately 11.5 miles of at-grade, elevated and cut-and-cover track from Warm Springs to San Jose; and
- 2) The “Central Area Guideway”, a 5.1-mile-long tunnel, consisting of twin bored tunnels and cut-and-cover structures through downtown San Jose.

As currently planned, the Central Area Guideway includes at-grade and open cut track, cut-and-cover stations, and a cut-and-cover track crossover structure. The cut-and-cover stations and the crossover structures have a cumulative length of approximately 4,970 feet. The remaining 4.14 miles of the alignment will be twin 19.5-foot-diameter tunnels.

This investigation and report cover the 5.1-mile-long Central Area Guideway only.

1.2 GEOTECHNICAL EXPLORATION PROGRAM OVERVIEW

The joint venture of Hatch Mott MacDonald T & T, Inc., and Bechtel Infrastructure Corporation (HMM/Bechtel) is providing engineering design services for the Central Area Guideway of the SVRT Project to the VTA. HMM/Bechtel has subcontracted with a number of companies to conduct the geotechnical field exploration program for the project. HMM/Bechtel's primary subcontractors for the geotechnical exploration program include: Fugro, Parikh Consultants (Parikh) and Pitcher Drilling Company (Pitcher).

The three companies, Fugro, Parikh, and Pitcher, conducted the majority of the geotechnical field exploration program for the Central Area Guideway of the SVRT Project from October 2004 to March 2005. This supplementary geotechnical field investigation was performed between March 2007 and August 2007. The intent of the field investigation program was to obtain geotechnical data that would aid in the design and construction of the proposed tunnel and cut-and-cover structures.



In general, the geotechnical field investigations explored subsurface conditions along the proposed Central Area Guideway. The explorations were within the vicinity of the proposed Eastern and Western Portals, at the two proposed ventilation structures, and at the proposed stations, including Alum Rock Station, Downtown San Jose Station and Diridon/Arena Station. The geotechnical exploration program included:

- 2004 / 2005 Investigation
 - 76 Rotary Wash Borings (by others); and
 - 146 CPTs (by Fugro).
- 2007 Investigation
 - 18 Rotary Wash Borings (by others); and
 - 22 CPTs (by Fugro).

Figure 3-1 in the main report provides a map of the exploration locations. These locations were selected by HMM/Bechtel based on the following considerations: 1) the requirements of the tunnel designer, 2) the location of existing geotechnical data, 3) reducing impacts on private property, and 4) the avoidance of existing underground and overhead utilities. The locations of the 2007 explorations were chosen to fill in gaps in the data along the tunnel alignment. A subcontractor to HMM/Bechtel surveyed the CPT locations. HMM/Bechtel provided the surveyed coordinates to Fugro.

1.3 CPT PROGRAM OVERVIEW

Fugro West, Inc. and Fugro Consultants, Inc. (formerly Fugro Geosciences, Inc.) conducted the CPTs using a Fugro truck-mounted 25-ton cone apparatus. The CPTs were performed in general accordance with ASTM D5778. The continuous CPT soundings were typically advanced to refusal, which ranged from approximately 34 to 116 feet in depth. For detailed procedures and equipment specifications on the 2007 CPT operations, refer to Appendix 2 – CPT Testing. Downhole seismic shear (S) wave velocity measurements were successfully conducted at 12 CPT locations to obtain profiles of shear wave velocity versus depth as part of the 2007 investigation. Detailed information regarding the downhole SCPTs, including field procedures, data interpretation and results are discussed in the following sections.

1.4 SEISMIC CONE PENETRATION TEST (SCPT) PROGRAM OVERVIEW

Prior to initiation of the fieldwork, Fugro obtained the appropriate permits from the Santa Clara Valley Water District and City of San Jose. Seismic shear wave velocity tests were completed at a total of 12 locations as part of the 2007 study. Table A3-1 summarizes the Seismic CPT program.





Table A3-1. Summary of Seismic CPT Program

CPT	Proposed Structure	Location					Final Seismic Test Depth (ft)	Final CPT Test Depth (ft)
		Northing	Easting	Elev.	Station	Offset		
158	East Portal	1956837	6162889	91.6	562+47	30 L	44	45
161	East Portal	1956251	6163128	87.3	568+89	26 L	104	105
162	Alum Rock Station	1953716	6164945	87.1	600+71	140 L	72	73
165	Tunnel	1950703	6162527	96.1	642+21	41 L	76	77
167	Downtown Station	1947884	6157354	86.7	701+09	11 R	89	91
168	Diridon Station	1946017	6154586	87.8	734+51	100 L	149	150
169	Tunnel	1947464	6156937	89.0	706+79	145 L	83	85
171	Tunnel	1949684	6150804	75.1	794+96	42 R	74	75
172	Tunnel	1953024	6164741	88.0	607+63	66 R	112	113
173	West Portal	1951765	6148281	69.9	828+06	92 L	35	82
174	West Portal	1952160	6147771	67.5	834+47	21 L	53	69
179	Downtown Station	1945918	6153987	91.5	740+58	109 L	114	116

2.0 SCPT TEST EQUIPMENT AND PROCEDURES

2.1 FIELD EQUIPMENT

Downhole seismic shear wave velocity measurements were conducted using Fugro's SCPT system. The SCPT system includes the basic thrust system, a seismic cone assembly, a seismic wave source, and a digital recording seismograph. SCPT testing was performed in accordance with ASTM test designation D-5778-95.

The seismic cone assembly is similar to the conventional cone assembly, but also includes a three-component array of geophones. The geophones are orthogonally mounted inside the cone assembly at about 15 cm above the cone tip. The cone tip area of the seismic cone is 15 cm², with an area ratio of 0.59 to 0.61 and a cylindrical sleeve area of 200 cm².



The seismic source consisted of a heavy metal beam held firmly against the ground by the weight of the beam and additional weights placed on top of the beam. Seismic waves were generated at each test depth (3 to 5 foot intervals) by alternately striking each end of the beam with a 12-pound sledgehammer. A SmartSeis 100 Seismograph (manufactured by Geomatics) was integrated with Fugro's CPT equipment and was used for the seismic wave recording.

2.2 FIELD PROCEDURES

For CPT soundings in which seismic data were collected, conventional CPT testing was temporarily halted at either 3-foot or 5-foot intervals to collect seismic data. Shear waves were generated by striking a heavy steel beam on the ground with a 12-pound sledgehammer. The beam was positioned parallel to the cone truck, at least 10 feet from the cone rods, and was coupled to the ground surface by the weight of the beam and additional weights on top of the beam to prevent the beam from moving when struck. The beam was struck alternatively at opposite sides, generating shear waves with opposite polarity. Hammer blows on the beam triggered the seismograph to record the time histories of the generated seismic waves as they travel through the soil and are detected by the geophones, which monitor the waveform arrivals. Each side of the beam was struck several times, and each signal produced by a blow was closely examined for signal and noise content. If the signal appeared clean (i.e., the shear wave signal is clearly defined) that waveform was selected for stacking and the arrival time of the shear wave was picked and recorded. Further signals generated by additional blows were similarly examined and stacked to minimize noise detected and improve the overall signal to noise ratio. As a standard procedure, a minimum of three stacks, per side of the beam, per depth were recorded. However, in a noisy environment, the beam is struck continuously until a clean and consistent signal is obtained for stacking. As such, the beam may have been struck more times than the actual number of signals chosen for stacking. Waveforms were digitally recorded and saved in the seismograph's hard drive for further processing. After a complete set of seismic data was recorded, the cone was advanced to the next depth, and the procedure was repeated until the hole was complete.

2.3 INTERPRETATION OF SEISMIC DATA

The seismic data at each SCPT location were interpreted as follows:

- The shear wave arrival time at each depth is first determined from the recorded "stacked" signals using software on the seismograph;
- Arrival times are determined for each of the two sides of the beam that are struck and are designated "east" and "west" arrival times;
- The east and west arrival times are checked in the field to ensure that consistent arrival times are recorded between the two strike directions;
- The average arrival time is determined from the east and west arrival times; and
- A strike angle is determined based on the horizontal offset of the seismic source from the CPT rods and the average vertical arrival time is determined by taking the sine of the strike angle;



- The incremental seismic velocity is determined by taking the difference in vertical average arrival time between two depth increments, and dividing by the length of the increment (typically 3 to 5 feet);

3.0 RESULTS AND DISCUSSION

3.1 DATA PLOTS

CPT sound logs for the 12 SCPTs performed in 2007 are attached to this appendix. The CPT logs provide graphical plots versus depth showing:

- Measured cone tip resistance, in tons per square foot (tsf);
- Measured sleeve friction, in tsf;
- Friction ratio, in percentage, including color coding denoting the Soil Behavior Type according to Robertson, 1990 (see CPT correlation chart);
- Measured pore pressure at the u2 location, in tsf; and
- Measured shear wave velocity, in feet per second.

4.0 LIMITATIONS

Our services consist of subsurface field explorations and data evaluations that are made in accordance with generally accepted geotechnical engineering principles and practices. This warranty is in lieu of all other warranties, either expressed or implied.

The data provided in this appendix are based on the subsurface explorations conducted for this study. These explorations indicate subsurface conditions only at specific locations and times, and only to the depths penetrated. Variations may exist and conditions not observed or described in this report could be encountered during construction. Our results are based on our standard practices and specific data obtained.

This appendix has been prepared for the exclusive use of HMM/Bechtel and their consultants for specific application to the SVRT project as described herein. In the event that there are any changes in the ownership, nature, design, or location of the proposed project, or if any future additions are planned, the results contained in this appendix should not be considered valid unless: 1) the project changes are reviewed by Fugro, and 2) results presented in this appendix are modified or verified in writing. Reliance on this report by others must be at their risk unless we are consulted on the use or limitations. We cannot be responsible for the impacts of any changes in geotechnical standards, practices, or regulations subsequent to performance of services without our further consultation. We can neither vouch for the accuracy of information supplied by others, nor accept consequences for unconsulted use of segregated portions of this report.



5.0 ADDITIONAL REFERENCE MATERIAL

Fugro West, Inc. (2005), "Appendix 9 Seismic Cone Penetration Test (SCPT) Results, Geotechnical Exploration Program, Tunnel Segment of Silicon Valley Rapid Transit (SVRT) Project, San Jose, California" Prepared for HMM/Bechtel, Fugro Project No. 1637.001

Lunne, Robertson & Powell (1997), *Cone Penetration Testing in Geotechnical Practice*, Blackie Academic & Professional, London, UK.

Robertson, P.K., Campanella, R.G., Gillespie, D. and Greig, J. (1986), "Use of Piezocone Data," *Proceedings of the ASCE Specially Conference In Situ 1986: Use of In Situ Tests in Geotechnical Engineering*, Blacksburg, pp.1263-80.

Robertson, P.K., (1990), "Soil Classification using the Cone Penetration Test," *Canadian Geotechnical Journal*, 27

For Reference Only



For Reference Only

LOGS OF SEISMIC CPTs

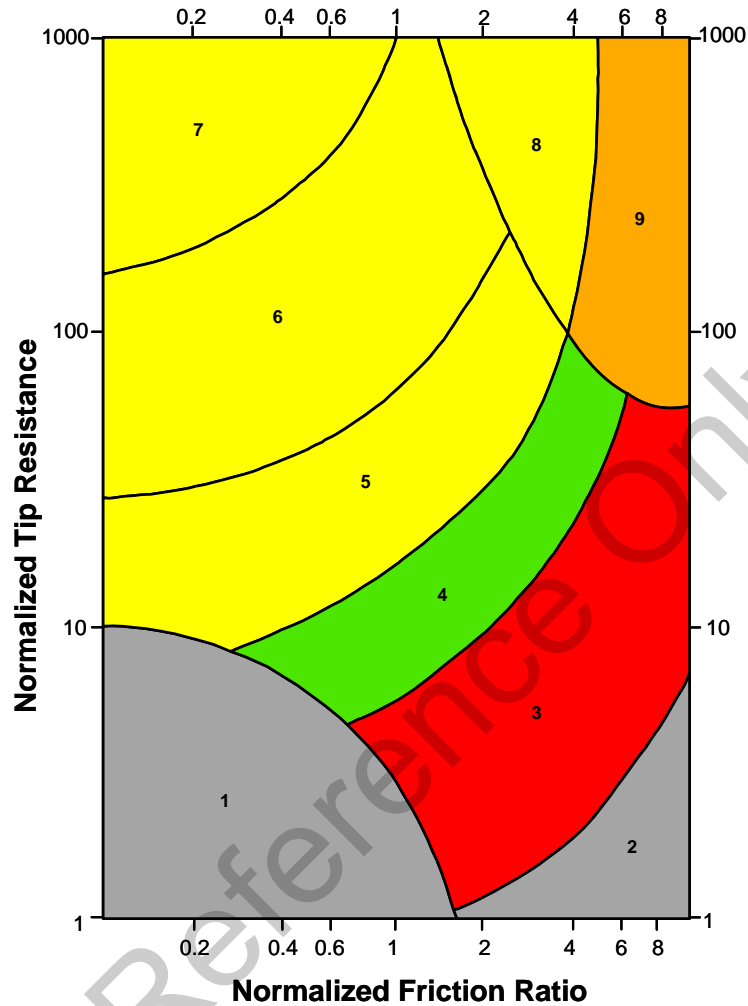

Zone	Soil Behavior Type
1	Sensitive Fine-grained
2	Organic Material
3	Clay to Silty Clay
4	Clayey Silt to Silty Clay
5	Silty Sand to Sandy Silt
6	Clean Sands to Silty Sands
7	Gravelly Sand to Sand
8	Very Stiff Sand to Clayey Sand *
9	Very Stiff Fine-grained *

*overconsolidated or cemented

CPT CORRELATION CHART
(Modified from Robertson, 1990)

KEY TO CPT LOGS
Central Area Guideway of SVRT Project
San Jose, California

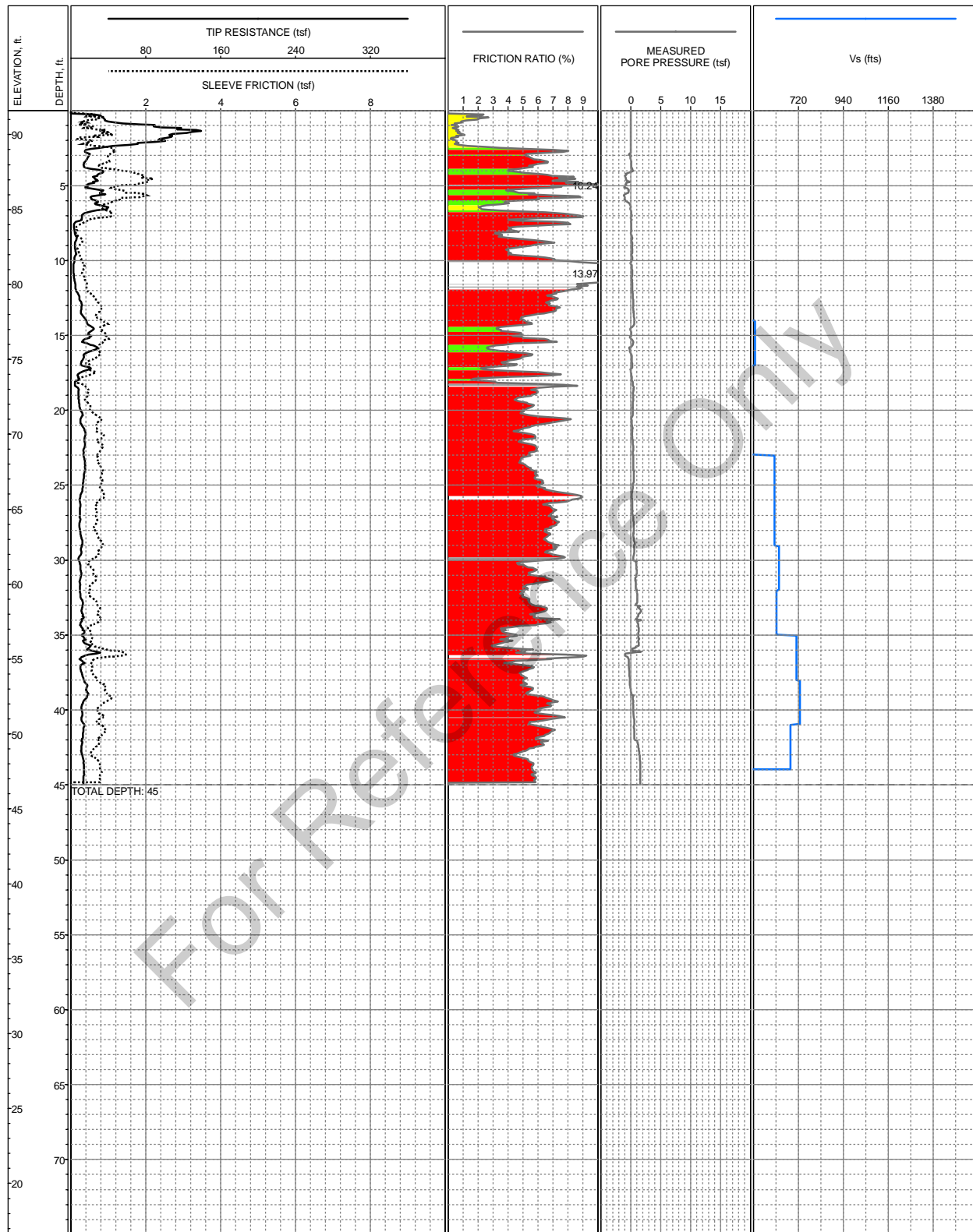

LOCATION: E6162888.9 N1956837.2 (NAD83, CA State Plane Zone III, Feet)
 SURFACE EL: 91.6ft +/- (NAVD88)
 COMPLETION DEPTH: 45ft
 TEST DATE: 4/3/2007

CONE: F7.5CKESW1645
 PERFORMED BY: Fugro Consultants, Inc.
 OPERATOR: D Garza & R Norris
 REVIEWED BY: M Paquette

LOG OF CPT-158
 Central Area Guideway of SVRT Project
 San Jose, California

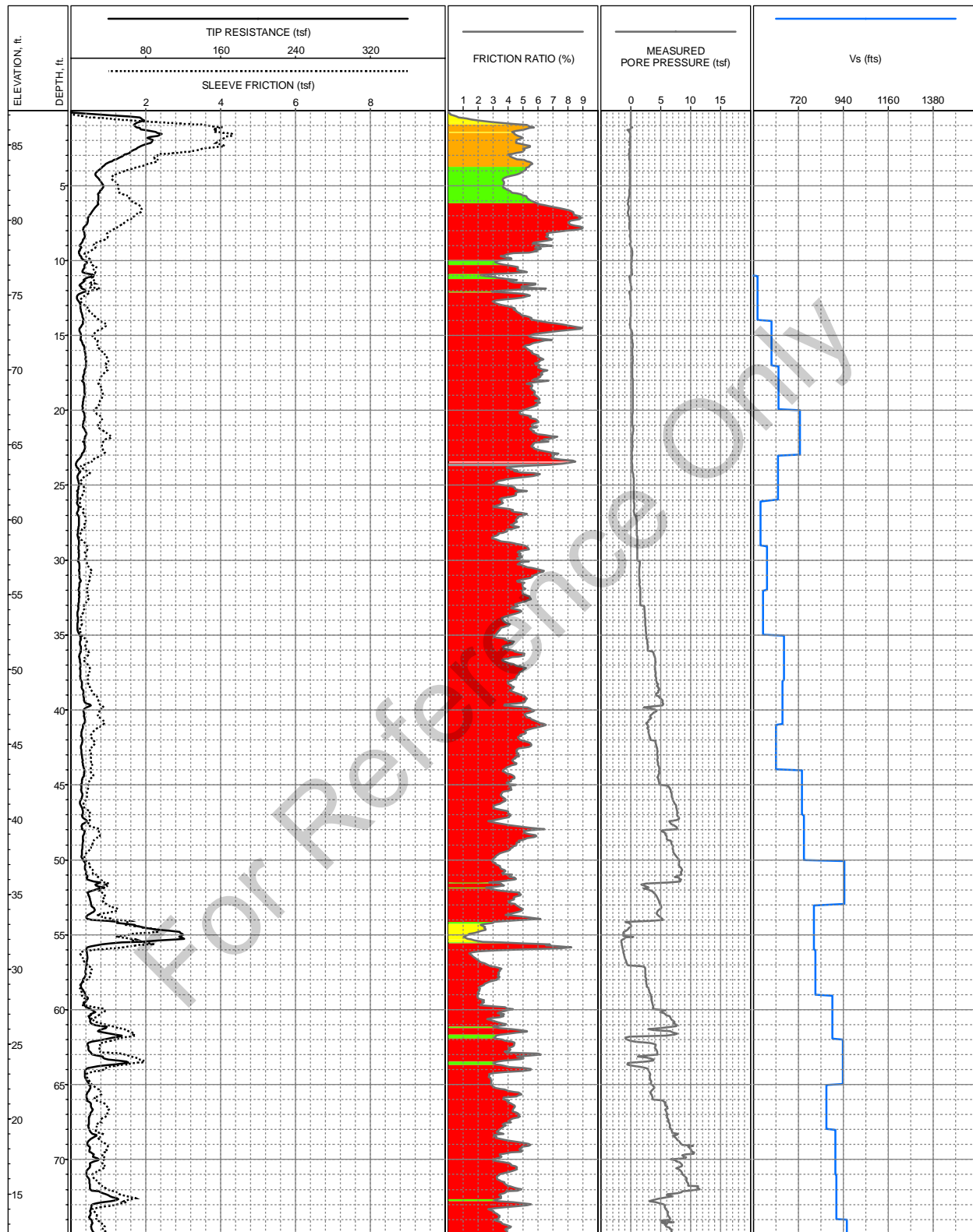

LOCATION: E6163128.3 N1956250.6 (NAD83, CA State Plane Zone III, Feet)
 SURFACE EL: 87.3ft +/- (NAVD88)
 COMPLETION DEPTH: 105ft
 TEST DATE: 4/3/2007

CONE: F7.5CKESW1645
 PERFORMED BY: Fugro Consultants, Inc.
 OPERATOR: D Garza & R Norris
 REVIEWED BY: M Paquette

LOG OF CPT-161
 Central Area Guideway of SVRT Project
 San Jose, California

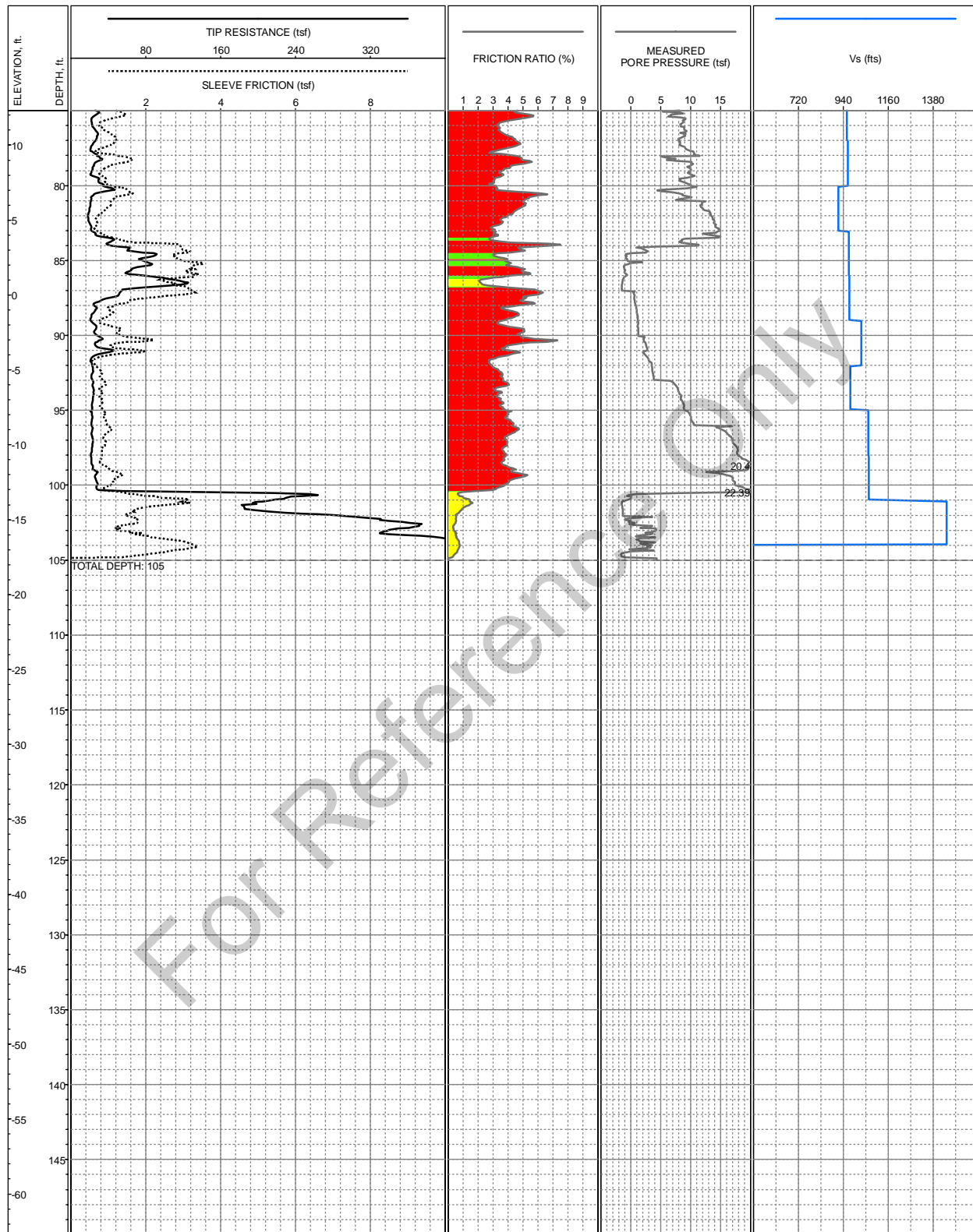

LOCATION: E6163128.3 N1956250.6 (NAD83, CA State Plane Zone III, Feet)
 SURFACE EL: 87.3ft +/- (NAVD88)
 COMPLETION DEPTH: 105ft
 TEST DATE: 4/3/2007

CONE: F7.5CKESW1645
 PERFORMED BY: Fugro Consultants, Inc.
 OPERATOR: D Garza & R Norris
 REVIEWED BY: M Paquette

LOG OF CPT-161
 Central Area Guideway of SVRT Project
 San Jose, California

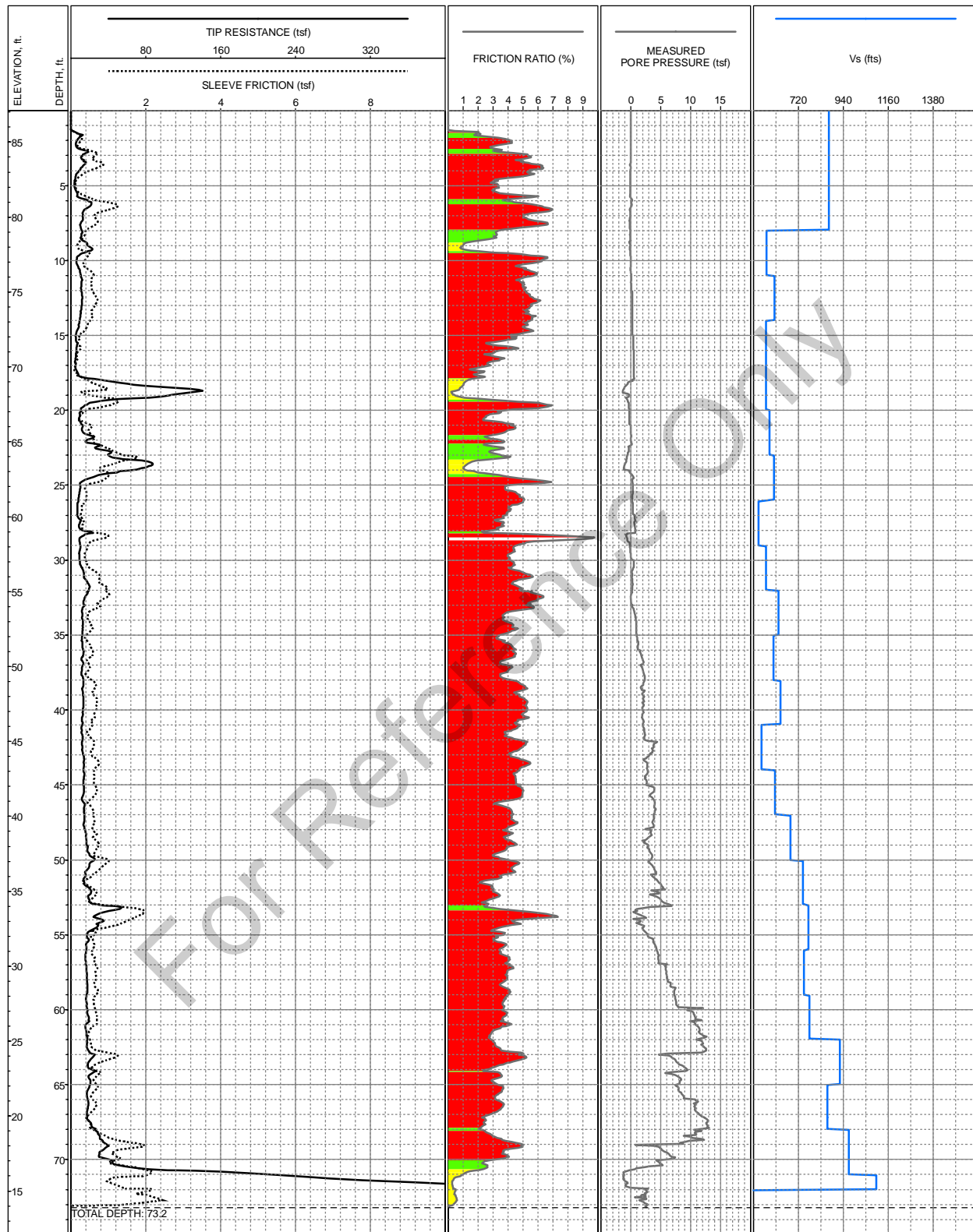

LOCATION: E6164944.9 N1953715.9 (NAD83, CA State Plane Zone III, Feet)
 SURFACE EL: 87.1ft +/- (NAVD88)
 COMPLETION DEPTH: 73.2ft
 TEST DATE: 8/13/2007

CONE: F7.5CKEGW1645
 PERFORMED BY: Fugro Consultants, Inc.
 OPERATOR: D Garza
 REVIEWED BY: M Paquette

LOG OF CPT-162
 Central Area Guideway of SVRT Project
 San Jose, California

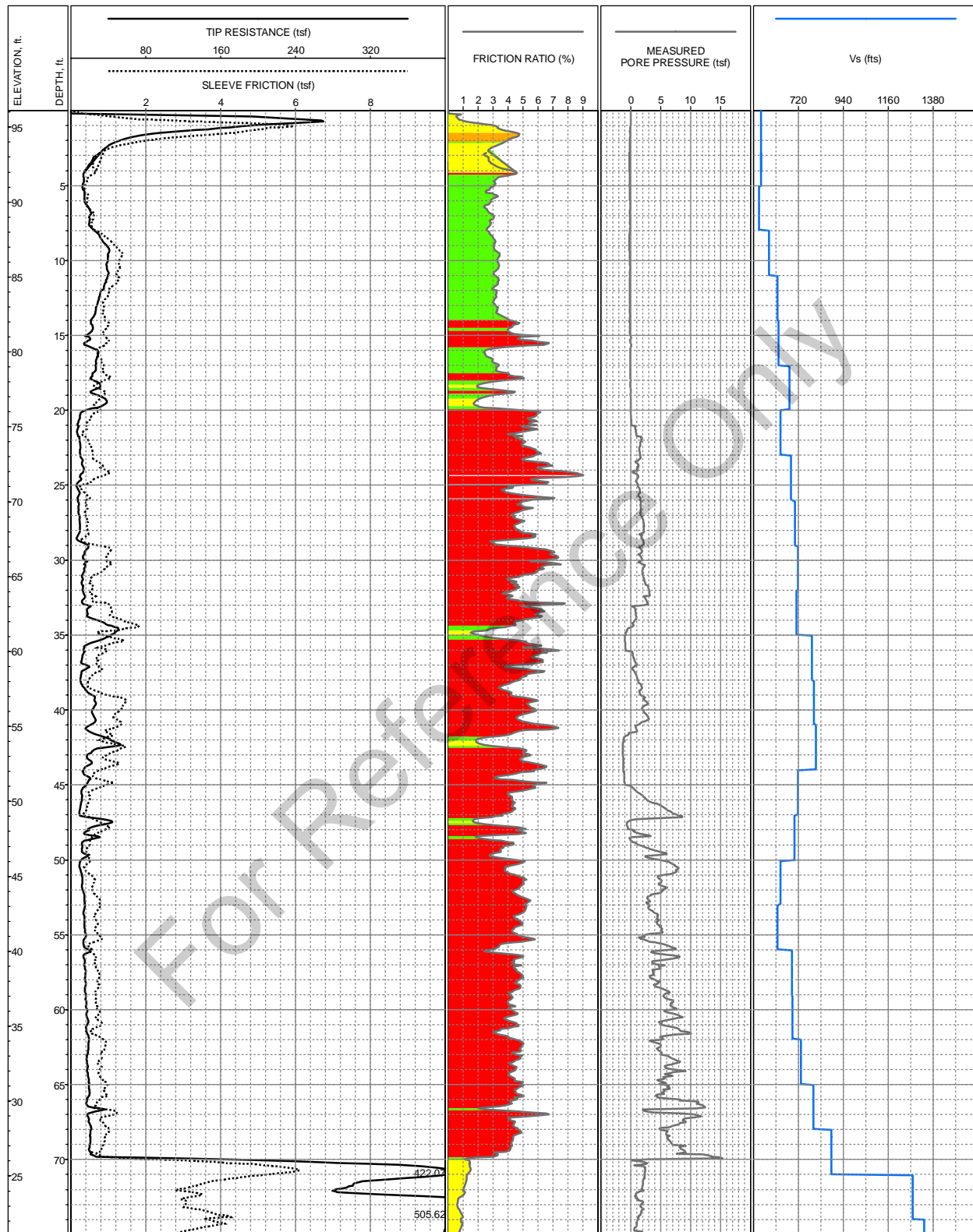

LOCATION: E6162527.2 N1950703.4 (NAD83, CA State Plane Zone III, Feet)
 SURFACE EL: 96.1ft +/- (NAVD88)
 COMPLETION DEPTH: 77.4ft
 TEST DATE: 8/16/2007

CONE: F7.5CKEGW1645
 PERFORMED BY: Fugro Consultants, Inc.
 OPERATOR: D Garza
 REVIEWED BY: M Paquette

LOG OF CPT-165
 Central Area Guideway of SVRT Project
 San Jose, California

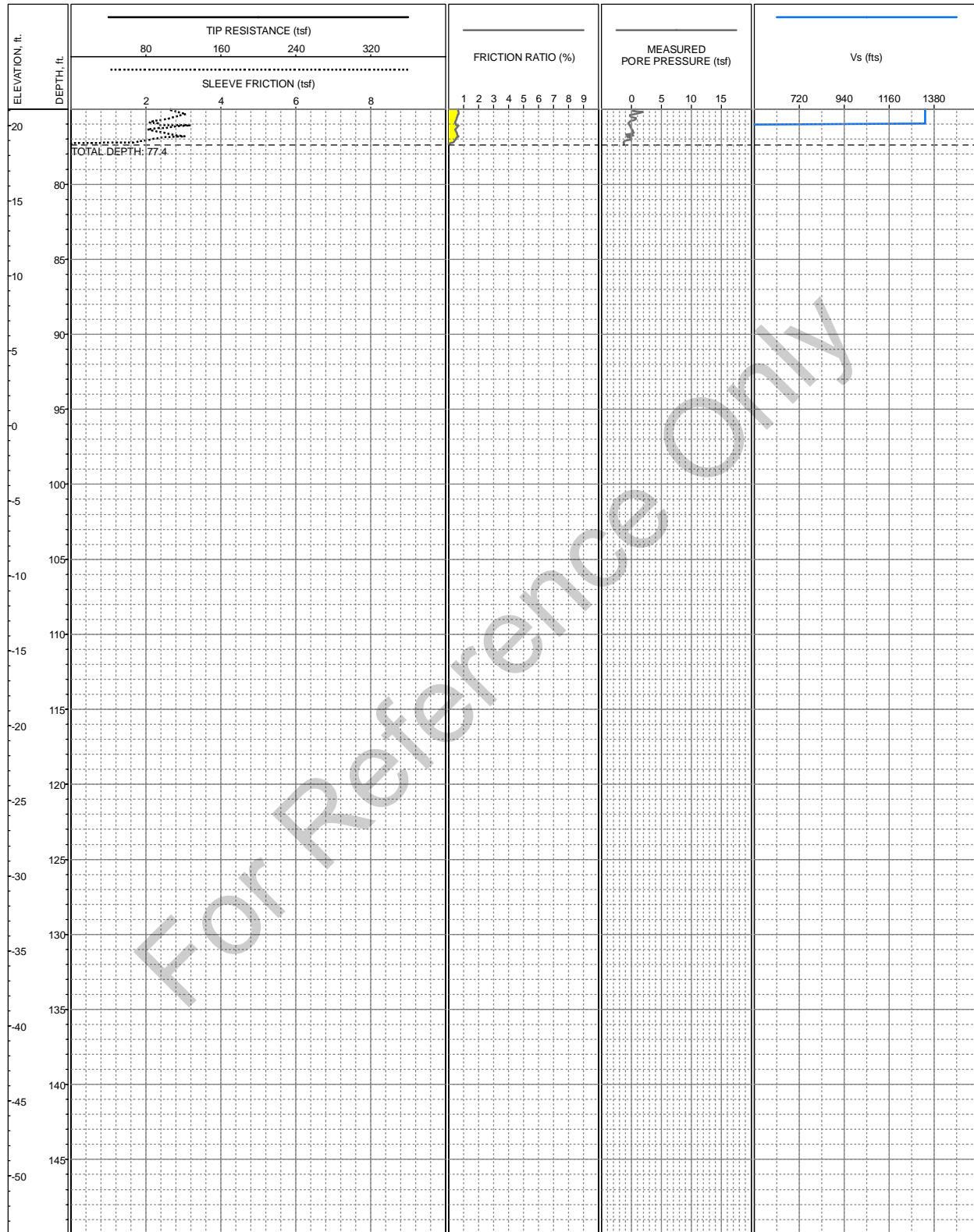

LOCATION: E6162527.2 N1950703.4 (NAD83, CA State Plane Zone III, Feet)
 SURFACE EL: 96.1ft +/- (NAVD88)
 COMPLETION DEPTH: 77.4ft
 TEST DATE: 8/16/2007

CONE: F7.5CKEGW1645
 PERFORMED BY: Fugro Consultants, Inc.
 OPERATOR: D Garza
 REVIEWED BY: M Paquette

LOG OF CPT-165
 Central Area Guideway of SVRT Project
 San Jose, California

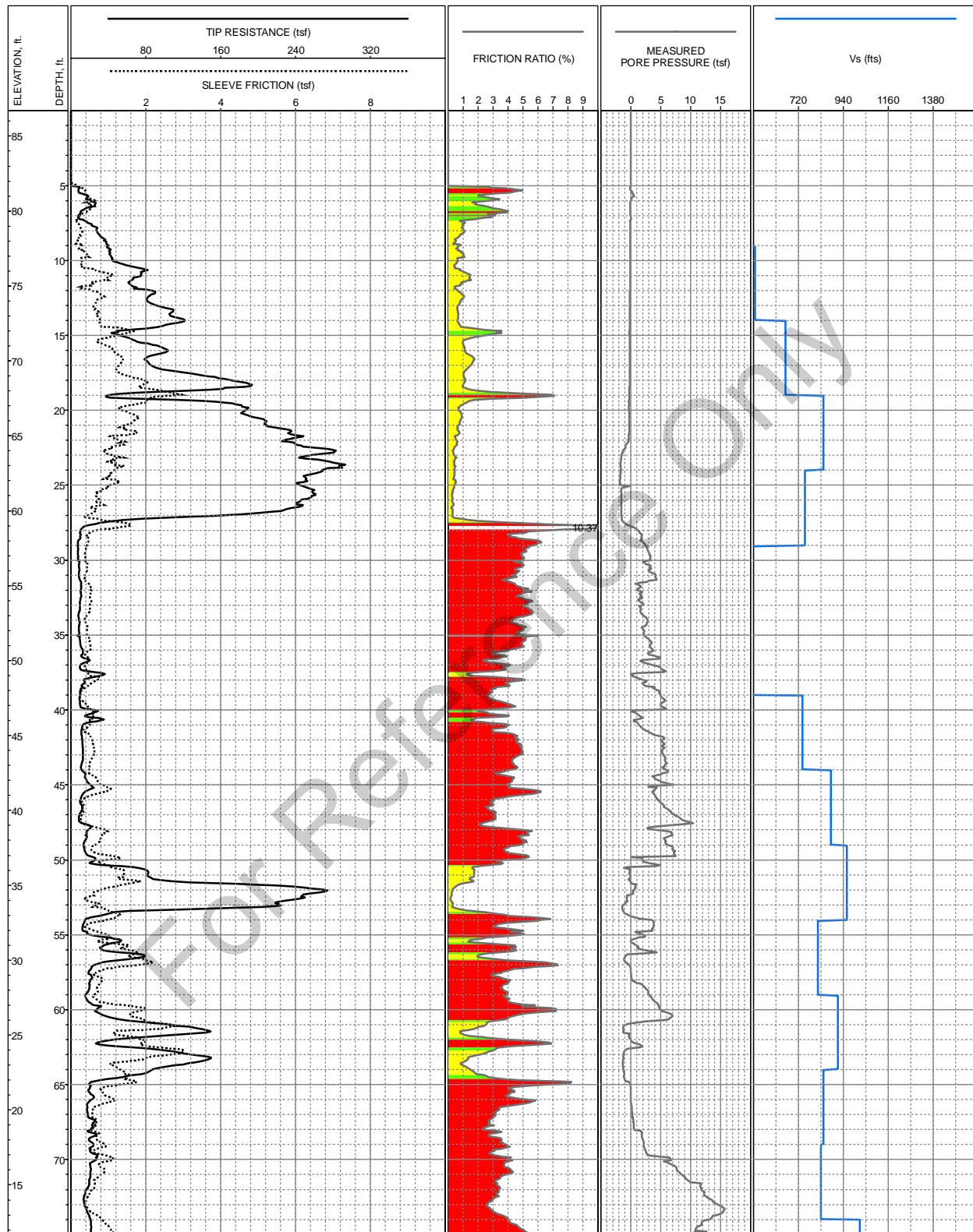

LOCATION: E6157353.8 N1947883.5 (NAD83, CA State Plane Zone III, Feet)
 SURFACE EL: 86.7ft +/- (NAVD88)
 COMPLETION DEPTH: 90.7ft
 TEST DATE: 4/1/2007

CONE: F7.5CKESW1645
 PERFORMED BY: Fugro Consultants, Inc.
 OPERATOR: D Garza & R Norris
 REVIEWED BY: M Paquette

LOG OF CPT-167
 Central Area Guideway of SVRT Project
 San Jose, California

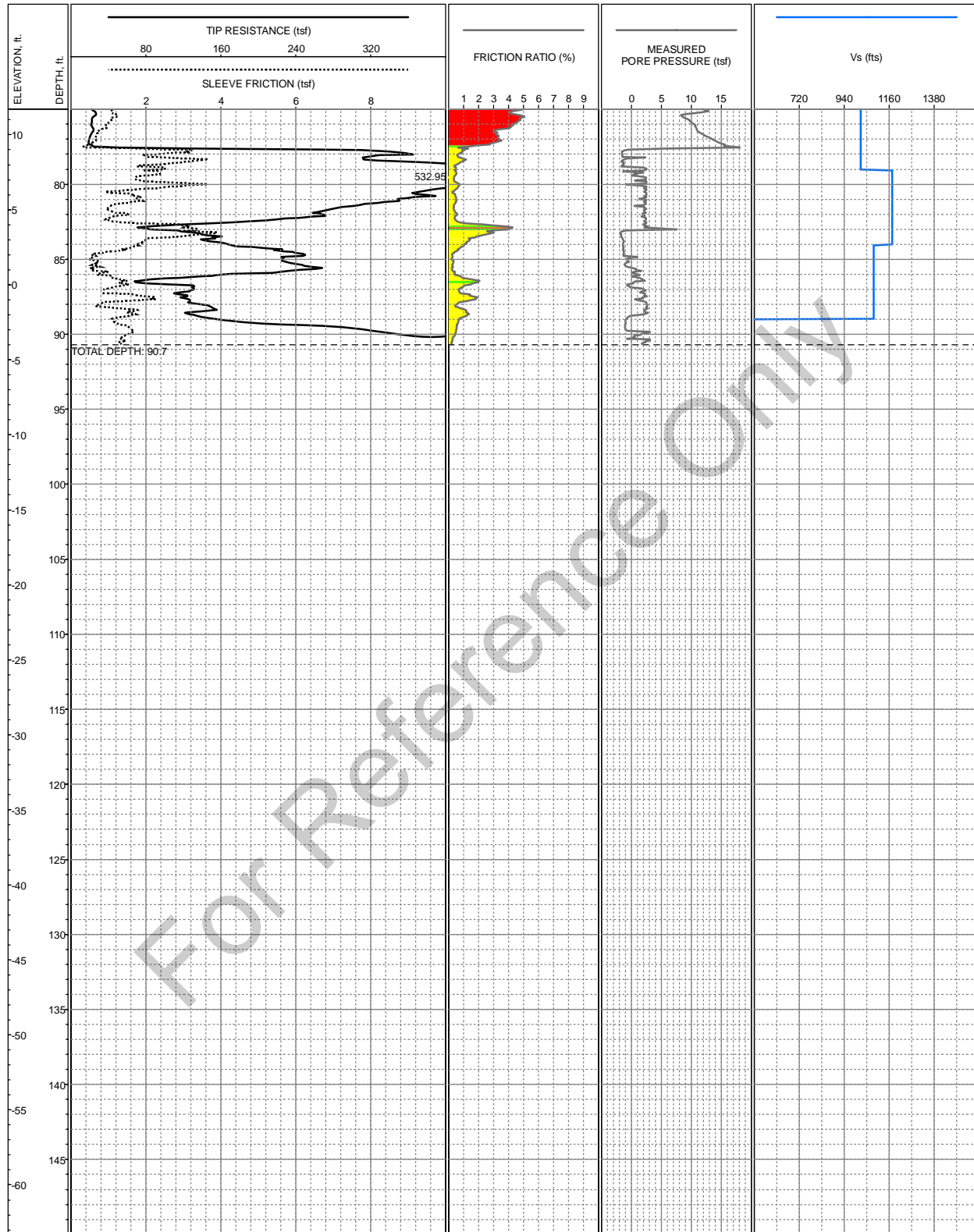

LOCATION: E6157353.8 N1947883.5 (NAD83, CA State Plane Zone III, Feet)
 SURFACE EL: 86.7ft +/- (NAVD88)
 COMPLETION DEPTH: 90.7ft
 TEST DATE: 4/1/2007

CONE: F7.5CKESW1645
 PERFORMED BY: Fugro Consultants, Inc.
 OPERATOR: D Garza & R Norris
 REVIEWED BY: M Paquette

LOG OF CPT-167
 Central Area Guideway of SVRT Project
 San Jose, California

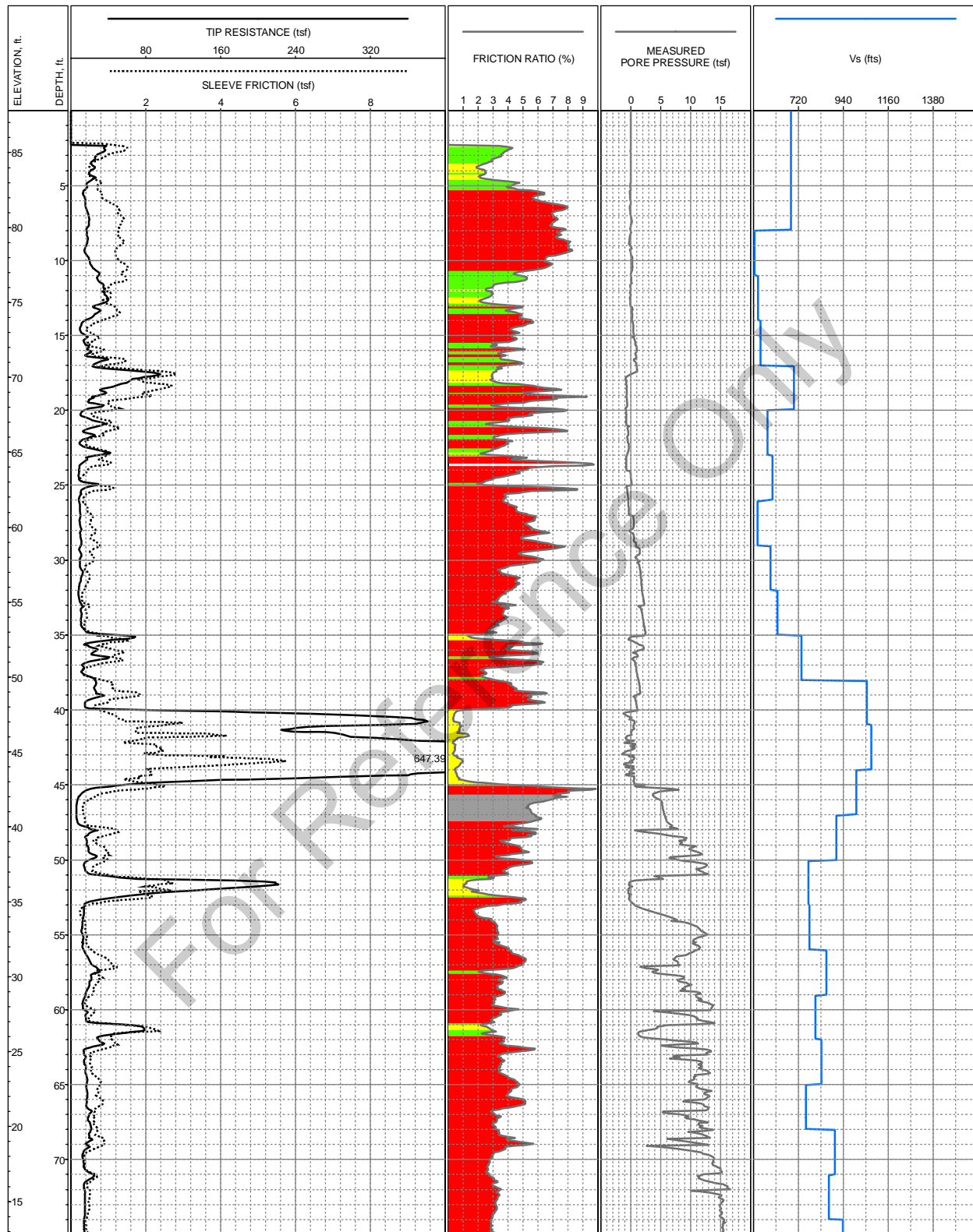

LOCATION: E6154586 N1946016.7 (NAD83, CA State Plane Zone III, Feet)
 SURFACE EL: 87.8ft +/- (NAVD88)
 COMPLETION DEPTH: 149.9ft
 TEST DATE: 4/5/2007

CONE: F7.5CKESW1645
 PERFORMED BY: Fugro Consultants, Inc.
 OPERATOR: D Garza & R Norris
 REVIEWED BY: M Paquette

LOG OF CPT-168
 Central Area Guideway of SVRT Project
 San Jose, California

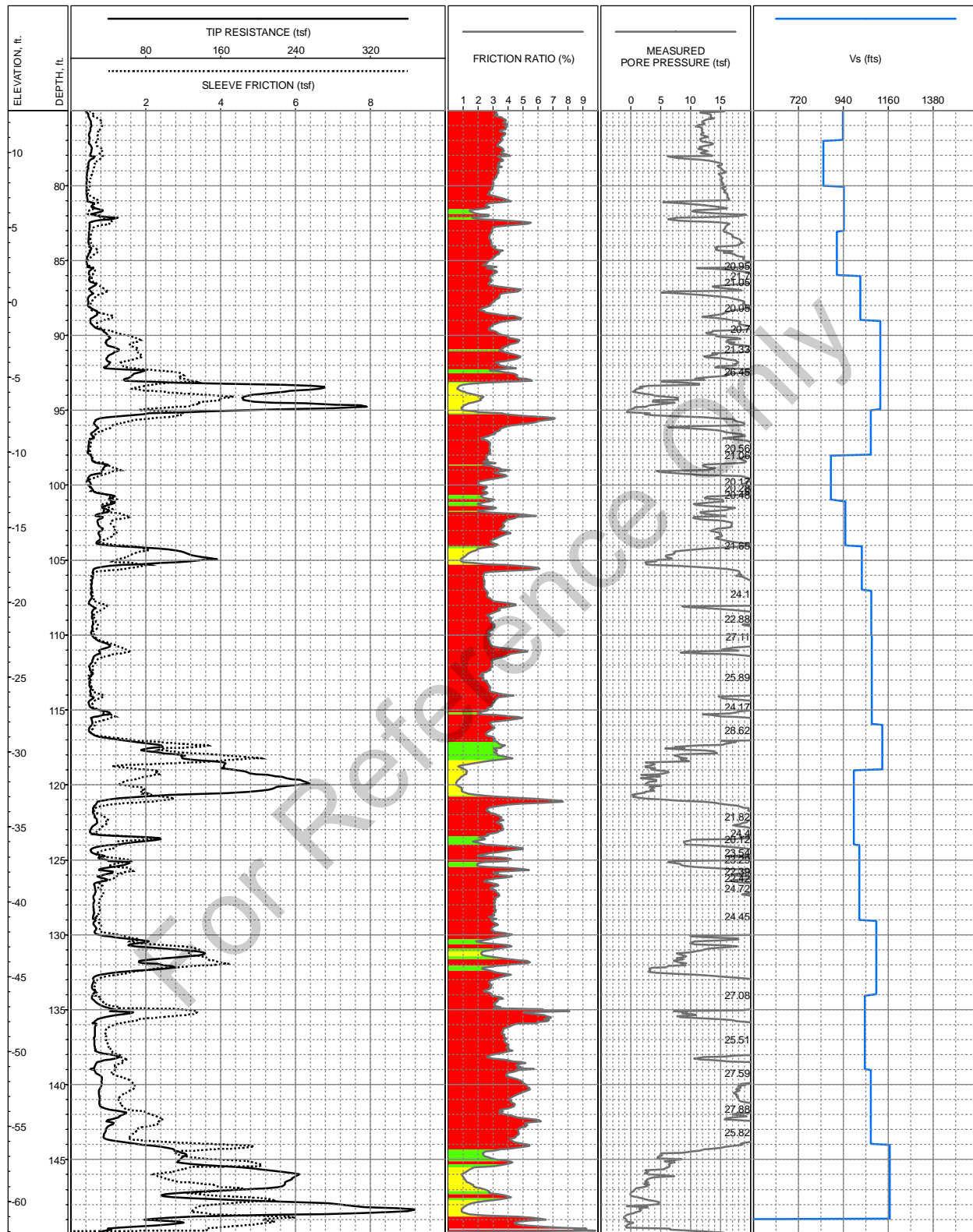

TOTAL DEPTH: 149.9
 LOCATION: E6154586 N1946016.7 (NAD83, CA State Plane Zone III, Feet)
 SURFACE EL: 87.8ft +/- (NAVD88)
 COMPLETION DEPTH: 149.9ft
 TEST DATE: 4/5/2007

CONE: F7.5CKESW1645
 PERFORMED BY: Fugro Consultants, Inc.
 OPERATOR: D Garza & R Norris
 REVIEWED BY: M Paquette

LOG OF CPT-168
 Central Area Guideway of SVRT Project
 San Jose, California

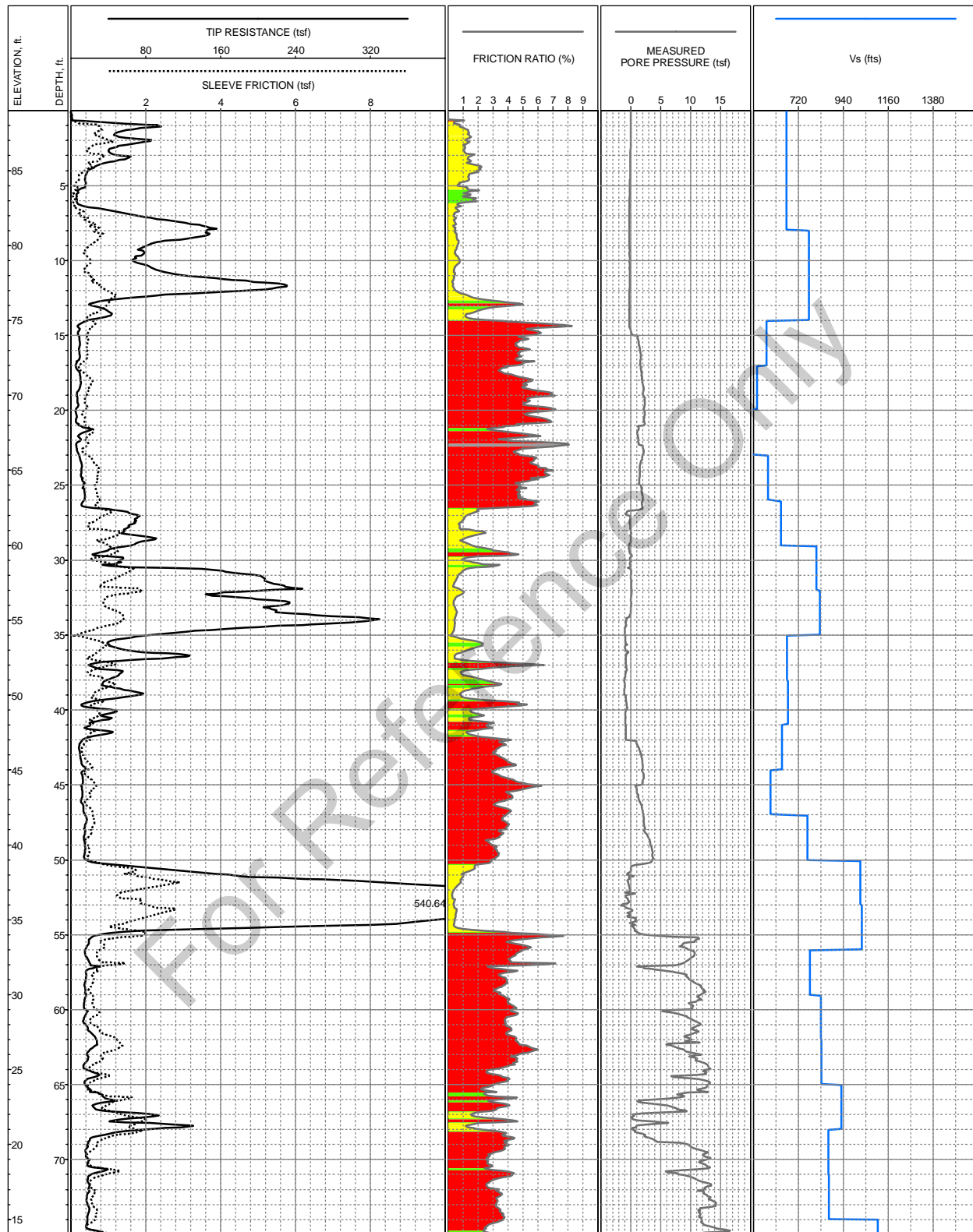

LOCATION: E6156936.7 N1947464 (NAD83, CA State Plane Zone III, Feet)
 SURFACE EL: 89ft +/- (NAVD88)
 COMPLETION DEPTH: 85.4ft
 TEST DATE: 8/17/2007

CONE: F7.5CKEGW1645
 PERFORMED BY: Fugro Consultants, Inc.
 OPERATOR: D Garza
 REVIEWED BY: M Paquette

LOG OF CPT-169
 Central Area Guideway of SVRT Project
 San Jose, California

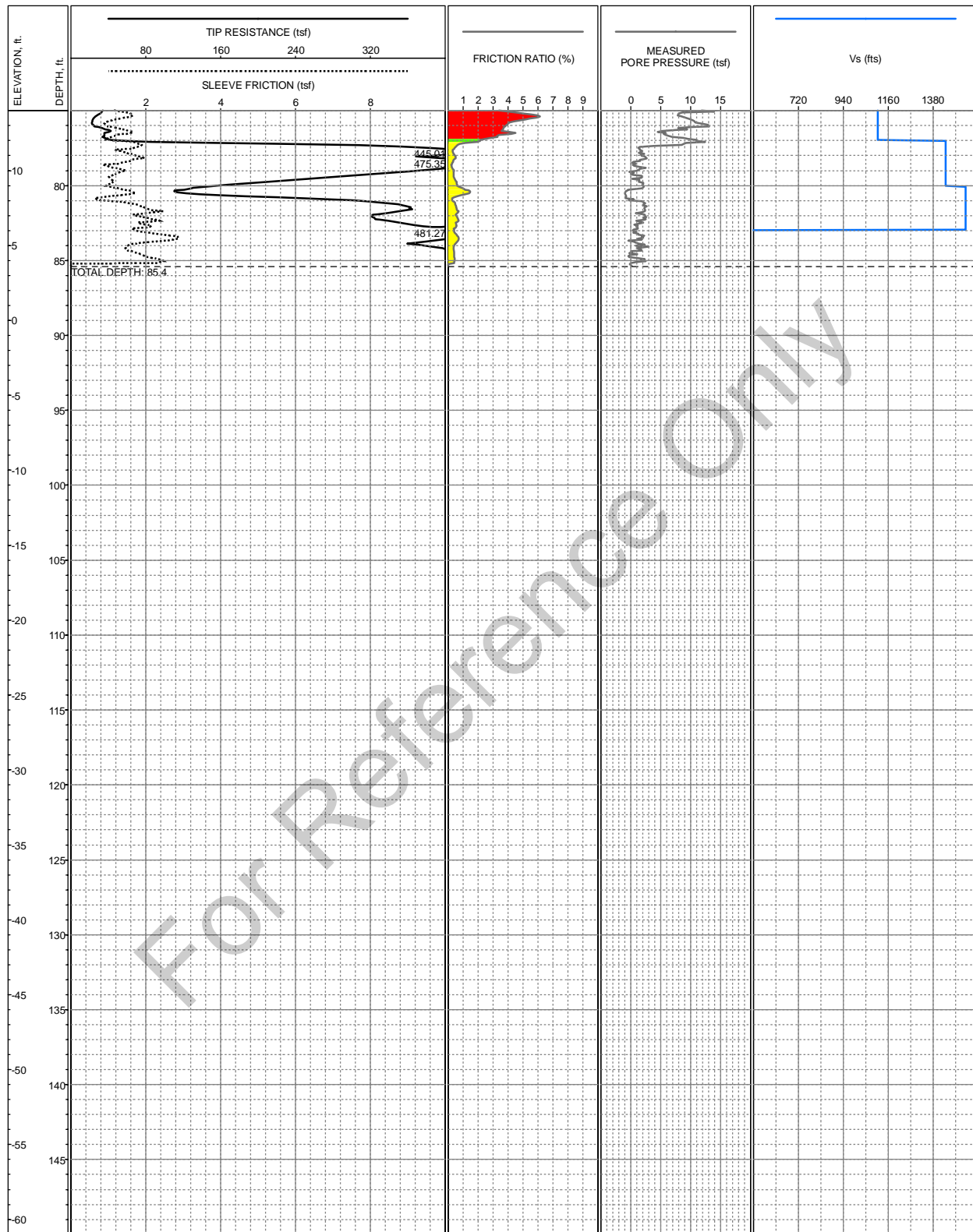

LOCATION: E6156936.7 N1947464 (NAD83, CA State Plane Zone III, Feet)
 SURFACE EL: 89ft +/- (NAVD88)
 COMPLETION DEPTH: 85.4ft
 TEST DATE: 8/17/2007

CONE: F7.5CKEGW1645
 PERFORMED BY: Fugro Consultants, Inc.
 OPERATOR: D Garza
 REVIEWED BY: M Paquette

LOG OF CPT-169
 Central Area Guideway of SVRT Project
 San Jose, California

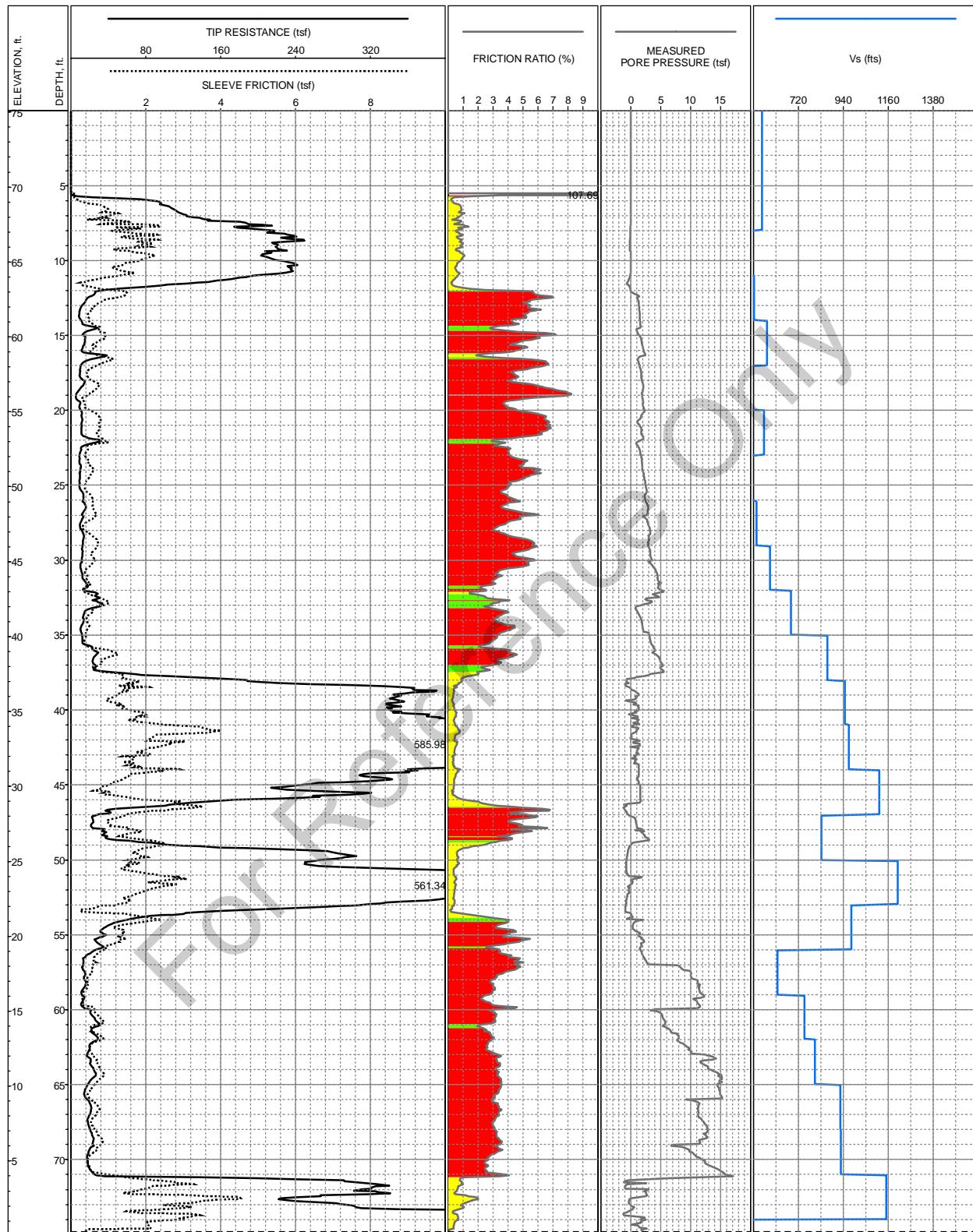

TOTAL DEPTH: 74.8
 LOCATION: E6150804.4 N1949684.3 (NAD83, CA State Plane Zone III, Feet)
 SURFACE EL: 75.1ft +/- (NAVD88)
 COMPLETION DEPTH: 74.8ft
 TEST DATE: 3/30/2007

CONE: F7.5CKESW1645
 PERFORMED BY: Fugro Consultants, Inc.
 OPERATOR: D Garza & R Norris
 REVIEWED BY: M Paquette

LOG OF CPT-171
 Central Area Guideway of SVRT Project
 San Jose, California

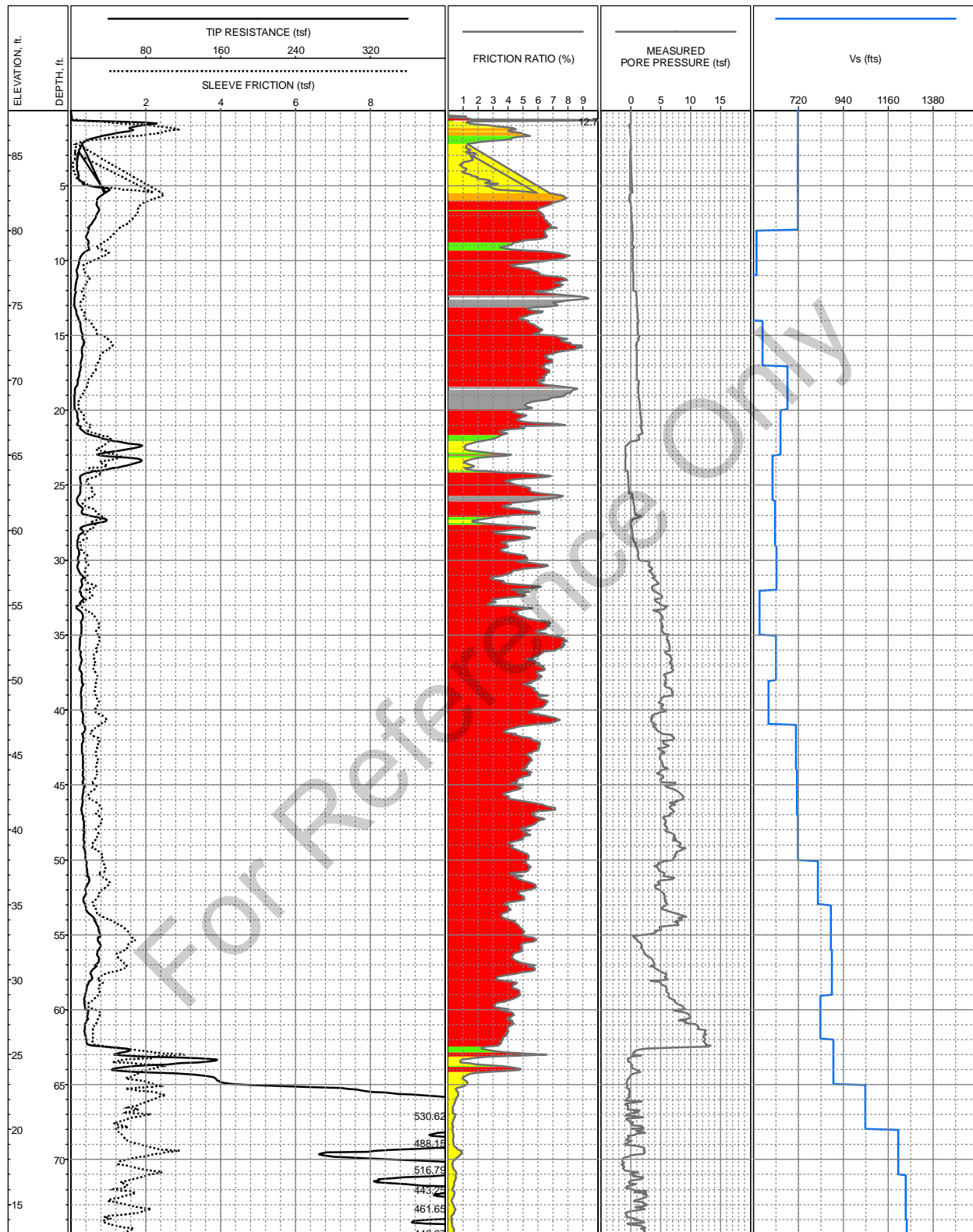

LOCATION: E6164740.58 N1953023.9 (NAD83, CA State Plane Zone III, Feet)
 SURFACE EL: 88ft +/- (NAVD88)
 COMPLETION DEPTH: 113.4ft
 TEST DATE: 8/16/2007

CONE: F7.5CKEGW1645
 PERFORMED BY: Fugro Consultants, Inc.
 OPERATOR: D Garza
 REVIEWED BY: M Paquette

LOG OF CPT-172
 Central Area Guideway of SVRT Project
 San Jose, California

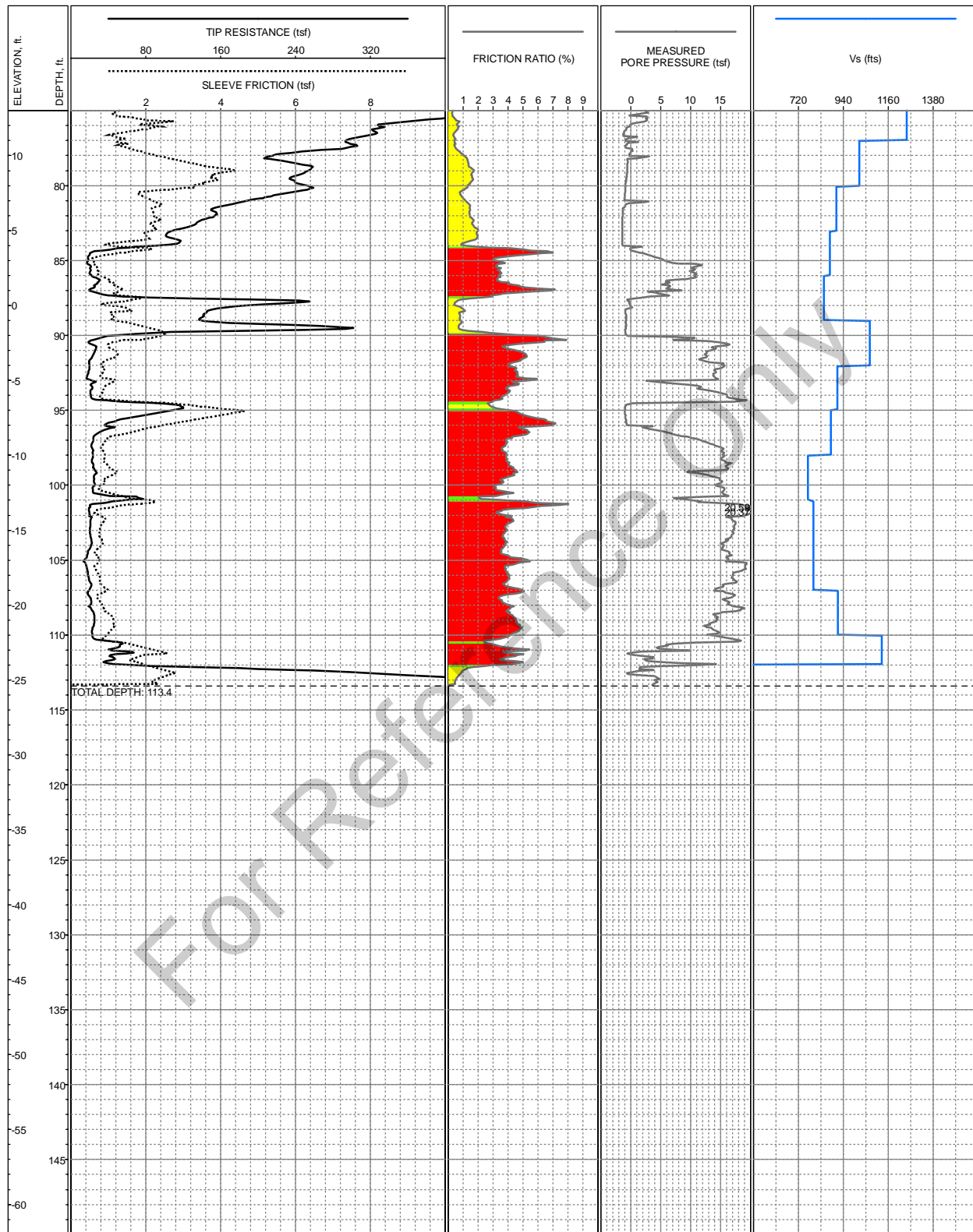

LOCATION: E6164740.58 N1953023.9 (NAD83, CA State Plane Zone III, Feet)
 SURFACE EL: 88ft +/- (NAVD88)
 COMPLETION DEPTH: 113.4ft
 TEST DATE: 8/16/2007

CONE: F7.5CKEGW1645
 PERFORMED BY: Fugro Consultants, Inc.
 OPERATOR: D Garza
 REVIEWED BY: M Paquette

LOG OF CPT-172
 Central Area Guideway of SVRT Project
 San Jose, California

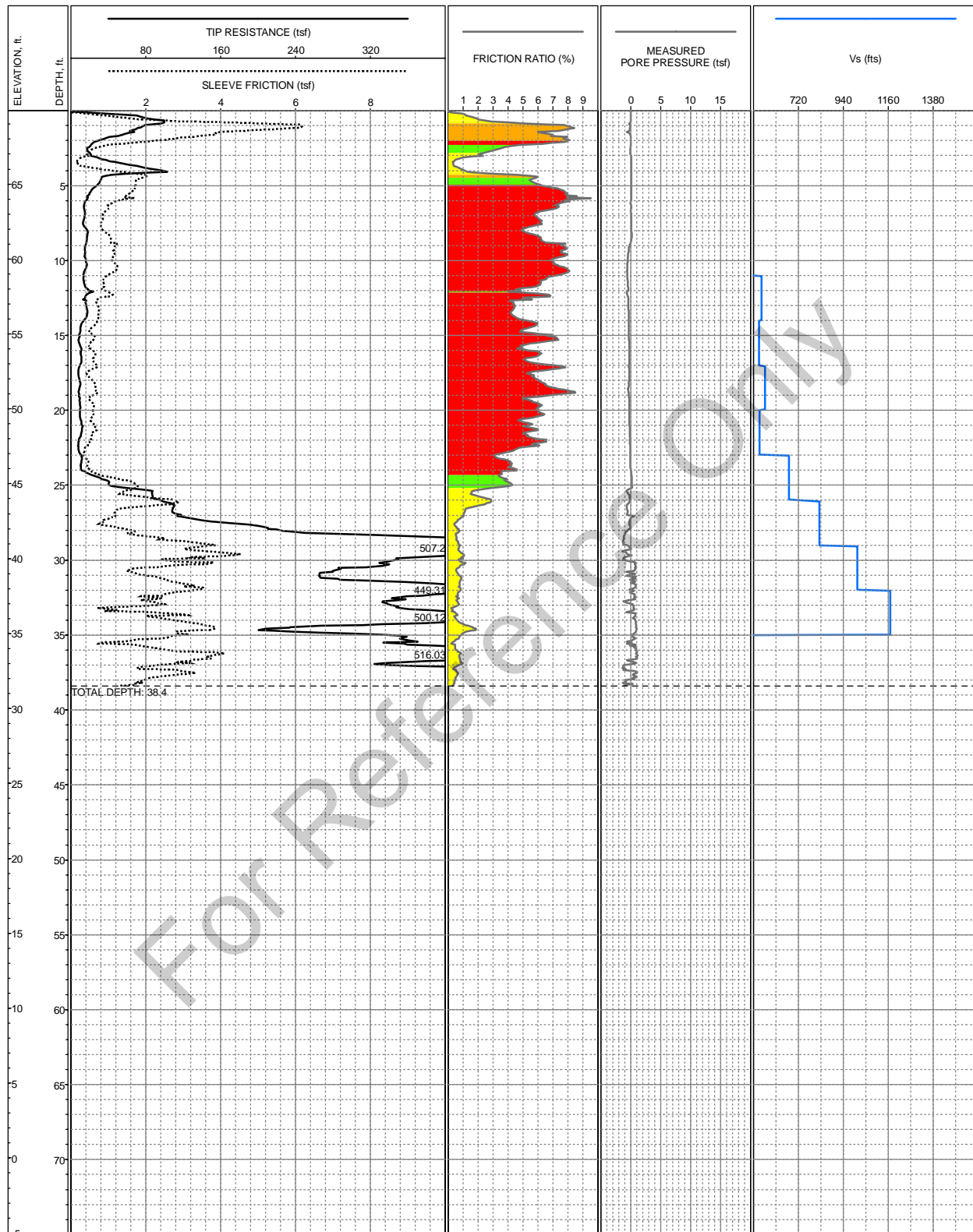

LOCATION: E6148281.4 N1951764.6 (NAD83, CA State Plane Zone III, Feet)
 SURFACE EL: 69.9ft +/- (NAVD88)
 COMPLETION DEPTH: 38.4ft
 TEST DATE: 3/29/2007

CONE: F7.5CKESW1645
 PERFORMED BY: Fugro Consultants, Inc.
 OPERATOR: D Garza & R Norris
 REVIEWED BY: M Paquette

LOG OF CPT-173
 Central Area Guideway of SVRT Project
 San Jose, California

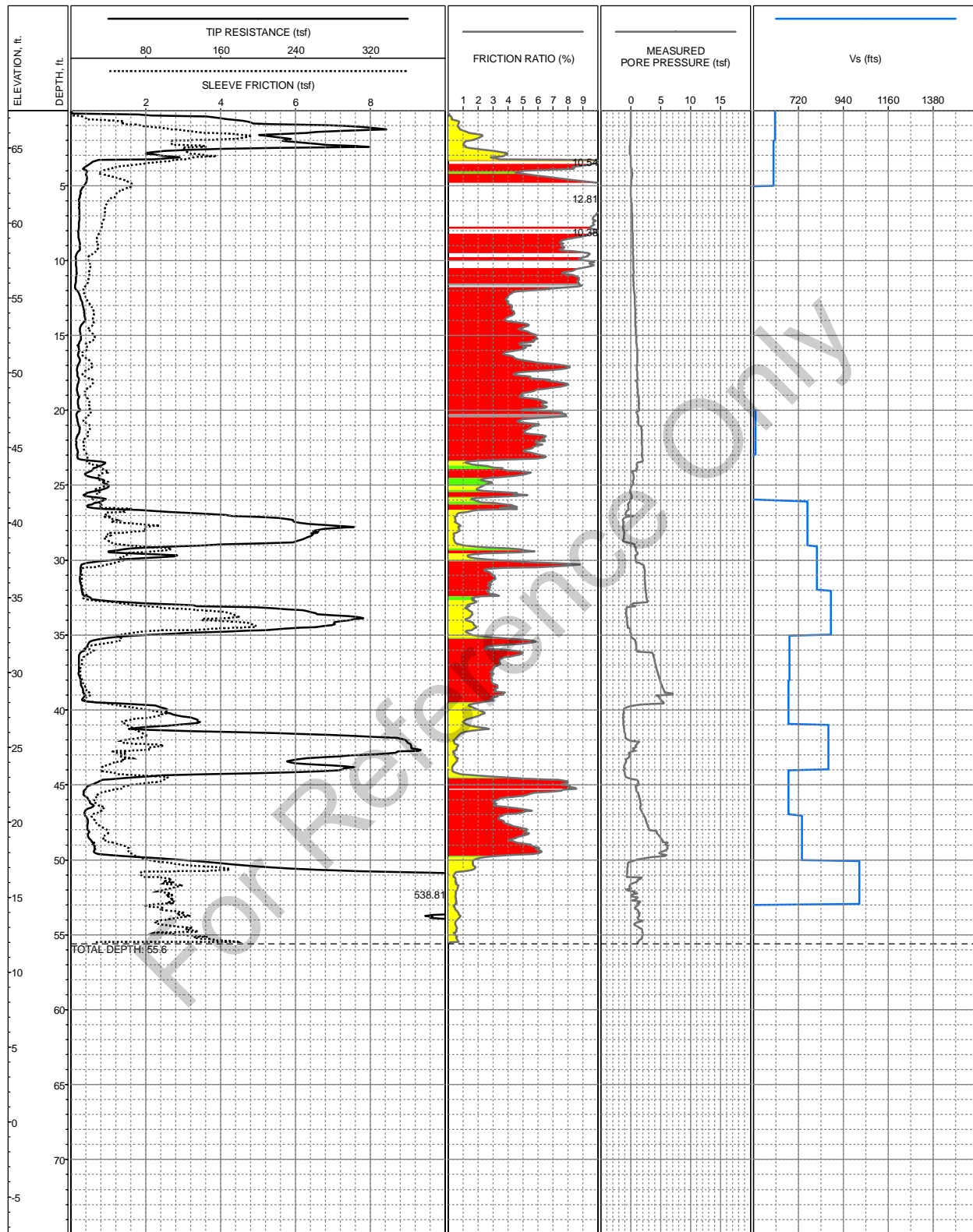

LOCATION: E6147771.2 N1952159.6 (NAD83, CA State Plane Zone III, Feet)
 SURFACE EL: 67.5ft +/- (NAVD88)
 COMPLETION DEPTH: 55.6ft
 TEST DATE: 3/31/2007

CONE: F7.5CKESW1645
 PERFORMED BY: Fugro Consultants, Inc.
 OPERATOR: D Garza & R Norris
 REVIEWED BY: M Paquette

LOG OF CPT-174
 Central Area Guideway of SVRT Project
 San Jose, California

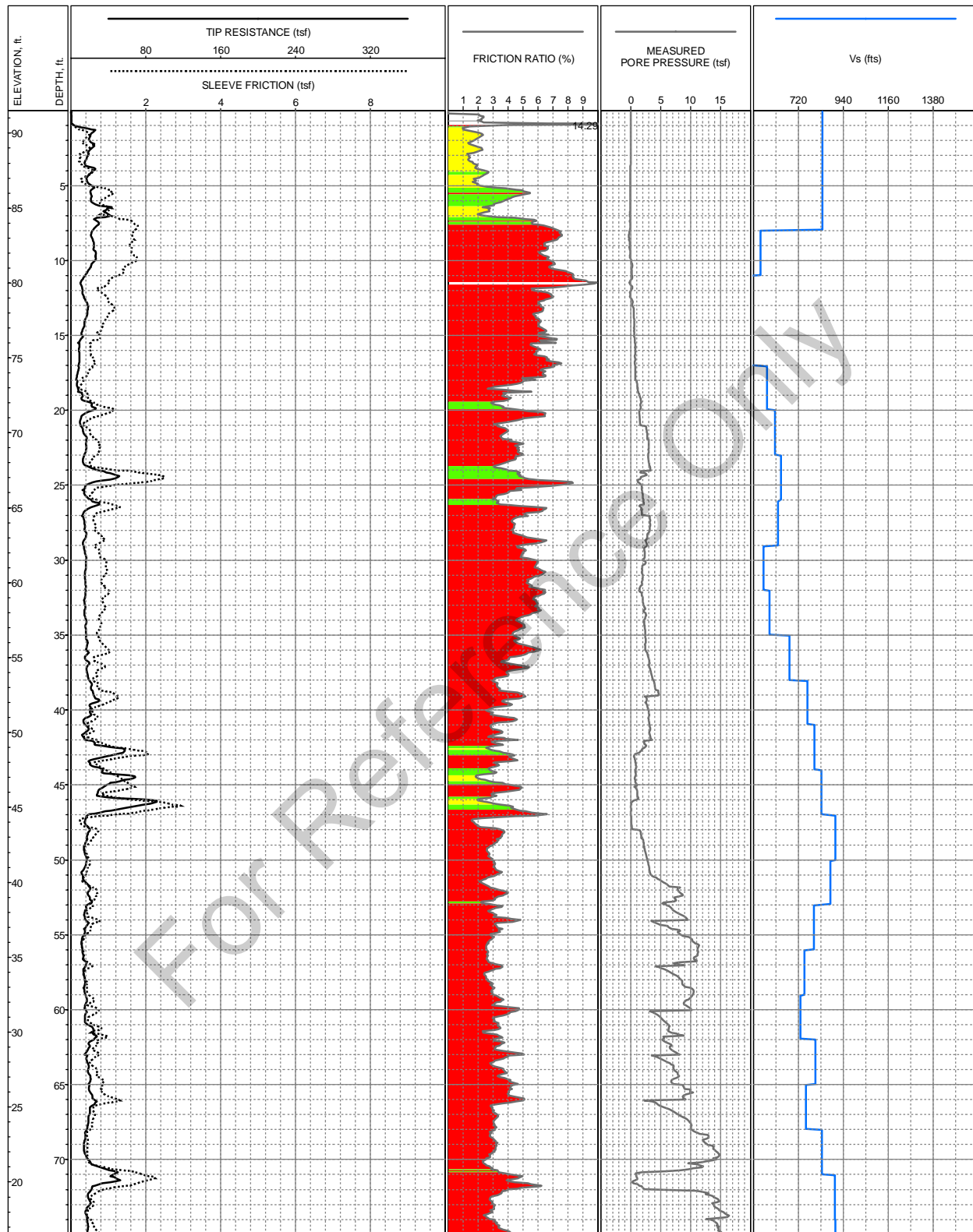

LOCATION: E6153986.9 N1945918.4 (NAD83, CA State Plane Zone III, Feet)
 SURFACE EL: 91.5ft +/- (NAVD88)
 COMPLETION DEPTH: 115.5ft
 TEST DATE: 8/14/2007

CONE: F7.5CKEGW1645
 PERFORMED BY: Fugro Consultants, Inc.
 OPERATOR: D Garza
 REVIEWED BY: M Paquette

LOG OF CPT-179
 Central Area Guideway of SVRT Project
 San Jose, California

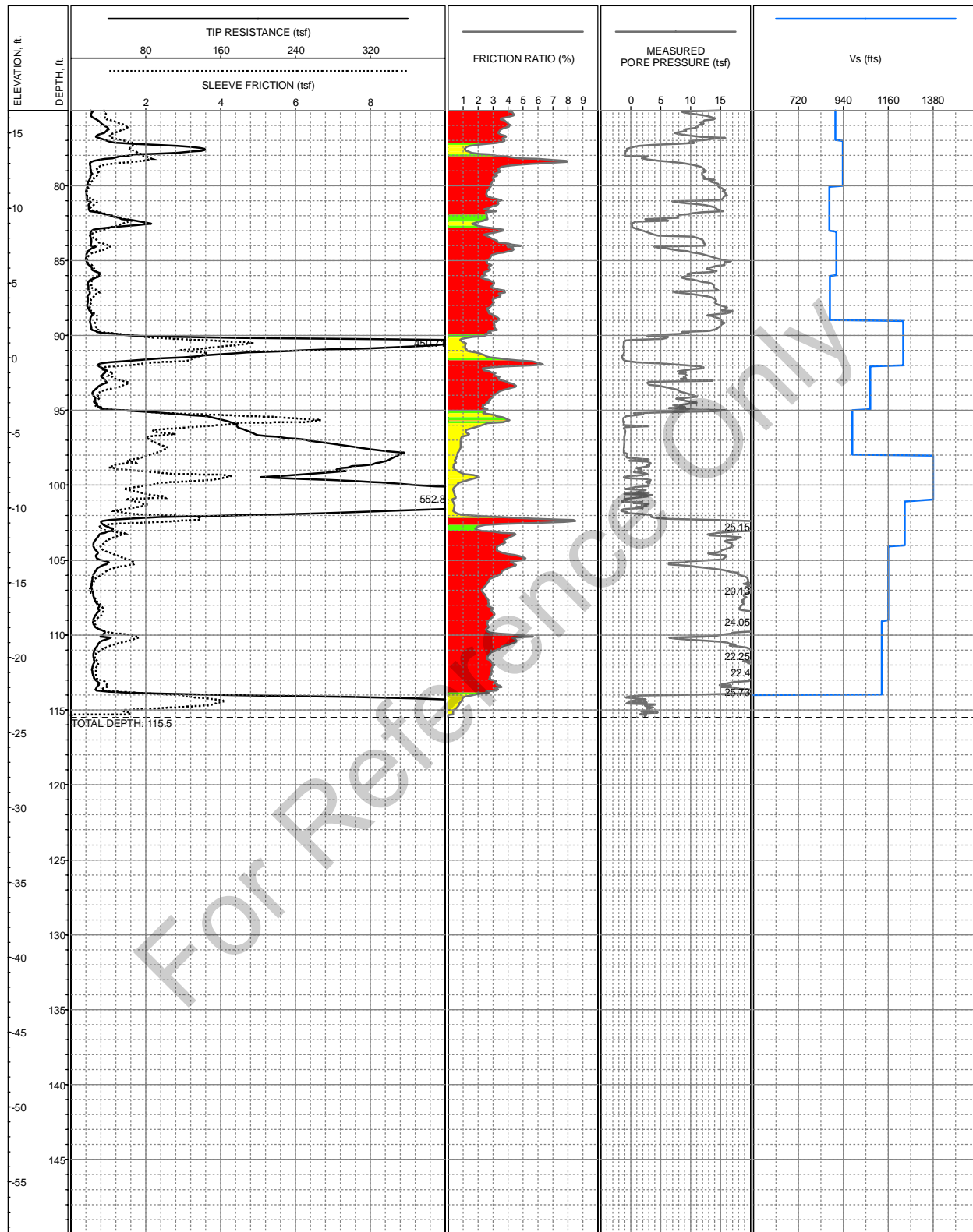

LOCATION: E6153986.9 N1945918.4 (NAD83, CA State Plane Zone III, Feet)
SURFACE EL: 91.5ft +/- (NAVD88)
COMPLETION DEPTH: 115.5ft
TEST DATE: 8/14/2007

CONE: F7.5CKEGW1645
PERFORMED BY: Fugro Consultants, Inc.
OPERATOR: D Garza
REVIEWED BY: M Paquette

LOG OF CPT-179
Central Area Guideway of SVRT Project
San Jose, California

Appendix 4: Laboratory Classification Test Results

For Reference Only

INTRODUCTION

Parikh Consultants, Inc. (PCI), was retained to perform laboratory geotechnical tests associated with subsurface exploration for 65 % Engineering Design phase of Silicon Valley Rapid Transit (SVRT) project. They performed the exploration from June 4, 2007 through August 1, 2007. The laboratory tests were performed on samples selected by HMM/Bechtel from June through August, 2007.

PURPOSE AND SCOPE

The purpose of the laboratory tests was to obtain index geotechnical properties of the selected samples. PCI performed the following tests:

- Particle-size distribution with Hydrometer (ASTM D 422)
- Moisture/Density (ASTM D 2216)
- Atterberg Limits (ASTM D 4318)

The samples were classified according to Unified Soil Classification System (USCS) using ASTM D 2487 and ASTM D 2488. The test results were provided to HMM/Bechtel in a gINT database software format. We provided the gINT templates. The moisture/density test results are provided on the boring logs provided in Appendix 1. The Atterberg test results are presented in Figures A4-1 through A4-18. The particle-size distribution graphs are presented in Figures A4-19 through A4-38. The summary of lab test results is presented in Tables A4-1 through A4-32. The laboratory test results for borehole BH-81, which was performed near the end of 35% engineering design phase, is also included.

SVRT - PARIKH LAB TEST SUMMARY SVRT PHASE2 (01252008_WITH USCS).GPJ SVRT-BART.GDT 4/29/08

Boring No.	Sample No.	Depth (ft)	USCS**	Grain Size Analysis			Atterberg Limits			Unconfined Comp. (qu, ksf)	Lab Vane (su, ksf)	Dry Density (pcf)	Moisture Content (%)	Remarks
				gravel (%)	sand (%)	finer (%)	LL (%)	PL (%)	PI (%)					
BH-081	1	34.5	GM	48	40	12						7.0		
BH-081	2	42.5	SP											
BH-081	3	47.5	SW-SC	25	64	11						10.0		
BH-081	4	51.5												
BH-081	5	65	CL			72						22.0		
BH-081	6	70	CL											
BH-081	7	74	SC											
BH-081	8	80	ML			72					110.4	20.0		
BH-081	9	84.5	CL			70								
BH-081	10	89	CL											
BH-081	11	95												
BH-081	12	99	CL			82						25.0		
BH-081	13	104	SW											
BH-081	14	109	CL											
BH-081	15	113.5	CL											
BH-081	16	118	SP	34	63	3								
BH-081	17	125.5	ML/SM			45						16.0		
BH-081	18	130.5	SP			69						20.0		
BH-081	19	136.5	CL											
BH-081	20	141.5	CL			98						33.2		
BH-081	21	146.5	CL											
BH-081	22	150.5	SC											

SUMMARY OF LABORATORY TEST RESULTS

SILICON VALLEY RAPID TRANSIT (SVRT) PROJECT
CENTRAL AREA GUIDEWAY
SAN JOSE, CALIFORNIA

Notes:

**USCS - Symbol of Unified Soil Classification System per visual-manual procedures in accordance with ASTM D 2488 or classification based on laboratory test results in accordance with ASTM D 2487 when laboratory data is available.



PARIKH CONSULTANTS, INC.
Geotechnical & Materials Engineering

Date: 4/29/2008

Job No.: 204104.10

TABLE A4-1

See disclaimer on cover page.

SVRT - PARIKH LAB TEST SUMMARY SVRT PHASE2 (01252008_WITH USCS).GPJ SVRT-BART.GDT 4/29/08

Boring No.	Sample No.	Depth (ft)	USCS**	Grain Size Analysis			Atterberg Limits			Unconfined Comp. (qu, ksf)	Lab Vane (su, ksf)	Dry Density (pcf)	Moisture Content (%)	Remarks
				gravel (%)	sand (%)	finer (%)	LL (%)	PL (%)	PI (%)					
BH-082	1	3.5	ML											
BH-082	2	7.5	CL											
BH-082	3	12.5	CL											
BH-082	4	17.5	CL											
BH-082	5	22.5	CL	0	2	98	42	24	18		96.2	27.8		
BH-082	6	27.5	CL											
BH-082	7	32.5	CL									26.6		
BH-082	8	37.5	CL											
BH-082	9	42.5	CL	1	27	72	35	17	18			25.7		
BH-082	10	46.5	CL-ML											
BH-082	11	51.5	ML									23.6		
BH-082	12	56.5	ML											
BH-082	13	61.5	CL-ML											
BH-082	14	67.5	ML	0	4	96	38	29	9		94.3	26.9		
BH-082	15	72.5	CL											
BH-082	16	82.5	SM											
BH-082	17	92.5	CL								110.1	20.6		

SUMMARY OF LABORATORY TEST RESULTS
SILICON VALLEY RAPID TRANSIT (SVRT) PROJECT
CENTRAL AREA GUIDEWAY
SAN JOSE, CALIFORNIA

Notes:
**USCS - Symbol of Unified Soil Classification System per visual-manual procedures in accordance with ASTM D 2488 or classification based on laboratory test results in accordance with ASTM D 2487 when laboratory data is available.



PARIKH CONSULTANTS, INC.
Geotechnical & Materials Engineering

Date: 4/29/2008

Job No.: 204104.10

TABLE A4-2

See disclaimer on cover page.

SVRT - PARIKH LAB TEST SUMMARY SVRT PHASE2 (01252008_WITH USCS).GPJ SVRT-BART.GDT 4/29/08

Boring No.	Sample No.	Depth (ft)	USCS**	Grain Size Analysis			Atterberg Limits			Unconfined Comp. (qu, ksf)	Lab Vane (su, ksf)	Dry Density (pcf)	Moisture Content (%)	Remarks
				gravel (%)	sand (%)	finer (%)	LL (%)	PL (%)	PI (%)					
BH-084	1	3.5	SM											
BH-084	2	12.5	CL											
BH-084	3	21.5	SM											
BH-084	4	32.5	CL											
BH-084	5	42.5	CH				58	27	31		89.9	33.0		
BH-084	6	52.5	CL											
BH-084	7	62.5	CL											
BH-084	8	71.5	CL											
BH-084	9	82.5	SW-SC	42	48	10						15.5		
BH-084	10	92.5	SW-SC											
BH-084	11	101.5	SM											
BH-084	12	111.5	SW-SM	46	48	6						8.2		
BH-084	13	122.5	CL											
BH-084	14	131.5	CL/SC	0	44	56						21.3		
BH-084	15	141	SW-SM	4	84	12						15.5		
BH-084	16	152.5	CL											
BH-084	17	157.5	CL				29	17	12		111.7	18.8		
BH-084	18	162.5	CL											
BH-084	19	167.5	CL/CH				49	27	22			28.9		
BH-084	20	172.5	CL											
BH-084	21	177.5	CL/ML				36	24	12		100.8	25.6		
BH-084	22	182.5	CL											
BH-084	23	187.5	CL											
BH-084	24	192.5	CL				30	18	12			20.7		
BH-084	25	197.5	CL											

SUMMARY OF LABORATORY TEST RESULTS
 SILICON VALLEY RAPID TRANSIT (SVRT) PROJECT
 CENTRAL AREA GUIDEWAY
 SAN JOSE, CALIFORNIA



PARIKH CONSULTANTS, INC.
 Geotechnical & Materials Engineering

Notes:

**USCS - Symbol of Unified Soil Classification System per visual-manual procedures in accordance with ASTM D 2488 or classification based on laboratory test results in accordance with ASTM D 2487 when laboratory data is available.

Date: 4/29/2008

Job No.: 204104.10

TABLE A4-3

See disclaimer on cover page.

Boring No.	Sample No.	Depth (ft)	USCS**	Grain Size Analysis			Atterberg Limits			Unconfined Comp. (qu, ksf)	Lab Vane (su, ksf)	Dry Density (pcf)	Moisture Content (%)	Remarks
				gravel (%)	sand (%)	finer (%)	LL (%)	PL (%)	PI (%)					
BH-084	26	201.5	CH											
BH-084	27	207.5	CH				57	25	32			21.6		
For Reference Only														
<p style="text-align: center;">SUMMARY OF LABORATORY TEST RESULTS SILICON VALLEY RAPID TRANSIT (SVRT) PROJECT CENTRAL AREA GUIDEWAY SAN JOSE, CALIFORNIA</p>										Notes: **USCS - Symbol of Unified Soil Classification System per visual-manual procedures in accordance with ASTM D 2488 or classification based on laboratory test results in accordance with ASTM D 2487 when laboratory data is available.				
 <p>PARIKH CONSULTANTS, INC. Geotechnical & Materials Engineering</p>										Date: 4/29/2008		Job No.: 204104.10		

TABLE A4-4

SVRT - PARIKH LAB TEST SUMMARY SVRT PHASE2 (01252008_WITH USCS).GPJ SVRT-BART.GDT 4/29/08

Boring No.	Sample No.	Depth (ft)	USCS**	Grain Size Analysis			Atterberg Limits			Unconfined Comp. (qu, ksf)	Lab Vane (su, ksf)	Dry Density (pcf)	Moisture Content (%)	Remarks
				gravel (%)	sand (%)	finer (%)	LL (%)	PL (%)	PI (%)					
BH-085	1	3.5	GP-GC											
BH-085	2	12.5	CL											
BH-085	3	22.5	CL											
BH-085	4	32.5	CL											
BH-085	5	42.5	CH											
BH-085	6	52.5	CL				43	19	24		103.2	23.5		
BH-085	7	62.5	CL											
BH-085	8	66.5	CL											
BH-085	9	71.5	CL											
BH-085	10	76.5	CL											
BH-085	11	81.5	CL											
BH-085	12	86.5	SW-SC	43	49	8						9.5		
BH-085	13	92.5	CL											
BH-085	14	102.5	ML	0	41	59	NP	NP	NP		104.3	20.3		
BH-085	15	111.5	GM											
BH-085	16	121.5	SP-SC	24	68	8						11.0		
BH-085	17	131.5	CL											
BH-085	18	141.5	CL											
BH-085	19	151.5	CL				29	20	9			23.1		
BH-085	20	155.8	CL											
BH-085	21	161	CL											
BH-085	22	167.5	CH				53	27	26		99.4	26.3		
BH-085	23	172.5	CL											
BH-085	24	177.5	CL											
BH-085	25	182.5	CL											

SUMMARY OF LABORATORY TEST RESULTS
 SILICON VALLEY RAPID TRANSIT (SVRT) PROJECT
 CENTRAL AREA GUIDEWAY
 SAN JOSE, CALIFORNIA



PARIKH CONSULTANTS, INC.
 Geotechnical & Materials Engineering

Notes:

**USCS - Symbol of Unified Soil Classification System per visual-manual procedures in accordance with ASTM D 2488 or classification based on laboratory test results in accordance with ASTM D 2487 when laboratory data is available.

Date: 4/29/2008

Job No.: 204104.10

TABLE A4-5

See disclaimer on cover page.

Boring No.	Sample No.	Depth (ft)	USCS**	Grain Size Analysis			Atterberg Limits			Unconfined Comp. (qu, ksf)	Lab Vane (su, ksf)	Dry Density (pcf)	Moisture Content (%)	Remarks
				gravel (%)	sand (%)	finer (%)	LL (%)	PL (%)	PI (%)					
BH-085	26	187.5	CH											
BH-085	27	192.5	CL	0	40	60	27	18	9		112.8	17.2		
BH-085	28	197.5	CH											
BH-085	29	202.5	CL											

SUMMARY OF LABORATORY TEST RESULTS
 SILICON VALLEY RAPID TRANSIT (SVRT) PROJECT
 CENTRAL AREA GUIDEWAY
 SAN JOSE, CALIFORNIA



PARIKH CONSULTANTS, INC.
Geotechnical & Materials Engineering

Notes:
 **USCS - Symbol of Unified Soil Classification System per visual-manual procedures in accordance with ASTM D 2488 or classification based on laboratory test results in accordance with ASTM D 2487 when laboratory data is available.

Date: 4/29/2008

Job No.: 204104.10

TABLE A4-6

See disclaimer on cover page.

SVRT - PARIKH LAB TEST SUMMARY SVRT PHASE2 (01252008_WITH USCS).GPJ SVRT-BART.GDT 4/29/08

Boring No.	Sample No.	Depth (ft)	USCS**	Grain Size Analysis			Atterberg Limits			Unconfined Comp. (qu, ksf)	Lab Vane (su, ksf)	Dry Density (pcf)	Moisture Content (%)	Remarks
				gravel (%)	sand (%)	finer (%)	LL (%)	PL (%)	PI (%)					
BH-087	1	4.5	CL											
BH-087	2	12.5	SM											
BH-087	3	22.5	CL											
BH-087	4	32.5	SM											
BH-087	5	37.5	CL											
BH-087	6	42.5	ML											
BH-087	7	47.5	CL											
BH-087	8	52.5	CL				46	24	22			29.0		
BH-087	9	57.5	CL											
BH-087	10	62.5	CL				46	24	22			28.3		
BH-087	11	67.5	CL											
BH-087	12	71.5	GW	69	27	4						8.3		
BH-087	13	74	SC											
BH-087	14	76.5	SM											
BH-087	15	79	GP-GC	65	28	7						10.8		
BH-087	16	81.5	CL											
BH-087	17	84	ML											
BH-087	18	86.5	SP-SM	3	89	8						13.7		
BH-087	19	89	SM											
BH-087	20	91.5	SM											
BH-087	21	96	GP-GC											
BH-087	22	101.5	SM											
BH-087	23	107.5	CL											
BH-087	24	112.5	CL											
BH-087	25	117.5	SM											

SUMMARY OF LABORATORY TEST RESULTS
 SILICON VALLEY RAPID TRANSIT (SVRT) PROJECT
 CENTRAL AREA GUIDEWAY
 SAN JOSE, CALIFORNIA



PARIKH CONSULTANTS, INC.
Geotechnical & Materials Engineering

Notes:
 **USCS - Symbol of Unified Soil Classification System per visual-manual procedures in accordance with ASTM D 2488 or classification based on laboratory test results in accordance with ASTM D 2487 when laboratory data is available.

Date: 4/29/2008
Job No.: 204104.10

TABLE A4-7

See disclaimer on cover page.

SVRT - PARIKH LAB TEST SUMMARY SVRT PHASE2 (01252008_WITH USCS).GPJ SVRT-BART.GDT 4/29/08

Boring No.	Sample No.	Depth (ft)	USCS**	Grain Size Analysis			Atterberg Limits			Unconfined Comp. (qu, ksf)	Lab Vane (su, ksf)	Dry Density (pcf)	Moisture Content (%)	Remarks
				gravel (%)	sand (%)	finer (%)	LL (%)	PL (%)	PI (%)					
BH-087	26	121.5	SW-SM	43	51	6						8.3		
BH-087	27	126.5	SW-SM											
BH-087	28	132.5	CL-ML											
BH-087	29	136.25	GC	47	40	13						9.1		
BH-087	30	141.5	SM											
BH-087	31	146.5	ML											
BH-087	32	152.5	ML											
BH-087	33	157.5	SM	0	76	24					91.7	16.2		
BH-087	34	160.8	SM											
BH-087	35	166	SM											
BH-087	36	171	GP-GM											
BH-087	37	176.4	GP-GM											
BH-087	38	181	SP-SM	43	51	6						9.4		
BH-087	39	187.5	MH/CH				56	31	25			35.3		
BH-087	40	191.5	CL											
BH-087	41	201.5	CL											
SUMMARY OF LABORATORY TEST RESULTS														
SILICON VALLEY RAPID TRANSIT (SVRT) PROJECT CENTRAL AREA GUIDEWAY SAN JOSE, CALIFORNIA														
 PARIKH CONSULTANTS, INC. <i>Geotechnical & Materials Engineering</i>											Notes:			
											**USCS - Symbol of Unified Soil Classification System per visual-manual procedures in accordance with ASTM D 2488 or classification based on laboratory test results in accordance with ASTM D 2487 when laboratory data is available.			
											Date: 4/29/2008		Job No.: 204104.10	

TABLE A4-8

See disclaimer on cover page.

SVRT - PARIKH LAB TEST SUMMARY SVRT PHASE2 (01252008_WITH USCS).GPJ SVRT-BART.GDT 4/29/08

Boring No.	Sample No.	Depth (ft)	USCS**	Grain Size Analysis			Atterberg Limits			Unconfined Comp. (qu, ksf)	Lab Vane (su, ksf)	Dry Density (pcf)	Moisture Content (%)	Remarks
				gravel (%)	sand (%)	finer (%)	LL (%)	PL (%)	PI (%)					
BH-088	1	3.5	ML											
BH-088	2	7.5	ML											
BH-088	3	12	ML											
BH-088	4	16.5	SP-SM											
BH-088	5	22.5	CL											
BH-088	6	27.5	CL											
BH-088	7	34.5	ML	0	10	90	29	24	5					
BH-088	8	37	CL-ML											
BH-088	9	39	CL-ML											
BH-088	10	41	CL				34	18	16			25.4		
BH-088	11	43	CL											
BH-088	12	45	CL											
BH-088	13	47	SM											
BH-088	14	49	CL-ML											
BH-088	15	51	CL											
BH-088	16	53	CL											
BH-088	17	55	ML											
BH-088	18	57	CL											
BH-088	19	59	CL											
BH-088	20	62	CL											
BH-088	21	65	ML											
BH-088	22	68	ML	0	0	100	40	27	13					
BH-088	23	69	ML											
BH-088	24	71	GP-GM	51	38	11	NP	NP	NP					
BH-088	25	72.5	SW-SM											

SUMMARY OF LABORATORY TEST RESULTS
 SILICON VALLEY RAPID TRANSIT (SVRT) PROJECT
 CENTRAL AREA GUIDEWAY
 SAN JOSE, CALIFORNIA



PARIKH CONSULTANTS, INC.
Geotechnical & Materials Engineering

Notes:
 **USCS - Symbol of Unified Soil Classification System per visual-manual procedures in accordance with ASTM D 2488 or classification based on laboratory test results in accordance with ASTM D 2487 when laboratory data is available.

Date: 4/29/2008
Job No.: 204104.10

TABLE A4-9

See disclaimer on cover page.

SVRT - PARIKH LAB TEST SUMMARY SVRT PHASE2 (01252008_WITH USCS).GPJ SVRT-BART.GDT 4/29/08

Boring No.	Sample No.	Depth (ft)	USCS**	Grain Size Analysis			Atterberg Limits			Unconfined Comp. (qu, ksf)	Lab Vane (su, ksf)	Dry Density (pcf)	Moisture Content (%)	Remarks
				gravel (%)	sand (%)	finer (%)	LL (%)	PL (%)	PI (%)					
BH-088	26	75.5	SW-SM											
BH-088	27	78	SW-SM											
BH-088	28	80	SW-SM											
BH-088	29	81.5	SW-SM	43	50	7								
BH-088	30	83	SW-SM											
BH-088	31	84.5	GP											
BH-088	32	86.5	CL											
BH-088	33	88.5	CL											
BH-088	34	91	CL											
BH-088	35	93	GW-GM											
BH-088	36	94.5	GW-GM	51	44	5								
BH-088	37	95	SM											
BH-088	38	96.5	SM											
BH-088	39	98	SM											
BH-088	40	100	SM											
BH-088	41	102	GC											
BH-088	42	104	GC	28	65	7								
BH-088	43	106	GC											
BH-088	44	108	GC											
BH-088	45	110	SM											
BH-088	46	112.5	GM											
SUMMARY OF LABORATORY TEST RESULTS SILICON VALLEY RAPID TRANSIT (SVRT) PROJECT CENTRAL AREA GUIDEWAY SAN JOSE, CALIFORNIA											Notes: **USCS - Symbol of Unified Soil Classification System per visual-manual procedures in accordance with ASTM D 2488 or classification based on laboratory test results in accordance with ASTM D 2487 when laboratory data is available.			
 PARIKH CONSULTANTS, INC. <i>Geotechnical & Materials Engineering</i>											Date: 4/29/2008		Job No.: 204104.10	

TABLE A4-10

See disclaimer on cover page.

SVRT - PARIKH LAB TEST SUMMARY SVRT PHASE2 (01252008_WITH USCS).GPJ SVRT-BART.GDT 4/29/08

Boring No.	Sample No.	Depth (ft)	USCS**	Grain Size Analysis			Atterberg Limits			Unconfined Comp. (qu, ksf)	Lab Vane (su, ksf)	Dry Density (pcf)	Moisture Content (%)	Remarks
				gravel (%)	sand (%)	finer (%)	LL (%)	PL (%)	PI (%)					
BH-089	1	3.5	CL											
BH-089	2	12.5	ML											
BH-089	3	22.5	CL				37	21	16			31.9		
BH-089	4	32.5	ML											
BH-089	5	41.5	SM	0	53	47					106.3	23.0		
BH-089	6	51.5	GW-GM	53	38	9								
BH-089	7	67.5	ML											
BH-089	8	72.5	ML											
BH-089	9	81.5	SP-SM	30	63	7						11.4		
BH-089	10	91.5	SP-SM											
BH-089	11	101.5	ML											
BH-089	12	112.5	ML											
BH-089	13	122.5	SC											
BH-089	14	131.5	SC											
BH-089	15	142.5	CL											
BH-089	16	147.5	ML	0	21	79						20.3		
BH-089	17	152.5	SM											
BH-089	18	156.5	CL											
BH-089	19	151.5	CL	0	33	67						19.3		
BH-089	20	167.5	ML											
BH-089	21	172.5	ML	3	44	53					107.5	21.0		
BH-089	22	176.5	CL											
BH-089	23	181.5	CL											
BH-089	24	187.5	SC											
BH-089	25	191.5	CL	0	2	98	49	25	24			25.2		
SUMMARY OF LABORATORY TEST RESULTS SILICON VALLEY RAPID TRANSIT (SVRT) PROJECT CENTRAL AREA GUIDEWAY SAN JOSE, CALIFORNIA											Notes: **USCS - Symbol of Unified Soil Classification System per visual-manual procedures in accordance with ASTM D 2488 or classification based on laboratory test results in accordance with ASTM D 2487 when laboratory data is available.			
 PARIKH CONSULTANTS, INC. <i>Geotechnical & Materials Engineering</i>											Date: 4/29/2008		Job No.: 204104.10	

TABLE A4-11

See disclaimer on cover page.

Boring No.	Sample No.	Depth (ft)	USCS**	Grain Size Analysis			Atterberg Limits			Unconfined Comp. (qu, ksf)	Lab Vane (su, ksf)	Dry Density (pcf)	Moisture Content (%)	Remarks
				gravel (%)	sand (%)	finer (%)	LL (%)	PL (%)	PI (%)					
BH-089	26	196.5	SM											
BH-089	27	201.5	SM											
<p style="font-size: 48px; opacity: 0.3; transform: rotate(-30deg);">For Reference Only</p>														
<p>SUMMARY OF LABORATORY TEST RESULTS SILICON VALLEY RAPID TRANSIT (SVRT) PROJECT CENTRAL AREA GUIDEWAY SAN JOSE, CALIFORNIA</p>										<p>Notes: **USCS - Symbol of Unified Soil Classification System per visual-manual procedures in accordance with ASTM D 2488 or classification based on laboratory test results in accordance with ASTM D 2487 when laboratory data is available.</p>				
										Date: 4/29/2008		Job No.: 204104.10		

TABLE A4-12

SVRT - PARIKH LAB TEST SUMMARY SVRT PHASE2 (01252008_WITH USCS).GPJ SVRT-BART.GDT 4/29/08

Boring No.	Sample No.	Depth (ft)	USCS**	Grain Size Analysis			Atterberg Limits			Unconfined Comp. (qu, ksf)	Lab Vane (su, ksf)	Dry Density (pcf)	Moisture Content (%)	Remarks
				gravel (%)	sand (%)	finer (%)	LL (%)	PL (%)	PI (%)					
BH-090	1	5	CONCRETE											
BH-090	2	7.5	CL											
BH-090	3	11.5	CL											
BH-090	4	17.5	ML											
BH-090	5	22.5	CL											
BH-090	6	24	CH											
BH-090	7	27.5	CL											
BH-090	8	29	CL	0	11	89	36	22	14			23.4		
BH-090	9	32.5	SM											
BH-090	10	34	ML	0	30	70	NP	NP	NP			28.2		
BH-090	11	37.5	SM											
BH-090	12	39	CL	0	19	81	30	22	8			27.8		
BH-090	13	41.5	CH											
BH-090	14	45	ML									22.4		
BH-090	15	46.5	CL	0	30	70	26	18	8			24.4		
BH-090	16	49	CL											
BH-090	17	52.5	ML											
BH-090	18	54	CL-ML	0	22	78	28	22	6			29.4		
BH-090	19	56	CL											
BH-090	20	58.5	CL	1	34	65	34	15	19			21.7		
BH-090	21	62.5	CL											
BH-090	22	72.5	CL											
BH-090	23	81.5	GM											
BH-090	24	91.5	GM											
BH-090	25	101.5	CL											

SUMMARY OF LABORATORY TEST RESULTS
 SILICON VALLEY RAPID TRANSIT (SVRT) PROJECT
 CENTRAL AREA GUIDEWAY
 SAN JOSE, CALIFORNIA



PARIKH CONSULTANTS, INC.
 Geotechnical & Materials Engineering

Notes:

**USCS - Symbol of Unified Soil Classification System per visual-manual procedures in accordance with ASTM D 2488 or classification based on laboratory test results in accordance with ASTM D 2487 when laboratory data is available.

Date: 4/29/2008

Job No.: 204104.10

TABLE A4-13

See disclaimer on cover page.

SVRT - PARIKH LAB TEST SUMMARY SVRT PHASE2 (01252008_WITH USCS).GPJ SVRT-BART.GDT 4/29/08

Boring No.	Sample No.	Depth (ft)	USCS**	Grain Size Analysis			Atterberg Limits			Unconfined Comp. (qu, ksf)	Lab Vane (su, ksf)	Dry Density (pcf)	Moisture Content (%)	Remarks
				gravel (%)	sand (%)	finer (%)	LL (%)	PL (%)	PI (%)					
BH-090	26	112.5	CL											
BH-090	27	121.5	SM											
BH-090	28	131.5	CL											
BH-090	29	142.5	ML											
BH-090	30	151.5	ML	0	53	47						21.3		
BH-090	31	157.5	CL											
BH-090	32	162.5	CL	0	27	73					104.6	21.6		
BH-090	33	166.5	SM											
BH-090	34	171.5	CL											
BH-090	35	177.5	CL											
BH-090	36	182.5	CL	0	37	63						26.4		
BH-090	37	186.33	CL	0	30	70						28.0		
BH-090	38	191.33	ML											
BH-090	39	197.5	ML	0	34	66					104.5	20.5		
BH-090	40	202.5	ML											
BH-090	41	206.5	CL											
BH-090	42	211.5	ML								109.7	18.5		
SUMMARY OF LABORATORY TEST RESULTS											Notes: **USCS - Symbol of Unified Soil Classification System per visual-manual procedures in accordance with ASTM D 2488 or classification based on laboratory test results in accordance with ASTM D 2487 when laboratory data is available.			
SILICON VALLEY RAPID TRANSIT (SVRT) PROJECT CENTRAL AREA GUIDEWAY SAN JOSE, CALIFORNIA														
 PARIKH CONSULTANTS, INC. <i>Geotechnical & Materials Engineering</i>			Date: 4/29/2008								Job No.: 204104.10			

TABLE A4-14

See disclaimer on cover page.

SVRT - PARIKH LAB TEST SUMMARY SVRT PHASE2 (01252008_WITH USCS).GPJ SVRT-BART.GDT 4/29/08

Boring No.	Sample No.	Depth (ft)	USCS**	Grain Size Analysis			Atterberg Limits			Unconfined Comp. (qu, ksf)	Lab Vane (su, ksf)	Dry Density (pcf)	Moisture Content (%)	Remarks
				gravel (%)	sand (%)	finer (%)	LL (%)	PL (%)	PI (%)					
BH-091	1	3.5	CL											
BH-091	2	12.5	SM											
BH-091	3	22.5	CL				45	25	20			38.0		
BH-091	4	27.5	CL											
BH-091	5	29	SM	0	63	37	NP	NP	NP			24.4		
BH-091	6	31	SM	11	54	35	NP	NP	NP			24.3		
BH-091	7	32.5	SP-SM	16	75	9	NP	NP	NP			16.8		
BH-091	8	35	SP-SM											
BH-091	9	37	SM											
BH-091	10	39	SM											
BH-091	11	40.5	CL	0	18	82	33	21	12					
BH-091	12	44	CL											
BH-091	13	45.5	CL	0	25	75	32	18	14					
BH-091	14	52.5	SM											
BH-091	15	61.5	CL											
BH-091	16	72.5	CL								103.5	22.4		
BH-091	17	81.5	GC											
BH-091	18	91.5	GC											
BH-091	19	101.5	CL											
BH-091	20	112.5	CL-ML								101.2	23.9		
BH-091	21	121.5	GM											
BH-091	22	132	CL											
BH-091	23	136.5	CL											
BH-091	24	142.5	SC	23	38	39						14.9		
BH-091	25	146	SP-SM	31	61	8						12.0		

SUMMARY OF LABORATORY TEST RESULTS
 SILICON VALLEY RAPID TRANSIT (SVRT) PROJECT
 CENTRAL AREA GUIDEWAY
 SAN JOSE, CALIFORNIA



PARIKH CONSULTANTS, INC.
 Geotechnical & Materials Engineering

Notes:

**USCS - Symbol of Unified Soil Classification System per visual-manual procedures in accordance with ASTM D 2488 or classification based on laboratory test results in accordance with ASTM D 2487 when laboratory data is available.

Date: 4/29/2008

Job No.: 204104.10

TABLE A4-15

See disclaimer on cover page.

SVRT - PARIKH LAB TEST SUMMARY SVRT PHASE2 (01252008_WITH USCS).GPJ SVRT-BART.GDT 4/29/08

Boring No.	Sample No.	Depth (ft)	USCS**	Grain Size Analysis			Atterberg Limits			Unconfined Comp. (qu, ksf)	Lab Vane (su, ksf)	Dry Density (pcf)	Moisture Content (%)	Remarks
				gravel (%)	sand (%)	finer (%)	LL (%)	PL (%)	PI (%)					
BH-091	26	151	SP-SM											
BH-091	27	156.5	SM	0	85	15						18.8		
BH-091	28	162.5	CL											
BH-091	29	166	GP-GM											
BH-091	30	171	GP-GM											
BH-091	31	176.5	GP-GM	50	41	9						10.6		
BH-091	32	182.5	CL	0	1	99						28.0		
BH-091	33	186.5	CL											
BH-091	34	190.8	GP-GC											
BH-091	35	196.5	GP-GC	64	29	7						9.0		

SUMMARY OF LABORATORY TEST RESULTS
 SILICON VALLEY RAPID TRANSIT (SVRT) PROJECT
 CENTRAL AREA GUIDEWAY
 SAN JOSE, CALIFORNIA



PARIKH CONSULTANTS, INC.
Geotechnical & Materials Engineering

Notes:
 **USCS - Symbol of Unified Soil Classification System per visual-manual procedures in accordance with ASTM D 2488 or classification based on laboratory test results in accordance with ASTM D 2487 when laboratory data is available.

Date: 4/29/2008

Job No.: 204104.10

TABLE A4-16

See disclaimer on cover page.

SVRT - PARIKH LAB TEST SUMMARY SVRT PHASE2 (01252008_WITH USCS).GPJ SVRT-BART.GDT 4/29/08

Boring No.	Sample No.	Depth (ft)	USCS**	Grain Size Analysis			Atterberg Limits			Unconfined Comp. (qu, ksf)	Lab Vane (su, ksf)	Dry Density (pcf)	Moisture Content (%)	Remarks
				gravel (%)	sand (%)	finer (%)	LL (%)	PL (%)	PI (%)					
BH-093	1	3.5	CL											
BH-093	2	12.5	ML											
BH-093	3	22.5	CL											
BH-093	4	32.5	CL											
BH-093	5	41.5	GM											
BH-093	6	52.5	CL-ML				28	23	5		105.3	21.1		
BH-093	7	62.5	CL-ML											
BH-093	8	71.5	SW											
BH-093	9	82.5	CL											
BH-093	10	91.5	CL											
BH-093	11	101.5	SP-SM	2	87	11						18.5		
BH-093	12	111.5	SM											
BH-093	13	122.5	CL								101.5	23.6		
BH-093	14	131.5	SM											
BH-093	15	141.5	CL											
BH-093	16	151.5	CL-ML											
BH-093	17	153.5	SW											
BH-093	18	156	SM											
BH-093	19	158.5	CL	0	17	83	30	21	9			23.0		
BH-093	20	161	CL											
BH-093	21	163	CL											
BH-093	22	164.7	SP-SM	4	90	6						20.1		
BH-093	23	167.2	SP-SM											
BH-093	24	169.7	CL	9	37	54						17.7		
BH-093	25	171.7	GP-GM											
SUMMARY OF LABORATORY TEST RESULTS SILICON VALLEY RAPID TRANSIT (SVRT) PROJECT CENTRAL AREA GUIDEWAY SAN JOSE, CALIFORNIA											Notes: **USCS - Symbol of Unified Soil Classification System per visual-manual procedures in accordance with ASTM D 2488 or classification based on laboratory test results in accordance with ASTM D 2487 when laboratory data is available.			
 PARIKH CONSULTANTS, INC. <i>Geotechnical & Materials Engineering</i>											Date: 4/29/2008		Job No.: 204104.10	

TABLE A4-17

See disclaimer on cover page.

SVRT - PARIKH LAB TEST SUMMARY SVRT PHASE2 (01252008_WITH USCS).GPJ SVRT-BART.GDT 4/29/08

Boring No.	Sample No.	Depth (ft)	USCS**	Grain Size Analysis			Atterberg Limits			Unconfined Comp. (qu, ksf)	Lab Vane (su, ksf)	Dry Density (pcf)	Moisture Content (%)	Remarks
				gravel (%)	sand (%)	finer (%)	LL (%)	PL (%)	PI (%)					
BH-093	26	173.2	GP-GM	73	21	6						7.7		
BH-093	27	175.2	SM											
BH-093	28	177.2	GP-GC											
BH-093	29	179.7	SP-SM											
BH-093	30	181.8	SP-SM	34	60	6						9.7		
BH-093	31	184.3	ML											
BH-093	32	186.8	CL											
BH-093	33	190	CL								97.6	26.4		
BH-093	34	191.5	CL											
BH-093	35	193.7	CL											
BH-093	36	195.2	SM											
BH-093	37	197.7	CL											
BH-093	38	200	CL	0	25	75	35	26	9			26.9		
BH-093	39	211.5	CL											

SUMMARY OF LABORATORY TEST RESULTS
 SILICON VALLEY RAPID TRANSIT (SVRT) PROJECT
 CENTRAL AREA GUIDEWAY
 SAN JOSE, CALIFORNIA



PARIKH CONSULTANTS, INC.
Geotechnical & Materials Engineering

Notes:

**USCS - Symbol of Unified Soil Classification System per visual-manual procedures in accordance with ASTM D 2488 or classification based on laboratory test results in accordance with ASTM D 2487 when laboratory data is available.

Date: 4/29/2008

Job No.: 204104.10

TABLE A4-18

See disclaimer on cover page.

SVRT - PARIKH LAB TEST SUMMARY SVRT PHASE2 (01252008_WITH USCS).GPJ SVRT-BART.GDT 4/29/08

Boring No.	Sample No.	Depth (ft)	USCS**	Grain Size Analysis			Atterberg Limits			Unconfined Comp. (qu, ksf)	Lab Vane (su, ksf)	Dry Density (pcf)	Moisture Content (%)	Remarks
				gravel (%)	sand (%)	finer (%)	LL (%)	PL (%)	PI (%)					
BH-095	1	3.5	CL											
BH-095	2	7.5	CL											
BH-095	3	12.5	CL-ML											
BH-095	4	17.5	CL											
BH-095	5	22.5	MH/CH				55	30	25			39.9		
BH-095	6	25	CL											
BH-095	7	27.5	CL											
BH-095	8	30	CL											
BH-095	9	32.5	SM	0	61	39					104	23.3		
BH-095	10	34	ML											
BH-095	11	36.5	GW											
BH-095	12	39	GP-GM	56	39	5						7.5		
BH-095	13	41.5	CL-ML											
BH-095	14	44	CL-ML											
BH-095	15	45	CL											
BH-095	16	46.5					38	23	15			30.4		
BH-095	17	49	CL											
BH-095	18	51.5	CL				35	23	12		100.1	26.1		
BH-095	19	54	CL-ML											
BH-095	20	57.5	SP-SM											
BH-095	21	59	SP-SM	45	49	6						9.0		
BH-095	22	61.5	GW											
BH-095	23	64	GM	75	12	13						9.0		
BH-095	24	67.5	SM											
BH-095	25	69	GP-GM	49	45	6						8.4		
SUMMARY OF LABORATORY TEST RESULTS SILICON VALLEY RAPID TRANSIT (SVRT) PROJECT CENTRAL AREA GUIDEWAY SAN JOSE, CALIFORNIA											Notes: **USCS - Symbol of Unified Soil Classification System per visual-manual procedures in accordance with ASTM D 2488 or classification based on laboratory test results in accordance with ASTM D 2487 when laboratory data is available.			
 PARIKH CONSULTANTS, INC. <i>Geotechnical & Materials Engineering</i>											Date: 4/29/2008		Job No.: 204104.10	

TABLE A4-19

See disclaimer on cover page.

SVRT - PARIKH LAB TEST SUMMARY SVRT PHASE2 (01252008_WITH USCS).GPJ SVRT-BART.GDT 4/29/08

Boring No.	Sample No.	Depth (ft)	USCS**	Grain Size Analysis			Atterberg Limits			Unconfined Comp. (qu, ksf)	Lab Vane (su, ksf)	Dry Density (pcf)	Moisture Content (%)	Remarks
				gravel (%)	sand (%)	finer (%)	LL (%)	PL (%)	PI (%)					
BH-095	26	71.5	GP-GM											
BH-095	27	74	GP-GM											
BH-095	28	76.5	GW											
BH-095	29	79	SW-SM	43	52	5						7.2		
BH-095	30	81.5	CL											
BH-095	31	84	GW											
BH-095	32	87.5	CL-ML											
BH-095	33	92.5	CL-ML											
BH-095	34	97.5	CL				34	19	15			25.0		
BH-095	35	101.5	CL								105.1	22.8		

SUMMARY OF LABORATORY TEST RESULTS
 SILICON VALLEY RAPID TRANSIT (SVRT) PROJECT
 CENTRAL AREA GUIDEWAY
 SAN JOSE, CALIFORNIA

PARIKH CONSULTANTS, INC.
Geotechnical & Materials Engineering

Notes:

**USCS - Symbol of Unified Soil Classification System per visual-manual procedures in accordance with ASTM D 2488 or classification based on laboratory test results in accordance with ASTM D 2487 when laboratory data is available.

Date: 4/29/2008

Job No.: 204104.10

TABLE A4-20

See disclaimer on cover page.

SVRT - PARIKH LAB TEST SUMMARY SVRT PHASE2 (01252008_WITH USCS).GPJ SVRT-BART.GDT 4/29/08

Boring No.	Sample No.	Depth (ft)	USCS**	Grain Size Analysis			Atterberg Limits			Unconfined Comp. (qu, ksf)	Lab Vane (su, ksf)	Dry Density (pcf)	Moisture Content (%)	Remarks
				gravel (%)	sand (%)	finer (%)	LL (%)	PL (%)	PI (%)					
BH-097	1	3.5	CL											
BH-097	2	7.5	CL											
BH-097	3	11.5	CL											
BH-097	4	17.5	CH	0	1	99	62	30	32		78.4	42.5		
BH-097	5	21.5	CL											
BH-097	6	26.5	GW-GM											
BH-097	7	31.5	ML											
BH-097	8	37.5	CL											
BH-097	9	41.5	SM											
BH-097	10	48	ML									29.5		
BH-097	11	51.5	SP-SM	28	65	7						9.6		
BH-097	12	55.792	GW-GM											
BH-097	13	60.875	GW-GM											
BH-097	14	66.5	SW-SM											
BH-097	15	71.5	GC	41	35	24						13.6		
BH-097	16	77.5	CL											
BH-097	17	81.5	GW-GM											
BH-097	18	86.5	GW	90	9	1						6.3		
BH-097	19	91.5	GC											
SUMMARY OF LABORATORY TEST RESULTS											Notes: **USCS - Symbol of Unified Soil Classification System per visual-manual procedures in accordance with ASTM D 2488 or classification based on laboratory test results in accordance with ASTM D 2487 when laboratory data is available.			
SILICON VALLEY RAPID TRANSIT (SVRT) PROJECT CENTRAL AREA GUIDEWAY SAN JOSE, CALIFORNIA														
 PARIKH CONSULTANTS, INC. <i>Geotechnical & Materials Engineering</i>			Date: 4/29/2008		Job No.: 204104.10									

TABLE A4-21

See disclaimer on cover page.

SVRT - PARIKH LAB TEST SUMMARY SVRT PHASE2 (01252008_WITH USCS).GPJ SVRT-BART.GDT 4/29/08

Boring No.	Sample No.	Depth (ft)	USCS**	Grain Size Analysis			Atterberg Limits			Unconfined Comp. (qu, ksf)	Lab Vane (su, ksf)	Dry Density (pcf)	Moisture Content (%)	Remarks
				gravel (%)	sand (%)	finer (%)	LL (%)	PL (%)	PI (%)					
BH-098	1	3.5	ML											
BH-098	2	7.5	CL											
BH-098	3	11.5	ML				60	33	27		85.7	35.9		
BH-098	4	17.5	CL-ML											
BH-098	5	21.5	CL											
BH-098	6	27.5	CL											
BH-098	7	31.5	CL-ML											
BH-098	8	37.5	ML	0	49	51						22.0		
BH-098	9	41.5	SM	0	79	21					104.5	21.9		
BH-098	10	46.5	CL	0	10	90						30.7		
BH-098	11	52.5	CL-ML											
BH-098	12	56.5	ML				39	30	9			33.8		
BH-098	13	61.5	GW-GM											
SUMMARY OF LABORATORY TEST RESULTS														
SILICON VALLEY RAPID TRANSIT (SVRT) PROJECT CENTRAL AREA GUIDEWAY SAN JOSE, CALIFORNIA														
 PARIKH CONSULTANTS, INC. <i>Geotechnical & Materials Engineering</i>											Notes:			
											**USCS - Symbol of Unified Soil Classification System per visual-manual procedures in accordance with ASTM D 2488 or classification based on laboratory test results in accordance with ASTM D 2487 when laboratory data is available.			
											Date: 4/29/2008		Job No.: 204104.10	

TABLE A4-22

See disclaimer on cover page.

SVRT - PARIKH LAB TEST SUMMARY SVRT PHASE2 (01252008_WITH USCS).GPJ SVRT-BART.GDT 4/29/08

Boring No.	Sample No.	Depth (ft)	USCS**	Grain Size Analysis			Atterberg Limits			Unconfined Comp. (qu, ksf)	Lab Vane (su, ksf)	Dry Density (pcf)	Moisture Content (%)	Remarks
				gravel (%)	sand (%)	finer (%)	LL (%)	PL (%)	PI (%)					
BH-099	1	3.5	CH											
BH-099	2	7.5	CL											
BH-099	3	11.5	CL											
BH-099	4	17.5	ML											
BH-099	5	21.5	CH											
BH-099	6	27.5	CL											
BH-099	7	31.5	CL	0	39	61	27	16	11			26.8		
BH-099	8	37.5	CL											
BH-099	9	41.5	CL											
BH-099	10	47.5	SM	0	73	27					106.5	19.7		
BH-099	11	51.5	CL											
BH-099	12	57.5	CL	0	28	72						20.2		
BH-099	13	61	GW											
BH-099	14	66.5	SP-SM	37	58	5						9.8		
BH-099	15	71.5	SP-SM											
BH-099	16	76.5	SW-SM	31	62	7						10.1		
BH-099	17	81.5	SW-SM											

SUMMARY OF LABORATORY TEST RESULTS
 SILICON VALLEY RAPID TRANSIT (SVRT) PROJECT
 CENTRAL AREA GUIDEWAY
 SAN JOSE, CALIFORNIA



PARIKH CONSULTANTS, INC.
Geotechnical & Materials Engineering

Notes:
 **USCS - Symbol of Unified Soil Classification System per visual-manual procedures in accordance with ASTM D 2488 or classification based on laboratory test results in accordance with ASTM D 2487 when laboratory data is available.

Date: 4/29/2008

Job No.: 204104.10

TABLE A4-23

See disclaimer on cover page.

SVRT - PARIKH LAB TEST SUMMARY SVRT PHASE2 (01252008_WITH USCS).GPJ SVRT-BART.GDT 4/29/08

Boring No.	Sample No.	Depth (ft)	USCS**	Grain Size Analysis			Atterberg Limits			Unconfined Comp. (qu, ksf)	Lab Vane (su, ksf)	Dry Density (pcf)	Moisture Content (%)	Remarks
				gravel (%)	sand (%)	finer (%)	LL (%)	PL (%)	PI (%)					
BH-100	1	3.5	CH											
BH-100	2	7.5	CH											
BH-100	3	11.5	CL											
BH-100	4	17.5	CL											
BH-100	5	21.5	CL											
BH-100	6	27.5	CL-ML				27	20	7		104.7	21.8		
BH-100	7	31.5	SP-SM	31	61	8						11.2		
BH-100	8	36.5	SC	7	48	45						20.1		
BH-100	9	41.5	SP-SM	11	78	11						10.0		

SUMMARY OF LABORATORY TEST RESULTS
 SILICON VALLEY RAPID TRANSIT (SVRT) PROJECT
 CENTRAL AREA GUIDEWAY
 SAN JOSE, CALIFORNIA

PARIKH CONSULTANTS, INC.
Geotechnical & Materials Engineering

Notes:
 **USCS - Symbol of Unified Soil Classification System per visual-manual procedures in accordance with ASTM D 2488 or classification based on laboratory test results in accordance with ASTM D 2487 when laboratory data is available.

Date: 4/29/2008

Job No.: 204104.10

TABLE A4-24

See disclaimer on cover page.

SVRT - PARIKH LAB TEST SUMMARY SVRT PHASE2 (01252008_WITH USCS).GFJ SVRT-BART.GDT 4/29/08

Boring No.	Sample No.	Depth (ft)	USCS**	Grain Size Analysis			Atterberg Limits			Unconfined Comp. (qu, ksf)	Lab Vane (su, ksf)	Dry Density (pcf)	Moisture Content (%)	Remarks
				gravel (%)	sand (%)	finer (%)	LL (%)	PL (%)	PI (%)					
BH-101	1	3.5	SC											
BH-101	2	6.5	GP-GM	77	18	5						8.1		
BH-101	3	12.5	ML											
BH-101	4	17.5	CL											
BH-101	5	22.5	CH				52	27	25		81.4	41.0		
BH-101	6	27.5	CL											
BH-101	7	32.5	CL											
BH-101	8	37.5	CL				31	19	12		107.3	20.6		
BH-101	9	42.5	CL											
BH-101	10	47.5	CL											
BH-101	11	52.5	ML											

For Reference Only

SUMMARY OF LABORATORY TEST RESULTS

SILICON VALLEY RAPID TRANSIT (SVRT) PROJECT
 CENTRAL AREA GUIDEWAY
 SAN JOSE, CALIFORNIA



PARIKH CONSULTANTS, INC.
 Geotechnical & Materials Engineering

Notes:

**USCS - Symbol of Unified Soil Classification System per visual-manual procedures in accordance with ASTM D 2488 or classification based on laboratory test results in accordance with ASTM D 2487 when laboratory data is available.

Date: 4/29/2008

Job No.: 204104.10

TABLE A4-25

See disclaimer on cover page.

SVRT - PARIKH LAB TEST SUMMARY SVRT PHASE2 (01252008_WITH USCS).GPJ SVRT-BART.GDT 4/29/08

Boring No.	Sample No.	Depth (ft)	USCS**	Grain Size Analysis			Atterberg Limits			Unconfined Comp. (qu, ksf)	Lab Vane (su, ksf)	Dry Density (pcf)	Moisture Content (%)	Remarks
				gravel (%)	sand (%)	finer (%)	LL (%)	PL (%)	PI (%)					
BH-102	1	3.5	SP-SM											
BH-102	2	6.5	SP-SM											
BH-102	3	11.5	GW-GM											
BH-102	4	16.5	GW-GM											
BH-102	5	22.5	CL											
BH-102	6	27.5	CL	0	6	94					87.7	33.2		
BH-102	7	33	CL											
BH-102	8	36	CL											
BH-102	9	39	ML											
BH-102	10	42	CL											
BH-102	11	46	CL											
BH-102	12	49	GW-GM	48	45	7								
BH-102	13	51	GW-GM											
BH-102	14	52	CL											
BH-102	15	53.5	CL											
BH-102	16	56	CL											
BH-102	17	57.5	SM											
BH-102	18	59	GW-GM											
BH-102	19	60.5	GW-GM	66	30	4								
BH-102	20	62	GW-GM											
BH-102	21	63.5	GW-GM											
BH-102	22	65	GW-GM											
BH-102	23	66.5	ML	0	28	72								
BH-102	24	68.5	CL-ML											
BH-102	25	70	CL-ML											

SUMMARY OF LABORATORY TEST RESULTS

SILICON VALLEY RAPID TRANSIT (SVRT) PROJECT
CENTRAL AREA GUIDEWAY
SAN JOSE, CALIFORNIA



PARIKH CONSULTANTS, INC.
Geotechnical & Materials Engineering

Notes:
**USCS - Symbol of Unified Soil Classification System per visual-manual procedures in accordance with ASTM D 2488 or classification based on laboratory test results in accordance with ASTM D 2487 when laboratory data is available.

Date: 4/29/2008
Job No.: 204104.10

TABLE A4-26

See disclaimer on cover page.

Boring No.	Sample No.	Depth (ft)	USCS**	Grain Size Analysis			Atterberg Limits			Unconfined Comp. (qu, ksf)	Lab Vane (su, ksf)	Dry Density (pcf)	Moisture Content (%)	Remarks
				gravel (%)	sand (%)	finer (%)	LL (%)	PL (%)	PI (%)					
BH-102	26	72	CL-ML											
BH-102	27	74	SP-SM											
BH-102	28	75.5	SP-SM											
BH-102	29	77	GW-GM											
BH-102	30	78.5	GW-GM	46	45	9								
BH-102	31	80	GW-GM											



<p style="text-align: center;">SUMMARY OF LABORATORY TEST RESULTS</p> <p style="text-align: center;">SILICON VALLEY RAPID TRANSIT (SVRT) PROJECT CENTRAL AREA GUIDEWAY SAN JOSE, CALIFORNIA</p>	<p>Notes:</p> <p>**USCS - Symbol of Unified Soil Classification System per visual-manual procedures in accordance with ASTM D 2488 or classification based on laboratory test results in accordance with ASTM D 2487 when laboratory data is available.</p>
 <p>PARIKH CONSULTANTS, INC. Geotechnical & Materials Engineering</p>	<p>Date: 4/29/2008 Job No.: 204104.10</p>

TABLE A4-27

SVRT - PARIKH LAB TEST SUMMARY SVRT PHASE2 (01252008_WITH USCS).GPJ SVRT-BART.GDT 4/29/08

Boring No.	Sample No.	Depth (ft)	USCS**	Grain Size Analysis			Atterberg Limits			Unconfined Comp. (qu, ksf)	Lab Vane (su, ksf)	Dry Density (pcf)	Moisture Content (%)	Remarks
				gravel (%)	sand (%)	finer (%)	LL (%)	PL (%)	PI (%)					
BH-103	1	3.5	CL											
BH-103	2	6.5	CL-ML											
BH-103	3	11.5	ML											
BH-103	4	16.5	ML											
BH-103	5	22.5	ML											
BH-103	6	27.5	CL											
BH-103	7	32	CH	0	10	90	59	22	37					
BH-103	8	34	CL											
BH-103	9	36	CL											
BH-103	10	38	CL											
BH-103	11	40	CL											
BH-103	12	41.5	GP											
BH-103	13	43	GP											
BH-103	14	44.5	GP											
BH-103	15	46	GP											
BH-103	16	47.5	GW-GM	59	36	5								
BH-103	17	49	GW-GM											
BH-103	18	50.5	GW-GM											
BH-103	19	52	GW-GM											
BH-103	20	53.5	CL											
BH-103	21	55	ML	0	35	65	NP	NP	NP					
BH-103	22	56.5	SW											
BH-103	23	58	SW											
BH-103	24	59.5	SW											
BH-103	25	61	SW											

SUMMARY OF LABORATORY TEST RESULTS
 SILICON VALLEY RAPID TRANSIT (SVRT) PROJECT
 CENTRAL AREA GUIDEWAY
 SAN JOSE, CALIFORNIA



PARIKH CONSULTANTS, INC.
Geotechnical & Materials Engineering

Notes:
**USCS - Symbol of Unified Soil Classification System per visual-manual procedures in accordance with ASTM D 2488 or classification based on laboratory test results in accordance with ASTM D 2487 when laboratory data is available.

Date: 4/29/2008
Job No.: 204104.10

TABLE A4-28

See disclaimer on cover page.

SVRT - PARIKH LAB TEST SUMMARY SVRT PHASE2 (01252008_WITH USCS).GPJ SVRT-BART.GDT 4/29/08

Boring No.	Sample No.	Depth (ft)	USCS**	Grain Size Analysis			Atterberg Limits			Unconfined Comp. (qu, ksf)	Lab Vane (su, ksf)	Dry Density (pcf)	Moisture Content (%)	Remarks
				gravel (%)	sand (%)	finer (%)	LL (%)	PL (%)	PI (%)					
BH-103	26	62.5	SW	46	51	3								
BH-103	27	64	SW											
BH-103	28	65.5	SW											
BH-103	29	68	ML											
BH-103	30	70.5	ML											
BH-103	31	72	ML	1	44	55								
BH-103	32	75	ML											
BH-103	33	77.5	SM	8	79	13								
BH-103	34	79	SM											
BH-103	35	79.92	SM											
BH-103	36	81.5	SW											
BH-103	37	84	SW	51	45	4								
BH-103	38	86.5	GP											
BH-103	39	89	ML	0	48	52	NP	NP	NP					
BH-103	40	90.5	ML											

SUMMARY OF LABORATORY TEST RESULTS
 SILICON VALLEY RAPID TRANSIT (SVRT) PROJECT
 CENTRAL AREA GUIDEWAY
 SAN JOSE, CALIFORNIA



PARIKH CONSULTANTS, INC.
Geotechnical & Materials Engineering

Notes:
 **USCS - Symbol of Unified Soil Classification System per visual-manual procedures in accordance with ASTM D 2488 or classification based on laboratory test results in accordance with ASTM D 2487 when laboratory data is available.

Date: 4/29/2008

Job No.: 204104.10

TABLE A4-29

See disclaimer on cover page.

SVRT - PARIKH LAB TEST SUMMARY SVRT PHASE2 (01252008_WITH USCS).GPJ SVRT-BART.GDT 4/29/08

Boring No.	Sample No.	Depth (ft)	USCS**	Grain Size Analysis			Atterberg Limits			Unconfined Comp. (qu, ksf)	Lab Vane (su, ksf)	Dry Density (pcf)	Moisture Content (%)	Remarks
				gravel (%)	sand (%)	finer (%)	LL (%)	PL (%)	PI (%)					
BH-105	1	3.5	CL											
BH-105	2	7.5	ML											
BH-105	3	11.5	SW-SM	35	53	12						8.2		
BH-105	4	17.5	CL											
BH-105	5	22.5	CL											
BH-105	6	24	SM	0	50	50	NP	NP	NP			27.1		
BH-105	7	27.5	SM	0	66	34	NP	NP	NP		84.1	34.5		
BH-105	8	29	SM											
BH-105	9	32.5	CL	0	55	45	29	19	10			31.9		
BH-105	10	34	SC											
BH-105	11	37.5	CL											
BH-105	12	39	SM	0	52	48	86	62	24			64.6		
BH-105	13	41.5	SW-SM	39	51	10						12.6		
BH-105	14	46.5	CL-ML											
BH-105	15	51.5	CL-ML											

SUMMARY OF LABORATORY TEST RESULTS
 SILICON VALLEY RAPID TRANSIT (SVRT) PROJECT
 CENTRAL AREA GUIDEWAY
 SAN JOSE, CALIFORNIA

PARIKH CONSULTANTS, INC.
Geotechnical & Materials Engineering

Notes:
 **USCS - Symbol of Unified Soil Classification System per visual-manual procedures in accordance with ASTM D 2488 or classification based on laboratory test results in accordance with ASTM D 2487 when laboratory data is available.

Date: 4/29/2008 Job No.: 204104.10

TABLE A4-30

See disclaimer on cover page.

SVRT - PARIKH LAB TEST SUMMARY SVRT PHASE2 (01252008_WITH USCS).GPJ SVRT-BART.GDT 4/29/08

Boring No.	Sample No.	Depth (ft)	USCS**	Grain Size Analysis			Atterberg Limits			Unconfined Comp. (qu, ksf)	Lab Vane (su, ksf)	Dry Density (pcf)	Moisture Content (%)	Remarks
				gravel (%)	sand (%)	finer (%)	LL (%)	PL (%)	PI (%)					
BH-106	1	3.5	CL											
BH-106	2	7.5	ML											
BH-106	3	12.5	CL											
BH-106	4	17.5	ML											
BH-106	5	22.5	CL				31	17	14					
BH-106	6	27.5	CL											
BH-106	7	33	CL											
BH-106	8	36	CL											
BH-106	9	39	CL											
BH-106	10	41.5	CL											
BH-106	11	43	GP	51	45	4								
BH-106	12	44.5	GP											
BH-106	13	46	GP											
BH-106	14	47.5	GP											
BH-106	15	49	GW	51	44	5								
BH-106	16	50.5	GW											
BH-106	17	52	GW											
BH-106	18	53.5	GW											
BH-106	19	55.5	GW											
BH-106	20	57	GW											
BH-106	21	58.5	ML	0	10	90								
BH-106	22	62	ML											
BH-106	23	64	ML											
BH-106	24	65.5	ML											
BH-106	25	67	GW-GM											

SUMMARY OF LABORATORY TEST RESULTS
 SILICON VALLEY RAPID TRANSIT (SVRT) PROJECT
 CENTRAL AREA GUIDEWAY
 SAN JOSE, CALIFORNIA



PARIKH CONSULTANTS, INC.
 Geotechnical & Materials Engineering

Notes:

**USCS - Symbol of Unified Soil Classification System per visual-manual procedures in accordance with ASTM D 2488 or classification based on laboratory test results in accordance with ASTM D 2487 when laboratory data is available.

Date: 4/29/2008

Job No.: 204104.10

TABLE A4-31

See disclaimer on cover page.

SVRT - PARIKH LAB TEST SUMMARY SVRT PHASE2 (01252008_WITH USCS).GPJ SVRT-BART.GDT 4/29/08

Boring No.	Sample No.	Depth (ft)	USCS**	Grain Size Analysis			Atterberg Limits			Unconfined Comp. (qu, ksf)	Lab Vane (su, ksf)	Dry Density (pcf)	Moisture Content (%)	Remarks
				gravel (%)	sand (%)	finer (%)	LL (%)	PL (%)	PI (%)					
BH-106	26	68.5	ML	0	49	51	NP	NP	NP					
BH-106	27	70	ML											
BH-106	28	72.5	ML											
BH-106	29	74	CL											
BH-106	30	77.5	CL-ML											
BH-106	31	80	CL											
BH-106	32	81.5	ML											
BH-106	33	85	ML				32	23	9					
BH-106	34	87.5	CL											
BH-106	35	90	ML											

SUMMARY OF LABORATORY TEST RESULTS
 SILICON VALLEY RAPID TRANSIT (SVRT) PROJECT
 CENTRAL AREA GUIDEWAY
 SAN JOSE, CALIFORNIA

PARIKH CONSULTANTS, INC.
Geotechnical & Materials Engineering

Notes:

**USCS - Symbol of Unified Soil Classification System per visual-manual procedures in accordance with ASTM D 2488 or classification based on laboratory test results in accordance with ASTM D 2487 when laboratory data is available.

Date: 4/29/2008

Job No.: 204104.10

TABLE A4-32

See disclaimer on cover page.

PLASTICITY INDEX

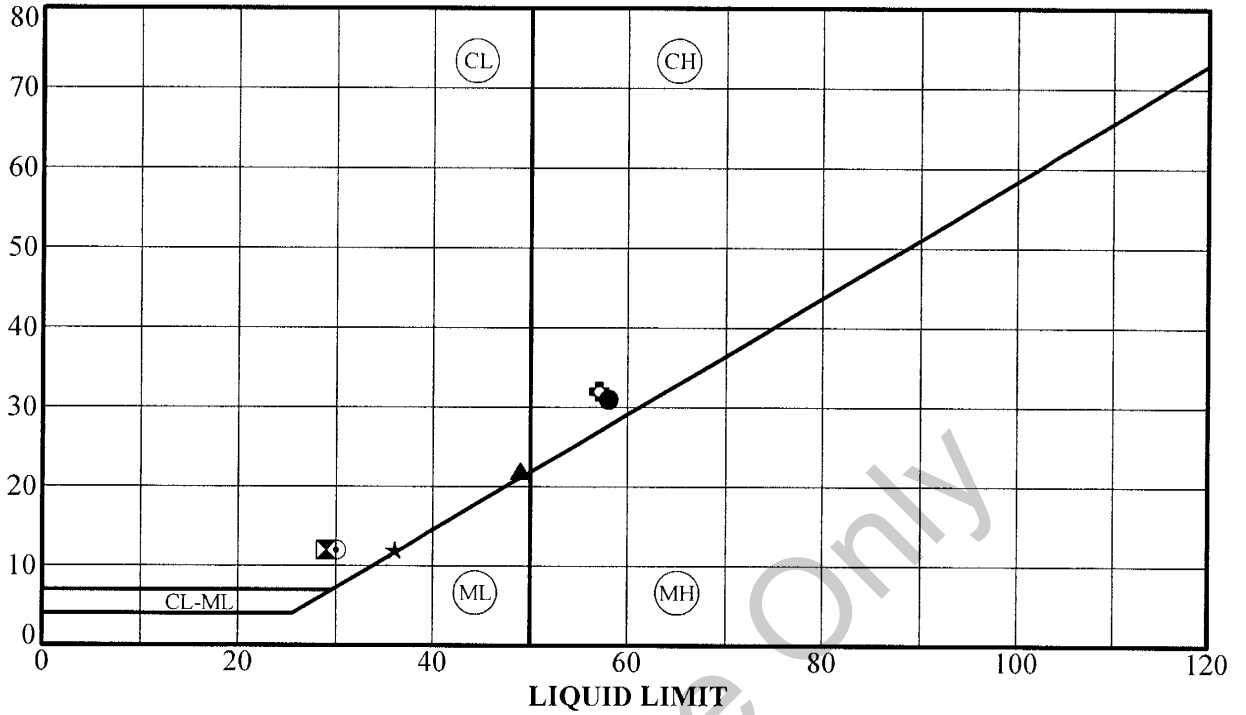

Key Symbol	Boring No.	Depth (Feet)	Liquid Limit (%)	Plasticity Index (%)	Liquidity Index	Water Content (%)	% Passing #200 Sieve	USCS
●	BH-084	42.5	58	31	0.194	33		CH
⊗	BH-084	157.5	29	12	0.150	19		CL
▲	BH-084	167.5	49	22	0.086	29		CL/CH
★	BH-084	177.5	36	12	0.133	26		CL/ML
⊙	BH-084	192.5	30	12	0.225	21		CL
⊕	BH-084	207.5	57	32	-0.106	22		CH

ATTERBERG SVRT_PHASE 2_041808 GPJ SVRT-BART GDT 4/29/08



PREP'D BY:
L. Tran
APP'D BY:
F. Wang
DATE:
4/29/08
DWG FILE:

PLASTICITY CHART AND DATA
SILICON VALLEY RAPID TRANSIT PROJECT
San Jose, California

FIGURE
4-2
PROJECT No.
213213

PLASTICITY INDEX

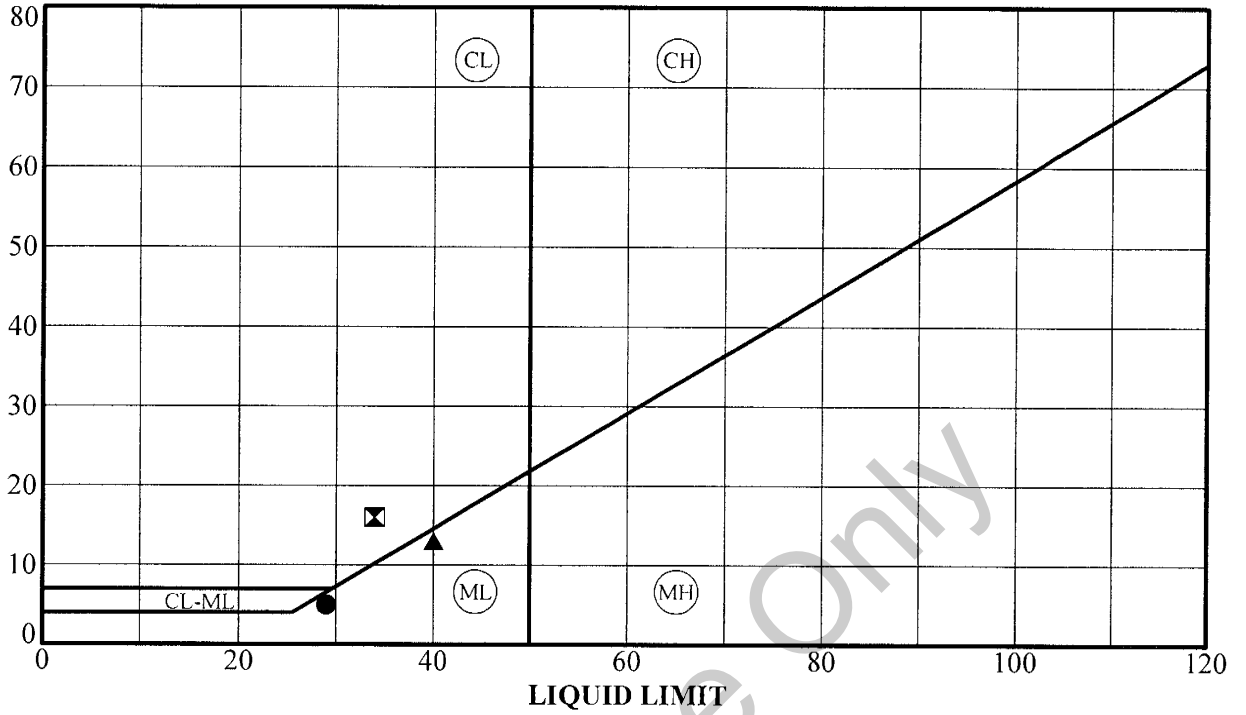

Key Symbol	Boring No.	Depth (Feet)	Liquid Limit (%)	Plasticity Index (%)	Liquidity Index	Water Content (%)	% Passing #200 Sieve	USCS
●	BH-088	33.5	29	5			90	ML
⊠	BH-088	41.0	34	16	0.463	25		CL
▲	BH-088	68.0	40	13			100	ML
	BH-088	71.0	NP	NP			11	GP-GM

ATTERBERG SVRT_PHASE 2_041808 GPJ SVRT-BART.GDT 4/29/08



PREP'D BY:
L. Tran
APP'D BY:
F. Wang
DATE:
4/29/08
DWG FILE

PLASTICITY CHART AND DATA

SILICON VALLEY RAPID TRANSIT PROJECT
San Jose, California

FIGURE
4-5
PROJECT No
213213

PLASTICITY INDEX

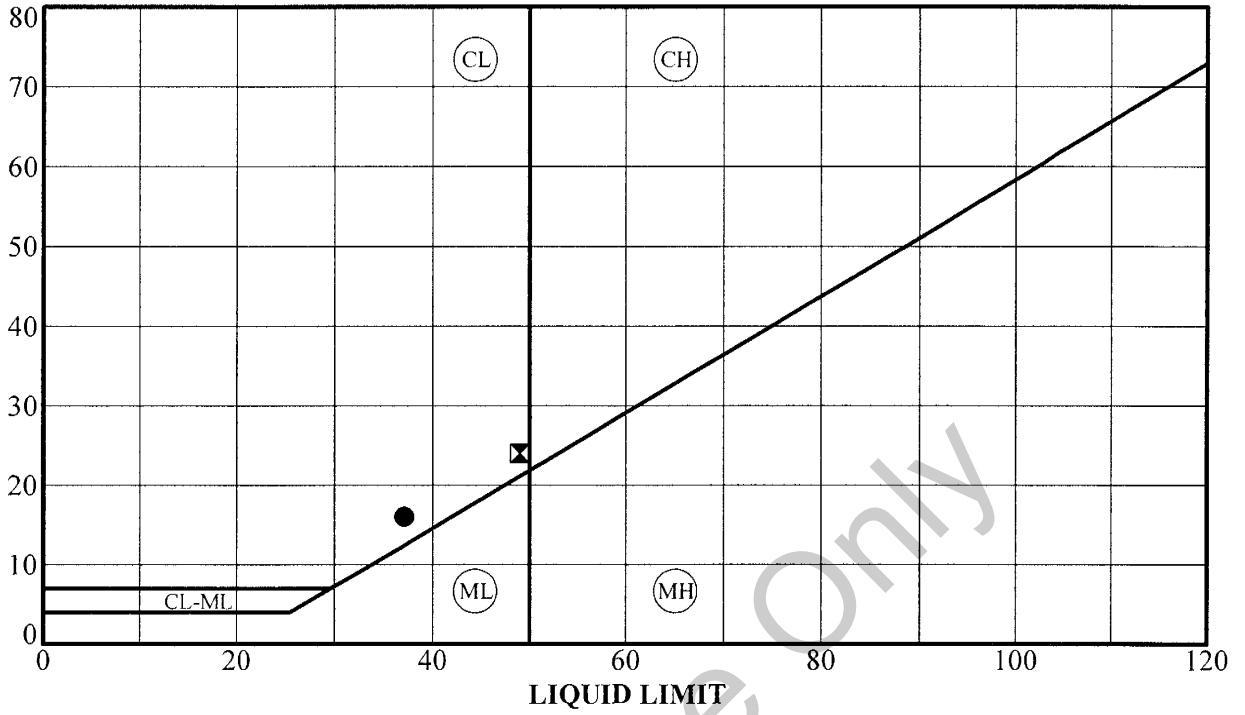

Key Symbol	Boring No.	Depth (Feet)	Liquid Limit (%)	Plasticity Index (%)	Liquidity Index	Water Content (%)	% Passing #200 Sieve	USCS
●	BH-089	22.5	37	16	0.681	32		CL
⊠	BH-089	191.5	49	24	0.008	25	98	CL

ATTERBERG SVRT_PHASE 2_041808.GPJ SVRT-BART.GDT 4/29/08



PREP'D BY
L. Tran
APP'D BY
F. Wang
DATE
4/29/08
DWG FILE

PLASTICITY CHART AND DATA

SILICON VALLEY RAPID TRANSIT PROJECT
San Jose, California

FIGURE
4-6
PROJECT No
213213

PLASTICITY INDEX

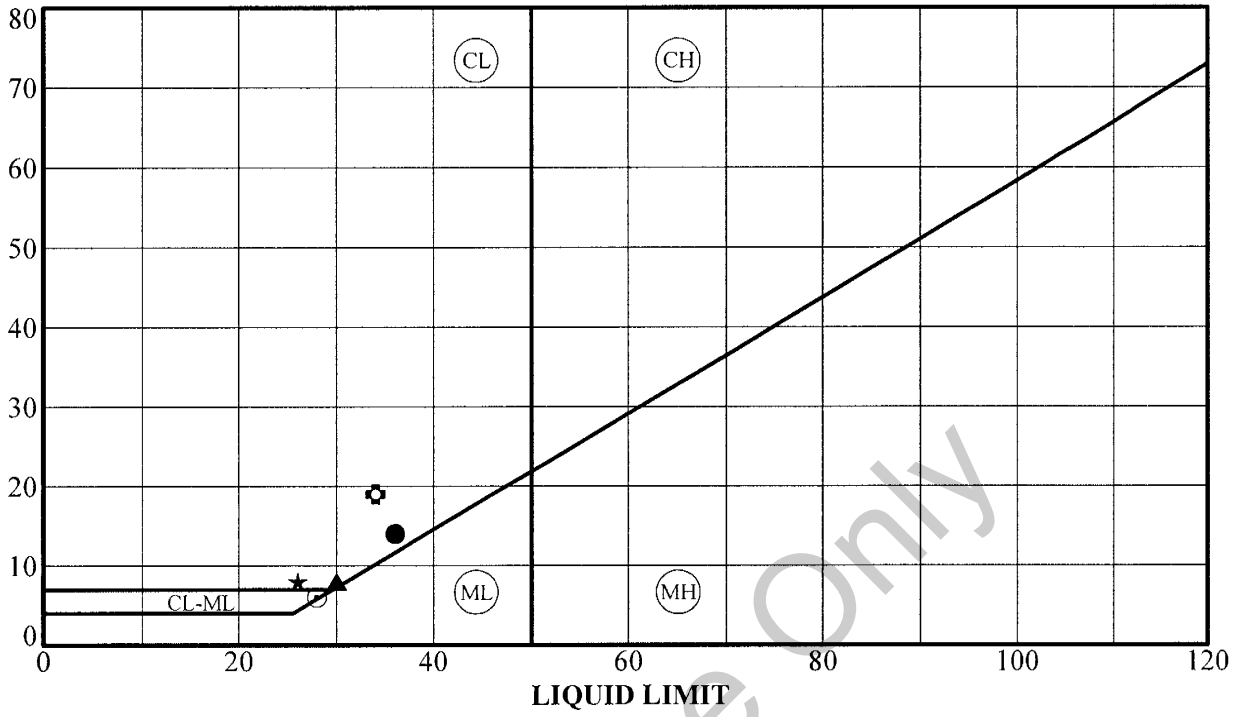

Key Symbol	Boring No.	Depth (Feet)	Liquid Limit (%)	Plasticity Index (%)	Liquidity Index	Water Content (%)	% Passing #200 Sieve	USCS
●	BH-090	29.0	36	14	0.100	23	89	CL
○	BH-090	34.0	NP	NP		28	70	ML
▲	BH-090	39.0	30	8	0.725	28	81	CL
★	BH-090	46.5	26	8	0.800	24	70	CL
⊙	BH-090	54.0	28	6	1.233	29	78	CL-ML
⊕	BH-090	58.5	34	19	0.353	22	65	CL

ATTERBERG SVRT_PHASE 2_041808.GPJ SVRT-BART.GDT 4/29/08

	PREP'D BY: L. Tran	PLASTICITY CHART AND DATA	FIGURE
	APP'D BY: F. Wang		4-7
	DATE: 4/29/08	SILICON VALLEY RAPID TRANSIT PROJECT San Jose, California	PROJECT No.
	DWG FILE		213213

See disclaimer on cover page.

PLASTICITY INDEX

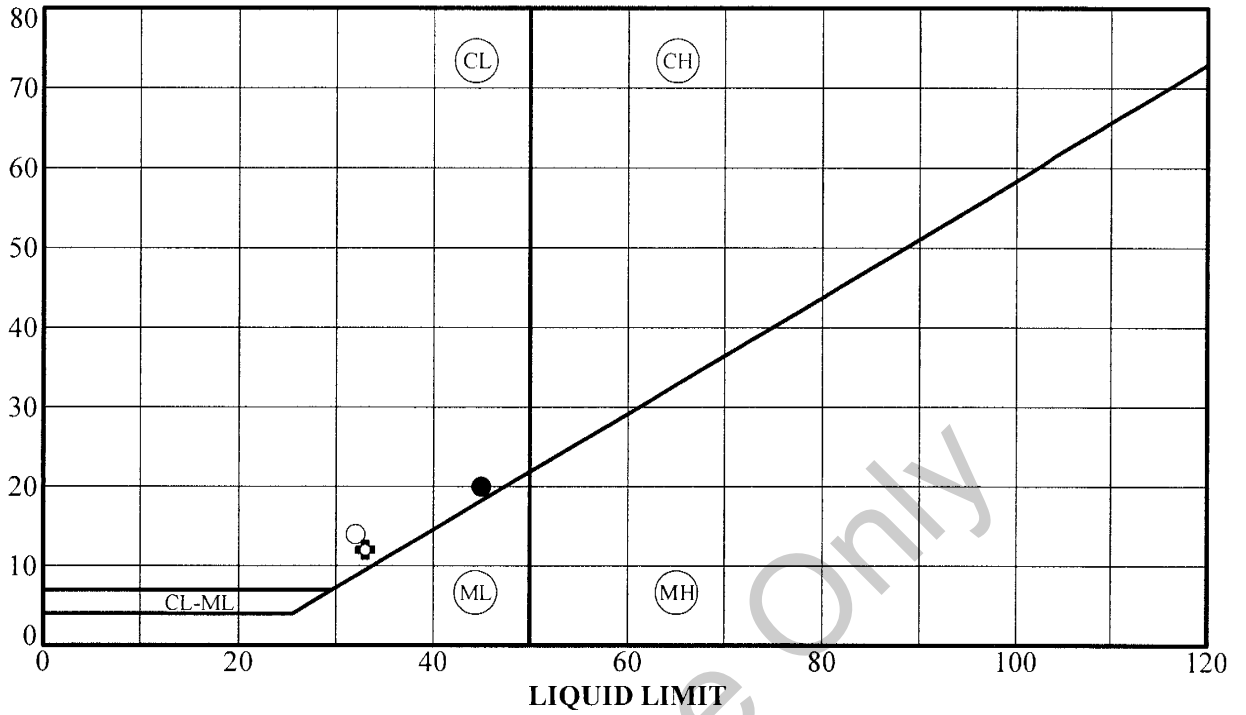

Key Symbol	Boring No.	Depth (Feet)	Liquid Limit (%)	Plasticity Index (%)	Liquidity Index	Water Content (%)	% Passing #200 Sieve	USCS
●	BH-091	22.5	45	20	0.650	38		CL
	BH-091	27.5	NP	NP				
	BH-091	29.0	NP	NP		24	37	SM
	BH-091	31.0	NP	NP		24	35	SM
	BH-091	32.5	NP	NP		17	9	SP-SM
⊕	BH-091	40.5	33	12			82	CL
○	BH-091	45.5	32	14			75	CL

ATTERBERG SVRT_PHASE 2_041808.GPJ SVRT-BART.GDT 4/29/08



PREP'D BY:
L. Tran
APP'D BY:
F. Wang
DATE:
4/29/08
DWG FILE:

PLASTICITY CHART AND DATA
SILICON VALLEY RAPID TRANSIT PROJECT
San Jose, California

FIGURE

4-8

PROJECT No.

213213

PLASTICITY INDEX

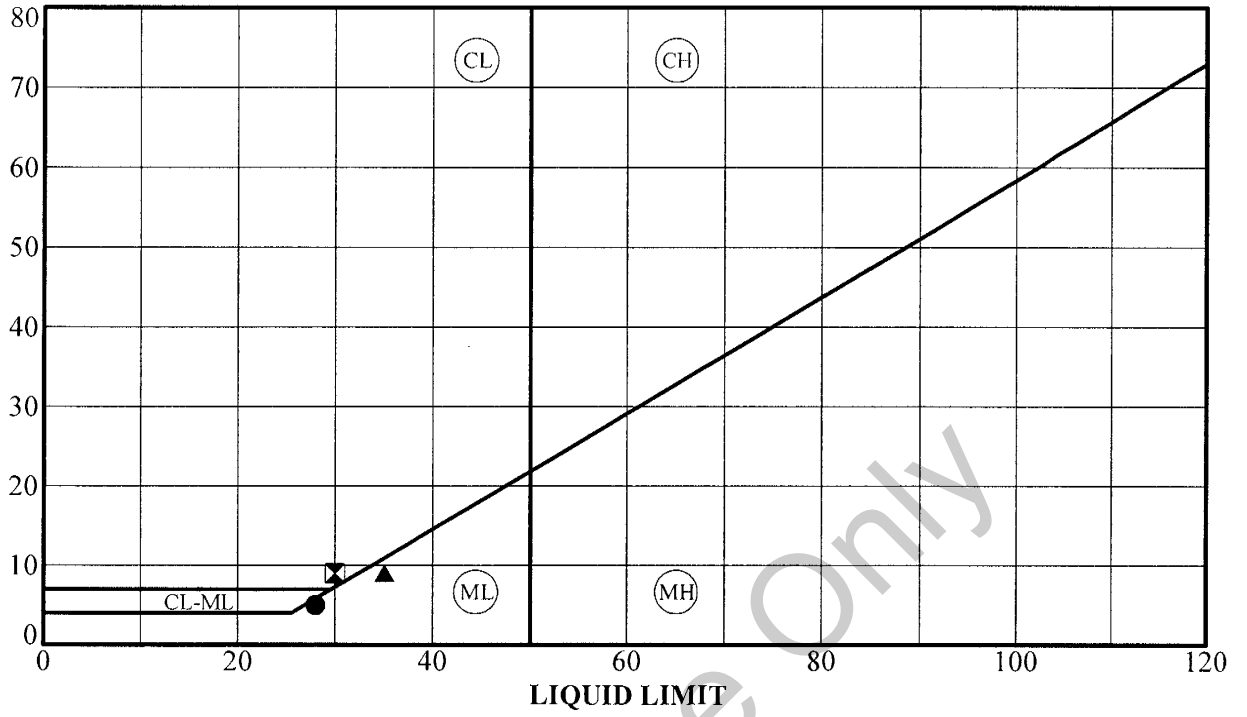

Key Symbol	Boring No.	Depth (Feet)	Liquid Limit (%)	Plasticity Index (%)	Liquidity Index	Water Content (%)	% Passing #200 Sieve	USCS
●	BH-093	52.5	28	5	-0.380	21		CL-ML
☒	BH-093	158.5	30	9	0.222	23	83	CL
▲	BH-093	200.0	35	9	0.100	27	75	ML

ATTERBERG SVRT_PHASE 2_041808 GPJ SVRT-BART.GDT 4/29/08



PREP'D BY
L. Tran
APP'D BY
F. Wang
DATE
4/29/08
DWG FILE

PLASTICITY CHART AND DATA

SILICON VALLEY RAPID TRANSIT PROJECT
San Jose, California

FIGURE
4-9
PROJECT No.
213213

PLASTICITY INDEX

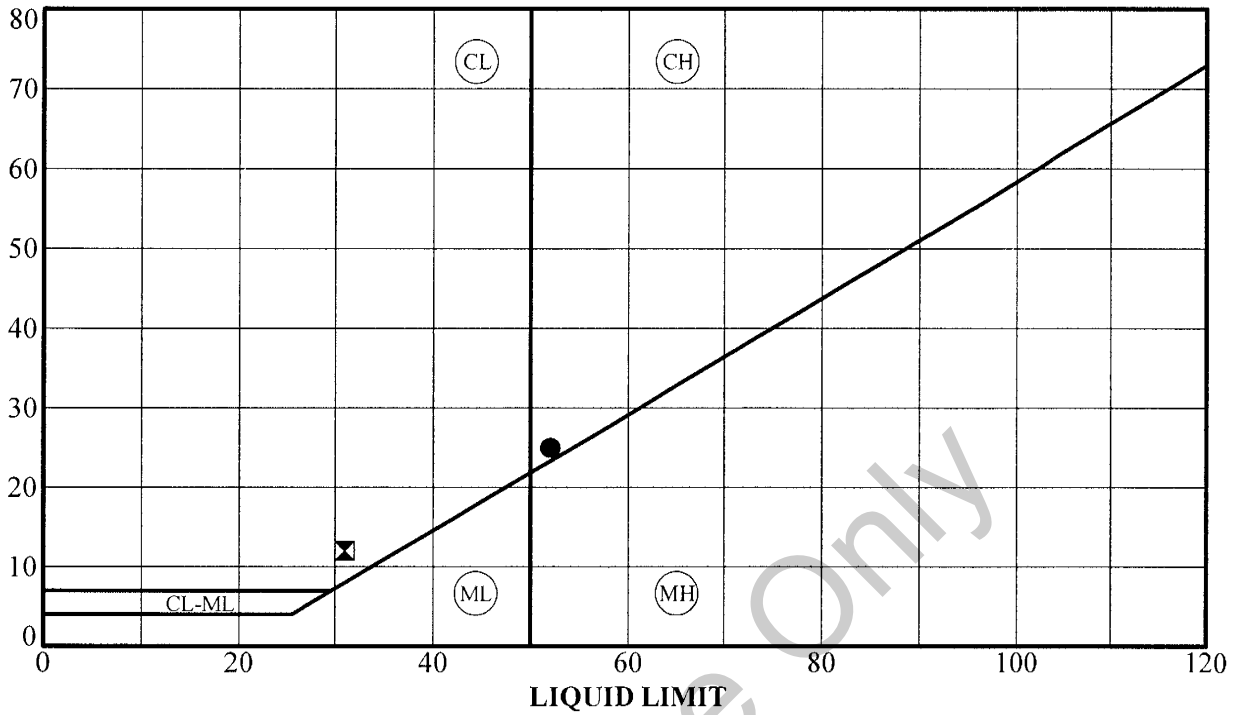

Key Symbol	Boring No.	Depth (Feet)	Liquid Limit (%)	Plasticity Index (%)	Liquidity Index	Water Content (%)	% Passing #200 Sieve	USCS
●	BH-101	22.5	52	25	0.560	41		CH
⊠	BH-101	37.5	31	12	0.133	21		CL

ATTERBERG SVRT_PHASE 2_041808 GPJ SVRT-BART.GDT 4/29/08



PREP'D BY
L. Tran
APP'D BY
F. Wang
DATE
4/29/08
DWG FILE

PLASTICITY CHART AND DATA
SILICON VALLEY RAPID TRANSIT PROJECT
San Jose, California

FIGURE
4-15
PROJECT No.
213213

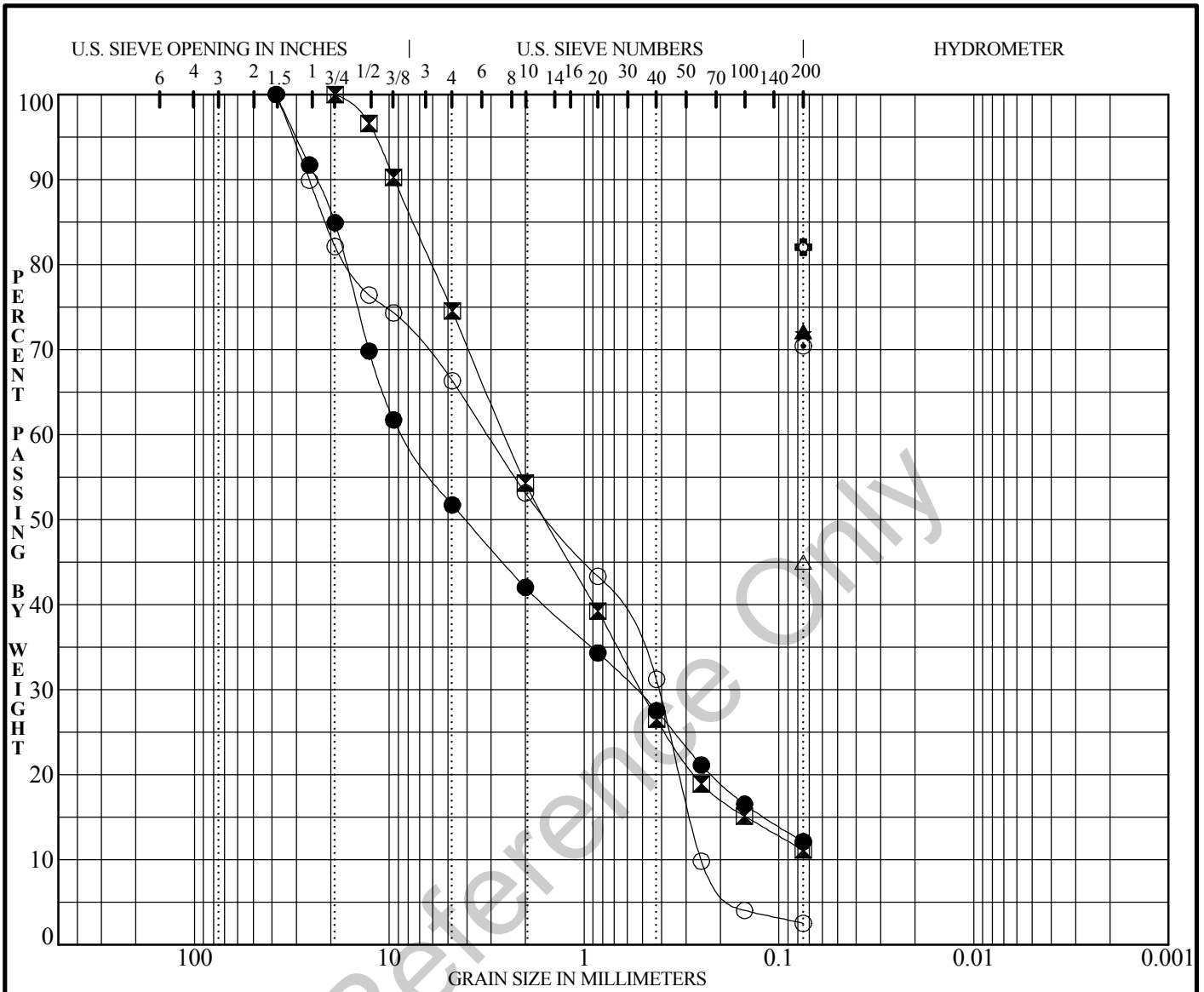

Cobbles	Gravel		Sand			Silt and Clay
	Coarse	Fine	Coarse	Medium	Fine	

Key Symbol	Boring No.	Depth (Feet)	% Passing No. 200 Sieve	% Passing No. 4 Sieve	Sample Description	USCS
●	BH-81	33.8	12	52	Silty GRAVEL with sand (GM)	GM
☒	BH-81	46.5	11	75	Well-graded SAND with clay and gravel (SW-SC)	SW-SC
▲	BH-81	65.0	72		Sandy Lean CLAY (CL)	CL
★	BH-81	80.0	72		Sandy SILT (ML)	ML
⊙	BH-81	84.5	70		Sandy Lean CLAY (CL)	CL
⊕	BH-81	98.7	82		Lean CLAY with sand (CL)	CL
○	BH-81	117.8	3	66	Poorly-graded SAND with gravel (SP)	SP
△	BH-81	125.2	45		Silty SAND (SM)/ Sandy SILT (ML)	SM/ML



PREP'D BY:
 APP'D BY:
 Y. D. Wang
 DATE:
 4/29/08
 DWG FILE:

GRADATION TEST DATA
SILICON VALLEY RAPID TRANSIT PROJECT
San Jose, California

FIGURE

4- 19a

PROJECT No.

213213

GRADATION_B ALTERNATE SVRT_PHASE 2_041808.GPJ SVRT-BART.GDT 4/29/08

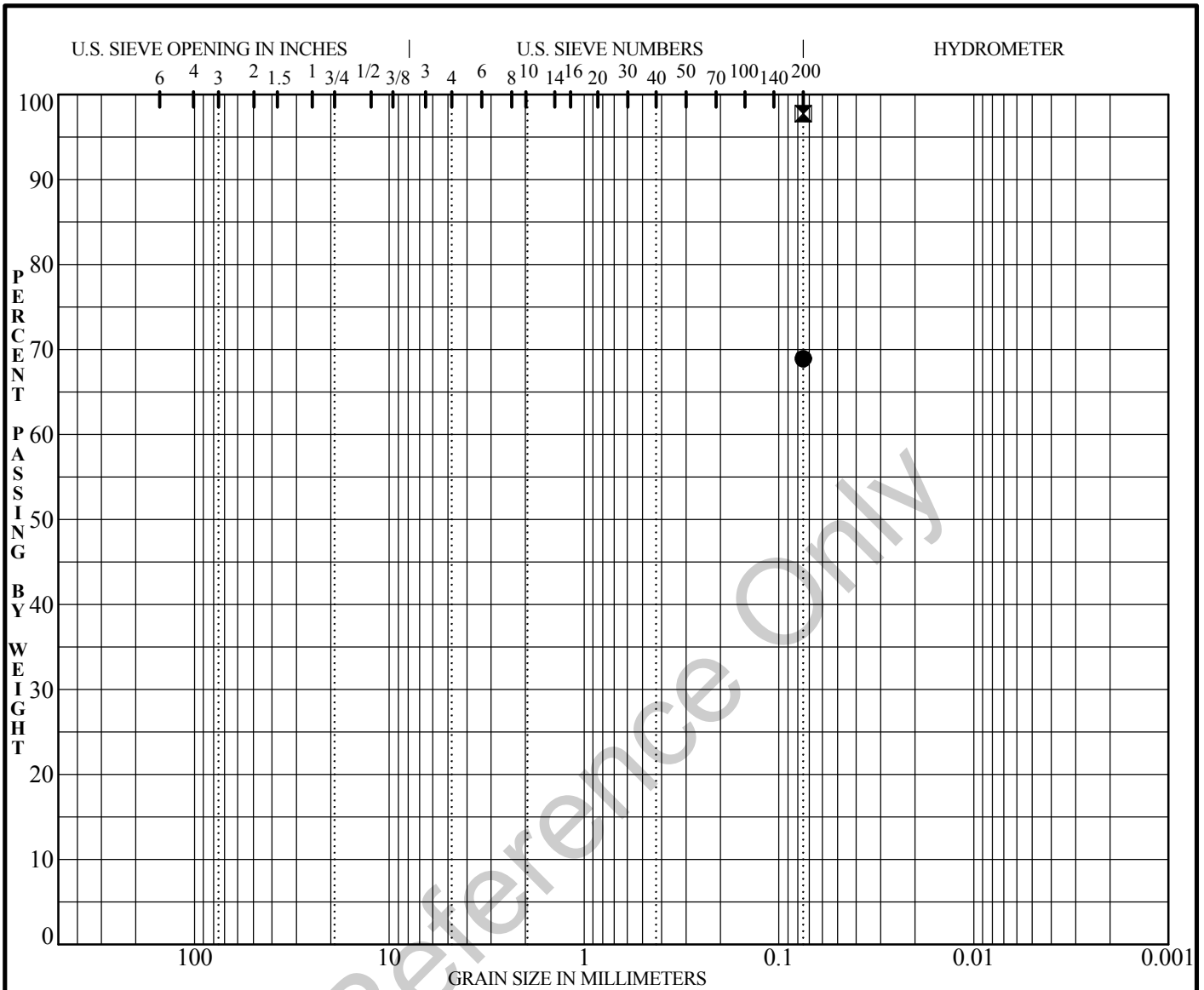

Cobbles	Gravel		Sand			Silt and Clay
	Coarse	Fine	Coarse	Medium	Fine	

Key Symbol	Boring No.	Depth (Feet)	% Passing No. 200 Sieve	% Passing No. 4 Sieve	Sample Description	USCS
●	BH-81	130.2	69		Sandy Lean CLAY (CL)	CL
☒	BH-81	141.5	98		Lean CLAY (CL)	CL

GRADATION_B ALTERNATE SVRT_PHASE 2_041808.GPJ SVRT-BART.GDT 4/29/08

	PREP'D BY:	GRADATION TEST DATA SILICON VALLEY RAPID TRANSIT PROJECT San Jose, California	FIGURE
	APP'D BY: Y. D. Wang		A4-19b
	DATE: 4/29/08		PROJECT No.
	DWG FILE:		213213

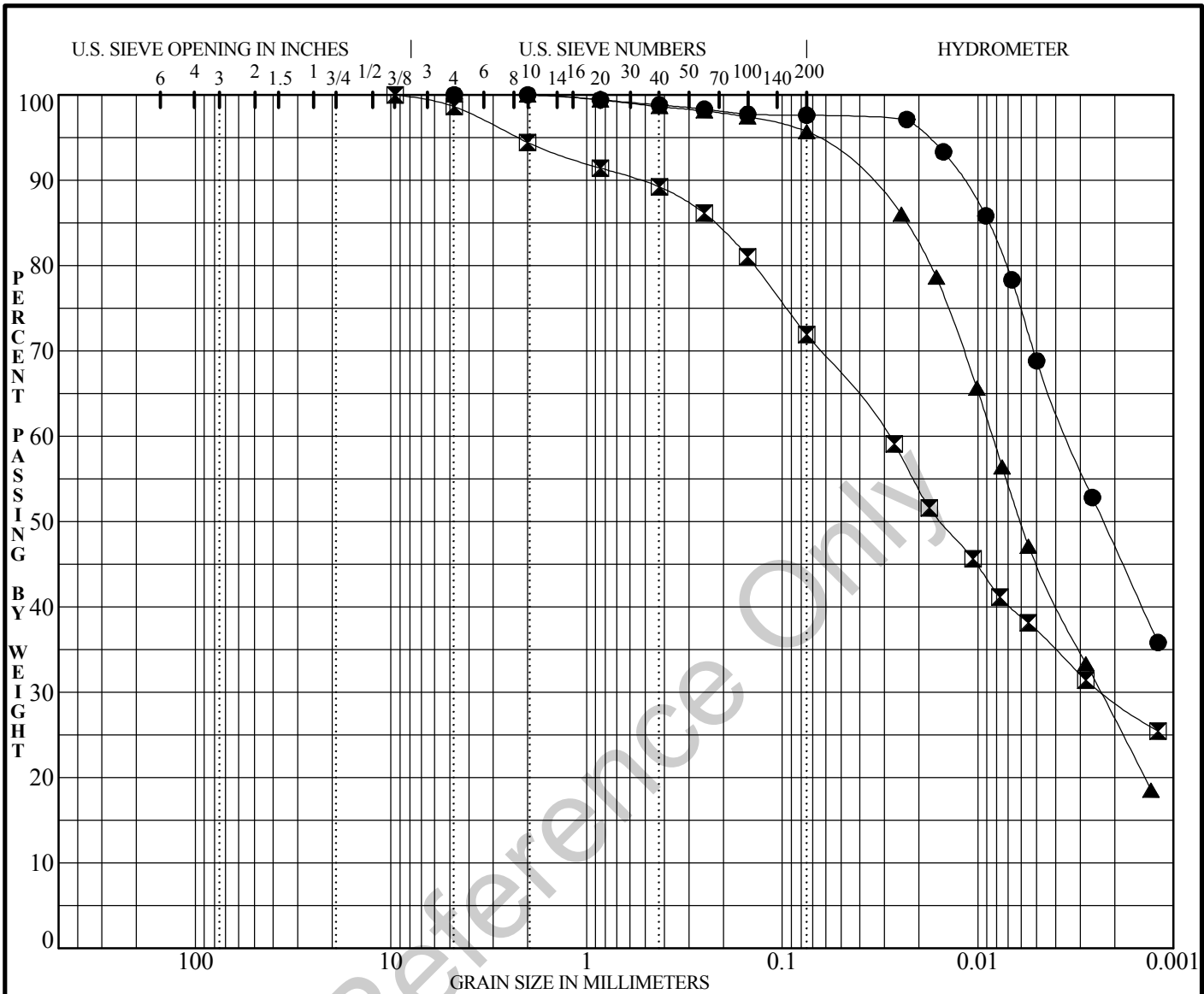

Cobbles	Gravel		Sand			Silt and Clay
	Coarse	Fine	Coarse	Medium	Fine	

Key Symbol	Boring No.	Depth (Feet)	% Passing No. 200 Sieve	% Passing No. 4 Sieve	Sample Description	USCS
●	BH-82	22.5	98	100	Lean CLAY (CL)	CL
☒	BH-82	42.5	72	99	Lean CLAY with sand (CL)	CL
▲	BH-82	67.5	96	100	SILT (ML)	ML

GRADATION_B SVRT_PHASE 2_041808.GPJ SVRT-BART.GDT 4/29/08



PREP'D BY:
L. Tran
APP'D BY:
F. Wang
DATE:
4/29/08
DWG FILE:

GRADATION TEST DATA
SILICON VALLEY RAPID TRANSIT PROJECT
San Jose, California

FIGURE
4-20
PROJECT No.
213213

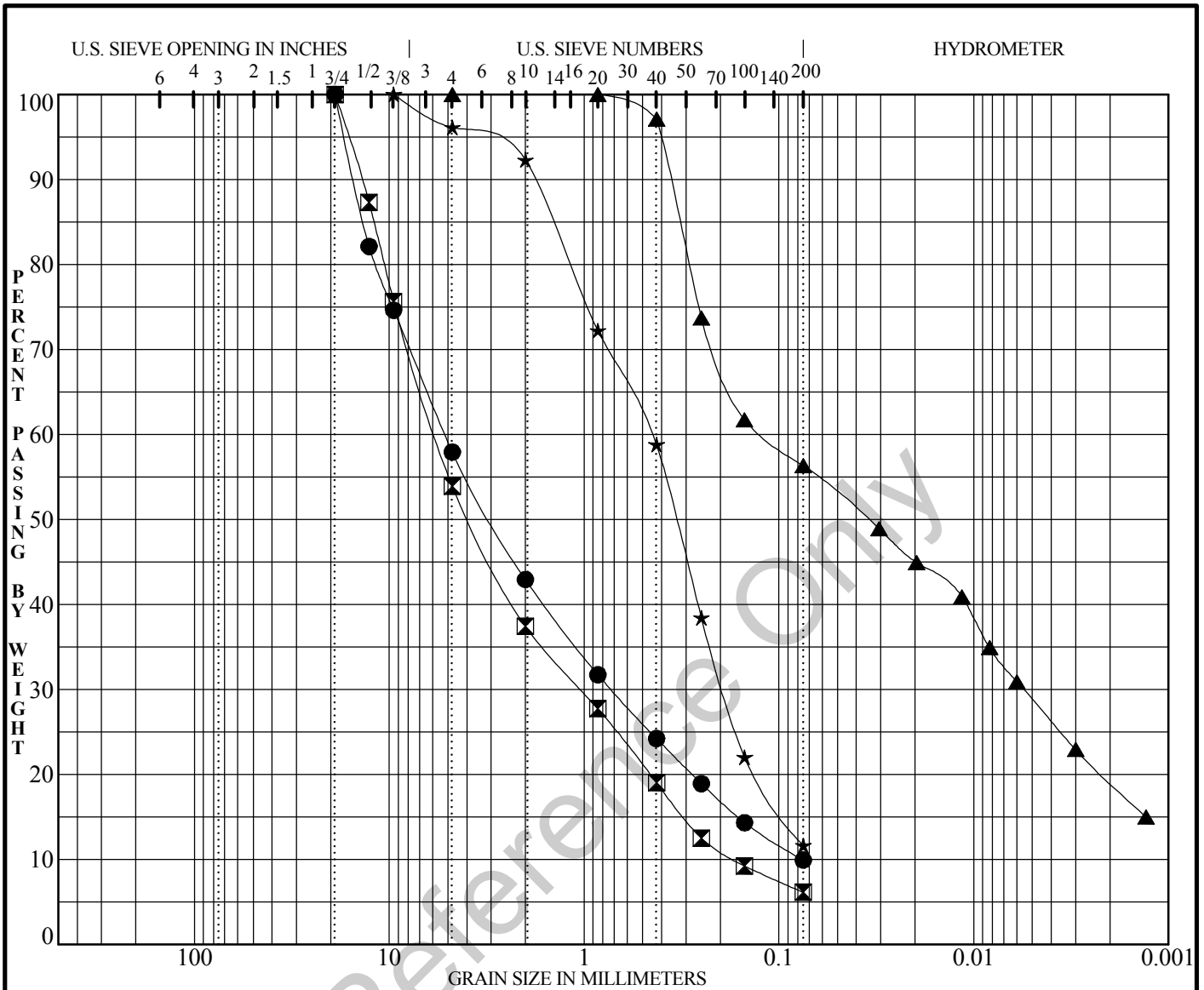

Cobbles	Gravel		Sand			Silt and Clay
	Coarse	Fine	Coarse	Medium	Fine	

Key Symbol	Boring No.	Depth (Feet)	% Passing No. 200 Sieve	% Passing No. 4 Sieve	Sample Description	USCS
●	BH-84	82.5	10	58	Well-graded SAND with clay and gravel (SW-SC)	SW-SC
◻	BH-84	111.5	6	54	Well-graded SAND with silt and gravel (SW-SM)	SW-SM
▲	BH-84	131.5	56	100	Sandy Lean CLAY (CL)	CL
★	BH-84	141.0	12	96	Well-graded SAND with silt (SW-SM)	SW-SM

GRADATION_B SVRT_PHASE 2_041808.GPJ SVRT-BART.GDT 4/29/08



PREP'D BY:
L. Tran
APP'D BY:
F. Wang
DATE:
4/29/08
DWG FILE:

GRADATION TEST DATA

SILICON VALLEY RAPID TRANSIT PROJECT
San Jose, California

FIGURE

4-21

PROJECT No.
213213

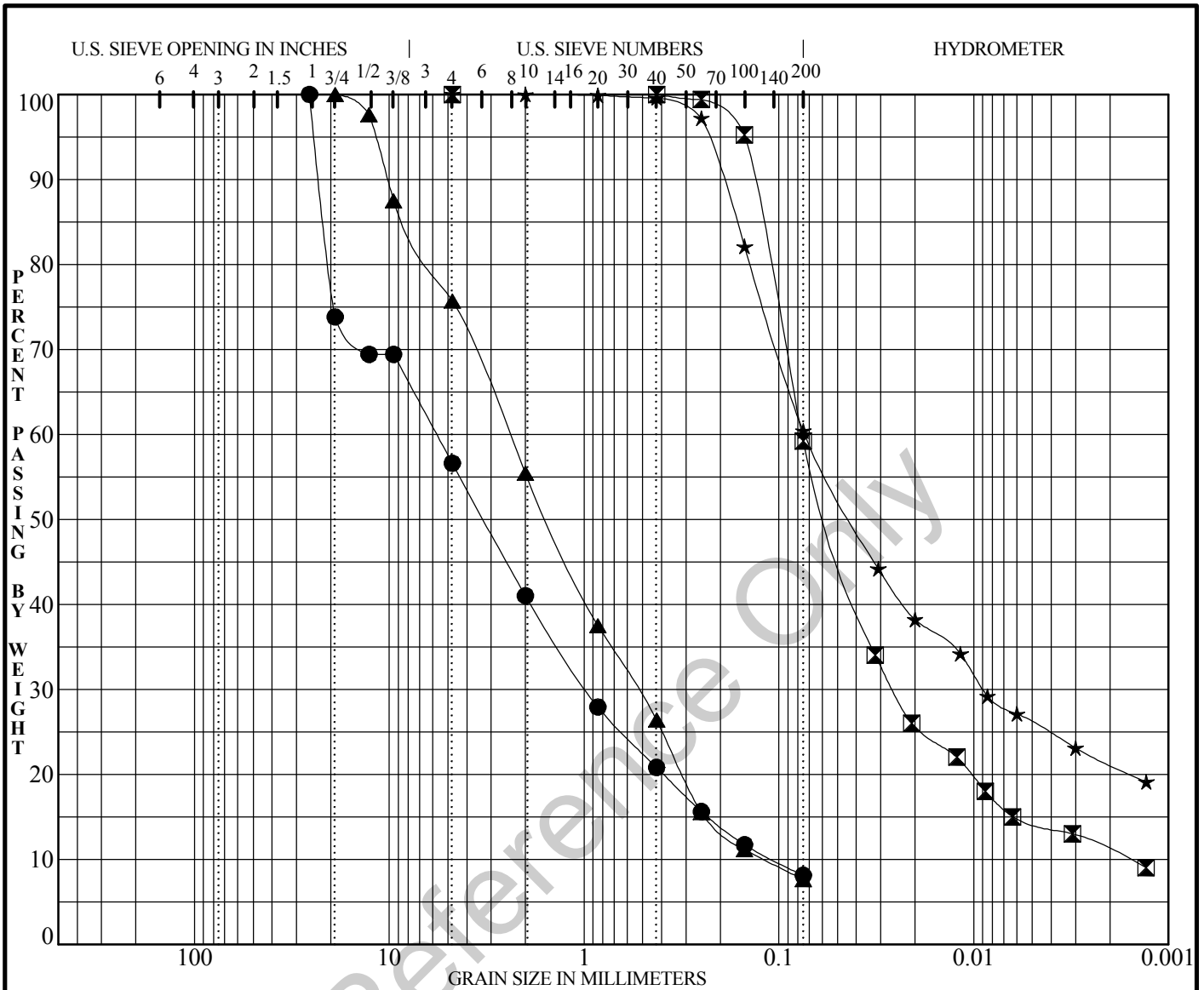

Cobbles	Gravel		Sand			Silt and Clay
	Coarse	Fine	Coarse	Medium	Fine	

Key Symbol	Boring No.	Depth (Feet)	% Passing No. 200 Sieve	% Passing No. 4 Sieve	Sample Description	USCS
●	BH-85	86.5	8	57	Well-graded SAND with clay and gravel (SW-SC)	SW-SC
☒	BH-85	102.5	59	100	Sandy SILT (ML)	ML
▲	BH-85	121.5	8	76	Poorly-graded SAND with clay and gravel (SP-SC)	SP-SC
★	BH-85	192.5	60	100	Sandy Lean CLAY (CL)	CL

GRADATION_B SVRT_PHASE 2_041808.GPJ SVRT-BART.GDT 4/29/08



PREP'D BY:
L. Tran
APP'D BY:
F. Wang
DATE:
4/29/08
DWG FILE:

GRADATION TEST DATA
SILICON VALLEY RAPID TRANSIT PROJECT
San Jose, California

FIGURE
4-22
PROJECT No.
213213

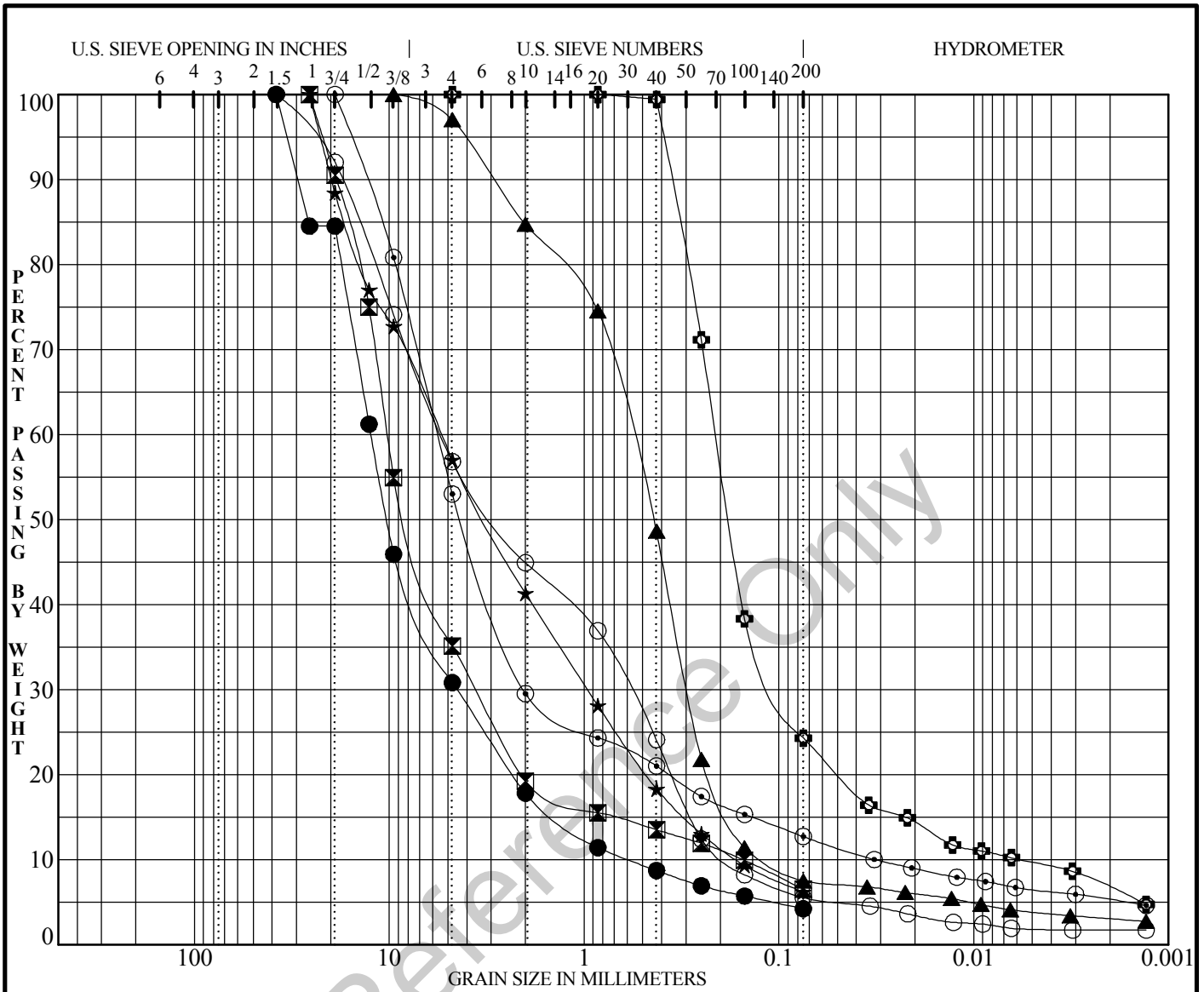

Cobbles	Gravel		Sand			Silt and Clay
	Coarse	Fine	Coarse	Medium	Fine	

Key Symbol	Boring No.	Depth (Feet)	% Passing No. 200 Sieve	% Passing No. 4 Sieve	Sample Description	USCS
●	BH-87	71.5	4	31	Well-graded GRAVEL (GW)	GW
⊠	BH-87	79.0	7	35	Poorly-graded GRAVEL with clay and sand (GP-GC)	GP-GC
▲	BH-87	86.5	8	97	Poorly-graded SAND with silt (SP-SM)	SP-SM
★	BH-87	121.5	6	57	Well-graded SAND with silt and gravel (SW-SM)	SW-SM
⊙	BH-87	137.5	13	53	Clayey GRAVEL with sand (GC)	GC
⊕	BH-87	157.5	24	100	Silty SAND (SM)	SM
○	BH-87	181.0	6	57	Poorly-graded SAND with silt and gravel (SP-SM)	SP-SM

GRADATION_B SVRT_PHASE 2_041808.GPJ SVRT-BART.GDT 4/29/08

	PREP'D BY: L. Tran	GRADATION TEST DATA SILICON VALLEY RAPID TRANSIT PROJECT San Jose, California	FIGURE
	APP'D BY: F. Wang		4-23
	DATE: 4/29/08		PROJECT No.
	DWG FILE:		213213

See disclaimer on cover page.

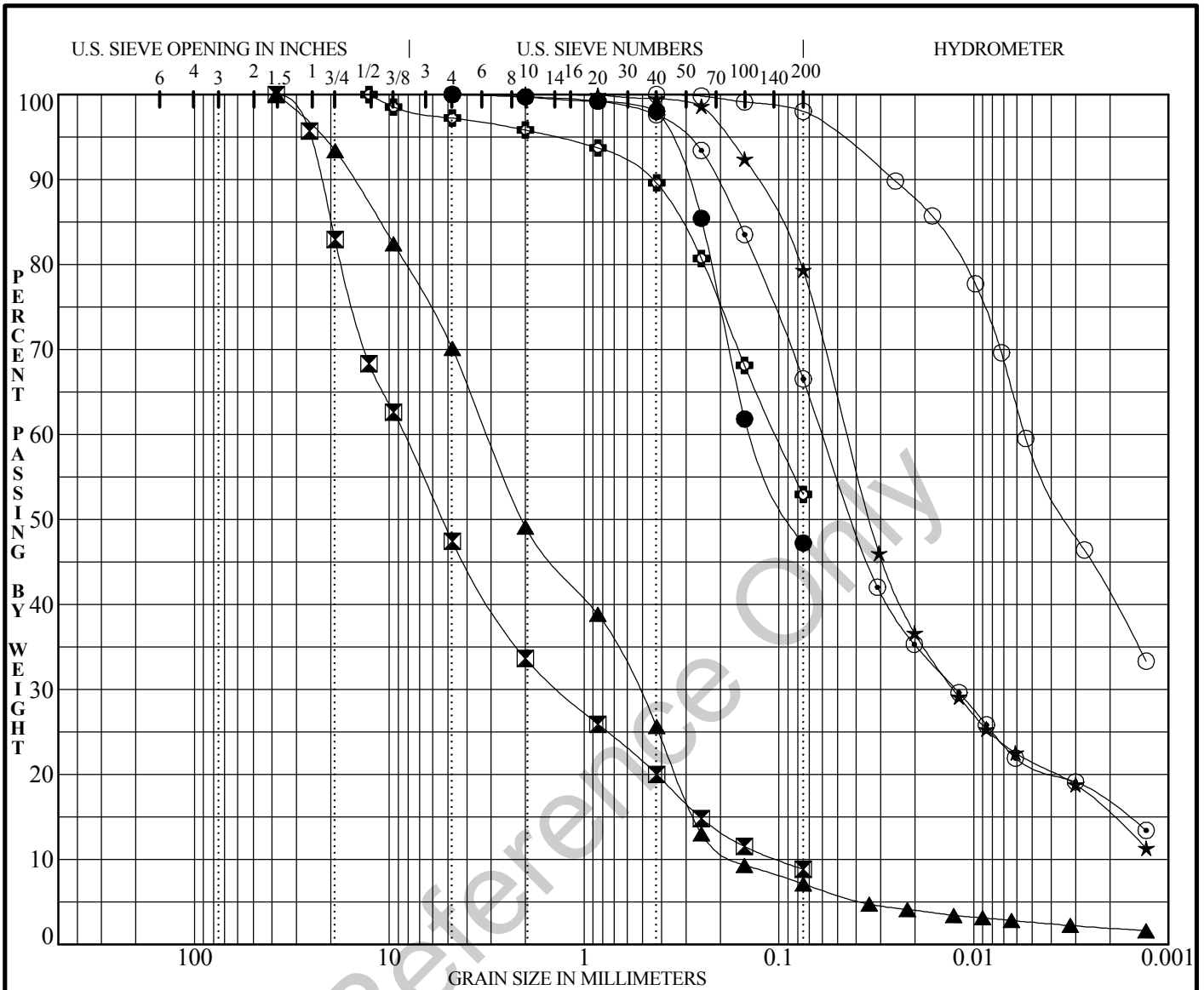

Cobbles	Gravel		Sand			Silt and Clay
	Coarse	Fine	Coarse	Medium	Fine	

Key Symbol	Boring No.	Depth (Feet)	% Passing No. 200 Sieve	% Passing No. 4 Sieve	Sample Description	USCS
●	BH-89	41.5	47	100	Silty SAND (SM)	SM
⊠	BH-89	51.5	9	47	Well-graded GRAVEL with silt and sand (GW-GM)	GW-GM
▲	BH-89	81.5	7	70	Poorly-graded SAND with silt and gravel (SP-SM)	SP-SM
★	BH-89	147.5	79	100	SILT with sand (ML)	ML
⊙	BH-89	161.5	67	100	Sandy Lean CLAY (CL)	CL
⊕	BH-89	172.5	53	97	Sandy SILT (ML)	ML
○	BH-89	191.5	98	100	Lean CLAY (CL)	CL

GRADATION_B SVRT_PHASE 2_041808.GPJ SVRT-BART.GDT 4/29/08

	PREP'D BY: L. Tran	GRADATION TEST DATA SILICON VALLEY RAPID TRANSIT PROJECT San Jose, California	FIGURE
	APP'D BY: F. Wang		4-25
	DATE: 4/29/08		PROJECT No.
	DWG FILE:		213213

See disclaimer on cover page.

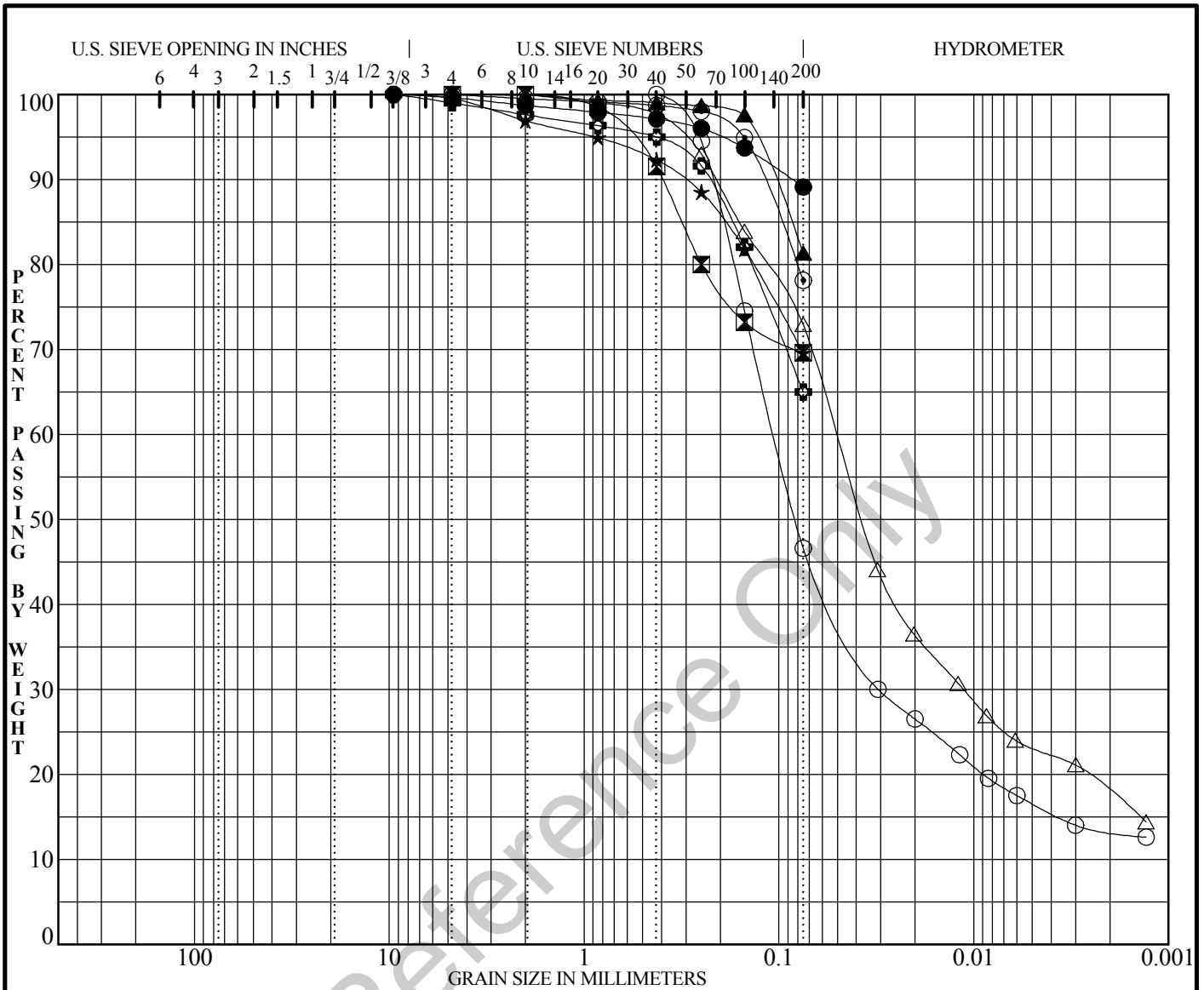

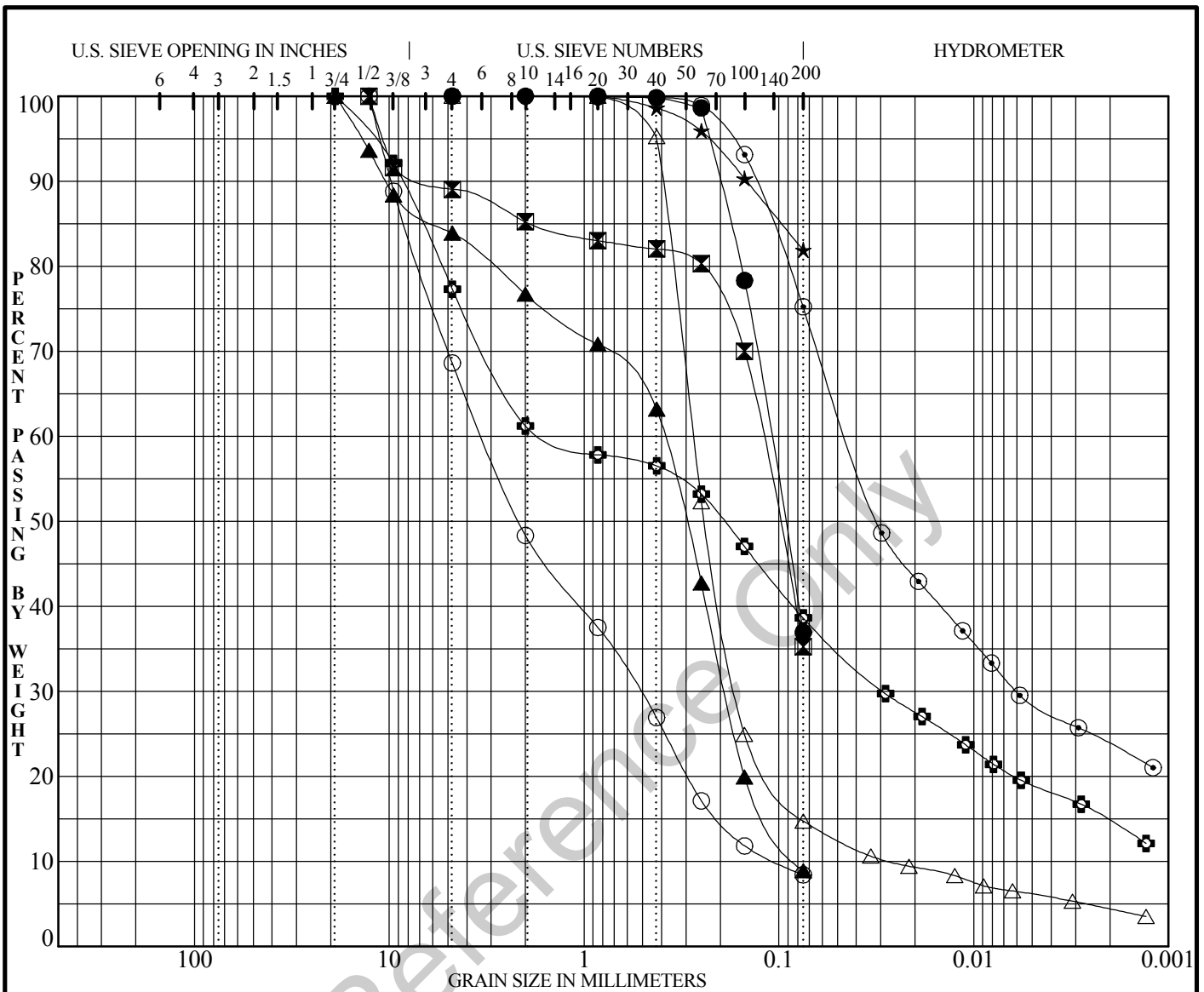

Cobbles	Gravel		Sand			Silt and Clay
	Coarse	Fine	Coarse	Medium	Fine	

Key Symbol	Boring No.	Depth (Feet)	% Passing No. 200 Sieve	% Passing No. 4 Sieve	Sample Description	USCS
●	BH-91	29.0	37	100	Silty SAND (SM)	SM
⊠	BH-91	31.0	35	89	Silty SAND (SM)	SM
▲	BH-91	32.5	9	84	Poorly-graded SAND with silt and gravel (SP-SM)	SP-SM
★	BH-91	40.5	82	100	Lean CLAY (CL)	CL
⊙	BH-91	45.5	75	100	Lean CLAY (CL)	CL
⊕	BH-91	142.5	39	77	Clayey SAND with gravel (SC)	SC
○	BH-91	146.0	8	69	Poorly-graded SAND with silt and gravel (SP-SM)	SP-SM
△	BH-91	156.5	15	100	Silty SAND (SM)	SM

GRADATION_B ALTERNATE SVRT_PHASE 2_041808.GPJ SVRT-BART.GDT 4/29/08

	PREP'D BY: L. Tran	GRADATION TEST DATA SILICON VALLEY RAPID TRANSIT PROJECT San Jose, California	FIGURE
	APP'D BY: F. Wang		A4-27a
	DATE: 4/29/08		PROJECT No.
	DWG FILE:		213213

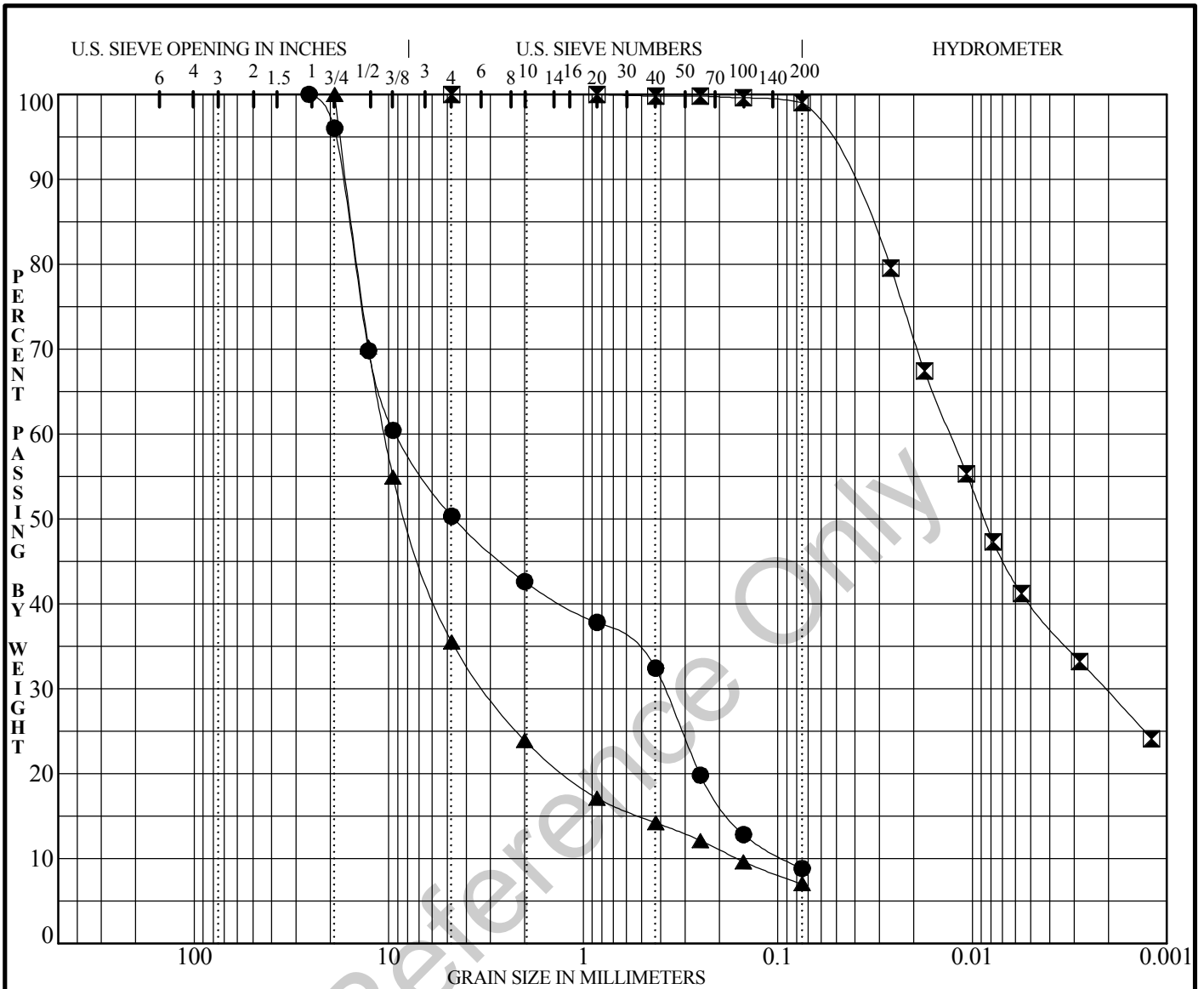

Cobbles	Gravel		Sand			Silt and Clay
	Coarse	Fine	Coarse	Medium	Fine	

Key Symbol	Boring No.	Depth (Feet)	% Passing No. 200 Sieve	% Passing No. 4 Sieve	Sample Description	USCS
●	BH-91	176.5	9	50	Poorly-graded GRAVEL with silt and sand (GP-GM)	GP-GM
☒	BH-91	182.5	99	100	Lean CLAY (CL)	CL
▲	BH-91	196.5	7	36	Poorly-graded GRAVEL with clay and sand (GP-GC)	GP-GC

GRADATION_B ALTERNATE SVRT_PHASE 2_041808.GPJ SVRT-BART.GDT 4/29/08

	PREP'D BY: L. Tran	GRADATION TEST DATA SILICON VALLEY RAPID TRANSIT PROJECT San Jose, California	FIGURE
	APP'D BY: F. Wang		A4-27b
	DATE: 4/29/08		PROJECT No.
	DWG FILE:		213213

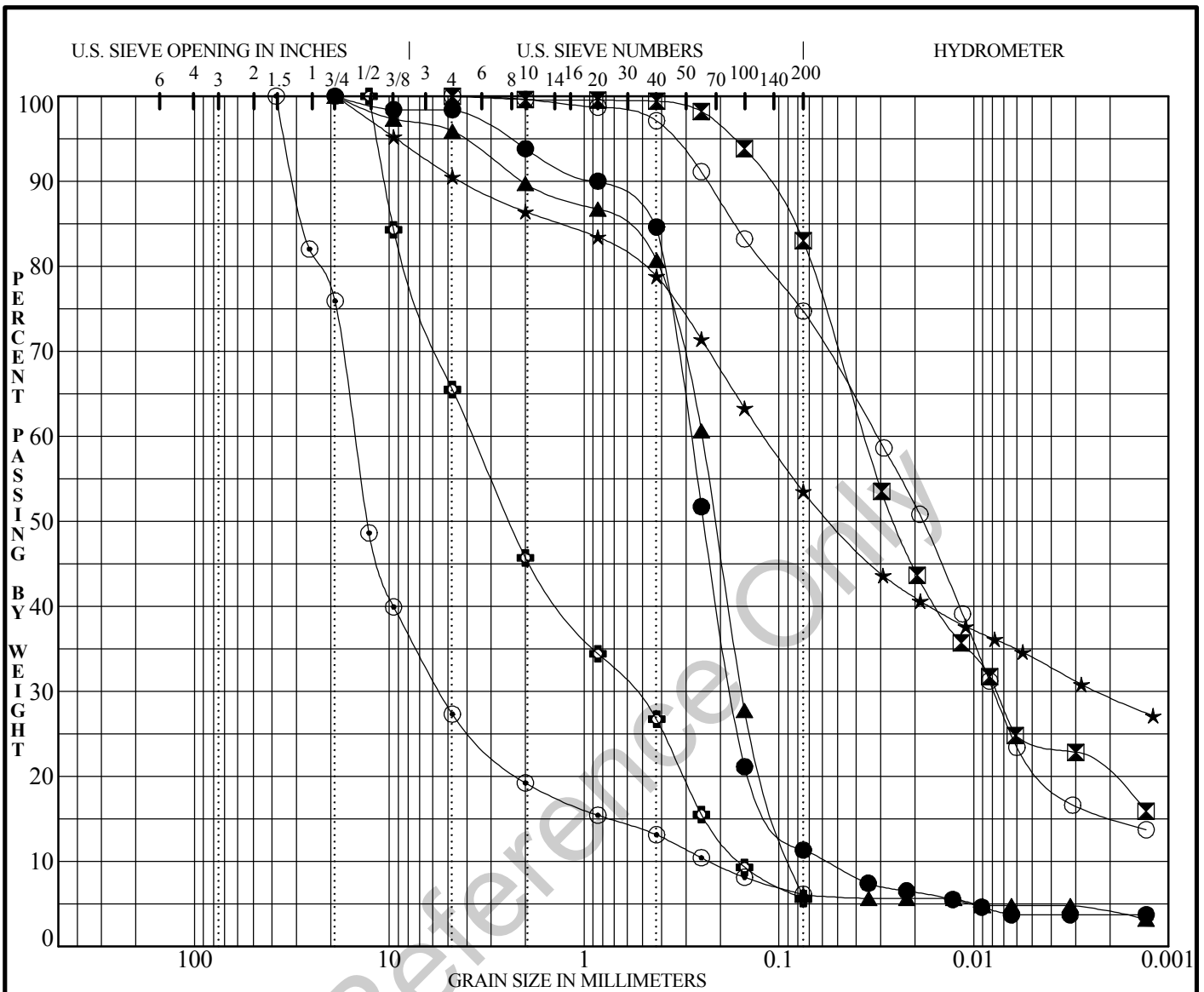

Cobbles	Gravel		Sand			Silt and Clay
	Coarse	Fine	Coarse	Medium	Fine	

Key Symbol	Boring No.	Depth (Feet)	% Passing No. 200 Sieve	% Passing No. 4 Sieve	Sample Description	USCS
●	BH-93	101.5	11	98	Poorly-graded SAND with silt (SP-SM)	SP-SM
⊠	BH-93	158.5	83	100	Lean CLAY with sand (CL)	CL
▲	BH-93	164.7	6	96	Poorly-graded SAND with silt (SP-SM)	SP-SM
★	BH-93	169.7	54	91	Sandy Lean CLAY (CL)	CL
⊙	BH-93	173.2	6	27	Poorly-graded GRAVEL with silt and sand (GP-GM)	GP-GM
⊕	BH-93	181.8	6	66	Poorly-graded SAND with silt and gravel (SP-SM)	SP-SM
○	BH-93	200.0	75	100	SILT with sand (ML)	ML

GRADATION_B SVRT_PHASE 2_04:1808.GPJ SVRT-BART.GDT 4/29/08



PREP'D BY:
L. Tran
APP'D BY:
F. Wang
DATE:
4/29/08
DWG FILE:

GRADATION TEST DATA
SILICON VALLEY RAPID TRANSIT PROJECT
San Jose, California

FIGURE
4-28
PROJECT No.
213213

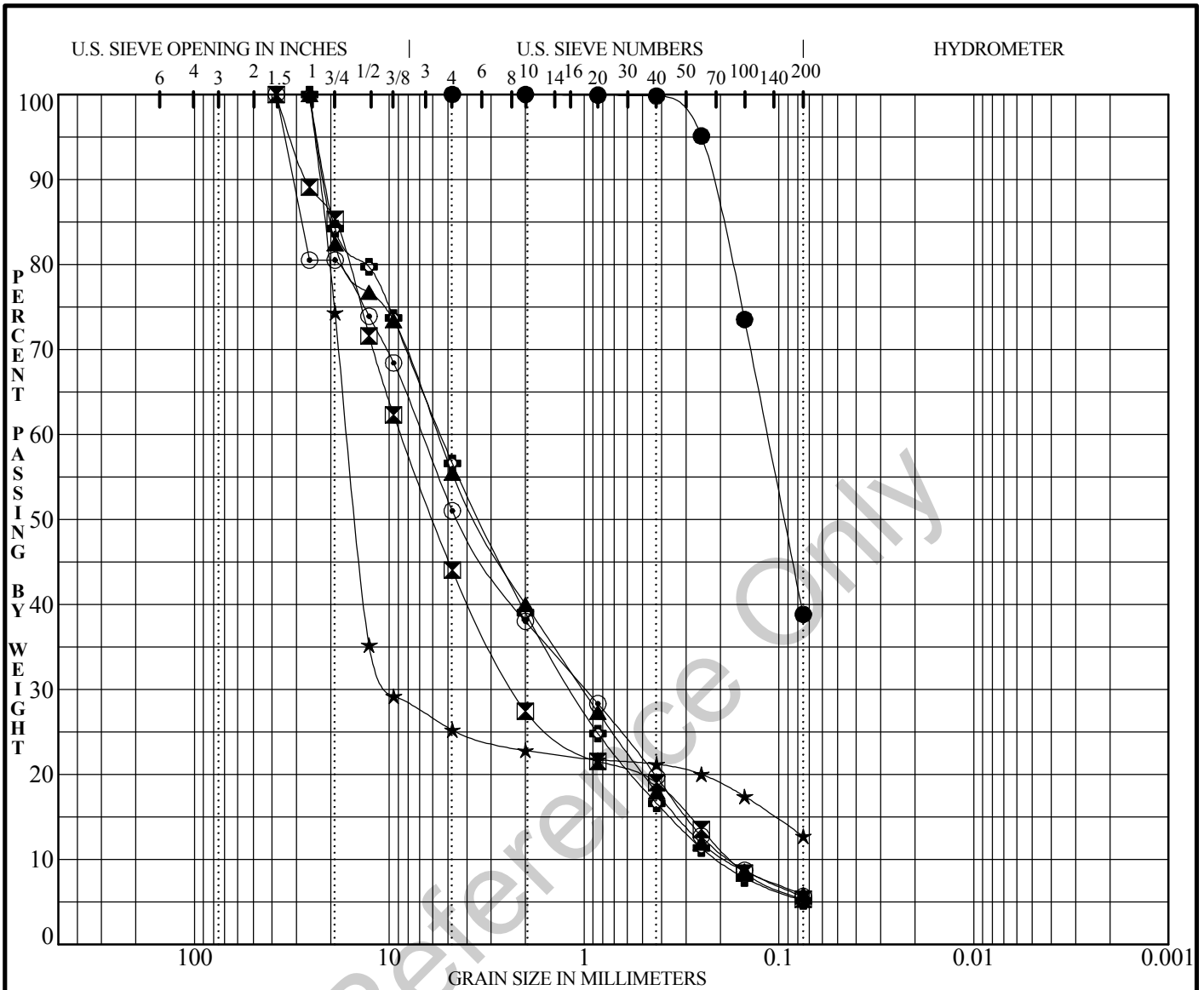

Cobbles	Gravel		Sand			Silt and Clay
	Coarse	Fine	Coarse	Medium	Fine	

Key Symbol	Boring No.	Depth (Feet)	% Passing No. 200 Sieve	% Passing No. 4 Sieve	Sample Description	USCS
●	BH-95	32.5	39	100	Silty SAND (SM)	SM
☒	BH-95	39.0	5	44	Poorly-graded GRAVEL with silt and sand (GP-GM)	GP-GM
▲	BH-95	59.0	6	55	Poorly-graded SAND with silt and gravel (SP-SM)	SP-SM
★	BH-95	64.0	13	25	Silty GRAVEL (GM)	GM
⊙	BH-95	69.0	6	51	Poorly-graded GRAVEL with silt and sand (GP-GM)	GP-GM
⊕	BH-95	79.0	5	57	Well-graded SAND with silt and gravel (SW-SM)	SW-SM

GRADATION_B SVRT_PHASE 2_041808.GPJ SVRT-BART.GDT 4/29/08

	PREP'D BY: L. Tran	GRADATION TEST DATA SILICON VALLEY RAPID TRANSIT PROJECT San Jose, California	FIGURE
	APP'D BY: F. Wang		4-29
	DATE: 4/29/08		PROJECT No.
	DWG FILE:		213213

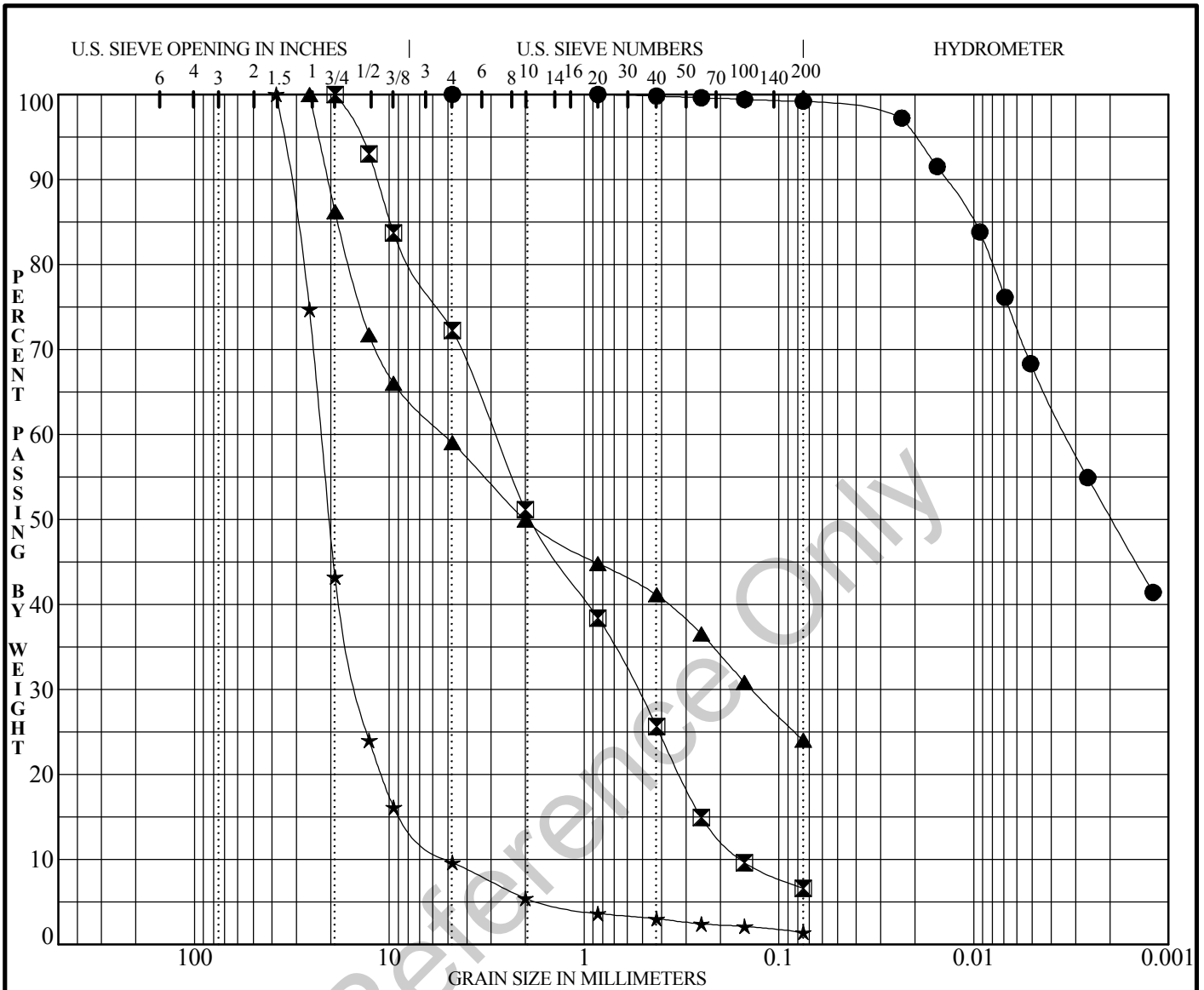

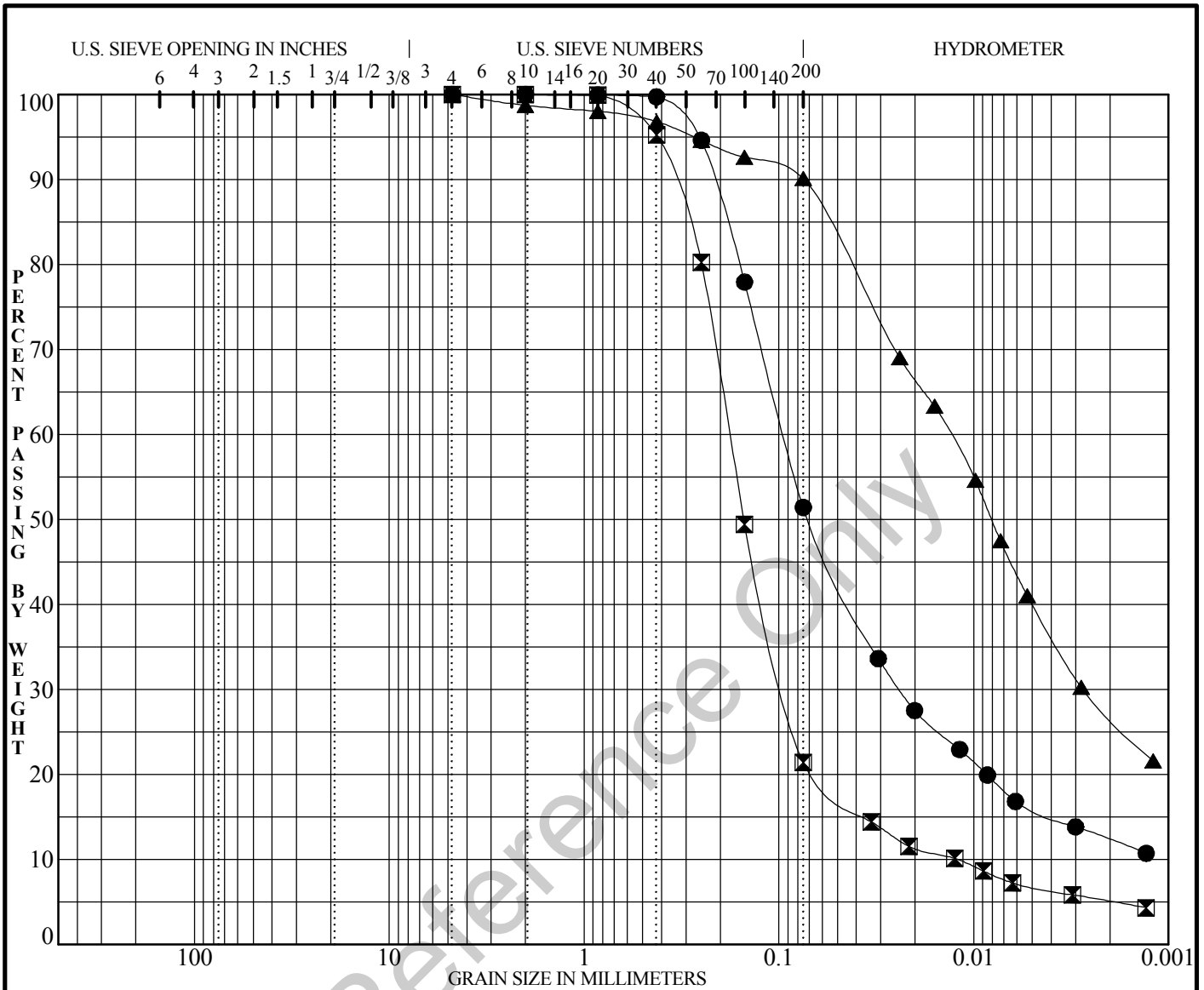

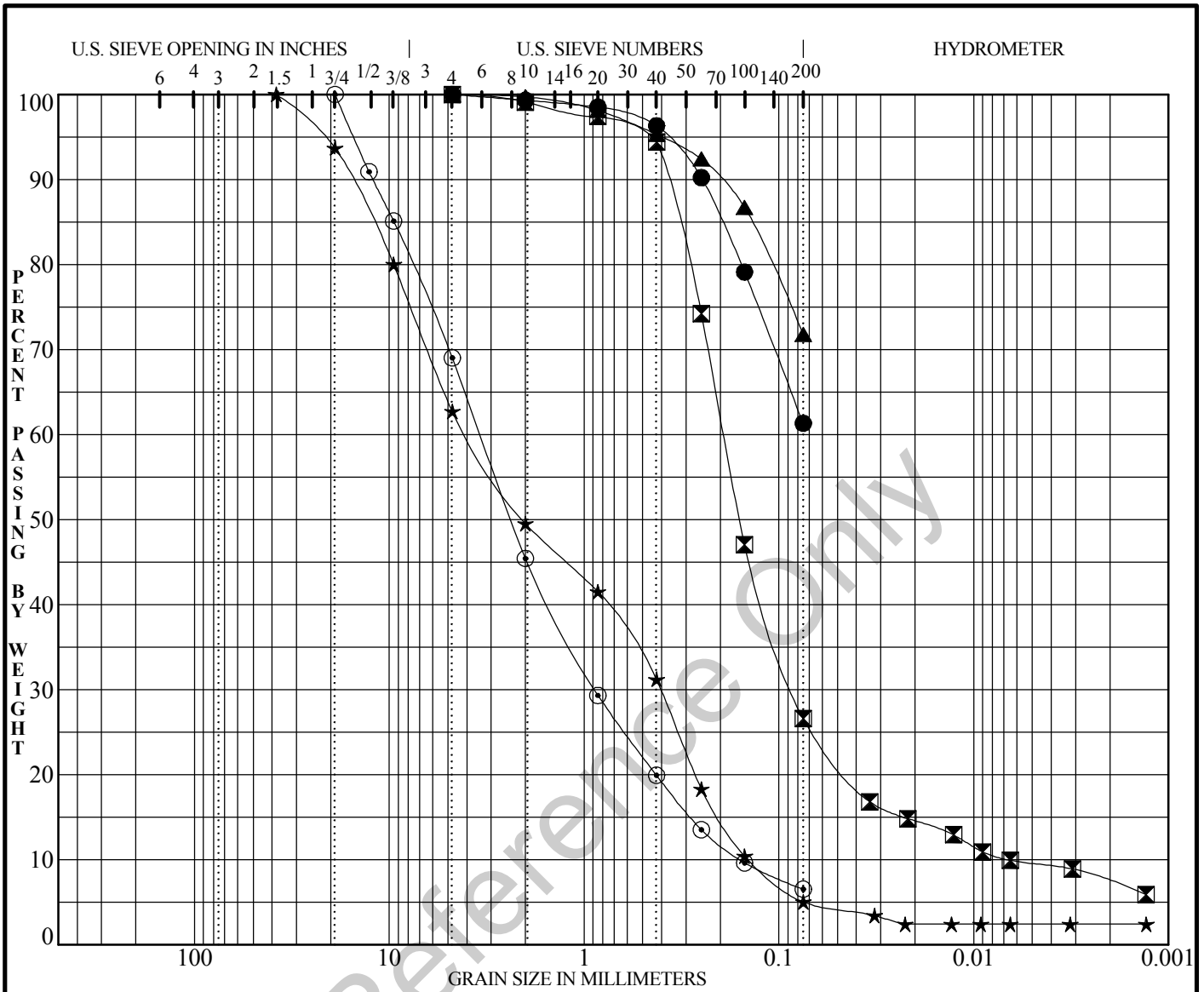

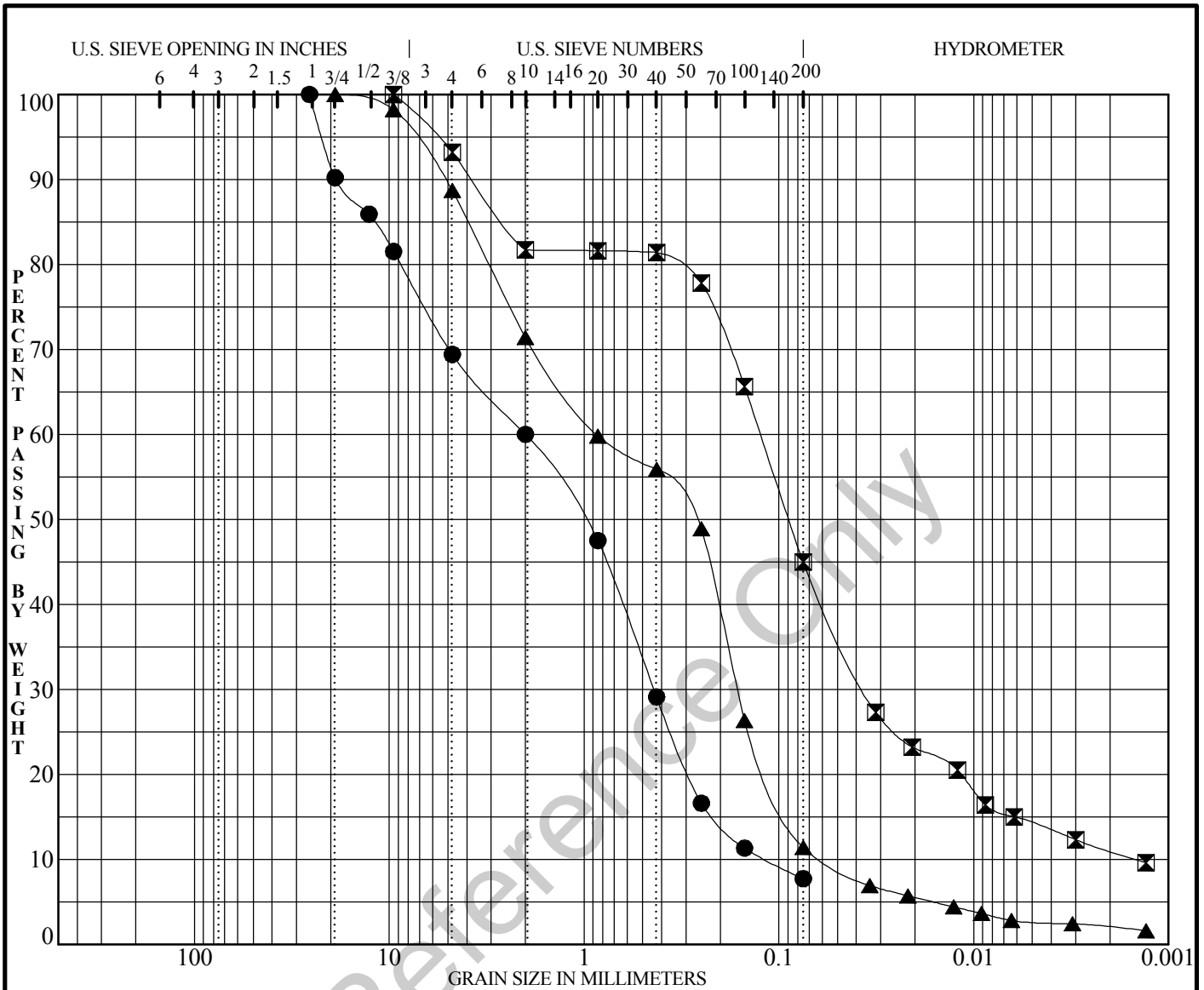

Cobbles	Gravel		Sand			Silt and Clay
	Coarse	Fine	Coarse	Medium	Fine	

Key Symbol	Boring No.	Depth (Feet)	% Passing No. 200 Sieve	% Passing No. 4 Sieve	Sample Description	USCS
●	BH-100	31.5	8	69	Poorly-graded SAND with silt and gravel (SP-SM)	SP-SM
◻	BH-100	36.5	45	93	Clayey SAND (SC)	SC
▲	BH-100	41.5	11	89	Poorly-graded SAND with silt (SP-SM)	SP-SM

GRADATION_B SVRT_PHASE 2_041808.GPJ SVRT-BART.GDT 4/29/08



PREP'D BY:
L. Tran
APP'D BY:
F. Wang
DATE:
4/29/08
DWG FILE:

GRADATION TEST DATA
SILICON VALLEY RAPID TRANSIT PROJECT
San Jose, California

FIGURE
4-33
PROJECT No.
213213

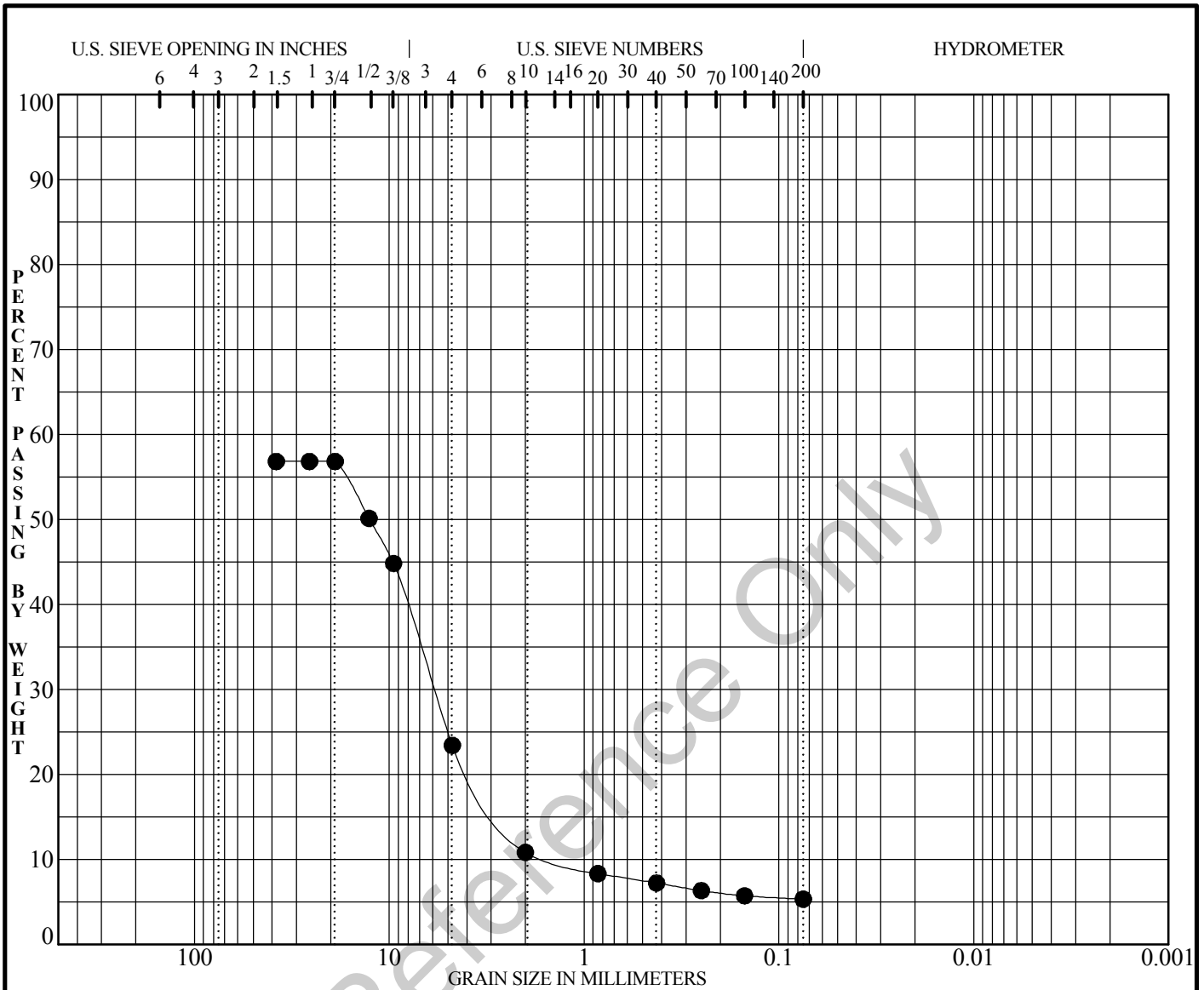

Cobbles	Gravel		Sand			Silt and Clay
	Coarse	Fine	Coarse	Medium	Fine	

Key Symbol	Boring No.	Depth (Feet)	% Passing No. 200 Sieve	% Passing No. 4 Sieve	Sample Description	USCS
●	BH-101	6.5	5	23	Poorly-graded GRAVEL with silt and sand (GP-GM)	GP-GM

GRADATION_B SVRT_PHASE 2_041808.GPJ SVRT-BART.GDT 4/29/08

	PREP'D BY: L. Tran	GRADATION TEST DATA SILICON VALLEY RAPID TRANSIT PROJECT San Jose, California	FIGURE
	APP'D BY: F. Wang		4-34
	DATE: 4/29/08		PROJECT No.
	DWG FILE:		213213

See disclaimer on cover page.

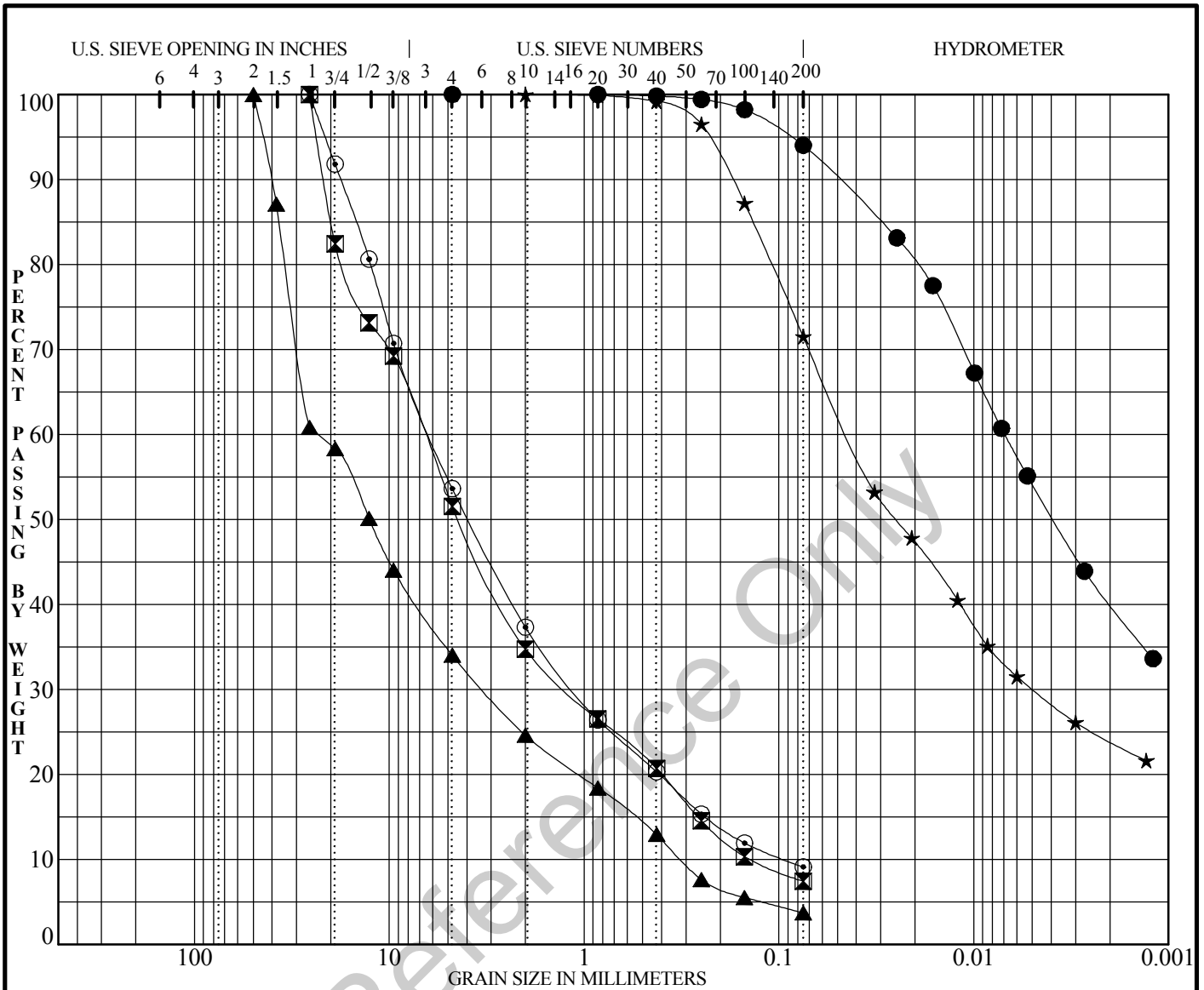

Cobbles	Gravel		Sand			Silt and Clay
	Coarse	Fine	Coarse	Medium	Fine	

Key Symbol	Boring No.	Depth (Feet)	% Passing No. 200 Sieve	% Passing No. 4 Sieve	Sample Description	USCS
●	BH-102	27.5	94	100	Lean CLAY (CL)	CL
☒	BH-102	49.0	7	52	Well-graded GRAVEL with silt and sand (GW-GM)	GW-GM
▲	BH-102	60.5	4	34	Well-graded GRAVEL with silt and sand (GW-GM)	GW-GM
★	BH-102	66.5	72	100	SILT (ML)	ML
⊙	BH-102	78.5	9	54	Well-graded GRAVEL with silt and sand (GW-GM)	GW-GM

GRADATION_B SVRT_PHASE 2_041808.GPJ SVRT-BART.GDT 4/29/08



PREP'D BY:
L. Tran
APP'D BY:
F. Wang
DATE:
4/29/08
DWG FILE:

GRADATION TEST DATA
SILICON VALLEY RAPID TRANSIT PROJECT
San Jose, California

FIGURE
4-35
PROJECT No.
213213

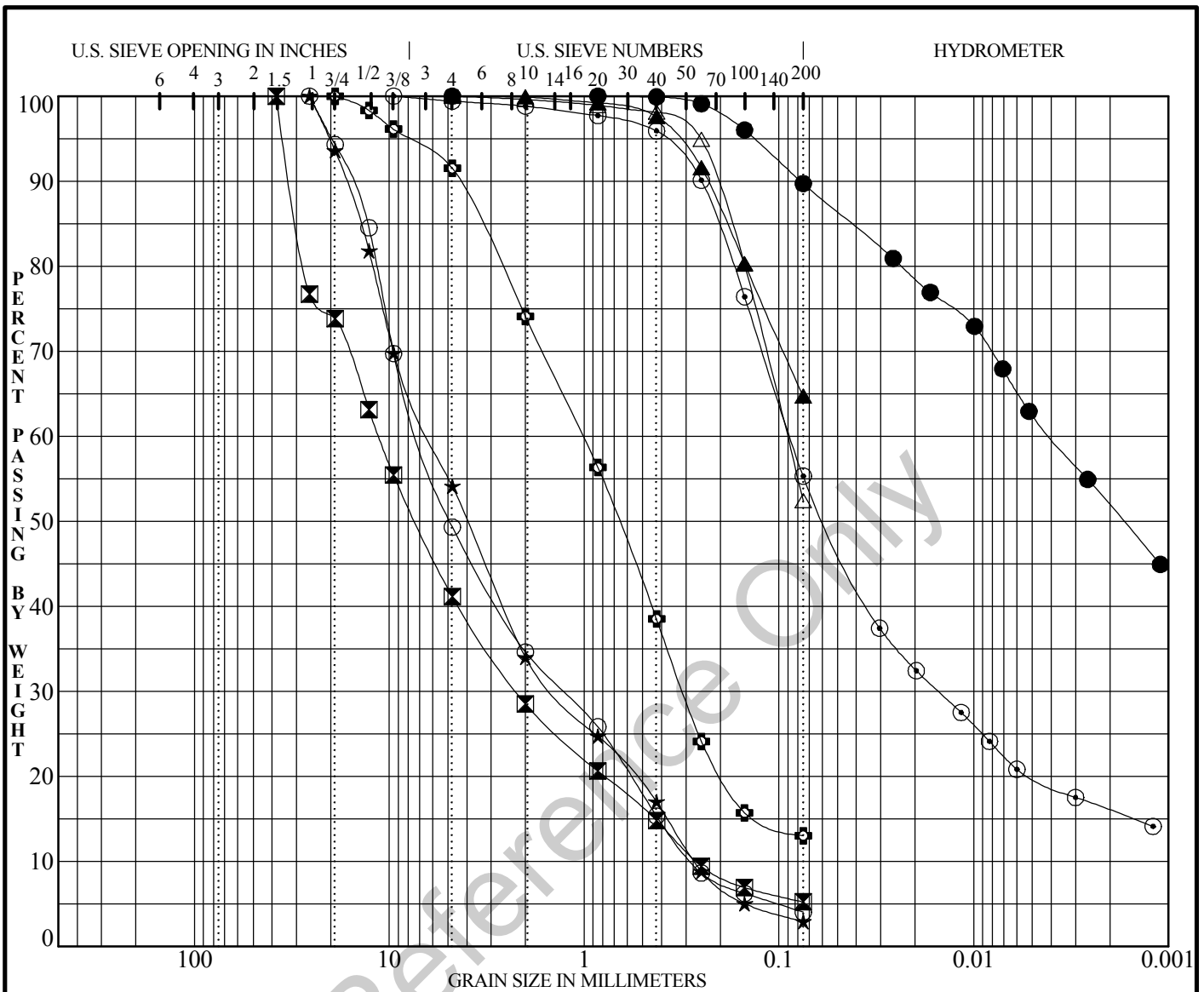

Cobbles	Gravel		Sand			Silt and Clay
	Coarse	Fine	Coarse	Medium	Fine	

Key Symbol	Boring No.	Depth (Feet)	% Passing No. 200 Sieve	% Passing No. 4 Sieve	Sample Description	USCS
●	BH-103	32.0	90	100	Fat CLAY (CH)	CH
⊠	BH-103	47.5	5	41	Well-graded GRAVEL with silt and sand (GW-GM)	GW-GM
▲	BH-103	55.0	65	100	Sandy SILT (ML)	ML
★	BH-103	62.5	3	54	Well-graded SAND with gravel (SW)	SW
⊙	BH-103	72.0	55	99	Sandy SILT (ML)	ML
⊕	BH-103	77.5	13	92	Silty SAND (SM)	SM
○	BH-103	84.0	4	49	Poorly-graded GRAVEL with sand (GP)	GP
△	BH-103	89.0	52	100	Sandy SILT (ML)	ML

GRADATION_B SVRT_PHASE 2_04:1808.GPJ SVRT-BART.GDT 4/29/08



PREP'D BY:
L. Tran
APP'D BY:
F. Wang
DATE:
4/29/08
DWG FILE:

GRADATION TEST DATA
SILICON VALLEY RAPID TRANSIT PROJECT
San Jose, California

FIGURE

4-36

PROJECT No.

213213

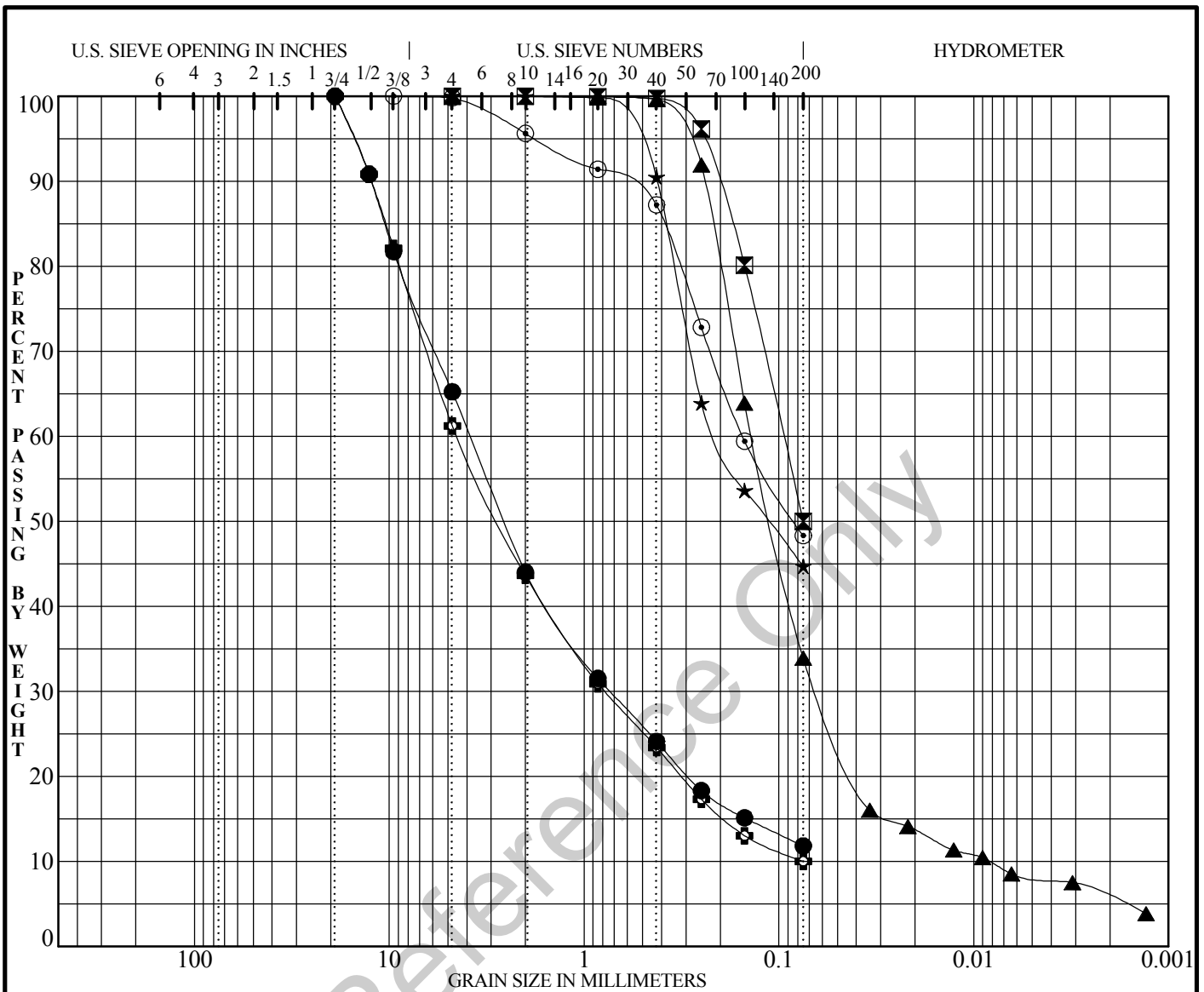

Cobbles	Gravel		Sand			Silt and Clay
	Coarse	Fine	Coarse	Medium	Fine	

Key Symbol	Boring No.	Depth (Feet)	% Passing No. 200 Sieve	% Passing No. 4 Sieve	Sample Description	USCS
●	BH-105	11.5	12	65	Well-graded SAND with silt and gravel (SW-SM)	SW-SM
☒	BH-105	24.0	50	100	Silty SAND (SM)	SM
▲	BH-105	27.5	34	100	Silty SAND (SM)	SM
★	BH-105	32.5	45	100	Clayey SAND (SC)	SC
⊙	BH-105	39.0	48	100	Silty SAND (SM)/SANDY ORGANIC SILT (OH)	SM/OH
⊕	BH-105	41.5	10	61	Well-graded SAND with silt and gravel (SW-SM)	SW-SM

GRADATION_B SVRT_PHASE 2_041808.GPJ SVRT-BART.GDT 4/29/08



PREP'D BY:
L. Tran
APP'D BY:
F. Wang
DATE:
4/29/08
DWG FILE:

GRADATION TEST DATA
SILICON VALLEY RAPID TRANSIT PROJECT
San Jose, California

FIGURE
4-37
PROJECT No.
213213

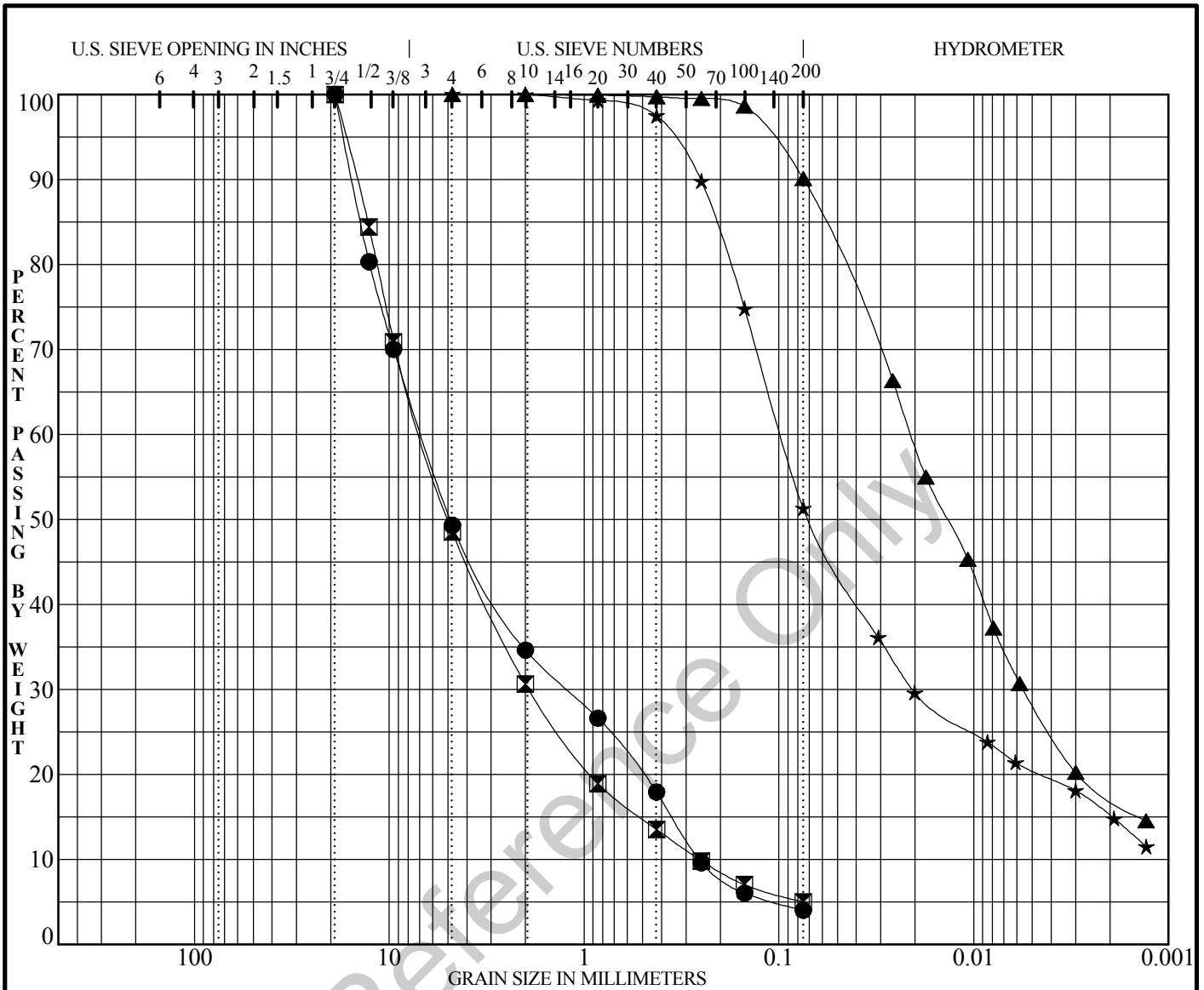

Cobbles	Gravel		Sand			Silt and Clay
	Coarse	Fine	Coarse	Medium	Fine	

Key Symbol	Boring No.	Depth (Feet)	% Passing No. 200 Sieve	% Passing No. 4 Sieve	Sample Description	USCS
●	BH-106	43.0	4	49	Poorly-graded GRAVEL with sand (GP)	GP
☒	BH-106	49.0	5	49	Well-graded GRAVEL with sand (GW)	GW
▲	BH-106	58.5	90	100	SILT (ML)	ML
★	BH-106	68.5	51	100	Sandy SILT (ML)	ML

GRADATION_B SVRT_PHASE 2_041808.GPJ SVRT-BART.GDT 4/29/08



PREP'D BY:
L. Tran
APP'D BY:
F. Wang
DATE:
4/29/08
DWG FILE:

GRADATION TEST DATA
SILICON VALLEY RAPID TRANSIT PROJECT
San Jose, California

FIGURE
4-38
PROJECT No.
213213

For Reference Only

Appendix 5: Cyclic Triaxial Test Results

For Reference Only

**APPENDIX 5
CYCLIC TRIAXIAL STRENGTH
TEST RESULTS**

**GEOTECHNICAL EXPLORATION PROGRAM
CENTRAL AREA GUIDEWAY**

**SILICON VALLEY RAPID TRANSIT (SVRT) PROJECT
SAN JOSE, CALIFORNIA**

Prepared for:
HMM/Bechtel

JANUARY 2008
Fugro Project No. 1637.001

For Reference Only

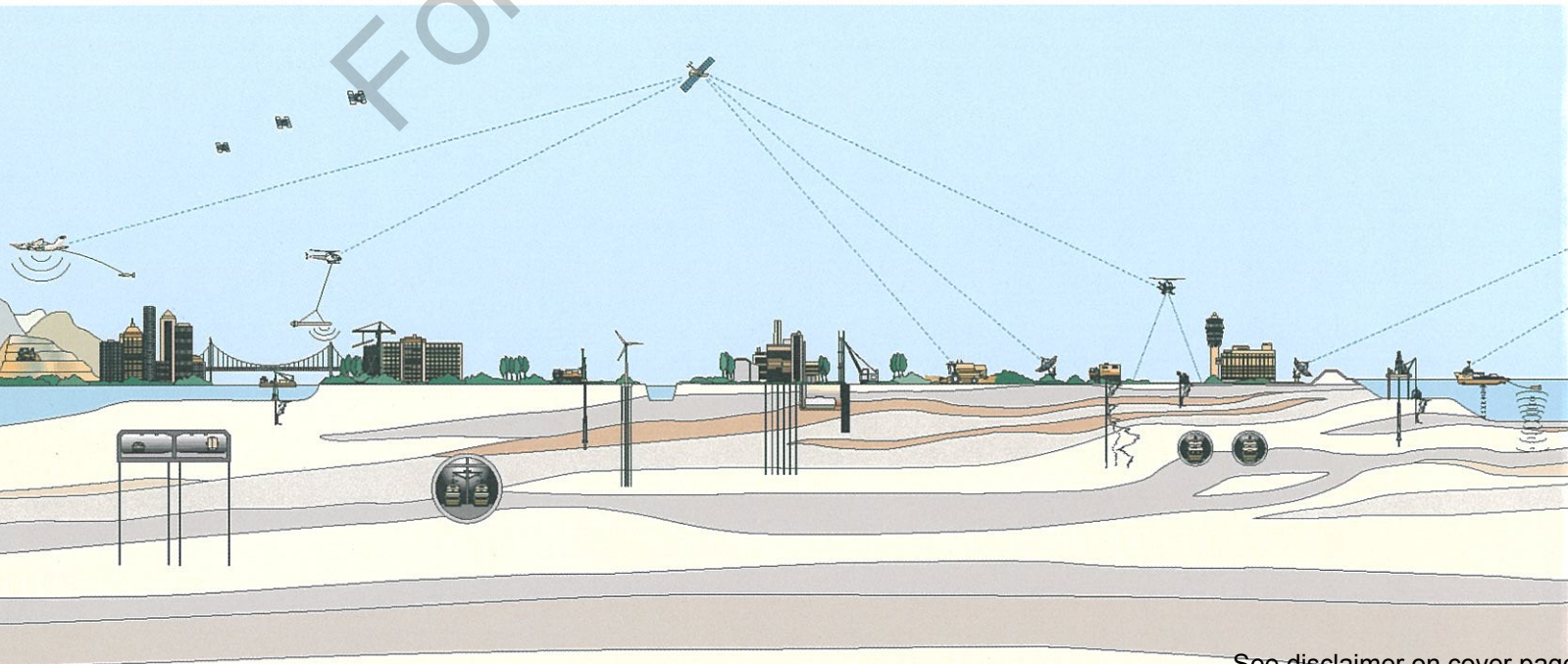



1000 Broadway, Suite 440
Oakland, California 94607
Tel: (510) 268-0461
Fax: (510) 268-0545

January 21, 2008
Project No. 1637.001

HMM/Bechtel
3103 North First Street
San Jose, California 95134

Attention: Mr. Thomas Hunt, P.E.

Subject: Appendix 5 – Cyclic Triaxial Test Results,
Central Area Guideway of SVRT Project, San Jose, California

Dear Mr. Hunt:

Fugro is pleased to submit this copy of "Appendix 5 – Cyclic Triaxial Test Results," describing the test equipment, procedures and results for the Central Area Guideway of the SVRT Project in San Jose, California.

We appreciate this opportunity to be of continued service to HMM/Bechtel. Please contact Michael Paquette at (510) 267-4441 if you have any questions regarding the information presented in this appendix.

Sincerely,

FUGRO WEST, INC.

A handwritten signature in black ink that reads "Michael Paquette".

Michael Paquette, P.E.
Project Engineer

A handwritten signature in blue ink that reads "Edwin P. Woo".

Edwin P. Woo, P.E., G.E.
Principal Engineer

MP/EW:rh

Copies Submitted: (PDF) Addressee



CONTENTS

	Page
REPORT DOCKET	1
1.0 INTRODUCTION.....	1
1.1 Project Description	1
1.2 Geotechnical Exploration Program Overview.....	1
1.3 Laboratory Testing Program Overview.....	2
1.3.1 Overview of Consolidated Undrained Cyclic Triaxial Testing Program	2
1.3.2 Sample Recovery and Handling.....	3
2.0 X-RAY TEST PROCEDURES AND RESULTS	3
2.1 Overview	3
2.2 Procedure.....	3
2.3 Results and Limitations	3
3.0 CONSOLIDATED UNDRAINED CYCLIC TRIAXIAL TEST PROCEDURES.....	4
3.1 Introduction.....	4
3.2 Consolidated Undrained Cyclic Triaxial Test Standards and Procedures.....	4
3.3 Consolidated Undrained Cyclic Triaxial Test Results.....	5
4.0 LIMITATIONS.....	5

FIGURES

	Figure
X-ray of Sample No. 11, Boring B-90.....	A5-1
X-ray of Sample No. 17, Boring B-90.....	A5-2
X-ray of Sample No. 10, Boring B-91.....	A5-3
X-ray of Sample No. 19, Boring B-105.....	A5-4
Results of Consolidated Undrained Cyclic Triaxial Tests	A5-5a to A5-13b



1.0 INTRODUCTION

This appendix presents the results of the Cyclic Triaxial Compression tests conducted by the geotechnical laboratory of Fugro Consultants LP in Houston, Texas, (Fugro Consultants) as a part of the advanced laboratory-testing program for the Central Area Guideway portion of the Silicon Valley Rapid Transit (SVRT) Project.

1.1 PROJECT DESCRIPTION

The Santa Clara Valley Transportation Authority (VTA) intends to construct the SVRT Project in San Jose, California. This will be a 26.2-km (16.3-mile) extension of the Bay Area Rapid Transit (BART) heavy rail rapid transit system from the planned terminus at the end of the Warm Springs Extension in Fremont, to San Jose. The proposed alignment currently includes several new stations and vehicle storage and maintenance facilities. The alignment is composed of two major segments:

- 1) The "Northern Area" that will be approximately 11.5 miles of at-grade, elevated and cut-and-cover track from Warm Springs to San Jose; and
- 2) The "Central Area Guideway", a 5.1-mile-long tunnel, consisting of twin bored tunnels and cut-and-cover structures through downtown San Jose.

As currently planned, the Central Area Guideway includes at-grade and open cut track, cut-and-cover stations, and a cut-and-cover track crossover structure. The cut-and-cover stations and the crossover structures have a cumulative length of approximately 4,970 feet. The remaining 4.14 miles of the alignment will be twin 19.5-foot-diameter tunnels.

This investigation and report cover the 5.1-mile-long Central Area Guideway only.

1.2 GEOTECHNICAL EXPLORATION PROGRAM OVERVIEW

The joint venture of Hatch Mott MacDonald T & T, Inc., and Bechtel Infrastructure Corporation (HMM/Bechtel) is providing engineering design services for the Central Area Guideway of the SVRT Project to the VTA. HMM/Bechtel has subcontracted with a number of companies to conduct the geotechnical field exploration program for the project. HMM/Bechtel's primary subcontractors for the geotechnical exploration program include: Fugro, Parikh Consultants (Parikh) and Pitcher Drilling Company (Pitcher).

The three companies, Fugro, Parikh, and Pitcher, conducted the majority of the geotechnical field exploration program for the Central Area Guideway of the SVRT Project from October 2004 to March 2005. This supplementary geotechnical field investigation was performed between March 2007 and August 2007. The intent of the field investigation program was to obtain geotechnical data that would aid in the design and construction of the proposed tunnel and cut-and-cover structures.



In general, the geotechnical field investigations explored subsurface conditions along the proposed Central Area Guideway. The explorations were within the vicinity of the proposed Eastern and Western Portals, at the two proposed ventilation structures, and at the proposed stations, including Alum Rock Station, Downtown San Jose Station and Diridon/Arena Station. The geotechnical exploration program included:

- 2004 / 2005 Investigation
 - 76 Rotary Wash Borings (by others); and
 - 146 CPTs (by Fugro).
- 2007 Investigation
 - 18 Rotary Wash Borings (by others); and
 - 22 CPTs (by Fugro).

Figure 3-1 in the main report provides a map of the exploration locations. These locations were selected by HMM/Bechtel based on the following considerations: 1) the requirements of the tunnel designer, 2) the location of existing geotechnical data, 3) reducing impacts on private property, and 4) the avoidance of existing underground and overhead utilities.

The two companies, Parikh and Pitcher, conducted the boring investigation program. The investigation included soil sampling and in-situ testing. Soil sampling consisted of Pitcher Barrel sampling, Shelby tube sampling, SPT sampling and California sampling. The in-situ testing conducted in the borings consisted of field vane shear testing, pressuremeter testing, downhole geophysical logging, and piezometer installation. For further details regarding the boring investigation program and results, please refer to the main report.

1.3 LABORATORY TESTING PROGRAM OVERVIEW

1.3.1 Overview of Consolidated Undrained Cyclic Triaxial Testing Program

Fugro Consultants' geotechnical laboratory conducted the Consolidated Undrained Cyclic Triaxial (CUCTX) laboratory-testing program for the Central Area Guideway of the SVRT Project. This laboratory program was conducted on samples selected by HMM/Bechtel and provided by Parikh from soil borings located along the tunnel segment. This appendix provides a detailed description for the CUCTX tests along with a summary of the interpreted parameters.

The scope of the advanced laboratory-testing program also included the x-raying of assigned soil samples. A discussion of the x-ray testing procedure is provided in Section 2.0 below, with x-ray images attached to this Appendix.



1.3.2 Sample Recovery and Handling

Parikh conducted soil sampling at intervals typically ranging from 5 to 10 feet in accordance with the project specifications. Upon sample recovery, undisturbed portions of the soil sample tubes were sealed and transported to Parikh's lab. For further details regarding sample recovery and handling, refer to the main report. Soil samples assigned for advanced laboratory testing were transported in wooden Shelby tube holders designed to maintain the tubes vertical orientation during transit to Fugro's laboratory in Oakland, California. The samples were then packed in specially fabricated, padded containers designed to minimize disturbance, and maintain an upright (vertical) orientation of the samples during shipping. The samples were shipped to Fugro Consultants' geotechnical laboratory in Houston, Texas, for testing.

2.0 X-RAY TEST PROCEDURES AND RESULTS

2.1 OVERVIEW

Fugro Consultants conducted x-ray tests on soil samples assigned by HMM/Bechtel, in general accordance with ASTM D4452, Standard Test Methods for X-Ray Radiography of Soil Samples. X-ray radiography provides a qualitative measure of the internal structure of the sample's content, as displayed by the varying shades of gray resulting from variations in the soil sample. These varying shades of gray enable one to evaluate items such as the following:

- Sample quality, as noted by signs of voids, drilling wash, separations in the soil caused by gas expansion, unusual changes in bedding planes or layering;
- The presence of inclusions in the sample, such as shells or calcareous nodules; and
- The presence of naturally occurring fissures, bedding planes, voids, layering, gravel, and silts seams.

Results of the x-ray tests are used to help select appropriate and relatively undisturbed soil specimen for the laboratory testing.

2.2 PROCEDURE

In accordance with ASTM D4452, x-rayed soil samples were viewed in a slightly darkened room. Information regarding the tested sample was recorded on the laboratory's tube log sheet. All pertinent project information, including project number, boring, sample, and depth, was recorded on the tube log sheet. Technicians use the x-ray photographs to select the location to cut the tubes to obtain the specimen for advanced testing.

2.3 RESULTS AND LIMITATIONS

The x-ray photographs are attached to this appendix. Interpretation of x-ray photographs involves some degree of uncertainty. The interpretation of the radiographs is



dependent upon the quality of the radiograph and the amount of experience the technician has in performing these interpretations.

3.0 CONSOLIDATED UNDRAINED CYCLIC TRIAXIAL TEST PROCEDURES

3.1 INTRODUCTION

The CUCTX tests were conducted in accordance with ASTM D 5311. In the CUCTX test, the sample is prepared and mounted in a triaxial cell similar to a consolidated-undrained triaxial cell. The sample is saturated using backpressure and then isotropically (equal axial and radial stress) consolidated to the assigned stress. The sample is then subjected to a sinusoidal varying axial load. Cyclic load, axial deformation and porewater pressure versus time are recorded.

3.2 CONSOLIDATED UNDRAINED CYCLIC TRIAXIAL TEST STANDARDS AND PROCEDURES

CUCTX tests were performed using an electro-hydraulic closed-loop loading system (MTS-793) manufactured by MTS Systems Corporation and a special control and data acquisition software developed by Fugro for cyclic triaxial testing. The test procedure followed the technical requirements of the ASTM Standard Test Method for Load Controlled Cyclic Triaxial Strength of Soil, Designation D 5311. The procedure for the CUCTX tests typically consists of the following steps:

1. *Cell Preparation:* Using the assigned confining pressure, strength estimates and specimen area, the proper load cell and pressure transducers are selected.
2. *Specimen Preparation:* The selected portions of the tubes were cut into segments with a mechanical hacksaw (18 teeth per inch). A wire saw was used to separate the soil from the surrounding tube in an effort to reduce potential disturbance upon extrusion. In addition, each tube was marked such that all test specimens had the same orientation when sheared. The sample was then extruded from the cut portion of the tube using a hydraulically actuated ram.

Test specimens were trimmed to an approximate 2-inch diameter by 4¼-inch height. After specimens were trimmed, they were mounted in the triaxial testing apparatus and aligned with the cell base with porous stones at each end. Each specimen had top, bottom and radial drainage boundaries during consolidation. Radial drainage was provided by spirally oriented, ¼ inch wide, Whatman No. 1 filter strips, placed at about ¼-inch spacing.

3. *Back Pressure Saturation:* Specimen saturation was achieved through back pressure by simultaneously increasing the chamber and back pressure. The pressure is applied incrementally to limit the stress applied to the sample.



4. *Consolidation*: The soil specimen is isotropically consolidated to the assigned stress. The samples are typically consolidated to an effective stress approximately equal to the estimated overburden pressure. Specimens were allowed to consolidate at the prescribed stresses for about 24 hours prior to cyclic loading.
5. *Cyclic Loading*: Upon completion of consolidation, a sinusoidal cyclical load was applied to each test specimen at a frequency of 1 hertz (Hz). The specimens were maintained in an undrained (no volume change) state during cyclic loading. The system collected 200 data points per channel (vertical displacement, vertical force, pore pressure, and cell pressure) for each loading cycle, independent of the loading frequency. Fugro's software is capable of ramping the axial force at a given rate, hold the load for a given period, and cycle at a given frequency using the MTS 793 controller.

Cyclic loading continued until failure occurred or 10% axial strain occurred. Failure could be readily defined if it occurred within the tested cycles; otherwise, failure was defined by data extrapolation. A special Excel worksheet was used to process the raw data files created by the data acquisition and control software.

3.3 CONSOLIDATED UNDRAINED CYCLIC TRIAXIAL TEST RESULTS

During consolidation and loading the necessary data (time, vertical and horizontal forces, shear deformations, pore pressures and transducer excitation voltage) were recorded using an automated data-acquisition system and electronically filed. Specialized Excel worksheets, along with a Visual Basic code (VBA) were used to reduce the data files into engineering units in tabular and graphical format. Figures A5-1 through A5-18 present the CUCTX test results.

Results such as moisture content, initial unit weight, soil type, vertical effective consolidation stress and confinement pressure are summarized in Table A15-1 "Summary of CUCTX Test Results."

4.0 LIMITATIONS

Our services consist of laboratory testing and data evaluations that are made in accordance with generally accepted geotechnical engineering principles and practices. This warranty is in lieu of all other warranties, either expressed or implied.

The test data provided in this appendix are from laboratory testing performed on samples from subsurface explorations by others. The explorations indicate subsurface conditions only at specific locations and times, and only to the depths penetrated. Variations may exist and conditions not observed or described in this report could be encountered during construction. Our laboratory tests results presented in this appendix are based on the standards and procedures indicated herein. HMM/Bechtel provided the laboratory test assignments.





This appendix has been prepared for the exclusive use of HMM/Bechtel and their consultants for specific application to the SVRT project as described herein. In the event that there are any changes in the ownership, nature, design, or location of the proposed project, or if any future additions are planned, the results contained in this appendix should not be considered valid unless: 1) the project changes are reviewed by Fugro, and 2) results presented in this appendix are modified or verified in writing. Reliance on this report by others must be at their risk unless we are consulted on the use or limitations. We cannot be responsible for the impacts of any changes in geotechnical standards, practices, or regulations subsequent to performance of services without our further consultation. We can neither vouch for the accuracy of information supplied by others, nor accept consequences for unconsulted use of segregated portions of this report.

For Reference Only



For Reference Only

FIGURES

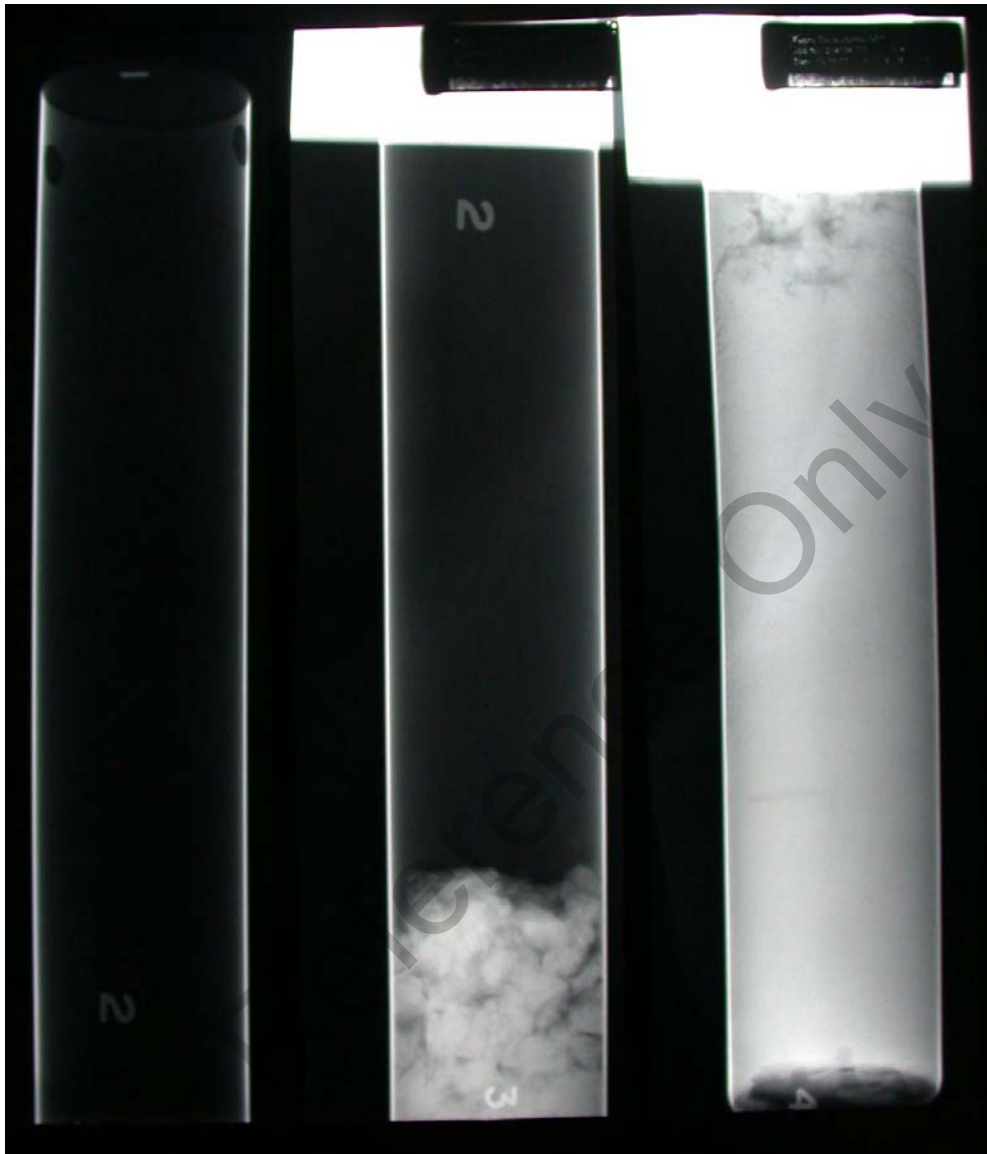

X-Ray of Sample No. 11, Boring B-90



X-Ray of Sample No. 17, Boring B-90



X-Ray of Sample No. 10, Boring B-91

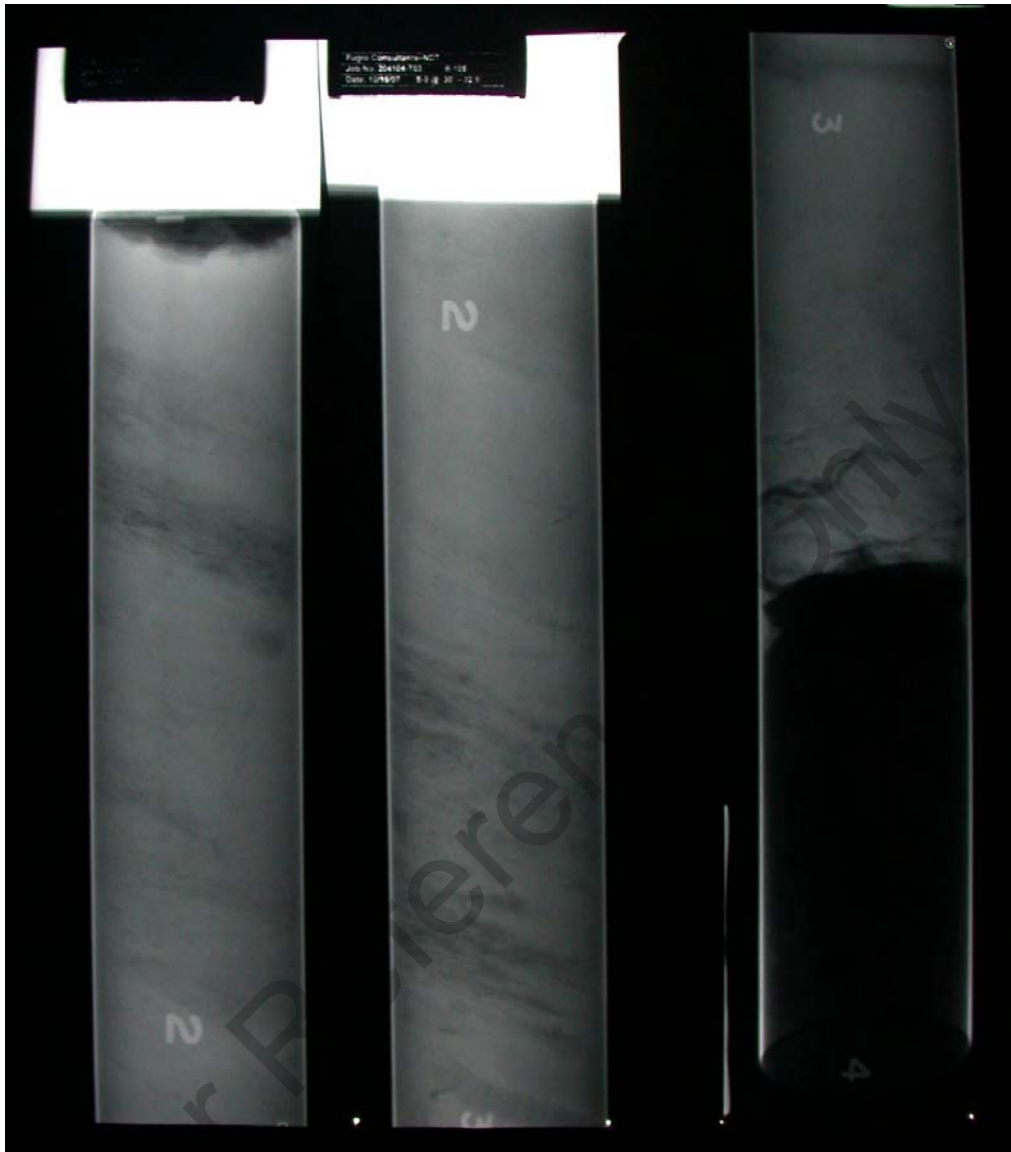

X-Ray of Sample No. 19, Boring B-105

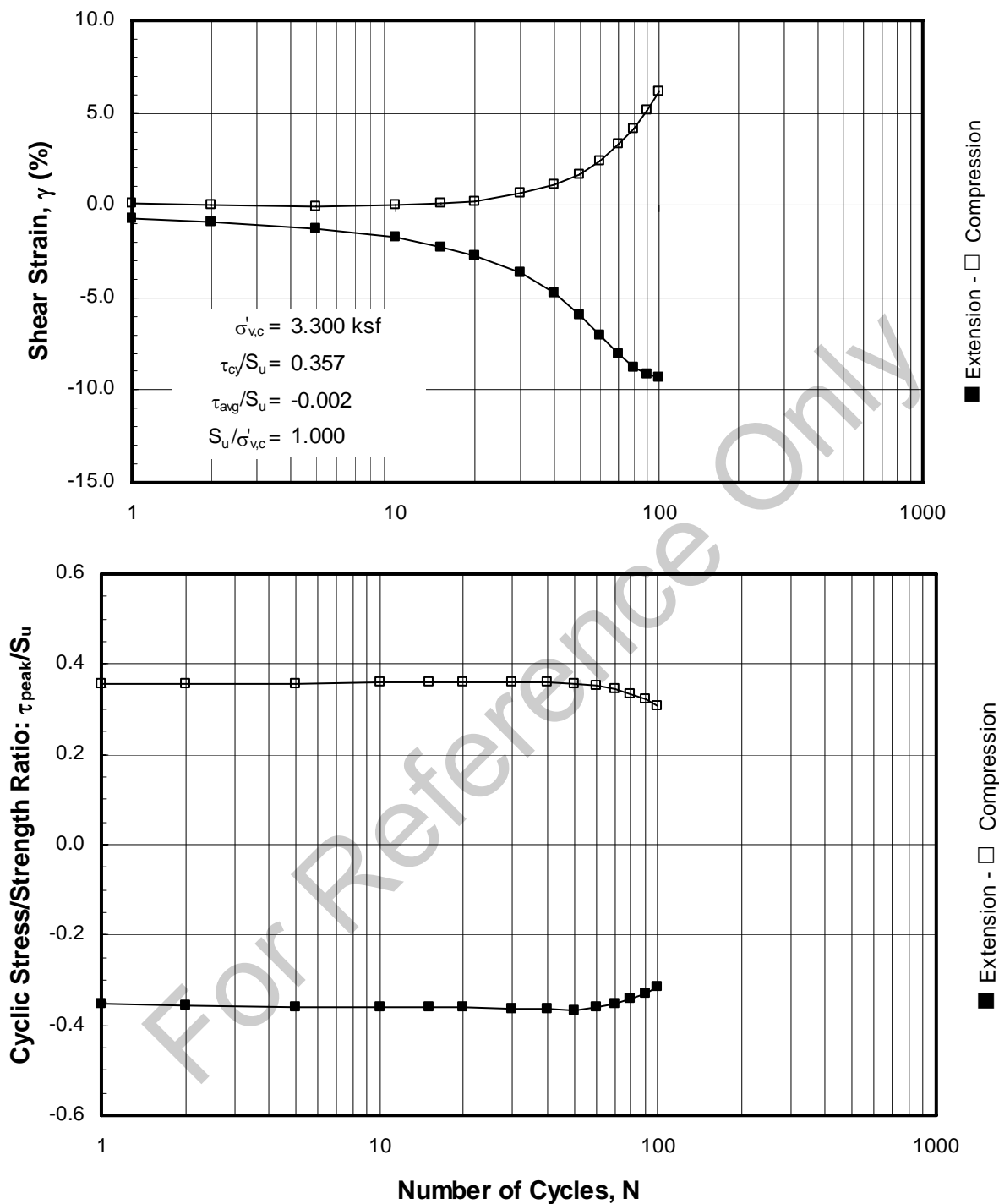

CYCLIC TRIAXIAL STRENGTH TEST: With Undrained Bias Stress

Isotropic Consolidation - OCR = 1 - Cyclic Rate: 1.0 Hz

Sample: S-11a - Depth: 37.50 ft.

Boring BH-90



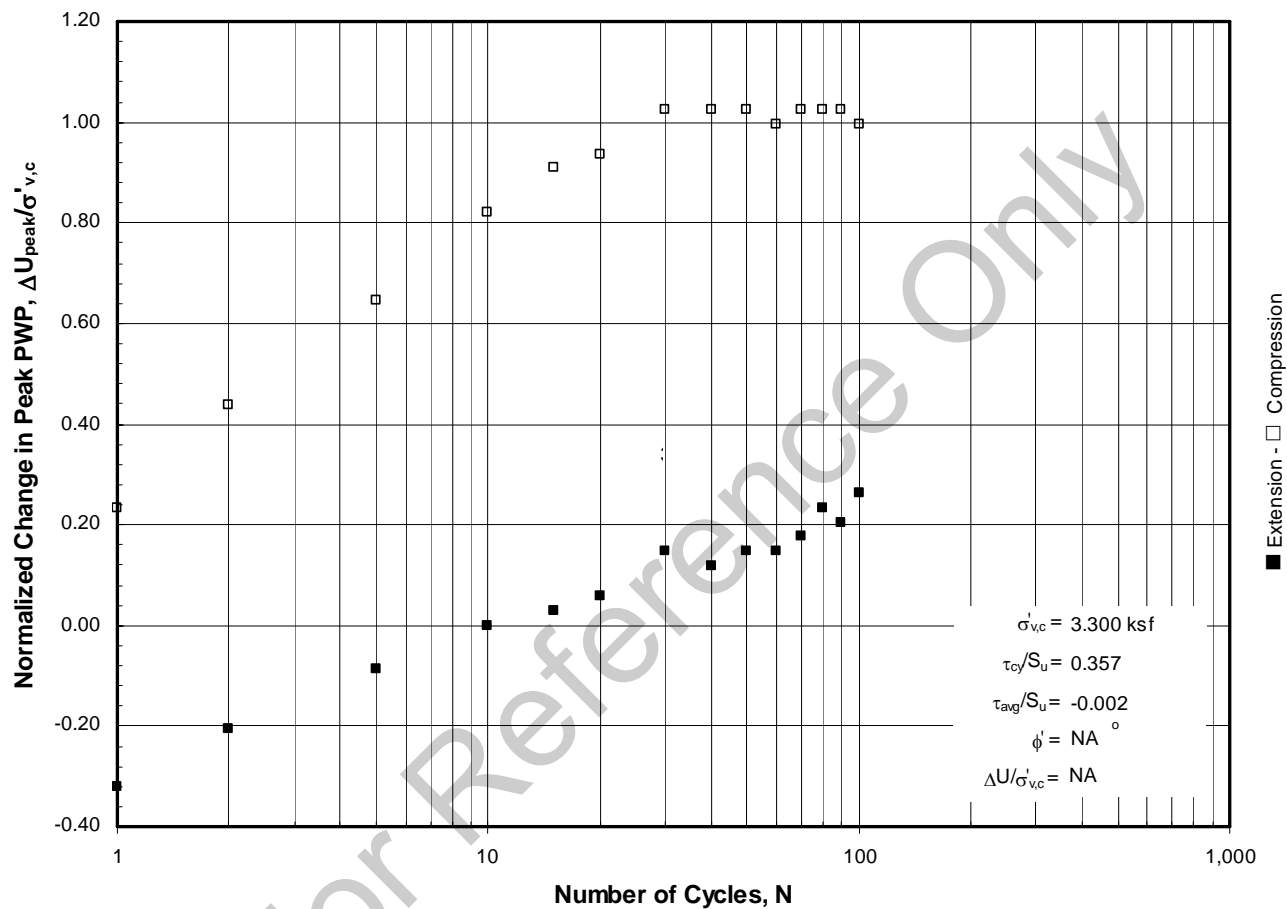

For Reference Only

CYCLIC TRIAXIAL STRENGTH TEST: With Undrained Bias Stress
 Isotropic Consolidation - OCR = 1 - Cyclic Rate: 1.0 Hz
 Sample: S-11a - Depth: 37.50 ft.
 Boring BH-90



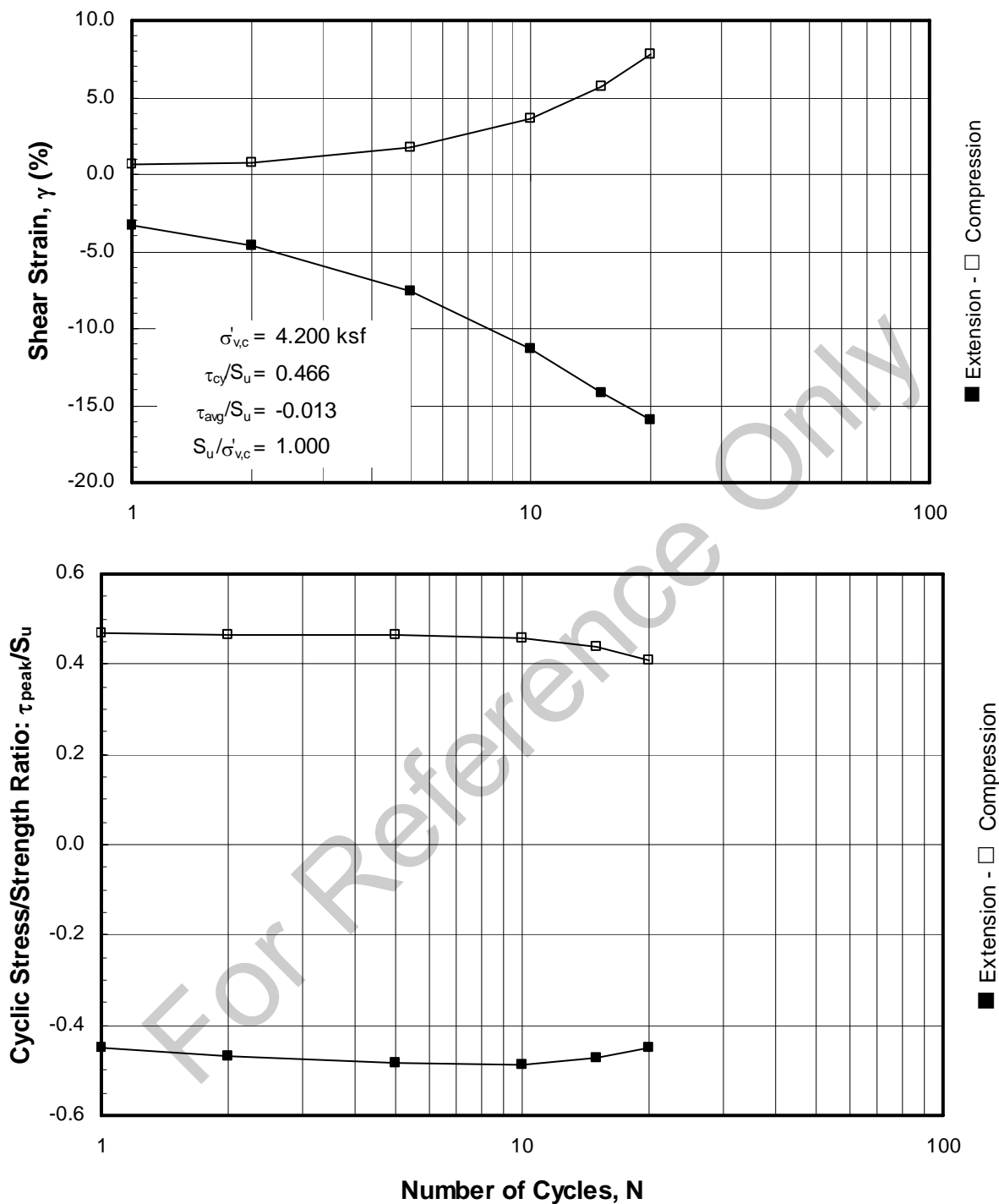

CYCLIC TRIAXIAL STRENGTH TEST: With Undrained Bias Stress

Isotropic Consolidation - OCR = 1 - Cyclic Rate: 1.0 Hz

Sample: S-17c - Depth: 52.50 ft.

Boring BH-90



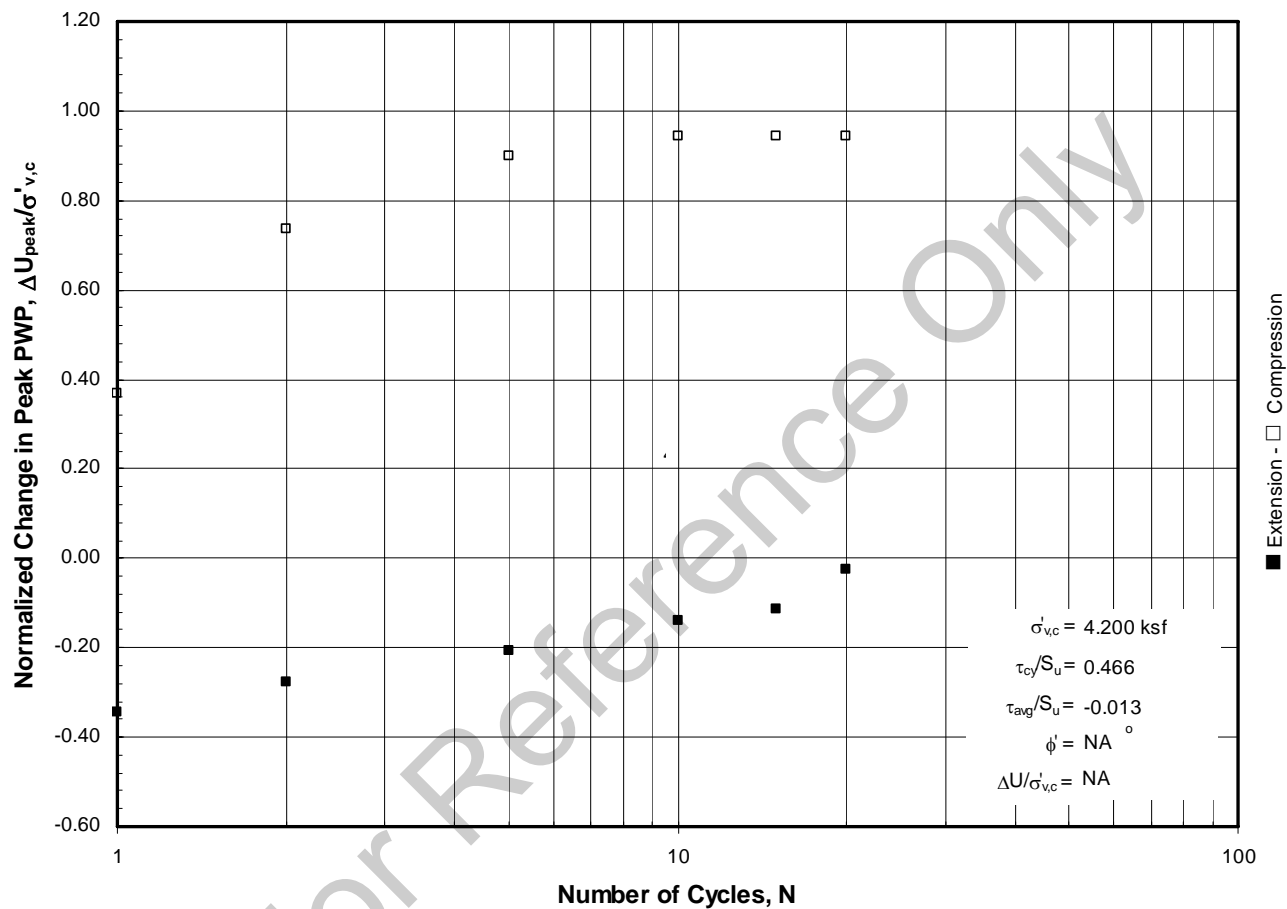

For Reference Only

CYCLIC TRIAXIAL STRENGTH TEST: With Undrained Bias Stress
 Isotropic Consolidation - OCR = 1 - Cyclic Rate: 1.0 Hz
 Sample: S-17c - Depth: 52.50 ft.
 Boring BH-90



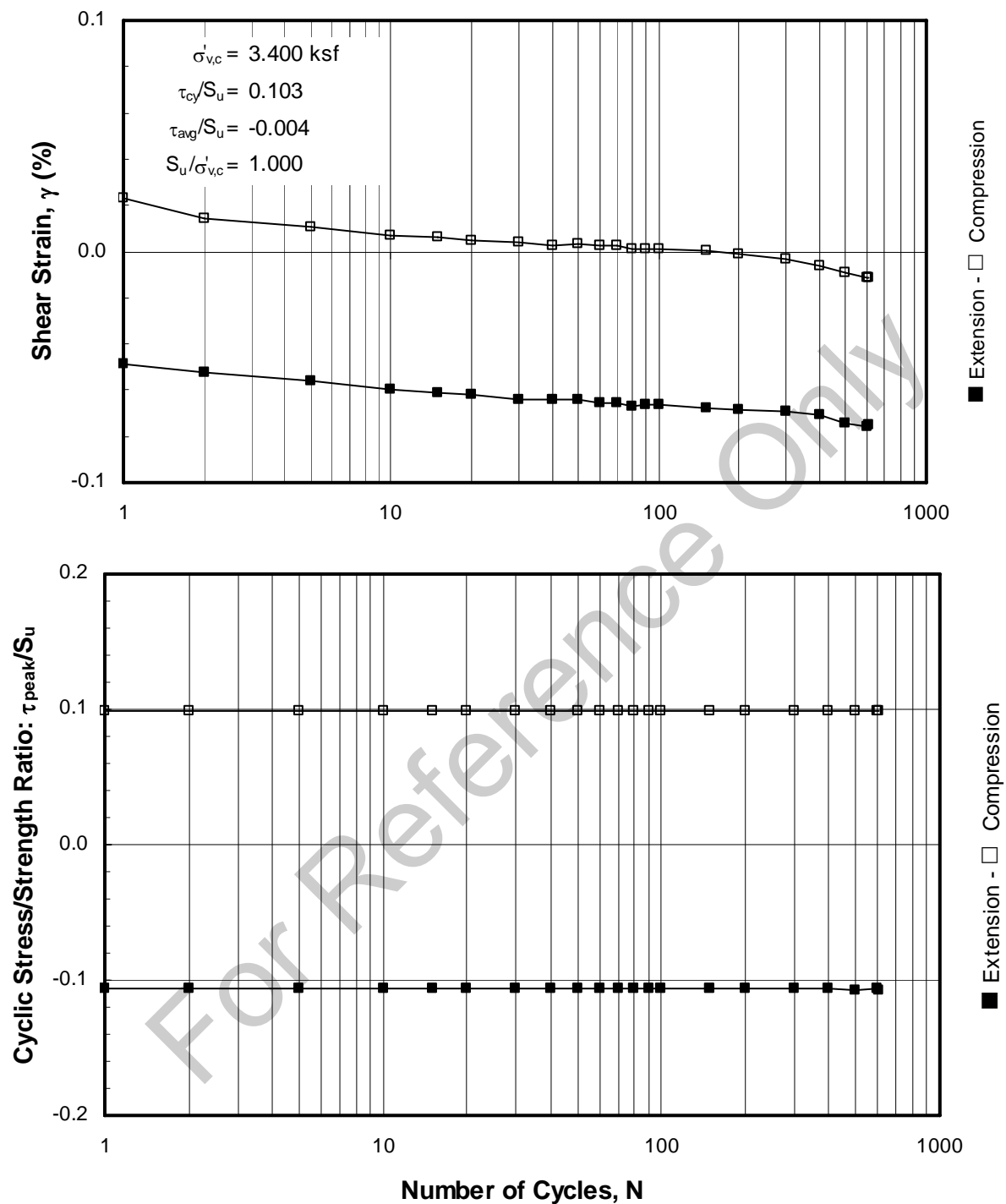

CYCLIC TRIAXIAL STRENGTH TEST: With Undrained Bias Stress

Isotropic Consolidation - OCR = 1 - Cyclic Rate: 1.0 Hz

Sample: S-10a - Depth: 38.90 ft.

Boring BH-91



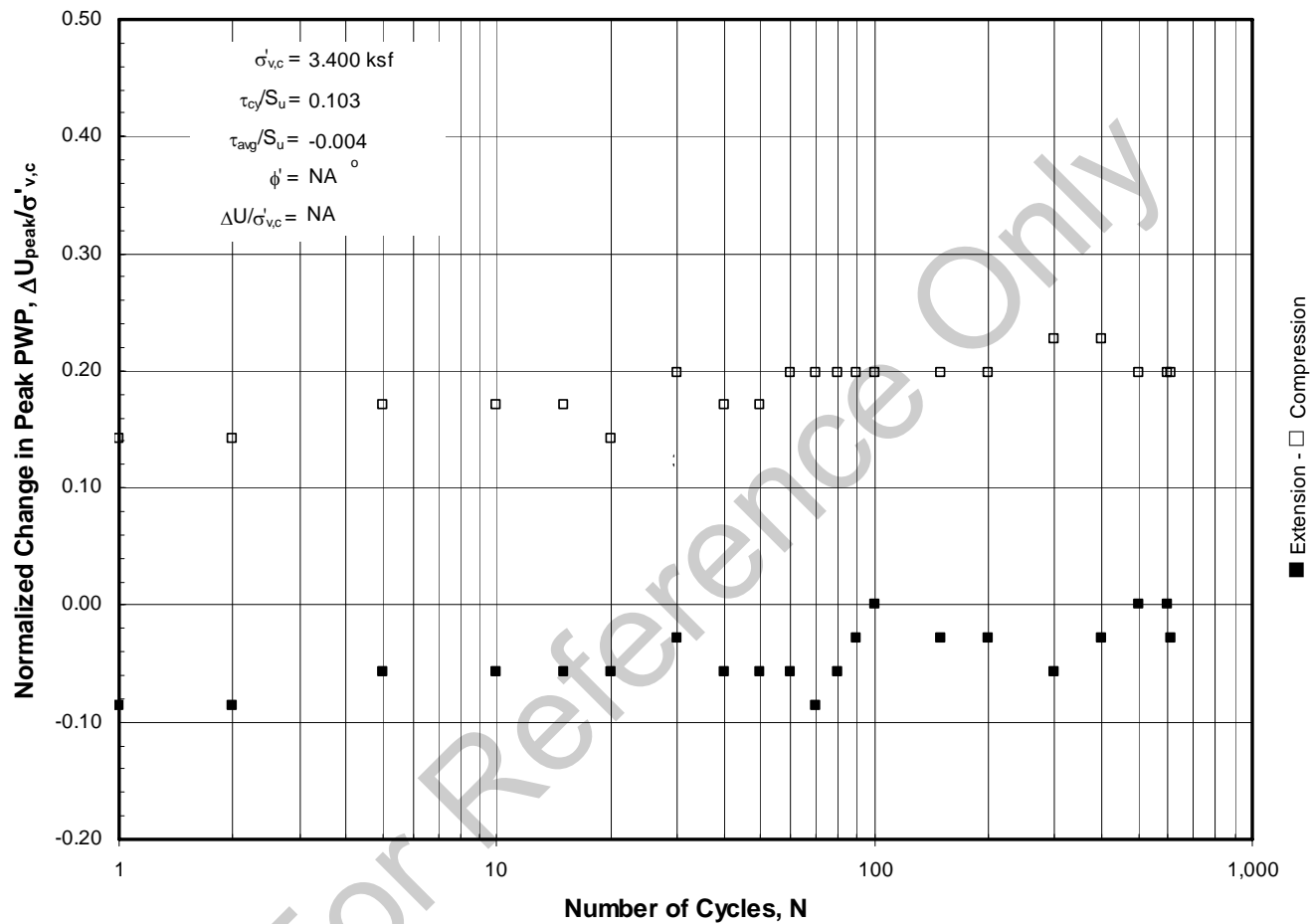

CYCLIC TRIAXIAL STRENGTH TEST: With Undrained Bias Stress

Isotropic Consolidation - OCR = 1 - Cyclic Rate: 1.0 Hz

Sample: S-10a - Depth: 38.90 ft.

Boring BH-91

Central Area Guideway of SVRT Project
San Jose, California

Figure A5-7b



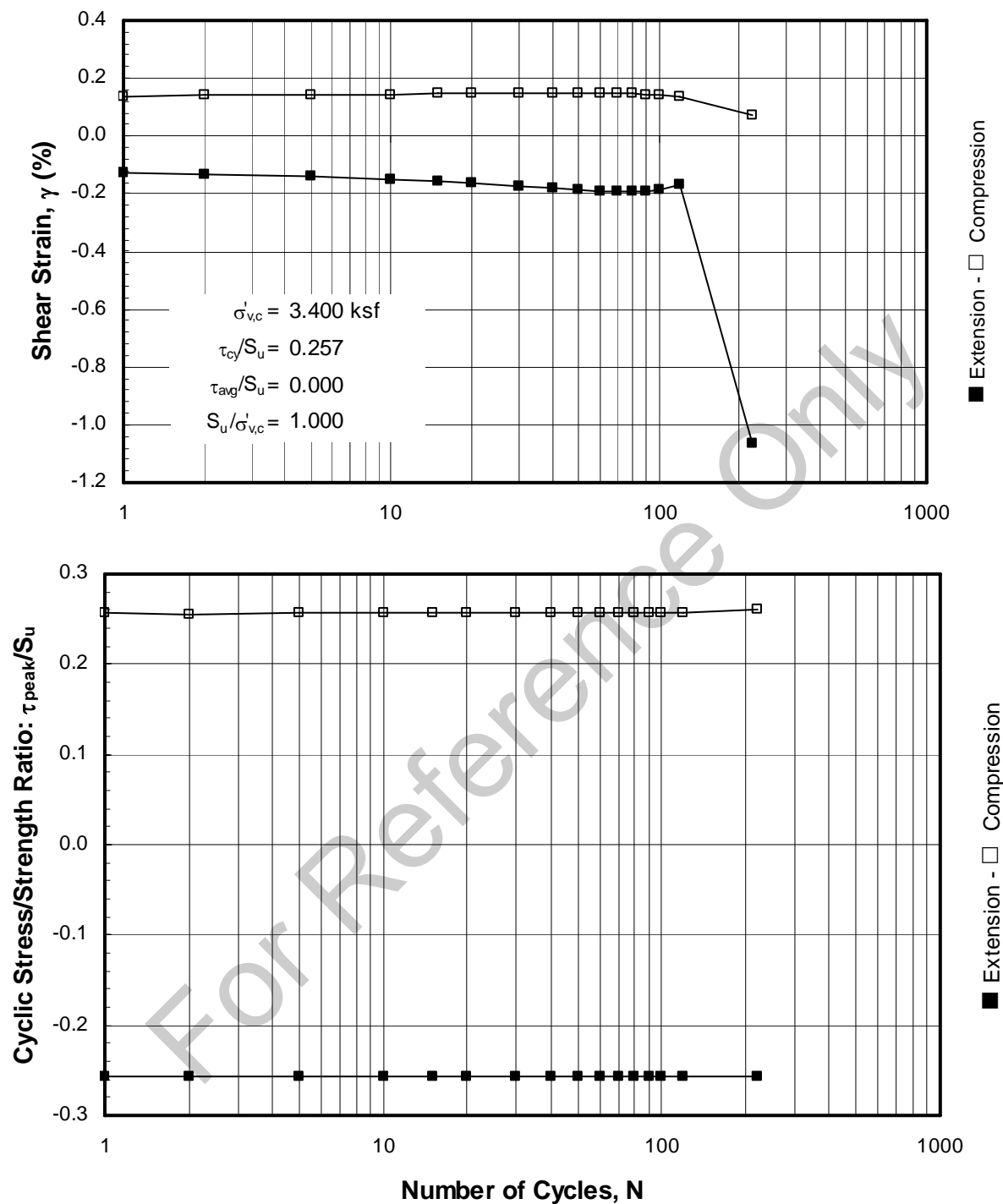

CYCLIC TRIAXIAL STRENGTH TEST: With Undrained Bias Stress

Isotropic Consolidation - OCR = 1 - Cyclic Rate: 1.0 Hz

Sample: S-10b - Depth: 38.50 ft.

Boring BH-91



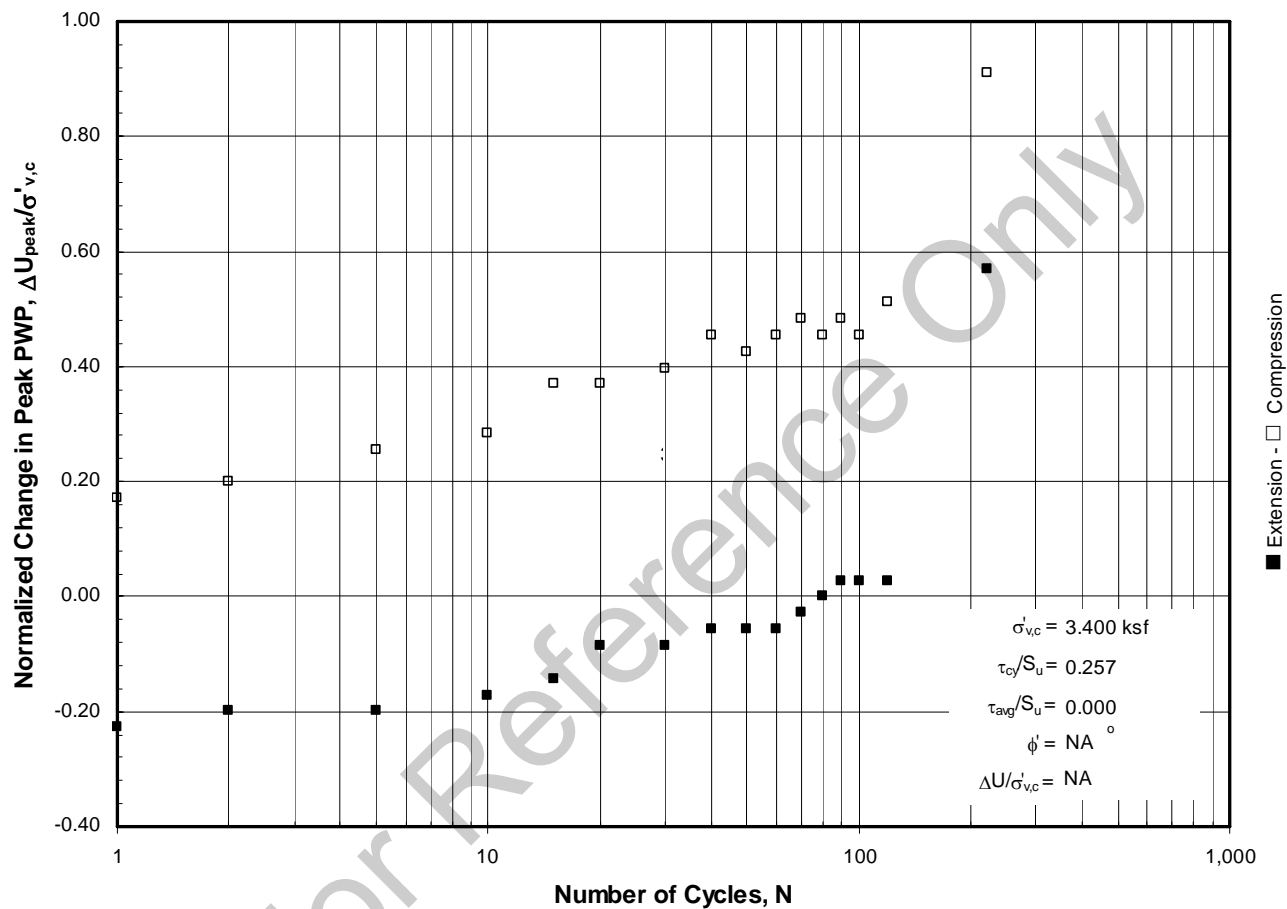

CYCLIC TRIAXIAL STRENGTH TEST: With Undrained Bias Stress

Isotropic Consolidation - OCR = 1 - Cyclic Rate: 1.0 Hz

Sample: S-10b - Depth: 38.50 ft.

Boring BH-91



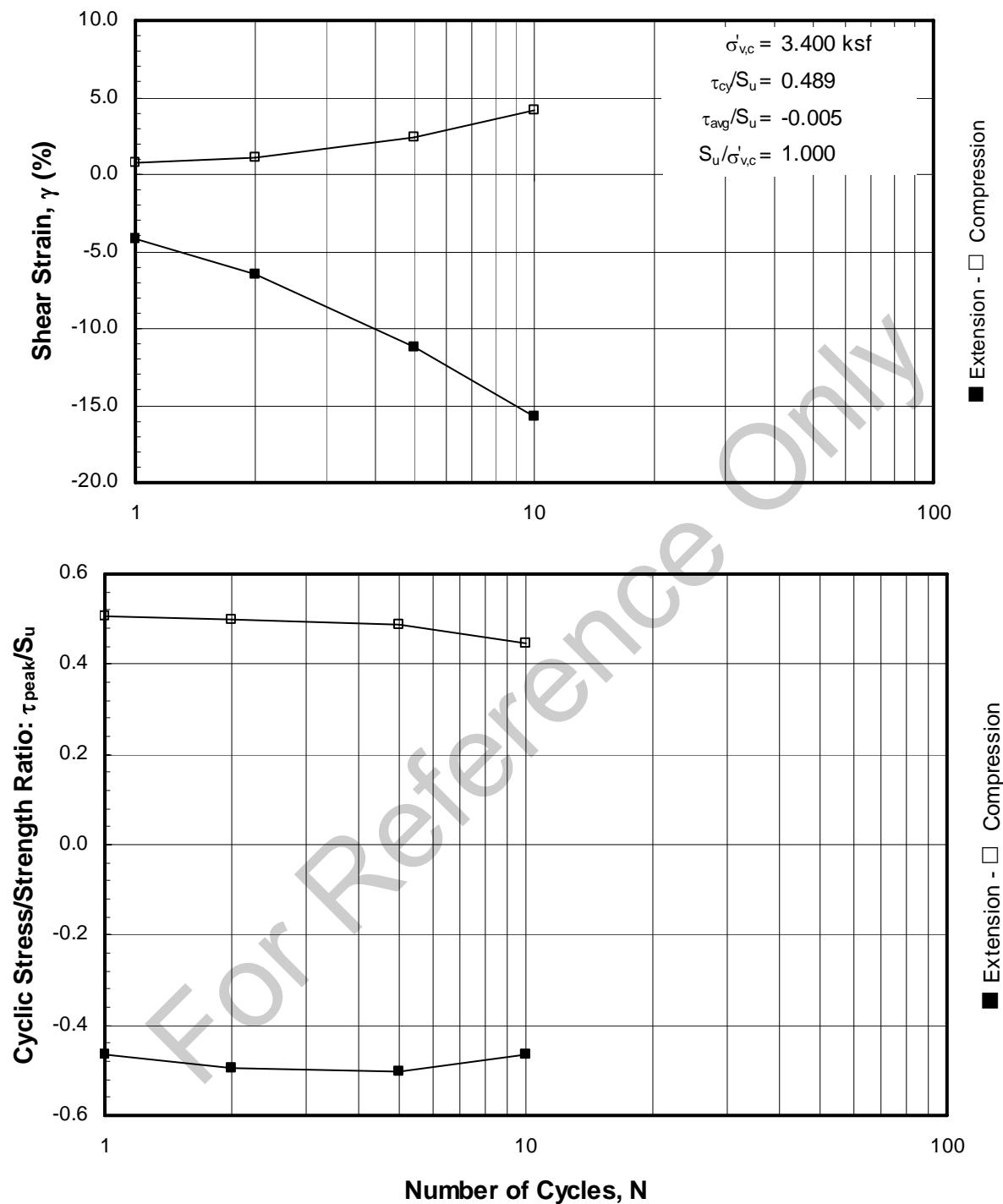

CYCLIC TRIAXIAL STRENGTH TEST: With Undrained Bias Stress

Isotropic Consolidation - OCR = 1 - Cyclic Rate: 1.0 Hz

Sample: S-10c - Depth: 38.10 ft.

Boring BH-91



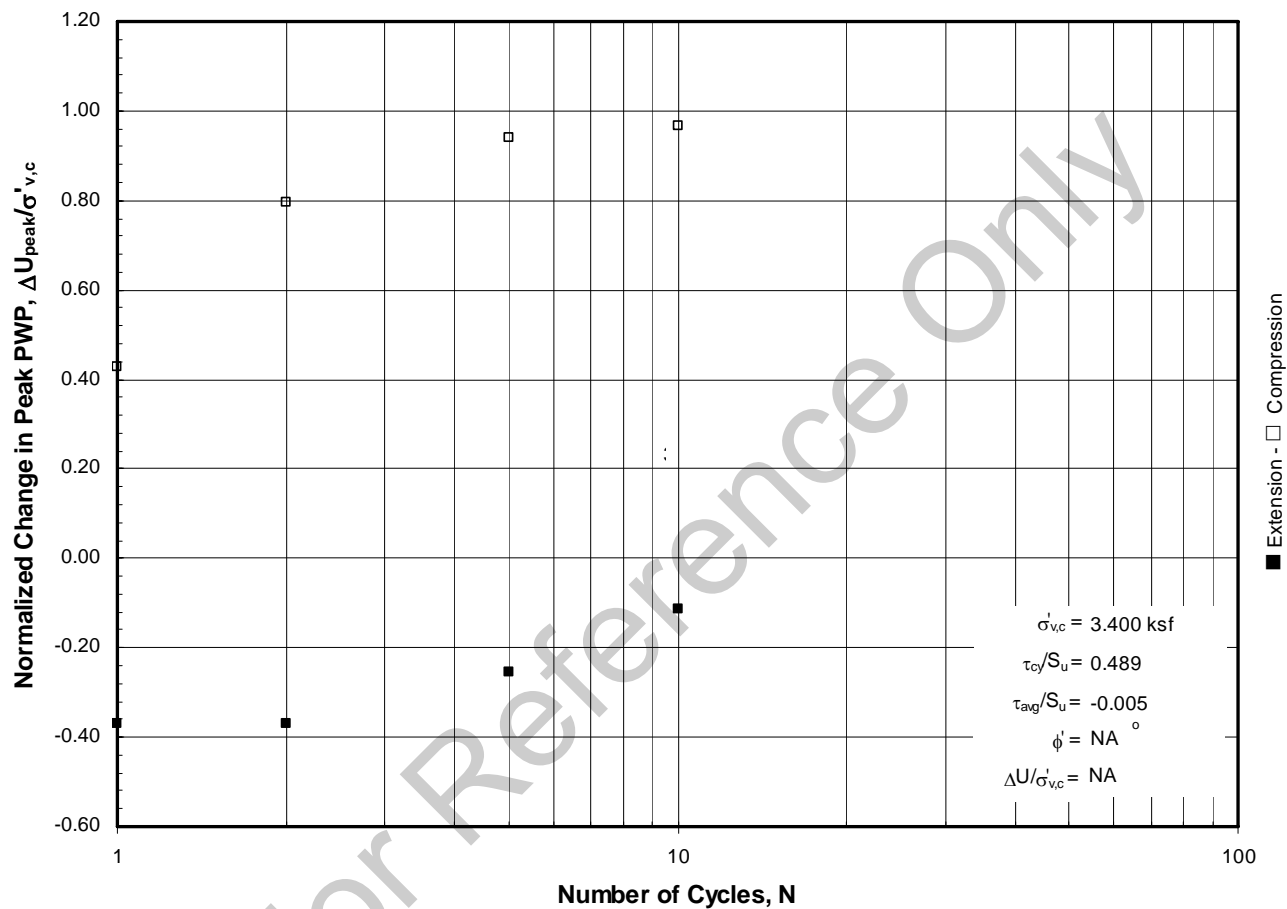

CYCLIC TRIAXIAL STRENGTH TEST: With Undrained Bias Stress

Isotropic Consolidation - OCR = 1 - Cyclic Rate: 1.0 Hz

Sample: S-10c - Depth: 38.10 ft.

Boring BH-91



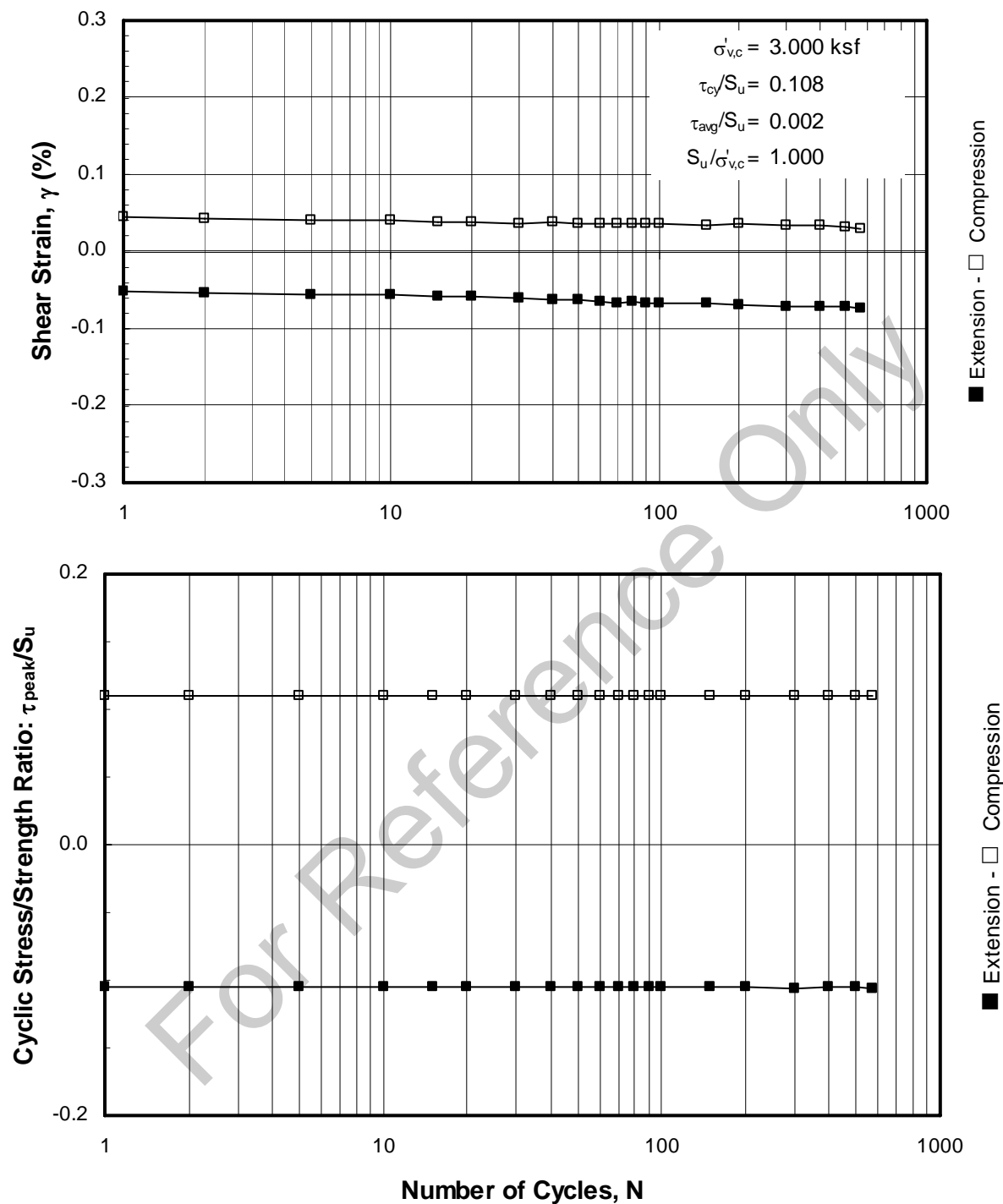

CYCLIC TRIAXIAL STRENGTH TEST: With Undrained Bias Stress

Isotropic Consolidation - OCR = 1 - Cyclic Rate: 1.0 Hz

Sample: S-9a - Depth: 32.45 ft.

Boring BH-105



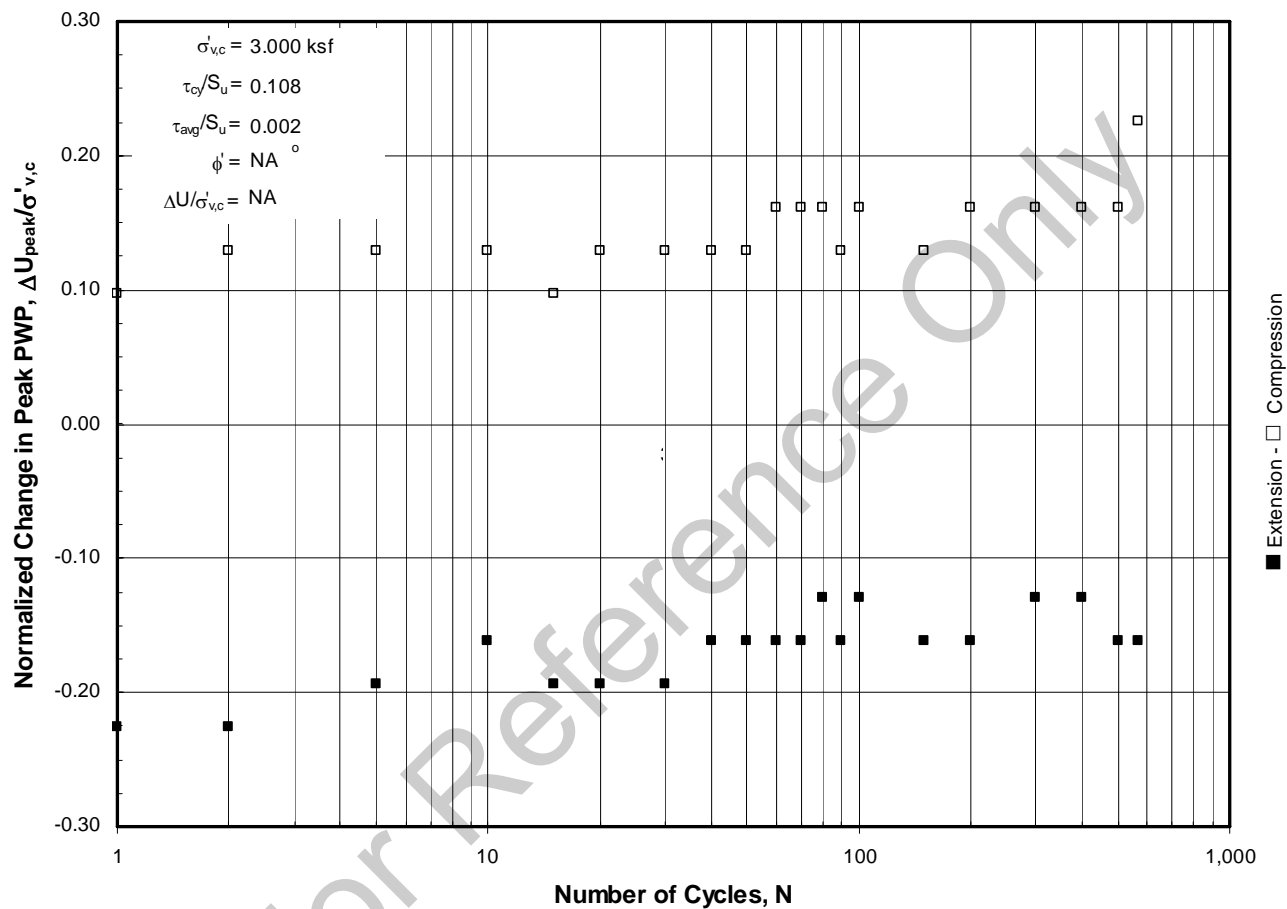

For Reference Only

CYCLIC TRIAXIAL STRENGTH TEST: With Undrained Bias Stress
 Isotropic Consolidation - OCR = 1 - Cyclic Rate: 1.0 Hz
 Sample: S-9a - Depth: 32.45 ft.
 Boring BH-105



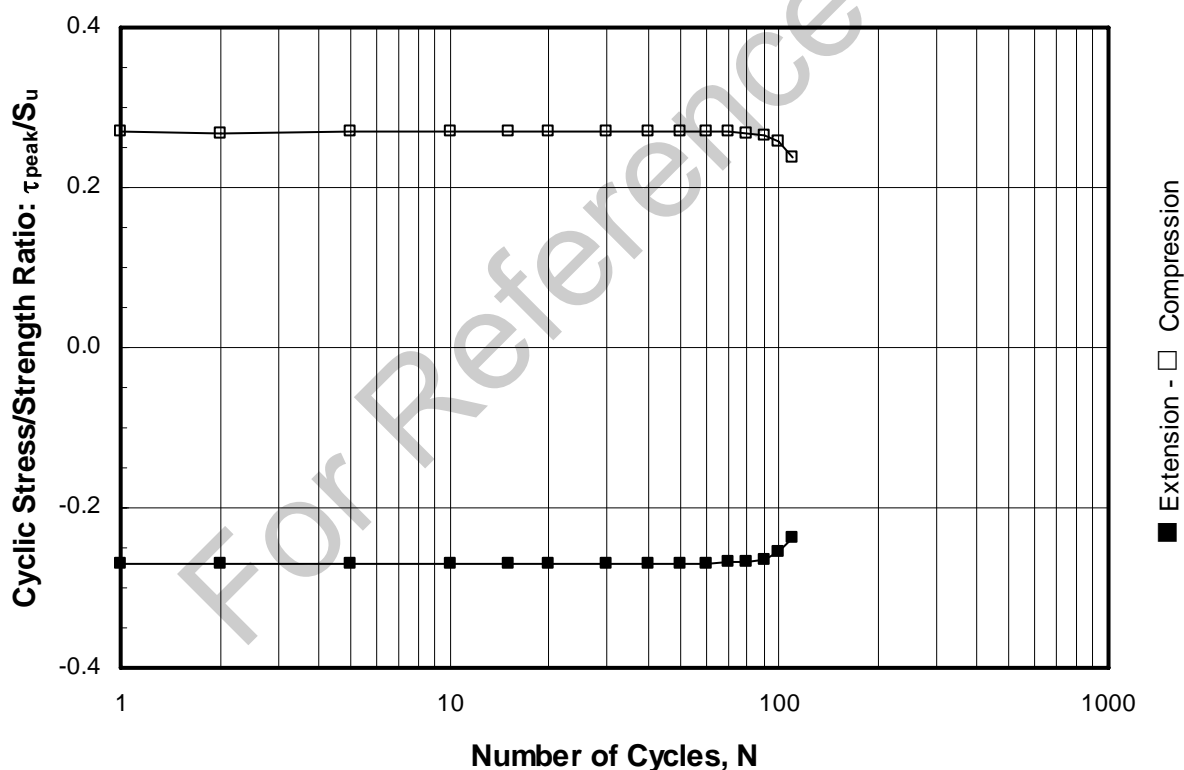
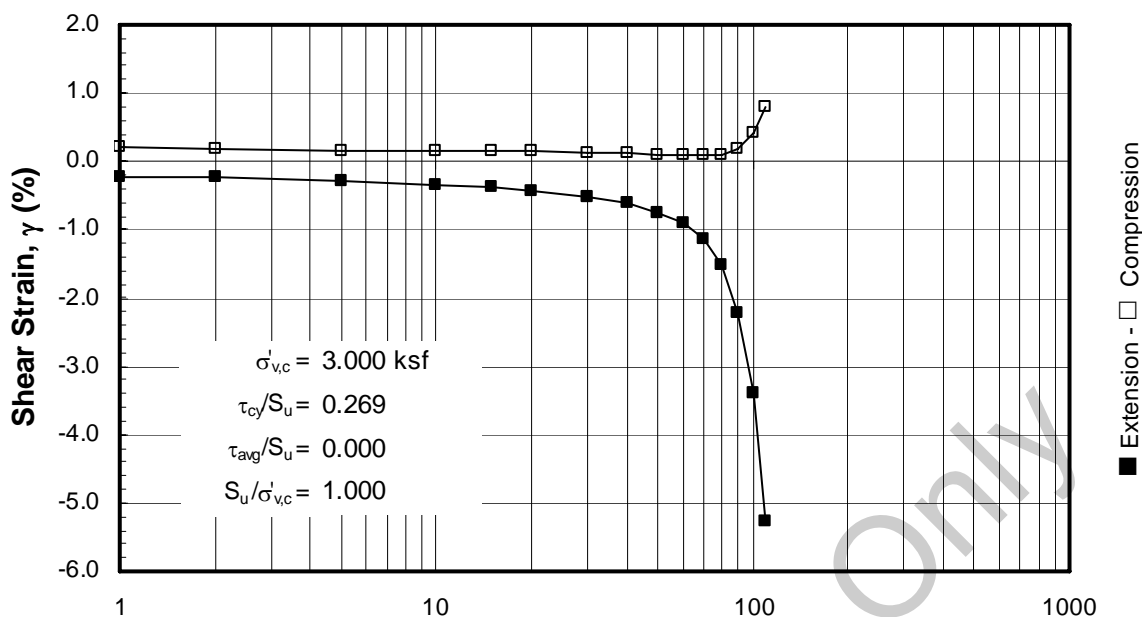

CYCLIC TRIAXIAL STRENGTH TEST: With Undrained Bias Stress

Isotropic Consolidation - OCR = 1 - Cyclic Rate: 1.0 Hz

Sample: S-9b - Depth: 32.05 ft.

Boring BH-105



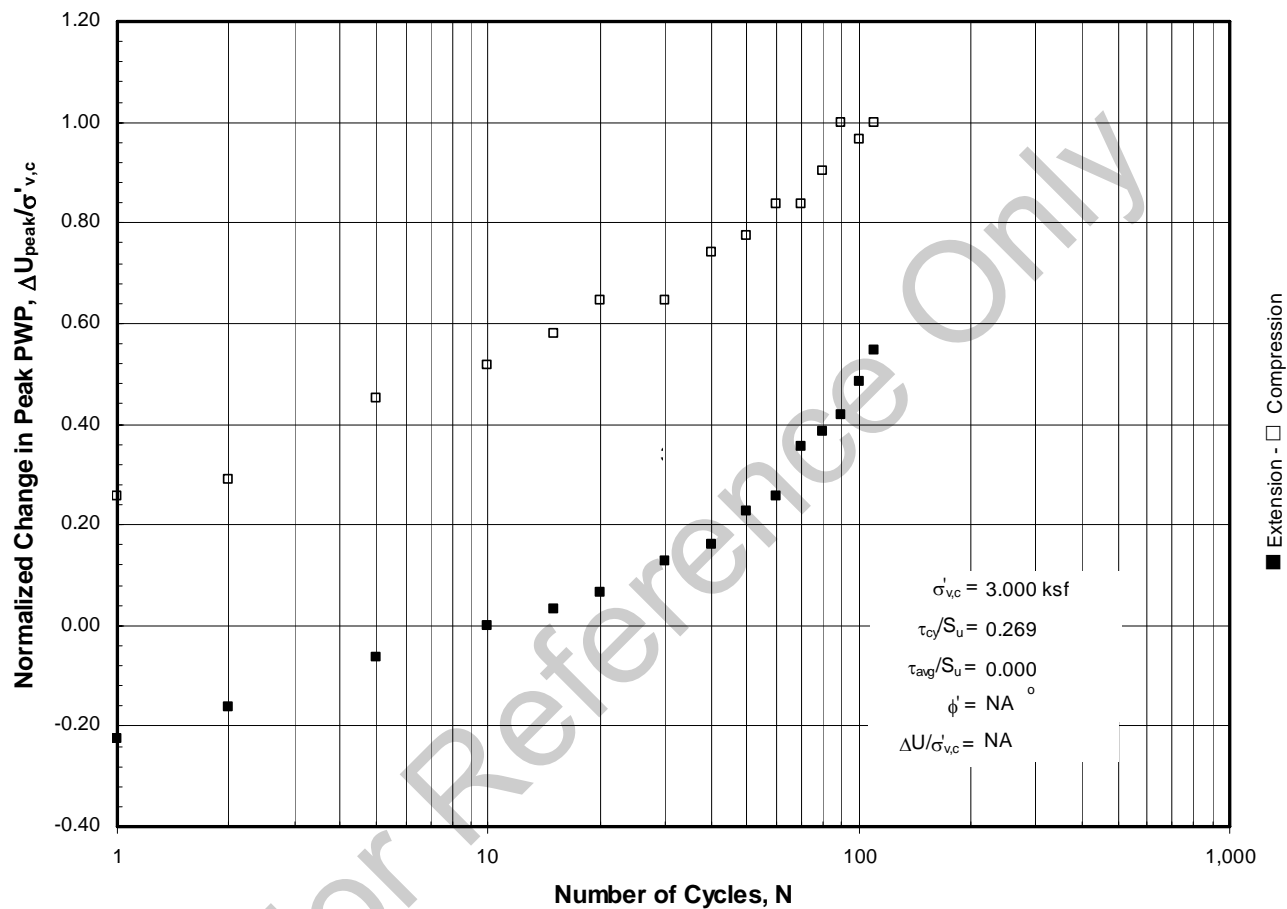

CYCLIC TRIAXIAL STRENGTH TEST: With Undrained Bias Stress

Isotropic Consolidation - OCR = 1 - Cyclic Rate: 1.0 Hz

Sample: S-9b - Depth: 32.05 ft.

Boring BH-105



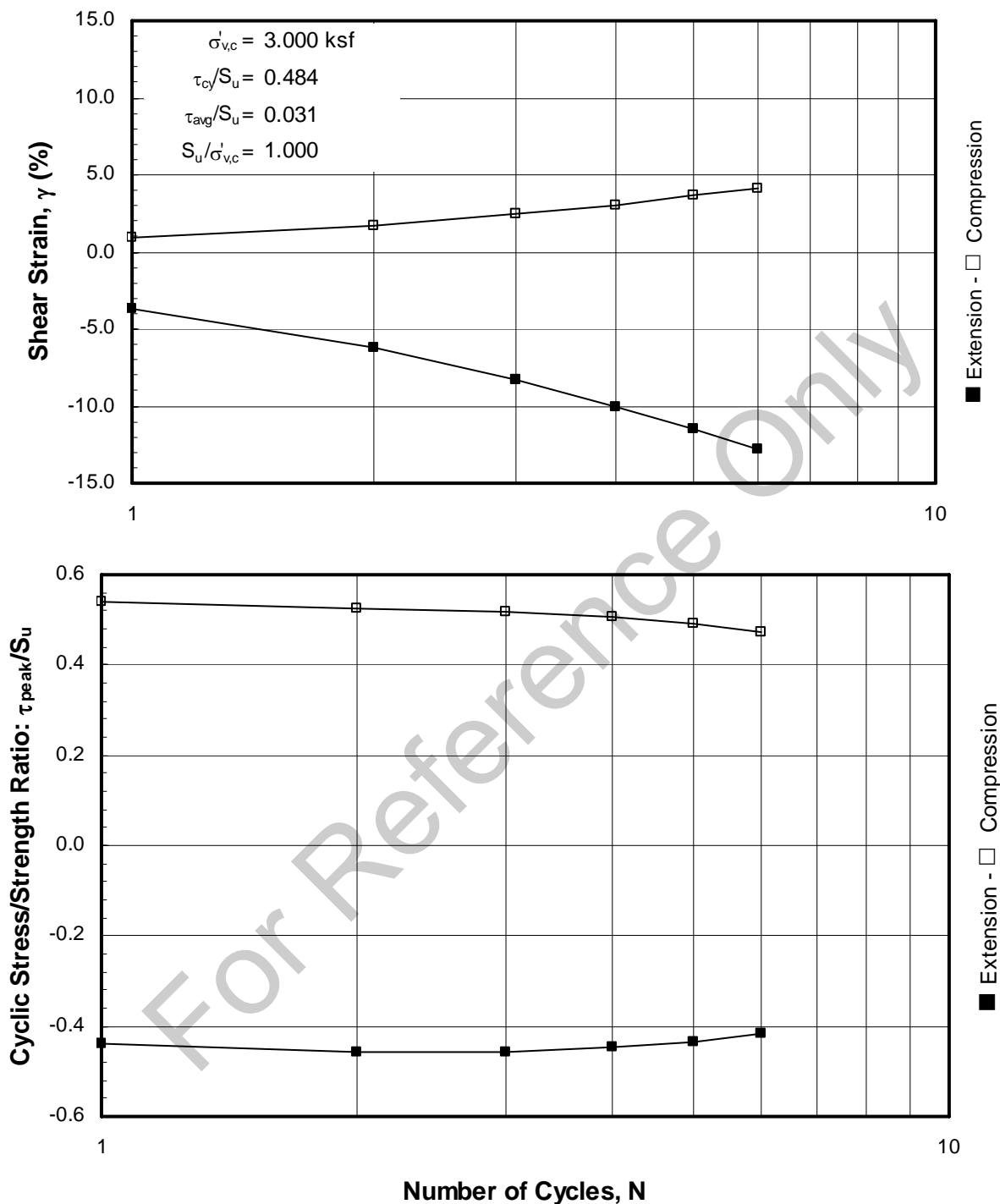

CYCLIC TRIAXIAL STRENGTH TEST: With Undrained Bias Stress

Isotropic Consolidation - OCR = 1 - Cyclic Rate: 1.0 Hz

Sample: S-9c - Depth: 31.65 ft.

Boring BH-105



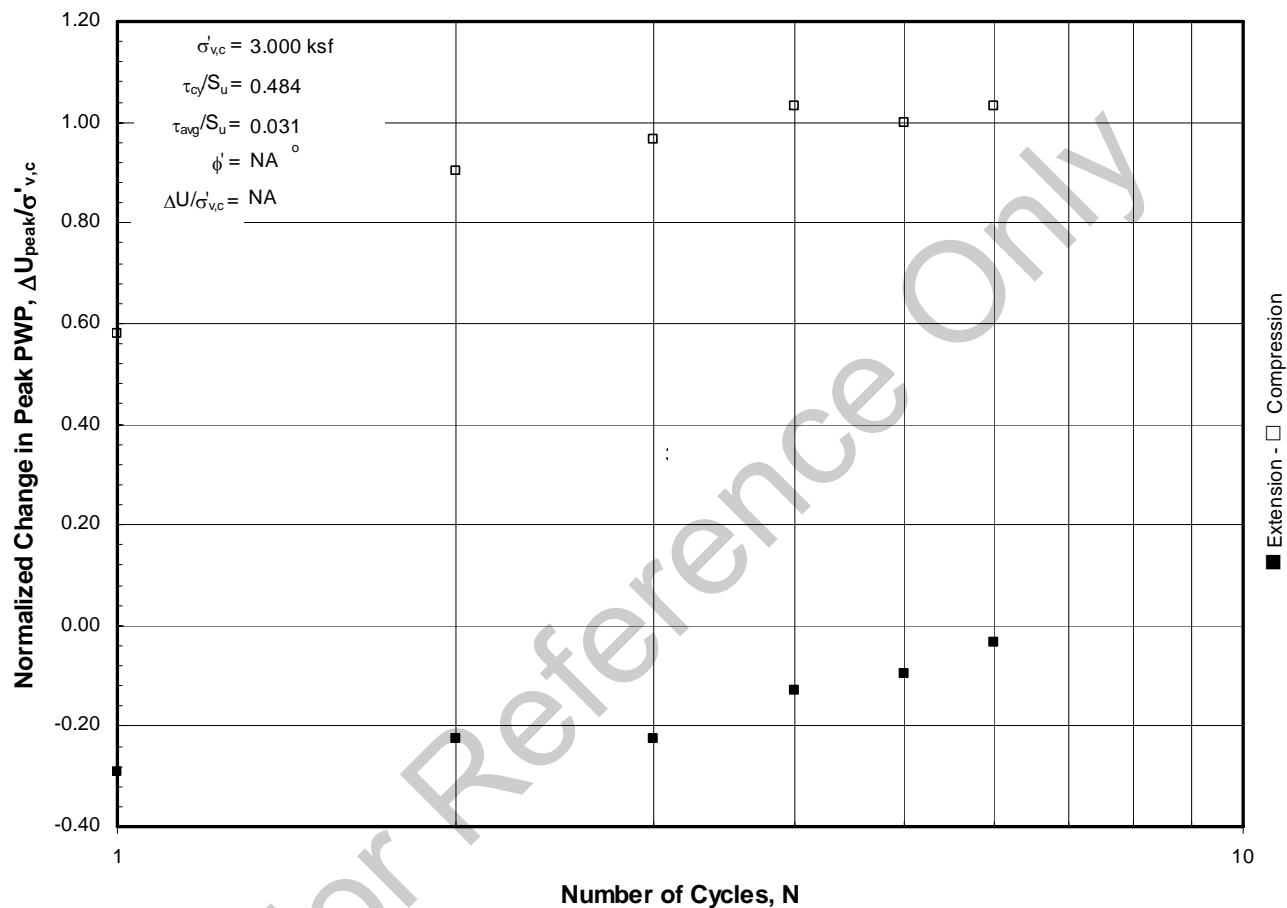

For Reference Only

CYCLIC TRIAXIAL STRENGTH TEST: With Undrained Bias Stress
 Isotropic Consolidation - OCR = 1 - Cyclic Rate: 1.0 Hz
 Sample: S-9c - Depth: 31.65 ft.
 Boring BH-105



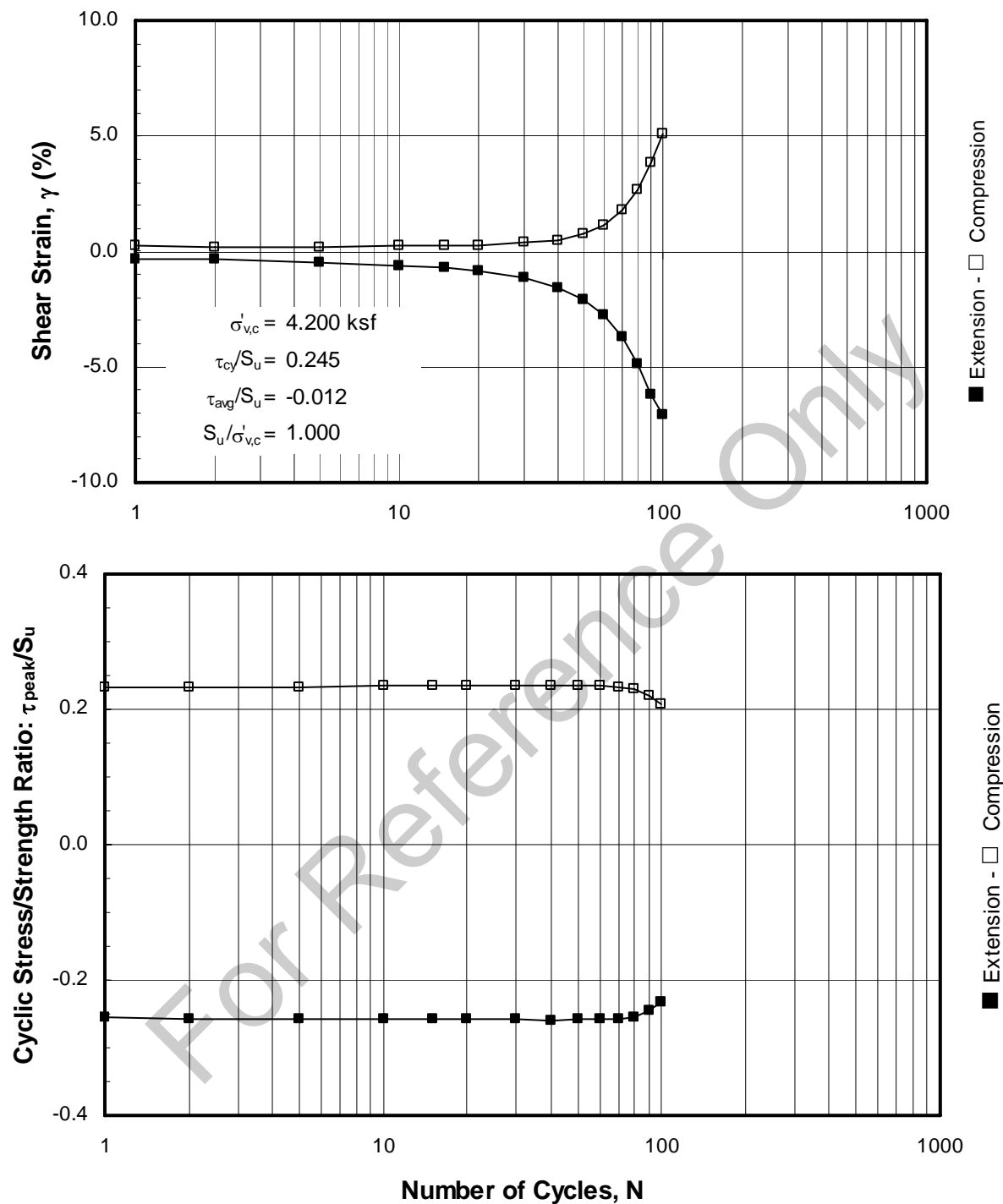

CYCLIC TRIAXIAL STRENGTH TEST: With Undrained Bias Stress

Isotropic Consolidation - OCR = 1 - Cyclic Rate: 1.0 Hz

Sample: S-17d - Depth: 52.10 ft.

Boring BH-90

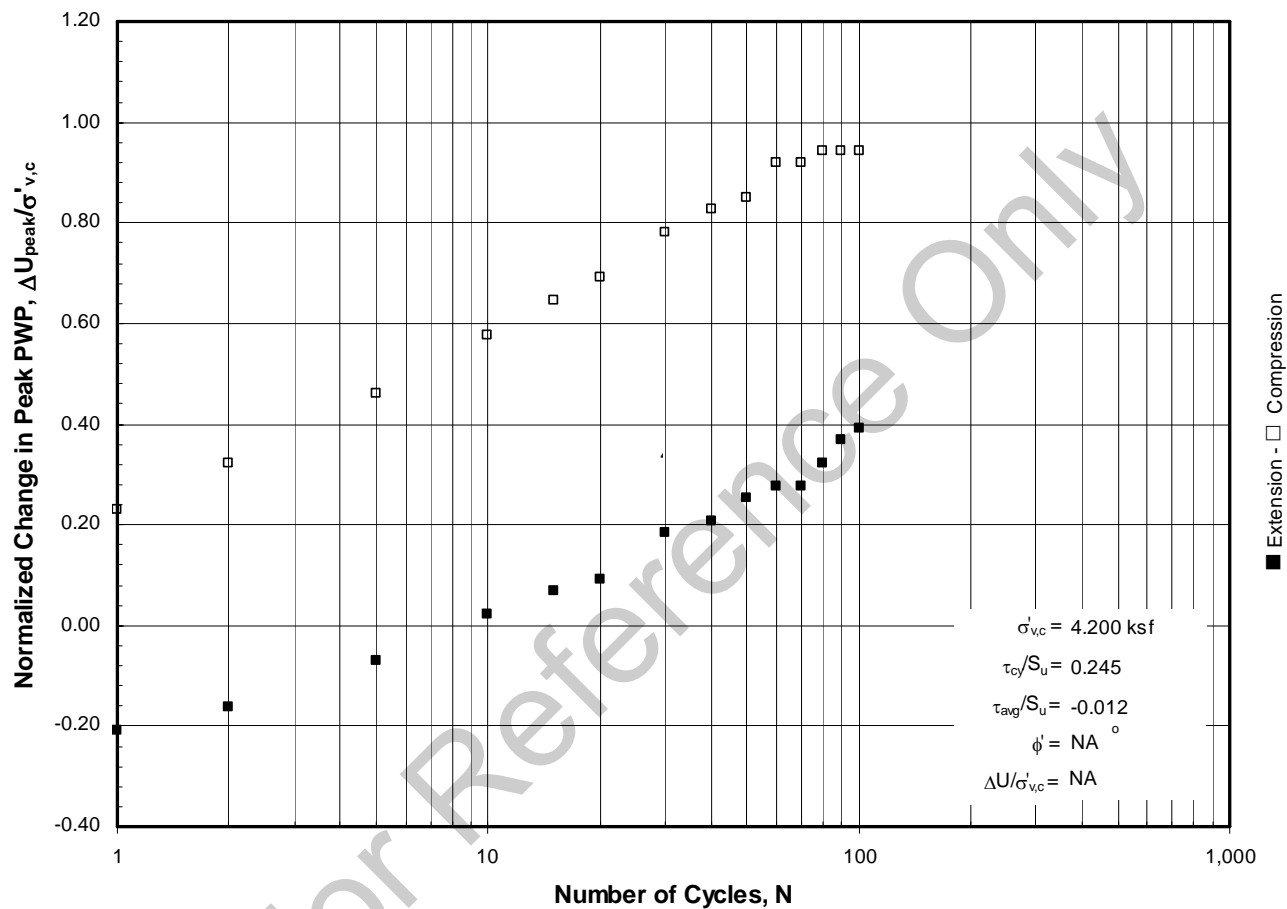

For Reference Only

CYCLIC TRIAXIAL STRENGTH TEST: With Undrained Bias Stress
 Isotropic Consolidation - OCR = 1 - Cyclic Rate: 1.0 Hz
 Sample: S-17d - Depth: 52.10 ft.
 Boring BH-90



LIQUID LIMIT, PLASTIC LIMIT, AND PLASTICITY INDEX: ASTM D 4318

Project Number: 1637-001
 Task Number: _____
 Project Name: _____

Test Spec. from Eng. Property Test:
 Yes; Trimmings; Spec.
 Type Test: CyCU ta=0

Boring No.: BH-90
 Sample No.: S-17/d
 Penetration/Depth (ft): 52.1

Visual Identification: Lean Clay or Silty clay success
is gray with some sand

Test No.: _____ of _____

Signs of organic soil behavior: No; Yes (spongy PL; signs of oxidation; organic fibers; black color, humus odor)

INITIAL VISUAL USCS GROUP SYMBOL (1): _____

TESTING EQUIPMENT USED	
Plastic Limit:	Hand Rolled <input checked="" type="checkbox"/>
	Between Glass Plates <input checked="" type="checkbox"/>
	Mechanical Rolling Device <input checked="" type="checkbox"/>
Liquid Limit:	Manual <input checked="" type="checkbox"/>
	Mechanical <input type="checkbox"/>
Apparatus No. ()	
Casagrande / ASTM	Metal <input type="checkbox"/>
Grooving Tool:	Plastic <input checked="" type="checkbox"/>

SPECIMEN PREPARATION	
Wet <input checked="" type="checkbox"/>	Washed on # 40 Sieve <input checked="" type="checkbox"/>
Dry (Air) <input type="checkbox"/>	Dry Sieved on # 40 Sieve <input type="checkbox"/>
Dry (Oven) <input type="checkbox"/>	Mechanically Pushed Through # 40 Sieve <input checked="" type="checkbox"/>
Mixed on Glass Plate and Removed Medium Plus Sand Particles	
Mixing water <input checked="" type="checkbox"/> Distilled;	<input type="checkbox"/> Demineralized; or other

AS-RECEIVED WATER CONTENT (OVEN DRIED)

Container No.		
Mass Moist Soil + Container, M1 (g)		
Mass Dry Soil + Container, M2 (g)		
Mass Container, M3 (g)		
WATER CONTENT, w_o (%)		Average

Circle Approximate Max. Grain Size in "Sample": 3" 1-1/2" 3/4" 3/8" 3/8" #4 #10 <#10

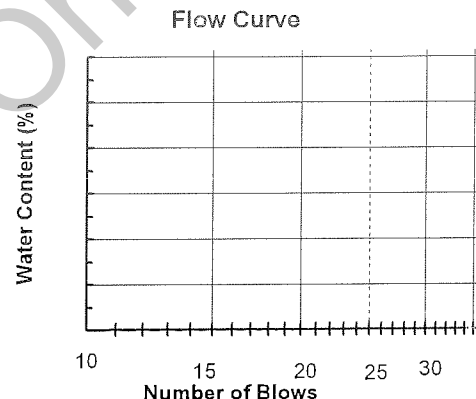

PLASTIC LIMIT

Container No.		
Mass Moist Soil + Container, M1 (g)	<u>8.81</u>	<u>9.14</u>
Mass Dry Soil + Container, M2 (g)	<u>7.49</u>	<u>7.16</u>
Mass Container, M3 (g)	<u>1.27</u>	<u>1.27</u>
WATER CONTENT, w (%)	<u>21.2</u>	<u>21.3</u>
		Average

LIQUID LIMIT

Container No.		
Mass Moist Soil + Container, M1 (g)	<u>9.68</u>	<u>10.17</u>
Mass Dry Soil + Container, M2 (g)	<u>7.67</u>	<u>8.05</u>
Mass Container, M3 (g)	<u>1.27</u>	<u>1.27</u>
WATER CONTENT, w (%)	<u>31.4</u>	<u>31.3</u>
NUMBER OF BLOWS, N	<u>21</u>	<u>22</u>
LIQUID LIMIT, ASTM SINGLE POINT		Average

LINEAR REGRESSION ANALYSIS	
w at N = 25 Blows	
Coef. of Determination, r ²	

Recommended range of Blow Count for Multiple Point Method A :
 15 to 25, 20 to 30, and 25 to 35.
 Recommended range of Blow Count for Single Point Method B :
 20 to 30.

$w_o \text{ or } w = ((M1-M2) / (M2-M3)) \times 100$
 LL = Water Content at N=25 blows, from Flow Curve.
 LL by Single Point = $w \times (N / 25)^{0.121}$
 PI = LL - PL
 LI = $(w_o - PL) / (LL - PL)$

NOTES: (1) USCS: Unified Soil Classification System.
 (2) Wet = Wet Preparation Method, and Dry = Dry Preparation Method

REMARKS: _____

SUMMARY

TEST METHOD (2)	A	B	Wet	Dry
AS-RECEIVED WATER CONTENT, w _o (%)			<input checked="" type="checkbox"/>	<input type="checkbox"/>
LIQUID LIMIT, LL				31
PLASTIC LIMIT, PL				21
PLASTICITY INDEX, PI				10
LIQUIDITY INDEX, LI				
PERCENTAGE POINTS ABOVE/BELOW A-LINE				
PLASTICITY CHART CLASSIFICATION				

Prepared By: NLH
 Tested By: LR

Date: 1-22-08
 Date: 1-23-08

Dry Masses By: CE/ky
 Calculated By: cy 1-24-08

Spot Checked By: KB 1-24-08
 Reviewed By: _____

Date Assigned: 10/22/2007

AL on Sandy lean Clay

LIQUID LIMIT, PLASTIC LIMIT, AND PLASTICITY INDEX: ASTM D 4318

Project Number: 1637-001 Test Spec. from Eng. Property Test:
 Task Number: _____ Yes; Trimmings; Spec.
 Project Name: _____ Type Test: CyCU ta=0 Boring No.: BH-91
 Visual Identification: cl fi. 5a dk g w/ few br. ppts Sample No.: S-10a
 Penetration/Depth (ft): 38.9
 Test No.: _____ of _____

Signs of organic soil behavior: No; Yes (spongy PL; signs of oxidation; organic fibers; black color, humus odor)

INITIAL VISUAL USCS GROUP SYMBOL (1): _____

TESTING EQUIPMENT USED	
Plastic Limit:	Hand Rolled <input checked="" type="checkbox"/>
	Between Glass Plates <input type="checkbox"/>
	Mechanical Rolling Device <input type="checkbox"/>
Liquid Limit:	Manual <input checked="" type="checkbox"/>
	Mechanical <input type="checkbox"/>
Apparatus No. ()	
Casagrande / ASTM	Metal <input type="checkbox"/>
Grooving Tool:	Plastic <input checked="" type="checkbox"/>

SPECIMEN PREPARATION	
Wet <input checked="" type="checkbox"/>	Washed on # 40 Sieve
Dry (Air) <input type="checkbox"/>	Dry Sieved on # 40 Sieve
Dry (Oven) <input type="checkbox"/>	Mechanically Pushed Through # 40 Sieve
Mixed on Glass Plate and Removed Medium Plus Sand Particles	
Mixing water <input checked="" type="checkbox"/> Distilled; <input type="checkbox"/> Demineralized; or other	

AS-RECEIVED WATER CONTENT (OVEN DRIED)

Container No.			
Mass Moist Soil + Container, M1 (g)			
Mass Dry Soil + Container, M2 (g)			
Mass Container, M3 (g)			Average
WATER CONTENT, w_o (%)			

Circle Approximate Max. Grain Size in "Sample": 3" 1-1/2" 3/4" 3/8" 3/8" #4 #10 <#10

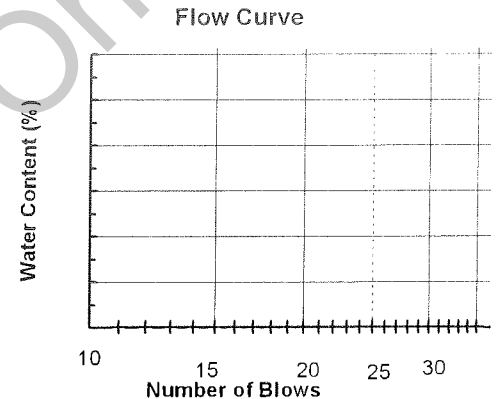

PLASTIC LIMIT

Container No.			
Mass Moist Soil + Container, M1 (g)	<i>18.12</i>	<i>7.90</i>	
Mass Dry Soil + Container, M2 (g)	<i>6.95</i>	<i>6.85</i>	
Mass Container, M3 (g)	<i>1.32</i>	<i>1.24</i>	Average
WATER CONTENT, w (%)			<i>19</i>

LIQUID LIMIT

Container No.			
Mass Moist Soil + Container, M1 (g)	<i>15.20</i>	<i>17.68</i>	
Mass Dry Soil + Container, M2 (g)	<i>12.36</i>	<i>14.24</i>	
Mass Container, M3 (g)	<i>1.32</i>	<i>1.22</i>	
WATER CONTENT, w (%)			<i>26.6</i>
NUMBER OF BLOWS, N			<i>23</i>
LIQUID LIMIT, ASTM SINGLE POINT			<i>26</i>

LINEAR REGRESSION ANALYSIS	
w at N = 25 Blows	
Coef. of Determination, r^2	

Recommended range of Blow Count for Multiple Point Method A : 15 to 25, 20 to 30, and 25 to 35.

Recommended range of Blow Count for Single Point Method B: 20 to 30.

w_o or $w = (M1-M2) / (M2-M3) \times 100$

LL = Water Content at N=25 blows, from Flow Curve.

LL by Single Point = $w \times (N / 25)^{0.121}$

PI = LL - PL

LI = $(w_o - PL) / (LL - PL)$

NOTES: (1) USCS: Unified Soil Classification System.

(2) Wet = Wet Preparation Method, and Dry = Dry Preparation Method

REMARKS: Maybe Non-Plastic

SUMMARY

TEST METHOD (2)	A	B	Wet	Dry
AS-RECEIVED WATER CONTENT, w_o (%)			<input checked="" type="checkbox"/>	<input type="checkbox"/>
LIQUID LIMIT, LL				<i>26</i>
PLASTIC LIMIT, PL				<i>19</i>
PLASTICITY INDEX, PI				<i>7</i>
LIQUIDITY INDEX, LI				
PERCENTAGE POINTS ABOVE/BELOW A-LINE				
PLASTICITY CHART CLASSIFICATION				

Prepared By: V.H Date: 11/12/07
 Tested By: CR Date: 11/12

Dry Masses By: CR 11/14
 Calculated By: cy 11.14.07

Checked By: PK 11-15-07
 Spot Checked By: _____
 Reviewed By: _____

LIQUID LIMIT, PLASTIC LIMIT, AND PLASTICITY INDEX: ASTM D 4318

Project Number: 1637-001
 Task Number: _____
 Project Name: _____

Test Spec. from Eng. Property Test:
 Yes; Trimmings; Spec.
 Type Test: CyCU ta=0

Boring No.: BH-105
 Sample No.: S-9a
 Penetration/Depth (ft): 32.45
 Test No.: _____ of _____

Visual Identification: CL Dr Grny w/ Si, S, Sa P&S, organics

Signs of organic soil behavior: No; Yes (spongy PL; signs of oxidation; organic fibers; black color, humus odor)

INITIAL VISUAL USCS GROUP SYMBOL (1): _____

TESTING EQUIPMENT USED	
Plastic Limit:	Hand Rolled <input checked="" type="checkbox"/>
	Between Glass Plates <input type="checkbox"/>
	Mechanical Rolling Device <input type="checkbox"/>
Liquid Limit:	Manual <input checked="" type="checkbox"/>
	Mechanical <input type="checkbox"/>
Apparatus No. ()	
Casagrande / ASTM	Metal <input type="checkbox"/>
Grooving Tool:	Plastic <input checked="" type="checkbox"/>

SPECIMEN PREPARATION	
Wet <input checked="" type="checkbox"/>	Washed on # 40 Sieve
Dry (Air) <input type="checkbox"/>	Dry Sieved on # 40 Sieve
Dry (Oven) <input type="checkbox"/>	Mechanically Pushed Through # 40 Sieve <input checked="" type="checkbox"/>
Mixed on Glass Plate and Removed Medium Plus Sand Particles	
Mixing water	Distilled; <input checked="" type="checkbox"/> Demineralized; or other

AS-RECEIVED WATER CONTENT (OVEN DRIED)

Container No.			
Mass Moist Soil + Container, M1 (g)			
Mass Dry Soil + Container, M2 (g)			
Mass Container, M3 (g)			Average
WATER CONTENT, w_o (%)			
Circle Approximate Max. Grain Size in "Sample": 3" 1-1/2" 3/4" 3/8" 3/8" #4 #10 <#10			

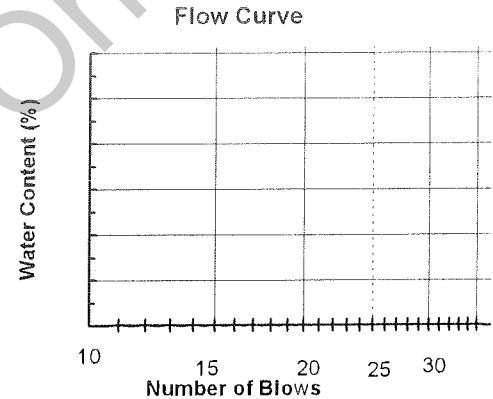

PLASTIC LIMIT

Container No.	11	12		
Mass Moist Soil + Container, M1 (g)	8.24	8.14		
Mass Dry Soil + Container, M2 (g)	7.02	6.95		
Mass Container, M3 (g)	1.27	1.27		Average
WATER CONTENT, w (%)			21.2	21.0
			21	

LIQUID LIMIT

Container No.	9	10		
Mass Moist Soil + Container, M1 (g)	12.01	11.23		
Mass Dry Soil + Container, M2 (g)	8.84	8.79		
Mass Container, M3 (g)	1.28	1.27		
WATER CONTENT, w (%)			41.9	41.9
NUMBER OF BLOWS, N			24	27
LIQUID LIMIT, ASTM SINGLE POINT			42	

LINEAR REGRESSION ANALYSIS	
w at N = 25 Blows	
Coef. of Determination, r ²	

Recommended range of Blow Count for Multiple Point Method A : 15 to 25, 20 to 30, and 25 to 35.

Recommended range of Blow Count for Single Point Method B: 20 to 30.

w_o or $w = (M1 - M2) / (M2 - M3) \times 100$

LL = Water Content at N=25 blows, from Flow Curve.

LL by Single Point = $w \times (N / 25)^{0.121}$

PI = LL - PL

LI = $(w_o - PL) / (LL - PL)$

NOTES: (1) USCS: Unified Soil Classification System.

(2) Wet = Wet Preparation Method, and Dry = Dry Preparation Method

REMARKS: _____

SUMMARY

TEST METHOD (2)	A	B	Wet	Dry
AS-RECEIVED WATER CONTENT, w _o (%)			<input checked="" type="checkbox"/>	<input type="checkbox"/>
LIQUID LIMIT, LL				42
PLASTIC LIMIT, PL				21
PLASTICITY INDEX, PI				21
LIQUIDITY INDEX, LI				
PERCENTAGE POINTS ABOVE/BELOW A-LINE				
PLASTICITY CHART CLASSIFICATION				

Prepared By: ALC
 Tested By: ALC

Date: 11-5-07
 Date: 11-7-07

Dry Masses By: CP 11/8
 Calculated By: CP 11-8-07

Checked By: PJK 11-8
 Spot Checked By: _____
 Reviewed By: _____

LIQUID LIMIT, PLASTIC LIMIT, AND PLASTICITY INDEX: ASTM D 4318

Project Number: 1637-001
 Task Number: _____
 Project Name: _____
 Visual Identification: Clayey silty sand tan & gray

Test Spec. from Eng. Property Test:
 Yes; Trimmings; Spec.
 Type Test: CyCU ta=0

Boring No.: BH-90
 Sample No.: S-11a
 Penetration/Depth (ft): 37.5
 Test No.: _____ of _____

Signs of organic soil behavior: No; Yes (spongy PL; signs of oxidation; organic fibers; black color, humus odor)

INITIAL VISUAL USCS GROUP SYMBOL (1): _____

TESTING EQUIPMENT USED	
Plastic Limit:	Hand Rolled <input checked="" type="checkbox"/>
	Between Glass Plates <input type="checkbox"/>
	Mechanical Rolling Device <input type="checkbox"/>
Liquid Limit:	Manual <input checked="" type="checkbox"/>
Apparatus No. ()	Mechanical <input type="checkbox"/>
Casagrande / ASTM	Metal <input type="checkbox"/>
Grooving Tool:	Plastic <input checked="" type="checkbox"/>

SPECIMEN PREPARATION	
Wet <input checked="" type="checkbox"/>	Washed on # 40 Sieve
Dry (Air) <input type="checkbox"/>	Dry Sieved on # 40 Sieve
Dry (Oven) <input type="checkbox"/>	Mechanically Pushed Through # 40 Sieve
Mixed on Glass Plate and Removed Medium Plus Sand Particles	
Mixing water <input checked="" type="checkbox"/> Distilled;	<input type="checkbox"/> Demineralized; or other

AS-RECEIVED WATER CONTENT (OVEN DRIED)

Container No.			
Mass Moist Soil + Container, M1 (g)			
Mass Dry Soil + Container, M2 (g)			
Mass Container, M3 (g)			Average
WATER CONTENT, w_o (%)			

Circle Approximate Max. Grain Size in "Sample": 3" 1-1/2" 3/4" 3/8" 3/8" #4 #10 <#10

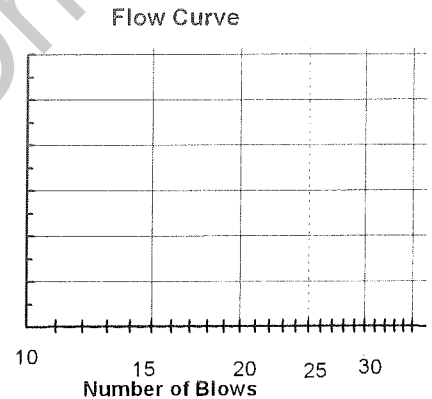

PLASTIC LIMIT

Container No.	31	32	
Mass Moist Soil + Container, M1 (g)	8.27	8.16	
Mass Dry Soil + Container, M2 (g)	7.15	7.02	
Mass Container, M3 (g)	1.26	1.27	Average
WATER CONTENT, w (%)			19

LIQUID LIMIT

Container No.	29	30		
Mass Moist Soil + Container, M1 (g)	10.17	10.13		
Mass Dry Soil + Container, M2 (g)	8.52	8.19		
Mass Container, M3 (g)	1.27	1.28		
WATER CONTENT, w (%)			22.8	22.7
NUMBER OF BLOWS, N			22	23
LIQUID LIMIT, ASTM SINGLE POINT			Average	
			22	

LINEAR REGRESSION ANALYSIS	
w at N = 25 Blows	
Coef. of Determination, r ²	

Recommended range of Blow Count for Multiple Point Method A :
 15 to 25, 20 to 30, and 25 to 35.
 Recommended range of Blow Count for Single Point Method B:
 20 to 30.

w_o or $w = (M1-M2) / (M2-M3) \times 100$
 $LL = \text{Water Content at } N=25 \text{ blows, from Flow Curve.}$
 $LL \text{ by Single Point} = w \times (N / 25)^{0.121}$
 $PI = LL - PL$
 $LI = (w_o - PL) / (LL - PL)$

NOTES: (1) USCS: Unified Soil Classification System.
 (2) Wet = Wet Preparation Method, and Dry = Dry Preparation Method

REMARKS: Maybe non-plastic

SUMMARY

TEST METHOD (2)	A	B	Wet <input checked="" type="checkbox"/>	Dry <input type="checkbox"/>
AS-RECEIVED WATER CONTENT, w _o (%)				
LIQUID LIMIT, LL				22
PLASTIC LIMIT, PL				19
PLASTICITY INDEX, PI				3
LIQUIDITY INDEX, LI				
PERCENTAGE POINTS ABOVE/BELOW A-LINE				
PLASTICITY CHART CLASSIFICATION				

Prepared By: VLH Date: 1-14-08
 Tested By: HC Date: 1-15-08

Dry Masses By: CR 1-16
 Calculated By: CF 1-16-08

Checked By: KBI-17-08
 Spot Checked By: _____
 Reviewed By: _____



PERCENT FINES (ASTM D 1140)

TESTED BY:	DATE:	COMPUTED BY:	DATE:	REVIEWED BY:	DATE:	DATE	PROJECT NAME			PROJECT NO.:		
						October 22, 2007						
						Boring No.	Sample No.	Depth (ft)	Visual Identification (Color, Group Name & Symbol)	Initial Dry Mass of Soil (g)	Dry Mass of Soil After Washing & Shaking Over 75 μm Sieve	% Passing 75 μm Sieve
RNC	1/28/08	CJ	1-28-08	KB	1-29-08	BH-90	S-17d	520'	Fine Clay or Silty Clay brown gray at some sand	30.85	5.80	81.2

For Reference Only

REMARKS



DETERMINATION OF PERCENTAGE OF FINES (ASTM D 1140)

DATE	10/22/07			PROJECT NAME	CyCU ta=0			PROJECT NO.:	1637-001	
	Boring No.	Sample No.	Depth (ft)	Material Description	Initial Dry Mass of Soil (g)	Dry Mass of Soil After Washing & Shaking Over 74 μ m Sieve	% Passing 74 μ m Sieve			
	BH-91	S-10a	38.9	Silty sand, dark gray w/ clayey sandstone	72.75	40.47	46.6			

For Reference Only

TESTED BY: *TRG* DATE: *11/14/07*

COMPUTED BY: *CF* DATE: *11/14/07*

CHECKED BY: *PK* DATE: *11/15/07*

REMARKS _____



DETERMINATION OF PERCENTAGE OF FINES (ASTM D 1140)

TESTED BY: 12/16	DATE: 11/2/07	COMPUTED BY: CJ	DATE: 11/8/07	CHECKED BY: PK	DATE: 11/8/07	DATE	PROJECT	PROJECT	
						10/22/07	NAME	CyCU ta=0	NO.:
Boring No.	Sample No.	Depth (ft)	Material Description	Initial Dry Mass of Soil (g)	Dry Mass of Soil After Washing & Shaking Over 74 μ m Sieve	% Passing 74 μ m Sieve			
BH-105	S-9a	32.45	Si. Sa. Ok G	75.68	46.90	38.0			

REMARKS _____



DETERMINATION OF PERCENTAGE OF FINES (ASTM D 1140)

DATE		PROJECT NAME		PROJECT NO.:		
10/22/07		CyCU ta=0		1637-001		
Boring No.	Sample No.	Depth (ft)	Material Description	Initial Dry Mass of Soil (g)	Dry Mass of Soil After Washing & Shaking Over 74 µ m Sieve	% Passing 74 µ m Sieve
BH-90	S-11a	37.5	clay silty sand, tan & gray	30.97	18.04	41.75

TESTED BY: *[Signature]*
 DATE: 1/17/08
 COMPUTED BY: *[Signature]*
 DATE: 1/17/08
 CHECKED BY: *[Signature]*
 DATE: 1-18-08

REMARKS _____

For Reference Only

[Handwritten]
 41.8

Appendix 6: Large-Scale Direct Shear Test Results

For Reference Only

Prepared for:

Hatch Mott Macdonald
3103 N. 1st St., Building B, Suite 200
San Jose, CA 95134

FINAL REPORT

**PARTICLE-SIZE ANALYSIS, RELATIVE
DENSITY, AND DIRECT SHEAR TESTING**

**SILICON VALLEY
RAPID TRANSIT PROJECT**

Prepared by:



SGI TESTING SERVICES, LLC

4405 International Blvd., Suite B-117
Norcross, GA 30093

Project Number SGI7047

18 January 2008

CAVEAT

The reported results apply only to the materials and test conditions used in the laboratory testing program. The results do not necessarily apply to other materials or test conditions. The test results should not be used in engineering analysis unless the test conditions model the anticipated field conditions. The testing was performed in accordance with general engineering testing standards and requirements. This testing report is submitted for the exclusive use of the client to whom it is addressed.

For Reference Only

1. INTRODUCTION

SGI Testing Services, LLC (SGI) conducted a laboratory testing program to evaluate the particle-size distribution, relative density, and internal shear strength of four soil samples for the Silicon Valley Rapid Transit (SVRT) project. The sample preparation procedures and testing conditions used in the testing program were specified by Mr. Abhishek Jain of Hatch Mott Macdonald (HMM) to simulate anticipated field conditions. All of the tests were conducted at SGI located in Norcross, Georgia.

2. TEST MATERIALS

2.1 Soil Samples

Four types of soil materials were used in this testing program. Descriptions of the four materials are given below:

- Soil Sample MW-8A;
- Soil Sample MW-2B;
- Soil Sample MW-4A; and
- Soil Sample MW-6J.

Bulk samples of the four soil materials were provided to SGI by HMM.

2.2 Soil Processing and Index Property Testing

For each type of soil, the received bulk sample was first air-dried, mixed and separated into two portions. One portion of the air-dried soil sample was used for particle-size analysis in accordance with ASTM D 422, "*Particle-Size Analysis of Soils*". The results of the particle analysis are presented in Appendix A to this report. The other portion of soil sample was sieved by using a 1.25 in. sieve to remove the particles greater than 1.25 in. The remaining soil sample with all the particles passing through 1.25-in sieve, referred to as 1.25-in. minus material, was used for relative density testing in accordance with

ASTM D 4253, “*Maximum Index Density and Unit Weight of Soils Using a Vibratory Table*”, and ASTM D 4254, “*Minimum Index Density and Unit Weight of Soils and Calculation of Relative Density*”. The results of relative density tests for the four 1.25-in. minus materials are presented in Appendix B. The 1.25-in. minus materials of soil samples MW-8A, MW-2B, and MW-6J were subsequently used in direct shear testing.

3. DIRECT SHEAR TEST EQUIPMENT

The direct testing device used in this testing consisted an upper and lower shear box. The upper shear box measured 12 in. by 12 in. in plan and 3 in. in depth. The lower shear box measured 12 in. by 12 in. in plan and 3 in. in depth. Normal stresses were applied to the testing specimen through an air bladder system, and shear loads were applied to the test specimen through an automatically controlled motor system.

4. TEST METHOD AND PROCEDURES

The direct shear tests were performed in accordance with ASTM D 3080, “*Direct Shear Test of Soils under Consolidated Drained Conditions*”. For each direct shear test, the test was set up in accordance with the following procedures and tested under the specific conditions as described below:

- 1.25-in. minus material was moisture-conditioned to approximately the specified moisture content, and compacted by hand tamping in 2 in. thick lifts within the lower and upper shear boxes, to form a 6 in. thick test specimen. The target dry unit weight, corresponding to the specified relative density, was achieved by compacting a pre-determined amount of soil into a fixed volume (12 in. x 12 in. x 6 in.);
- A specific normal stress was applied to top of the test specimen through an air bladder system; and

- After the application of the normal stress, the test specimen was sheared at a constant shear displacement rate of 0.04 in/min. Shearing was continued until a minimum total shear displacement of 2.5 in. was achieved.

5. DIRECT SHEAR TEST RESULTS

Five series of direct shear tests were performed in this testing program. For each test series, the test results are presented on a summary page in Appendix C. The summary page includes:

- Shear force versus displacement figure;
- Shear strength versus normal stress figure; and
- A table that summarizes test conditions, peak shear strength, and large displacement (LD) shear strength at the end of test.

For each test series, the shear strength parameters of friction angle and cohesion were determined based on the best-fit straight line drawn through the test data points on a plot of shear strength versus normal stress, and reported on the summary page. Caution should be exercised in using these shear strength parameters for applications involving normal stresses outside the range of stresses covered by the test series.

6. CLOSURE

The reported test results apply only to the materials and test conditions used in the laboratory testing program. The test results do not necessarily apply to other materials or test conditions. The test results should not be used in engineering analysis unless the test conditions model the anticipated field conditions. The testing was performed in accordance with general engineering testing standards and requirements. This testing report is submitted for the exclusive use of HMM.

APPENDIX A

RESULTS OF PARTICLE SIZE ANALYSIS

For Reference Only



SGI Testing Services, LLC

4405 International Blvd., Suite B-117, Norcross, GA 30093
 Ph: (770) 931-8222 Fax: (770) 931-8240

Project Name: SVRT
 Project No: SGI7047
 Client Sample ID: Soil Sample MW-8A
 Lab Sample No: S13087

ASTM D 2216, D 1140, D 422,
 C 136, D 4318, D 2487

SOIL INDEX PROPERTIES

Moisture Content, Grain Size, Atterberg
 Limits, Classification

Boulder	Cobbles	Coarse	Fine	Coarse	Medium	Fine	Silt	Clay
		Gravel		Sand				

U.S. Standard Sieve Sizes and Numbers														
12"	3"	2"	1.5"	1"	3/4"	1/2"	3/8"	#4	#10	#20	#40	#60	#100	#200

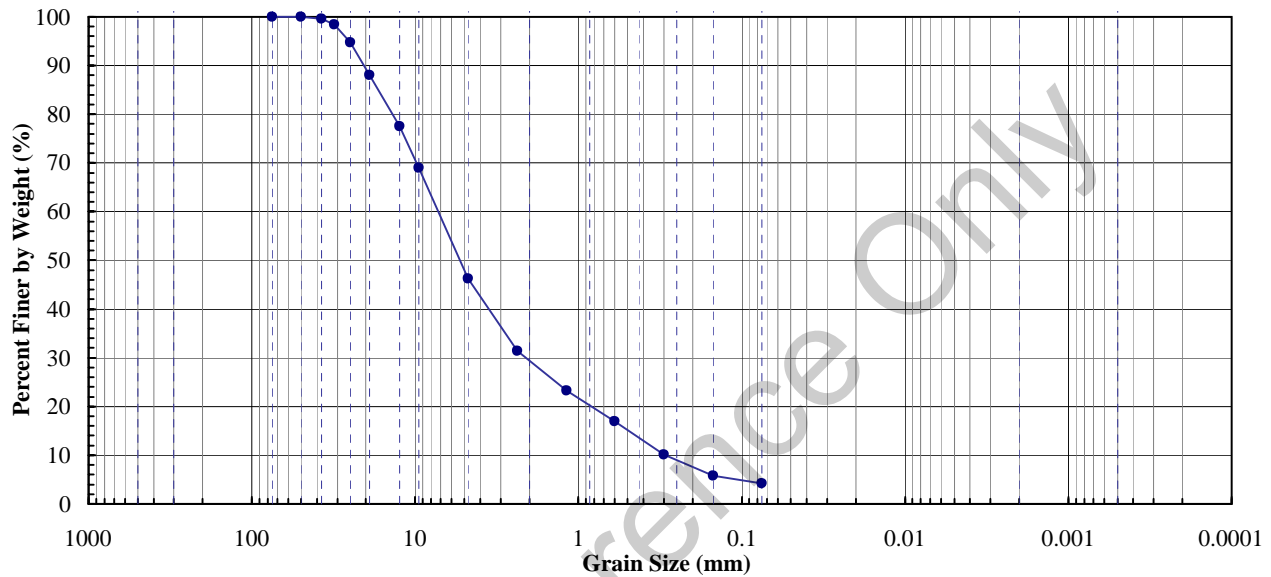

Sieve No.	Size (mm)	% Finer
3"	75	100.0
2"	50	100.0
1.5"	37.5	99.6
1.25"	31.25	98.4
1"	25	94.8
3/4"	19	88.0
1/2"	12.5	77.5
3/8"	9.5	69.0
#4	4.75	46.3
#8	2.00	31.4
#16	0.850	23.2
#30	0.425	16.9
#50	0.250	10.1
#100	0.150	5.8
#200	0.075	4.2

Hydrometer Particle Diameter (mm)	% Finer
0.0310	
0.0200	
0.0061	
0.0031	
0.0013	

Gravel (%):	53.7
Sand (%):	42.1
Fines (%):	4.2
Silt (%):	
Clay (%):	

Coeff. Unif. (Cu):	24.0
Coeff. Curv. (Cc):	2.0

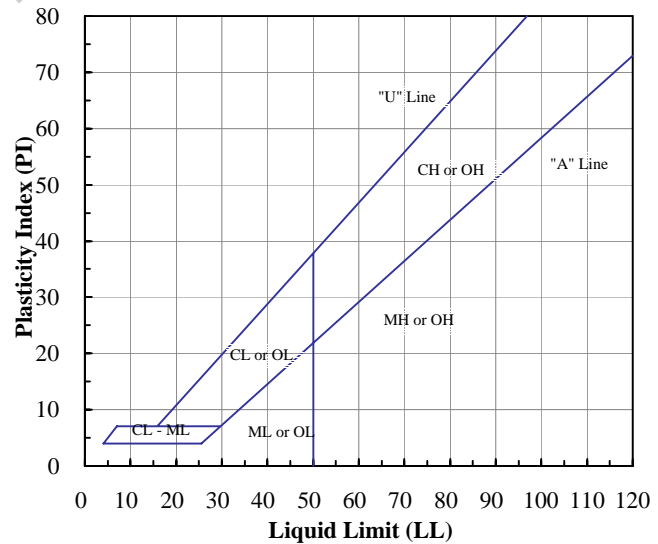

Client Sample ID.	Lab Sample No.	Moisture Content (%)	Fines Content < No. 200 (%)	Atterberg Limits			Engineering Classification
				LL (%)	PL (%)	PI (-)	
Soil MW-8A	S13087		4.2				GW

Note(s):



SGI Testing Services, LLC

4405 International Blvd., Suite B-117, Norcross, GA 30093
 Ph: (770) 931-8222 Fax: (770) 931-8240

Project Name: SVRT
 Project No: SGI7047
 Client Sample ID: Soil Sample MW-2B
 Lab Sample No: S13088

ASTM D 2216, D 1140, D 422,
 C 136, D 4318, D 2487

SOIL INDEX PROPERTIES

Moisture Content, Grain Size, Atterberg
 Limits, Classification

Boulder	Cobbles	Coarse	Fine	Coarse	Medium	Fine	Silt	Clay
		Gravel		Sand				

U.S. Standard Sieve Sizes and Numbers														
12"	3"	2"	1.5"	1"	3/4"	1/2"	3/8"	#4	#10	#20	#40	#60	#100	#200

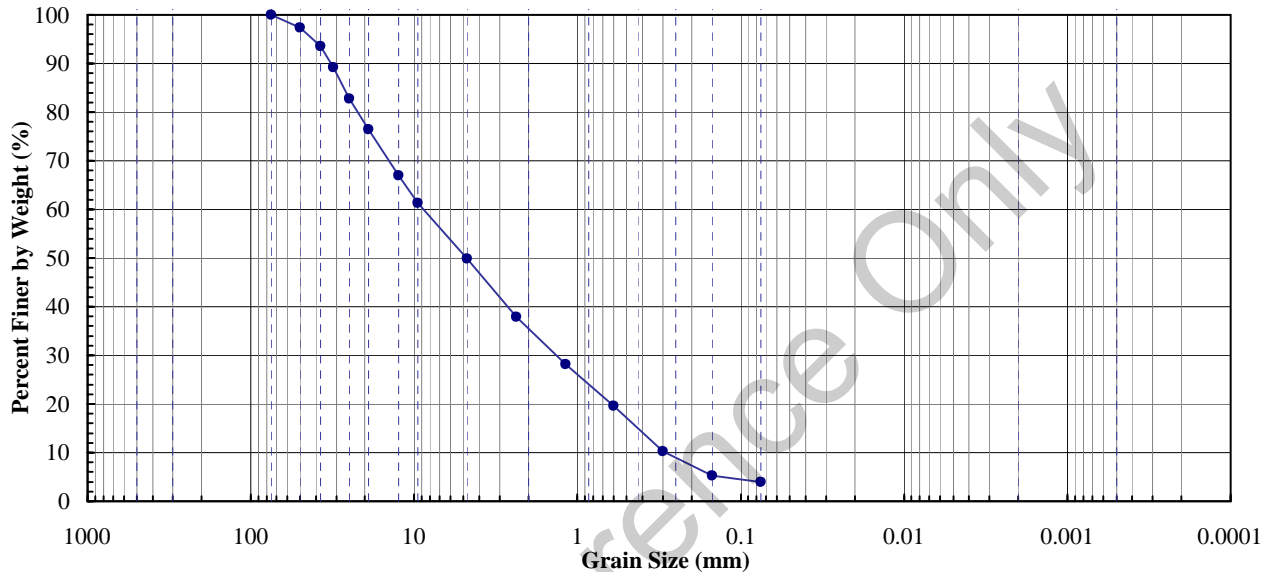

Sieve No.	Size (mm)	% Finer
3"	75	100.0
2"	50	97.4
1.5"	37.5	93.5
1.25"	31.25	89.2
1"	25	82.7
3/4"	19	76.5
1/2"	12.5	67.0
3/8"	9.5	61.3
#4	4.75	49.9
#8	2.00	37.9
#16	0.850	28.1
#30	0.425	19.6
#50	0.250	10.3
#100	0.150	5.3
#200	0.075	4.0

Hydrometer Particle Diameter (mm)	% Finer
0.0310	
0.0200	
0.0061	
0.0031	
0.0013	

Gravel (%):	50.1
Sand (%):	45.9
Fines (%):	4.0
Silt (%):	
Clay (%):	

Coeff. Unif. (Cu):	31.0
Coeff. Curv. (Cc):	0.7

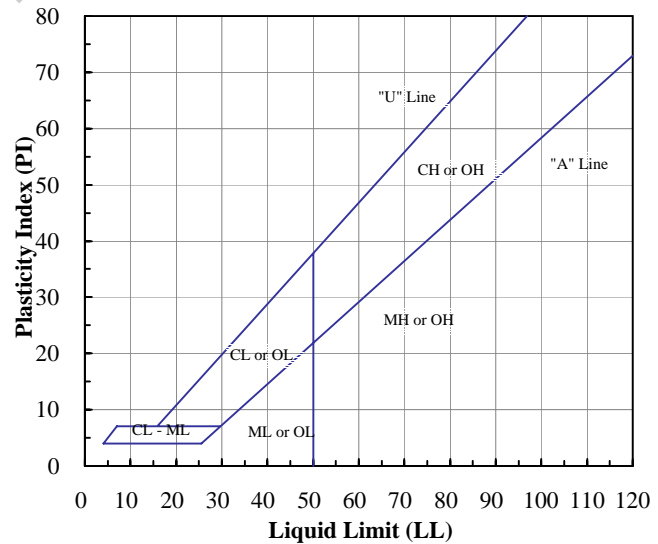

Client Sample ID	Lab Sample No:	Moisture Content (%)	Fines Content < No. 200 (%)	Atterberg Limits			Engineering Classification
				LL (%)	PL (%)	PI (-)	
Soil MW-2B	S13088		4.0				GP

Note(s):



SGI Testing Services, LLC

4405 International Blvd., Suite B-117, Norcross, GA 30093
 Ph: (770) 931-8222 Fax: (770) 931-8240

Project Name: SVRT
 Project No: SGI7047
 Client Sample ID: Soil Sample MW-4A
 Lab Sample No: S13089

ASTM D 2216, D 1140, D 422,
 C 136, D 4318, D 2487

SOIL INDEX PROPERTIES

Moisture Content, Grain Size, Atterberg
 Limits, Classification

Boulder	Cobbles	Coarse	Fine	Coarse	Medium	Fine	Silt	Clay
		Gravel		Sand				

U.S. Standard Sieve Sizes and Numbers														
12"	3"	2"	1.5"	1"	3/4"	1/2"	3/8"	#4	#10	#20	#40	#60	#100	#200

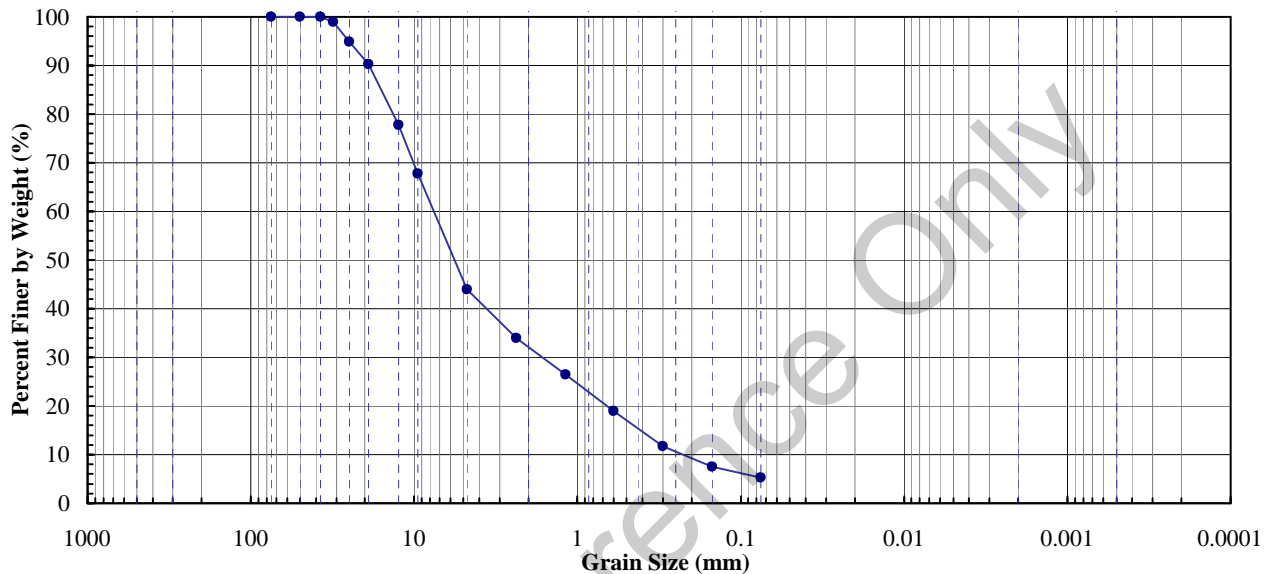

Sieve No.	Size (mm)	% Finer
3"	75	100.0
2"	50	100.0
1.5"	37.5	100.0
1.25"	31.25	98.9
1"	25	94.9
3/4"	19	90.2
1/2"	12.5	77.7
3/8"	9.5	67.8
#4	4.75	44.0
#8	2.00	34.0
#16	0.850	26.4
#30	0.425	19.0
#50	0.250	11.7
#100	0.150	7.5
#200	0.075	5.3

Hydrometer Particle Diameter (mm)	% Finer
0.0310	
0.0200	
0.0061	
0.0031	
0.0013	

Gravel (%):	56
Sand (%):	38.7
Fines (%):	5.3
Silt (%):	
Clay (%):	

Coeff. Unif. (Cu):	34.0
Coeff. Curv. (Cc):	1.7

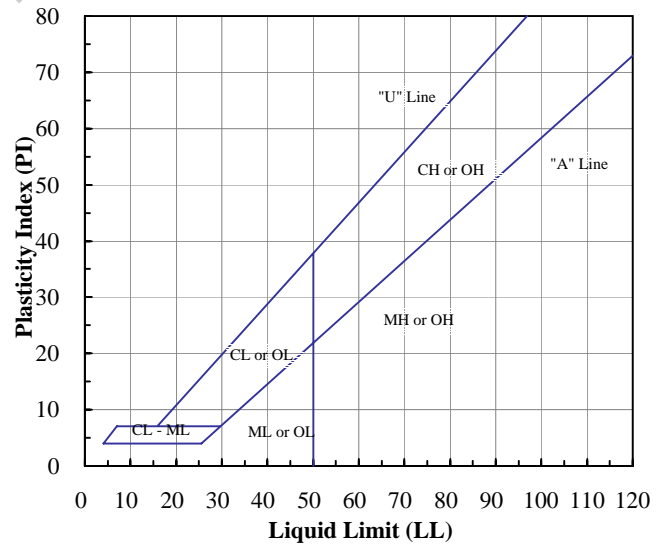

Client Sample ID	Lab Sample No:	Moisture Content (%)	Fines Content < No. 200 (%)	Atterberg Limits			Engineering Classification
				LL (%)	PL (%)	PI (-)	
Soil MW-4A	S13089		5.3				GW-GM

Note(s):



SGI Testing Services, LLC

4405 International Blvd., Suite B-117, Norcross, GA 30093
 Ph: (770) 931-8222 Fax: (770) 931-8240

Project Name: SVRT
 Project No: SGI7047
 Client Sample ID: Soil Sample MW-6J
 Lab Sample No: S13090

ASTM D 2216, D 1140, D 422,
 C 136, D 4318, D 2487

SOIL INDEX PROPERTIES

Moisture Content, Grain Size, Atterberg
 Limits, Classification

Boulder	Cobbles	Coarse	Fine	Coarse	Medium	Fine	Silt	Clay
		Gravel		Sand				

U.S. Standard Sieve Sizes and Numbers														
12"	3"	2"	1.5"	1"	3/4"	1/2"	3/8"	#4	#10	#20	#40	#60	#100	#200

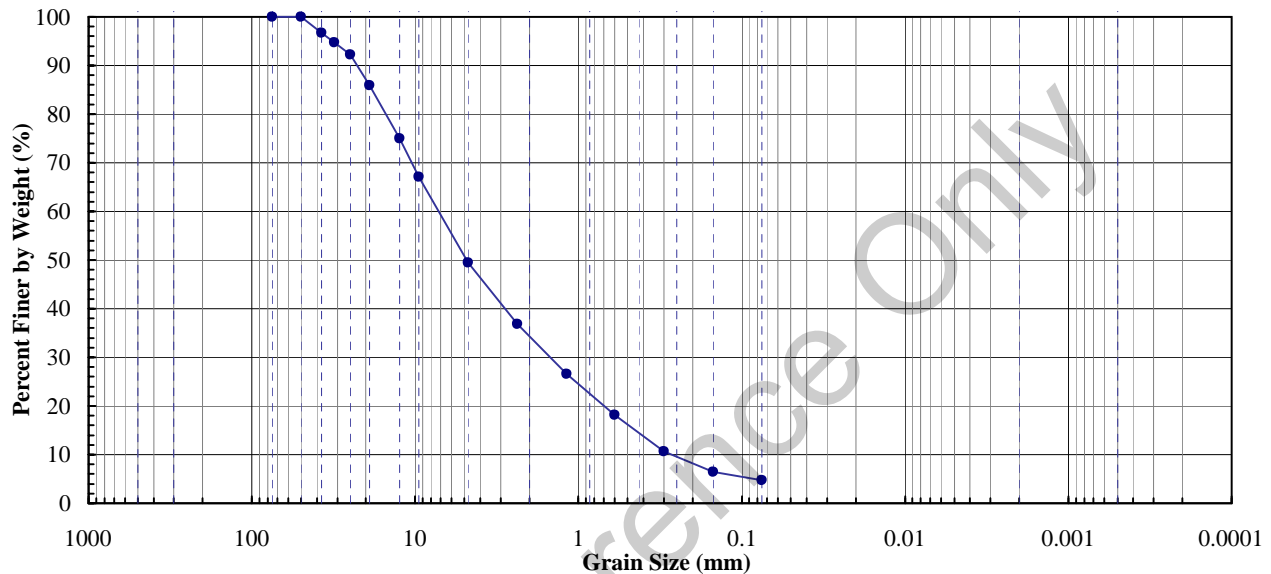

Sieve No.	Size (mm)	% Finer
3"	75	100.0
2"	50	100.0
1.5"	37.5	96.7
1.25"	31.25	94.7
1"	25	92.2
3/4"	19	85.9
1/2"	12.5	75.0
3/8"	9.5	67.1
#4	4.75	49.5
#8	2.00	36.8
#16	0.850	26.6
#30	0.425	18.1
#50	0.250	10.7
#100	0.150	6.5
#200	0.075	4.8

Hydrometer Particle Diameter (mm)	% Finer
0.0310	
0.0200	
0.0061	
0.0031	
0.0013	

Gravel (%):	50.5
Sand (%):	44.7
Fines (%):	4.8
Silt (%):	
Clay (%):	

Coeff. Unif. (Cu):	27.0
Coeff. Curv. (Cc):	1.1

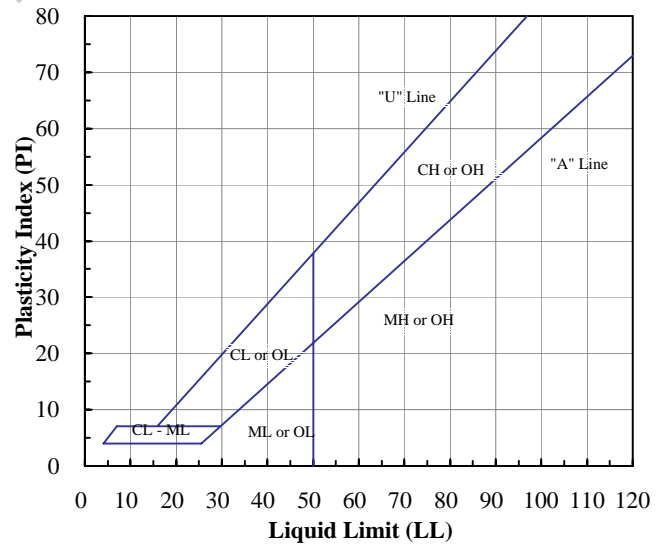

Client Sample ID.	Lab Sample No.	Moisture Content (%)	Fines Content < No. 200 (%)	Atterberg Limits			Engineering Classification
				LL (%)	PL (%)	PI (-)	
Soil MW-6J	S13090		4.8				GW

Note(s):

APPENDIX B

RELATIVE DENSITY TEST RESULTS

For Reference Only

HATCH MOTT MACDONALD – SILICON VALLEY RAPID TRANSIT PROJECT

RELATIVE DENSITY (ASTM D 4253/4254)

Soil Sample MW-8A (1.25" Minus Material)

SGI Lab Sample ID: S13087

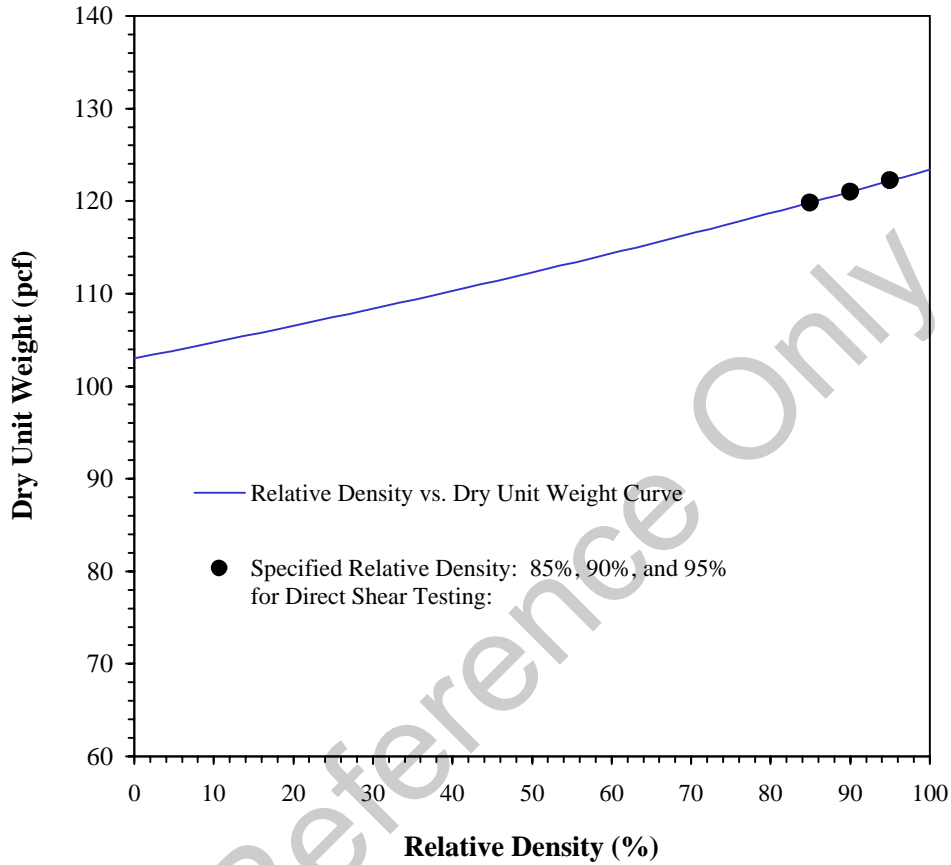

Test Description	Diameter of Mold (in.)	Height of Mold (in.)	Average Height of Sample (in.)	Volume of Sample (ft ³)	Dry Weight of Sample (g)	Dry Unit Weight (pcf)
Maximum Dry Unit Weight	5.988	6.112	5.47	0.0891	5000	123.4
Minimum Dry Unit Weight	5.998	6.112	6.11	0.100	4675	103.0

<u>Specified Relative Density (%)</u>	<u>Dry Unit Weight (pcf)</u>
85.0	119.8
90.0	121.0
95.0	122.2

DATE REPORTED: 12/16/2007



SGI TESTING SERVICES, LLC

FIGURE NO.	B-1
PROJECT NO.	SGI7047
DOCUMENT NO.	
FILE NO.	

HATCH MOTT MACDONALD – SILICON VALLEY RAPID TRANSIT PROJECT

RELATIVE DENSITY (ASTM D 4253/4254)

Soil Sample MW-2B(1.25" Minus Material)

SGI Lab Sample ID: S13088

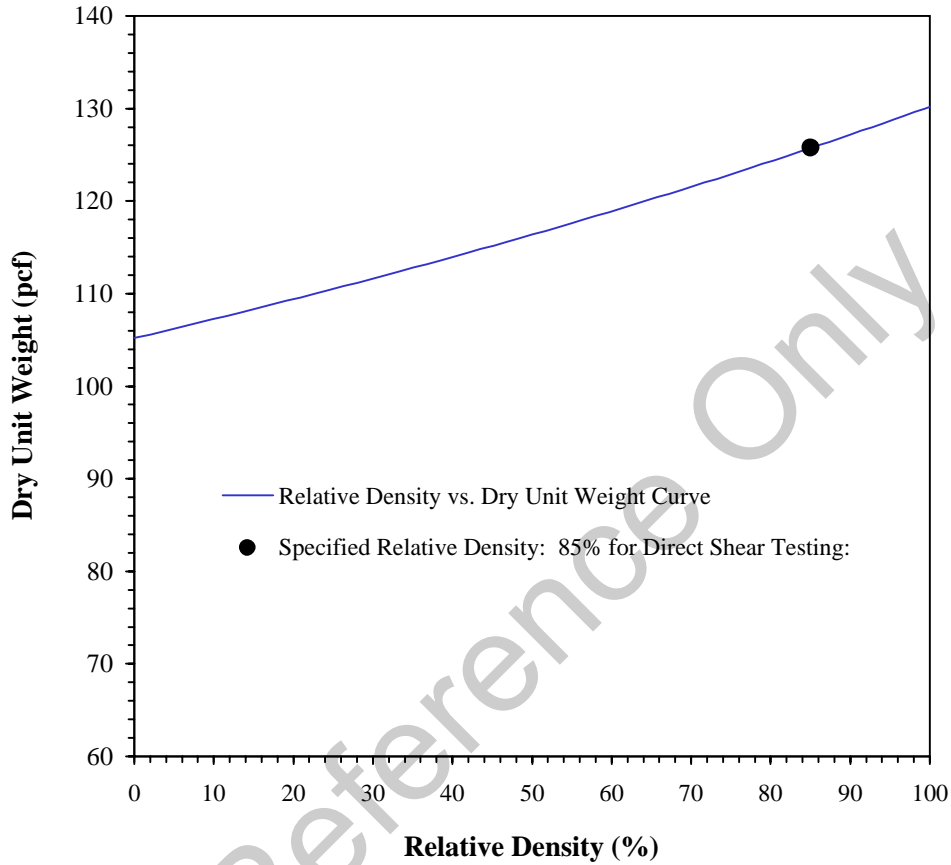

Test Description	Diameter of Mold (in.)	Height of Mold (in.)	Average Height of Sample (in.)	Volume of Sample (ft ³)	Dry Weight of Sample (g)	Dry Unit Weight (pcf)
Maximum Dry Unit Weight	5.988	6.112	5.18	0.0845	5000	130.2
Minimum Dry Unit Weight	5.998	6.112	6.11	0.100	4775	105.2

Specified Relative Density (%)
85.0

Dry Unit Weight (pcf)
125.7

DATE REPORTED: 12/16/2007



SGI TESTING SERVICES, LLC

FIGURE NO.	B-2
PROJECT NO.	SGI7047
DOCUMENT NO.	
FILE NO.	

HATCH MOTT MACDONALD – SILICON VALLEY RAPID TRANSIT PROJECT

RELATIVE DENSITY (ASTM D 4253/4254)

Soil Sample MW-4A (1.25" Minus Material)

SGI Lab Sample ID: S13089

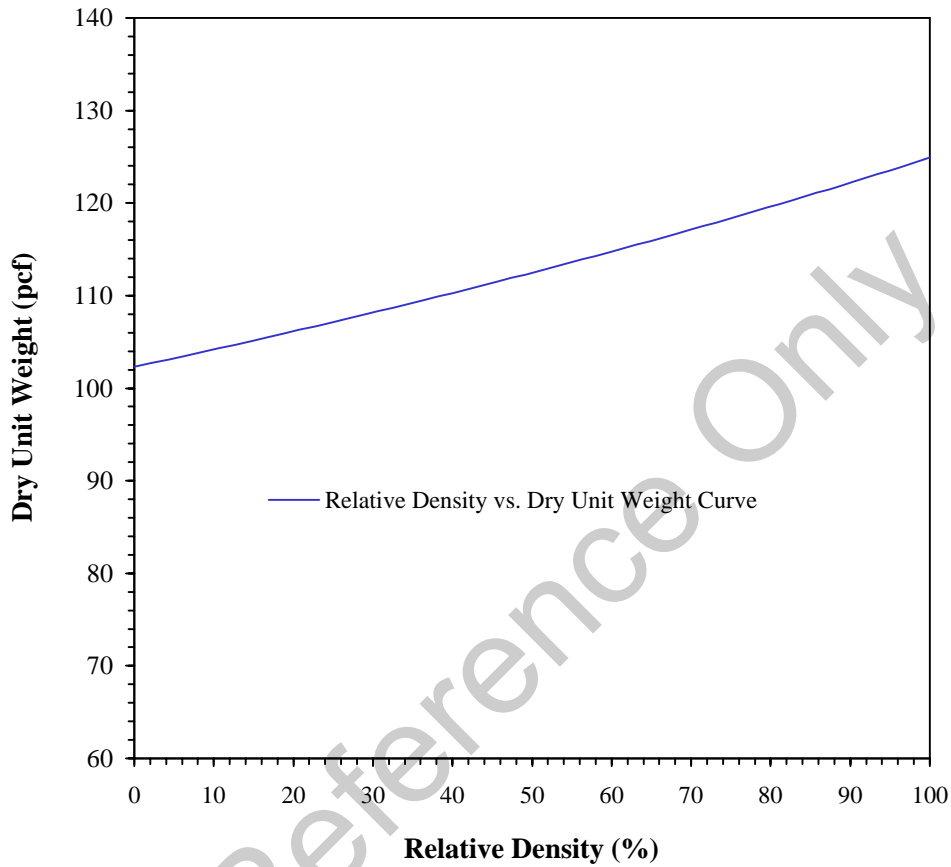

Test Description	Diameter of Mold (in.)	Height of Mold (in.)	Average Height of Sample (in.)	Volume of Sample (ft ³)	Dry Weight of Sample (g)	Dry Unit Weight (pcf)
Maximum Dry Unit Weight	5.988	6.112	4.407	0.0718	4077	124.9
Minimum Dry Unit Weight	5.998	6.112	6.11	0.100	4640	102.3

Specified Relative Density (%)

Dry Unit Weight (pcf)

DATE REPORTED: 12/16/2007



SGI TESTING SERVICES, LLC

FIGURE NO.	B-3
PROJECT NO.	SGI7047
DOCUMENT NO.	
FILE NO.	

HATCH MOTT MACDONALD – SILICON VALLEY RAPID TRANSIT PROJECT

RELATIVE DENSITY (ASTM D 4253/4254)

Soil Sample MW-6J (1.25" Minus Material)

SGI Lab Sample ID: S13090

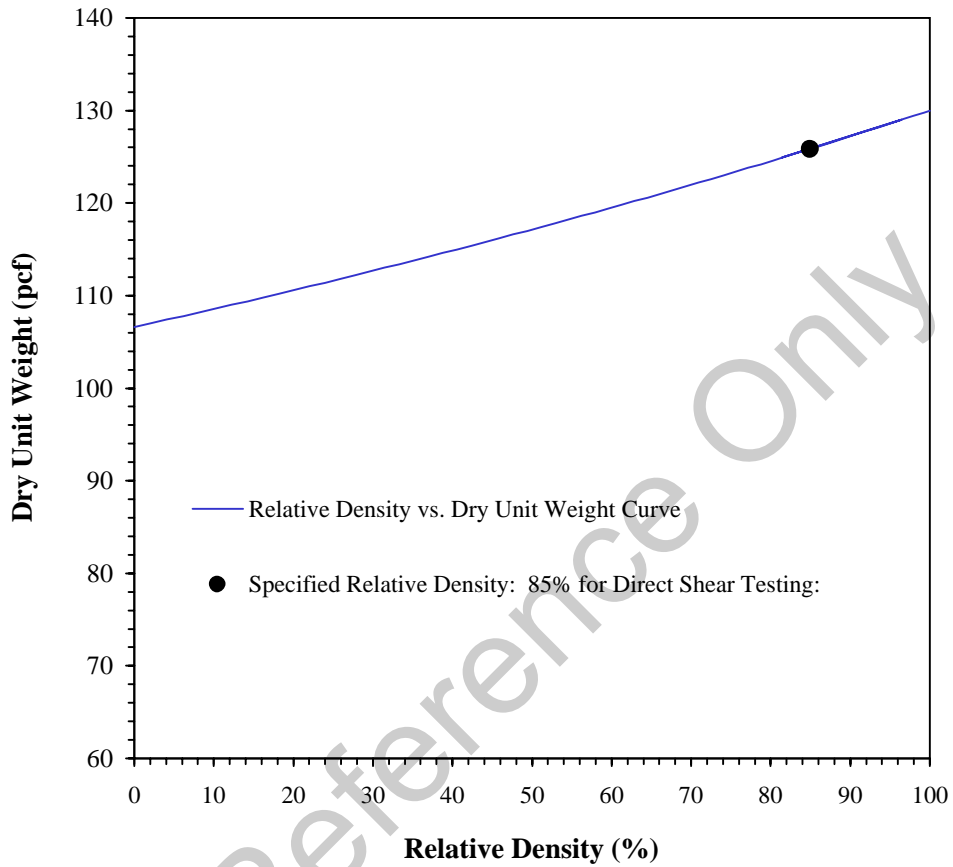

Test Description	Diameter of Mold (in.)	Height of Mold (in.)	Average Height of Sample (in.)	Volume of Sample (ft ³)	Dry Weight of Sample (g)	Dry Unit Weight (pcf)
Maximum Dry Unit Weight	5.988	6.112	5.193	0.0846	5000	130.0
Minimum Dry Unit Weight	5.998	6.112	6.11	0.100	4835	106.6

Specified Relative Density (%)
85.0

Dry Unit Weight (pcf)
125.9

DATE REPORTED: 12/16/2007



SGI TESTING SERVICES, LLC

FIGURE NO.	B-4
PROJECT NO.	SGI7047
DOCUMENT NO.	
FILE NO.	

APPENDIX C

DIRECT SHEAR TEST RESULTS

For Reference Only

**HATCH MOTT MACDONALD – SILICON VALLEY RAPID TRANSIT PROJECT
DIRECT SHEAR TESTING (ASTM D D3080)**

Test Series No. 1: Soil sample MW-8A (1.25" minus material) compacted to approximately 85% relative density

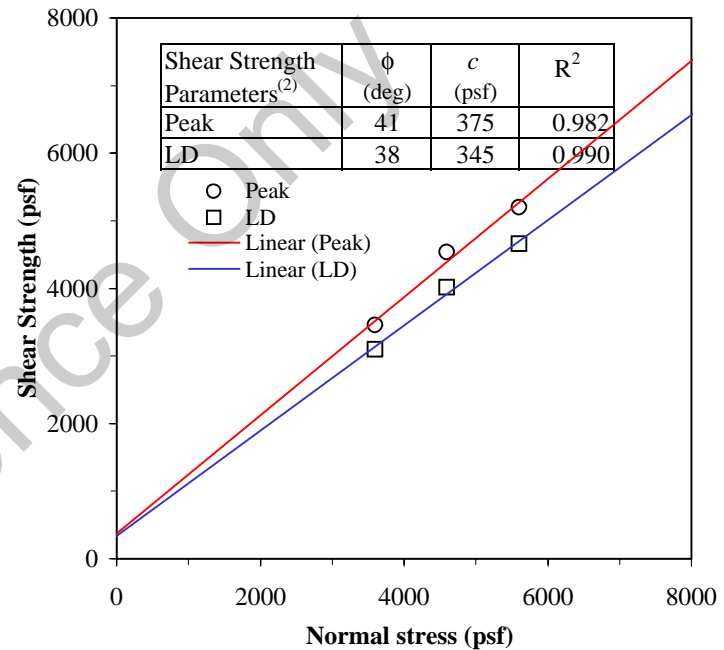
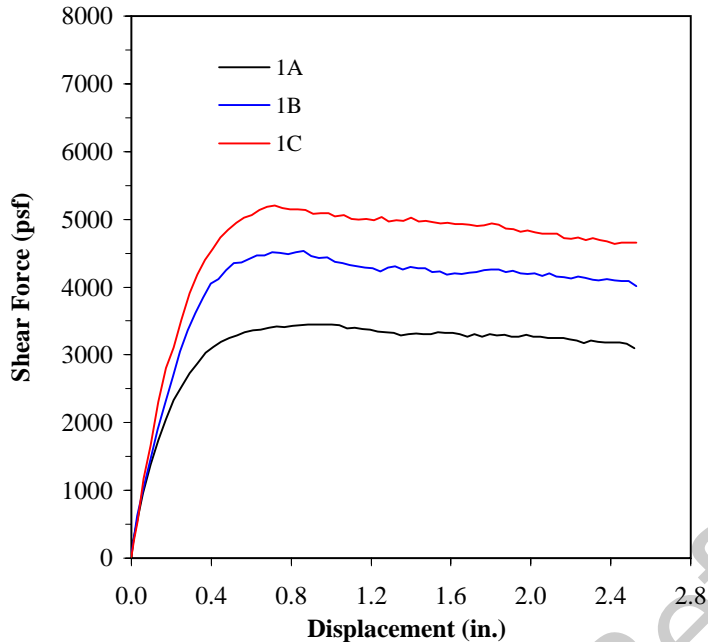

Test No.	Shear Box Size (in. x in.)	Normal Stress (psf)	Shear Rate (in./min)	Soaking		Consolidation		Soil # MW-8A			Soil # MW-8A			GCL		Shear Stress		Failure Mode
				Stress (psf)	Time (hour)	Stress (psf)	Time (hour)	γ_d (pcf)	ω_i (%)	ω_f (%)	γ_d (pcf)	ω_i (%)	ω_f (%)	ω_i (%)	ω_f (%)	τ_p (psf)	τ_{LD} (psf)	
1A	12 x 12	3600	0.040	-	-	-	-	120.1	9.7	8.9	-	-	-	-	-	3452	3100	(1)
1B	12 x 12	4600	0.040	-	-	-	-	119.5	10.3	8.5	-	-	-	-	-	4532	4015	(1)
1C	12 x 12	5600	0.040	-	-	-	-	120.2	9.6	7.9	-	-	-	-	-	5200	4656	(1)

NOTES:

(1) Sliding (i.e., shear failure) was forced to occur on the plane between the upper and lower shear box.

(2) The reported total-stress parameters of friction angle and cohesion were determined from a best-fit line drawn through the test data. Caution should be exercised in using these strength parameters for applications involving normal stresses outside the range of the stresses covered by the test series. The large-displacement (LD) shear strength was calculated using the shear force measured at the end of the test.

DATE OF REPORT: 12/17/2007

FIGURE NO. C-1

PROJECT NO. SG7047

DOCUMENT NO.

FILE NO.



SGI TESTING SERVICES, LLC

HATCH MOTT MACDONALD – SILICON VALLEY RAPID TRANSIT PROJECT
DIRECT SHEAR TESTING (ASTM D D3080)

Test Series No. 2: Soil sample MW-8A (1.25" minus material) compacted to approximately 90% relative density

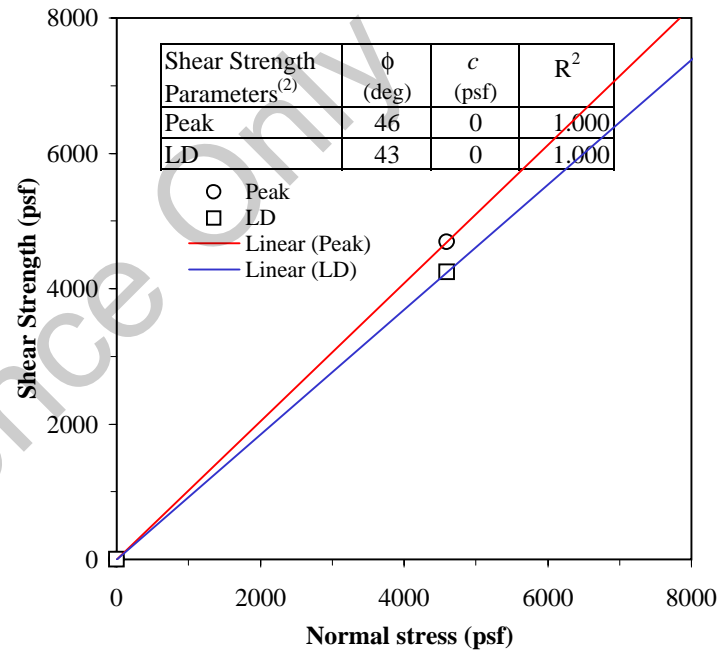
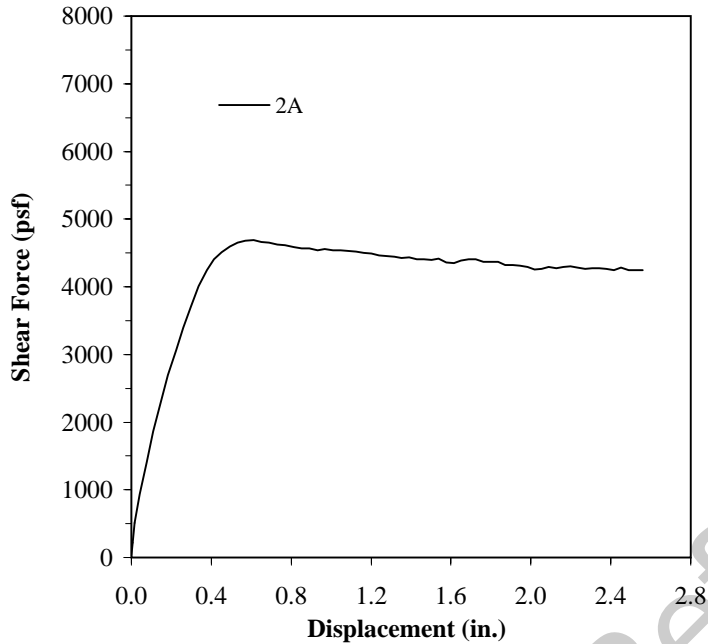

Test No.	Shear Box Size (in. x in.)	Normal Stress (psf)	Shear Rate (in./min)	Soaking		Consolidation		Soil # MW-8A			Soil # MW-8A			GCL		Shear Stress		Failure Mode
				Stress (psf)	Time (hour)	Stress (psf)	Time (hour)	γ_d (pcf)	ω_i (%)	ω_f (%)	γ_d (pcf)	ω_i (%)	ω_f (%)	ω_i (%)	ω_f (%)	τ_p (psf)	τ_{LD} (psf)	
2A	12 x 12	4600	0.040	-	-	-	-	121.2	9.8	8.6	-	-	-	-	-	4694	4245	(1)

NOTES:

- (1) Sliding (i.e., shear failure) was forced to occur on the plane between the upper and lower shear box.
- (2) The reported total-stress friction angle was determined by drawing a straight line from origin through the test data point. Caution should be exercised in using the friction angle for applications involving normal stresses other than the test normal stress.

DATE OF REPORT: 12/17/2007



SGI TESTING SERVICES, LLC

FIGURE NO. C-2
 PROJECT NO. SG7047
 DOCUMENT NO.
 FILE NO.

HATCH MOTT MACDONALD – SILICON VALLEY RAPID TRANSIT PROJECT
DIRECT SHEAR TESTING (ASTM D D3080)

Test Series No. 3: Soil sample MW-8A (1.25" minus material) compacted to approximately 95% relative density

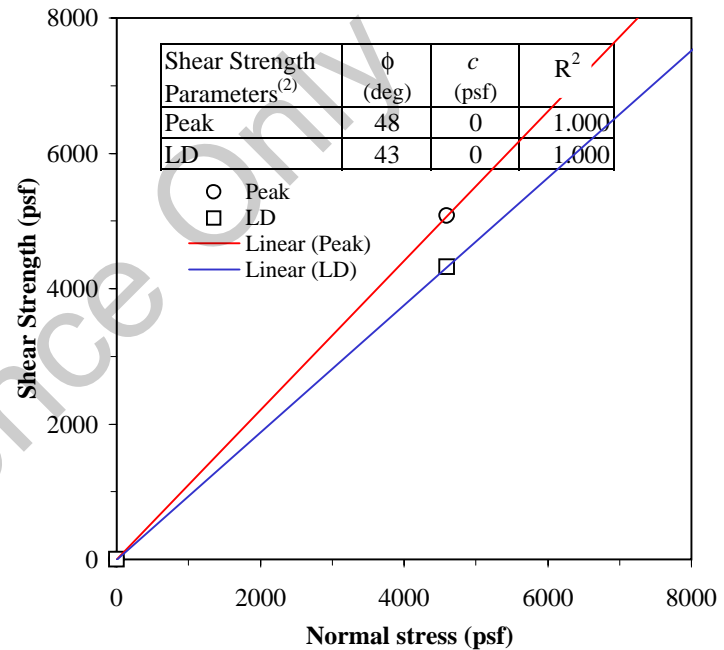
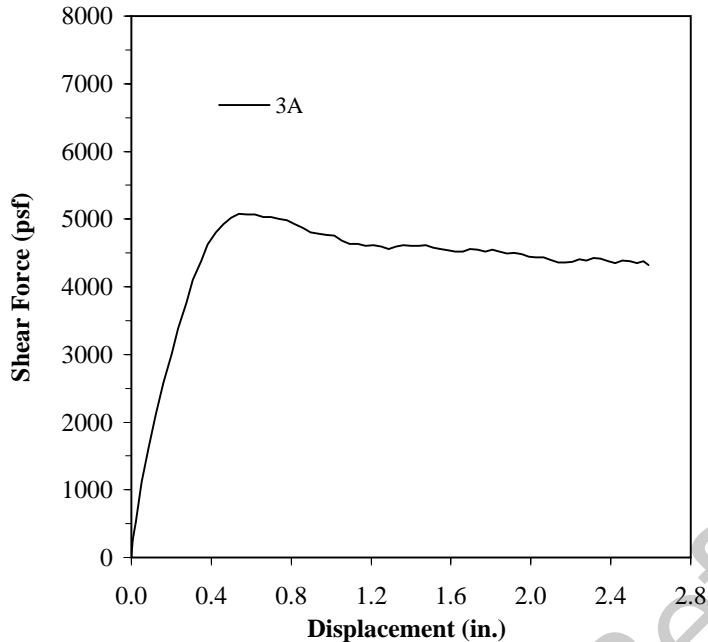

Test No.	Shear Box Size (in. x in.)	Normal Stress (psf)	Shear Rate (in./min)	Soaking		Consolidation		Soil # MW-8A			Soil # MW-8A			GCL		Shear Stress		Failure Mode
				Stress (psf)	Time (hour)	Stress (psf)	Time (hour)	γ_d (pcf)	ω_i (%)	ω_f (%)	γ_d (pcf)	ω_i (%)	ω_f (%)	ω_i (%)	ω_f (%)	τ_p (psf)	τ_{LD} (psf)	
3A	12 x 12	4600	0.040	-	-	-	-	121.9	10.3	8.8	-	-	-	-	-	5074	4326	(1)

NOTES:

- (1) Sliding (i.e., shear failure) was forced to occur on the plane between the upper and lower shear box.
- (2) The reported total-stress friction angle was determined by drawing a straight line from origin through the test data point. Caution should be exercised in using the friction angle for applications involving normal stresses other than the test normal stress.

DATE OF REPORT: 12/17/2007



SGI TESTING SERVICES, LLC

FIGURE NO. C-3
 PROJECT NO. SG7047
 DOCUMENT NO.
 FILE NO.

**HATCH MOTT MACDONALD – SILICON VALLEY RAPID TRANSIT PROJECT
DIRECT SHEAR TESTING (ASTM D D3080)**

Test Series No. 4: Soil sample MW-2B (1.25" minus material) compacted to approximately 85% relative density

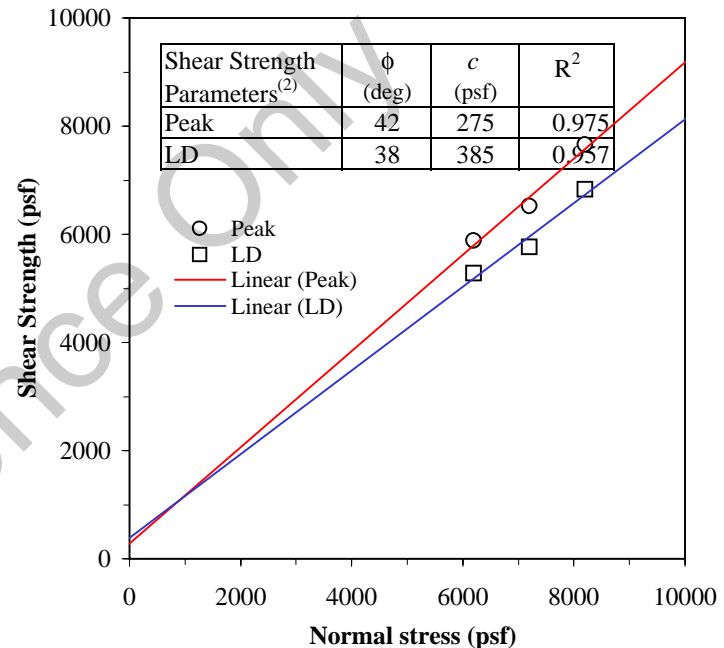
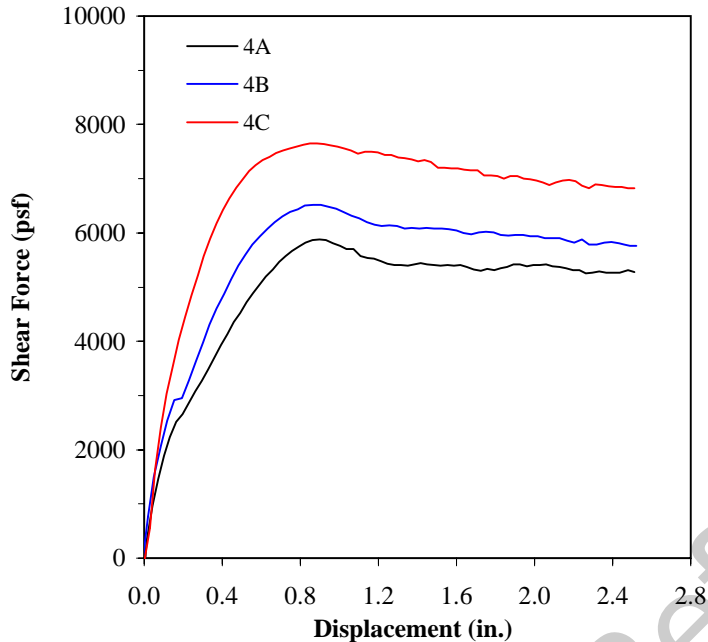

Test No.	Shear Box Size (in. x in.)	Normal Stress (psf)	Shear Rate (in./min)	Soaking		Consolidation		Soil # MW-2B			Soil # MW-2B			GCL		Shear Stress		Failure Mode
				Stress (psf)	Time (hour)	Stress (psf)	Time (hour)	γ_d (pcf)	ω_i (%)	ω_f (%)	γ_d (pcf)	ω_i (%)	ω_f (%)	ω_i (%)	ω_f (%)	τ_p (psf)	τ_{LD} (psf)	
4A	12 x 12	6200	0.040	-	-	-	-	125.6	10.1	8.9	-	-	-	-	-	5876	5278	(1)
4B	12 x 12	7200	0.040	-	-	-	-	126.2	9.6	8.2	-	-	-	-	-	6520	5767	(1)
4C	12 x 12	8200	0.040	-	-	-	-	125.4	10.3	7.6	-	-	-	-	-	7656	6826	(1)

NOTES:

- (1) Sliding (i.e., shear failure) was forced to occur on the plane between the upper and lower shear box.
- (2) The reported total-stress parameters of friction angle and cohesion were determined from a best-fit line drawn through the test data. Caution should be exercised in using these strength parameters for applications involving normal stresses outside the range of the stresses covered by the test series. The large-displacement (LD) shear strength was calculated using the shear force measured at the end of the test.

DATE OF REPORT: 12/17/2007



SGI TESTING SERVICES, LLC

FIGURE NO. C-4
PROJECT NO. SG7047
DOCUMENT NO.
FILE NO.

HATCH MOTT MACDONALD – SILICON VALLEY RAPID TRANSIT PROJECT
DIRECT SHEAR TESTING (ASTM D D3080)

Test Series No. 5: Soil sample MW-6J (1.25" minus material) compacted to approximately 85% relative density

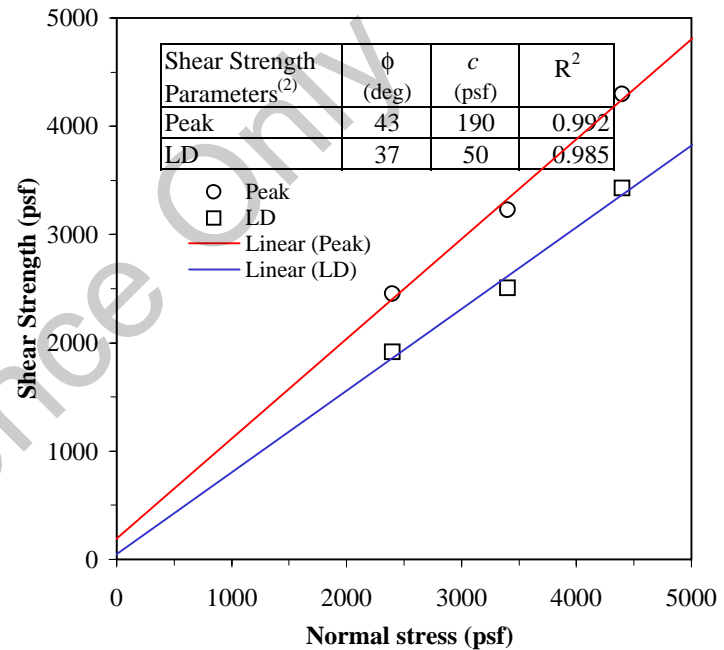
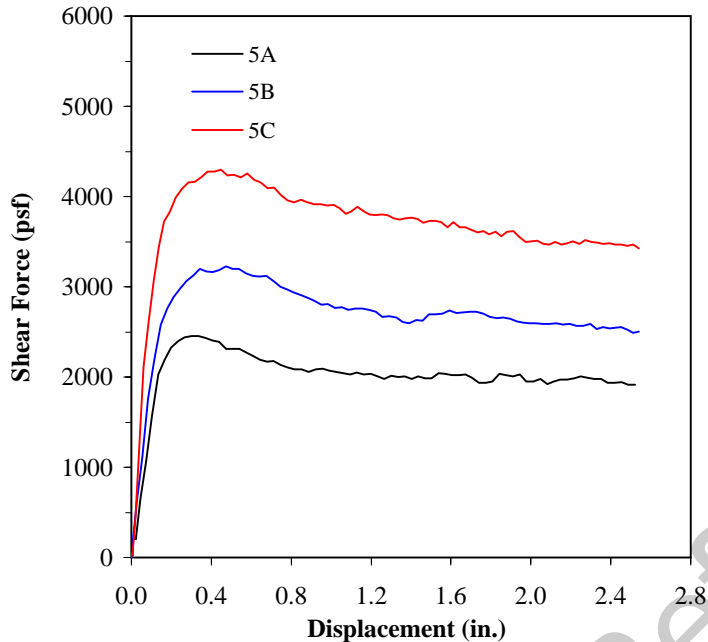

Test No.	Shear Box Size (in. x in.)	Normal Stress (psf)	Shear Rate (in./min)	Soaking		Consolidation		Soil # MW-6J			Soil # MW-6J			GCL		Shear Stress		Failure Mode
				Stress (psf)	Time (hour)	Stress (psf)	Time (hour)	γ_d (pcf)	ω_i (%)	ω_f (%)	γ_d (pcf)	ω_i (%)	ω_f (%)	ω_i (%)	ω_f (%)	τ_p (psf)	τ_{LD} (psf)	
5A	12 x 12	2400	0.040	-	-	-	-	125.2	10.6	8.6	-	-	-	-	-	2454	1916	(1)
5B	12 x 12	3400	0.040	-	-	-	-	125.7	10.2	8.9	-	-	-	-	-	3229	2507	(1)
5C	12 x 12	4400	0.040	-	-	-	-	126.2	9.7	8.1	-	-	-	-	-	4298	3425	(1)

NOTES:

- (1) Sliding (i.e., shear failure) was forced to occur on the plane between the upper and lower shear box.
- (2) The reported total-stress parameters of friction angle and cohesion were determined from a best-fit line drawn through the test data. Caution should be exercised in using these strength parameters for applications involving normal stresses outside the range of the stresses covered by the test series. The large-displacement (LD) shear strength was calculated using the shear force measured at the end of the test.

DATE OF REPORT: 12/17/2007



SGI TESTING SERVICES, LLC

FIGURE NO. C-5
 PROJECT NO. SG7047
 DOCUMENT NO.
 FILE NO.

Appendix 7: Sticky Limit Test Results

For Reference Only

January 18, 2008

Mr. Abhishek Jain
Hatch Mott MacDonald
3103 North First Street
Building B, Suite 200
San Jose, CA 95134

RE: BAY AREA RAPID TRANSIT (BART) EXTENSION STICKY LIMIT TESTING

Dear Mr. Jain:

In response to our telephone conversation on January 16, 2008, I have put together the following letter describing the procedures and methods used to perform the moisture content, liquid limit, plastic limit, and stick limit laboratory tests on samples provided to us by Hatch Mott MacDonald for the BART extension project.

On September 10, 2007, the Shannon & Wilson, Inc. (S&W) Seattle soils testing laboratory received 7 wooden core boxes containing 14 steel tube soil samples and 1 bag soil sample. It is our understanding that the samples were originally obtained by Hatch Mott MacDonald in 2004 and 2005, and that the tube samples were sealed with wax and stored vertically in a temperature-controlled room.

Upon receiving the samples, S&W laboratory personnel extruded the thin-walled tube samples using a hydraulic tube extruder. Following extrusion, the samples were classified in accordance with ASTM International (ASTM) Standard D 2488, "Description and Identification of Soils (Visual-Manual Procedure)." The tube samples were logged along the entire length of the sample by laboratory staff. Along with classifying the soil type, variations in stratigraphy and soil structure were also noted. Water contents were also determined from each sample in accordance with ASTM standard D 2216, "Laboratory Determination of Water (Moisture) Content of Soil and Rock by Mass." A specimen was taken from approximately the middle of each tube sample to perform the liquid, plastic, and sticky limit tests.

Mr. Abhishek Jain
Hatch Mott MacDonald
January 18, 2008
Page 2

SHANNON & WILSON, INC.

The plastic limit and liquid limit tests were both performed in accordance with ASTM standard 4318, "Liquid Limit, Plastic Limit, and Plasticity Index of Soils." The sticky limit was determined by following the procedure described in K.H. Head's Manual of Soil Laboratory Testing, Volume 1: Soil Classification and testing (1980). A description of the sticky limit procedure is presented below:

"Use a pat of clay which has been matured at a moisture content within the plastic range, such that it is 'sticky'- that is, the clay sticks to a clean, dry spatula blade. Allow the clay to dry gradually by exposure to the atmosphere, and at intervals draw the tool lightly over the surface of the clay-pat. When the tool no longer picks up any clay, measure the moisture content. Add a little water to the clay so that it becomes sticky again, and repeat the process once or twice more. If the measured moisture contents are within reasonable agreement (an overall range of 2%), calculate the average moisture content to the nearest 1% and report it as the sticky limit of the clay."

After completion of testing, a report was generated for each test in accordance with applicable ASTM standards and results were summarized in a table including visual description, water content, plastic limit, liquid limit, and sticky limit. All calculations, data entry, and reports were reviewed by the laboratory technical director.

Please contact me at (206) 632-8020 if you have any questions regarding any of the procedures used in our laboratory.

Sincerely,

SHANNON & WILSON, INC.

Andrew Caneday
Seattle Laboratory Technical Director

AJC/ajc

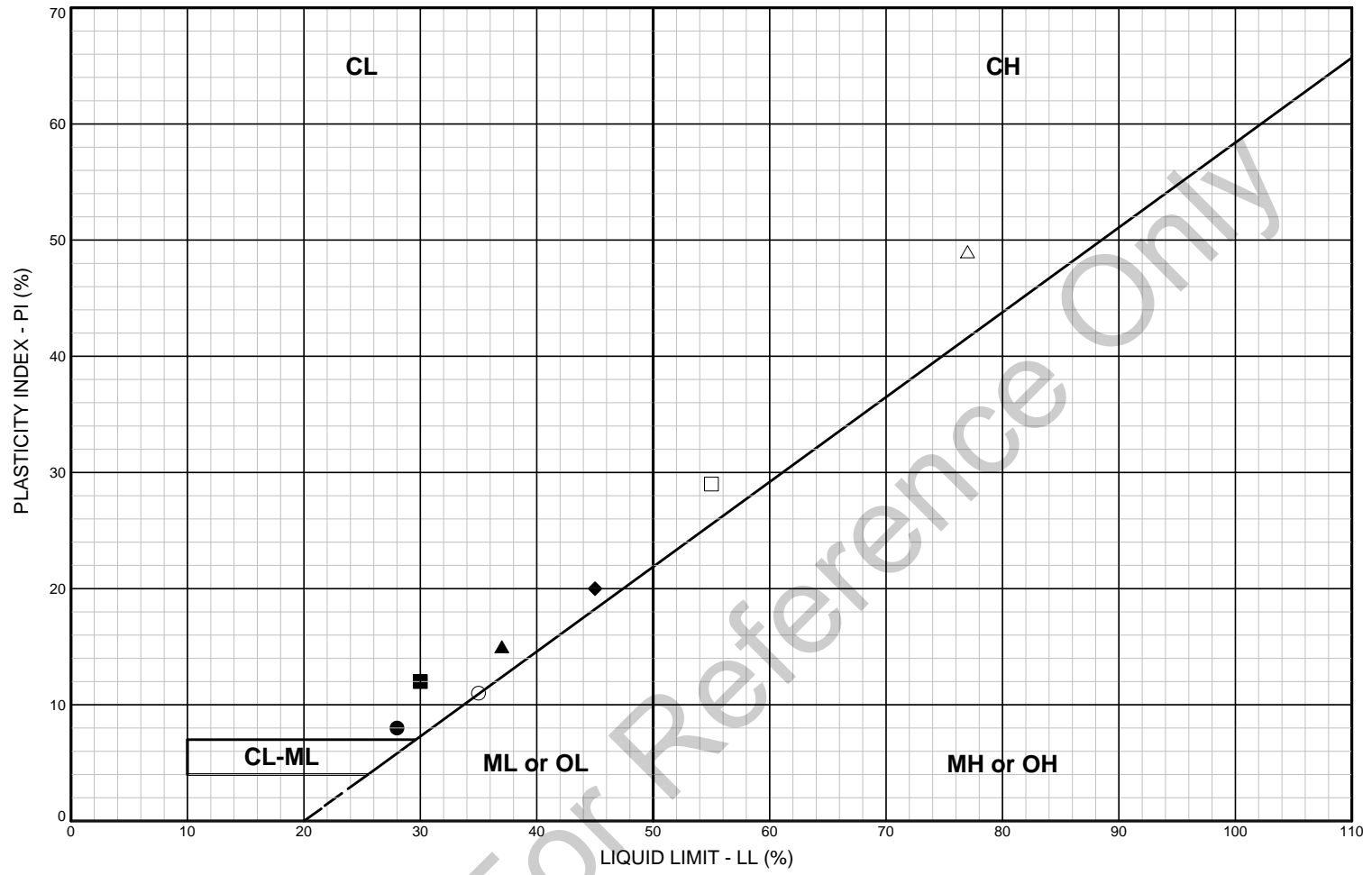

LEGEND

- CL:** Low plasticity inorganic clays; sandy and silty clays
- CH:** High plasticity inorganic clays
- ML or OL:** Inorganic and organic silts and clayey silts of low plasticity
- MH or OH:** Inorganic and organic silts and clayey silts of high plasticity
- CL-ML:** Silty clays and clayey silts

FIG. FINAL

BORING AND SAMPLE NO.	DEPTH (feet)	U.S.C.S. SYMBOL	SOIL CLASSIFICATION	LL %	PL %	PI %	NAT. W.C. %	PASS. #200, %
● BH-01, S-6	26.0	CL	Gray, slightly sandy, Lean CLAY, trace of fine gravel	28	20	8	27.3	
■ BH-01, S-8	35.3	CL	Gray, slightly fine sandy, Lean CLAY	30	18	12	24.0	
▲ BH-07, S-4	41.5	CL	Gray, Lean CLAY	37	22	15	30.9	
◆ BH-12, S-2	50.0	CL	Gray, Lean CLAY; scattered organics	45	25	20	31.3	
○ BH-16, S-7	85.9	CL	Gray, Lean CLAY	35	24	11	25.4	
□ BH-17, S-2	51.1	CH	Gray, Fat CLAY	55	26	29	31.7	
△ BH-18, S-1	41.2	CH	Gray, Fat CLAY; scattered to abundant organics	77	28	49	44.3	

Silicon Valley Rapid Transit Project
Silicon Valley, California

PLASTICITY CHART

October 2007 21-1-08824-030

SHANNON & WILSON, INC.
Geotechnical and Environmental Consultants **FIG. FINAL**

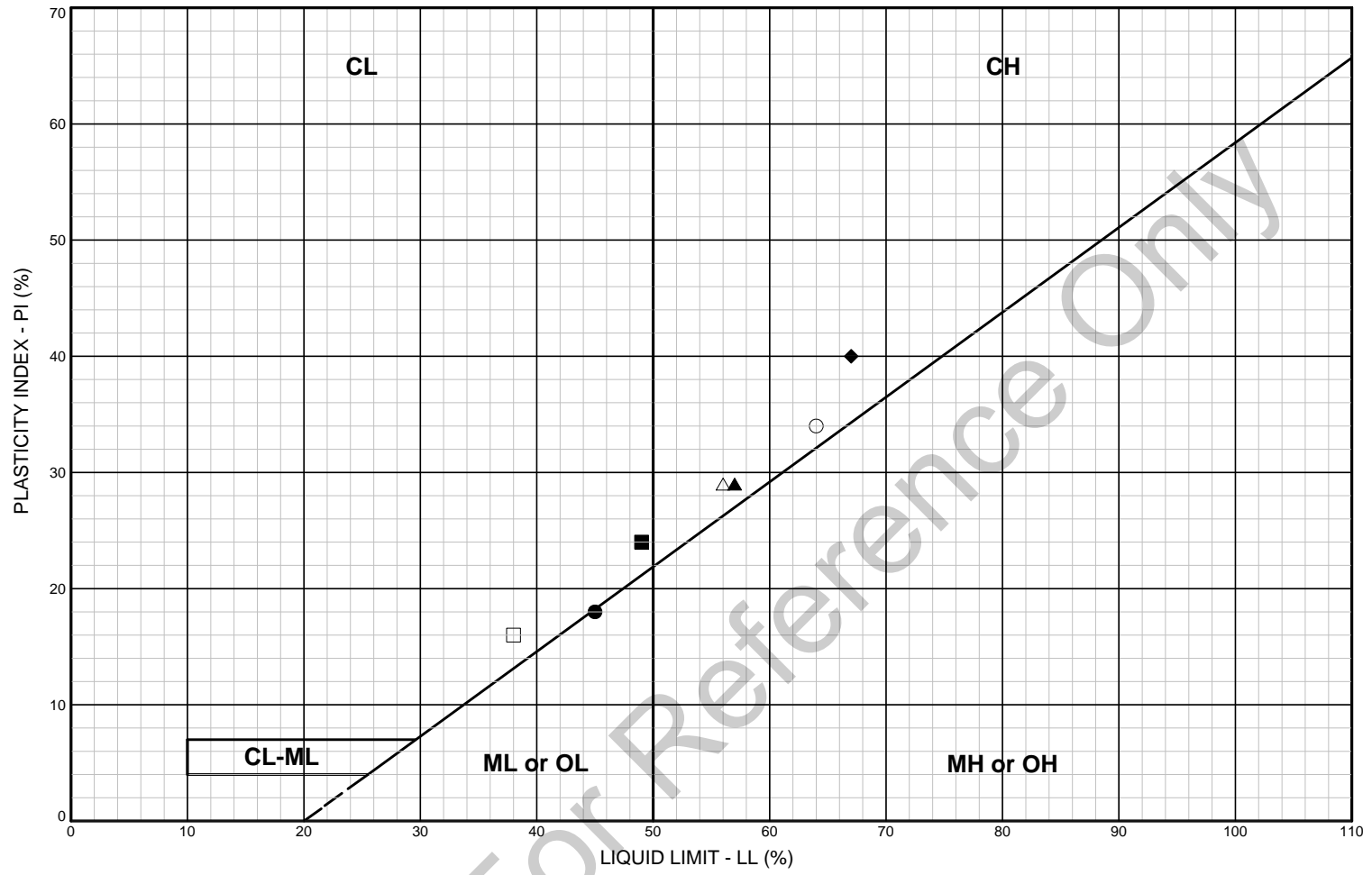

LEGEND

- CL:** Low plasticity inorganic clays; sandy and silty clays
- CH:** High plasticity inorganic clays
- ML or OL:** Inorganic and organic silts and clayey silts of low plasticity
- MH or OH:** Inorganic and organic silts and clayey silts of high plasticity
- CL-ML:** Silty clays and clayey silts

FIG. FINAL

BORING AND SAMPLE NO.	DEPTH (feet)	U.S.C.S. SYMBOL	SOIL CLASSIFICATION	LL %	PL %	PI %	NAT. W.C. %	PASS. #200, %
● BH-101, S-5	21.0	ML	Gray and brown, clayey SILT; scattered organics	45	27	18	37.0	
■ BH-103, S-7	30.0	CL	Brown, Lean CLAY, trace of sand	49	25	24	31.8	
▲ BH-19, S-3	41.1	CH	Gray, Fat CLAY; scattered organic laminations	57	28	29	37.9	
◆ BH-19, S-4	45.0	CH	Gray, Fat CLAY, trace of sand; scattered organics	67	27	40	32.6	
○ BH-52, S-14	37.6	CH	Gray, Fat CLAY; scattered organic seams	64	30	34	46.2	
□ BH-54, S-8	36.5	CL	Gray, Lean CLAY, trace of sand; scattered organics	38	22	16	34.0	
△ BH-87, S-9	56.0	CH	Gray, Fat CLAY, trace of sand; scattered organics	56	27	29	29.2	

Silicon Valley Rapid Transit Project
Silicon Valley, California

PLASTICITY CHART

October 2007 21-1-08824-030

SHANNON & WILSON, INC.
Geotechnical and Environmental Consultants

FIG. FINAL

SUMMARY OF LABORATORY TESTING

Boring	Sample	Sample Recovery (feet)	Test Depth (feet)	Sample Description	USCS Symbol	Water Content (%)	LL	PL	PI	NP	SL
BH-01	6	25.0-26.7	26.0	Gray, slightly sandy, Lean CLAY, trace of fine gravel	CL	27.3	28	20	8		28
BH-01	8	35.0-37.5	35.3	Gray, slightly fine sandy, Lean CLAY	CL	24.0	30	18	12		28
BH-06	5	37.5-38.5	38.1	Brown, silty, fine to medium SAND, trace of gravel	SM	19.2	-	-	-	NP	
BH-07	4	40.0-41.7	41.5	Gray, Lean CLAY	CL	30.9	37	22	15		39
BH-12	2	50.0-52.2	50.0	Gray, Lean CLAY; scattered organics	CL	31.3	45	25	20		33
BH-16	7	85.0-86.8	85.9	Gray, Lean CLAY	CL	25.4	35	24	11		34
BH-17	2	50.0-51.9	51.1	Gray, Fat CLAY	CH	31.7	55	26	30		38
BH-18	1	40.0-42.5	41.2	Gray, Fat CLAY; scattered to abundant organics	CH	44.3	77	28	49		56
BH-19	3	40.0-42.0	41.1	Gray, Fat CLAY; scattered organic laminations	CH	37.9	57	28	30		49
BH-19	4	45.0-46.1	45.0	Gray, Fat CLAY, trace of sand; scattered organics	CH	32.6	67	27	40		44
BH-52	14	37.0-38.3	37.6	Gray, Fat CLAY; scattered organic seams	CH	46.2	64	30	33		53
BH-54	8	35.0-36.8	36.5	Gray, Lean CLAY, trace of sand; scattered organics	CL	34.0	38	22	16		36
BH-87	9	55.0-57.5	56.0	Gray, Fat CLAY, trace of sand; scattered organics	CH	29.2	56	27	28		45
BH-101	5	20.0-22.1	21.0	Gray and brown, clayey SILT; scattered organics	ML	37.0	45	27	18		37
BH-103	7	Bag Sample	30.0	Brown, Lean CLAY, trace of sand	CL	31.8	49	25	24		36

Notes:

The above results were obtained from samples stored for a period of 2-3 years. Moisture loss or other types of disturbance associated with storing samples for an extended period of time may affect test results.

LL = Liquid Limit

PL = Plastic Limit

PI = Plastic Index

NP = Non plastic

SL = Sticky Limit

March 10, 2008

Mr. Abhishek Jain
Hatch Mott MacDonald
3103 North First Street
Building B, Suite 200
San Jose, CA 95134

**RE: 24965-PO-00011: SILICON VALLEY RAPID TRANSIT PROJECT
(213213 EC03), LABORATORY TESTING**

Dear Mr. Jain:

This letter presents the results of and describes the procedures and methods that we used to perform moisture content, liquid limit, plastic limit, and stick limit laboratory tests on samples provided to us by Hatch Mott MacDonald for the Silicon Valley Rapid Transit Project (SVRTP).

On February 5, 2008, the Shannon & Wilson, Inc. (S&W) Seattle soils testing laboratory received 17 soil samples. Samples were immediately stored in a humidity-controlled storage area. It is our understanding that the samples were originally obtained by Hatch Mott MacDonald in November 2007.

Upon receiving authorization to begin testing the samples on February 25, 2008, S&W laboratory personnel classified each sample in accordance with ASTM International (ASTM) Standard D 2488, "Description and Identification of Soils (Visual-Manual Procedure)." Water contents were determined from each sample in accordance with ASTM standard D 2216, "Laboratory Determination of Water (Moisture) Content of Soil and Rock by Mass." A representative specimen was taken from each sample to perform the liquid, plastic, and sticky limit tests.

The plastic limit and liquid limit tests were both performed in accordance with ASTM standard 4318, "Liquid Limit, Plastic Limit, and Plasticity Index of Soils." The sticky limit was determined by following the procedure described in K.H. Head's Manual of Soil Laboratory Testing, Volume 1: Soil Classification and testing (1980). Sticky limit tests were only

Mr. Abhishek Jain
Hatch Mott MacDonald
March 10, 2008
Page 2

SHANNON & WILSON, INC.

performed on soils having a Unified Soil Classification System (USCS) symbol of CH. A description of the sticky limit procedure is presented below:

“Use a pat of clay which has been matured at a moisture content within the plastic range, such that it is ‘sticky’- that is, the clay sticks to a clean, dry spatula blade. Allow the clay to dry gradually by exposure to the atmosphere, and at intervals draw the tool lightly over the surface of the clay-pat. When the tool no longer picks up any clay, measure the moisture content. Add a little water to the clay so that it becomes sticky again, and repeat the process once or twice more. If the measured moisture contents are within reasonable agreement (an overall range of 2%), calculate the average moisture content to the nearest 1% and report it as the sticky limit of the clay.”

After completion of testing, a report was generated for each test in accordance with applicable ASTM standards and results were summarized in a table including visual description, water content, plastic limit, liquid limit, and sticky limit. All calculations, data entry, and reports were reviewed by the laboratory technical director. The table summarizing the results and plots of the limit testing are enclosed.

Please contact me at (206) 632-8020 if you have any questions regarding any of the procedures used in our laboratory.

Sincerely,

SHANNON & WILSON, INC.



Andrew Caneday
Seattle Laboratory Technical Director

AJC/twh:ajc

Enclosures: Summary of Laboratory Testing
Figure 1 – Plasticity Chart (3 sheets)

SUMMARY OF LABORATORY TESTING

Silicon Valley Rapid Transit Project
 Job No. 213213 EC03
 Purchase Order No. 24965-PO-00011

Boring	Sample	Test Depth (feet)	Sample Description	USCS Symbol	Water Content (%)				
						LL	PL	PI	SL
BH-84	26	200	Brown and light brown, Lean CLAY, trace of sand and fine gravel	CL	18.7	44	18	26	-
BH-85	5	42.25	Gray, Fat CLAY; scattered organics	CH	35.5	58	28	30	47
BH-85	26	187.25	Gray, Fat CLAY	CH	28.7	59	24	35	37
BH-85	28	197.25	Gray-brown, Fat CLAY	CH	25.3	57	22	34	38
BH-90	6	22.5	Gray, fine sandy, Lean CLAY	CL	24.7	39	18	21	-
BH-90	13	40	Gray, Fat CLAY	CH	44.9	72	32	40	47
BH-92	8A	130	Gray, Lean CLAY	CL	20.4	43	19	24	-
BH-99	1	2	Gray, slightly sandy, Fat CLAY, trace of fine gravel	CH	26.8	66	24	42	36
BH-99	5	20	Gray, Lean CLAY, trace of fine to medium sand	CL	24.6	34	15	18	-
BH-100	1	2	Dark brown, Fat CLAY; abundant organics	CH	29.2	59	22	38	38
BH-100	2	7.25	Gray-brown, Fat CLAY	CH	48.1	90	34	56	55
MW-3C	-	46.5	Gray, Fat CLAY	CH	31.6	59	27	32	47
MW-3C	-	61.5	Gray, Fat CLAY	CH	28.7	57	25	32	42
MW-3D	-	39	Gray, Fat CLAY	CH	29.1	57	27	30	43
MW-3D	-	53	Gray, Fat CLAY	CH	28.3	59	27	32	43
PZ-6J	-	30	Dark gray-brown, Fat CLAY	CH	36.0	68	32	36	46
PZ-6K	-	33.5	Light brown, Fat CLAY, trace of fine sand	CH	28.9	54	20	35	34

LL = Liquid Limit
 PL = Plastic Limit
 PI = Plastic Index
 SL = Sticky Limit

trace= <5% constituent
 slightly= 5-12% constituent
 lower case= +12% constituent
 ALL CAPS= Major constituent

- Sticky Limit Test not performed on CL soils

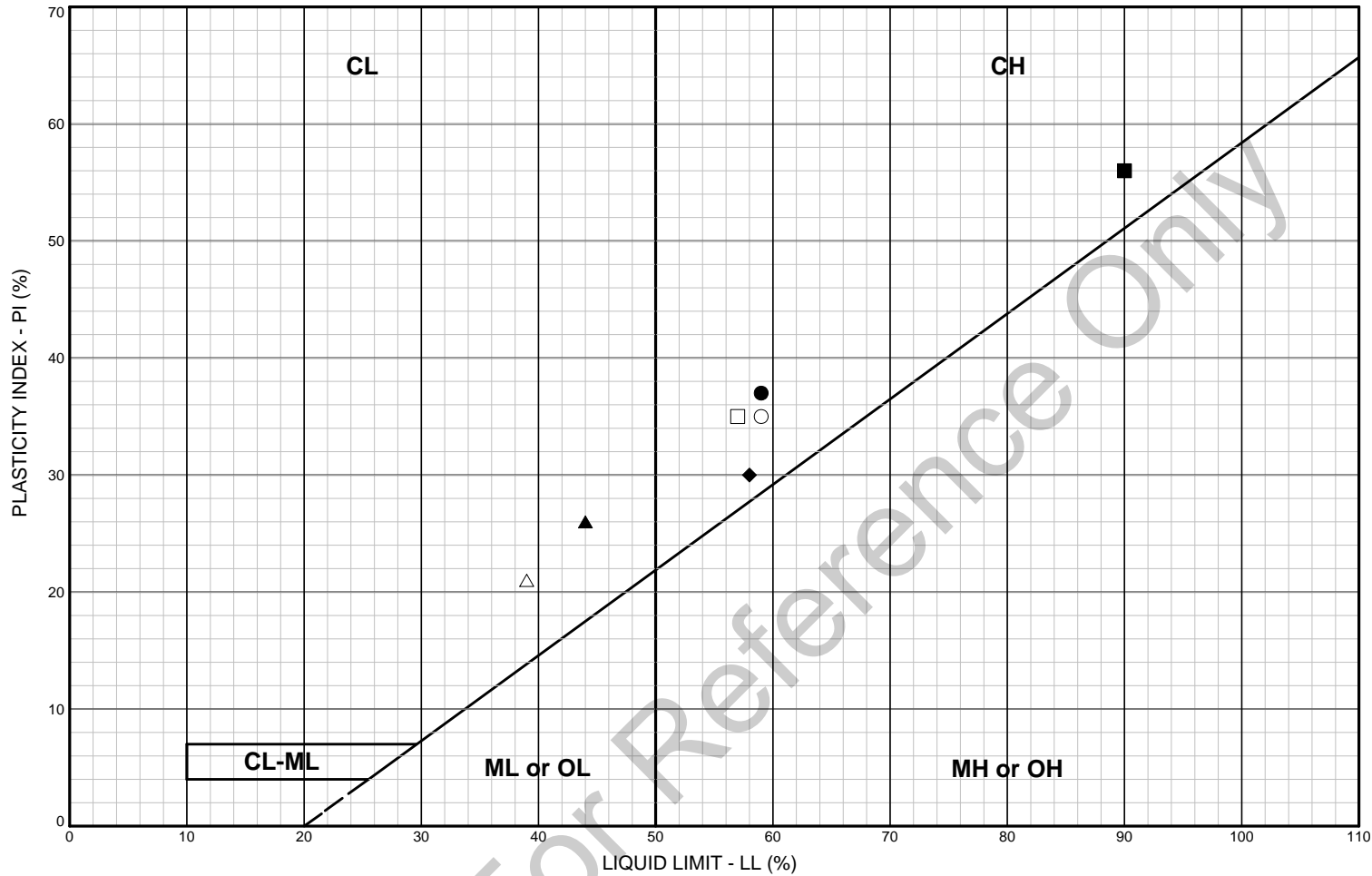

LEGEND

- CL:** Low plasticity inorganic clays; sandy and silty clays
- CH:** High plasticity inorganic clays
- ML or OL:** Inorganic and organic silts and clayey silts of low plasticity
- MH or OH:** Inorganic and organic silts and clayey silts of high plasticity
- CL-ML:** Silty clays and clayey silts

NOTES

- AD Sample air dried before testing
- ND Sample not air dried

BORING AND SAMPLE NO.	DEPTH (feet)	U.S.C.S. SYMBOL	SOIL CLASSIFICATION	LL %	PL %	PI %	NAT. W.C. %	PASS. #200, %	TEST BY	CKD BY	SMPL PREP.
● BH-100, S-1	2.0	CH	Dark brown, Fat CLAY; abundant organics	59	22	37	29.2		AKV	AJC	ND
■ BH-100, S-2	7.3	CH	Gray-brown, Fat CLAY	90	34	56	48.1		AKV	AJC	ND
▲ BH-84	200.0	CL	Brown and light brown, Lean CLAY, trace of sand and fine gravel	44	18	26	18.7		AJC	AJC	ND
◆ BH-85, S-5	42.3	CH	Gray, Fat CLAY; scattered organics	58	28	30	35.5		AKV	AJC	ND
○ BH-85, S-26	187.3	CH	Gray, Fat CLAY	59	24	35	28.7		AKV	AJC	ND
□ BH-85, S-28	197.3	CH	Gray-brown, Fat CLAY	57	22	35	25.3		AKV	AJC	ND
△ BH-90, S-6	22.5	CL	Gray, fine sandy, Lean CLAY	39	18	21	24.7		JFL	AJC	ND

Silicon Valley Rapid Transit Project
California

PLASTICITY CHART

March 2008

213213 EC03

SHANNON & WILSON, INC.
Geotechnical and Environmental Consultants

FIG. 1
Sheet 1 of 3

FIG. 1

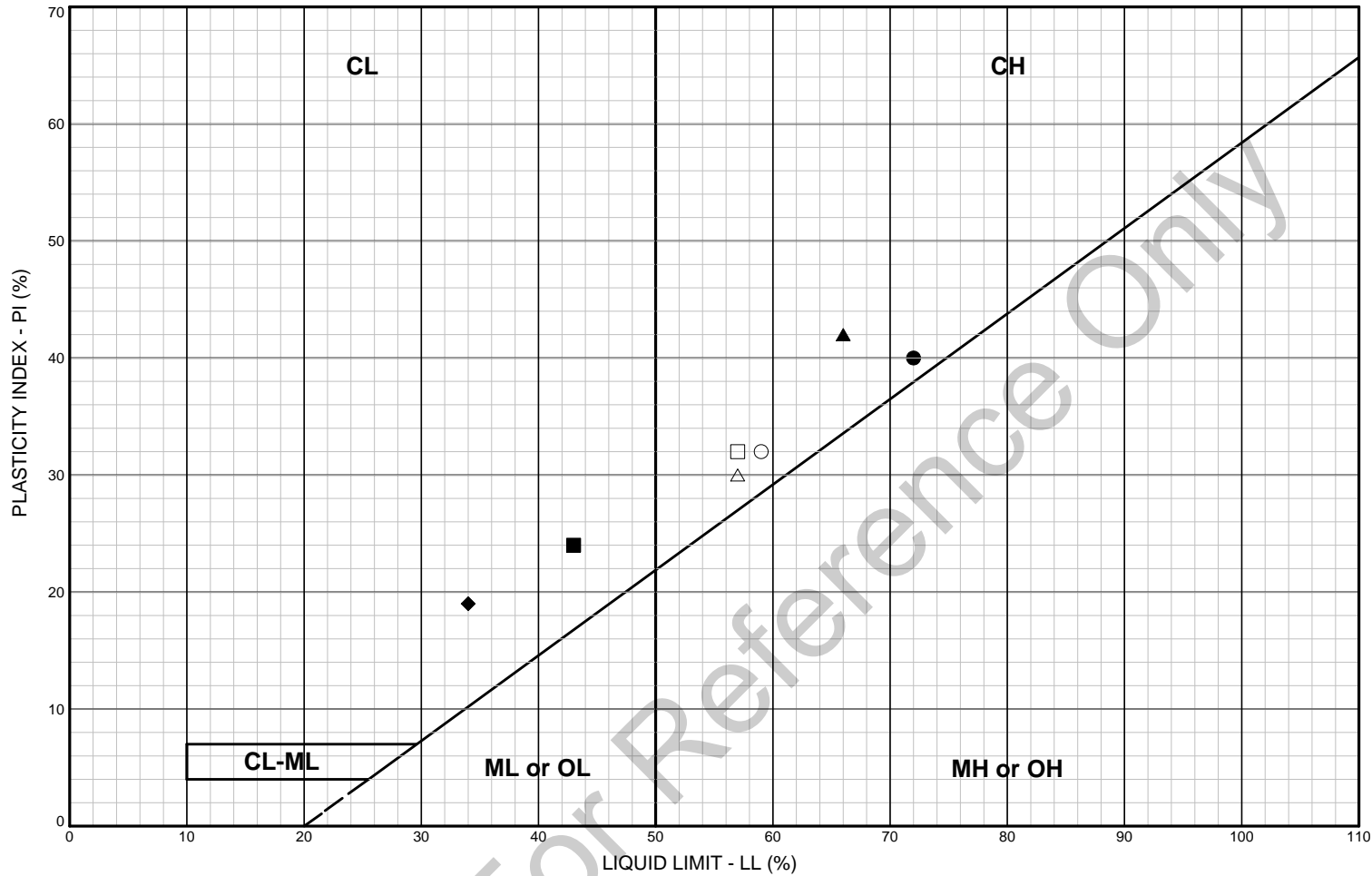

LEGEND

- CL:** Low plasticity inorganic clays; sandy and silty clays
- CH:** High plasticity inorganic clays
- ML or OL:** Inorganic and organic silts and clayey silts of low plasticity
- MH or OH:** Inorganic and organic silts and clayey silts of high plasticity
- CL-ML:** Silty clays and clayey silts

NOTES

- AD Sample air dried before testing
- ND Sample not air dried

BORING AND SAMPLE NO.	DEPTH (feet)	U.S.C.S. SYMBOL	SOIL CLASSIFICATION	LL %	PL %	PI %	NAT. W.C. %	PASS. #200, %	TEST BY	CKD BY	SMPL PREP.
● BH-90	40.0	CH	Gray, Fat CLAY	72	32	40	44.9		AJC	AJC	ND
■ BH-92, 8A	130.0	CL	Gray, Lean CLAY	43	19	24	20.4		AKV	AJC	ND
▲ BH-99, S-1	2.0	CH	Gray, slightly sandy, Fat CLAY, trace of fine gravel	66	24	42	26.8		JFL	AJC	ND
◆ BH-99, S-5	20.0	CL	Gray, Lean CLAY, trace of fine to medium sand	34	15	19	24.6		AKV	AJC	ND
○ MW-3C	46.5	CH	Gray, Fat CLAY	59	27	32	31.6		OTH	AJC	ND
□ MW-3C	61.5	CH	Gray, Fat CLAY	57	25	32	28.7		OTH	AJC	ND
△ MW-3D	39.0	CH	Gray, Fat CLAY	57	27	30	29.1		AKV	AJC	ND

Silicon Valley Rapid Transit Project
California

PLASTICITY CHART

March 2008

213213 EC03

SHANNON & WILSON, INC.
Geotechnical and Environmental Consultants

FIG. 1
Sheet 2 of 3

FIG. 1

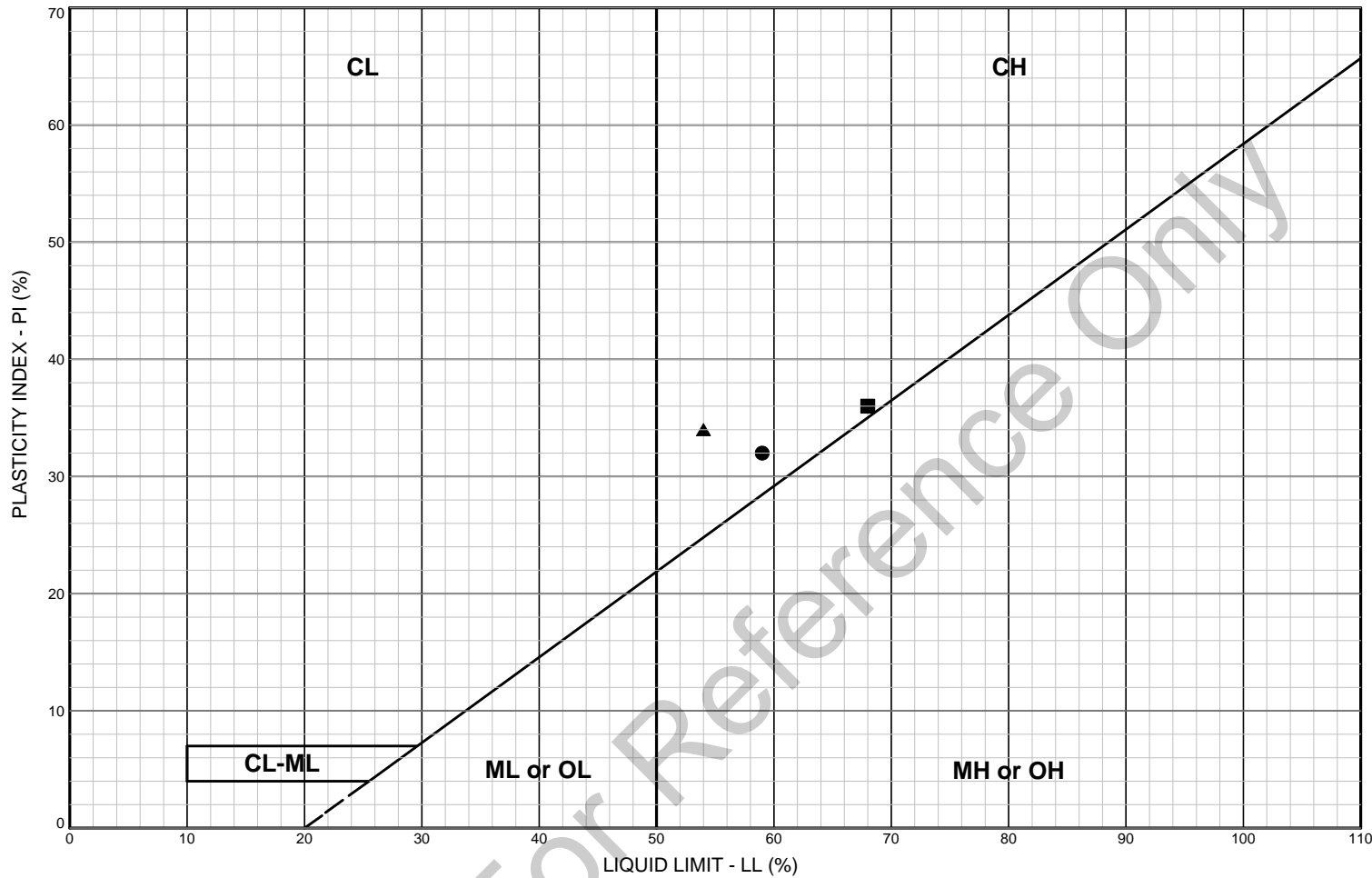

LEGEND

- CL:** Low plasticity inorganic clays; sandy and silty clays
- CH:** High plasticity inorganic clays
- ML or OL:** Inorganic and organic silts and clayey silts of low plasticity
- MH or OH:** Inorganic and organic silts and clayey silts of high plasticity
- CL-ML:** Silty clays and clayey silts

NOTES

- AD Sample air dried before testing
- ND Sample not air dried

BORING AND SAMPLE NO.	DEPTH (feet)	U.S.C.S. SYMBOL	SOIL CLASSIFICATION	LL %	PL %	PI %	NAT. W.C. %	PASS. #200, %	TEST BY	CKD BY	SMPL PREP.
● MW-3D	53.0	CH	Gray, Fat CLAY	59	27	32	28.3		AKV	AJC	ND
■ PZ-6J	30.0	CH	Dark gray-brown, Fat CLAY	68	32	36	36.0		JFL	AJC	ND
▲ PZ-6K	33.5	CH	Light brown, Fat CLAY, trace of fine sand	54	20	34	28.9		AKV	AJC	ND

Silicon Valley Rapid Transit Project
California

PLASTICITY CHART

March 2008 213213 EC03

SHANNON & WILSON, INC.
Geotechnical and Environmental Consultants

FIG. 1
Sheet 3 of 3

FIG. 1

Appendix 8: Direct Shear Test Results

For Reference Only

Mr. Abhishek Jain, E.I.T.
Geotechnical Professional
Hatch Mott Macdonald

Re: SVRT Testing Program description

The following is a brief description of the testing program undertaken by Cooper Testing Labs for the SVRT project under your guidance.

1. Introduction

Cooper Testing Laboratories, Inc. (Cooper) conducted a laboratory testing program consisting of particle-size distribution, relative density, and direct shear tests for Silicon Valley Rapid Transit (SVRT) project. The tests were performed in general accordance with American Society of Testing and Materials (ASTM) standards. This memorandum describes the tests performed, and presents the test results.

2. Testing Program

Three (3) bulk soil samples, labeled as MW-2D, MW-6K and MW-4A, were provided to Cooper by the client. Cooper performed the following tests on these samples.

Particle-size Distribution

On each sample, Cooper performed particle-size distribution in accordance with ASTM D 422, "*Particle-Size Analysis of soils*". The particle-size distribution graphs for each specimen are shown on 'Particle Size Distribution Test Report'.

Relative Density Tests

The tests were performed in accordance with ASTM D 4253, "*Maximum Index Density and Unit Weight of Soils Using a Vibratory Table*", and ASTM D 4254, "*Minimum Index Density and Unit Weight of Soils and Calculation of Relative Density*". The maximum density tests were performed on wet samples using an electro-magnetic vertically vibrating table (Method 1A), except for sample MW-6K that was run dry due to the high fines content. The minimum density tests were performed by either the soil-filled tube method (Method B) or the graduated cylinder method (Method C). The samples were reused for direct shear testing due to scarcity of samples provided.

The sample MW-6K contained 27 % (more than 15 %) particles passing the no. 200 sieve. ASTM recommends using a 'modified-proctor' procedure (ASTM D 1557) for such soils, however, this procedure could not be used due to scarcity of soil samples provided.

The results of maximum and minimum index density tests are provided on 'Minimum & Maximum Index unit Weight' reports for each sample.

Direct Shear Tests

Three direct shear envelopes were developed for each of the samples. Each envelope was based on material being compacted to one of three relative densities (60%, 80%, and 95%). The tests were performed in accordance with ASTM D 3080, "*Direct Shear Test of Soils Under Consolidated Drained Conditions*". The client provided the normal pressures and relative densities. The samples were moisture conditioned and remolded by tamping in 1" layers according to the remolding targets. These remolding targets were calculated using the results of

maximum and minimum relative density tests, and the target relative densities provided. The test results are presented on 'Direct Shear' test reports for each soil sample at a specific relative density. Each report includes plots of 1) shear stress vs. normal stress, 2) change in specimen height vs. deformation, and 3) shear stress vs. deformation. The spreadsheets of raw data have also been provided to the client. The shear strength parameters of friction angle and cohesion were determined based on the best-fit straight line drawn through the test data points on a plot of shear strength vs. normal stress. The report format allows the client to reinterpret the raw data using their engineering judgment.

3. Direct Shear Test Limitations

In general, direct shear tests can be problematic. In this test, the sample is forced to fail along a narrow predefined plane. Any gravel in this plane can cause strange behavior and higher shear loads to be observed during the test. Likewise, any variations in density that occur in this predefined shear plane can have a significant impact on the measured strength of any given point. It is also not uncommon for the top cap to tip during a test. This can affect both the shear load and the measured change in height of the sample. These problems can begin to overshadow differences due to the normal loads if the grouping of the normal loads is too tight

Please let me know if there are any questions,

Best regards,

Peter Jacke
Vice President
Cooper testing Labs

For Reference Only

Direct Shear

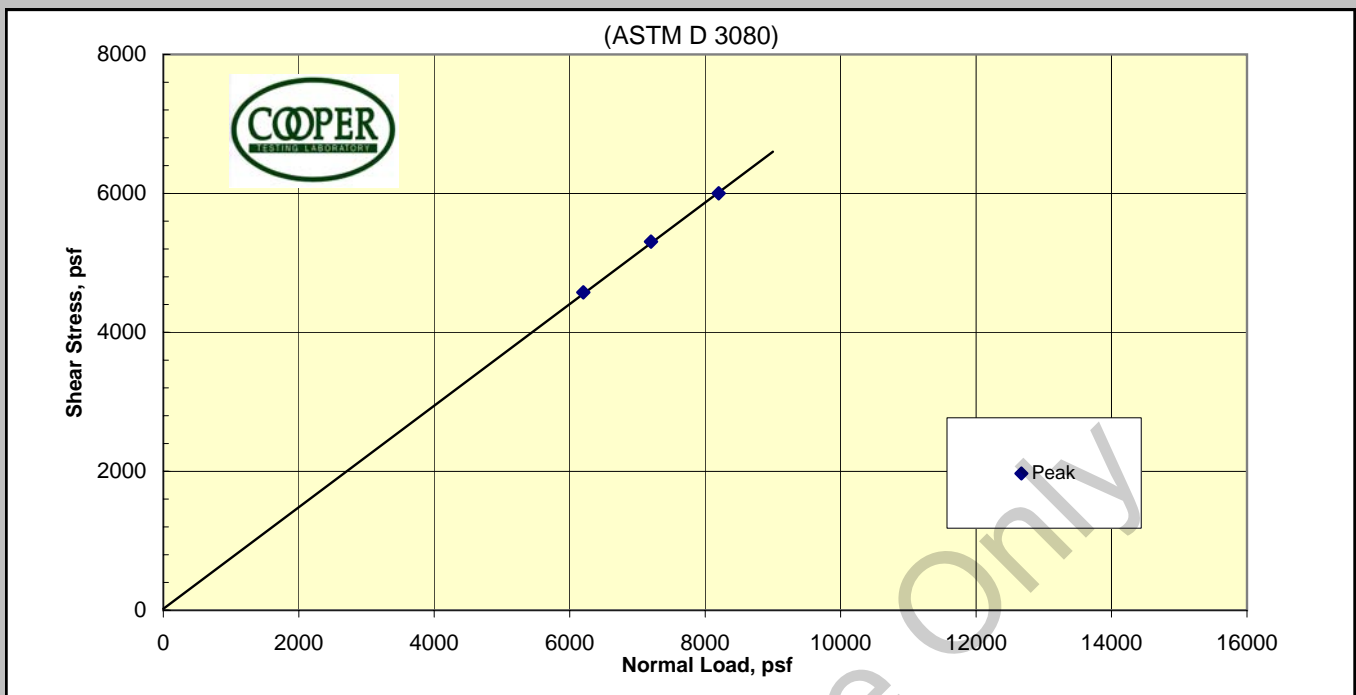

P. Phi (degrees)	36.2	Ult. phi (degrees)	
P. Cohesion (psf)	20	Ult. Cohesion (psf)	

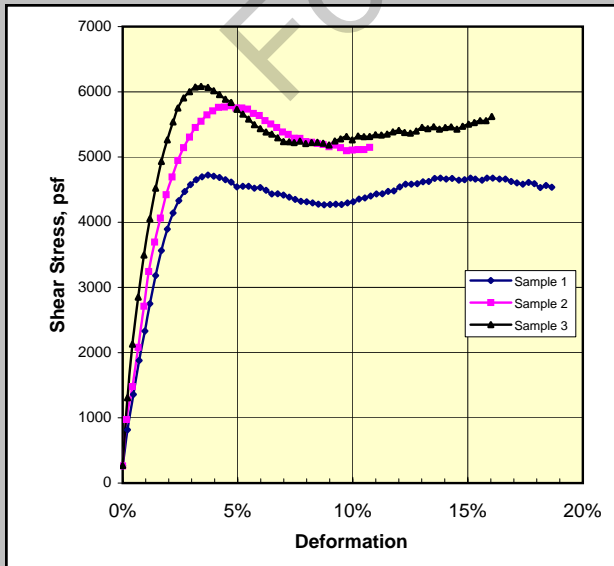
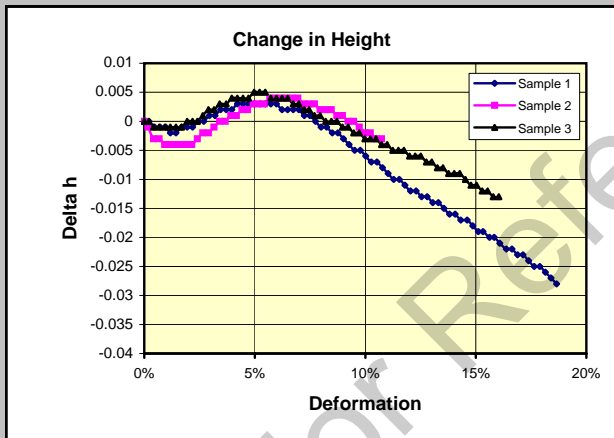

Sample Data: Initial				
Initial	1	2	3	4
Moisture	14.5%	14.5%	14.5%	
Dry Density, pcf	118.1	118.0	117.9	
Void Ratio	0.4539	0.4550	0.4550	
Saturation	87.8%	87.7%	87.7%	
Diameter, in.	2.38	2.375	2.375	
Height, in.	1.01	1.01	1.01	
Sample Data: At Test				
Moisture	14.8%	14.3%	14.3%	
Dry Density, pcf	121.1	122.2	121.6	
Void Ratio	0.4173	0.4140	0.4111	
Saturation	97.4%	99.7%	95.6%	
Diameter, in.	2.375	2.375	2.375	
Height, in.	0.98	0.98	0.97	
Normal Stress, psf	6200	7200	8200	
Shear Stress, psf	4577	5305	6000	
Deformation	3%	3%	3%	
Ultimate Stress, psf	0	0	0	
Rate in/min.	0.002	0.002	0.002	

CTL #	659-001	Date:	12/5/2007
Client:	HMM		
Project Name:	SVRT		
Project Number:	213213	Reduced by:	MD
Sample #	Boring	Sample	Depth, ft.
1	MW-2D		105-108
2	MW-2D		105-108
3	MW-2D		105-108
4			
Visual Soil Classification			
1	Brown well graded SAND with Silt & Gravel		
2	Brown well graded SAND with Silt & Gravel		
3	Brown well graded SAND with Silt & Gravel		
4			

Remarks: Remolding target = 80% Relative density (120.3 pcf dry)

Direct Shear

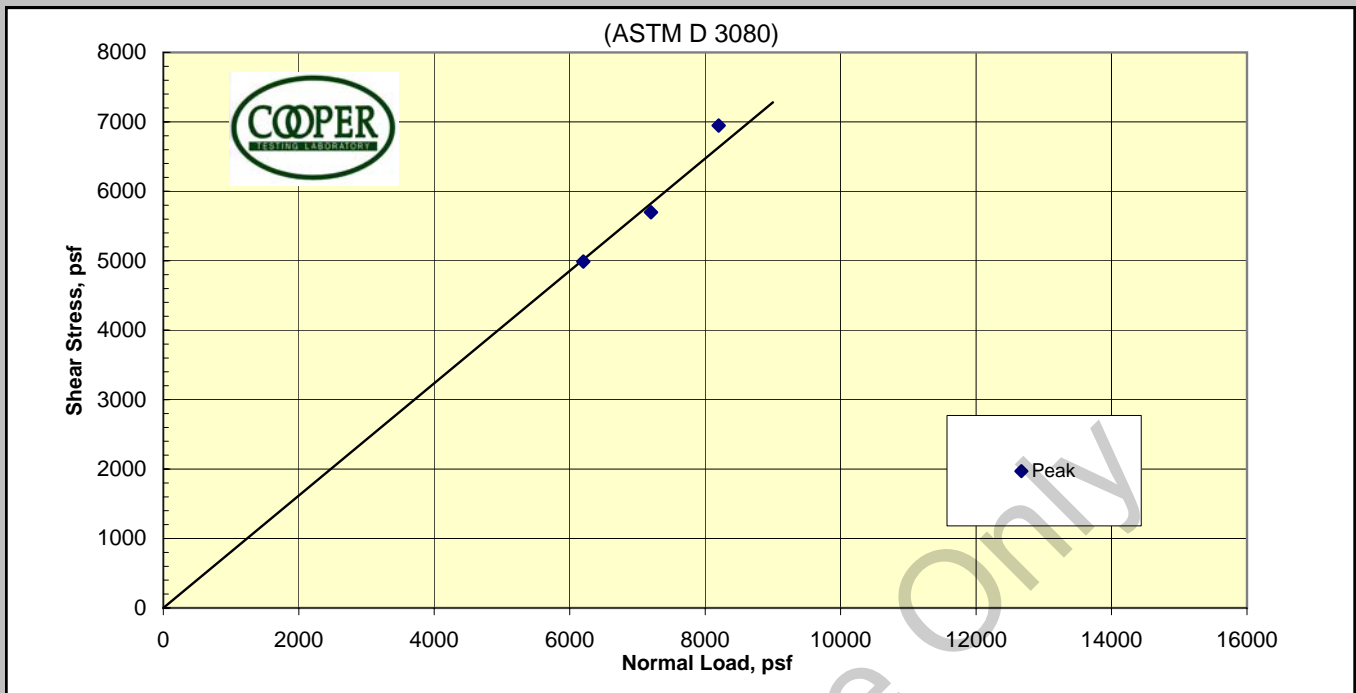

P. Phi (degrees)	39.0	Ult. phi (degrees)	
P. Cohesion (psf)	0	Ult. Cohesion (psf)	

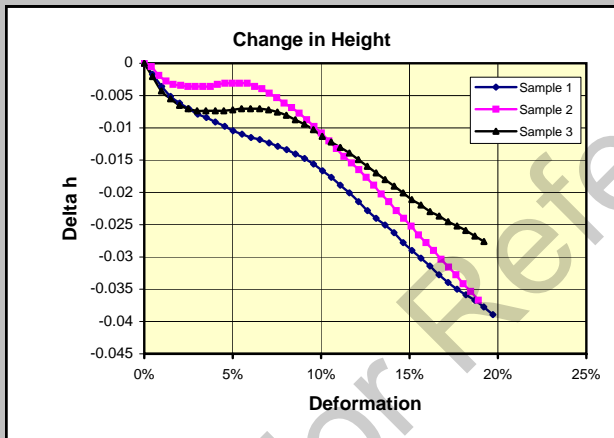

Sample Data: Initial				
Initial	1	2	3	4
Moisture	14.5%	14.5%	14.5%	
Dry Density, pcf	116.5	116.7	116.6	
Void Ratio	0.4734	0.4712	0.4712	
Saturation	84.0%	84.7%	84.7%	
Diameter, in.	2.38	2.375	2.375	
Height, in.	1.00	1.00	1.00	
Sample Data: At Test				
Moisture	14.6%	14.8%	14.1%	
Dry Density, pcf	119.7	120.1	120.2	
Void Ratio	0.4345	0.4300	0.4277	
Saturation	92.5%	94.7%	90.5%	
Diameter, in.	2.375	2.375	2.375	
Height, in.	0.97	0.97	0.97	
Normal Stress, psf	6200	7200	8200	
Shear Stress, psf	4988	5699	6947	
Deformation	5%	5%	5%	
Ultimate Stress, psf	0	0	0	
Rate in/min.	0.002	0.002	0.002	

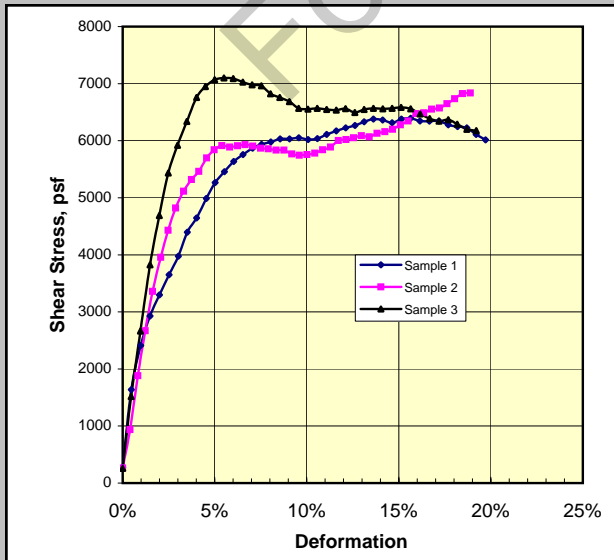

CTL #	659-001	Date:	11/18/2007
Client:	HMM		
Project Name:	SVRT		
Project Number:	213213	Reduced by:	MD
Sample #	Boring	Sample	Depth, ft.
1	MW-2D		105-108
2	MW-2D		105-108
3	MW-2D		105-108
4			
Visual Soil Classification			
1	Brown Well Graded SAND with Silt & Gravel		
2	Brown Well Graded SAND with Silt & Gravel		
3	Brown Well Graded SAND with Silt & Gravel		
4			

Remarks: Remolding target = 65% Relative density (117.3 pcf dry)

Direct Shear

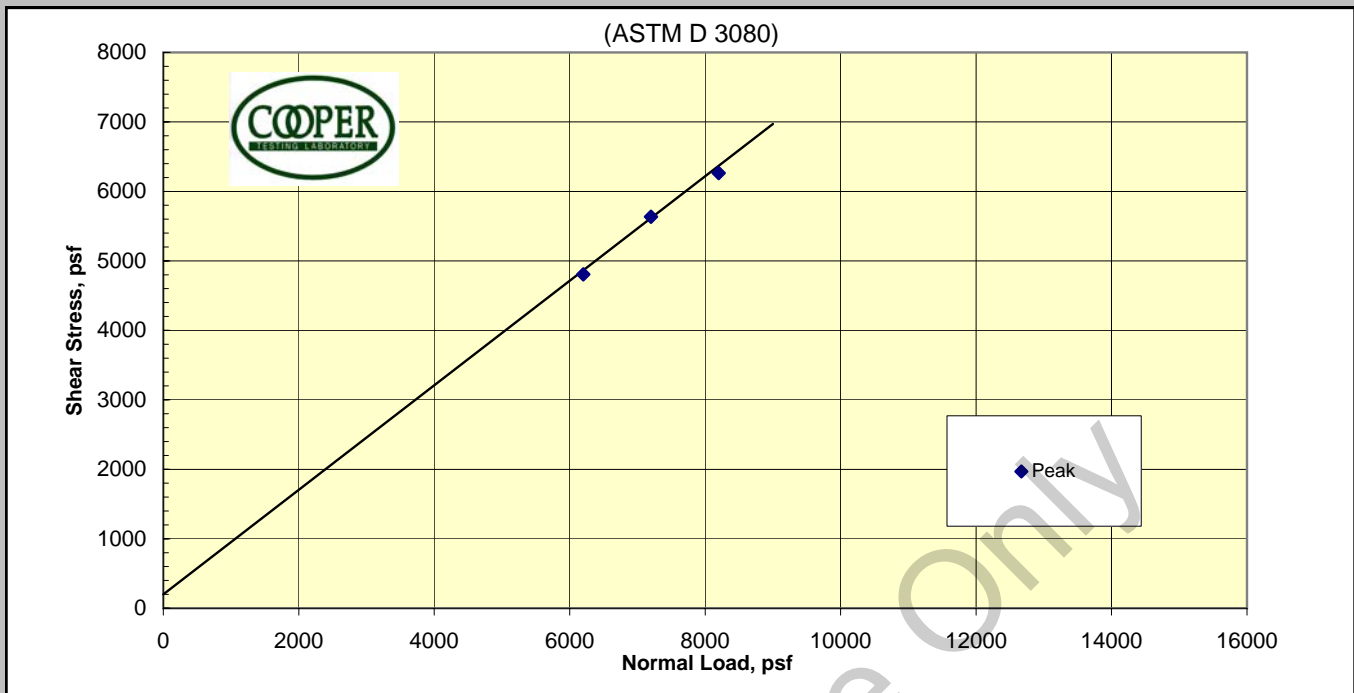

P. Phi (degrees)	37.0	Ult. phi (degrees)	
P. Cohesion (psf)	200	Ult. Cohesion (psf)	

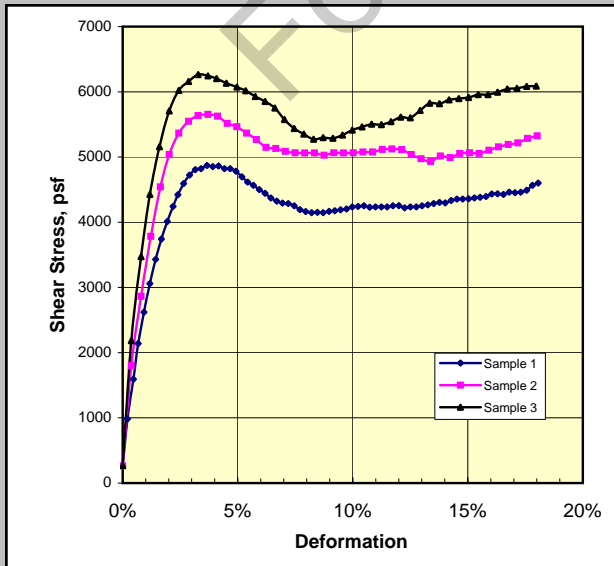
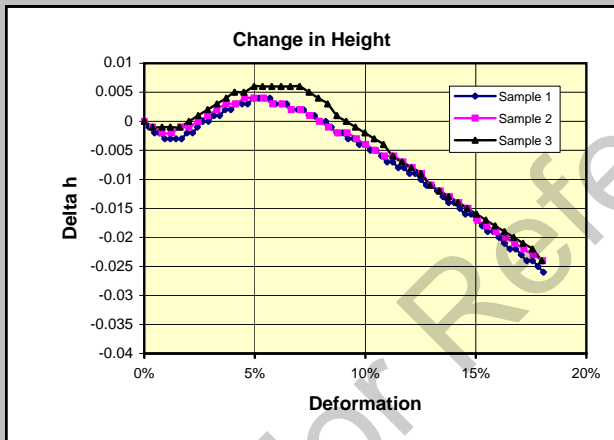

Sample Data: Initial				
Initial	1	2	3	4
Moisture	14.5%	14.5%	14.5%	
Dry Density, pcf	120.6	120.7	119.6	
Void Ratio	0.4240	0.4220	0.4347	
Saturation	94.4%	94.2%	91.9%	
Diameter, in.	2.38	2.375	2.375	
Height, in.	1.01	1.01	1.02	
Sample Data: At Test				
Moisture	13.8%	14.2%	14.1%	
Dry Density, pcf	123.5	122.9	123.6	
Void Ratio	0.3899	0.3972	0.3883	
Saturation	97.1%	98.6%	99.9%	
Diameter, in.	2.375	2.375	2.375	
Height, in.	0.99	0.99	0.99	
Normal Stress, psf	6200	7200	8200	
Shear Stress, psf	4807	5636	6264	
Deformation	Peak	Peak	Peak	
Ultimate Stress, psf	0	0	0	
Rate in/min.	0.002	0.002	0.002	

CTL #	659-001	Date:	12/3/2007
Client:	HMM		
Project Name:	SVRT		
Project Number:	213213	Reduced by:	MD
Sample #	Boring	Sample	Depth, ft.
1	MW-2D		105-108
2	MW-2D		105-108
3	MW-2D		105-108
4			
Visual Soil Classification			
1	Brown well graded SAND with Silt & Gravel		
2	Brown well graded SAND with Silt & Gravel		
3	Brown well graded SAND with Silt & Gravel		
4			

Remarks: Target density = 95% Relative density (123.5 pcf dry)

Direct Shear

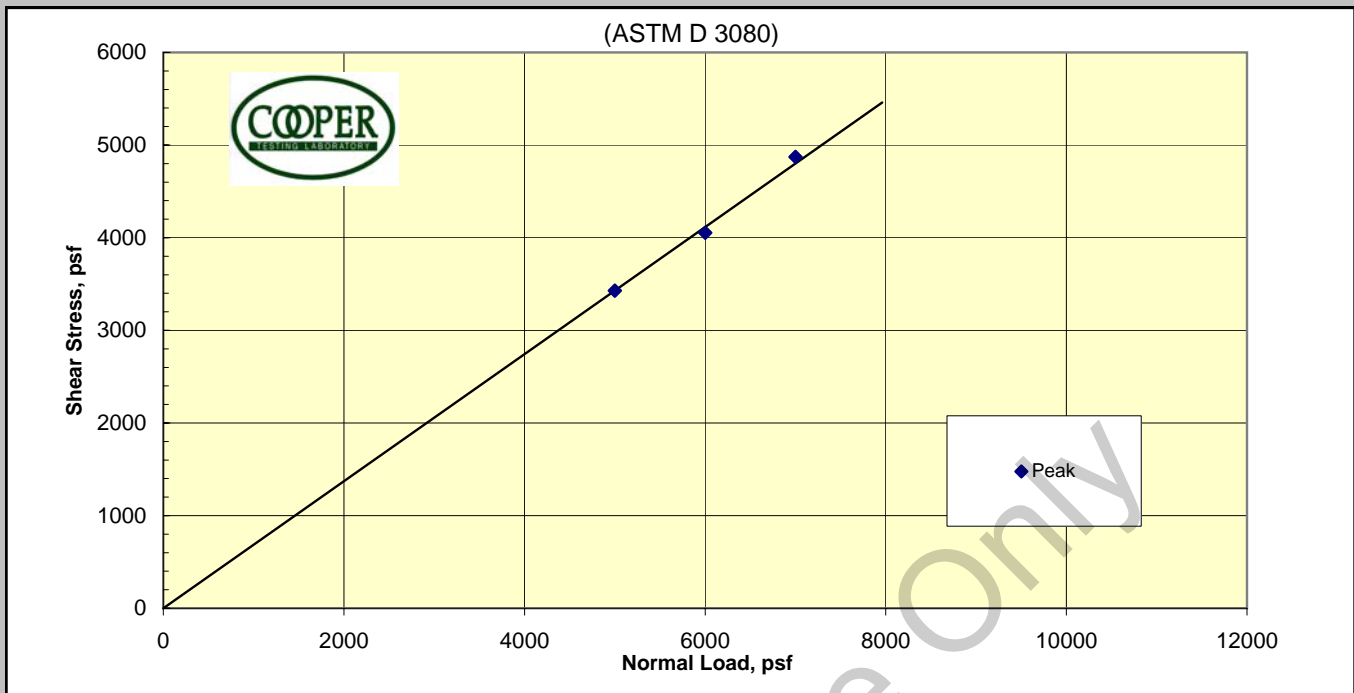

P. Phi (degrees)	34.4	Ult. phi (degrees)	
P. Cohesion (psf)	0	Ult. Cohesion (psf)	

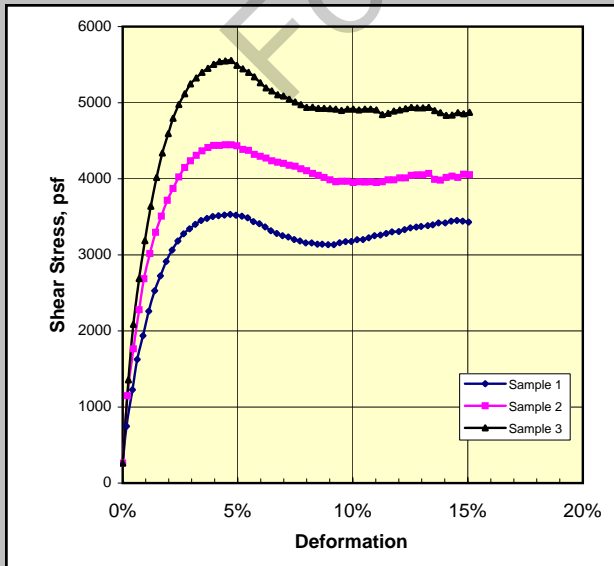
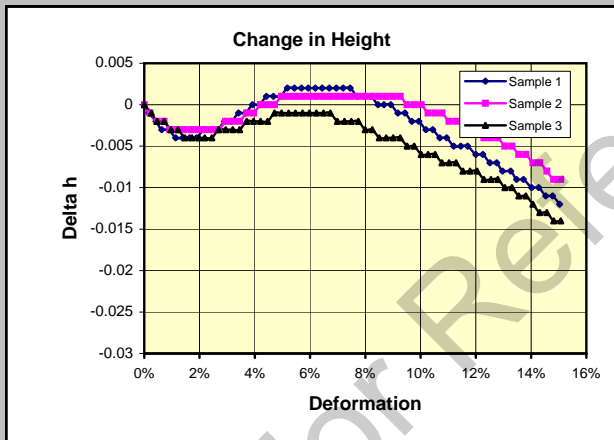

Sample Data: Initial				
Initial	1	2	3	4
Moisture	15.7%	15.7%	15.7%	
Dry Density, pcf	106.0	106.3	106.2	
Void Ratio	0.6192	0.6152	0.6152	
Saturation	69.9%	70.2%	70.2%	
Diameter, in.	2.38	2.375	2.375	
Height, in.	1.00	1.00	1.00	
Sample Data: At Test				
Moisture	17.3%	17.7%	18.0%	
Dry Density, pcf	108.1	108.7	108.5	
Void Ratio	0.5874	0.5792	0.5810	
Saturation	80.9%	84.1%	85.0%	
Diameter, in.	2.375	2.375	2.375	
Height, in.	0.98	0.98	0.98	
Normal Stress, psf	5000	6000	7000	
Shear Stress, psf	3429	4053	4872	
Deformation	15%	15%	15%	
Ultimate Stress, psf	0	0	0	
Rate in/min.	0.002	0.002	0.002	

CTL #	659-001	Date:	11/29/2007
Client:	HMM		
Project Name:	SVRT		

Project Number:	213213	Reduced by:	MD
Sample #	Boring	Sample	Depth, ft.
1	MW-4A		84-85
2	MW-4A		84-85
3	MW-4A		84-85
4			

Visual Soil Classification	
1	Brown poorly Graded SAND with Silt
2	Brown poorly Graded SAND with Silt
3	Brown poorly Graded SAND with Silt
4	

Remarks: Remolding target = 80% relative density (106.9pcf dry)

Direct Shear

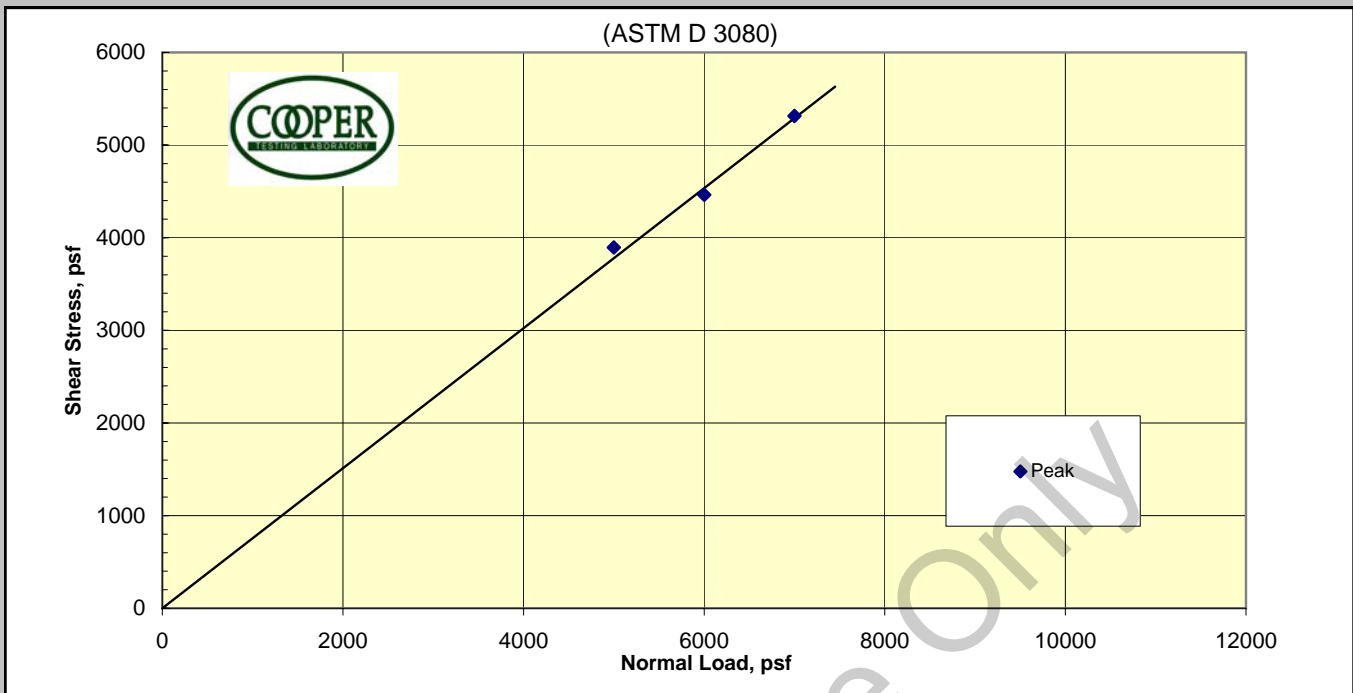

P. Phi (degrees)	37.1	Ult. phi (degrees)	
P. Cohesion (psf)	0	Ult. Cohesion (psf)	

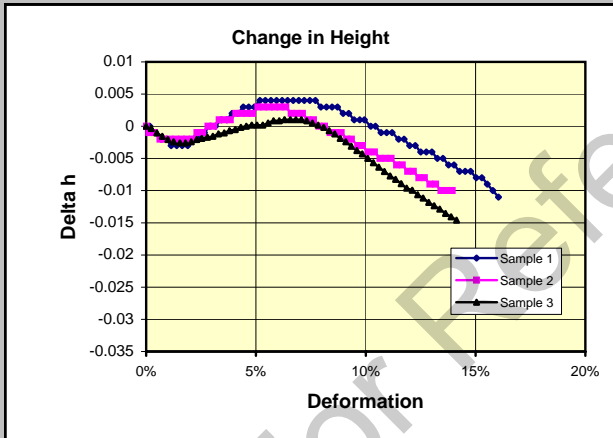

Sample Data: Initial				
Initial	1	2	3	4
Moisture	15.7%	15.7%	15.7%	
Dry Density, pcf	109.0	108.9	108.8	
Void Ratio	0.5745	0.5770	0.5770	
Saturation	75.1%	74.9%	74.9%	
Diameter, in.	2.38	2.375	2.375	
Height, in.	1.00	1.00	1.00	
Sample Data: At Test				
Moisture	16.6%	15.4%	16.2%	
Dry Density, pcf	111.3	111.9	112.0	
Void Ratio	0.5419	0.5337	0.5322	
Saturation	84.4%	79.4%	83.7%	
Diameter, in.	2.375	2.375	2.375	
Height, in.	0.98	0.97	0.97	
Normal Stress, psf	5000	6000	7000	
Shear Stress, psf	3894	4463	5315	
Deformation	5%	5%	5%	
Ultimate Stress, psf	0	0	0	
Rate in/min.	0.002	0.002	0.002	

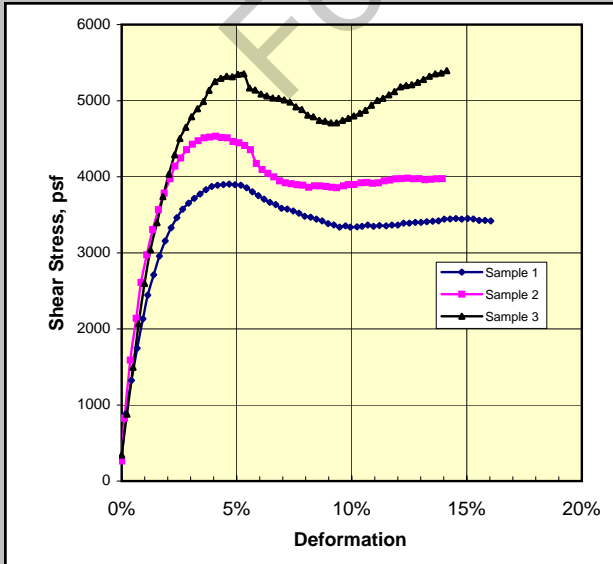

CTL #	659-001	Date:	12/4/2007
Client:	HMM		
Project Name:	SVRT		
Project Number:	213213	Reduced by:	MD
Sample #	Boring	Sample	Depth, ft.
1	MW-4A		84-85
2	MW-4A		84-85
3	MW-4A		84-85
4			
Visual Soil Classification			
1	Brown poorly graded SAND with Silt		
2	Brown poorly graded SAND with Silt		
3	Brown poorly graded SAND with Silt		
4			

Remarks: Remolding target = 95% relative density (110pcf dry)

Direct Shear

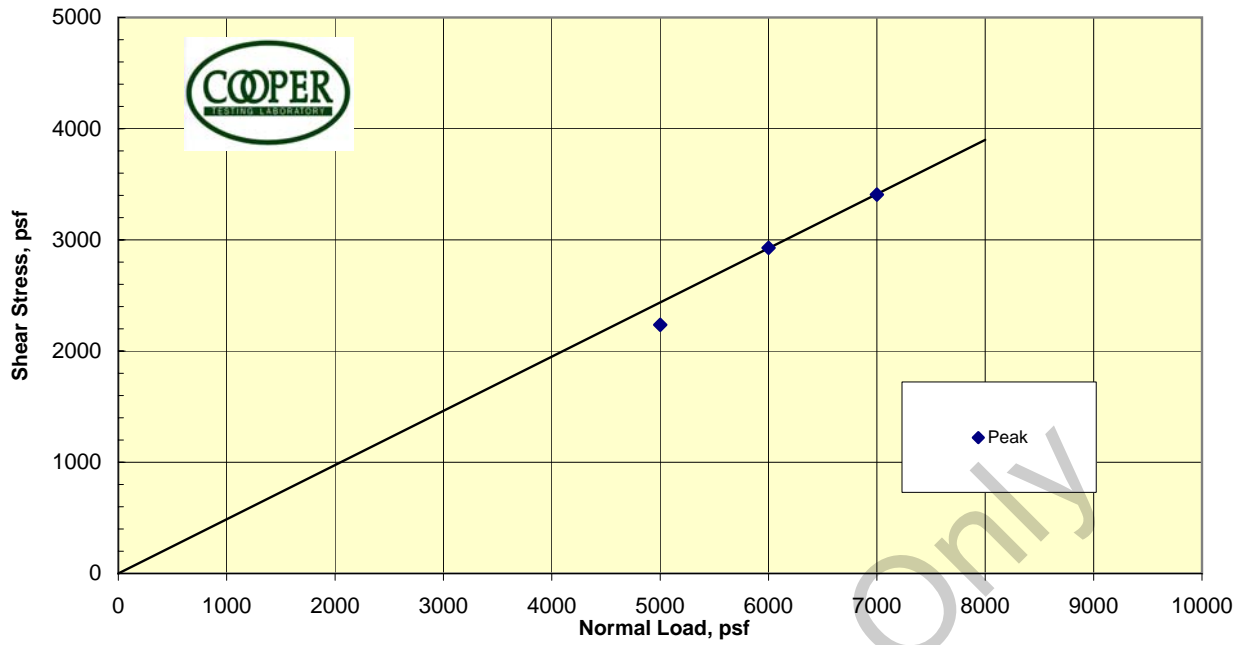

P. Phi (degrees)	26.0	Ult. phi (degrees)	
P. Cohesion (psf)	0	Ult. Cohesion (psf)	

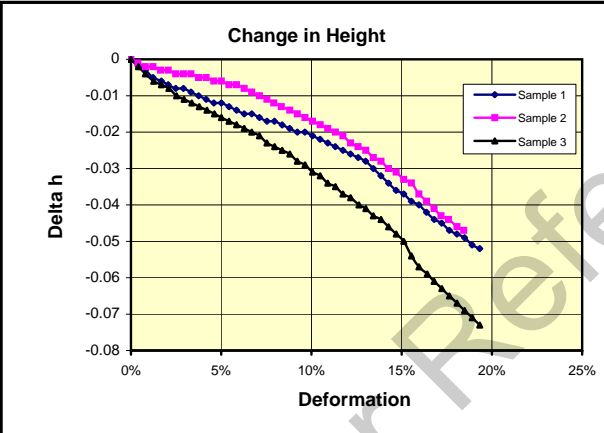

Sample Data: Initial				
Initial	1	2	3	4
Moisture	15.7%	15.7%	15.8%	
Dry Density, pcf	105.0	105.0	105.0	
Void Ratio	0.6343	0.6351	0.6351	
Saturation	68.1%	68.1%	68.4%	
Diameter, in.	2.38	2.375	2.375	
Height, in.	1.00	1.00	1.00	
Sample Data: At Test				
Moisture	17.8%	18.5%	18.6%	
Dry Density, pcf	107.4	107.5	107.5	
Void Ratio	0.5987	0.5975	0.5963	
Saturation	81.9%	85.2%	85.7%	
Diameter, in.	2.3754	2.375	2.375	
Height, in.	0.98	0.98	0.98	
Normal Stress, psf	5000	6000	7000	
Shear Stress, psf	2236	2929	3406	
Deformation	3%	3%	3%	
Ultimate Stress, psf	0	0	0	
Rate in/min.	0.002	0.002	0.002	

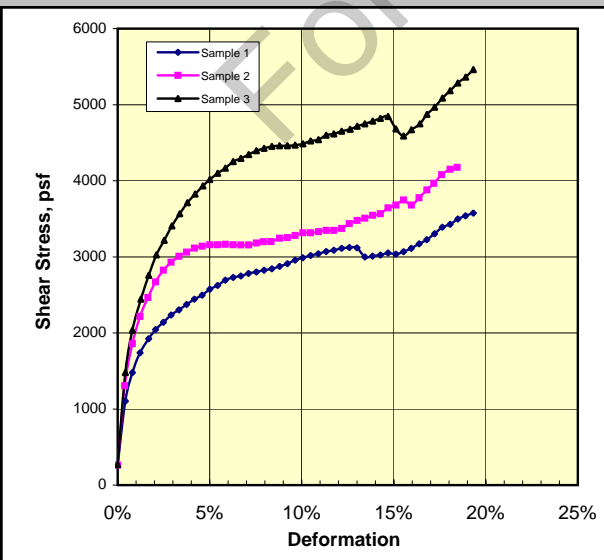

CTL #	659-001		Date:	11/19/2007	
Client:	HMM				
Project Name:	SVRT				
Project Number:	213213			Reduced by:	MD
Sample #	Boring	Sample	Depth, ft.		
1	MW-4A	95%	84-85		
2	MW-4A	95%	84-85		
3	MW-4A	95%	84-85		
4					
Visual Soil Classification					
1	Brown Poorly Graded SAND with Silt				
2	Brown Poorly Graded SAND with Silt				
3	Brown Poorly Graded SAND with Silt				
4					

Remarks: Due to the angularity of the material the strength envelope is non linear and increases as the confining stress increases, causing a negative cohesion. Note the stress-strain curves continue to increase at high strain, as the material interlocks. Remolding target = 65% relative density (103.9pcf dry)

Direct Shear

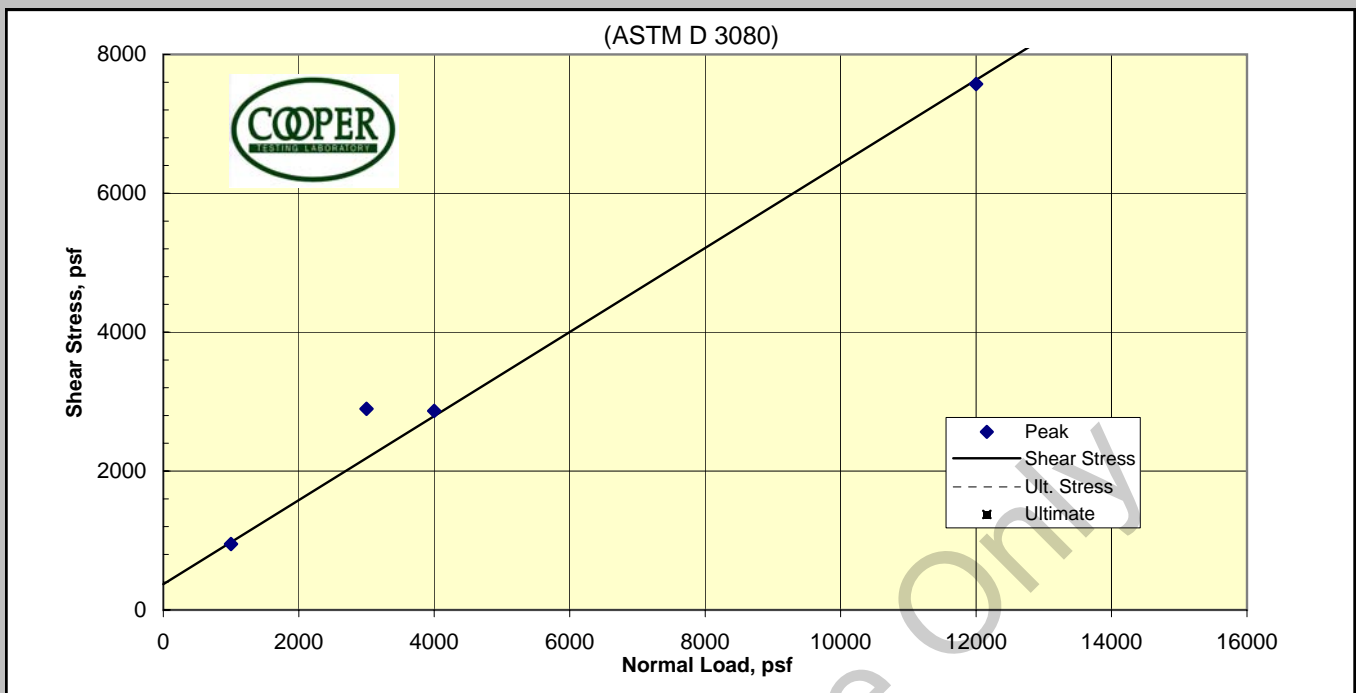

P. Phi (degrees)	31.2	Ult. phi (degrees)	
P. Cohesion (psf)	370	Ult. Cohesion (psf)	

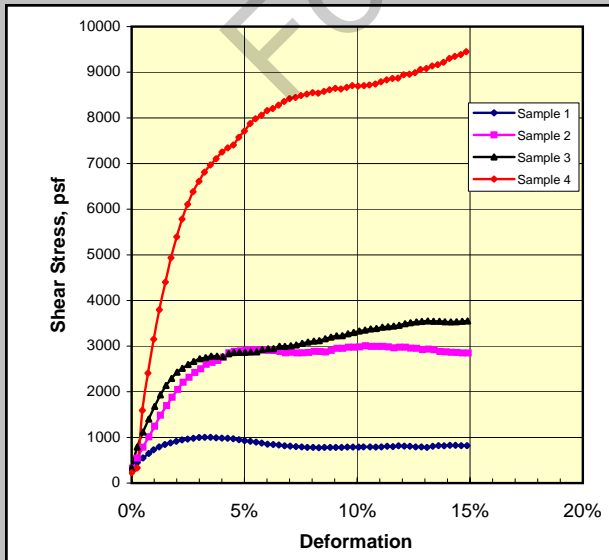
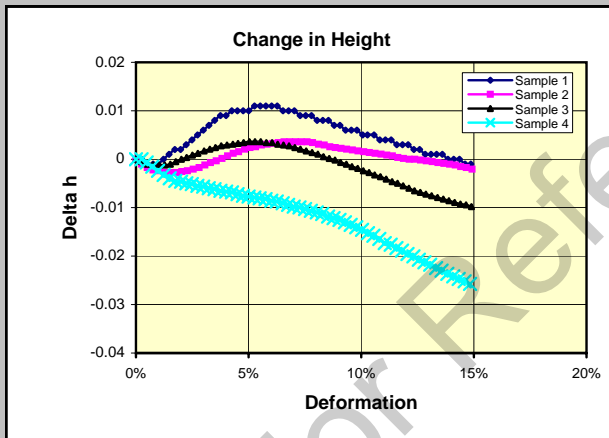

Sample Data: Initial				
Initial	1	2	3	4
Moisture	15.0%	15.0%	15.0%	15.0%
Dry Density, pcf	104.0	104.0	103.7	103.6
Void Ratio	0.681	0.680	0.680	0.680
Saturation	61.5%	61.6%	61.6%	61.6%
Diameter, in.	2.38	2.38	2.38	2.38
Height, in.	1.00	1.00	1.00	1.00
Sample Data: At Test				
Moisture	17.2%	17.1%	17.1%	17.1%
Dry Density, pcf	104.4	106.0	105.8	106.8
Void Ratio	0.674	0.649	0.647	0.630
Saturation	71.5%	73.8%	73.7%	75.7%
Diameter, in.	2.375	2.375	2.375	2.375
Height, in.	1.00	0.98	0.98	0.97
Normal Stress, psf	1000	3000	4000	12000
Shear Stress, psf	949	2897	2865	7574
Deformation	5%	5%	5%	5%
Ultimate Stress, psf	0	0	0	0
Rate in/min.	0.002	0.002	0.002	0.002

CTL #	659-003	Date:	7/26/2007
Client:	HMM		
Project Name:	SVRT		

Project Number:		Reduced by:	MD
Sample #	Boring	Sample	Depth, ft.
1	MW4A		84-85
2	MW4A		84-85
3	MW4A		84-85
4			

Visual Soil Classification	
1	Brown poorly Graded SAND with Silt
2	Brown poorly Graded SAND with Silt
3	Brown poorly Graded SAND with Silt
4	Brown poorly Graded SAND with Silt

Remarks: Sample remolded to 105pcf @ 15%

Direct Shear

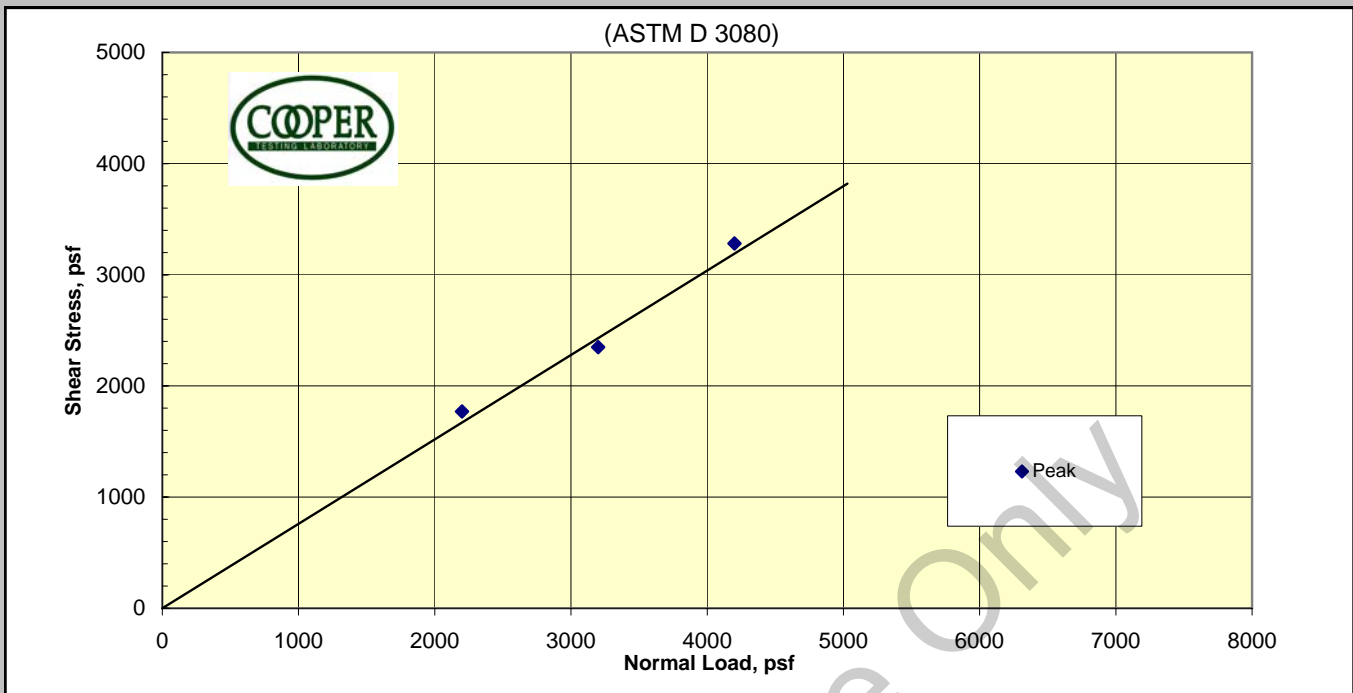

P. Phi (degrees)	37.2	Ult. phi (degrees)	
P. Cohesion (psf)	0	Ult. Cohesion (psf)	

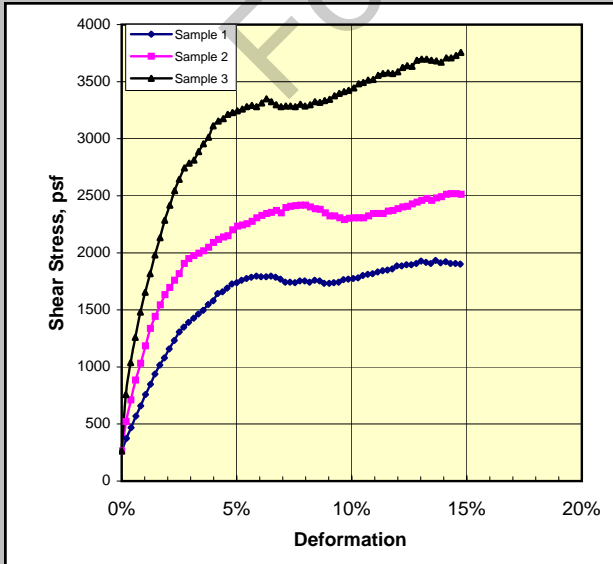
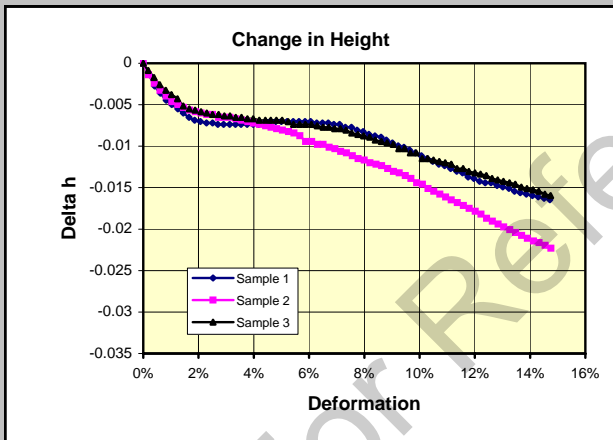

Sample Data: Initial				
Initial	1	2	3	4
Moisture	15.3%	15.3%	15.3%	
Dry Density, pcf	101.5	101.4	101.4	
Void Ratio	0.6919	0.6933	0.6933	
Saturation	60.6%	60.6%	60.6%	
Diameter, in.	2.38	2.375	2.375	
Height, in.	1.00	1.00	1.00	
Sample Data: At Test				
Moisture	20.8%	20.7%	22.2%	
Dry Density, pcf	103.0	103.6	103.5	
Void Ratio	0.6667	0.6567	0.6595	
Saturation	85.6%	86.7%	92.7%	
Diameter, in.	2.375	2.375	2.375	
Height, in.	0.99	0.98	0.98	
Normal Stress, psf	2200	3200	4200	
Shear Stress, psf	1770	2349	3281	
Deformation	7%	7%	7%	
Ultimate Stress, psf	0	0	0	
Rate in/min.	0.001	0.001	0.001	

CTL #	659-001	Date:	11/30/2007
Client:	HMM		
Project Name:	SVRT		

Project Number:	213213	Reduced by:	MD
Sample #	Boring	Sample	Depth, ft.
1	MW-6K		37-38.5
2	MW-6K		37-38.5
3	MW-6K		37-38.5
4			

Visual Soil Classification	
1	Brown Silty SAND
2	Brown Silty SAND
3	Brown Silty SAND
4	

Remarks: Remolding target = 65% relative density(101.7pcf dry)

Direct Shear

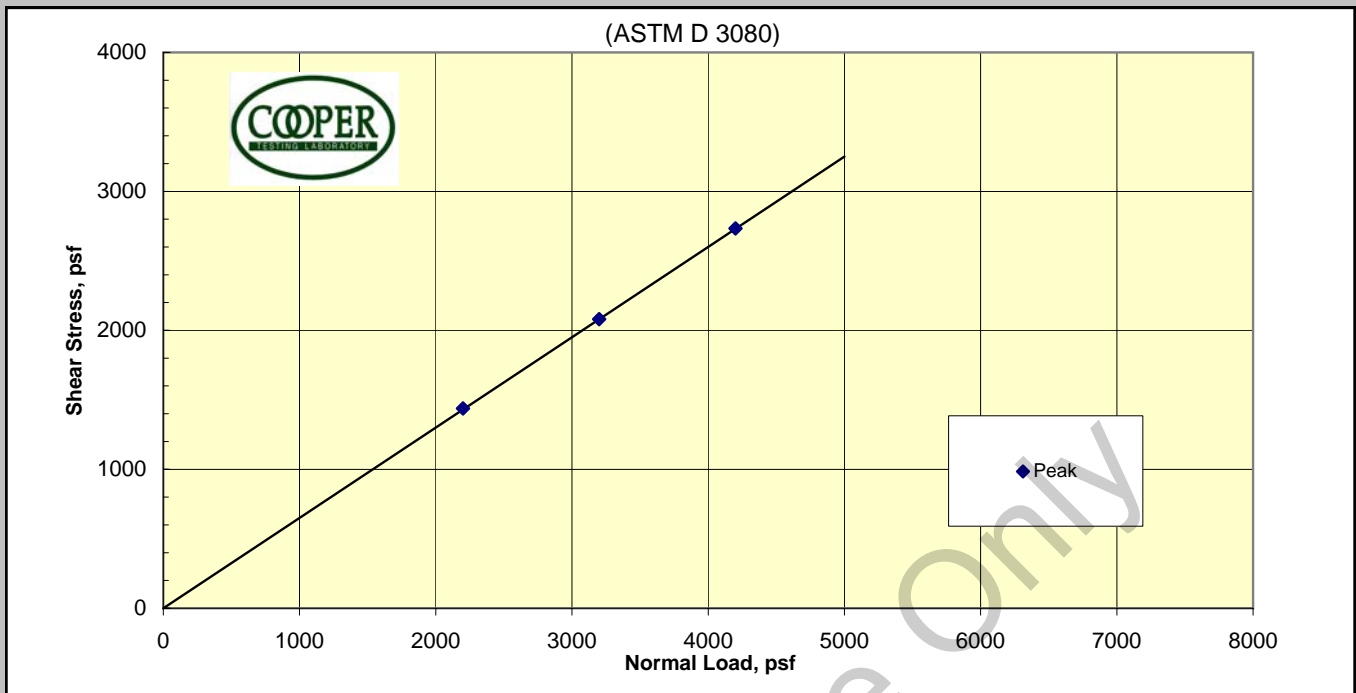

P. Phi (degrees)	33.0	Ult. phi (degrees)	
P. Cohesion (psf)	0	Ult. Cohesion (psf)	

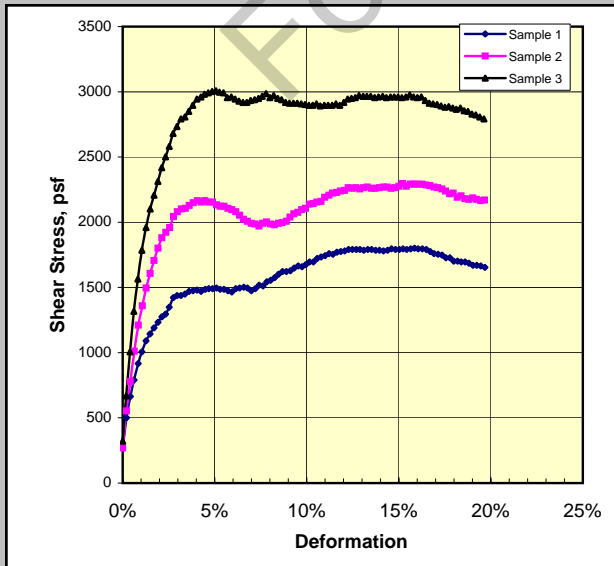
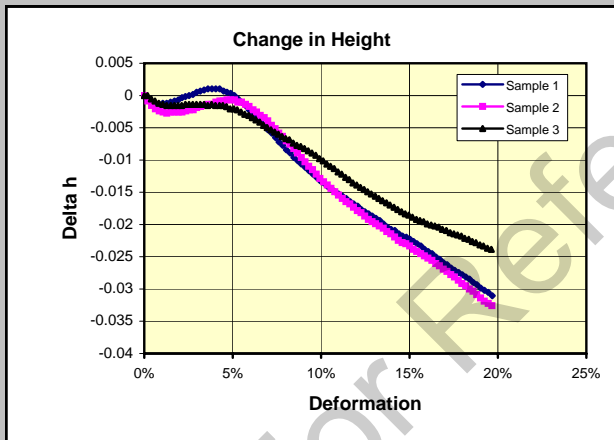

Sample Data: Initial				
Initial	1	2	3	4
Moisture	15.3%	15.3%	15.3%	
Dry Density, pcf	104.7	104.7	104.7	
Void Ratio	0.6391	0.6404	0.6404	
Saturation	65.7%	65.6%	65.6%	
Diameter, in.	2.38	2.375	2.375	
Height, in.	1.00	1.00	1.00	
Sample Data: At Test				
Moisture	15.6%	15.8%	19.3%	
Dry Density, pcf	109.4	109.6	106.7	
Void Ratio	0.6168	0.6129	0.6098	
Saturation	85.3%	86.3%	87.5%	
Diameter, in.	2.375	2.375	2.375	
Height, in.	0.99	0.98	0.98	
Normal Stress, psf	2200	3200	4200	
Shear Stress, psf	1438	2081	2734	
Deformation	3%	3%	3%	
Ultimate Stress, psf	0	0	0	
Rate in/min.	0.001	0.001	0.001	

CTL #	659-001	Date:	11/9/2007
Client:	HMM		
Project Name:	SVRT		
Project Number:	213213	Reduced by:	MD
Sample #	Boring	Sample	Depth, ft.
1	MW-6K		37-38.5
2	MW-6K		37-38.5
3	MW-6K		37-38.5
4			
Visual Soil Classification			
1	Brown Silty SAND		
2	Brown Silty SAND		
3	Brown Silty SAND		
4			

Remarks: Remolding target = 80% relative density (105.3pcf dry)

Direct Shear

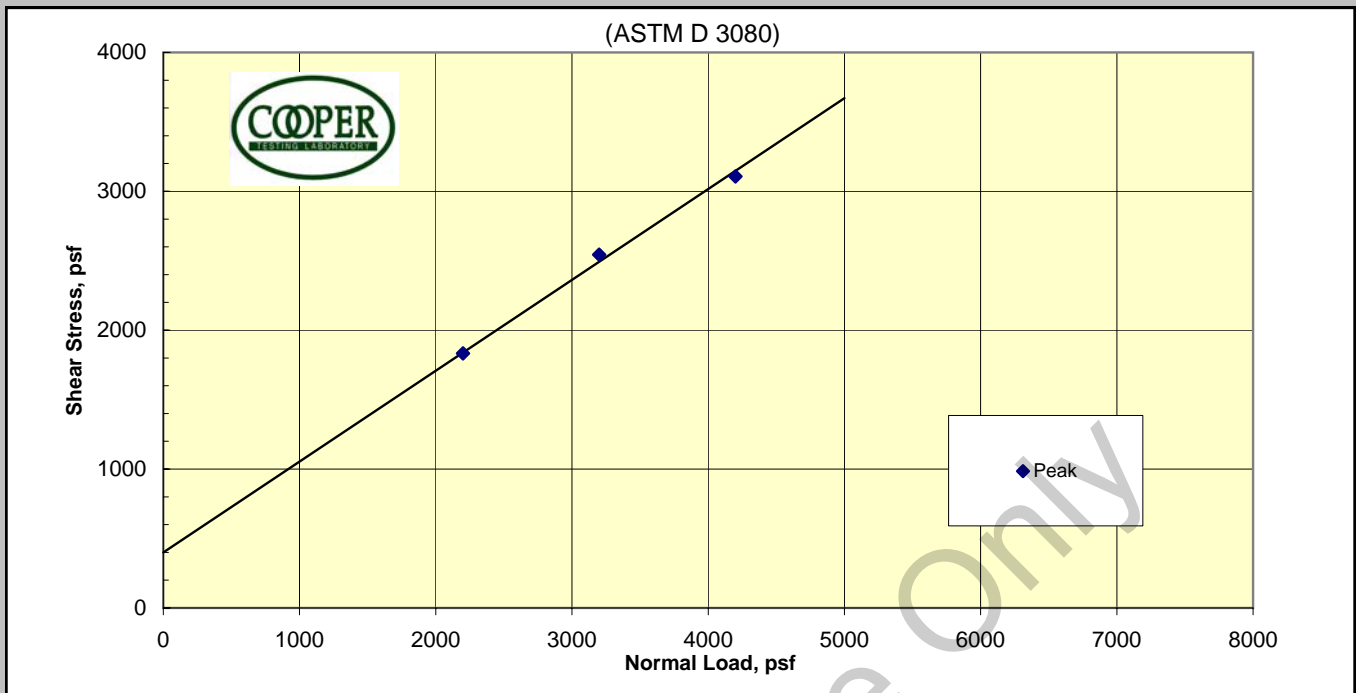

P. Phi (degrees)	33.2	Ult. phi (degrees)	
P. Cohesion (psf)	400	Ult. Cohesion (psf)	

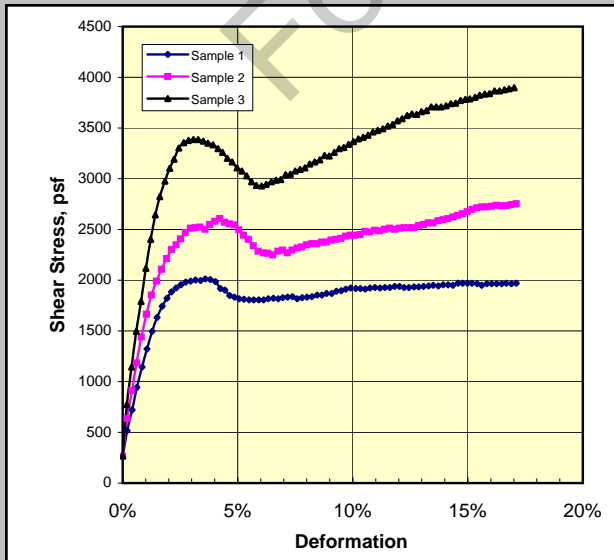
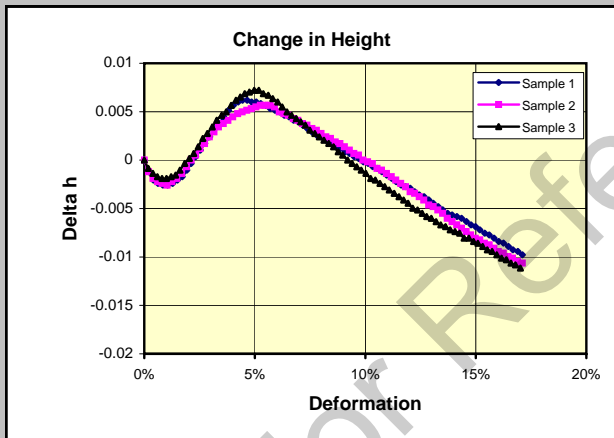

Sample Data: Initial				
Initial	1	2	3	4
Moisture	15.3%	15.3%	15.3%	
Dry Density, pcf	108.8	108.7	108.7	
Void Ratio	0.5782	0.5794	0.5794	
Saturation	72.9%	72.8%	72.8%	
Diameter, in.	2.38	2.375	2.375	
Height, in.	1.00	1.00	1.00	
Sample Data: At Test				
Moisture	17.9%	17.7%	16.7%	
Dry Density, pcf	110.7	110.6	111.7	
Void Ratio	0.5503	0.5529	0.5366	
Saturation	89.7%	88.1%	85.5%	
Diameter, in.	2.375	2.375	2.375	
Height, in.	0.98	0.98	0.97	
Normal Stress, psf	2200	3200	4200	
Shear Stress, psf	1833	2544	3108	
Deformation	5%	5%	5%	
Ultimate Stress, psf	0	0	0	
Rate in/min.	0.001	0.001	0.001	

CTL #	659-001	Date:	12/6/2007
Client:	HMM		
Project Name:	SVRT		
Project Number:	213213	Reduced by:	MD
Sample #	Boring	Sample	Depth, ft.
1	MW-6K		37-38.5
2	MW-6K		37-38.5
3	MW-6K		37-38.5
4			
Visual Soil Classification			
1	Brown Silty SAND		
2	Brown Silty SAND		
3	Brown Silty SAND		
4			

Remarks: Remolding target = 95% relative density (109.2pcf dry)

For Reference Only

Appendix 9: Consolidation and Cyclic Shear Test Results

For Reference Only

Memorandum

Date: November 1, 2007

To: Peter Chiu, Project Engineer
Praad Geotechnical

From: Jonathan Stewart, Ph.D., P.E. and Eric Yee
UCLA Civil & Environmental Engineering Department

RE: Draft report on results of cyclic simple shear (CSS) laboratory testing for SVRT project

Overview and Test Procedures

Suites of cyclic simple shear tests have been completed on three samples: BH-101 at 35 ft depth, BH-89 at 20 ft depth, and BH-85 at 50 ft depth. All of the samples were obtained using Shelby tubes. We do not know the date of sampling.

The procedure and equipment that was used in our testing program is summarized below:

1. Samples tubes were cut around their perimeter with a band saw.
2. A wire saw was used to cut the soil in the sample tube. By this process, a slice of the sample tube with soil approximately 4-6 cm in height was obtained.
3. Appropriate measurements were made to evaluate the water content and density of the soil in the cut section of sample tube.
4. As discussed further below, samples were soaked while still inside the cut Shelby tube section to increase saturation levels. This soaking took place for 24 to 48 hours. During the soaking phase the specimens were under the in situ vertical stresses corresponding to the sample depths ($\sigma_v = 2,200$ psf for BH101-35, 2,400 psf for BH89-20, and 3700 psf for BH85-50 ft).
5. Soils specimens were extracted from the cut section of Shelby tube by pushing them out with a static force acting on a plate just slightly smaller than the inside diameter of the tube. Specimens were then carefully trimmed by hand to a diameter of 7.1 cm.
6. A wire-reinforced membrane was carefully placed around the specimen, which was then positioned for placement in the simple shear apparatus. The purpose of the wire-reinforced membrane is to minimize lateral extension of the samples.
7. A vertical load was applied to the specimen matching the in situ vertical stress from the location of the sample depth. Those vertical stresses are indicated in Item (4) above.
8. Prescribed strain histories were applied to the specimens. Measured responses include horizontal displacements (used in the control algorithm), vertical load (which

remains constant), vertical displacement, and horizontal loads. Results are typically presented as shear stress versus shear strain and vertical strain versus shear strain.

All shear testing was performed using the Digitally Controlled Simple Shear (DCSS) device in the geotechnical laboratory at UCLA. Details on the physical characteristics and capabilities of the device are given in Duku et al. (2007).

Saturation of Specimens

Our understanding is that these samples have been handled previously by another laboratory. Some drying of sample BH101 was evident from saturation levels measured on specimens retrieved from the bottom of the sample tube that ranged from 78-92%. Saturations were much higher for the other specimens (BH89 and BH85).

Because field saturations are expected to be unity, we soaked the specimens for times ranging from 24 to 48 hours to increase saturation levels prior to simple shear testing. The need for this soaking had not been anticipated when the testing program was first discussed. The use of this soaking phase is a major factor in the relatively long time frame involved in completing the tests. The configuration under which the specimens were given access to water is depicted in Figure 1.

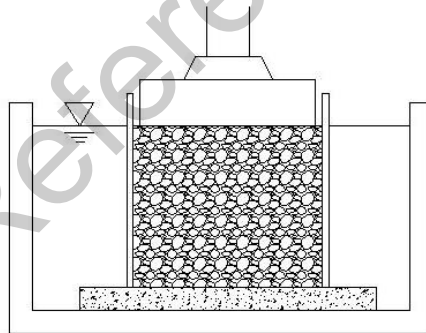

Figure 1. Configuration of specimen during soaking phase

As shown in Figure 1, during the soaking phase the soil specimen is within a cut section of the Shelby tube. It sits upon a pre-saturated porous stone and has an aluminum top cap with a diameter nearly matching the inside diameter of the Shelby tube. A vertical seating load is placed on the top cap matching the in situ vertical stress at the sample depth. The soaking was generally effective in raising the saturation for BH101, with little effect for the other samples.

Format of Results

Results of the simple shear tests are presented in three figures per sample. The results are presented in the following order: BH101-35 (Figures 2-4), BH89-20 (Figures 5-7), and BH85-50 (Figures 8-10). For each sample, CSS tests were performed on three specimens under the following conditions: monotonic fast test with $\dot{\gamma} = 1\%/sec$, monotonic slow test with $\dot{\gamma} = 1\%/20$ min (0.0008%/sec), and cyclic test with strain rate of $\dot{\gamma} = 1\%/sec$ and full stress-strain cycles at strain amplitudes of approximately $\gamma=0.05\%$, 0.10%, 0.15%, 0.2%, 0.3%, 0.5%, 1%, and 1.7%. One cycle was performed at each of those strain levels, followed by monotonic shear to the next strain level.

The first figure for each sample (Figures 2, 5, and 8) summarizes the monotonic test results and cyclic backbone curves. Those results are interpreted in the section below titled: "Evaluation of Backbone Curve Results." The second figure for each sample (Figures 3, 6, and 9) shows the stress-strain cyclic loops obtained in the fast cyclic tests. The third figure for each sample (Figures 4, 7, and 10) shows shear moduli and damping values inferred from the cyclic loops. Also shown in the damping plots are estimates of damping versus shear strain calculated using the model of Darendeli (2001). An interpretation of the shear moduli and damping values is presented in the section below titled: "Interpretation of Shear Modulus and Damping Results."

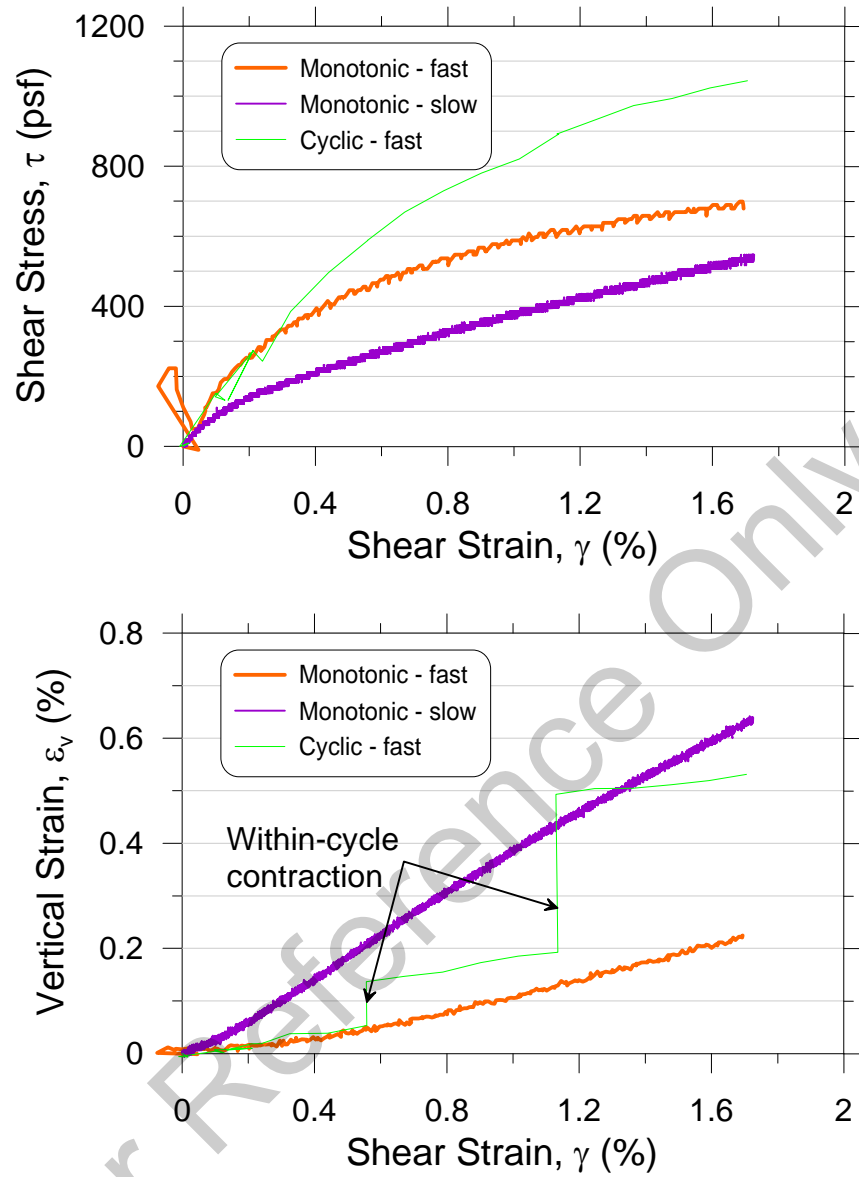

Figure 2. Variation of shear stress and vertical strain with shear strain for fast and slow monotonic CSS tests on specimens from sample BH101-35 ft

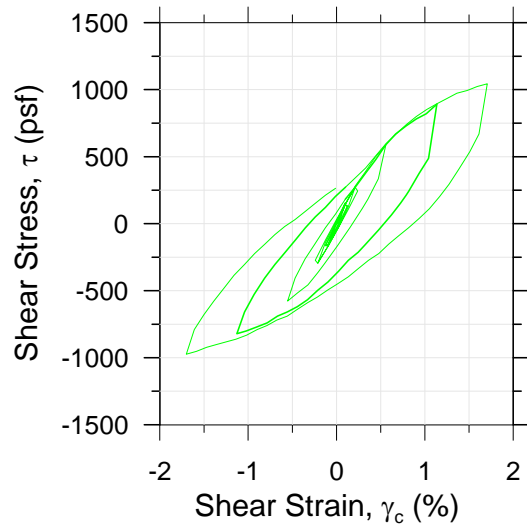

Figure 3. Cyclic stress-strain hysteresis curves for specimen from Sample BH-101-35ft.

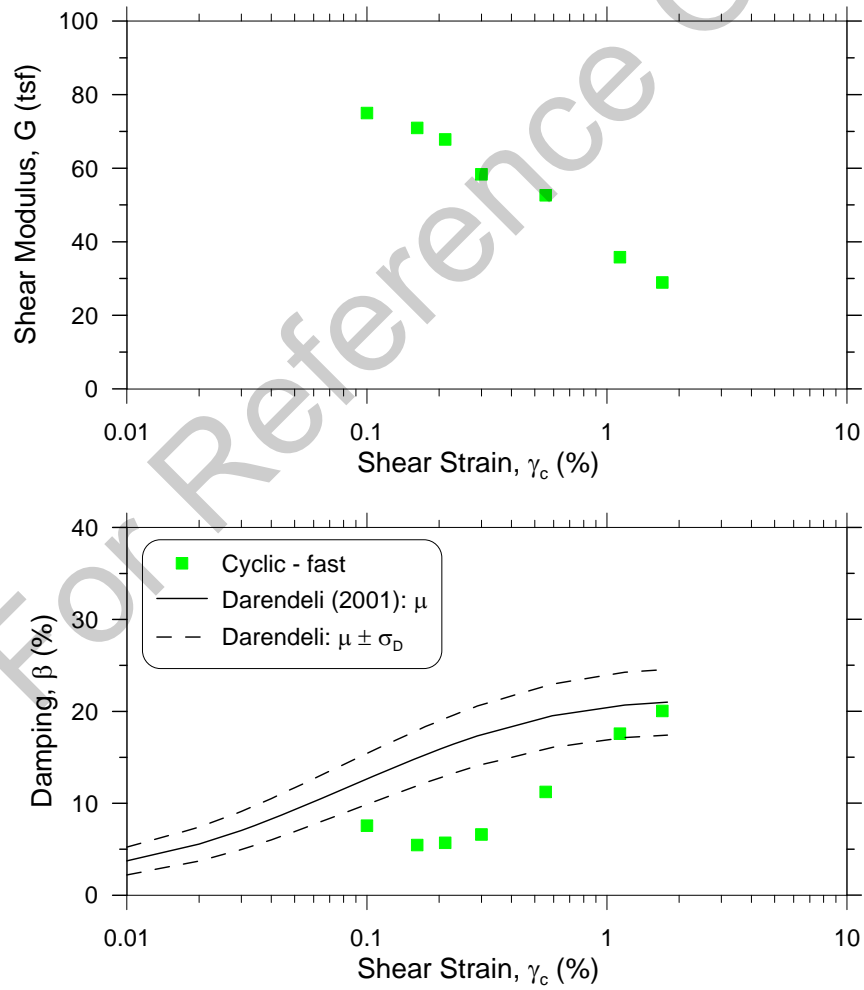

Figure 4. Shear modulus and damping ratio versus shear strain. Sample BH-101-35ft. Darendeli model prediction is for $\sigma_v = 2,200$ psf, $PI=12$, and $OCR=2$

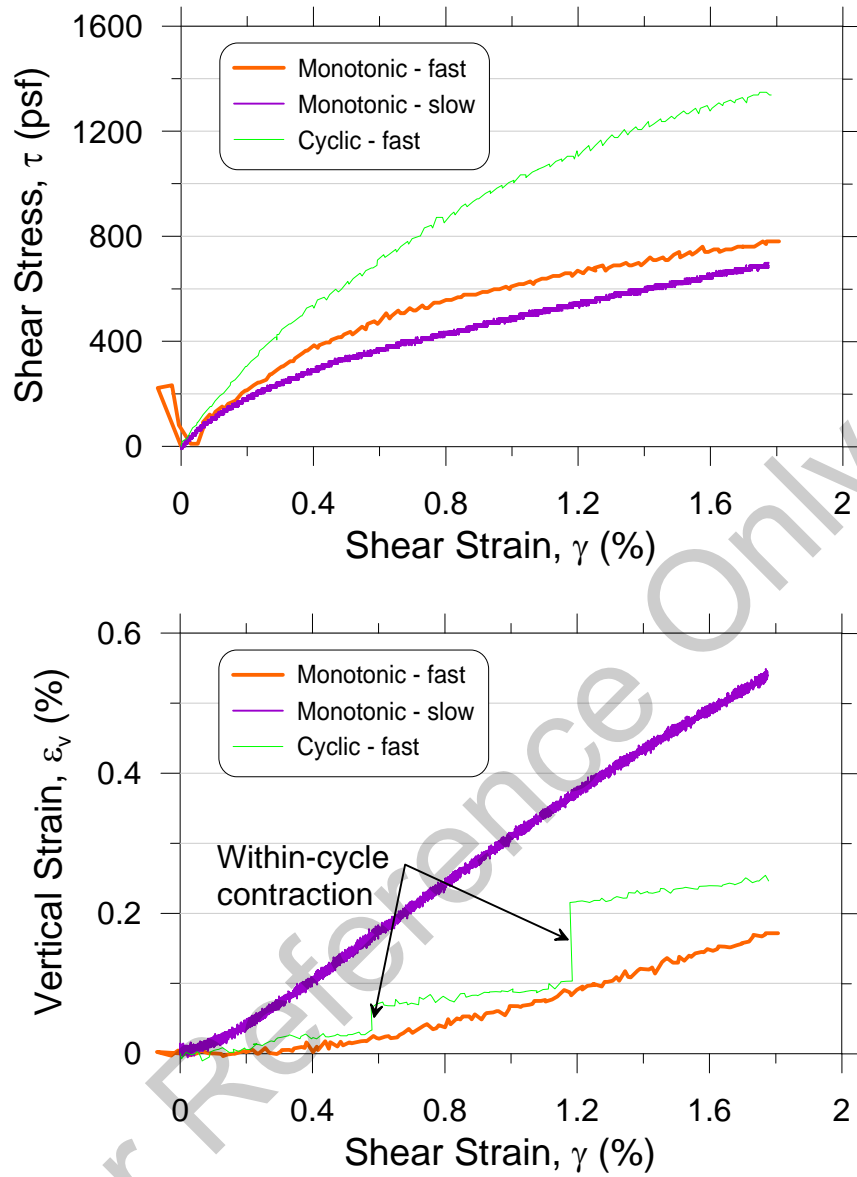

Figure 5. Variation of shear stress and vertical strain with shear strain for fast and slow monotonic CSS tests and fast cyclic test on specimens from sample BH89-20 ft

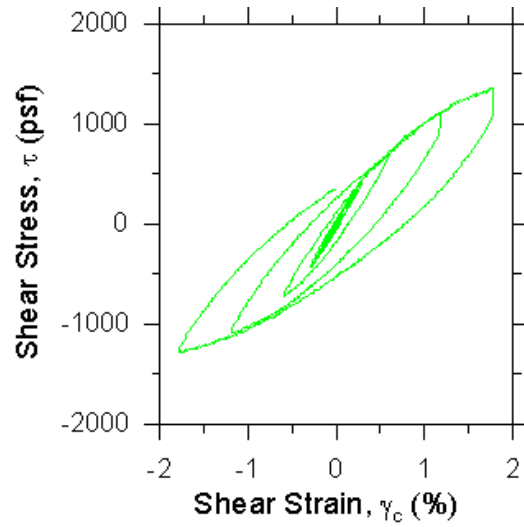

Figure 6. Cyclic stress-strain hysteresis curves for specimen from Sample BH-89, 20ft.

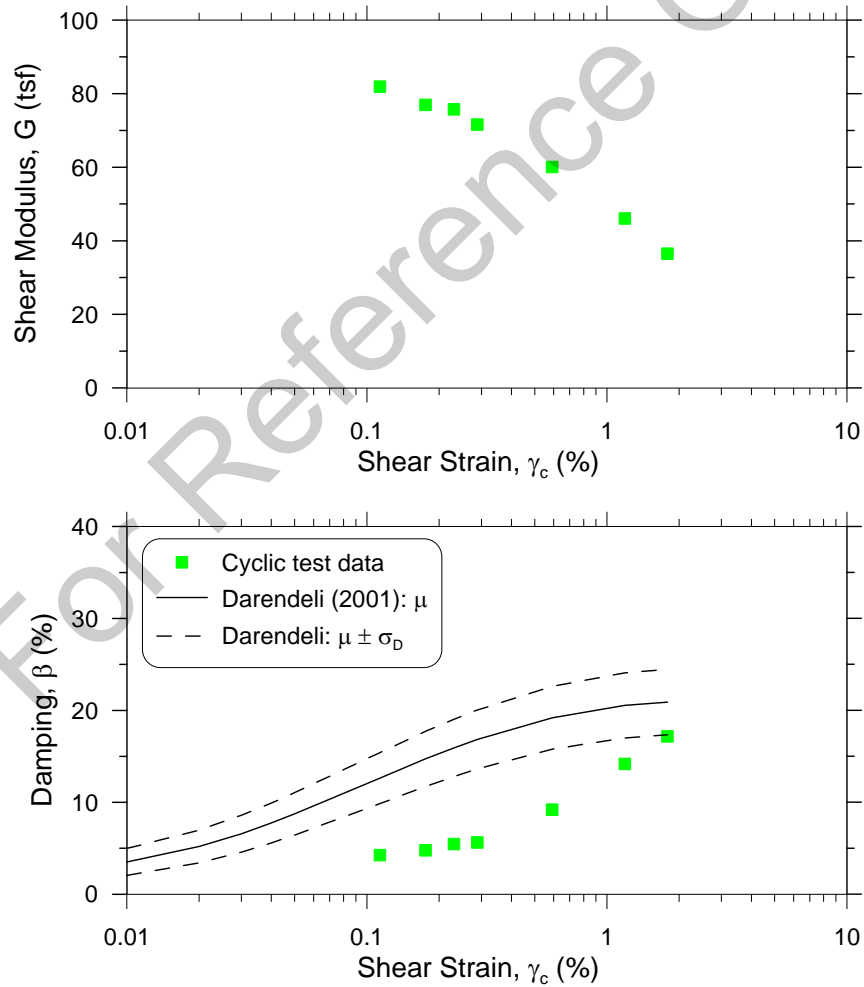

Figure 7. Shear modulus and damping ratio versus shear strain. Sample BH-89, 20ft. Darendeli model prediction is for $\sigma_v = 2,400$ psf, $PI=16$, and $OCR=2$

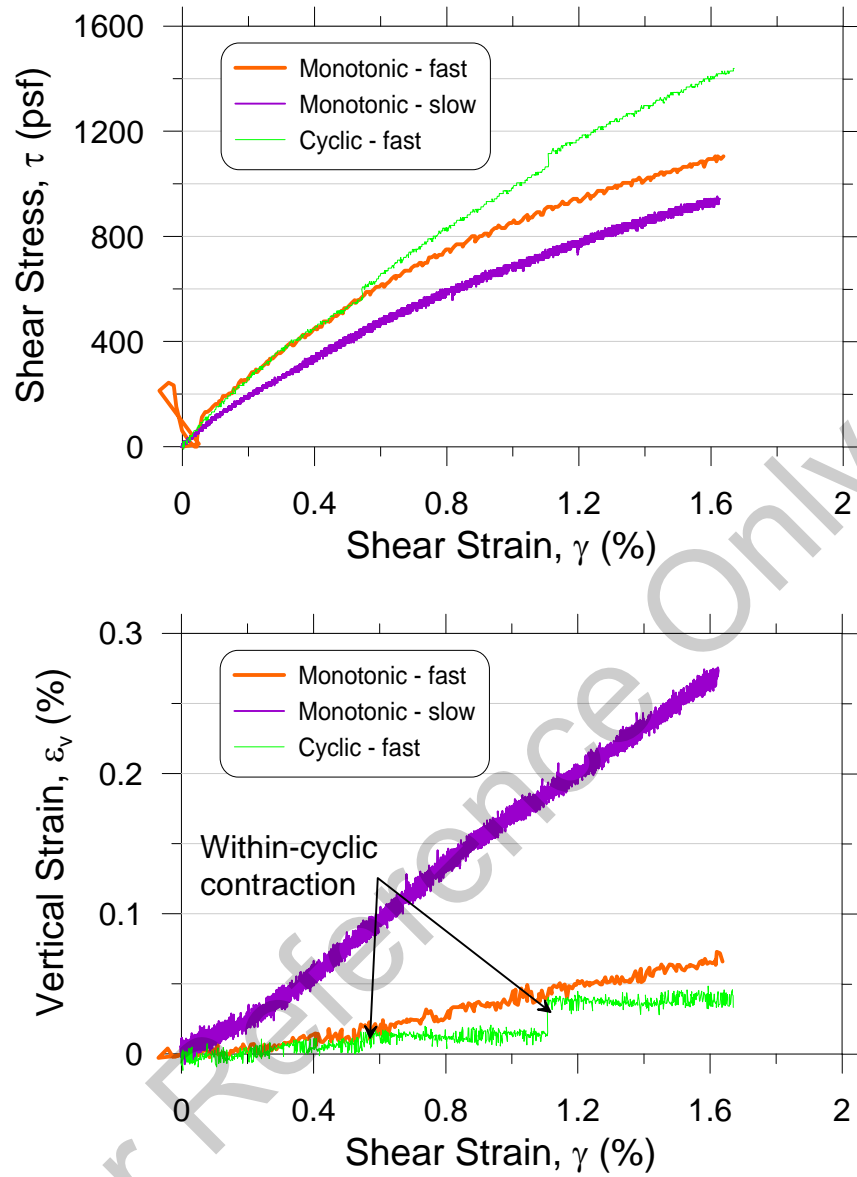

Figure 8. Variation of shear stress and vertical strain with shear strain for fast and slow monotonic CSS tests and fast cyclic test on specimens from sample BH85-50 ft

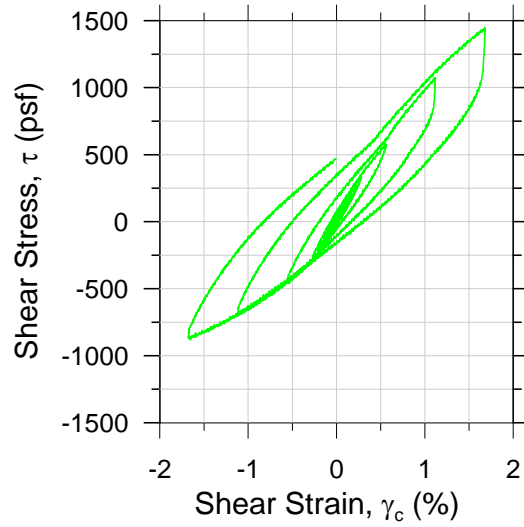

Figure 9. Cyclic stress-strain hysteresis curves for specimen from Sample BH-85, 50ft.

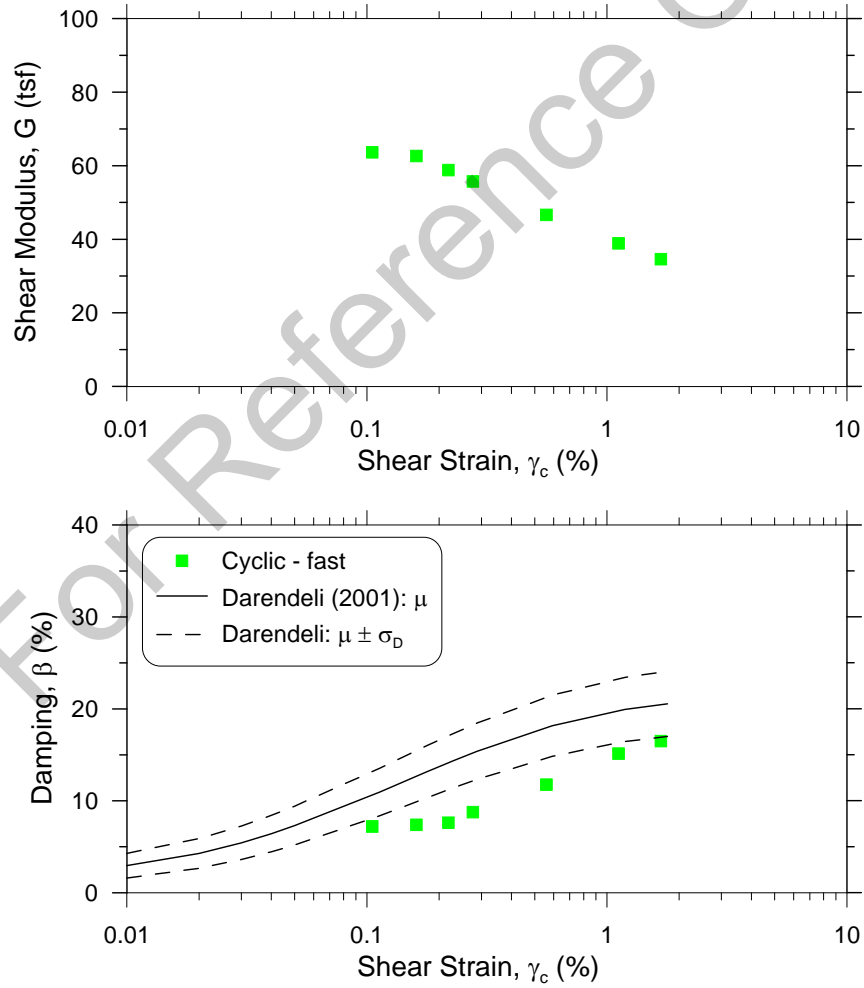

Figure 10. Shear modulus and damping ratio versus shear strain. Sample BH-85-50ft. Darendeli model prediction is for $\sigma_v = 3,700$ psf, $PI=24$, and $OCR=2$

Evaluation of Backbone Curve Results

One important point of comparison with respect to the backbone curves are differences between the slow and fast monotonic tests. Comparing shear stresses for shear strains of approximately 0.2, 0.5, 1.0, and 1.5%, the rate effects are found to be as indicated below:

- BH101: range of 35 to 92%, average 65%
- BH89: range of 18 to 28%, average 24%
- BH85: range of 18 to 37%, average 28%

For each specimen, testing was performed to a maximum strain of approximately 1.7% due to control difficulties that were encountered for larger strains. Although we did not reach a peak strength for the specimens, it is likely reasonable to take the rate effect for these samples as the values given above since at $\gamma=1.7\%$ we are well beyond the maximum strain anticipated for the SVRT project.

The fast cyclic test produces larger stresses than the fast monotonic tests, which may be due to strain hardening resulting from within-cycle specimen contraction, as shown in the bottom half of Figures 2, 5, and 8. Volumetric contraction of unsaturated soils subjected to cyclic loading, such as depicted in the bottom frame of the figures, is a well-known phenomenon (e.g., Whang et al., 2004).

The differences between the monotonic-fast and cyclic-fast results lead us to believe that separate specimens should be used to evaluate damping ratios and rate effects on shear strength. That is, if the fast monotonic test were omitted, the effect of strain rate could not be isolated from the effect of within-cycle contraction in comparing the monotonic-slow and cyclic-fast tests.

Interpretation of Shear Modulus and Damping Results

Figures 4, 7, and 10 show secant shear moduli and damping ratios calculated from the stress-strain loops. The results at small strains ($\leq 0.2\%$) for BH85 (Figure 10) have relatively high uncertainty due to a controller error that led to a relatively small number of data points being recorded to define the cyclic loops.

There are two points that should be made in connection with the shear moduli reported in these figures.

1. The moduli do not extend to the very small strains that would typically be associated with the maximum shear modulus, G_{max} . The lowest strain for which moduli are reported is $\gamma=0.1\%$. Values of G_{max} should generally be taken from strain cycles at amplitudes of approximately $\gamma=10^{-4}\%$. The DCSS device is not well configured for very

small-strain testing, as would be required to evaluate a laboratory value of G_{max} . Alternative devices, such as described by Doroudian and Vucetic (1995) could be employed for such testing.

2. Allowing for typical levels of modulus reduction associated with the minimum tested strain level of 0.1% ($G/G_{max} \approx 0.5$ at $\gamma=0.1\%$), the inferred values of maximum shear modulus (denoted here $G_{max-inf}$) are approximately 150 tsf for BH101, 170 tsf (BH89) and 130 tsf (BH85). Based on the in situ measurement of shear wave velocity ($V_s = 640$ ft/s, 580 ft/s, and 760 ft/s for the respective samples), the “field” values of $G_{max} = 700$ tsf, 570 tsf, and 990 tsf, respectively. Hence, the ratios of laboratory-to-field G_{max} are approximately 0.21, 0.30, and 0.13. This offset between laboratory and field estimates of G_{max} is well established in the literature. For example, Hueze et al. (2003) found the laboratory/field G_{max} ratios for three sites to typically be in the range of 0.1-0.5 for Pitcher barrel sample depths retrieved from 2-90 m depth. These offsets between laboratory and field moduli result from sample disturbance, possible lack of full K_0 lateral pressures for samples tested at the in situ vertical stress, and different strain rates in the laboratory and field tests.

As a result of the above points, the shear moduli reported in Figure 4, 7, and 10 are not expected to be representative of field conditions. They could be used to construct a modulus reduction (G/G_{max}) curve following appropriate extrapolation to G_{max} if that is desired. Additional testing could also be undertaken to measure G_{max} in the laboratory (this was not part of our scope).

In the lower part of Figures 4, 7, and 10, the damping data are compared to the predictions of the Darendeli (2001) model. The Darendeli model was used with the parameters given in the respective captions. The comparisons show that the Darendeli model predicts higher levels of damping than demonstrated by the data. It is possible that the reduced damping is related to suction effects increasing the inter-particle stresses beyond those represented by the seating load. That is, damping is known to decrease with confining pressure for granular and low-plasticity soils (e.g., Seed et al., 1986; Darendeli, 2001), so additional confinement from suction could decrease damping levels relative to what would have been measured in a fully saturated specimen.

References

- Darendeli, M. (2001). “Development of a new family of normalized modulus reduction and material damping curves.” Ph.D. Dissertation, Dept. of Civil Engrg., Univ. of Texas, Austin.
- Doroudian, M. and M. Vucetic (1995). “A direct simple shear device for measuring small strain behavior,” *Geotech. Testing Journal*, ASTM, 18 (1), 69-85.

Duku, P.M., J.P. Stewart, D.H. Whang, R. Venugopal (2007). "Digitally controlled simple shear apparatus for dynamic soil testing," *Geotech. Testing Journal, ASTM*, 30 (5), 368-377.

Heuze, F., R. Archuleta, F. Bonilla, S. Day, M. Doroudian, A. Elgamal, S. Gonzales, M. Hoehler, T. Lai, D. Lavallee, B. Lawrence, P.-C. Liu, A. Martin, L. Matesic, B. Minster, R. Mellors, D. Oglesby, S. Park, M. Riemer, J. Steidl, F. Vernon, M. Vucetic, J. Wagoner, and Z. Yang (2003). "Estimating site-specific strong earthquake motions," *Soil Dynamics and Earthquake Engineering*, 24 (3), 199-223.

Whang, D.H., J.P. Stewart, and J.D. Bray (2004). "Effect of compaction conditions on the seismic compression of compacted fill soils," *Geotechnical Testing Journal, ASTM*, 27 (4), 371-379.

Seed, H.B., R.T. Wong, I.M. Idriss, and K. Tokimatsu (1986). "Moduli and damping factors for dynamic analysis of cohesionless soils," *Journal of Geotechnical Engineering*, 112 (11), 1016-1032.

For Reference Only

SVRT LABORATORY TESTS

September – October 2007

Consolidation and Atterberg Limits:

- **BH-89 at 20 ft**
- **BH-101 at 35 ft**
- **BH-85 at 50 ft**
- **BH-87 at 106 ft**
- **BH-90 at 110 ft**

For Reference Only

SVRT 05-108-C
BH-89 @ 20'

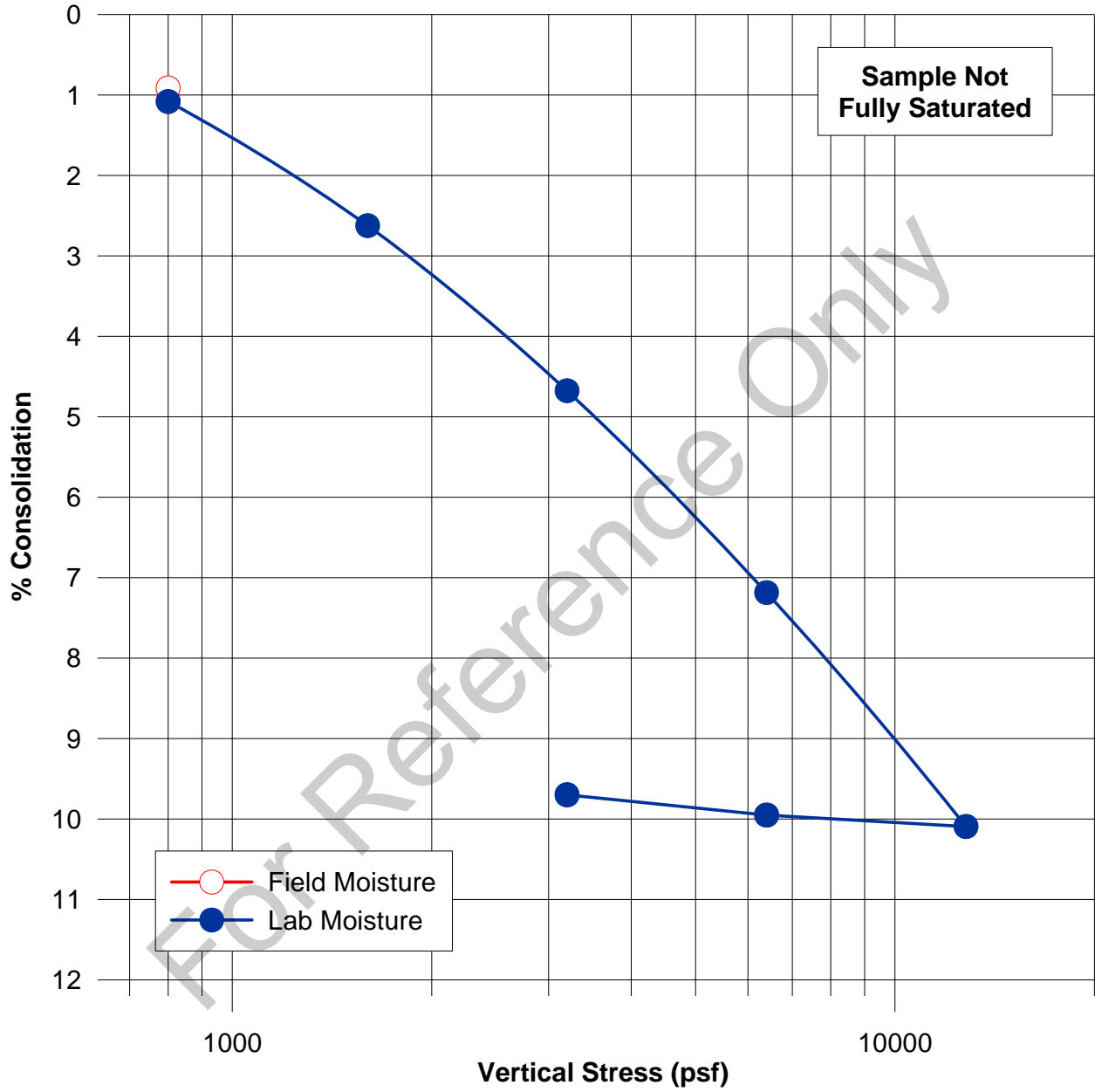

SVRT 05-108-C
BH-89 @ 20'

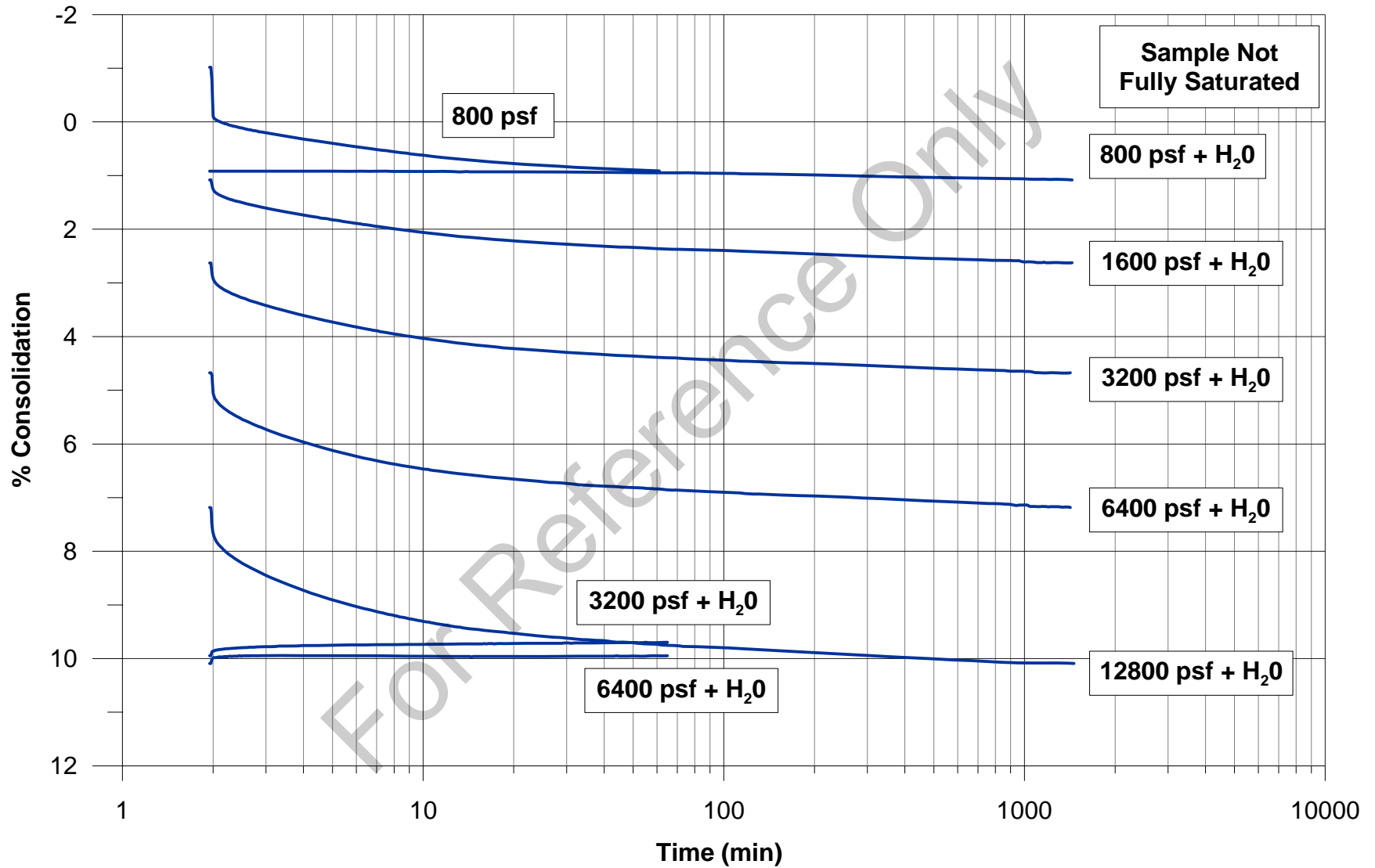

SVRT 05-108-C
BH-101 @ 35'

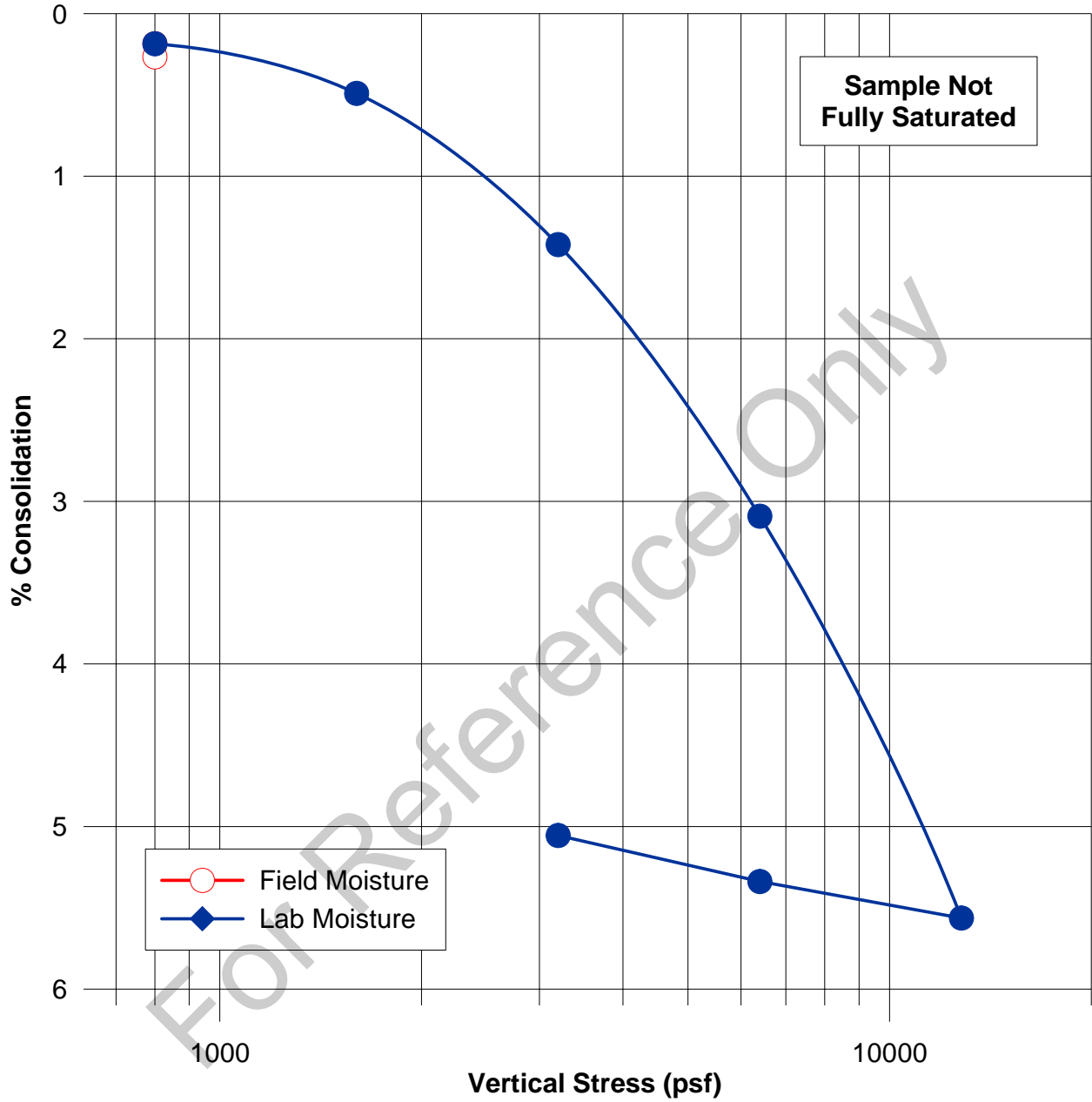

SVRT 05-108-C
BH-101 @ 35'

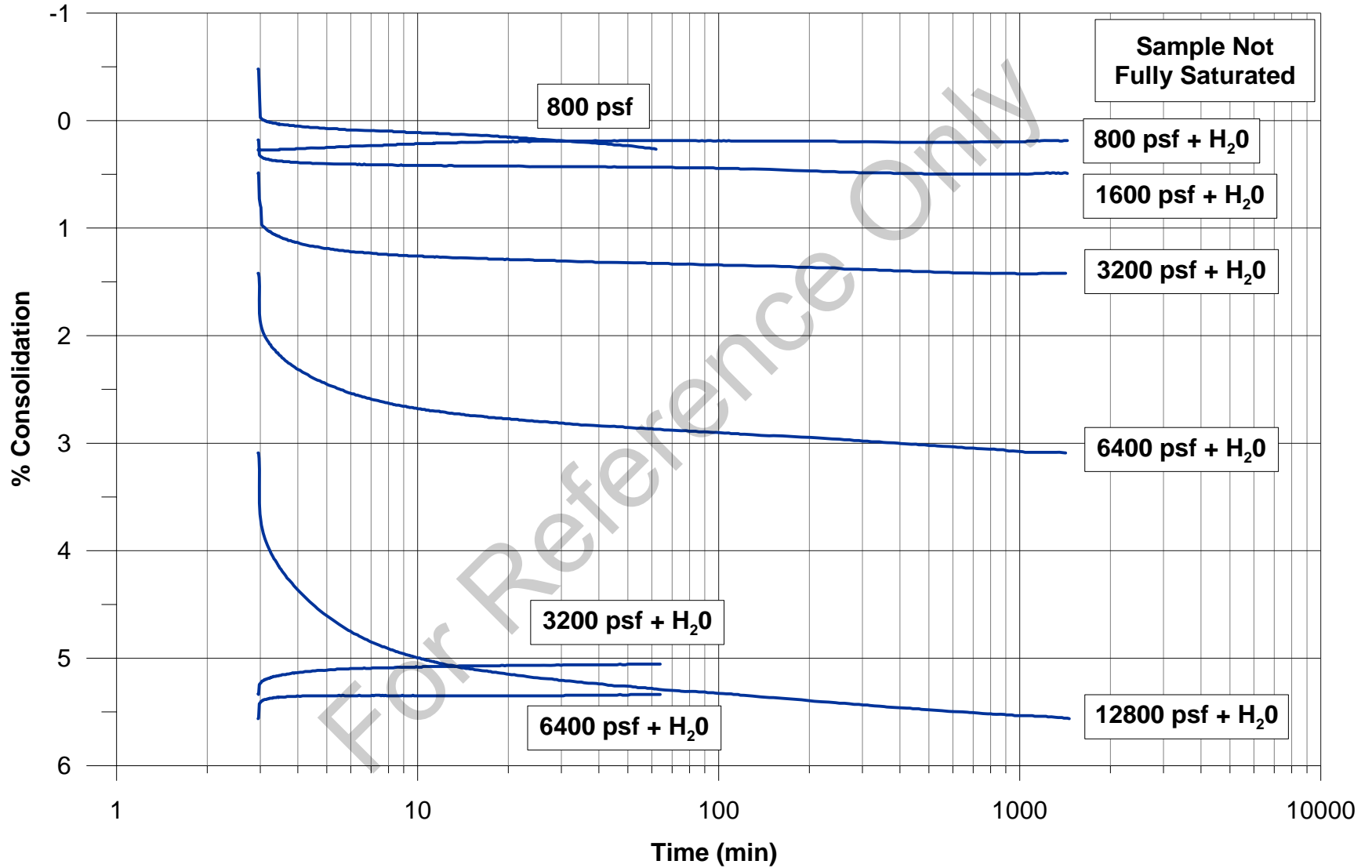

SVRT 05-108-C
BH-85 @ 50' - Test 1

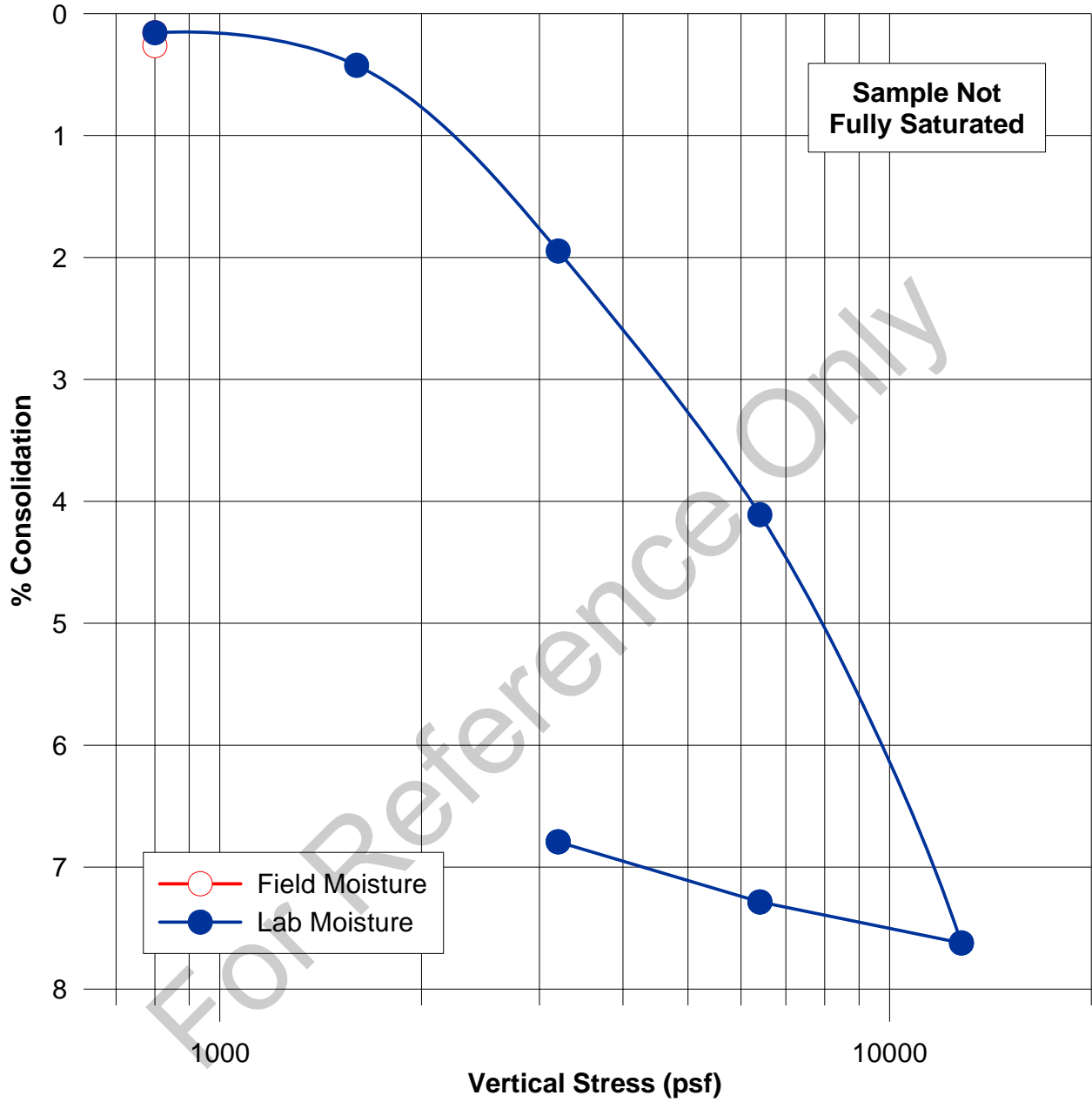

Note: Carbon stained pores observed in sample

SVRT 05-108-C
BH-85 @ 50' Test 1

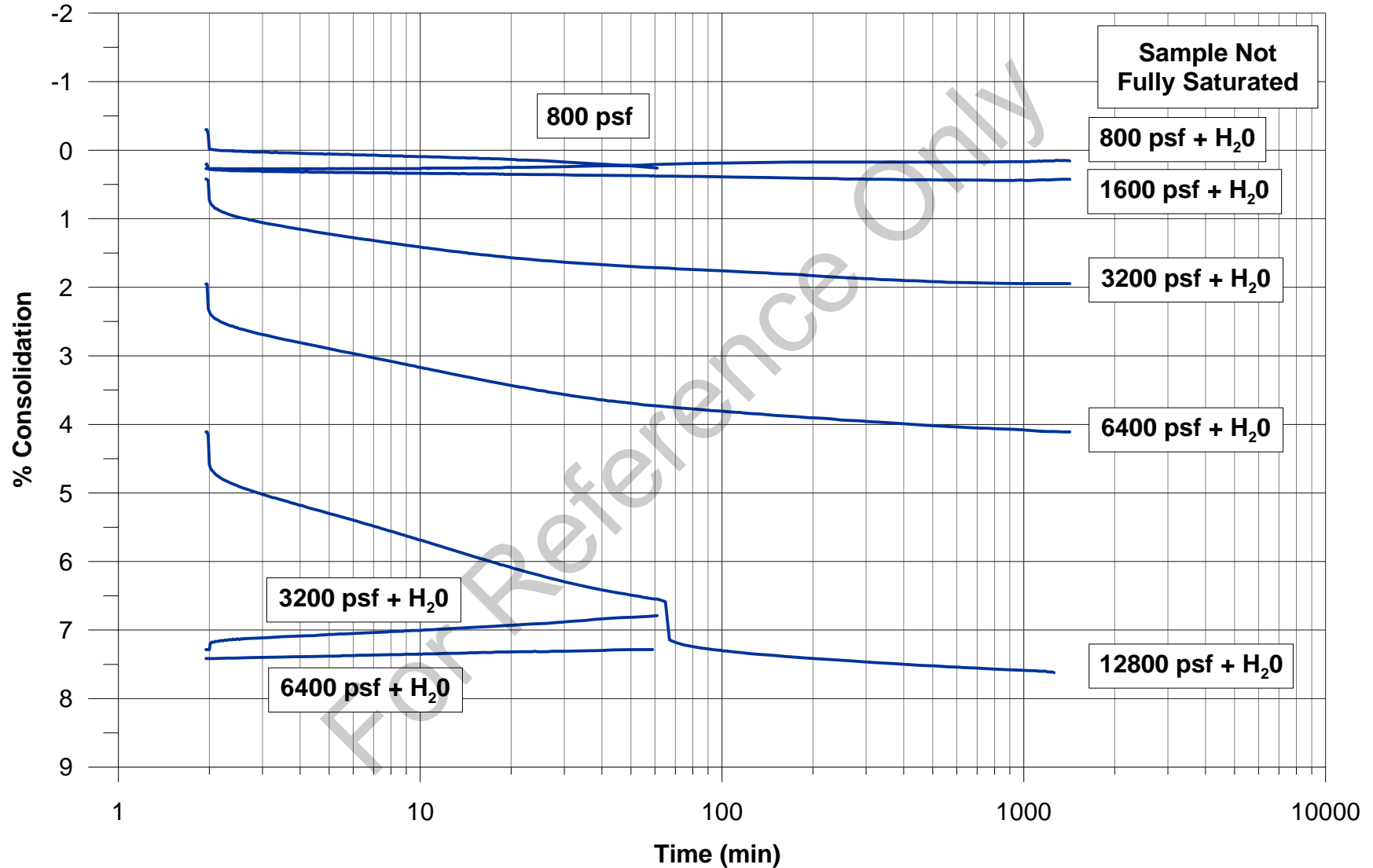

Note: Carbon stained pores observed in sample

SVRT 05-108-C
BH-85 @ 50' - Test 2

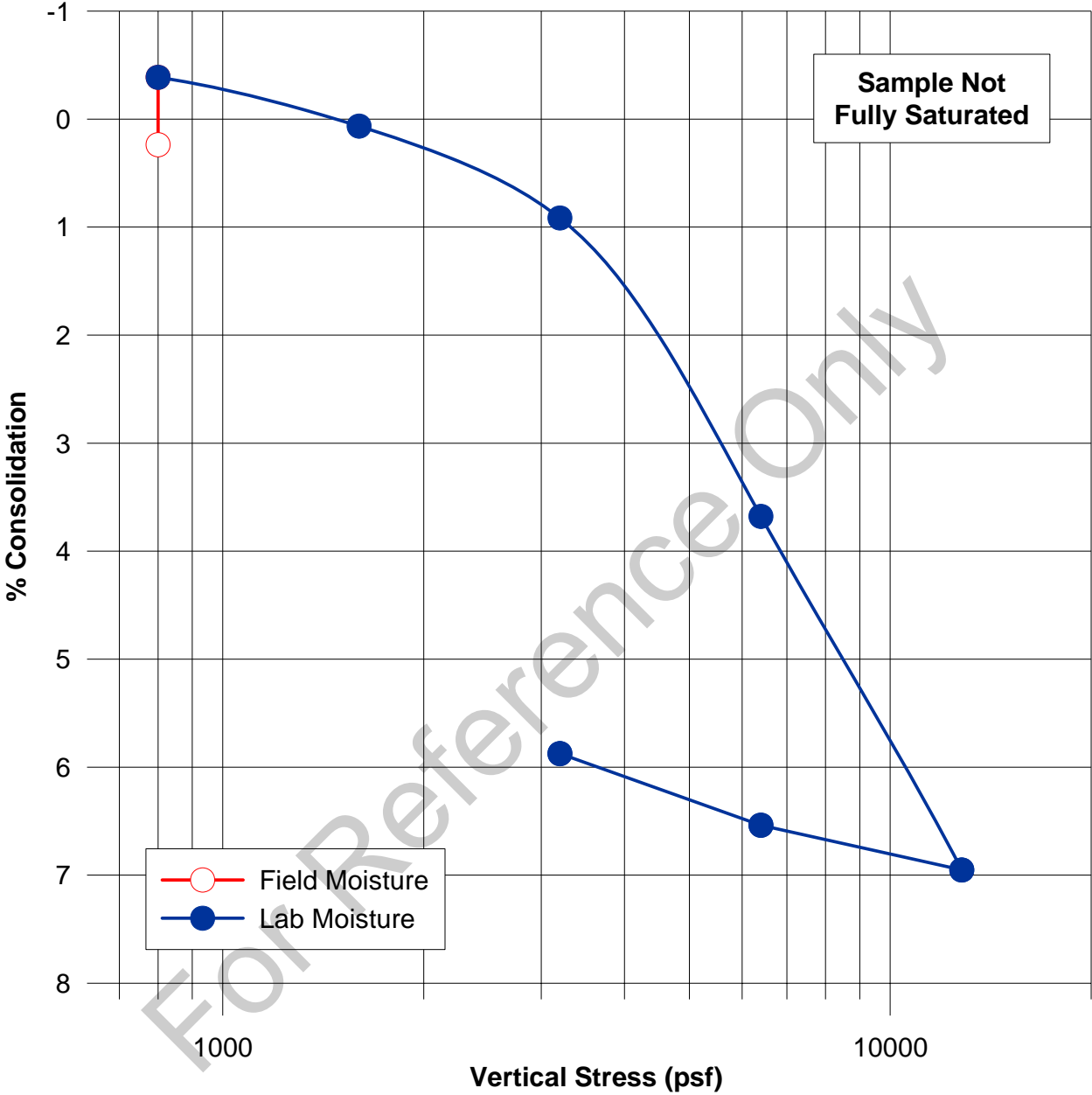

Note: Carbon stained pores observed in sample

SVRT 05-108-C
BH-85 @ 50' Test 2

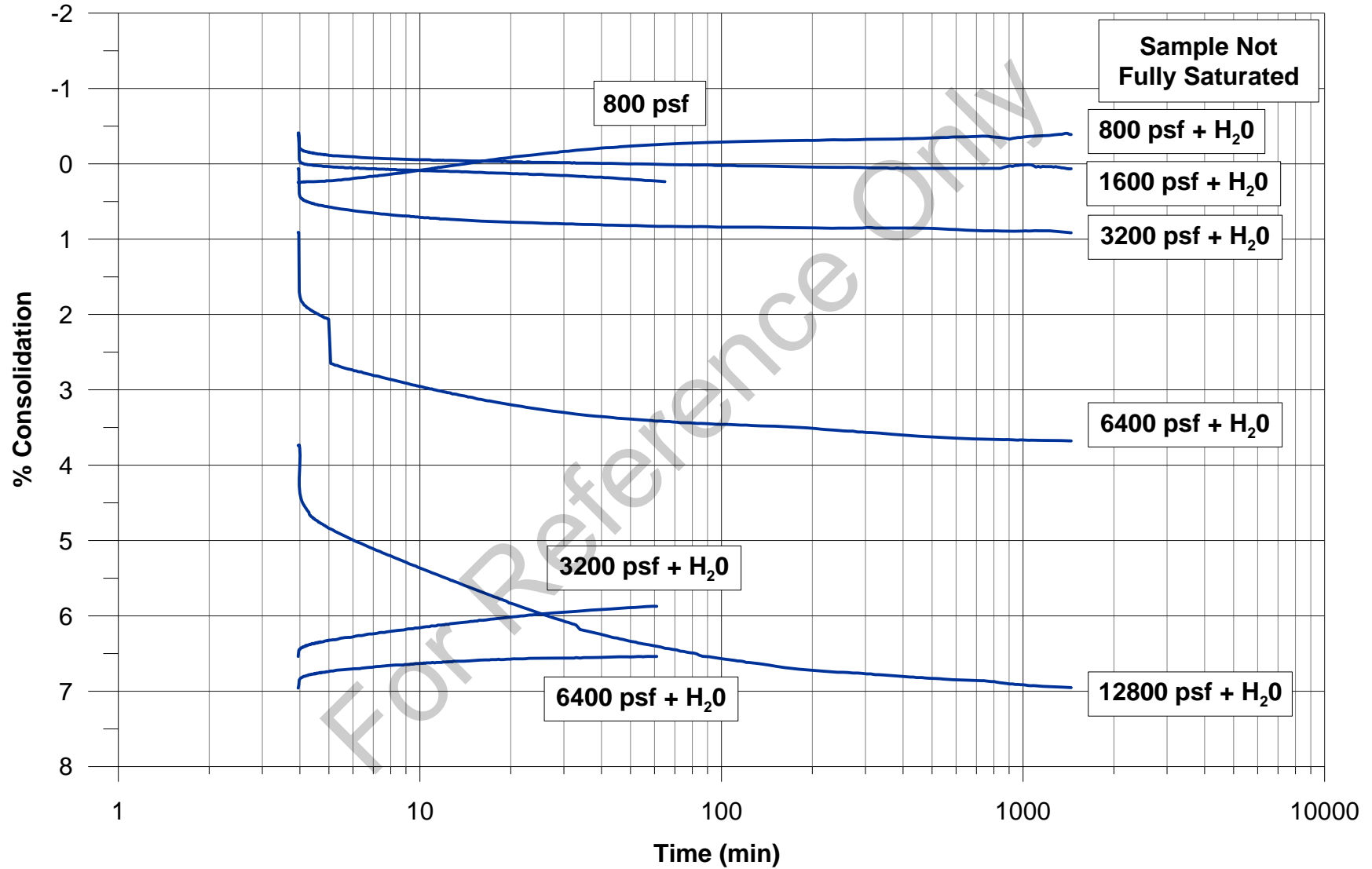

Note: Carbon stained pores observed in sample

SVRT 05-108-C
BH-87 @ 106'

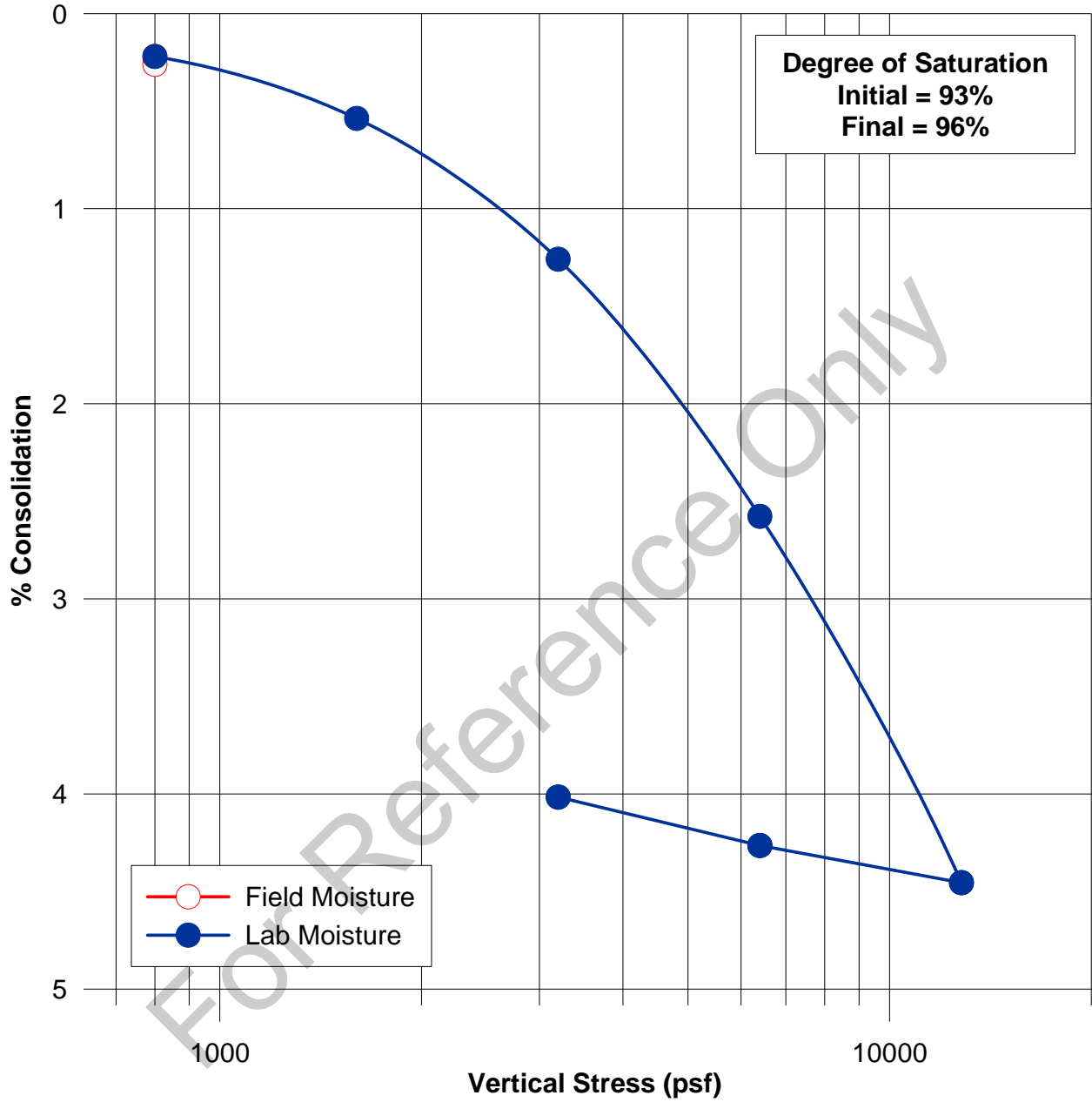

SVRT 05-108-C
BH-87 @ 106'

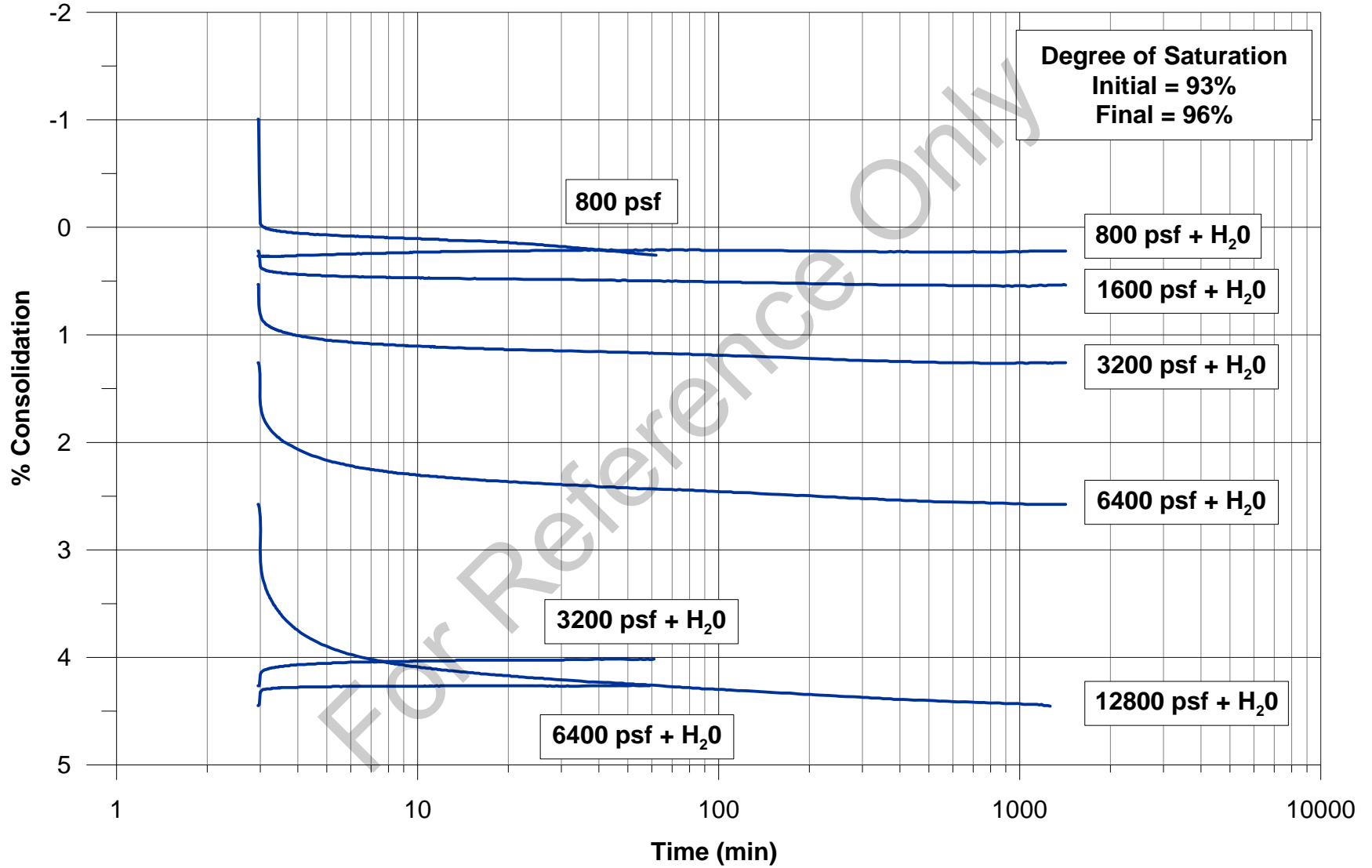

SVRT 05-108-C
BH-90 @ 110'

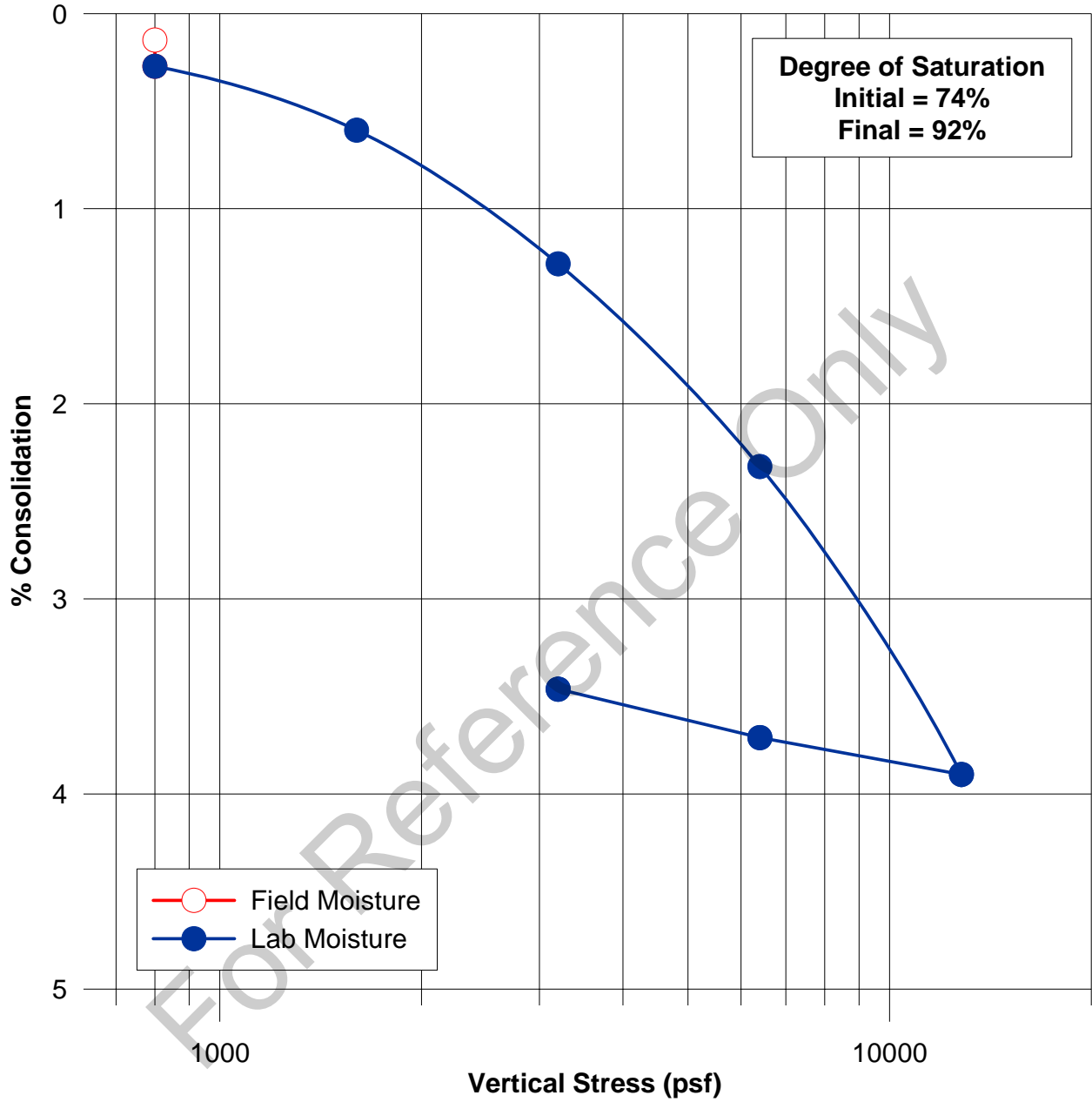

SVRT 05-108-C
BH-90 @ 110'

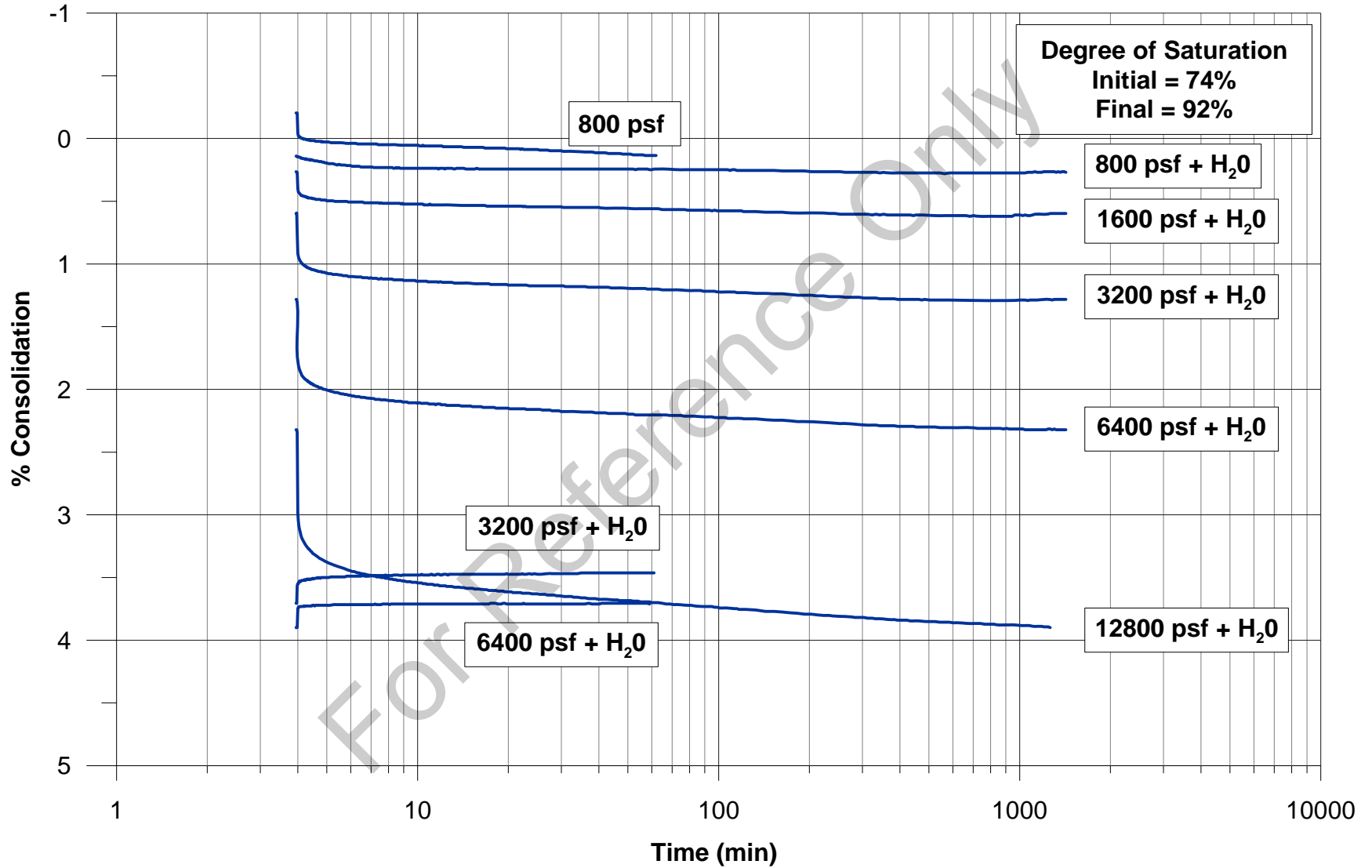

SVRT 05-108-C

Maximum Past Pressure, σ'_p , Summary

Sample	σ'_p , psf
BH-89 @ 20 ft	-
BH-101 @ 35 ft	~ 3,700
BH-85 @ 50 ft (1)	~ 3,200
BH-85 @ 50 ft (2)	~ 3,800
BH-87 @ 106 ft	-
BH-90 @ 110 ft	-

Atterberg Limit Summary

Sample	PRAAD			Parikh Lab
	Liquid Limit, LL	Plastic Limit, PL	Plastic Index, PI	Plastic Index, PI
BH-89 @ 20 ft	29	19	10	16
BH-101 @ 35 ft	29	20	9	12
BH-85 @ 50 ft	49	24	25	24
BH-87 @ 106 ft	36	25	11	-
BH-90 @ 110 ft	28	22	6	-

For Reference Only

Appendix 10: Dissolved Gas Sampling and Analysis Report

For Reference Only

For Reference Only

16 September 2008

Mr. Thomas Hunt
SVRT Project
3103 North First Street
Hynix Building B, 2nd Floor
San Jose CA 95134-1927

RE: *Report on Dissolved Gas Sampling and Analysis*
Locus Project No. 28006-0012

Dear Mr. Hunt:

Locus Technologies (Locus) recently completed sampling and analysis of 30 groundwater wells as requested by the HMM/Bechtel Silicon Valley Rapid Transit Project (SVRT) under Subcontract 24965-AE-029. This report documents the sampling and analyses, including field observations, laboratory results, and review of quality control information.

Summary of Sampling Activities

Locus collected groundwater samples from 12 Phase 1 groundwater wells specified by SVRT on 21-22 May 2008. Field activity logs, water sampling logs, and chain of custody records for this event are included in Attachment A. Field quality control samples collected during this round included a duplicate (sample ID 4767 collected from well MW-2F), a rinseate blank (sample ID 4769 collected after sampling TW-6A), and two travel blanks (sample IDs 4768 and "Trip B1"). Samples collected during this event were shipped to Bioremediation Consulting Inc (BCI) in Watertown, MA and Gusmer Enterprises, Inc (Gusmer) in Napa, CA.

On 22-23 July 2008, Locus collected groundwater samples from 18 Phase 2 groundwater wells specified by SVRT. Field activity logs, water sampling logs, and chain of custody records for this event are included in Attachment B. Field quality control samples collected during this round included two duplicates (sample ID 4783 collected from well MW-2G and sample ID 4785 collected from well MW-6D), two rinseate blanks (sample ID 4784 collected after sampling MW-3C and sample ID 4786 collected after sampling ST-11), and a travel blank (sample ID "Trip B1"). Samples collected during this event were shipped to BCI in Watertown, MA.

All samples were collected using low-flow purge methods in accordance with EPA Ground-Water Sampling Guidelines for Superfund and RCRA Project Managers (2002). As required for the sample analysis, all samples were collected in bottles with zero headspace. Small bubbles were noted in some sample bottles prior to shipping, but these bubbles are attributed to dissolved gas accumulation.

Laboratory Analysis

Phase 1 groundwater samples were analyzed for methane, ethane, ethanethiol, argon, nitrogen, carbon monoxide, carbon dioxide, ammonia-nitrogen, sulfide, oxygen, hydrogen, and hydrogen sulfide. The complete analytical reports from BCI and Gusmer are presented in Attachment C.

After review of the Phase 1 results, Phase 2 samples were analyzed for a limited list of dissolved gases including methane, nitrogen, carbon dioxide, and sulfide. The complete analytical reports from BCI are presented in Attachment D.

Quality Control Review

The duplicate samples for Phase 1 showed acceptable replicability, with the only significant percent differences occurring near the reporting limit for ethane (0.2 $\mu\text{g/L}$ in MW-2F and 0.3 $\mu\text{g/L}$ in 4767) and ammonia (<0.02 mg/L in MW-2F and 0.03 mg/L in 4767). Duplicate analyses were also performed in the laboratory on samples MW-3Dr and TW-2B. These duplicates also showed similar results. Some blank samples collected during Phase 1 showed low detections of methane, nitrogen, and carbon dioxide. However, the concentrations of these gases in the blank samples were much lower than those detected in the well samples. Therefore, these detections do not have any impact on the results. Hydrogen and oxygen were also detected in the blank samples. However, since both of these gases are inherent in every water sample, these results do not invalidate any of the sample results.

For the Phase 2 samples, the two duplicate pairs showed similar results for all analytes except sulfide, which had 57 percent difference in the MW-2G duplicate and 70 percent difference in the MW-6D duplicate. Laboratory duplicate analyses performed on samples MW-4A and ST-8 showed similar results, but these samples were not analyzed for sulfide. Concentrations of methane and nitrogen were detected in the rinseate blanks and travel blanks. Most methane concentrations in the groundwater samples were higher than the concentrations in the blanks, indicating no significant quality control issue. However, nitrogen results in the groundwater samples were similar to concentrations found in the blank samples, which indicates that the nitrogen results should be considered with data qualifiers. A low carbon dioxide concentration was also detected in one of the blanks, but at a much lower concentration than detected in any of the groundwater samples. Sulfide was not detected in any of the blank samples.

Should you have questions, please do not hesitate to call.

Sincerely,



J. Wesley Hawthorne, P.E., P.G.
Senior Project Manager

JWH/mmm

WELLS SELECTED FOR DISSOLVED GAS SAMPLING

Well Number	Well Screen (ft bgs)		Hydrogeologic Unit	Well Casing Diameter (inches)	Gas Sampling Priority = 1	Gas Sampling Priority = 2
	Top	Bottom				
East Portal to Alum Rock Station						
ST-1	67.5	72.5	Upper Aquifer ?	4		2
Alum Rock Station						
TW-2B	108	128		10		
MW-2C	98	108		2		2
MW-2E	110	120		2		
MW-2F	115	125		2		
MW-2G	63	73		2		2
ST-2	77.5	87.5	Upper Aquifer	4		2
ST-3	59.5	79.5	Upper Aquifer	4		
NW-01	70	80	Upper Aquifer	6		2
Alum Rock Station to Crossover						
MW-3C	68	78		2		2
MW-3D(r)	60	70		2		
ST-5	55	65	Upper Aquifer	4		
MW-1	64	74	Upper Aquifer	2		2
Crossover & Downtown San Jose Station						
TW-5A	78	93		10		
MW-4A	80	90		2		2
MW-5A	115	125		2		
MW-5B	73	97		2		2
ST-7	67.5	72.5	Upper Aquifer	4		2
ST-8	76.25	86.25	Upper Aquifer	4		2
Downtown San Jose Station to Diridon/Arena Station						
NW-05	80	90	Upper Aquifer	6		2
Diridon/Arena Station						
TW-6A	72	87		10		
TW-6B	106	116		10		
MW-6D	76	86		2		2
MW-6J	103	113		2		
ST-10	68	73	Upper Aquifer	4		2
ST-11	79.5	84.5	Upper Aquifer	4		2
NW-06	90	100	Upper Aquifer	6		2
Diridon/Arena Station to West Portal						
ST-12	64.5	69	Upper Aquifer	4		2
West Portal						
TW-8A	55	75		10		
ST-13	21	31	Channel in Confining Layer	4		2
Total				51	12	18

Gas sampling priority:

- 1 - Gas detected during drilling/sampling/pumping/slug testing at this location and depth. Require sampling.
- 2 - Gas not previously detected, but well screen is similar to tunnelling depth (e.g., 60 to 100 ft bgs). Recommend sampling.

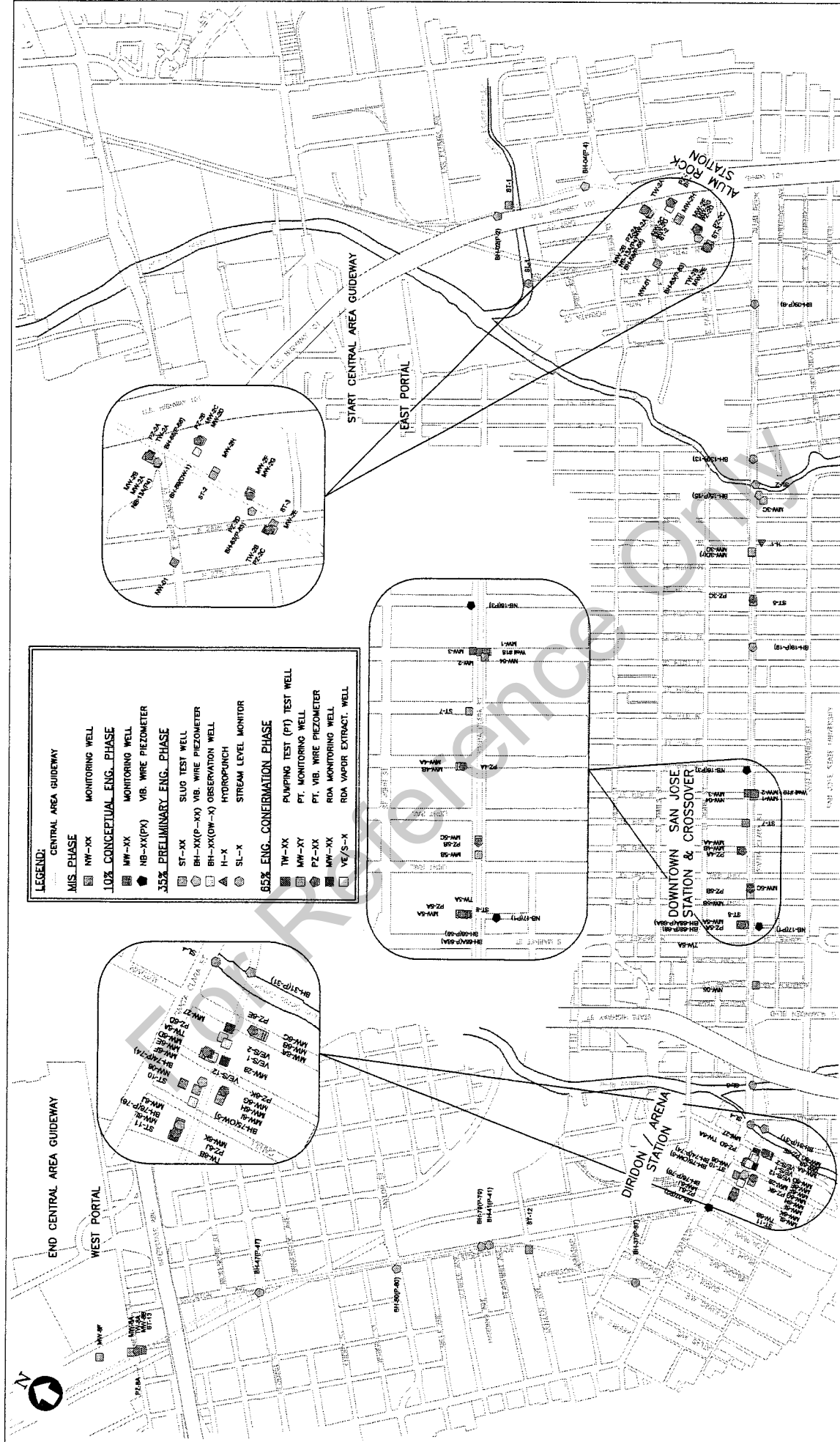

LEGEND:

CENTRAL AREA GUIDEWAY
 MIS PHASE
 MW-XX MONITORING WELL

10% CONCEPTUAL ENG. PHASE
 MW-XX MONITORING WELL
 NB-XX(PX) VB. WIRE PIEZOMETER

35% PRELIMINARY ENG. PHASE
 ST-XX SLUG TEST WELL
 BH-XX(P-XX) VB. WIRE PIEZOMETER
 BH-XX(OV-X) OBSERVATION WELL
 H-X HYDROPUNCH
 SL-X STREAM LEVEL MONITOR

65% ENG. CONSTRUCTION PHASE
 TW-XX PUMPING TEST (PT) TEST WELL
 MH-XY PT. MONITORING WELL
 PZ-XX PT. VB. WIRE PIEZOMETER
 MW-XX RDA MONITORING WELL
 VE/S-X RDA VAPOR EXTRACT. WELL

		CADW RELEASE D:\DD-S-TR-C013-A.dwg DATE SCALE 1"=500' CONTRACT NO. D CONTRACT NO. D.300 AREA CODE SHEET NO. TR PAGE NO. C013	
		SILICON VALLEY RAPID TRANSIT PROJECT CENTRAL AREA GUIDEWAY HYDROGEOLOGY REPORT WELL AND PIEZOMETER LOCATION MAP FIGURE 4-1	
A Joint Venture of Hatch Mott MacDonald T&T, Inc. and Bechtel Infrastructure Corp.		APPROVED	
SUBMITTED		DATE	
IN PROGRESS		DATE	
IN PROGRESS		DATE	

ATTACHMENT A

Field Log, Water Sampling Log, and Chain of Custody Forms

Phase I Sampling

For Reference Only

WELL SAMPLING SUMMARY
PHASE 1 GROUNDWATER SAMPLING

Well	Sample Date	Sample Time	Purge Duration (min)	Purge Volume (gal)	Temperature (°C)	pH	Dissolved Oxygen (mg/L)	Dissolved Oxygen (% saturation)	Oxidation-Reduction Potential	Conductivity (µS)
TW-6B	21-May	7:20	10	1	17.6	7.04	4.98	52.2	386.9	721
MW-6J	21-May	8:35	25	2.5	18.7	6.96	4.45	47.6	393.2	698
ST-3	21-May	9:40	20	2	19.9	7.04	4.01	47.2	381.1	1160
MW-3Dr	21-May	10:50	15	1.5	24.8	7.25	2.98	34.4	358.9	1010
ST-5	21-May	12:05	15	1.5	24.6	7.21	2.62	30.2	358.9	1060
TW-6A	21-May	13:10	20	2	25.5	6.61	1.37	17.2	244.7	792
MW-2F	21-May	14:20	25	2.5	23.4	7.23	2.92	34.4	171.2	1407
TW-2B	21-May	15:15	20	2	21.1	7.39	2.58	30.2	52.3	1337
MW-2E	21-May	15:55	15	1.5	21.3	7.37	2.8	29.4	130.7	1397
TW-5A	22-May	8:45	25	2.5	18.5	7.11	1.81	19.7	172.2	1042
MW-5A	22-May	9:50	25	2.5	19.2	7.50	1.74	20.6	65.3	546
TW-8A	22-May	10:40	20	2	20.9	7.17	1.97	20.8	66.2	714



DAILY FIELD ACTIVITY LOG

Project Name: Santa Clara VTA
 Field Activity: Well Sampling
 Weather: clear/sunny

Project No.: 28006-08-0001
 Date: 5-21-08
 Logged by: H. Castro Jr.
 Page: 1 of 2

TIME	DAILY ACTIVITIES AND EVENTS
0600	Prepped & loaded truck for low flow sampling.
0700	Arrived onsite at TW-6B. Set up equipment for purge. Met with Tom Hunt from VTA.
0725	Sampled TW-6B.
0800	AT MW-6J, Set up equipment for low flow purge.
0840	Sampled MW-6J.
0900	AT ST-3. Met with officer Bryan & Traffic control Inc. for traffic control. Set up equipment for low flow purge.
0945	Sampled ST-3.
1005	AT MW-3D(r). Set up traffic control.
1025	Set up equipment for low flow purge.
1055	Sampled MW-3D(r).
1120	AT ST-5. Set up traffic control.
1140	Set up equipment for low flow purge.
1210	Sampled ST-5. Traffic control Inc. & Officer Bryan left site.

Comments/Remarks:

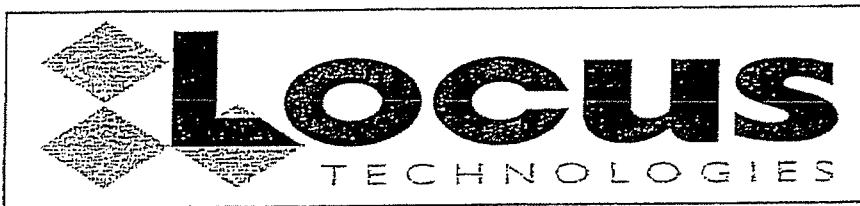

DAILY FIELD ACTIVITY LOG

Project Name: Santa Clara VTA
 Field Activity: Well Sampling
 Weather: Clear/Scuffy

Project No.: 28006-08-0001
 Date: 5-21-08
 Logged by: H. Castro Jr.
 Page: 2 of 2

TIME	DAILY ACTIVITIES AND EVENTS
1240	AT TW-6A, Set up equipment for low flow purge.
1315	Sampled TW-6A. (RB TAKEN 4769)
1345	AT MW-2F, Set up equipment for low flow purge.
1425	Sampled MW-2F. (DUP TAKEN 4767)
1445	AT TW-2B, Set up equipment for low flow purge.
1520	Sampled TW-2B.
1530	AT MW-2E, Set up equipment for low flow purge.
1600	Sampled MW-2E.
5/22/08	
0800	Arrived onsite, AT TW-5A. Set up equipment for purge.
0850	Sampled TW-5A.
0915	AT MW-5A, Set up equipment for purge.
0955	Sampled MW-5A.
1010	AT TW-8A, Set up equipment for purge.
1045	Sampled TW-8A.
1120	Left purge water onsite just SE of TW-8A w/ pending analysis lab.
1135	Left site for office.
Comments/Remarks:	

LOCUS TECHNOLOGIES WATER SAMPLING LOG

WELL/SAMPLE DESIGNATION TW-6B SITE: S.C. VTA
 SAMPLE SOURCE A DATE: 5-21-08
 AMBIENT CONDITIONS Clear & Sunny PROJECT# 28006-08-0001
 SAMPLER H.CASTRO/ T.Murphy

GRAB SAMPLE INFORMATION (Use notes section for meter reading, flow rate, vol. purged, etc.)

GRAB SAMPLE METHOD: CONTINUOUS PUMPER YES NO pH Meter: FLOW RATE:
 PUMP CYCLING YES NO METER READING:

WATER LEVEL INFORMATION MEASURING POINT TOC INSTRUMENT USED SJ-1

W/L BEFORE PURGE: TIME _____ W/L AFTER PURGE: TIME _____
 W/L FOR 80% RECOVERY: _____ W/L TIME OF SAMPLE: _____ DATE: _____ TIME: _____

MONITORING WELL PURGE INFORMATION MONITORING WELL PURGE METHOD E

PURGE DEVICE I.D. Low flow pump
 WELL DEPTH 116' DIAMETER 10" #CASING VOLUMES (PROTOCOL) _____
 SCREENED INTERVAL _____ PUMP SETTING _____
 PURGE VOLUME CALCULATION _____
 TIME PURGE BEGINS _____ ACTUAL AMOUNT PURGED _____ pH INSTRUMENT Low flow cell

TIME	TEMP.	COND.	pH	PURGE WATER APPEARANCE/ODOR	ORP	DO
720	17.6°	721	7.04	Slightly brown / no odor	386.9	52.290 4.98mg/L

WATER SAMPLING INFORMATION MONITORING WELL SAMPLE METHOD D

SAMPLING DEVICE ID Tubing SAMPLING TIME 725 APPROXIMATE DEPTH OF GRAB N/A
 DATE 5-21-08
 BOTTLE TYPE NO. VOLUME ANALYSIS LAB PRESERVATION FILTRATION

(See bottle list)

DECONTAMINATION INFORMATION

PURGE DEVICE ID: _____ HOSE REEL: _____ SAMPLING DEVICE ID: _____
 PREVIOUSLY USED IN WELL: _____ PREVIOUSLY USED IN WELL: _____
 SITE: _____ SITE: _____
 DECON METHOD/STEAM TIME: _____ DECON METHOD/STEAM TIME: _____
 RINSEATE SAMPLE: YES NO ID: _____ RINSEATE SAMPLE: YES NO ID: _____

QA/QC INFORMATION

IN SAMPLE SHIPMENT: TRAVEL BLANK YES NO ID 4768 QA/QC SPIKE YES NO ID _____
 DUPLICATE YES NO ID _____ FIELD BLANK YES NO ID _____ INTER-LAB SPLIT YES NO ID _____

NOTES

LOCUS TECHNOLOGIES WATER SAMPLING LOG

WELL/SAMPLE DESIGNATION MW-6J SITE: S.C. VTA
 SAMPLE SOURCE A DATE: 5-21-08
 AMBIENT CONDITIONS Clear & Sunny PROJECT#: 28006-08-0001
 SAMPLER H.CASTRO/ T.Murphy

GRAB SAMPLE INFORMATION (use notes section for meter reading, flow rate, vol. purged, etc.)

GRAB SAMPLE METHOD: CONTINUOUS PUMPER YES NO pH meter: _____ FLOW RATE: _____
PUMP CYCLING YES NO METER READING: _____

WATER LEVEL INFORMATION **MEASURING POINT** TOC **INSTRUMENT USED** SJ-1

W.L. BEFORE PURGE _____ TIME _____ W.L. AFTER PURGE _____ TIME _____
 W.L. FOR 80% RECOVERY _____ W.L. TIME OF SAMPLE _____ DATE _____ TIME _____

MONITORING WELL PURGE INFORMATION **MONITORING WELL PURGE METHOD** E

PURGE DEVICE I.D. Low flow pump
 WELL DEPTH 113' DIAMETER 2" #CASING VOLUMES (PROTOCOL) _____
 SCREENED INTERVAL _____ PUMP SETTING _____
 PURGE VOLUME CALCULATION _____
 TIME PURGE BEGINS _____ ACTUAL AMOUNT PURGED _____ pH INSTRUMENT Low flow cell

TIME	TEMP.	COND.	pH	PURGE WATER APPEARANCE/ODOR	ORP	DO
<u>8:55</u>	<u>18.7°</u>	<u>698</u>	<u>6.96</u>	<u>brown/woodor</u>	<u>393.2</u>	<u>47.6%</u> <u>4.45mg/L</u>

WATER SAMPLING INFORMATION **MONITORING WELL SAMPLE METHOD** D

SAMPLING DEVICE ID Tubing SAMPLING TIME 840 APPROXIMATE DEPTH OF GRAB N/A
 DATE 5-21-08
 BOTTLE TYPE NO. VOLUME ANALYSIS LAB PRESERVATION FILTRATION

(SEE BOTTLE LIST)

DECONTAMINATION INFORMATION

PURGE DEVICE ID: _____ HOSE REEL: _____ SAMPLING DEVICE ID: _____
 PREVIOUSLY USED IN WELL: _____ PREVIOUSLY USED IN WELL: _____
 SITE: _____ SITE: _____
 DECON METHOD/STEAM TIME: _____ DECON METHOD/STEAM TIME: _____
 RINSEATE SAMPLE: YES NO ID: _____ RINSEATE SAMPLE: YES NO ID: _____

QA/QC INFORMATION

IN SAMPLE SHIPMENT: TRAVEL BLANK YES NO ID 4768 QA/QC SPIKE YES NO ID _____
 DUPLICATE YES NO ID _____ FIELD BLANK YES NO ID _____ INTER-LAB SPLIT YES NO ID _____

NOTES

LOCUS TECHNOLOGIES WATER SAMPLING LOG

WELL/SAMPLE DESIGNATION ST-3 SITE: S.C. VTA
 SAMPLE SOURCE A DATE: 5-21-08
 AMBIENT CONDITIONS Clear & Sunny PROJECT#: 28006-08-0001
 SAMPLER H.CASTRO/ T.Murphy

GRAB SAMPLE INFORMATION (use notes section for meter reading, flow rate, vol purged, etc.)

GRAB SAMPLE METHOD: CONTINUOUS PUMPER YES NO pH meter: _____ FLOW RATE: _____
 PUMP CYCLING YES NO METER READING: _____

WATER LEVEL INFORMATION MEASURING POINT TOG INSTRUMENT USED: SJ-1

W/L BEFORE PURGE TIME: _____ W/L AFTER PURGE TIME: _____
 W/L FOR 80% RECOVERY: _____ W/L TIME OF SAMPLE DATE: _____ TIME: _____

MONITORING WELL PURGE INFORMATION MONITORING WELL PURGE METHOD E

PURGE DEVICE I.D. Low flow pump
 WELL DEPTH 79.5' DIAMETER 4" #CASING VOLUMES (PROTOCOL) _____
 SCREENED INTERVAL _____ PUMP SETTING _____
 PURGE VOLUME CALCULATION _____
 TIME PURGE BEGINS _____ ACTUAL AMOUNT PURGED _____ pH INSTRUMENT Low flow cell

TIME	TEMP.	COND.	pH	PURGE WATER APPEARANCE/ODOR	ORP	DO
940	19.9°	1160	7.04	clear/no odor	381.1	47.29% 4.01mg/L

WATER SAMPLING INFORMATION MONITORING WELL SAMPLE METHOD D

SAMPLING DEVICE ID Tubing SAMPLING TIME 945 APPROXIMATE DEPTH OF GRAB N/A
 DATE 5-21-08
 BOTTLE TYPE NO. VOLUME ANALYSIS LAB PRESERVATION FILTRATION

(See Bottle List)

DECONTAMINATION INFORMATION

PURGE DEVICE ID: _____ HOSE REEL: _____ SAMPLING DEVICE ID: _____
 PREVIOUSLY USED IN WELL: _____ PREVIOUSLY USED IN WELL: _____
 SITE: _____ SITE: _____
 DECON METHOD/STEAM TIME: _____ DECON METHOD/STEAM TIME: _____
 RINSEATE SAMPLE: YES NO ID: _____ RINSEATE SAMPLE: YES NO ID: _____

QA/QC INFORMATION

IN SAMPLE SHIPMENT: TRAVEL BLANK YES NO ID 4768 QA/QC SPIKE YES NO ID _____
 DUPLICATE YES NO ID _____ FIELD BLANK YES NO ID _____ INTER-LAB SPLIT YES NO ID _____

NOTES

LOCUS TECHNOLOGIES WATER SAMPLING LOG

WELL SAMPLE DESIGNATION MW-3D(r) SITE: S.C. VTA
 SAMPLE SOURCE A DATE: 5-21-08
 AMBIENT CONDITIONS Clear & Sunny PROJECT#: 2B006-08-0001
 SAMPLER H.CASTRO/ T.Murphy

GRAB SAMPLE INFORMATION (use notes section for meter reading, flow rate, vol. purged, etc.)

GRAB SAMPLE: CONTINUOUS PUMPER YES NO pH meter: FLOW RATE:
 METHOD: PUMP CYCLING YES NO METER READING:

WATER LEVEL INFORMATION MEASURING POINT: TOC INSTRUMENT USED: SJ-1

W/L BEFORE PURGE: TIME: W/L AFTER PURGE: TIME:
 W/L FOR 80% RECOVERY: W/L TIME OF SAMPLE: DATE: TIME:

MONITORING WELL PURGE INFORMATION MONITORING WELL PURGE METHOD: E

PURGE DEVICE I.D. Low flow pump
 WELL DEPTH 70' DIAMETER 2" #CASING VOLUMES (PROTOCOL)
 SCREENED INTERVAL PUMP SETTING
 PURGE VOLUME CALCULATION
 TIME PURGE BEGINS ACTUAL AMOUNT PURGED pH INSTRUMENT Low flow cell

TIME	TEMP.	COND.	pH	PURGE WATER APPEARANCE/ODOR	ORP	DO
1050	24.8°c	1010	7.25	cloudy/ no odor	358.9	34.4% 2.98mg/L

WATER SAMPLING INFORMATION MONITORING WELL SAMPLE METHOD: D

SAMPLING DEVICE ID: Tubing SAMPLING TIME: 1055 APPROXIMATE DEPTH OF GRAB: N/A
 DATE: 5-21-08
 BOTTLE TYPE NO. VOLUME ANALYSIS LAB PRESERVATION FILTRATION

(See bottle list)

DECONTAMINATION INFORMATION

PURGE DEVICE ID: HOSE REEL: SAMPLING DEVICE ID:
 PREVIOUSLY USED IN WELL: PREVIOUSLY USED IN WELL:
 SITE: SITE:
 DECON METHOD/STEAM TIME: DECON METHOD/STEAM TIME:
 RINSEATE SAMPLES: YES NO ID: RINSEATE SAMPLES: YES NO ID:

QA/QC INFORMATION

IN SAMPLE SHIPMENT: TRAVEL BLANK X YES NO ID 4768 QA/QC SPIKE YES X NO ID
 DUPLICATE YES X NO ID FIELD BLANK YES X NO ID INTER-LAB SPLIT YES X NO ID

NOTES

LOCUS TECHNOLOGIES WATER SAMPLING LOG

WELL/SAMPLE DESIGNATION ST-5 SITE: S.C. VTA
 SAMPLE SOURCE A DATE: 5-21-08
 AMBIENT CONDITIONS Clear & Sunny PROJECT# 28006-08-0001
 SAMPLER H.CASTRO/T.Murphy

GRAB SAMPLE INFORMATION (use notes section for meter reading, flow rate, vol. purged, etc.)

GRAB SAMPLE METHOD: CONTINUOUS PUMPER YES NO pH meter: _____ FLOW RATE: _____
 PUMP CYCLING: YES NO METER READING: _____

WATER LEVEL INFORMATION MEASURING POINT: TOC INSTRUMENT USED: SJ-1

W.L. BEFORE PURGE: _____ TIME: _____ W.L. AFTER PURGE: _____ TIME: _____
 W.L. FOR 80% RECOVERY: _____ W.L. TIME OF SAMPLE: _____ DATE: _____ TIME: _____

MONITORING WELL PURGE INFORMATION MONITORING WELL PURGE METHOD: E

PURGE DEVICE I.D. Low flow pump
 WELL DEPTH 65' DIAMETER 4" #CASING VOLUMES (PROTOCOL) _____
 SCREENED INTERVAL _____ PUMP SETTING _____
 PURGE VOLUME CALCULATION _____
 TIME PURGE BEGINS _____ ACTUAL AMOUNT PURGED _____ pH INSTRUMENT Low flow cell

TIME	TEMP.	COND.	pH	PURGE WATER APPEARANCE/ODOR	ORP	DO
1205	24.6°	1060	7.21	Clear/no odor	358.9	30.290 262mg/L

WATER SAMPLING INFORMATION MONITORING WELL SAMPLE METHOD: D

SAMPLING DEVICE ID: Tubing SAMPLING TIME: 1210 APPROXIMATE DEPTH OF GRAB: N/A
 DATE: 5-21-08
 BOTTLE TYPE NO. VOLUME ANALYSIS LAB PRESERVATION FILTRATION
(See bottle list)

DECONTAMINATION INFORMATION

PURGE DEVICE ID: _____ HOSE REEL: _____ SAMPLING DEVICE ID: _____
 PREVIOUSLY USED IN WELL: _____ PREVIOUSLY USED IN WELL: _____
 SITE: _____ SITE: _____
 DECON METHOD/STEAM TIME: _____ DECON METHOD/STEAM TIME: _____
 RINSEATE SAMPLE: YES NO ID: _____ RINSEATE SAMPLE: YES NO ID: _____

QA/QC INFORMATION

IN SAMPLE SHIPMENT: TRAVEL BLANK YES NO ID 4768 QA/QC SPIKE YES NO ID _____
 DUPLICATE YES NO ID _____ FIELD BLANK YES NO ID _____ INTER-LAB SPLIT YES NO ID _____

NOTES

LOCUS TECHNOLOGIES WATER SAMPLING LOG

WELL/SAMPLE DESIGNATION TW-6A SITE: S.C. VTA
 SAMPLE SOURCE A DATE: 5-21-08
 AMBIENT CONDITIONS Clear & Sunny PROJECT# 28006-08-0001
 SAMPLER H.CASTRO/ T.Murphy

GRAB SAMPLE INFORMATION (use notes section for meter reading, flow rate, vol. purged, etc.)

GRAB SAMPLE: CONTINUOUS PUMPER YES NO pH meter: FLOW RATE
 METHOD: PUMP CYCLING YES NO METER READING:

WATER LEVEL INFORMATION MEASURING POINT TOC INSTRUMENT USED SJ-1

W/L BEFORE PURGE: _____ TIME _____ W/L AFTER PURGE: _____ TIME _____
 W/L FOR 80% RECOVERY: _____ W/L TIME OF SAMPLE: _____ DATE: _____ TIME: _____

MONITORING WELL PURGE INFORMATION MONITORING WELL PURGE METHOD E

PURGE DEVICE I.D. Low flow pump
 WELL DEPTH 87' DIAMETER 10" #CASING VOLUMES (PROTOCOL) _____
 SCREENED INTERVAL _____ PUMP SETTING _____
 PURGE VOLUME CALCULATION _____
 TIME PURGE BEGINS _____ ACTUAL AMOUNT PURGED _____ pH INSTRUMENT Low flow cell

TIME	TEMP.	COND.	pH	PURGE WATER APPEARANCE/ODOR	ORP	DO
<u>1310</u>	<u>25.5c</u>	<u>792</u>	<u>6.61</u>	<u>silty brown/slight odor</u>	<u>244.7</u>	<u>17.29g</u> <u>1.37mg/L</u>

WATER SAMPLING INFORMATION MONITORING WELL SAMPLE METHOD D

SAMPLING DEVICE ID Tubing SAMPLING TIME 1315 APPROXIMATE DEPTH OF GRAB N/A
 DATE 5-21-08
 BOTTLE TYPE NO. VOLUME ANALYSIS LAB PRESERVATION FILTRATION

(See bottle list)

DECONTAMINATION INFORMATION

PURGE DEVICE ID: _____ HOSE REEL: _____ SAMPLING DEVICE ID: _____
 PREVIOUSLY USED IN WELL: _____ PREVIOUSLY USED IN WELL: _____
 SITE: _____ SITE: _____
 DECON METHOD/STEAM TIME: _____ DECON METHOD/STEAM TIME: _____
 RINSEATE SAMPLE: YES NO ID: _____ RINSEATE SAMPLE: YES NO ID: _____

QA/QC INFORMATION

IN SAMPLE SHIPMENT: TRAVEL BLANK YES NO ID 476B QA/QC SPIKE YES NO ID _____
 DUPLICATE YES NO ID — Rinse BLANK YES NO ID 476C INTER-LAB SPLIT YES NO ID _____

NOTES

(RB TAKEN)

LOCUS TECHNOLOGIES WATER SAMPLING LOG

WELL/SAMPLE DESIGNATION MW-2F SITE: S.C. VTA
 SAMPLE SOURCE A DATE: 5-21-08
 AMBIENT CONDITIONS Clear & Sunny PROJECT# 28006-08-0001
 SAMPLER H.CASTRO/ T.Murphy

GRAB SAMPLE INFORMATION (use notes section for meter reading, flow rate, vol. purged, etc.)

GRAB SAMPLE: _____ CONTINUOUS PUMPER: YES _____ NO _____ pH meter: _____ FLOW RATE: _____
 METHOD: _____ PUMP CYCLING: YES _____ NO _____ METER READING: _____

WATER LEVEL INFORMATION MEASURING POINT: TOC INSTRUMENT USED: SJ-1

W/L BEFORE PURGE: _____ TIME: _____ W/L AFTER PURGE: _____ TIME: _____
 W/L FOR 80% RECOVERY: _____ W/L TIME OF SAMPLE: _____ DATE: _____ TIME: _____

MONITORING WELL PURGE INFORMATION MONITORING WELL PURGE METHOD E

PURGE DEVICE I.D. Low flow pump
 WELL DEPTH 120' DIAMETER 2" #CASING VOLUMES (PROTOCOL) _____
 SCREENED INTERVAL _____ PUMP SETTING _____
 PURGE VOLUME CALCULATION _____
 TIME PURGE BEGINS _____ ACTUAL AMOUNT PURGED _____ pH INSTRUMENT Low flow cell

TIME	TEMP.	COND.	pH	PURGE WATER APPEARANCE/ODOR	ORP	DO
<u>1420</u>	<u>23.4°C</u>	<u>1407</u>	<u>7.23</u>	<u>clear/no odor</u>	<u>171.2</u>	<u>34.470</u> <u>292 mg/L</u>

WATER SAMPLING INFORMATION MONITORING WELL SAMPLE METHOD D

SAMPLING DEVICE ID Tubing SAMPLING TIME 1425 APPROXIMATE DEPTH OF GRAB N/A
 DATE 5-21-08
 BOTTLE TYPE NO. VOLUME ANALYSIS LAB PRESERVATION FILTRATION

(See bottle list)

DECONTAMINATION INFORMATION

PURGE DEVICE ID: _____ HOSE REEL: _____ SAMPLING DEVICE ID: _____
 PREVIOUSLY USED IN WELL: _____ PREVIOUSLY USED IN WELL: _____
 SITE: _____ SITE: _____
 DECON METHOD/STEAM TIME: _____ DECON METHOD/STEAM TIME: _____
 RINSEATE SAMPLE: YES _____ NO _____ ID: _____ RINSEATE SAMPLE: YES _____ NO _____ ID: _____

QA/QC INFORMATION

IN SAMPLE SHIPMENT: TRAVEL BLANK YES _____ NO ID 4768 QA/QC SPIKE YES NO ID _____
 DUPLICATE YES _____ NO ID 4767 FIELD BLANK YES NO ID _____ INTER-LAB SPLIT YES NO ID _____

NOTES

(DUP TAKEN)

LOCUS TECHNOLOGIES WATER SAMPLING LOG

WELL/SAMPLE DESIGNATION TW-2B SITE: S.C. VTA
 SAMPLE SOURCE A DATE: 5-21-08
 AMBIENT CONDITIONS Clear & Sunny PROJECT# 28006-08-0001
 SAMPLER H.CASTRO/ T.Murphy

GRAB SAMPLE INFORMATION (use notes section for meter reading, flow rate, vol purged, etc.)

GRAB SAMPLE: CONTINUOUS PUMPER YES NO pH meter: FLOW RATE:
 METHOD: PUMP CYCLING YES NO METER READING:

WATER LEVEL INFORMATION MEASURING POINT: TOC INSTRUMENT USED: SJ-1

WL BEFORE PURGE: _____ TIME: _____ WL AFTER PURGE: _____ TIME: _____
 WL FOR 80% RECOVERY: _____ WL TIME OF SAMPLE: _____ DATE: _____ TIME: _____

MONITORING WELL PURGE INFORMATION MONITORING WELL PURGE METHOD: E

PURGE DEVICE I.D. Low flow pump
 WELL DEPTH 128' DIAMETER 10" #CASING VOLUMES (PROTOCOL) _____
 SCREENED INTERVAL _____ PUMP SETTING _____
 PURGE VOLUME CALCULATION _____
 TIME PURGE BEGINS _____ ACTUAL AMOUNT PURGED _____ pH INSTRUMENT Low flow cell

TIME	TEMP.	COND.	pH	PURGE WATER APPEARANCE/ODOR	ORP	DO
1515	21.1°	1337	7.39	Slightly brown/no odor	52.3	30.27g/L 2.58mg/L

WATER SAMPLING INFORMATION MONITORING WELL SAMPLE METHOD: D

SAMPLING DEVICE ID: Tubing SAMPLING TIME: 1520 APPROXIMATE DEPTH OF GRAB: N/A
 DATE: 5-21-08
 BOTTLE TYPE NO. VOLUME ANALYSIS LAB PRESERVATION FILTRATION

(See bottle list)

DECONTAMINATION INFORMATION

PURGE DEVICE ID: _____ HOSE REEL: _____ SAMPLING DEVICE ID: _____
 PREVIOUSLY USED IN WELL: _____ PREVIOUSLY USED IN WELL: _____
 SITE: _____ SITE: _____
 DECON METHOD/STEAM TIME: _____ DECON METHOD/STEAM TIME: _____
 RINSEATE SAMPLE: YES NO ID: _____ RINSEATE SAMPLE: YES NO ID: _____

QA/QC INFORMATION

IN SAMPLE SHIPMENT: TRAVEL BLANK YES NO ID 4768 QA/QC SPIKE YES NO ID _____
 DUPLICATE YES NO ID _____ FIELD BLANK YES NO ID _____ INTER-LAB SPLIT YES NO ID _____

NOTES

LOCUS TECHNOLOGIES WATER SAMPLING LOG

WELL/SAMPLE DESIGNATION MW-2E SITE: S.C. VTA
 SAMPLE SOURCE A DATE: 5-21-08
 AMBIENT CONDITIONS Clear & Sunny PROJECT# 28006-08-0001
 SAMPLER H.CASTRO/ T.Murphy

GRAB SAMPLE INFORMATION (Use notes section for meter reading, flow rate, vol. purged, etc.)

GRAB SAMPLE METHOD: _____ CONTINUOUS PUMPER: YES _____ NO _____ pH meter: _____ FLOW RATE: _____
 PUMP CYCLING: YES _____ NO _____ METER READING: _____

WATER LEVEL INFORMATION: _____ MEASURING POINT: STOC INSTRUMENT USED: SJ1

W/L BEFORE PURGE: _____ TIME: _____ W/L AFTER PURGE: _____ TIME: _____
 W/L FOR 80% RECOVERY: _____ W/L TIME OF SAMPLE: _____ DATE: _____ TIME: _____

MONITORING WELL PURGE INFORMATION MONITORING WELL PURGE METHOD E

PURGE DEVICE I.D. Low flow pump
 WELL DEPTH 120' DIAMETER 2" #CASING VOLUMES (PROTOCOL) _____
 SCREENED INTERVAL _____ PUMP SETTING _____
 PURGE VOLUME CALCULATION _____
 TIME PURGE BEGINS _____ ACTUAL AMOUNT PURGED _____ pH INSTRUMENT Low flow cell

TIME	TEMP.	COND.	pH	PURGE WATER APPEARANCE/ODOR	ORP	DO
<u>1555</u>	<u>21.3°c</u>	<u>1397</u>	<u>7.37</u>	<u>Cloudy / no odor</u>	<u>130.7</u>	<u>29.4% 2.80mg/L</u>

WATER SAMPLING INFORMATION MONITORING WELL SAMPLE METHOD D

SAMPLING DEVICE ID Tubing SAMPLING TIME 1600 APPROXIMATE DEPTH OF GRAB N/A
 DATE 5-21-08
 BOTTLE TYPE NO. VOLUME ANALYSIS LAB PRESERVATION FILTRATION
(See bottle list)

DECONTAMINATION INFORMATION

PURGE DEVICE ID: _____ HOSE REEL: _____ SAMPLING DEVICE ID: _____
 PREVIOUSLY USED IN WELL: _____ PREVIOUSLY USED IN WELL: _____
 SITE: _____ SITE: _____
 DECON METHOD/STEAM TIME: _____ DECON METHOD/STEAM TIME: _____
 RINSEATE SAMPLE: YES _____ NO _____ ID: _____ RINSEATE SAMPLE: YES _____ NO _____ ID: _____

QA/QC INFORMATION

IN SAMPLE SHIPMENT: TRAVEL BLANK X YES _____ NO 4768 QA/QC SPIKE YES X NO ID _____
 DUPLICATE YES X NO ID _____ FIELD BLANK YES X NO ID _____ INTER-LAB SPLIT YES X NO ID _____

NOTES

LOCUS TECHNOLOGIES WATER SAMPLING LOG

WELL/SAMPLE DESIGNATION TW-5A SITE: S.C. VTA
 SAMPLE SOURCE A DATE: 5-22-08
 AMBIENT CONDITIONS Clear & Sunny PROJECT# 28006-08-0001
 SAMPLER H. CASTRO/ T. Murphy

GRAB SAMPLE INFORMATION (Use notes section for meter reading, flow rate, vol purged, etc.)

GRAB SAMPLE METHOD: CONTINUOUS PUMPER YES NO pH meter: _____ FLOW RATE: _____
PUMP CYCLING YES NO METER READING: _____

WATER LEVEL INFORMATION MEASURING POINT: TOC INSTRUMENT USED: SJ-1

WL BEFORE PURGE: _____ TIME: _____ WL AFTER PURGE: _____ TIME: _____
 WL FOR 80% RECOVERY: _____ WL TIME OF SAMPLE: _____ DATE: _____ TIME: _____

MONITORING WELL PURGE INFORMATION MONITORING WELL PURGE METHOD: E

PURGE DEVICE I.D. Low flow pump
 WELL DEPTH 95' DIAMETER 10" #CASING VOLUMES (PROTOCOL) _____
 SCREENED INTERVAL _____ PUMP SETTING _____
 PURGE VOLUME CALCULATION _____
 TIME PURGE BEGINS _____ ACTUAL AMOUNT PURGED _____ pH INSTRUMENT Low flow cell

TIME	TEMP.	COND.	pH	PURGE WATER APPEARANCE/ODOR	ORP	DO
<u>845</u>	<u>18.5c</u>	<u>1042</u>	<u>7.11</u>	<u>cloudy brown/ no odor</u>	<u>172.2</u>	<u>19.72g</u> <u>1.81 mg/L</u>

WATER SAMPLING INFORMATION MONITORING WELL SAMPLE METHOD: D

SAMPLING DEVICE ID: Tubing SAMPLING TIME: 850 APPROXIMATE DEPTH OF GRAB: N/A
 DATE: 5-22-08
 BOTTLE TYPE NO. VOLUME ANALYSIS LAB PRESERVATION FILTRATION

(See bottle list)

DECONTAMINATION INFORMATION

PURGE DEVICE ID: _____ HOSE REEL: _____ SAMPLING DEVICE ID: _____
 PREVIOUSLY USED IN WELL: _____ PREVIOUSLY USED IN WELL: _____
 SITE: _____ SITE: _____
 DECON METHOD/STEAM TIME: _____ DECON METHOD/STEAM TIME: _____
 RINSEATE SAMPLE: YES NO ID: _____ RINSEATE SAMPLE: YES NO ID: _____

QA/QC INFORMATION

IN SAMPLE SHIPMENT: TRAVEL BLANK YES NO ID 4768 QA/QC SPIKE YES NO ID _____
 DUPLICATE YES NO ID _____ FIELD BLANK YES NO ID _____ INTER-LAB SPLIT YES NO ID _____

NOTES

LOCUS TECHNOLOGIES WATER SAMPLING LOG

WELL/SAMPLE DESIGNATION MW-5A SITE: S.C. VTA
 SAMPLE SOURCE A DATE: 5-22-08
 AMBIENT CONDITIONS Clear & Sunny PROJECT# 28006-08-0001
 SAMPLER H.CASTRO/ T.Murphy

GRAB SAMPLE INFORMATION (Use notes section for meter reading, flow rate, vol. purged, etc.)

GRAB SAMPLE METHOD: CONTINUOUS PUMPER YES NO pH meter FLOW RATE
 PUMP CYCLING YES NO METER READING

WATER LEVEL INFORMATION MEASURING POINT: TOC INSTRUMENT USED: SJ1

W/L BEFORE PURGE _____ TIME _____ W/L AFTER PURGE _____ TIME _____
 W/L FOR 80% RECOVERY _____ W/L TIME OF SAMPLE _____ DATE _____ TIME _____

MONITORING WELL PURGE INFORMATION MONITORING WELL PURGE METHOD E

PURGE DEVICE I.D. Low flow pump
 WELL DEPTH 125' DIAMETER 2" #CASING VOLUMES (PROTOCOL) _____
 SCREENED INTERVAL _____ PUMP SETTING _____
 PURGE VOLUME CALCULATION _____
 TIME PURGE BEGINS _____ ACTUAL AMOUNT PURGED _____ pH INSTRUMENT Low flow cell

TIME	TEMP.	COND.	pH	PURGE WATER APPEARANCE/ODOR	ORP	DO
950	19.2°	546	7.50	clear/odor	65.3	20.69p 1.74mg/L

WATER SAMPLING INFORMATION MONITORING WELL SAMPLE METHOD D

SAMPLING DEVICE ID Tubing SAMPLING TIME 955 APPROXIMATE DEPTH OF GRAB N/A
 DATE 5-22-08
 BOTTLE TYPE NO. VOLUME ANALYSIS LAB PRESERVATION FILTRATION
(See bottle list)

DECONTAMINATION INFORMATION

PURGE DEVICE ID _____ HOSE REEL _____ SAMPLING DEVICE ID _____
 PREVIOUSLY USED IN WELL _____ PREVIOUSLY USED IN WELL _____
 SITE _____ SITE _____
 DECON METHOD/STEAM TIME _____ DECON METHOD/STEAM TIME _____
 RINSEATE SAMPLE YES NO ID _____ RINSEATE SAMPLE YES NO ID _____

QA/QC INFORMATION

IN SAMPLE SHIPMENT: TRAVEL BLANK YES NO ID 4768 QA/QC SPIKE YES NO ID _____
 DUPLICATE YES NO ID _____ FIELD BLANK YES NO ID _____ INTER-LAB SPLIT YES NO ID _____

NOTES

LOCUS TECHNOLOGIES WATER SAMPLING LOG

WELL/SAMPLE DESIGNATION TW-8A SITE: S.C. VTA
 SAMPLE SOURCE A DATE: 5-22-08
 AMBIENT CONDITIONS Clear & Sunny PROJECT#: 28006-08-0001
 SAMPLER H.CASTRO/T.Murphy

GRAB SAMPLE INFORMATION (use notes section for meter reading, flow rate, vol. purged, etc.)

GRAB SAMPLE METHOD: CONTINUOUS PUMPER YES NO pH meter: _____ FLOW RATE: _____
PUMP CYCLING YES NO METER READING: _____

WATER LEVEL INFORMATION MEASURING POINT: TOC INSTRUMENT USED: SJ-1

W/L BEFORE PURGE: _____ TIME: _____ W/L AFTER PURGE: _____ TIME: _____
 W/L FOR 80% RECOVERY: _____ W/L TIME OF SAMPLE: _____ DATE: _____ TIME: _____

MONITORING WELL PURGE INFORMATION MONITORING WELL PURGE METHOD: E

PURGE DEVICE I.D. Low flow pump
 WELL DEPTH 75' DIAMETER 10" #CASING VOLUMES (PROTOCOL) _____
 SCREENED INTERVAL _____ PUMP SETTING _____
 PURGE VOLUME CALCULATION _____
 TIME PURGE BEGINS _____ ACTUAL AMOUNT PURGED _____ pH INSTRUMENT Low flow cell

TIME	TEMP.	COND.	pH	PURGE WATER APPEARANCE/ODOR	ORP	DO
1040	20.9c	714	7.17	clear/no odor	66.2	20.89g 1.97mg/L

WATER SAMPLING INFORMATION MONITORING WELL SAMPLE METHOD: D

SAMPLING DEVICE ID Tubing SAMPLING TIME 1045 APPROXIMATE DEPTH OF GRAB N/A
 BOTTLE TYPE _____ NO. _____ VOLUME _____ ANALYSIS _____ LAB _____ PRESERVATION _____ FILTRATION _____
 DATE 5-22-08

(See bottle list)

DECONTAMINATION INFORMATION

PURGE DEVICE ID: _____ HOSE REEL: _____ SAMPLING DEVICE ID: _____
 PREVIOUSLY USED IN WELL: _____ PREVIOUSLY USED IN WELL: _____
 SITE: _____ SITE: _____
 DECON METHOD/STEAM TIME: _____ DECON METHOD/STEAM TIME: _____
 RINSEATE SAMPLE: YES NO ID: _____ RINSEATE SAMPLE: YES NO ID: _____

QA/QC INFORMATION

IN SAMPLE SHIPMENT: TRAVEL BLANK YES NO ID 4768 QA/QC SPIKE YES NO ID _____
 DUPLICATE YES NO ID _____ FIELD BLANK YES NO ID _____ INTER-LAB SPLIT YES NO ID _____

NOTES



Gusmer Enterprises, Inc.

Date: _____

File Code (Office Use): _____

640 Airpark Road, Suite D
Napa CA, 94558
Lab (707)224-7903 ext 106, 109
Fax (707)255-2019

Have you submitted samples to us in the past? <input type="checkbox"/> yes <input checked="" type="checkbox"/> no
--

IF YES. (**) MARKED INFORMATION MUST BE FILLED OUT FOR SAMPLES TO BE PROCESSED
IF NO, PLEASE FILL OUT THIS FORM COMPLETELY

ANALYSIS REQUEST FORM

PLEASE LABEL EACH SUBMITTED SAMPLE WITH YOUR WINERY NAME, A SAMPLE NAME AND THE SUBMISSION DATE

PLEASE FILL OUT THE REQUIRED INFORMATION ON BOTH SIDES OF THIS FORM AND SEND OR BRING WITH YOUR SAMPLES

MINIMUM ANALYSIS CHARGE \$25.00

**Account Name (Responsible Party) Locus Technologies

**Name (person requesting analysis) J. Wesley Hawthorne

Address: 299 Fairchild Drive

City, State and Zip: Mountain View, CA 94043

**Daytime Phone (650) 960-1640 **Fax (650) 960-0739

**E-mail hawthorne.w@locustca.com

Credit Card # _____ exp date _____

Name on Card _____ Signature _____

**Send Results to (if different from above): same as above

**Please send results by: fax e-mail mail only (Sorry, results may not be reported by telephone.)
A copy of the written results for your files will be sent by mail with your invoice

Are these samples involved in a legal dispute between two parties? no

Please check all that apply:

- I am not sure which test to run (please write a note or call our lab staff to discuss the sample)
- Do only the tests I select
- Other

Comments:

ANALYSIS REQUEST FORM

Please write the corresponding letter of the analysis you would like performed after the sample name in the table below
Please refer to our Web Page or Catalog for instructions on preparing and sending samples and amount of sample required

**Sample Name		Letter(s) of Requested Analyses	
1. TW-2B	11. TW-5A	O	O
2. MW-2E	12. MW-5A		
3. MW-2F	13. TW-6A		
4. ST-3	14. TW-6B		
5. TW-8A	15. MW-6		
6. MW-3D(V)			
7. ST-5			
8. 4767			
9. 4768			
10. 4769		↓	↓

Sample Type(s):

- uncrushed grapes
- juice
- fermenting
- refrigerated
- wine in cellar
- bottled wine
- water

ANALYSIS PANELS FOR COMMERCIAL WINEMAKERS

	Panel Name	Sample Size Needed
AA	Juice Panel Brix, TA, pH, YAN (NOPA and Ammonia), Nutrient Recommendation (\$68.00)	125 mL
BB	Basic Wine Chemistry Alcohol, VA, TA, pH, Free and Total SO ₂ (\$70.00)	250 mL
CC	Monitoring Malolactic Fermentation pH, Malic acid, Detailed Micro Exam (\$40.00)	125 mL
DD	Comprehensive Wine Panel Alcohol, VA, TA, pH, F/T SO ₂ , Malic Acid, G/F, Basic Sensory Evaluation, Detailed Micro Exam (\$140.00)	375 mL
EE	Cellar Maintenance Panel VA, pH, Malic acid, F/T SO ₂ , SO ₂ Recommendation (\$55.00)	125 mL
FF	Stuck/Sluggish Fermentation Panel Alcohol, VA, pH, G/F, Detailed Micro Exam, Yeast Viability (\$85.00)	375 mL
GG	Problematic MLF Panel Alcohol, VA, pH, F/T SO ₂ , Malic acid, Detailed Micro Exam (\$90.00)	125 mL
HH	Comprehensive Microbiology Panel VA, pH, F/T SO ₂ , Detailed Sensory, Detailed Micro Exam, Direct culture for yeast, mold and bacteria (\$115.00)	375 mL
II	Sediment/Haze ID pH, F/T SO ₂ , Detailed Micro Exam, Detailed Sensory Evaluation, Direct culture for Yeast, Mold and Bacteria (\$100.00) [White wine analysis includes: Cold and Heat (Protein) Stability (\$125.00)]	750 mL Un-opened
JJ	Pre-Bottling Panel Alcohol, VA, TA, pH, F/T SO ₂ , Malic Acid, G/F, Detailed Micro Exam, Direct Culture for Spoilage Organisms (\$140.00) [White wine analysis includes: Cold and Heat (Protein) Stability (\$162.50)]	375 mL
KK	Post-Bottling Panel Alcohol, pH, F/T SO ₂ , Membrane culture for Sterility (\$80.00)	750 mL Un-opened

CHEMICAL TESTS

50 mL min - no headspace

<u>A</u>	Alcohol (NIR)	<u>O</u>	Free and Total SO ₂	<u>X</u>	Brix Refractometer
<u>V</u>	Volatile Acidity	<u>R</u>	SO ₂ Recommendation* pH, F/T SO ₂ are required	<u>D</u>	Brix Hydrometer
<u>I</u>	Total Acidity	<u>M</u>	Malic Acid (Enzymatic)	<u>K</u>	Potassium
<u>P</u>	pH	<u>Z</u>	Residual Sugar (Enzymatic)	<u>B</u>	Bentonite Fining Trials (5 trial levels included)
<u>F</u>	Free SO ₂	<u>C</u>	Cold Stability (Freeze/Thaw)	<u>Y</u>	YAN (NOPA, NH ₄)
<u>S</u>	Total SO ₂	<u>H</u>	Heat (Protein Stability)		

SENSORY EVALUATIONS & ADJUSTMENTS

Sensory Evaluations:

SB Basic

Sulfide Treatment:

FA SRM (no charge)

FB Detection only

FC Detection AND treatment

Adjustment Trials:

TA Acidification

TD De-Acidification

MICROBIOLOGICAL TESTS

Direct Culture

MM Yeast, Mold & Bacteria

MY Yeast & Mold

MB Bacteria only

MD Dekkera/Brettanomyces

MR Red Wine Spoilage

Membrane Culture

MC Yeast, Mold & Bacteria

MP Yeast & Mold

MQ Bacteria only

Microscopic Examination

ME Detailed Micro exam

Other:

MV Yeast Viability

ML Yeast Cell Count

Bioremediation Consulting Inc
 39 Clarendon Street Watertown MA 02472
 phone 617-923-0976 fax 617-923-0959
 e-mail MFindlay@bcilabs.com

CHAIN OF CUSTODY RECORD

Project Name: Locus wells Sampling Location: SCVTA
 PO 30-12342

Sampled by: John Castro

Contact: John Hawthorne hawthornej@locustec.com
 pH: 650-960-1640 fax: 650-960-0739

Instructions: Fill containers completely. No air bubble.
 each set: 2 voas, HCl-preserved: methane, ethane, ethanethiol 502(A)
 2 voas, no preservative: Argon, O₂, CO, CO₂, N₂ = 502(A)
 1 voa, no preservative: dissolved sulfide ~ HACH 8131
 1 voa, no preservative: NH₃-N ~ HACH 8155
 1 160-ml serum bottle: H₂ analyses
 2 4-oz jars: dissolved O₂

RETURN CRIMPER & PLIERS TO BCI

Well Number	Date	VOA Vials HCl-preserved	rcv	VOA Vials No Preserv	rcv	160 ml SB (contain Argon)	rcv	4 oz jars for D.O.	rcv
TW-5A	5/21/08	2		4		1		2	
MW-5A		2		4		1		2	
TW-6A		2		4		1		2	
TW-6B		2		4		1		2	
MW-6J	↓	2		4		1		2	
trip blanks									
Return crimper to BCI									

SHIP TO: Bioremediation Consulting Inc (phone 617-923-0976)
 39 Clarendon St Watertown MA 02472

Shipping Conditions:
ICE NECESSARY; however,
No Loose Ice – bag ice in leak-proof bags
Do not allow ice to contact groundwater samples

Fed Ex Priority Overnight. NO Saturday Delivery

Call or fax BCI at time of shipping and report the tracking number

Relinquished by Sharon Murphy date 5/21/08
 Received by _____ date _____

Bioremediation Consulting Inc
 39 Clarendon Street Watertown MA 02472
 phone 617-923-0976 fax 617-923-0959
 e-mail: MFindlay@bciLabs.com

CHAIN OF CUSTODY RECORD

Project Name: Locus wells Sampling Location: SCVTA
 PO 30-12342
 Sampled by: HANK CASTRO

Contact: John Hawthorne hawthornej@locustec.com
 pH: 650-960-1640 fax: 650-960-0739

Instructions: Fill containers completely. No air bubble.
 each set: 2 voas, HCl-preserved: methane, ethane, ethanethiol
 2 voas, no preservative: Argon, O₂, CO, CO₂, N₂
 1 voa, no preservative: dissolved sulfide
 1 voa, no preservative: NH₃-N
 1 160-ml serum bottle: H₂ analyses
 2 4-oz jars: dissolved O₂

RETURN CRIMPER & PLIERS TO BCI

Well Number	Date	VOA Vials HCl-preserved	rcv	VOA Vials No Preserv	rcv	160 ml SB (contain Argon)	rcv	4 oz jars for D.O.	rcv
TW-2B	5/21/08	2		4		1		2	
MW-2E	5/21/08	2		4		1		2	
MW-2F	5/21/08	2		4		1		2	
ST-3	5/21/08	2		4		1		2	
TW-8A	5/21/08	2		4		1		2	
trip blanks		1		2					
Return crimper to BCI									

SHIP TO: Bioremediation Consulting Inc (phone 617-923-0976)
 39 Clarendon St Watertown MA 02472

Shipping Conditions:
ICE NECESSARY; however,
No Loose Ice – bag ice in leak-proof bags
Do not allow ice to contact groundwater samples

Fed Ex Priority Overnight. NO Saturday Delivery

Call or fax BCI at time of shipping and report the tracking number

Relinquished by Alamy Murphy date 5/21/08
 Received by _____ date _____

Bioremediation Consulting Inc
 39 Clarendon Street Watertown MA 02472
 phone 617-923-0976 fax 617-923-0959
 e-mail: MFindlay@bciLabs.com

CHAIN OF CUSTODY RECORD

Project Name: Locus wells **Sampling Location:** SCVTP
 PO 30-12342
Sampled by: HANK CASTRO

Contact: John Hawthorne hawthornej@locustec.com
 pH: 650-960-1640 fax: 650-960-0739

Instructions: Fill containers completely. No air bubble.
each set: 2 voas, HCl-preserved: methane, ethane, ethanethiol
 2 voas, no preservative: Argon, O₂, CO, CO₂, N₂
 1 voa, no preservative: dissolved sulfide
 1 voa, no preservative: NH₃-N
 1 160-ml serum bottle: H₂ analyses
 2 4-oz jars: dissolved O₂

RETURN CRIMPER & PLIERS TO BCI

Well Number	Date	VOA Vials HCl-preserved	rcv	VOA Vials No Preserv	rcv	160 ml SB (contain Argon)	rcv	4 oz jars for D.O.	rcv
MW-3D(L)	5/21/08	2		4		1		2	
ST-5	↓	2		4		1		2	
4767		2		4		1		2	
4768		2		4		1		2	
4769	↓	2		4		1		2	
trip blanks									
Return crimper to BCI									

SHIP TO: Bioremediation Consulting Inc (phone 617-923-0976)
 39 Clarendon St Watertown MA 02472

Shipping Conditions:
ICE NECESSARY; however,
No Loose Ice – bag ice in leak-proof bags
Do not allow ice to contact groundwater samples

Fed Ex Priority Overnight. **NO** Saturday Delivery

Call or fax BCI at time of shipping and report the tracking number

Relinquished by Alamy Murydz date 5/21/08

Received by _____ date _____

ATTACHMENT B

Field Log, Water Sampling Log, and Chain of Custody Forms

Phase 2 Sampling

For Reference Only

WELL SAMPLING SUMMARY
PHASE 2 GROUNDWATER SAMPLING

Well	Sample Date	Sample Time	Purge Duration (min)	Purge Volume (mL)	Temperature (°C)	pH	Dissolved Oxygen (mg/L)	Dissolved Oxygen (% saturation)	Oxidation-Reduction Potential	Conductivity (µS)	Turbidity (NTU)
ST-7	22-Jul	11:40	14	1900	23.8	7.31	1.10	13.1	113.9	916	13.7
MW-5B	22-Jul	12:10	10	4500	24.5	7.01	1.09	13.1	89.7	1200	75.6
NW-05	22-Jul	12:40	8	3900	26.3	7.68	1.44	18.4	84.3	282	2378.4
ST-12	22-Jul	13:45	10	6000	25.3	6.02	1.75	21.0	169	608	96.5
MW-1	22-Jul	14:35	12	4000	29.3	6.86	1.63	21.6	81.4	230	179.2
MW-3C	22-Jul	15:05	10	4500	27.9	7.25	1.23	16.2	34.9	977	254.1
MW-2G	22-Jul	15:50	14	3800	32.0	7.29	0.70	9.8	122.4	2308	1897.1
MW-6D	23-Jul	7:20	15	3800	20.2	6.19	3.13	34.7	141.7	417	180.3
ST-11	23-Jul	7:56	16	6300	20.0	7.08	1.75	19.5	121.6	594	7.4
ST-10	23-Jul	8:30	11	4800	21.1	7.18	1.17	13.4	95.8	601	1.8
MW-4A	23-Jul	9:10	14	1900	24.2	11.49	1.18	14.0	140.4	1299	93.2
NW-06	23-Jul	10:07	17	4400	23.1	7.77	0.98	11.3	80.1	538	58.6
ST-8	23-Jul	10:45	10	4500	21.8	7.30	0.92	10.7	147.3	1106	37.5
ST-1	23-Jul	11:55	20	2500	24.6	7.19	0.77	9.4	48.4	2873	10.3
NW-01	23-Jul	12:57	9	4500	27.3	7.51	0.83	10.7	67.1	638	341.8
MW-2C	23-Jul	13:43	14	1900	26.8	12.03	1.19	15.1	90.3	5988	39.4
ST-2	23-Jul	14:15	13	5100	26.5	8.50	0.65	8.2	64.7	608	50.7
ST-13	23-Jul	15:00	6	3300	25.6	7.08	2.10	25.6	122.8	1162	70.3

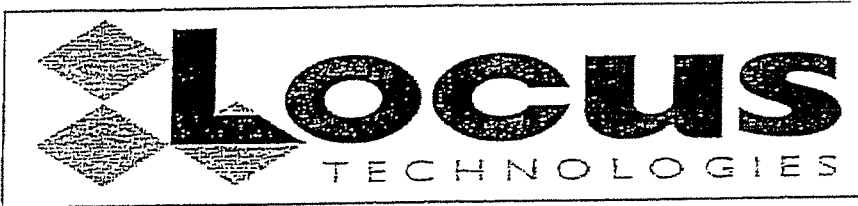

DAILY FIELD ACTIVITY LOG

Project Name: Santa Clara VTA
 Field Activity: Well Sampling
 Weather: clear

Project No.: 28006-08-0002
 Date: 7-22-08
 Logged by: H. Castro Jr.
 Page: 1 of 3

TIME	DAILY ACTIVITIES AND EVENTS
	7-22-08
0610	Prepped & loaded truck for Micro Purge Sampling.
0705	Arrived onsite at ST-8. Setup equipment for Purge.
0750	Could not get water to come up purge line. Called equipco to let them know. Equipco is sending out new equipment powered by CO2.
1055	Equipco arrived with CO2 equipment, exchanged equipment.
1115	AT ST-7. Met with officer Bryan & TCI for traffic control. Set up equipment.
1140	Sampled ST-7.
1150	AT MW-5B. Setup traffic control & purge equipment.
1210	Sampled MW-5B.
1225	AT NW-05. Setup traffic control & purge equipment.
1240	Sampled NW-05.
1320	AT ST-12. Setup traffic control & purge equipment.
1345	Sampled ST-12. TCI & officer Bryan left site.
1415	AT MW-1. Setup purge equip.
1435	Sampled MW-1.
1450	AT MW-3C. Setup purge equip.
1505	Sampled MW-3C.

Comments/Remarks:

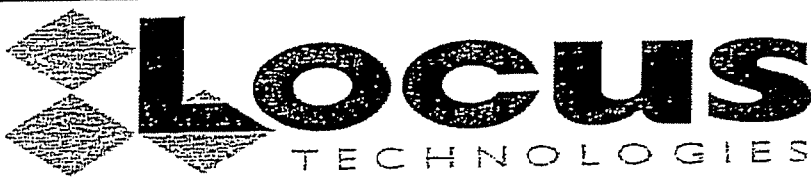

DAILY FIELD ACTIVITY LOG

Project Name: Santa Clara VTA
 Field Activity: Well Sampling
 Weather: clear

Project No.: 28006-08-0002
 Date: 7-23-08
 Logged by: H. Carter, Jr
 Page: 2 of 3

TIME	DAILY ACTIVITIES AND EVENTS
1530	AT MW 2G. Setup purge equip.
1550	Sampled MW-2G.
	<u>7-23-08</u>
0700	AT MW-6D. Setup purge equip.
0720	Sampled MW-6D.
0735	AT ST-11. Setup purge equip.
0756	Sampled ST-11.
0815	AT ST-10. Setup purge equip.
0830	Sampled ST-10.
0850	AT MW-4A. Setup purge equip.
0910	Sampled MW-4A.
0945	AT NW-06. Setup purge equip.
1007	Sampled NW-06.
1025	AT ST-8. Setup purge equip.
1045	Sampled ST-8.
1125	AT ST-1. Setup purge equip.
1155	Sampled ST-1.
1240	AT NW-01. Setup purge equip.
1257	Sampled NW-01.

Comments/Remarks:

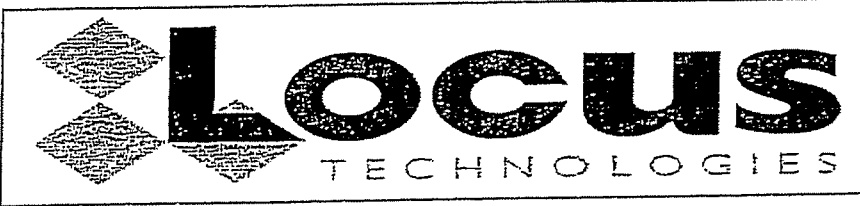

DAILY FIELD ACTIVITY LOG

Project Name: Santa Clara VTA

Project No.: 28006-08-0002

Field Activity: Well Sampling

Date: 7-23-08

Weather: clear

Logged by: H. Costello

Page: 3 of 3

TIME	DAILY ACTIVITIES AND EVENTS
1322	AT MW-2C. Setup purge equip.
1343	Sampled MW-2C.
1400	AT ST-2. Setup purge equip.
1415	Sampled ST-2.
1440	AT ST-13. Setup purge equip.
1500	Sampled ST-13.
1525	Left purge water onsite east of ST-13 against wall w/ analysis label filled out.
1540	Left site for M.V. office.

Comments/Remarks:

LOCUS TECHNOLOGIES WATER SAMPLING LOG

WELL/SAMPLE DESIGNATION ST-7 SITE: S.C. VTA
 SAMPLE SOURCE A DATE: 7-22-08
 AMBIENT CONDITIONS clear PROJECT#: 28006-08-0002
 SAMPLER: H. Castro / T. Murphy

GRAB SAMPLE INFORMATION (use notes section for meter reading, flow rate, vol. purged etc.)

GRAB SAMPLE METHOD: _____ CONTINUOUS PUMPER YES NO pH meter: _____ FLOW RATE: _____
 PUMP CYCLING YES NO METER READING _____

WATER LEVEL INFORMATION MEASURING POINT _____ INSTRUMENT USED _____

W.L. BEFORE PURGE 15.31 TIME _____ W.L. AFTER PURGE 15.31 TIME _____
 W.L. FOR 80% RECOVERY _____ W.L. TIME OF SAMPLE _____ DATE _____ TIME _____

MONITORING WELL PURGE INFORMATION MONITORING WELL PURGE METHOD _____

PURGE DEVICE I.D. Low flow pump DIAMETER 4" #CASING VOLUMES (PROTOCOL) CPM B1
 WELL DEPTH _____ PUMP SETTING 70'
 SCREENED INTERVAL _____
 PURGE VOLUME CALCULATION _____ ACTUAL AMOUNT PURGED 1900 ML pH INSTRUMENT Low flow cell
 TIME PURGE BEGINS 1126

TIME	TEMP.	COND.	pH	PURGE WATER APPEARANCE/ODOR	ORP	TURBIDITY
1137	23.8	916	7.30	cloudy / no odor	113.8	13.7
1138	23.8	916	7.31	" " "	113.9	13.7
1139	23.9	918	7.31	" " "	113.9	13.6

WATER SAMPLING INFORMATION MONITORING WELL SAMPLE METHOD B

SAMPLING DEVICE ID 1/4" Tubing SAMPLING TIME 1140 APPROXIMATE DEPTH OF GRAB _____
 DATE 7-22-08

BOTTLE TYPE	NO.	VOLUME	ANALYSIS	LAB	PRESERVATION	FILTRATION
VOA	2	40ML	Methane	BCI	HCl	None
VOA	2	40ML	CO ₂ , N ₂	BCI	None	None
VOA	1	40ML	Dissolved Sulfide	BCI	None	None

DECONTAMINATION INFORMATION

PURGE DEVICE ID _____ HOSE REEL _____ SAMPLING DEVICE ID _____ HOSE REEL _____
 PREVIOUSLY USED IN WELL _____ PREVIOUSLY USED IN WELL _____
 SITE _____ SITE _____
 DECON METHOD/STEAM TIME _____ DECON METHOD/STEAM TIME _____
 RINSE/ATE SAMPLE YES NO ID _____ RINSE/ATE SAMPLE YES NO ID _____

QA/QC INFORMATION

IN SAMPLE SHIPMENT: TRAVEL BLANK YES NO ID _____ QA/QC SPIKE YES NO ID _____
 DUPLICATE YES NO ID _____ FIELD BLANK YES NO ID _____ INTER-LAB SPLIT YES NO ID _____

NOTES
DO₉₀ = 13.1
DO_{mg} = 1.10

LOCUS TECHNOLOGIES WATER SAMPLING LOG

WELL/SAMPLE DESIGNATION MW-5B SITE: S.C. VTA
 SAMPLE SOURCE A DATE: 7-22-08
 AMBIENT CONDITIONS clear PROJECT# 28006-08-0002
 SAMPLER H. Castro/T. Murphy

GRAB SAMPLE INFORMATION (use notes section for meter reading, flow rate, vol. purged etc.)

GRAB SAMPLE METHOD: _____ CONTINUOUS PUMPER YES NO pH meter: _____ FLOW RATE: _____
 PUMP CYCLING YES NO METER READING _____

WATER LEVEL INFORMATION **MEASURING POINT** **INSTRUMENT USED**

W.L. BEFORE PURGE 23.06 TIME _____ W.L. ^{During} AFTER PURGE 23.06 TIME _____
 W.L. FOR 80% RECOVERY _____ W.L. TIME OF SAMPLE _____ DATE _____ TIME _____

MONITORING WELL PURGE INFORMATION **MONITORING WELL PURGE METHOD**

PURGE DEVICE I.D. Low flow pump #CASING VOLUMES (PROTOCOL) 3
 WELL DEPTH _____ DIAMETER 2" PUMP SETTING 90'
 SCREENED INTERVAL _____
 PURGE VOLUME CALCULATION _____
 TIME PURGE BEGINS 1200 ACTUAL AMOUNT PURGED 4500ML pH INSTRUMENT Low flow cell

TIME	TEMP.	COND.	pH	PURGE WATER APPEARANCE/ODOR	ORP	TURBIDITY
1207	24.5	1200	7.00	clear/no odor	89.7	75.7
1208	24.5	1200	7.01	ll " "	89.7	75.6
1209	24.5	1200	7.01	ll " "	89.6	75.5

WATER SAMPLING INFORMATION **MONITORING WELL SAMPLE METHOD** B

SAMPLING DEVICE ID 1/4" Tubing SAMPLING TIME 1210 APPROXIMATE DEPTH OF GRAB _____
 DATE 7-22-08

BOTTLE TYPE	NO.	VOLUME	ANALYSIS	LAB	PRESERVATION	FILTRATION
VOA	2	40ML	Methane	BCI	HCl	None
VOA	2	40ML	CO ₂ , N ₂	BCI	None	None
VOA	1	40ML	Dissolved Sulfide	BCI	None	None

DECONTAMINATION INFORMATION

PURGE DEVICE ID _____ HOSE REEL _____ SAMPLING DEVICE ID _____ HOSE REEL _____
 PREVIOUSLY USED IN WELL _____ PREVIOUSLY USED IN WELL _____
 SITE _____ SITE _____
 DECON METHOD/STEAM TIME _____ DECON METHOD/STEAM TIME _____
 RINSEATE SAMPLE YES NO ID _____ RINSEATE SAMPLE YES NO ID _____

QA/QC INFORMATION

IN SAMPLE SHIPMENT: TRAVEL BLANK YES NO ID _____ QA/QC SPIKE YES NO ID _____
 DUPLICATE YES NO ID _____ FIELD BLANK YES NO ID _____ INTER-LAB SPLIT YES NO ID _____

NOTES
DO % = 13.1
DO Mg = 1.09

LOCUS TECHNOLOGIES WATER SAMPLING LOG

WELL/SAMPLE DESIGNATION NW-05 SITE: S.C. VTA
 SAMPLE SOURCE A DATE: 7-22-08
 AMBIENT CONDITIONS clear PROJECT#: 28006-08-0002
 SAMPLER H. Castro/T. Murphy

GRAB SAMPLE INFORMATION (use notes section for meter reading, flow rate, vol. purged etc.)

GRAB SAMPLE METHOD: _____ CONTINUOUS PUMPER YES NO pH meter: _____ FLOW RATE: _____
 PUMP CYCLING YES NO METER READING _____

WATER LEVEL INFORMATION **MEASURING POINT** **INSTRUMENT USED**

W.L. BEFORE PURGE 21.31 TIME _____ W.L. AFTER PURGE 21.36 TIME _____
 W.L. FOR 80% RECOVERY _____ W.L. TIME OF SAMPLE _____ DATE _____ TIME _____

MONITORING WELL PURGE INFORMATION **MONITORING WELL PURGE METHOD**

PURGE DEVICE I.D. Low flow pump DIAMETER 6" #CASING VOLUMES (PROTOCOL) 3
 WELL DEPTH _____ PUMP SETTING 85'
 SCREENED INTERVAL _____
 PURGE VOLUME CALCULATION _____
 TIME PURGE BEGINS 1232 ACTUAL AMOUNT PURGED 3900ML pH INSTRUMENT Low flow cell

TIME	TEMP.	COND.	pH	PURGE WATER APPEARANCE/ODOR	ORP	TURBIDITY
1241	26.2	280	7.68	Silty/slight odor	84.2	2376.8
1242	26.3	282	7.68	" " "	84.3	2378.6
1243	26.3	282	7.68	" " "	84.3	2378.4

WATER SAMPLING INFORMATION **MONITORING WELL SAMPLE METHOD** B

SAMPLING DEVICE ID 1/4" Tubing SAMPLING TIME 1240 APPROXIMATE DEPTH OF GRAB _____
 DATE 7-22-08

BOTTLE TYPE	NO.	VOLUME	ANALYSIS	LAB	PRESERVATION	FILTRATION
VOA	2	40ML	Methane	BCI	HCl	None
VOA	2	40ML	CO ₂ , N ₂	BCI	None	None
VOA	1	40ML	Dissolved Solids	BCI	None	None

DECONTAMINATION INFORMATION

PURGE DEVICE ID _____ HOSE REEL _____ SAMPLING DEVICE ID _____ HOSE REEL _____
 PREVIOUSLY USED IN WELL _____ PREVIOUSLY USED IN WELL _____
 SITE _____ SITE _____
 DECON METHOD/STEAM TIME _____ DECON METHOD/STEAM TIME _____
 RINSEATE SAMPLE YES NO ID _____ RINSEATE SAMPLE YES NO ID _____

QA/QC INFORMATION

IN SAMPLE SHIPMENT: TRAVEL BLANK YES NO ID _____ QA/QC SPIKE YES NO ID _____
 DUPLICATE YES NO ID _____ FIELD BLANK YES NO ID _____ INTER-LAB SPLIT YES NO ID _____

NOTES

DO% = 18.4
 DOMg = 1.44

LOCUS TECHNOLOGIES WATER SAMPLING LOG

WELL/SAMPLE DESIGNATION ST-12 SITE: S.C. VTA
 SAMPLE SOURCE A DATE: 7-22-08
 AMBIENT CONDITIONS clear PROJECT# 28006-08-0002
 SAMPLER H. Castro/T. Murphy

GRAB SAMPLE INFORMATION (use notes section for meter reading, flow rate, vol. purged etc.)

GRAB SAMPLE METHOD: _____ CONTINUOUS PUMPER YES NO pH meter: _____ FLOW RATE: _____
 PUMP CYCLING YES NO METER READING _____

WATER LEVEL INFORMATION **MEASURING POINT** **INSTRUMENT USED**

W.L. BEFORE PURGE 19.90 TIME _____ W.L. AFTER PURGE 19.90 TIME _____
 W.L. FOR 80% RECOVERY _____ W.L. TIME OF SAMPLE _____ DATE _____ TIME _____

MONITORING WELL PURGE INFORMATION **MONITORING WELL PURGE METHOD**

PURGE DEVICE I.D. Low flow pump CPM
 WELL DEPTH _____ DIAMETER 4" #GASING VOLUMES (PROTOCOL) 34
 SCREENED INTERVAL _____ PUMP SETTING 66'
 PURGE VOLUME CALCULATION _____
 TIME PURGE BEGINS 1335 ACTUAL AMOUNT PURGED 6000 mL pH INSTRUMENT Low flow cell

TIME	TEMP.	COND.	pH	PURGE WATER APPEARANCE/ODOR	ORP	TURBIDITY
1342	25.2	609	6.00	cloudy/no color	169.0	96.4
1343	25.3	608	6.02	" " "	169.0	96.5
1344	25.3	608	6.02	" " "	169.1	96.5

WATER SAMPLING INFORMATION **MONITORING WELL SAMPLE METHOD** B

SAMPLING DEVICE ID 1/4" Tubing SAMPLING TIME 1345 APPROXIMATE DEPTH OF GRAB _____
 DATE 7-22-08

BOTTLE TYPE	NO.	VOLUME	ANALYSIS	LAB	PRESERVATION	FILTRATION
VOA	2	40ML	Methane	BCI	HCl	None
VOA	2	40ML	CO ₂ , N ₂	BCI	None	None
VOA	1	40ML	Dissolved Sulfide	BCI	None	None

DECONTAMINATION INFORMATION

PURGE DEVICE ID _____ HOSE REEL _____ SAMPLING DEVICE ID _____ HOSE REEL _____
 PREVIOUSLY USED IN WELL _____ PREVIOUSLY USED IN WELL _____
 SITE _____ SITE _____
 DECON METHOD/STEAM TIME _____ DECON METHOD/STEAM TIME _____
 RINSEATE SAMPLE YES NO ID _____ RINSEATE SAMPLE YES NO ID _____

QA/QC INFORMATION

IN SAMPLE SHIPMENT: TRAVEL BLANK YES NO ID _____ QA/QC SPIKE YES NO ID _____
 DUPLICATE YES NO ID _____ FIELD BLANK YES NO ID _____ INTER-LAB SPLIT YES NO ID _____

NOTES
DO% = 21.0
DO mg = 1.75

LOCUS TECHNOLOGIES WATER SAMPLING LOG

WELL/SAMPLE DESIGNATION MW-1 SITE: S.C. VTA
 SAMPLE SOURCE A DATE: 7-22-08
 AMBIENT CONDITIONS clear PROJECT#: 28006-08-0002
 SAMPLER: H. Castro / T. Murphy

GRAB SAMPLE INFORMATION (use notes section for meter reading, flow rate, vol. purged etc.)

GRAB SAMPLE METHOD: _____ CONTINUOUS PUMPER YES NO
 PUMP CYCLING YES NO pH meter: _____ FLOW RATE: _____
 METER READING: _____

WATER LEVEL INFORMATION MEASURING POINT _____ INSTRUMENT USED _____

W.L. BEFORE PURGE 12.77 TIME _____ W.L. ^{During} AFTER PURGE 12.98 TIME _____
 W.L. FOR 80% RECOVERY _____ W.L. TIME OF SAMPLE _____ DATE _____ TIME _____

MONITORING WELL PURGE INFORMATION MONITORING WELL PURGE METHOD _____

PURGE DEVICE I.D. Low flow pump DIAMETER 2" #CASING VOLUMES (PROTOCOL) 2
 WELL DEPTH _____ PUMP SETTING 60' pH INSTRUMENT Low flow cell
 SCREENED INTERVAL _____
 PURGE VOLUME CALCULATION _____
 TIME PURGE BEGINS 1423 ACTUAL AMOUNT PURGED _____

TIME	TEMP.	COND.	pH	PURGE WATER APPEARANCE/ODOR	ORP	TURBIDITY
1433	29.3	230	6.86	cloudy/no odor	81.4	179.2
1433	29.3	230	6.86	" "	81.4	179.1
1434	29.3	231	6.86	" "	81.4	179.3

WATER SAMPLING INFORMATION MONITORING WELL SAMPLE METHOD R

SAMPLING DEVICE ID 1/4" Tubing SAMPLING TIME 1435 APPROXIMATE DEPTH OF GRAB _____
 DATE 7-22-08

BOTTLE TYPE	NO.	VOLUME	ANALYSIS	LAB	PRESERVATION	FILTRATION
VDA	2	40ML	Methane	BCI	HCl	None
VDA	2	40ML	CO ₂ , N ₂	BCI	None	None
VDA	1	40ML	Dissolved Sulfide	BCI	None	None

DECONTAMINATION INFORMATION

PURGE DEVICE ID _____ HOSE REEL _____ SAMPLING DEVICE ID _____ HOSE REEL _____
 PREVIOUSLY USED IN WELL _____ PREVIOUSLY USED IN WELL _____
 SITE _____ SITE _____
 DECON METHOD/STEAM TIME _____ DECON METHOD/STEAM TIME _____
 RINSEATE SAMPLE YES NO ID _____ RINSEATE SAMPLE YES NO ID _____

QA/QC INFORMATION

IN SAMPLE SHIPMENT: TRAVEL BLANK YES NO ID _____ QA/QC SPIKE YES NO ID _____
 DUPLICATE YES NO ID _____ FIELD BLANK YES NO ID _____ INTER-LAB SPLIT YES NO ID _____

NOTES
DD₂₀ = 21.6
DDMS = 1.63

LOCUS TECHNOLOGIES WATER SAMPLING LOG

WELL/SAMPLE DESIGNATION MW-30C SITE: S.C. VTA
 SAMPLE SOURCE A DATE: 7-22-08
 AMBIENT CONDITIONS clear PROJECT# 28006-08-0002
 SAMPLER H. Castro/H. Murphy

GRAB SAMPLE INFORMATION (use notes section for meter reading, flow rate, vol. purged etc.)

GRAB SAMPLE METHOD: _____ CONTINUOUS PUMPER YES NO pH meter: _____ FLOW RATE: _____
 PUMP CYCLING YES NO METER READING: _____

WATER LEVEL INFORMATION MEASURING POINT INSTRUMENT USED

W.L. BEFORE PURGE 20.47 TIME During W.L. AFTER PURGE 20.47 TIME _____
 W.L. FOR 80% RECOVERY _____ W.L. TIME OF SAMPLE _____ DATE _____ TIME _____

MONITORING WELL PURGE INFORMATION MONITORING WELL PURGE METHOD

PURGE DEVICE I.D. Low flow pump DIAMETER 2" #CASING VOLUMES (PROTOCOL) 3 CPM _____
 WELL DEPTH _____ PUMP SETTING 73'
 SCREENED INTERVAL _____
 PURGE VOLUME CALCULATION _____
 TIME PURGE BEGINS 1455 ACTUAL AMOUNT PURGED 4500ML pH INSTRUMENT Low flow cell

TIME	TEMP.	COND.	pH	PURGE WATER APPEARANCE/ODOR	ORP	TURBIDITY
1502	27.9	976	7.24	cloudy/no odor	34.8	253.8
1503	27.9	977	7.25	" " "	34.9	254.1
1504	27.9	977	7.25	" " "	34.9	254.1

WATER SAMPLING INFORMATION MONITORING WELL SAMPLE METHOD 13

SAMPLING DEVICE ID 1/4" Tubing SAMPLING TIME 1505 APPROXIMATE DEPTH OF GRAB _____
 DATE 7-22-08

BOTTLE TYPE	NO.	VOLUME	ANALYSIS	LAB	PRESERVATION	FILTRATION
VOA	2	40ML	Methane	BCI	HCl	None
VOA	2	40ML	CO ₂ , N ₂	BCI	None	None
VOA	1	40ML	Dissolved Sulfide	BCI	None	None

DECONTAMINATION INFORMATION

PURGE DEVICE ID _____ HOSE REEL _____ SAMPLING DEVICE ID _____ HOSE REEL _____
 PREVIOUSLY USED IN WELL _____ PREVIOUSLY USED IN WELL _____
 SITE _____ SITE _____
 DECON METHOD/STEAM TIME _____ DECON METHOD/STEAM TIME _____
 RINSE/SEAL SAMPLE YES NO ID _____ RINSE/SEAL SAMPLE YES NO ID _____

QA/QC INFORMATION

IN SAMPLE SHIPMENT: TRAVEL BLANK YES NO ID _____ QA/QC SPIKE YES NO ID _____
 DUPLICATE YES NO ID _____ FIELD BLANK YES NO ID _____ INTER-LAB SPLIT YES NO ID _____

NOTES: Rinse
DO % = 16.2
DO mg = 1.23

LOCUS TECHNOLOGIES WATER SAMPLING LOG

WELL/SAMPLE DESIGNATION MW-26 SITE: S.C. VTA
 SAMPLE SOURCE A DATE: 7-22-08
 AMBIENT CONDITIONS clear PROJECT#: 28006-08-0002
 SAMPLER: H. Castro / T. Murphy

GRAB SAMPLE INFORMATION (use notes section for meter reading, flow rate, vol. purged etc.)

GRAB SAMPLE METHOD: _____ CONTINUOUS PUMPER YES NO pH meter: _____ FLOW RATE: _____
 PUMP CYCLING YES NO METER READING: _____

WATER LEVEL INFORMATION **MEASURING POINT** **INSTRUMENT USED**

W.L. BEFORE PURGE 20.21 TIME During W.L. AFTER PURGE 20.32 TIME _____
 W.L. FOR 80% RECOVERY _____ W.L. TIME OF SAMPLE _____ DATE _____ TIME _____

MONITORING WELL PURGE INFORMATION **MONITORING WELL PURGE METHOD**

PURGE DEVICE I.D. Low flow pump CPM _____
 WELL DEPTH _____ DIAMETER 2" #CASING VOLUMES (PROTOCOL) 2
 SCREENED INTERVAL _____ PUMP SETTING 70'
 PURGE VOLUME CALCULATION _____
 TIME PURGE BEGINS 1536 ACTUAL AMOUNT PURGED 3800 ML pH INSTRUMENT Low flow cell

TIME	TEMP.	COND.	pH	PURGE WATER APPEARANCE/ODOR	ORP	TURBIDITY
1552	31.9	2309	7.30	silty / slight color	-122.6	1896.4
1553	32.0	2308	7.29	" " "	-122.4	1897.1
1554	32.0	2308	7.29	" " "	-122.4	1897.2

WATER SAMPLING INFORMATION **MONITORING WELL SAMPLE METHOD** R

SAMPLING DEVICE ID 1/4" Tubing SAMPLING TIME 1550 APPROXIMATE DEPTH OF GRAB _____
 DATE 7-22-08

BOTTLE TYPE	NO.	VOLUME	ANALYSIS	LAB	PRESERVATION	FILTRATION
VOA	2	40ML	Methane	BCI	HCl	None
VOA	2	40ML	CO ₂ , N ₂	BCI	None	None
VOA	1	40ML	Dissolved Sulfide	BCI	None	None

DECONTAMINATION INFORMATION

PURGE DEVICE ID _____ HOSE REEL _____ SAMPLING DEVICE ID _____ HOSE REEL _____
 PREVIOUSLY USED IN WELL _____ PREVIOUSLY USED IN WELL _____
 SITE _____ SITE _____
 DECON METHOD/STEAM TIME _____ DECON METHOD/STEAM TIME _____
 RINSEATE SAMPLE YES NO ID _____ RINSEATE SAMPLE YES NO ID _____

QA/QC INFORMATION

IN SAMPLE SHIPMENT: TRAVEL BLANK YES NO ID _____ QA/QC SPIKE YES NO ID _____
 DUPLICATE YES NO ID 4783 FIELD BLANK YES NO ID _____ INTER-LAB SPLIT YES NO ID _____

NOTES
DO₂₀ = 9.8
DO_{mg} = 0.70 mg

LOCUS TECHNOLOGIES WATER SAMPLING LOG

WELL/SAMPLE DESIGNATION MW-6D SITE: S.C. VTA
 SAMPLE SOURCE A DATE: 7-23-08
 AMBIENT CONDITIONS clear PROJECT#: 28006-08-0002
 SAMPLER: H. Castro / T. Murphy

GRAB SAMPLE INFORMATION (use notes section for meter reading, flow rate, vol. purged etc.)

GRAB SAMPLE METHOD: / CONTINUOUS PUMPER YES NO pH meter: / FLOW RATE: /
 PUMP CYCLING YES NO METER READING: /

WATER LEVEL INFORMATION MEASURING POINT INSTRUMENT USED

W.L. BEFORE PURGE 21.12 TIME During W.L. AFTER PURGE 21.17 TIME /
 W.L. FOR 80% RECOVERY / W.L. TIME OF SAMPLE / DATE / TIME /

MONITORING WELL PURGE INFORMATION MONITORING WELL PURGE METHOD

PURGE DEVICE I.D. Low flow pump DIAMETER 2" #CASING VOLUMES (PROTOCOL) 32
 WELL DEPTH / PUMP SETTING 75' pH INSTRUMENT Low flow cell
 SCREENED INTERVAL / ACTUAL AMOUNT PURGED 3800ML

TIME	TEMP.	COND.	pH	PURGE WATER APPEARANCE/ODOR	ORP	TURBIDITY
716	20.2	417	6.19	clear/no odor	146.7	180.2
717	20.3	417	6.19	ll ll ll	146.7	180.3
718	20.2	417	6.20	ll ll ll	146.7	180.3

WATER SAMPLING INFORMATION MONITORING WELL SAMPLE METHOD B

SAMPLING DEVICE ID <u>1/4" Tubing</u>		SAMPLING TIME <u>720</u>	APPROXIMATE DEPTH OF GRAB <u>/</u>				
BOTTLE TYPE	NO.	VOLUME	ANALYSIS	LAB	PRESERVATION	FILTRATION	
VDA	2	40ML	Methane	BCI	HCl	None	
VDA	2	40ML	CO ₂ , N ₂	BCI	None	None	
VDA	1	40ML	Dissolved Sulfide	BCI	None	None	

DECONTAMINATION INFORMATION

PURGE DEVICE ID / HOSE REEL / SAMPLING DEVICE ID / HOSE REEL /
 PREVIOUSLY USED IN WELL / PREVIOUSLY USED IN WELL /
 SITE / SITE /
 DECON METHOD/STEAM TIME / DECON METHOD/STEAM TIME /
 RINSEATE SAMPLE YES NO ID / RINSEATE SAMPLE YES NO ID /

QA/QC INFORMATION

IN SAMPLE SHIPMENT: TRAVEL BLANK YES X NO ID / QA/QC SPIKE YES X NO ID /
 DUPLICATE X YES NO ID 4785 FIELD BLANK YES X NO ID / INTER-LAB SPLIT YES X NO ID /

NOTES
(DUP TAKEN) DO₂₀ = 34.7
 DO₁₃ = 3.13

LOCUS TECHNOLOGIES WATER SAMPLING LOG

WELL/SAMPLE DESIGNATION ST-11 SITE: S.C. VTA
 SAMPLE SOURCE A DATE: 7-23-08
 AMBIENT CONDITIONS clear PROJECT# 28006-08-0002
 SAMPLER H. Castro/T. Murphy

GRAB SAMPLE INFORMATION (use notes section for meter reading, flow rate, vol. purged etc.)

GRAB SAMPLE METHOD: _____ CONTINUOUS PUMPER YES NO pH meter: _____ FLOW RATE: _____
 PUMP CYCLING YES NO METER READING _____

WATER LEVEL INFORMATION **MEASURING POINT** **INSTRUMENT USED**

W.L. BEFORE PURGE 24.50 TIME During W.L. AFTER PURGE 24.50 TIME _____
 W.L. FOR 80% RECOVERY _____ W.L. TIME OF SAMPLE _____ DATE _____ TIME _____

MONITORING WELL PURGE INFORMATION **MONITORING WELL PURGE METHOD**

PURGE DEVICE I.D. Low flow pump DIAMETER 4" #CASING VOLUMES (PROTOCOL) 3
 WELL DEPTH _____ PUMP SETTING 8-2*
 SCREENED INTERVAL _____
 PURGE VOLUME CALCULATION _____
 TIME PURGE BEGINS 740 ACTUAL AMOUNT PURGED 6300 ML pH INSTRUMENT Low flow cell

TIME	TEMP.	COND.	pH	PURGE WATER APPEARANCE/ODOR	ORP	TURBIDITY
752	20.0	593	7.08	clear/no odor	121.4	7.4
753	20.1	594	7.08	" " "	121.6	7.4
754	20.0	594	7.08	" " "	121.6	7.5

WATER SAMPLING INFORMATION **MONITORING WELL SAMPLE METHOD** B

SAMPLING DEVICE ID 1/4" Tubing SAMPLING TIME 756 APPROXIMATE DEPTH OF GRAB _____ DATE 7-23-08

BOTTLE TYPE	NO.	VOLUME	ANALYSIS	LAB	PRESERVATION	FILTRATION
VOA	2	40ML	Methane	BCI	HCl	None
VOA	2	40ML	CO ₂ , N ₂	BCI	None	None
VOA	1	40ML	Dissolved Solids	BCI	None	None

DECONTAMINATION INFORMATION

PURGE DEVICE ID _____ HOSE REEL _____ SAMPLING DEVICE ID _____ HOSE REEL _____
 PREVIOUSLY USED IN WELL _____ PREVIOUSLY USED IN WELL _____
 SITE _____ SITE _____
 DECON METHOD/STEAM TIME _____ DECON METHOD/STEAM TIME _____
 RINSE/ATE SAMPLE YES NO ID _____ RINSE/ATE SAMPLE YES NO ID _____

QA/QC INFORMATION

IN SAMPLE SHIPMENT: TRAVEL BLANK YES NO ID _____ QA/QC SPIKE YES NO ID _____
 DUPLICATE YES NO ID _____ FIELD BLANK YES NO ID 4786 INTER-LAB SPLIT YES NO ID _____

NOTES Rinse (RIS TAKEN) NO₂ = 19.5
DOMS = 1.75

LOCUS TECHNOLOGIES WATER SAMPLING LOG

WELL/SAMPLE DESIGNATION ST-10 SITE: S.C. VTA
 SAMPLE SOURCE A DATE: 7-23-08
 AMBIENT CONDITIONS Clear PROJECT#: 28006-08-0002
 SAMPLER H. Castro/T. Murphy

GRAB SAMPLE INFORMATION (use notes section for meter reading, flow rate, vol. purged etc.)

GRAB SAMPLE METHOD: _____ CONTINUOUS PUMPER YES NO pH meter: _____ FLOW RATE: _____
 PUMP CYCLING YES NO METER READING _____

WATER LEVEL INFORMATION **MEASURING POINT** **INSTRUMENT USED**

W.L. BEFORE PURGE 23.06 TIME _____ W.L. AFTER PURGE 23.06 TIME _____
 W.L. FOR 80% RECOVERY _____ W.L. TIME OF SAMPLE _____ DATE _____ TIME _____

MONITORING WELL PURGE INFORMATION **MONITORING WELL PURGE METHOD**

PURGE DEVICE I.D. Low flow pump DIAMETER 4" #CASING VOLUMES (PROTOCOL) 3
 WELL DEPTH _____ PUMP SETTING 70'
 SCREENED INTERVAL _____
 PURGE VOLUME CALCULATION _____
 TIME PURGE BEGINS 8:19 ACTUAL AMOUNT PURGED 4800 ML pH INSTRUMENT Low flow cell

TIME	TEMP.	COND.	pH	PURGE WATER APPEARANCE/ODOR	ORP	TURBIDITY
8:27	21.1	600	7.18	Clear/no odor	95.7	1.8
8:28	21.1	601	7.18	ll ll ll	95.8	1.8
8:29	21.1	601	7.19	ll ll ll	95.8	1.8

WATER SAMPLING INFORMATION **MONITORING WELL SAMPLE METHOD** IS

SAMPLING DEVICE ID 1/4" Tubing SAMPLING TIME 8:30 APPROXIMATE DEPTH OF GRAB _____
 DATE 7-23-08

BOTTLE TYPE	NO.	VOLUME	ANALYSIS	LAB	PRESERVATION	FILTRATION
VOA	2	40ML	Methane	BCI	HCl	None
VOA	2	40ML	CO ₂ , N ₂	BCI	None	None
VOA	1	40ML	Dissolved Sulfide	BCI	None	None

DECONTAMINATION INFORMATION

PURGE DEVICE ID _____ HOSE REEL _____ SAMPLING DEVICE ID _____ HOSE REEL _____
 PREVIOUSLY USED IN WELL _____ PREVIOUSLY USED IN WELL _____
 SITE _____ SITE _____
 DECON METHOD/STEAM TIME _____ DECON METHOD/STEAM TIME _____
 RINSE/ATE SAMPLE YES NO ID _____ RINSE/ATE SAMPLE YES NO ID _____

QA/QC INFORMATION

IN SAMPLE SHIPMENT: TRAVEL BLANK YES NO ID _____ QA/QC SPIKE YES NO ID _____
 DUPLICATE YES NO ID _____ FIELD BLANK YES NO ID _____ INTER-LAB SPLIT YES NO ID _____

NOTES

DO% = 13.4
 DO mg = 1.17

LOCUS TECHNOLOGIES WATER SAMPLING LOG

WELL/SAMPLE DESIGNATION MW-4A SITE: S.C. VTA
 SAMPLE SOURCE A DATE: 7-23-08
 AMBIENT CONDITIONS clear PROJECT#: 28006-08-0002
 SAMPLER: H. Castro / T. Murphy

GRAB SAMPLE INFORMATION (use notes section for meter reading, flow rate, vol. purged etc.)

GRAB SAMPLE METHOD: _____ CONTINUOUS PUMPER YES NO pH meter: _____ FLOW RATE: _____
 PUMP CYCLING YES NO METER READING: _____

WATER LEVEL INFORMATION **MEASURING POINT** **INSTRUMENT USED**

W.L. BEFORE PURGE 13.61 TIME _____ W.L. AFTER PURGE 16.68 TIME _____
 W.L. FOR 80% RECOVERY _____ W.L. TIME OF SAMPLE _____ DATE _____ TIME _____

MONITORING WELL PURGE INFORMATION **MONITORING WELL PURGE METHOD**

PURGE DEVICE I.D. Low flow pump CPM
 WELL DEPTH _____ DIAMETER 2" #SABING VOLUMES (PROTOCOL) 81
 SCREENED INTERVAL _____ PUMP SETTING 70'
 PURGE VOLUME CALCULATION _____
 TIME PURGE BEGINS 856 ACTUAL AMOUNT PURGED 1900 ML pH INSTRUMENT Low flow cell

TIME	TEMP.	COND.	pH	PURGE WATER APPEARANCE/ODOR	ORP	TURBIDITY
907	24.2	1298	11.49	cloudy / slight odor	140.4	93.1
908	24.2	1299	11.49	ll ll ll	140.4	93.2
909	24.2	1299	11.49	ll ll ll	140.3	93.4

WATER SAMPLING INFORMATION **MONITORING WELL SAMPLE METHOD** B

SAMPLING DEVICE ID 1/4" Tubing SAMPLING TIME 910 APPROXIMATE DEPTH OF GRAB _____
 DATE 7-23-08

BOTTLE TYPE	NO.	VOLUME	ANALYSIS	LAB	PRESERVATION	FILTRATION
VOA	2	40ML	Methane	BCI	HCl	None
VOA	2	40ML	CO ₂ , N ₂	BCI	None	None
VOA	1	40ML	Dissolved Sulfide	BCI	None	None

DECONTAMINATION INFORMATION

PURGE DEVICE ID _____ HOSE REEL _____ SAMPLING DEVICE ID _____ HOSE REEL _____
 PREVIOUSLY USED IN WELL _____ PREVIOUSLY USED IN WELL _____
 SITE _____ SITE _____
 DECON METHOD/STEAM TIME _____ DECON METHOD/STEAM TIME _____
 RINSEATE SAMPLE YES NO ID _____ RINSEATE SAMPLE YES NO ID _____

QA/QC INFORMATION

IN SAMPLE SHIPMENT: TRAVEL BLANK YES NO ID _____ QA/QC SPIKE YES NO ID _____
 DUPLICATE YES NO ID _____ FIELD BLANK YES NO ID _____ INTER-LAB SPLIT YES NO ID _____

NOTES

DD₂₀ = 14.0
DDM₅ = 1.18

LOCUS TECHNOLOGIES WATER SAMPLING LOG

WELL/SAMPLE DESIGNATION NW-06 SITE: S.C. VTA
 SAMPLE SOURCE A DATE: 7-23-08
 AMBIENT CONDITIONS clear PROJECT#: 28006-08-0002
 SAMPLER H. Castro / T. Murphy

GRAB SAMPLE INFORMATION (use notes section for meter reading, flow rate, vol. purged etc.)

GRAB SAMPLE METHOD: _____ CONTINUOUS PUMPER YES NO pH meter: _____ FLOW RATE: _____
 PUMP CYCLING YES NO METER READING _____

WATER LEVEL INFORMATION **MEASURING POINT** **INSTRUMENT USED**

W.L. BEFORE PURGE 22.24 TIME During W.L. AFTER PURGE 22.24 TIME _____
 W.L. FOR 80% RECOVERY _____ W.L. TIME OF SAMPLE _____ DATE _____ TIME _____

MONITORING WELL PURGE INFORMATION **MONITORING WELL PURGE METHOD**

PURGE DEVICE I.D. Low flow pump CPM
 WELL DEPTH _____ DIAMETER 6" #GASING VOLUMES (PROTOCOL) 2
 SCREENED INTERVAL _____ PUMP SETTING 90'
 PURGE VOLUME CALCULATION _____
 TIME PURGE BEGINS 950 ACTUAL AMOUNT PURGED 4400ML pH INSTRUMENT Low flow cell

TIME	TEMP.	COND.	pH	PURGE WATER APPEARANCE/ODOR	ORP	TURBIDITY
1004	23.0	538	7.77	clear/no odor	80.1	58.6
1005	23.1	538	7.77	ll ll ll	80.1	58.7
1006	23.1	539	7.78	ll ll ll	80.1	58.6

WATER SAMPLING INFORMATION **MONITORING WELL SAMPLE METHOD** R

SAMPLING DEVICE ID 1/4" Tubing SAMPLING TIME 1007 APPROXIMATE DEPTH OF GRAB _____
 DATE 7-23-08

BOTTLE TYPE	NO.	VOLUME	ANALYSIS	LAB	PRESERVATION	FILTRATION
VOA	2	40ML	Methane	BCI	HCl	None
VOA	2	40ML	CO ₂ , N ₂	BCI	None	None
VOA	1	40ML	Dissolved Sulfide	BCI	None	None

DECONTAMINATION INFORMATION

PURGE DEVICE ID _____ HOSE REEL _____ SAMPLING DEVICE ID _____ HOSE REEL _____
 PREVIOUSLY USED IN WELL _____ PREVIOUSLY USED IN WELL _____
 SITE _____ SITE _____
 DECON METHOD/STEAM TIME _____ DECON METHOD/STEAM TIME _____
 RINSEATE SAMPLE YES NO ID _____ RINSEATE SAMPLE YES NO ID _____

QA/QC INFORMATION

IN SAMPLE SHIPMENT: TRAVEL BLANK YES NO ID _____ QA/QC SPIKE YES NO ID _____
 DUPLICATE YES NO ID _____ FIELD BLANK YES NO ID _____ INTER-LAB SPLIT YES NO ID _____

NOTES
DD% = 11.3
DDMg = 0.98

LOCUS TECHNOLOGIES WATER SAMPLING LOG

WELL/SAMPLE DESIGNATION ST-8 SITE: S.C. VTA
 SAMPLE SOURCE A DATE: 7-23-08
 AMBIENT CONDITIONS clear PROJECT# 28006-08-0002
 SAMPLER H. Castro / T. Murphy

GRAB SAMPLE INFORMATION (use notes section for meter reading, flow rate, vol. purged etc.)

GRAB SAMPLE METHOD: _____ CONTINUOUS PUMPER YES NO pH meter: _____ FLOW RATE: _____
 PUMP CYCLING YES NO METER READING _____

WATER LEVEL INFORMATION **MEASURING POINT** **INSTRUMENT USED**

W.L. BEFORE PURGE 23.60 TIME During W.L. AFTER PURGE 23.71 TIME _____
 W.L. FOR 80% RECOVERY _____ W.L. TIME OF SAMPLE _____ DATE _____ TIME _____

MONITORING WELL PURGE INFORMATION **MONITORING WELL PURGE METHOD**

PURGE DEVICE I.D. Low flow pump DIAMETER 4" #CASING VOLUMES (PROTOCOL) 3 ^{CPM}
 WELL DEPTH _____ PUMP SETTING 80'
 SCREENED INTERVAL _____
 PURGE VOLUME CALCULATION _____
 TIME PURGE BEGINS 1035 ACTUAL AMOUNT PURGED 4500 ML pH INSTRUMENT Low flow cell

TIME	TEMP.	COND.	pH	PURGE WATER APPEARANCE/ODOR	ORP	TURBIDITY
1042	21.8	1106	7.29	clear/ no odor	147.2	37.5
1043	21.8	1107	7.30	" "	147.3	37.5
1044	21.8	1106	7.30	" "	147.3	37.6

WATER SAMPLING INFORMATION **MONITORING WELL SAMPLE METHOD** B

SAMPLING DEVICE ID 1/4" Tubing SAMPLING TIME 1045 APPROXIMATE DEPTH OF GRAB _____
 DATE 7-23-08

BOTTLE TYPE	NO.	VOLUME	ANALYSIS	LAB	PRESERVATION	FILTRATION
VDA	2	40ML	Methane	BCI	HCl	None
VDA	2	40ML	CO ₂ , N ₂	BCI	None	None
VDA	1	40ML	Dissolved Solids	BCI	None	None

DECONTAMINATION INFORMATION

PURGE DEVICE ID _____ HOSE REEL _____ SAMPLING DEVICE ID _____ HOSE REEL _____
 PREVIOUSLY USED IN WELL _____ PREVIOUSLY USED IN WELL _____
 SITE _____ SITE _____
 DECON METHOD/STEAM TIME _____ DECON METHOD/STEAM TIME _____
 RINSE/ATE SAMPLE YES NO ID _____ RINSE/ATE SAMPLE YES NO ID _____

QA/QC INFORMATION

IN SAMPLE SHIPMENT: TRAVEL BLANK YES NO ID _____ QA/QC SPIKE YES NO ID _____
 DUPLICATE YES NO ID _____ FIELD BLANK YES NO ID _____ INTER-LAB SPLIT YES NO ID _____

NOTES
DO₂ = 10.7
DOM₂ = 0.92

LOCUS TECHNOLOGIES WATER SAMPLING LOG

WELL/SAMPLE DESIGNATION ST-1 SITE: S.C. VTA
 SAMPLE SOURCE A DATE: 7-23-08
 AMBIENT CONDITIONS Clear PROJECT#: 28006-08-0002
 SAMPLER H. Castro / T. Murphy

GRAB SAMPLE INFORMATION (use notes section for meter reading, flow rate, vol. purged etc.)

GRAB SAMPLE METHOD: _____ CONTINUOUS PUMPER YES NO pH meter: _____ FLOW RATE: _____
 PUMP CYCLING YES NO METER READING _____

WATER LEVEL INFORMATION **MEASURING POINT** **INSTRUMENT USED**

W.L. BEFORE PURGE 4.77 TIME _____ W.L. AFTER PURGE 4.98 TIME _____
 W.L. FOR 80% RECOVERY _____ W.L. TIME OF SAMPLE _____ DATE _____ TIME _____

MONITORING WELL PURGE INFORMATION **MONITORING WELL PURGE METHOD**

PURGE DEVICE I.D. Low flow pump DIAMETER 4" #CASING VOLUMES (PROTOCOL) 31
 WELL DEPTH _____ PUMP SETTING 70'
 SCREENED INTERVAL _____
 PURGE VOLUME CALCULATION _____
 TIME PURGE BEGINS 1135 ACTUAL AMOUNT PURGED 2500ML pH INSTRUMENT Low flow cell

TIME	TEMP.	COND.	pH	PURGE WATER APPEARANCE/ODOR	ORP	TURBIDITY
1152	24.5	2871	7.18	clear/no odor	48.4	10.3
1153	24.6	2873	7.19	" " "	48.4	10.3
1154	24.6	2874	7.19	" " "	48.4	10.5

WATER SAMPLING INFORMATION **MONITORING WELL SAMPLE METHOD** IS

SAMPLING DEVICE ID 1/4" Tubing SAMPLING TIME 1155 APPROXIMATE DEPTH OF GRAB _____
 DATE 7-23-08

BOTTLE TYPE	NO.	VOLUME	ANALYSIS	LAB	PRESERVATION	FILTRATION
VOA	2	40ML	Methane	BCI	HCl	None
VOA	2	40ML	CO ₂ , N ₂	BCI	None	None
VOA	1	40ML	Dissolved Sulfide	BCI	None	None

DECONTAMINATION INFORMATION

PURGE DEVICE ID _____ HOSE REEL _____ SAMPLING DEVICE ID _____ HOSE REEL _____
 PREVIOUSLY USED IN WELL _____ PREVIOUSLY USED IN WELL _____
 SITE _____ SITE _____
 DECON METHOD/STEAM TIME _____ DECON METHOD/STEAM TIME _____
 RINSEATE SAMPLE YES NO ID _____ RINSEATE SAMPLE YES NO ID _____

QA/QC INFORMATION

IN SAMPLE SHIPMENT: TRAVEL BLANK YES NO ID _____ QA/QC SPIKE YES NO ID _____
 DUPLICATE YES NO ID _____ FIELD BLANK YES NO ID _____ INTER-LAB SPLIT YES NO ID _____

NOTES

DD20 = 9.4
DDMS = 0.77

LOCUS TECHNOLOGIES WATER SAMPLING LOG

WELL/SAMPLE DESIGNATION NW-01 SITE: S.C. VTA
 SAMPLE SOURCE A DATE: 7-23-08
 AMBIENT CONDITIONS clear PROJECT#: 28006-08-0002
 SAMPLER H. Castro/T. Murphy

GRAB SAMPLE INFORMATION (use notes section for meter reading, flow rate, vol. purged etc.)

GRAB SAMPLE METHOD: _____ CONTINUOUS PUMPER YES NO pH meter: _____ FLOW RATE: _____
 PUMP CYCLING YES NO METER READING: _____

WATER LEVEL INFORMATION MEASURING POINT INSTRUMENT USED

W.L. BEFORE PURGE 19.11 TIME _____ W.L. AFTER PURGE 19.11 TIME _____
 W.L. FOR 80% RECOVERY _____ W.L. TIME OF SAMPLE _____ DATE _____ TIME _____

MONITORING WELL PURGE INFORMATION MONITORING WELL PURGE METHOD

PURGE DEVICE I.D. Low flow pump DIAMETER 6" #CASING VOLUMES (PROTOCOL) 3
 WELL DEPTH _____ PUMP SETTING 75'
 SCREENED INTERVAL _____
 PURGE VOLUME CALCULATION _____ ACTUAL AMOUNT PURGED 4500ML pH INSTRUMENT Low flow cell
 TIME PURGE BEGINS 1248

TIME	TEMP.	COND.	pH	PURGE WATER APPEARANCE/ODOR	ORP	TURBIDITY
1253	27.2	637	7.50	cloudy/slight odor	67.1	341.6
1254	27.3	638	7.52	" " "	67.1	341.8
1255	27.4	638	7.51	" " "	67.3	341.8

WATER SAMPLING INFORMATION MONITORING WELL SAMPLE METHOD IS

SAMPLING DEVICE ID 1/4" Tubing SAMPLING TIME 1257 APPROXIMATE DEPTH OF GRAB _____
 DATE 7-23-08

BOTTLE TYPE	NO.	VOLUME	ANALYSIS	LAB	PRESERVATION	FILTRATION
VOA	2	40ML	Methane	BCI	HCl	None
VOA	2	40ML	CO ₂ , N ₂	BCI	None	None
VOA	1	40ML	Dissolved Sulfide	BCI	None	None

DECONTAMINATION INFORMATION

PURGE DEVICE ID _____ HOSE REEL _____ SAMPLING DEVICE ID _____ HOSE REEL _____
 PREVIOUSLY USED IN WELL _____ PREVIOUSLY USED IN WELL _____
 SITE _____ SITE _____
 DECON METHOD/STEAM TIME _____ DECON METHOD/STEAM TIME _____
 RINSE/ATE SAMPLE YES NO ID _____ RINSE/ATE SAMPLE YES NO ID _____

QA/QC INFORMATION

IN SAMPLE SHIPMENT: TRAVEL BLANK YES NO ID _____ QA/QC SPIKE YES NO ID _____
 DUPLICATE YES NO ID _____ FIELD BLANK YES NO ID _____ INTER-LAB SPLIT YES NO ID _____

NOTES
DO₂₀ = 10.7
DDMS = 0.87

LOCUS TECHNOLOGIES WATER SAMPLING LOG

WELL/SAMPLE DESIGNATION MW-2C SITE: S.C. VTA
 SAMPLE SOURCE A DATE: 7-21-08
 AMBIENT CONDITIONS clear PROJECT#: 28006-08-0002
 SAMPLER: H. Castro/T. Murphy

GRAB SAMPLE INFORMATION (use notes section for meter reading, flow rate, vol. purged etc.)

GRAB SAMPLE METHOD: _____ CONTINUOUS PUMPER YES NO pH meter: _____ FLOW RATE: _____
 PUMP CYCLING YES NO METER READING: _____

WATER LEVEL INFORMATION **MEASURING POINT** **INSTRUMENT USED**

W.L. BEFORE PURGE 16.36 TIME _____ W.L. AFTER PURGE 16.55 TIME _____
 W.L. FOR 80% RECOVERY _____ W.L. TIME OF SAMPLE _____ DATE _____ TIME _____

MONITORING WELL PURGE INFORMATION **MONITORING WELL PURGE METHOD**

PURGE DEVICE I.D. Low flow pump DIAMETER 2" #CASING VOLUMES (PROTOCOL) 1
 WELL DEPTH _____ PUMP SETTING 98' PH INSTRUMENT Low flow cell
 SCREENED INTERVAL _____ ACTUAL AMOUNT PURGED 1900 ML

TIME	TEMP.	COND.	pH	PURGE WATER APPEARANCE/ODOR	ORP	TURBIDITY
1340	26.8	5988	12.04	cloudy/slight odor	90.1	39.0
1341	26.8	5987	12.03	ll ll ll	90.3	39.4
1342	26.7	5988	12.03	ll ll ll	90.4	39.7

WATER SAMPLING INFORMATION **MONITORING WELL SAMPLE METHOD**

SAMPLING DEVICE ID 1/4" Tubing SAMPLING TIME 1343 APPROXIMATE DEPTH OF GRAB _____ DATE 7-21-08

BOTTLE TYPE	NO.	VOLUME	ANALYSIS	LAB	PRESERVATION	FILTRATION
VOA	2	40ML	Methane	BCI	HCl	None
VOA	2	40ML	CO ₂ , N ₂	BCI	None	None
VOA	1	40ML	Dissolved Sulfide	BCI	None	None

DECONTAMINATION INFORMATION

PURGE DEVICE ID _____ HOSE REEL _____ SAMPLING DEVICE ID _____ HOSE REEL _____
 PREVIOUSLY USED IN WELL _____ PREVIOUSLY USED IN WELL _____
 SITE _____ SITE _____
 DECON METHOD/STEAM TIME _____ DECON METHOD/STEAM TIME _____
 RINSEATE SAMPLE YES NO ID _____ RINSEATE SAMPLE YES NO ID _____

QA/QC INFORMATION

IN SAMPLE SHIPMENT: TRAVEL BLANK YES NO ID _____ QA/QC SPIKE YES NO ID _____
 DUPLICATE YES NO ID _____ FIELD BLANK YES NO ID _____ INTER-LAB SPLIT YES NO ID _____

NOTES

ND₂₀ = 15.1
 ND_{MS} = 1.19

LOCUS TECHNOLOGIES WATER SAMPLING LOG

WELL/SAMPLE DESIGNATION ST-2 SITE: S.C. VTA
 SAMPLE SOURCE A DATE: 7-23-08
 AMBIENT CONDITIONS clear PROJECT#: 28006-08-0002
 SAMPLER H. Castro / T. Murphy

GRAB SAMPLE INFORMATION (use notes section for meter reading, flow rate, vol. purged etc.)

GRAB SAMPLE METHOD: _____ CONTINUOUS PUMPER YES NO pH meter: _____ FLOW RATE: _____
 PUMP CYCLING YES NO METER READING _____

WATER LEVEL INFORMATION **MEASURING POINT** **INSTRUMENT USED**

W.L. BEFORE PURGE 17.48 TIME During W.L. AFTER PURGE 17.52 TIME _____
 W.L. FOR 80% RECOVERY _____ W.L. TIME OF SAMPLE _____ DATE _____ TIME _____

MONITORING WELL PURGE INFORMATION **MONITORING WELL PURGE METHOD**

PURGE DEVICE I.D. Low flow pump DIAMETER 4" #GAGING VOLUMES (PROTOCOL) CPM #4
 WELL DEPTH _____ PUMP SETTING 30'
 SCREENED INTERVAL _____
 PURGE VOLUME CALCULATION _____
 TIME PURGE BEGINS 1402 ACTUAL AMOUNT PURGED 5100 ML pH INSTRUMENT Low flow cell

TIME	TEMP.	COND.	pH	PURGE WATER APPEARANCE/ODOR	ORP	TURBIDITY
1412	26.4	608	8.49	cloudy/no odor	64.6	50.8
1413	26.5	608	8.50	ll ll ll	64.7	50.7
1414	26.5	608	8.50	ll ll ll	64.7	50.7

WATER SAMPLING INFORMATION **MONITORING WELL SAMPLE METHOD** B

SAMPLING DEVICE ID 1/4" Tubing SAMPLING TIME 1415 APPROXIMATE DEPTH OF GRAB _____ DATE 7-23-08

BOTTLE TYPE	NO.	VOLUME	ANALYSIS	LAB	PRESERVATION	FILTRATION
VDA	2	40ML	Methane	BCI	HCl	None
VDA	2	40ML	CO ₂ , N ₂	BCI	None	None
VDA	1	40ML	Dissolved Sulfide	BCI	None	None

DECONTAMINATION INFORMATION

PURGE DEVICE ID _____ HOSE REEL _____ SAMPLING DEVICE ID _____ HOSE REEL _____
 PREVIOUSLY USED IN WELL _____ PREVIOUSLY USED IN WELL _____
 SITE _____ SITE _____
 DECON METHOD/STEAM TIME _____ DECON METHOD/STEAM TIME _____
 RINSEATE SAMPLE YES NO ID _____ RINSEATE SAMPLE YES NO ID _____

QA/QC INFORMATION

IN SAMPLE SHIPMENT: TRAVEL BLANK YES X NO ID _____ QA/QC SPIKE YES X NO ID _____
 DUPLICATE YES X NO ID _____ FIELD BLANK YES X NO ID _____ INTER-LAB SPLIT YES X NO ID _____

NOTES

DO_Z = 8.2
DDMG = 0.65

LOCUS TECHNOLOGIES WATER SAMPLING LOG

WELL/SAMPLE DESIGNATION ST-13 SITE: S.C. VTA
 SAMPLE SOURCE A DATE: 7-23-08
 AMBIENT CONDITIONS clear PROJECT# 28006-08-0002
 SAMPLER H. Castro / T. Murphy

GRAB SAMPLE INFORMATION (use notes section for meter reading, flow rate, vol. purged etc.)

GRAB SAMPLE METHOD: _____ CONTINUOUS PUMPER YES NO pH meter: _____ FLOW RATE: _____
 PUMP CYCLING YES NO METER READING _____

WATER LEVEL INFORMATION **MEASURING POINT** **INSTRUMENT USED**

W.L. BEFORE PURGE 15.76 TIME _____ W.L. AFTER PURGE 13.76 TIME _____
 W.L. FOR 80% RECOVERY _____ W.L. TIME OF SAMPLE _____ DATE _____ TIME _____

MONITORING WELL PURGE INFORMATION **MONITORING WELL PURGE METHOD**

PURGE DEVICE I.D. Low flow pump DIAMETER 4" #CASING VOLUMES (PROTOCOL) 3
 WELL DEPTH _____ PUMP SETTING 26'
 SCREENED INTERVAL _____
 PURGE VOLUME CALCULATION _____
 TIME PURGE BEGINS 1454 ACTUAL AMOUNT PURGED 3300 ML pH INSTRUMENT Low flow cell

TIME	TEMP.	COND.	pH	PURGE WATER APPEARANCE/ODOR	ORP	TURBIDITY
1457	25.5	1161	7.09	cloudy / slight odor	122.6	70.1
1458	25.6	1162	7.08	" " "	122.8	70.4
1459	25.6	1163	7.08	" " "	122.8	70.3

WATER SAMPLING INFORMATION **MONITORING WELL SAMPLE METHOD**

SAMPLING DEVICE ID 1/4" Tubing SAMPLING TIME 1500 APPROXIMATE DEPTH OF GRAB _____ DATE 7-23-08

BOTTLE TYPE	NO.	VOLUME	ANALYSIS	LAB	PRESERVATION	FILTRATION
VOA	2	40ML	Methane	BCI	HCl	None
VOA	2	40ML	CO ₂ , N ₂	BCI	None	None
VOA	1	40ML	Dissolved Sulfide	BCI	None	None

DECONTAMINATION INFORMATION

PURGE DEVICE ID _____ HOSE REEL _____ SAMPLING DEVICE ID _____ HOSE REEL _____
 PREVIOUSLY USED IN WELL _____ PREVIOUSLY USED IN WELL _____
 SITE _____ SITE _____
 DECON METHOD/STEAM TIME _____ DECON METHOD/STEAM TIME _____
 RINSE/ATE SAMPLE YES NO ID _____ RINSE/ATE SAMPLE YES NO ID _____

QA/QC INFORMATION

IN SAMPLE SHIPMENT: TRAVEL BLANK YES X NO ID _____ QA/QC SPIKE YES X NO ID _____
 DUPLICATE YES X NO ID _____ FIELD BLANK YES X NO ID _____ INTER-LAB SPLIT YES X NO ID _____

NOTES

DO₉₀ = 25.6
 DO_{M9} = 2.10

Bioremediation Consulting Inc
 39 Clarendon Street Watertown MA 02472
 phone 617-923-0976 fax 617-923-0959
 e-mail MFindlay@bcilabs.com

CHAIN OF CUSTODY RECORD

Project Name: Locus wells **Sampling Location:** SCVTA

PO 30-12362
Sampled by: H. Costello / K. Murphy

Contact: John Hawthorne hawthornej@locustec.com
 pH: 650-960-1640 fax: 650-960-0739

Instructions: Fill containers completely. No air bubble.
 each set: 2 voas. HCl-preserved: methane
 2 voas. no preservative: CO₂, N₂
 1 voa. no preservative: dissolved sulfide

Well Number	Date	VOA Vials HCl-preserved	rcv	VOA Vials No Preserv	rcv
MW-6D	7/23	2		3	
ST-11	7/23	2		3	
ST-10	7/23	2		3	
MW-4	7/23	2		3	
NW-6	7/23	2		3	
ST-8	7/23	2		3	
ST-1	7/23	2		3	
NW-01	7/23	2		3	
MW-2C	7/23	2		3	
trip blanks	7/23				

SHIP TO: Bioremediation Consulting Inc (phone 617-923-0976)
 39 Clarendon St Watertown MA 02472

Shipping Conditions:
ICE NECESSARY; however,
No Loose Ice – bag ice in leak-proof bags
Do not allow ice to contact groundwater samples

Fed Ex Priority Overnight. **NO** Saturday Delivery

Call or fax BCI at time of shipping and report the tracking number

Relinquished by H. Costello date 7-23-08

Received by _____ date _____

Bioremediation Consulting Inc
 39 Clarendon Street Watertown MA 02472
 phone 617-923-0976 fax 617-923-0959
 e-mail MFindlay@bciLabs.com

CHAIN OF CUSTODY RECORD

Project Name: Locus wells **Sampling Location:** SCVTA

PO 30-12362

Sampled by: H. Castro / K. Murphy

Contact: John Hawthorne hawthornej@locustec.com
 pH: 650-960-1640 fax: 650-960-0739

Instructions: Fill containers completely. No air bubble.
each set: 2 voas. HCl-preserved: methane
 2 voas. no preservative: CO₂, N₂
 1 voa. no preservative: dissolved sulfide

Well Number	Date	VOA Vials HCl-preserved	rev	VOA Vials No Preserv	rev
ST-7	7/22	2		3	
MW-5B	7/22	2		3	
NW-05	7/22	2		3	
ST-12	7/22	2		3	
MW-1	7/22	2		3	
MW-3C	7/22	2		3	
MW-2G	7/22	2		3	
4783	7/22	2		3	
4784	7/22	2		3	
trip blanks					

SHIP TO: Bioremediation Consulting Inc (phone 617-923-0976)
 39 Clarendon St Watertown MA 02472

Shipping Conditions:

ICE NECESSARY: however,
No Loose Ice – bag ice in leak-proof bags
Do not allow ice to contact groundwater samples

Fed Ex Priority Overnight. **NO** Saturday Delivery

Call or fax BCI at time of shipping and report the tracking number

Relinquished by H. Castro date 7-25-08

Received by _____ date _____

Bioremediation Consulting Inc
 39 Clarendon Street Watertown MA 02472
 phone 617-923-0976 fax 617-923-0959
 e-mail MFindlay@bcilabs.com

CHAIN OF CUSTODY RECORD

Project Name: Locus wells Sampling Location: SCVTA

PO 30-12362
 Sampled by: H. Castro / T. Murphy

Contact: John Hawthorne hawthornej@locustec.com
 pH: 650-960-1640 fax: 650-960-0739

Instructions: Fill containers completely. No air bubble.
 each set: 2 voas, HCl-preserved: methane
 2 voas. no preservative: CO₂, N₂
 1 voa. no preservative: dissolved sulfide

Well Number	Date	VOA Vials HCl-preserved	rcv	VOA Vials No Preserv	rcv
<u>ST-2</u>	<u>7/23</u>	2		3	
<u>ST-13</u>	<u>7/23</u>	2		3	
<u>4785</u>	<u>7/23</u>	2		3	
<u>4786</u>	<u>7/23</u>	2		3	
		2		3	
		2		3	
		2		3	
		2		3	
trip blanks					

SHIP TO: Bioremediation Consulting Inc (phone 617-923-0976)
 39 Clarendon St Watertown MA 02472

Shipping Conditions:
ICE NECESSARY: however,
No Loose Ice - bag ice in leak-proof bags
Do not allow ice to contact groundwater samples

Fed Ex Priority Overnight. **NO** Saturday Delivery

Call or fax BCI at time of shipping and report the tracking number

Relinquished by *Hey Castro* date 7/23/08

Received by _____ date _____

ATTACHMENT C

Laboratory Reports

Phase I Sampling

For Reference Only

Analytical Results

Groundwater Samples from SCVTA Site

*15 wells Sampled 5/21/08
Received 5/23/08
Analyzed 5/23/08 through 5/29/08*

5/30/08

Prepared for:

John Hawthorne
hawthornej@locustec.com 650-960-1640
Locus Technologies
299 Fairchild Drive
Mountain View CA 94043

Prepared by
Bioremediation Consulting Inc
39 Clarendon St, Watertown MA 02472
ph 617-923-0976 fx -0959 bioremediation@bciLabs.com

Groundwater Samples from SCVTA Site

15 wells Sampled 5/21/08 Received 5/23/08 Analyzed 5/23/08 through 5/29

Prepared for John Hawthorne, Locus Technologies

5/30/08

Dissolved Gasses by Gas Chromatography. Dissolved gasses were analyzed by according to EPA Method 5021A. Vials (40 ml), without preservative, were prepared for analysis by replacing 5 ml of groundwater with 5 cc Helium, using a double needle procedure through the septum, then shaken for 20 minutes to allow volatilization of gasses into the headspace. Headspace samples of 100 μ L were removed by syringe and injected directly into an HP 5890 gas chromatograph.

Argon, N₂, O₂, and CO₂ were detected by Thermal Conductivity Detector.

Methane, ethane, and ethanethiol were detected by Flame Ionization Detector.

Standards were prepared and analyzed in the same manner as samples. Compounds were identified by retention time, and quantitation was conducted using ChemStation software.

Dissolved Argon was calculated by subtracting the field O₂ readings from the combined Argon/O₂ peak on the gas chromatograph.

Dissolved O₂ by chemical test. Two samples, in 4 oz jars, were analyzed for dissolved O₂ according to Hach 8166.

Sulfide and Ammonia. VOA vials for the analysis of sulfide and ammonia were placed upright to allow sediment to settle prior to removing sub-samples for analysis. Sulfide was measured by Hach method 8131, NH₃-N by Hach method 8155. Measurements were made using a Hach Spectrophotometer. Samples were not diluted for analysis.

H₂ from Aqueous Samples. Serum bottles, 160 ml, provided pre-filled with H₂-free gas, were filled with ground water during field sampling and sealed with Teflon-coated gray rubber septa affixed with crimped caps. At BCI, using a two-needle procedure, 10 ml of water were removed while adding 10 cc of Argon, then the bottle was shaken for 20 min to allow H₂ to transfer to the headspace. A headspace sample of 5cc was removed from the 160 ml serum bottle (while injecting 5 cc degassed water) and injected directly into the H₂ Analyzer. A response factor for H₂ was obtained by analyzing a 5 ppm H₂ gas standard. The H₂ concentration originally in the ground water was calculated from the measured headspace concentration assuming a Henry's constant of 50.3. A lab blank was subtracted from the sample results prior to entering in data table.

Sample ID	4767	4768	4769	MW-2E	MW-2F	MW-3D-(r)	MW-3D-(c)-dup	MW-5A	MW-6J
Date Sampled	5/21/2008	5/21/2008	5/21/2008	5/21/2008	5/21/2008	5/21/2008	5/21/2008	5/22/2008	5/21/2008
Date Received	5/23/2008	5/23/2008	5/23/2008	5/23/2008	5/23/2008	5/23/2008	5/23/2008	5/23/2008	5/23/2008
Dissolved Gas, water matrix, Headspace GC, EPA meth 5021A									
Date Analyzed	5/23/2008	5/21/2008	5/27/2008	5/23/2008	5/23/2008	5/23/2008	5/28/2008	5/27/2008	5/27/2008
Analyst	t.s.	i.a.	i.a.	t.s.	t.s.	t.s.	i.a.	i.a.	i.a.
Methane	4.4	0.2	0.2	2.9	4.6	98	107	9.2	16
Ethane	0.3	<0.2	<0.2	<0.2	0.2	<0.2	<0.2	0.2	<0.2
Ethanol	<0.07	<0.07	<0.07	<0.07	<0.07	<0.07	<0.07	<0.07	<0.07
Argon	<2	<2	<2	<2	<2	2	1.6J	<2	<2
Nitrogen	34	15	15	33	36	34	28	25	24
Carbon monoxide	<0.5	<0.5	<0.5	<0.5	<0.5	<0.5	<0.5	<0.5	<0.5
Carbon dioxide	16	0.4	0.4	17	17	20	20	8	20
Chemical Tests									
Dates Analyzed									
Analysis	i.a./c.m	i.a./c.m	i.a./c.m	i.a./c.m	i.a./c.m	i.a./c.m		i.a./c.m	i.a./c.m
NH3-N Hach 8155	0.03	<0.02	<0.02	<0.02	<0.02	0.06		0.10	0.02
sulfide Hach 8131	0.004	<0.003	<0.003	0.007	0.005	0.008		0.003	0.010
Dissolved O2 Hach 8166	n.a.	8.3	9.8	n.a.	n.a.	n.a.		n.a.	n.a.
Dissolved H2, water matrix Reduction gas analyzer									
Date Analyzed	5/23/2008	5/23/2008	5/23/2008	5/23/2008	5/23/2008	5/23/2008		5/23/2008	5/23/2008
Analyst	t.s.	t.s.	t.s.	t.s.	t.s.	t.s.		t.s.	t.s.
Sample Dilution	/	/	/	/	/	/		/	/
Sample Result	1.6	4.9	2.8	1.1	0.9	0.4		1.0	0.5
Field DO	2.92	n.a.	n.a.	2.8	2.92	2.98		1.74	4.45

Only

Sample ID	ST-3	ST-5	TW-2B	TW-2B-dup	TW-5A	TW-6A	TW-6B	TW-8A	Trip BI
Date Sampled	5/21/2008	5/21/2008	5/21/2008	5/21/2008	5/22/2008	5/21/2008	5/21/2008	5/22/2008	5/15 prep
Date Received	5/23/2008	5/23/2008	5/23/2008	5/23/2008	5/23/2008	5/23/2008	5/23/2008	5/23/2008	5/23/2008
Dissolved Gas, water matrix,									
Headspace GC, EPA meth 5021A									
Date Analyzed	5/23/2008	5/23/2008	5/23/2008	5/21/2008	5/27/2008	5/27/2008	5/27/2008	5/23/2008	5/28/2008
Analyst	t.s.	t.s.	t.s.	i.a.	i.a.	i.a.	i.a.	t.s.	i.a.
Methane	6.9	6.1	75	70	0.5	95	0.5	31	0.6
Ethane	<0.2	<0.2	<0.2	<0.2	<0.2	0.2	<0.2	<0.2	<0.2
Ethane/ethiol	<0.7	<0.7	<0.7	<0.7	<0.7	<0.7	<0.7	<0.7	<0.7
Argon	<2	<2	<2	<2	<2	<2	<2	<2	n.a.
Nitrogen	33	32	33	29	34	24	24	33	21
Carbon monoxide	<0.5	<0.5	<0.5	<0.5	<0.5	<0.5	<0.5	<0.5	<0.5
Carbon dioxide	23	21	16	15	32	49	20	17	<0.5
Chemical Tests									
Dates Analyzed									
Analysis	i.a./c.m	i.a./c.m	i.a./c.m		i.a./c.m	i.a./c.m	i.a./c.m	i.a./c.m	i.a./c.m
NH3-N Hach 8155	<0.02	0.08	0.03		0.10	0.04	0.52	0.03	
sulfide Hach 8131	0.007	<0.003	0.014		0.005	0.005	<0.003	0.009	n.a.
Dissolved O2 Hach 8166	n.a.	n.a.	n.a.		n.a.	n.a.	n.a.	n.a.	
Dissolved H2, water matrix									
Reduction gas analyzer									
Date Analyzed	5/23/2008	5/23/2008	5/23/2008		5/23/2008	5/23/2008	5/23/2008	5/23/2008	
Analyst	t.s.	t.s.	t.s.		t.s.	t.s.	t.s.	t.s.	
Sample Dilution	1	1	1		1	1	1	1	
Sample Result	1.3	<2	0.8		0.9	0.8	1.2	0.7	
Field DO	4.01	2.62	2.58		1.81	1.37	4.98	1.97	

Bioremediation Consulting Inc
 39 Clarendon Street Watertown MA 02472
 phone 617-923-0976 fax 617-923-0959
 e-mail MFindlay@bcilabs.com

CHAIN OF CUSTODY RECORD

Project Name: Locus wells Sampling Location: SCVTA
 PO 30-12342
 Sampled by: HANK CASTRO

Contact: John Hawthorne hawthornej@locustec.com
 pH: 650-960-1640 fax: 650-960-0739

Instructions: Fill containers completely. No air bubble.
 each set: 2 voas, HCl-preserved: methane, ethane, ethanethiol
 2 voas, no preservative: Argon, O₂, CO, CO₂, N₂
 1 voa, no preservative: dissolved sulfide
 1 voa, no preservative: NH₃-N
 1 160-ml serum bottle: H₂ analyses
 2 4-oz jars: dissolved O₂

RETURN CRIMPER & PLIERS TO BCI

Well Number	Date	VOA Vials HCl-preserved	rcv	VOA Vials No Preserv	rcv	160 ml SB (contain Argon)	rcv	4 oz jars for D.O.	rcv
TW-2B	5/21/08	2	✓✓	4 ✓	✓✓✓	1	✓	2	✓✓
MW-2E	5/21/08	2	✓✓	4 ✓	✓✓✓	1	✓	2	✓✓
MW-2F	5/21/08	2	✓✓	4 ✓	✓✓✓	1	✓	2	✓✓
ST-3	5/21/08	2	✓✓	4 ✓	✓✓✓	1	✓	2	✓✓
TW-8A	5/21/08	2	✓✓	4 ✓	✓✓✓	1	✓	2	✓✓
trip blanks		1	✓	2	✓✓				
Return crimper to BCI									

SHIP TO: Bioremediation Consulting Inc (phone 617-923-0976)
 39 Clarendon St Watertown MA 02472

Shipping Conditions:
ICE NECESSARY; however,
No Loose Ice – bag ice in leak-proof bags
Do not allow ice to contact groundwater samples

Fed Ex Priority Overnight NO Saturday Delivery

Call or fax BCI at time of shipping and report the tracking number

Relinquished by [Signature] date 5/21/08
 Received by [Signature] date 5/23/08

Bioremediation Consulting Inc
 39 Clarendon Street Watertown MA 02472
 Phone 617-923-0976 fax 617-923-0959
 Email: MFindlay@bcilabs.com

CHAIN OF CUSTODY RECORD

Project Name: Locus wells Sampling Location: SCVTA
 PO 30-12342
 Sampled by: Hank Casav

Contact: John Hawthorne hawthornej@locustec.com
 pH: 650-960-1640 fax: 650-960-0739

Instructions: Fill containers completely No air bubble
 each set: 2 voas, HCl-preserved: methane, ethane, ethanethiol 50-1A
 2 voas, no preservative: Argon, O₂, CO, CO₂, N₂ → 50-21A
 1 voa, no preservative: dissolved sulfide → HACH 8131
 1 voa, no preservative: NH₃-N → HACH 8155
 1 160-ml serum bottle: H₂ analyses
 2 4-oz jars: dissolved O₂

RETURN CRIMPER & PLIERS TO BCI

Well Number	Date	VOA Vials HCl-preserved	rcv	VOA Vials No Preserv	rcv	160 ml SB (contain Argon)	rcv	4 oz jars for DO	rcv
TW-5A	5/21/08	2	✓	4 ✓✓✓	✓	1	✓	2	✓✓
MW-5A		2	✓	4 ✓✓✓	✓	1	✓	2	✓✓
TW-6A		2	✓	4 ✓✓✓	✓	1	✓	2	✓✓
TW-6B		2	✓	4 ✓✓✓	✓	1	✓	2	✓✓
MW-6J	↓	2	✓	4 ✓✓✓	✓	1	✓	2	✓✓
trip blanks									
Return crimper to BCI									

SHIP TO: Bioremediation Consulting Inc (phone 617-923-0976)
 39 Clarendon St Watertown MA 02472

Shipping Conditions:

ICE NECESSARY; however,
No Loose Ice – bag ice in leak-proof bags
Do not allow ice to contact groundwater samples

Fed Ex Priority Overnight NO Saturday Delivery

Call or fax BCI at time of shipping and report the tracking number

Relinquished by [Signature] date 5/21/08
 Received by [Signature] date 5/23/08

Bioremediation Consulting Inc
 39 Clarendon Street Watertown MA 02472
 phone 617-923-0976 fax 617-923-0959
 e-mail MFindlay@bciLabs.com

CHAIN OF CUSTODY RECORD

Project Name: Locus wells Sampling Location: SCVTA
 PO 30-12342
 Sampled by: HANK CASTRO

Contact: John Hawthorne hawthornej@locustec.com
 pH: 650-960-1640 fax: 650-960-0739

Instructions: Fill containers completely. No air bubble.
 each set: 2 voas, HCl-preserved: methane, ethane, ethanethiol
 2 voas, no preservative: Argon, O₂, CO, CO₂, N₂
 1 voa, no preservative: dissolved sulfide
 1 voa, no preservative: NH₃-N
 1 160-ml serum bottle: H₂ analyses
 2 4-oz jars: dissolved O₂

RETURN CRIMPER & PLIERS TO BCI

Well Number	Date	VOA Vials HCl-preserved	rcv	VOA Vials No Preserv	rcv	160 ml SB (contain Argon)	rcv	4 oz jars for D.O.	rcv
MW-3D(4)	5/21/08	2	✓✓	4	✓✓✓✓	1	✓	2	✓✓
ST-5	↓	2	✓✓	4	✓✓✓✓	1	✓	2	✓✓
4767		2	✓✓	4	✓✓✓✓	1	✓	2	✓✓
4768		2	✓✓	4	✓✓✓✓	1	✓	2	✓✓
4769		2	✓✓	4	✓✓✓✓	1	✓	2	✓✓
trip blanks									
Return crimper to BCI									

SHIP TO: Bioremediation Consulting Inc (phone 617-923-0976)
 39 Clarendon St Watertown MA 02472

Shipping Conditions:
ICE NECESSARY; however,
No Loose Ice – bag ice in leak-proof bags
Do not allow ice to contact groundwater samples

Fed Ex Priority Overnight. **NO** Saturday Delivery

Call or fax BCI at time of shipping and report the tracking number

Relinquished by Alamy Muzly date 5/21/08
 Received by James F. ... date 5/23/08



Gusmer Enterprises, Inc.

Locus Technologies
J. Wesley Hawthorne
299 Fairchild Drive
Mountain View, CA 94043

Account Name:
File name: LOC 8143

Phone: 1 650 960 1640
Fax: 1 650 960 0739
Email: hawthornej@locustec.com

ANALYSIS REPORT

Date Submitted: 5/23/08

Report Date: 5/27/08

Sample	Test	Result
TW-2B	Free SO2 (Skalar)	< 5 ppm
	Total SO2 (Skalar)	< 5 ppm
MW-2E	Free SO2 (Skalar)	< 5 ppm
	Total SO2 (Skalar)	< 5 ppm
MW-2F	Free SO2 (Skalar)	< 5 ppm
	Total SO2 (Skalar)	< 5 ppm
ST-3	Free SO2 (Skalar)	< 5 ppm
	Total SO2 (Skalar)	< 5 ppm
TW-8A	Free SO2 (Skalar)	< 5 ppm
	Total SO2 (Skalar)	< 5 ppm
MW-3D(r)	Free SO2 (Skalar)	< 5 ppm
	Total SO2 (Skalar)	< 5 ppm
ST-5	Free SO2 (Skalar)	< 5 ppm
	Total SO2 (Skalar)	< 5 ppm
4767	Free SO2 (Skalar)	< 5 ppm
	Total SO2 (Skalar)	< 5 ppm
4768	Free SO2 (Skalar)	< 5 ppm
	Total SO2 (Skalar)	< 5 ppm
4769	Free SO2 (Skalar)	< 5 ppm
	Total SO2 (Skalar)	< 5 ppm

Results apply to samples as received.

1 of 2 6/2/2008 11:18 AM

81 M st.
Fresno, CA 93721
Tel: 559 485 2692
Fax: 559 485 4254

640 Airpark Rd., Suite D
Napa, CA 94558
Tel: 707 224 7903
Fax: 707 255 2019

1165 Globe Ave.
Mountainside, NJ 07092
Tel: 908 301 1811
Fax: 908 301 1812

1401 Ware St.
Waupaca, WI 54981
Tel: 715 258 5525
Fax: 715 258 8488

"Service With Knowledge"® Since 1924

See disclaimer on cover page.



TW-5A	Free SO2 (Skalar)	< 5 ppm
	Total SO2 (Skalar)	< 5 ppm
MW-5A	Free SO2 (Skalar)	< 5 ppm
	Total SO2 (Skalar)	< 5 ppm
TW-6A	Free SO2 (Skalar)	< 5 ppm
	Total SO2 (Skalar)	< 5 ppm
TW-6B	Free SO2 (Skalar)	< 5 ppm
	Total SO2 (Skalar)	< 5 ppm
MW-6J	Free SO2 (Skalar)	< 5 ppm
	Total SO2 (Skalar)	< 5 ppm

Signed:

David A. Jeffrey, Enologist

For Reference Only

Results apply to samples as received.

2 of 2 6/2/2008 11:18 AM

81 M st.
Fresno, CA 93721
Tel: 559 485 2692
Fax: 559 485 4254

640 Airpark Rd., Suite D
Napa, CA 94558
Tel: 707 224 7903
Fax: 707 255 2019

1165 Globe Ave.
Mountainside, NJ 07092
Tel: 908 301 1811
Fax: 908 301 1812

1401 Ware St.
Waupaca, WI 54981
Tel: 715 258 5525
Fax: 715 258 8488

ATTACHMENT D

Laboratory Reports

Phase 2 Sampling

For Reference Only

Analytical Results

Groundwater Samples from SCVTA Site

*Sampled 7/22 & 7/23/08
Received 7/24/08
Analyzed 7/24/08 through 7/29/08*

7/31/08

Prepared for:

John Hawthorne
hawthornej@locustec.com 650-960-1640
Locus Technologies
299 Fairchild Drive
Mountain View CA 94043

Prepared by

Bioremediation Consulting Inc
39 Clarendon St, Watertown MA 02472
ph 617-923-0976 fx -0959 bioremediation@bciLabs.com

Groundwater Samples from SCVTA Site

Sampled 7/22 & 7/23/08 Received 7/24/08 Analyzed 7/24 through 7/29/08

Prepared for John Hawthorne, Locus Technologies

7/31/08

Dissolved Gasses by Gas Chromatography. Dissolved gasses were analyzed by according to EPA Method 5021A. For the analysis of N₂ and CO₂, vials (40 ml) without preservative were prepared for analysis by replacing 5 ml of groundwater with 5 cc Helium, using a double needle procedure through the septum, then shaken for 20 minutes to allow volatilization of gasses into the headspace. For the analysis of methane, vials with HCl as preservative were prepared for analysis in the same manner. Headspace samples of 100 µL were removed by syringe and injected directly into an HP 5890 gas chromatograph.

N₂ and CO₂ were detected by Thermal Conductivity Detector.

Methane was detected by Flame Ionization Detector.

Standards were prepared and analyzed in the same manner as samples. Compounds were identified by retention time, and quantitation was conducted using ChemStation software.

Sulfide. VOA vials, unpreserved, were placed upright to allow sediment to settle prior to removing sub-samples for analysis. Samples were analyzed within one day of receipt by BCI. Sulfide was measured by Hach method 8131 and measurements were made using a Hach Spectrophotometer.

Sample ID	4783	4784	4785	4786	MW-1	MW-5B	MW-6D
Date Sampled	7/22/2008	7/22/2008	7/23/2008	7/23/2008	7/22/2008	7/22/2008	7/23/2008
Date Received	7/24/2008	7/24/2008	7/24/2008	7/24/2008	7/24/2008	7/24/2008	7/24/2008
Dissolved Gas, water matrix,							
Headspace GC, EPA meth 5021A							
Date Analyzed	7/28/2008	7/25/2008	7/25/2008	7/29/2008	7/24/2008	7/24/2008	7/25/2008
Analyst	t.s.	t.s.	t.s.	t.s.	t.s.	t.s.	t.s.
Methane	35	0.7	1.8	1.0	0.5	0.9	1.9
Nitrogen	27	15	22	18	17	28	21
Carbon dioxide	23	<0.2	66	<0.2	1.5	37	72
Chemical Test							
Dates Analyzed	7/24/2008	7/25/2008	7/25/2008	7/24/2008	7/24/2008	7/24/2008	7/25/2008
Analysts	i.a.	i.a.	i.a.	i.a.	i.a.	i.a.	i.a.
sulfide Hach 8131	0.012	<0.01	0.017	<0.01	0.019	<0.01	0.010
Sample ID	MW-2C	MW-2G	MW-3C	MW-4A	MW-4A lab dup	ST-1	ST-2
Date Sampled	7/23/2008	7/22/2008	7/22/2008	7/23/2008	7/23/2008	7/23/2008	7/23/2008
Date Received	7/24/2008	7/24/2008	7/24/2008	7/24/2008	7/24/2008	7/24/2008	7/24/2008
Dissolved Gas, water matrix,							
Headspace GC, EPA meth 5021A							
Date Analyzed	7/29/2008	7/28/2008	7/24/2008	7/25/2008	7/25/2008	7/29/2008	7/29/2008
Analyst	t.s.	t.s.	t.s.	t.s.	t.s.	t.s.	t.s.
Methane	7.7	39	9.9	8.3	8.2	2.0	31
Nitrogen	32	26	35	24	24	28	22
Carbon dioxide	<0.2	24	22	<0.2	<0.2	38	3.7
Chemical Test							
Dates Analyzed	7/24/2008	7/24/2008	7/24/2008	7/25/2008	7/25/2008	7/25/2008	7/24/2008
Analysts	i.a.	i.a.	i.a.	i.a.	i.a.	i.a.	i.a.
sulfide Hach 8131	<0.01	0.028	<0.01	0.033	<0.01	<0.01	0.017

Sample ID	NW-01	NW-05	NW-6	ST-10	ST-11	ST-12	ST-13	Trip BI
Date Sampled	7/23/2008	7/22/2008	7/23/2008	7/23/2008	7/23/2008	7/22/2008	7/23/2008	prep 7/16
Date Received	7/24/2008	7/24/2008	7/24/2008	7/24/2008	7/24/2008	7/24/2008	7/24/2008	7/24/2008
Dissolved Gas, water matrix,								
HeadSpace GC, EPA meth 5021A								
Date Analyzed	7/29/2008	7/24/2008	7/29/2008	7/25/2008	7/25/2008	7/24/2008	7/29/2008	7/29/2008
Analyst	t.s.	t.s.	t.s.	t.s.	t.s.	t.s.	t.s.	t.s.
Methane	2.0	2.1	2.1	0.1	0.4	1.0	1.0	0.4
Nitrogen	35	20	26	27	27	23	27	29
Carbon dioxide	11	2.7	12	17	17	110	56	0.7
Chemical Test								
Dates Analyzed	7/25/2008	7/24 & 7/25	7/25/2008	7/25/2008	7/25/2008	7/24/2008	7/24/2008	7/25/2008
Analysts	i.a.	i.a.	i.a.	i.a.	i.a.	i.a.	i.a.	i.a.
sulfide Hach 8131	0.025	<0.1 (1)	0.011	<0.01	<0.01	<0.01	0.015	<0.01
(1) interference from turbidity;								
Hach turbidity interference correction procedure unsuccessful								
Sample ID								
Date Sampled	7/22/2008	7/23/2008	7/23/2008	7/23/2008	7/23/2008	7/23/2008	7/23/2008	7/23/2008
Date Received	7/24/2008	7/24/2008	7/24/2008	7/24/2008	7/24/2008	7/24/2008	7/24/2008	7/24/2008
Dissolved Gas, water matrix,								
HeadSpace GC, EPA meth 5021A								
Date Analyzed	7/24/2008	7/28/2008	7/28/2008	7/28/2008	7/28/2008	7/28/2008	7/28/2008	7/28/2008
Analyst	t.s.	t.s.	t.s.	t.s.	t.s.	t.s.	t.s.	t.s.
Methane	1.5	1.7	1.3	1.3	1.3	1.3	1.3	1.3
Nitrogen	31	37	37	37	37	37	37	37
Carbon dioxide	29	31	31	31	31	31	31	31
Chemical Test								
Dates Analyzed	7/24/2008	7/25/2008	7/25/2008	7/25/2008	7/25/2008	7/25/2008	7/25/2008	7/25/2008
Analysts	i.a.	i.a.	i.a.	i.a.	i.a.	i.a.	i.a.	i.a.
sulfide Hach 8131	<0.01	<0.01	<0.01	<0.01	<0.01	<0.01	<0.01	<0.01

Bioremediation Consulting Inc
 39 Clarendon Street Watertown MA 02472
 phone 617-923-0976 fax 617-923-0959
 e-mail: MFindlay@bcilabs.com

CHAIN OF CUSTODY RECORD

Project Name: Locus wells Sampling Location: SCVTA

PO 30-12362

Sampled by: H. Castro / K. Murphy

Contact: John Hawthorne hawthornej@locustec.com

PH: 650-960-1640 fax: 650-960-0739

Instructions: Fill containers completely. No air bubble.
 each set: 2 voas, HCl-preserved: methane
 2 voas, no preservative: CO₂, N₂
 1 voa. no preservative: dissolved sulfide

Well Number	Date	VOA Vials HCl-preserved	rcv	VOA Vials No Preserv	rcv
ST-7	7/22	2	2	3	3
MW-5B	7/22	2	2	3	3
NW-05	7/22	2	2	3	3
ST-12	7/22	2	2	3	3
MW-1	7/22	2	2	3	3
MW-3C	7/22	2	2	3	3
MW-2G	7/22	2	2	3	3
4783	7/22	2	2	3	3
4784	7/22	2	2	3	3
trip blanks		2	2	2	2

SHIP TO: Bioremediation Consulting Inc (phone 617-923-0976)
 39 Clarendon St Watertown MA 02472

Shipping Conditions:

ICE NECESSARY; however,

No Loose Ice – bag ice in leak-proof bags

Do not allow ice to contact groundwater samples

Fed Ex Priority Overnight. **NO** Saturday Delivery

Call or fax BCI at time of shipping and report the tracking number

Relinquished by [Signature] date 7/23/08

Received by [Signature] date 7/24/08

Bioremediation Consulting Inc
 39 Clarendon Street Watertown MA 02472
 phone 617-923-0976 fax 617-923-0959
 e-mail MFindlay@bciLabs.com

CHAIN OF CUSTODY RECORD

Project Name: Locus wells Sampling Location: SCVTA
 PO 30-12362

Sampled by: H. Costello / K. Murphy

Contact: John Hawthorne hawthornej@locustec.com
 pH: 650-960-1640 fax: 650-960-0739

Instructions: Fill containers completely. No air bubble.
 each set: 2 voas, HCl-preserved: methane
 2 voas, no preservative: CO₂, N₂
 1 voa. no preservative: dissolved sulfide

Well Number	Date	VOA Vials HCl-preserved	rcv	VOA Vials No Preserv	rcv
MW-6D	7/23	2	2	3	3
ST-11	7/23	2	2	3	3
ST-10	7/23	2	2	3	3
MW-4	7/23	2	2	3	3
NW-6	7/23	2	2	3	3
ST-8	7/23	2	2	3	3
ST-1	7/23	2	2	3	3
NW-01	7/23	2	2	3	3
MW-2C	7/23	2	2	3	3
trip blanks	7/23				

+2 +3 (4)
 MW4A (5)

SHIP TO: Bioremediation Consulting Inc (phone 617-923-0976)
 39 Clarendon St Watertown MA 02472

Shipping Conditions:
ICE NECESSARY: however,
No Loose Ice - bag ice in leak-proof bags
Do not allow ice to contact groundwater samples

Fed Ex Priority Overnight. NO Saturday Delivery

Call or fax BCI at time of shipping and report the tracking number

Relinquished by [Signature] date 7-23-08

Received by [Signature] date 7-24-08

Bioremediation Consulting Inc
 39 Clarendon Street Watertown MA 02472
 phone 617-923-0976 fax 617-923-0959
 e-mail MFindlay@bcilabs.com

CHAIN OF CUSTODY RECORD

Project Name: Locus wells Sampling Location: SCVTA

PO 30-12362
 Sampled by: H. Castro / T. Murphy

Contact: John Hawthorne hawthornej@locustec.com
 pH: 650-960-1640 fax: 650-960-0739

Instructions: Fill containers completely. No air bubble.
 each set: 2 voas, HCl-preserved: methane
 2 voas, no preservative: CO₂, N₂
 1 voa, no preservative: dissolved sulfide

Well Number	Date	VOA Vials HCl-preserved	rcv	VOA Vials No Preserv	rcv
<u>ST-2</u>	<u>7/23</u>	2	2	3	3
<u>ST-13</u>	<u>7/23</u>	2	2	3	3
<u>4785</u>	<u>7/23</u>	2	0	3	0
<u>4786</u>	<u>7/23</u>	2	2	3	3
		2		3	
		2		3	
		2		3	
		2		3	
trip blanks					

dup of MW6D-194

SHIP TO: Bioremediation Consulting Inc (phone 617-923-0976)
 39 Clarendon St Watertown MA 02472

Shipping Conditions:
ICE NECESSARY: however,
No Loose Ice - bag ice in leak-proof bags
Do not allow ice to contact groundwater samples

Fed Ex Priority Overnight. NO Saturday Delivery

Call or fax BCI at time of shipping and report the tracking number

Relinquished by Hez Castro date 7-23-08

Received by Tom Findlay date 7-24-08

For Reference Only

Appendix 11: Soil Abrasion Test Results

For Reference Only

**SINTEF****SINTEF Building and Infrastructure**
Rock and Soil Mechanics

Address: NO-7465 Trondheim, NORWAY

Location: R. Birkelands vei 3
Telephone: +47 73 59 46 00
Fax: +47 73 59 47 78Location: Høgskoleingen 7a
Telephone: +47 73 59 46 00
Fax: +47 73 59 53 40

Enterprise No: NO 948 007 029 MVA

TEST REPORT

CLIENT(S)

HMM/Bechtel
SVRT Project
Hynix Building
3331 North First Street (Bldg. A)
San Jose, CA 95134
USA

CLIENTS REF

Dinesh C. Mathur/Abhishek Jain

SAMPLE MATERIAL

Four soil samples

SCOPE OF WORK

SAT - Soil Abrasion Testing, Atterbergs Limits

REPORT/JOURNAL NO.	CLASSIFICATION	PERSON RESPONSIBLE (NAME, SIGN.)	
08043 IG	Confidential	Pål Drevland Jakobsen	
PROJECT NO.	DATE	DISCIPLINARY RESPONSIBLE (NAME, SIGN.)	NO. OF PAGES
3C0097.00	02.10.08	Filip Dahl	15

DETERMINATION OF ABRASIVITY PROPERTIES OF FOUR SOIL SAMPLES FROM THE SILICON VALLEY RAPID TRANSPORT (SVRT) PROJECT

SINTEF Building and Infrastructure, Rock and Soil Mechanics received four samples, consisting of soil, from the Client on August 11, 2008.

The samples were analysed by use of the Soil Abrasion Test (SAT) in order to determine abrasivity properties. The testing was performed in accordance with Nilsen, B., Dahl, F., Holzhäuser, J. and Raleigh, P. (2007): "New test methodology for estimating the abrasiveness of soils for TBM tunnelling", RETC Proceedings, 104 - 116.

One of the samples was additionally analysed according to the Norwegian Standards NS 8001 and NS 8003 in order to determine Atterbergs Limits.

The laboratory testing was conducted during the period from August 12 to September 9, 2008.

CONTENT

Table of samples of soils received for testing.....	Page 3
Test results.....	Page 4
Methodology and procedure for the Soil Abrasion Test (SAT).....	Page 5 - 9
Comments and remarks on SAT testing and test results.....	Page 10 - 11
Photographs of the samples prior to preparation.....	Page 12 - 15

For Reference Only

TABLE OF SAMPLES OF SOIL RECEIVED FOR TESTING
(Given by the Client)

Sample No.	Boring Number (Sample I.D.)	Soil type	Depth Interval (ft)
1	BH-12/S-6	CL	55 – 57.5
2	BH-31/S-4	SC	53.5 – 56
3	MW-61	SP-SM	69 – 70
4	MW-8B	GW	25.5 – 28

For Reference Only

TEST RESULTS

Basis SAT: "New test methodology for estimating the abrasiveness of soils for TBM tunnelling", RETC 2007 Proceedings, 104 - 116.

Basis Atterbergs Limits: NS 8001 and NS 8003

Sample No. (given by the Client)	1	2	3	4
Sample ID. (given by the Client)	BH-12/S-6	BH-31/S-4	MW-61	MW-8B
Soil Abrasion Test				
SAT Test 1	1	22	21	18
SAT Test 2	0	24	25	20
SAT Test 3	-	-	23	16
SAT (Mean)	0.5	23.0	23.0	18.0
Percentage of the total sample < 4.0 mm after preparation	100.0 %	92.6 %	99.1 %	91.1 %
Percentage of the total sample < 1.0 mm after preparation	100.0 %	81.7 %	84.7 %	51.9 %
Atterbergs Limits				
w _l	63.9 %	-	-	-
w _p	30.1 %	-	-	-
I _p	33.8 %	-	-	-

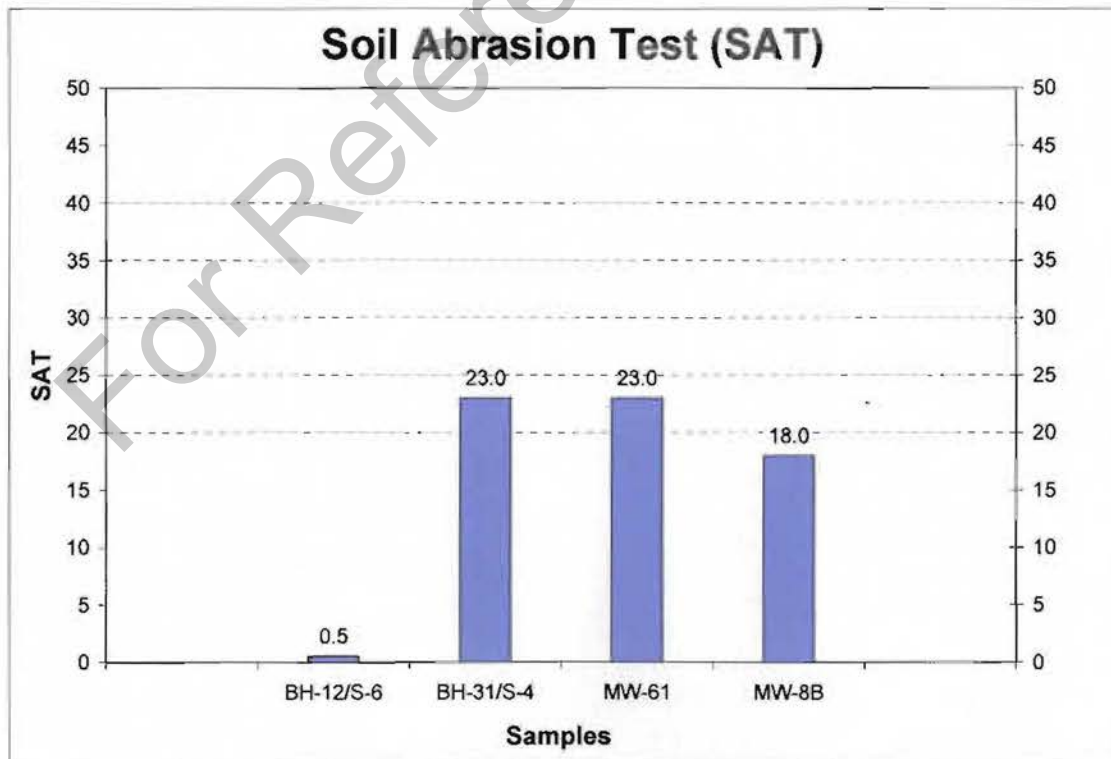

Figure 1. The SAT results presented as bar graph.

METHODOLOGY AND TEST PROCEDURE FOR THE SOIL ABRASION TEST (SAT)

The abrasivity of the received soil samples was tested by use of the Soil Abrasion Test (SAT). The Soil Abrasion Test is a further development of the existing Abrasion Value (AV) and Abrasion Value Cutter Steel (AVS) tests for rock. Compared to the AVS test, only one detail has been changed: instead of crushed rock powder <1 mm, a sieved soil sample with grain size < 4 mm is used in the SAT test. The initial SAT tests were performed with an upper grain size limit of 1 mm (Nilsen et al. 2006a to c), but this has now by a modification of the original test pieces, as shown in figure 2 and 3, been increased to 4 mm (Nilsen et al. RETC 2007).

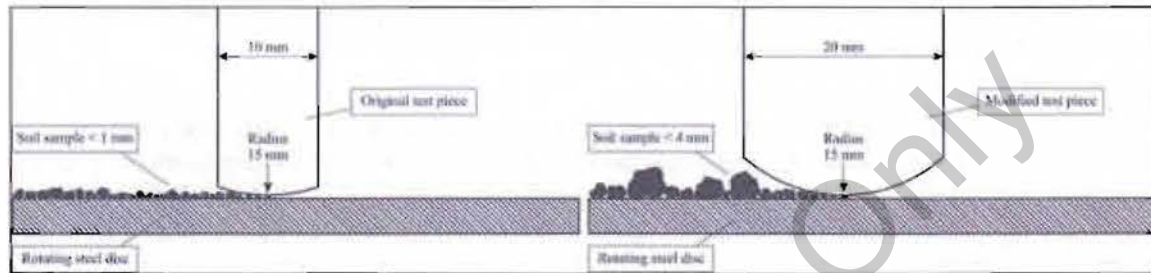

Figure 2. The original (left) and modified (right) SAT test pieces.



Figure 3. Photo showing two original AVS (to the left) and two modified SAT test pieces (to the right).

Preparation of soil samples

To enable comparison with previous test results and to take advantage of the extensive NTNU database, it is considered important to follow the standardized NTNU abrasion test procedures as closely as possible. The following preparation of soil samples is therefore recommended:

In order to reduce or avoid changes of the original properties, soil samples should be dried gently in a ventilated oven at 30° C for 2 - 3 days.

The following techniques should be used after drying in order to disintegrate and separate the particles for the abrasion powder:

1. Disintegration with a soft hammer (plastic head).
2. Sieving with steel balls as gentle milling/disintegration aid. The sample material is sieved on 4.0 mm and 1.0 mm sieves. 20 small steel balls with individual weight 14 g and diameter 15 mm are added to each sieve.
3. Crushing by use of jaw crushers (type and opening depending on the size of the lumps): Initial disintegration of samples which contains very hard lumps of cohesive material after drying. Crushing of intact grains should be avoided.

The disintegrated material should be sieved on 1 mm and 4 mm in order to verify the grain size distribution after preparation. SAT testing of the sieved fraction < 4.0 mm is then carried out according to the same procedures as for AVS testing (*see pages 8 - 9*) and the SAT value is calculated as the mean value of the measured weight loss in mg (to be accepted, the results of 2 - 4 parallel tests should not deviate by more than 5 units).

SAT testing in progress is illustrated in Figure 5 and examples of the appearance of test pieces after completed tests are shown in Figure 6.



Figure 4. Overview photo showing the general layout of the SAT rig.

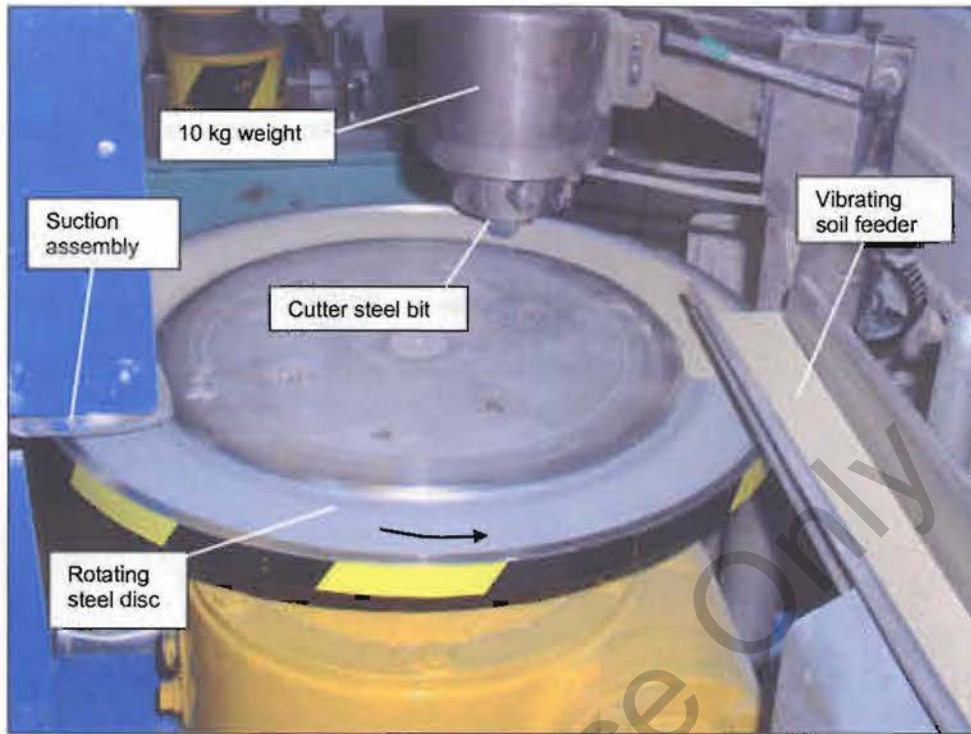

Figure 5. Close up photo taken during testing. The test piece which is clamped under the 10 kg weight is running on sample material supplied to the rotating disc by the vibrating feeder.

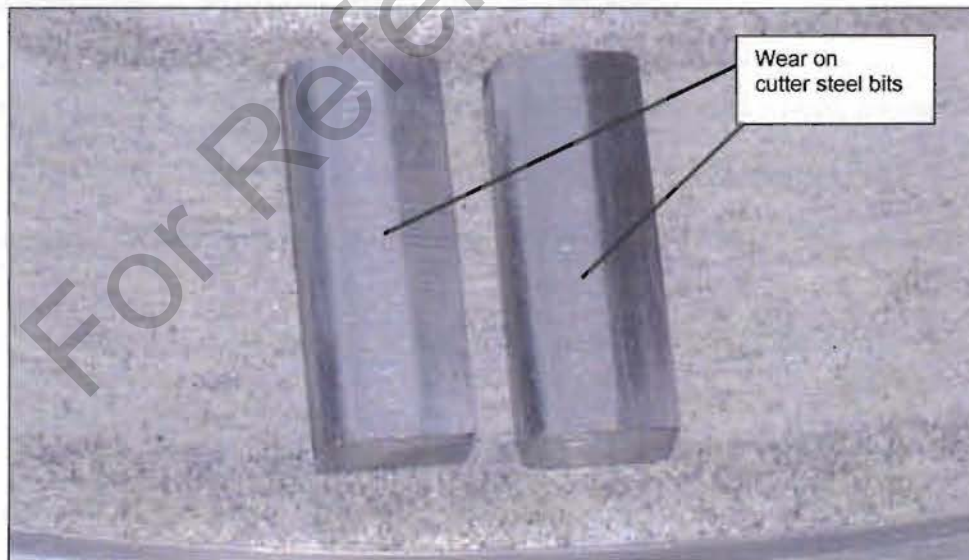

Figure 6. Abrasion of test pieces ($L = 30$ mm) after Soil Abrasion Test (SAT) (minimum 2 test runs per soil sample).

Test procedures for determination of Abrasion Value (AV), Abrasion Value Cutter Steel (AVS) and Soil Abrasion Test (SAT)

An outline of the principle for the Abrasion tests and specification of measurements for the test bits are given in Figure 7 and Figure 1 (modified SAT test pieces).

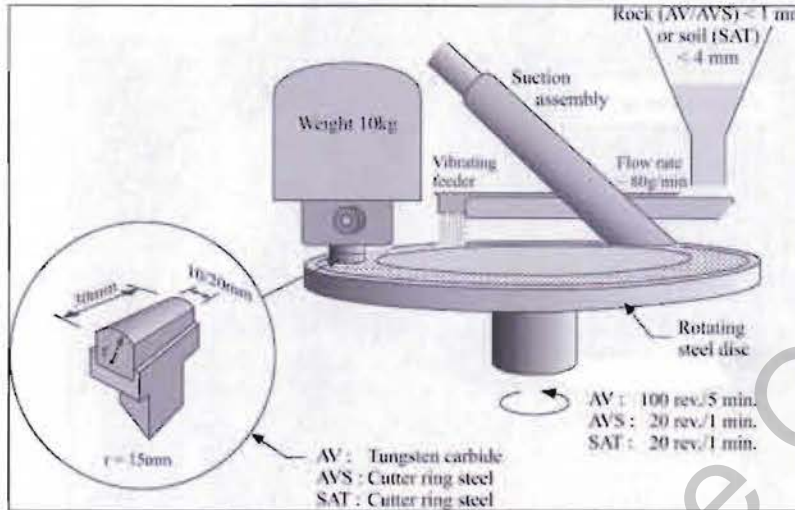

Figure 7. Abrasion Value, Abrasion Value Cutter Steel and Soil Abrasion tests.

Abrasion Value (AV)

Prepare 2 - 4 numbered tungsten carbide test pieces by grinding them to the specified dimensions.

Note:

Grinding of the test surface is a critical step and extra care is important in order to avoid overheating.

Visually examine the test surface and make sure that it is smooth and straight after grinding.

Polish the edges of the test surface by a hone and ensure that the test bit is absolutely clean and dry before weighing.

Weigh the test piece separately to the nearest 0.001g and note the number of the test piece and corresponding weight.

Secure a test piece to the weight and place it gently on the steel disc (*see Figure 5*).

Verify that the test surface is horizontally aligned with the steel disc, and if necessary, adjust the clamping of the test piece and the suspension of the weight.

Start the test and run it for 5 minutes, i.e. 100 revolutions. Verify whether the amount of abrasion powder fed onto the steel disc is sufficient or excessive. Adjust the vibrating feeder in order to avoid steel against steel abrasion or a pile of powder in front of the test piece. Make sure that the test piece runs in the middle of the track and that a single point of it does not bear directly against the steel disc.

Loosen the test piece from the weight and rinse and dry thoroughly before weighing.

Note the weight and calculate the weight loss in mg.

Run 2 - 4 parallel tests. The results shall not deviate by more than 5 units.

The Abrasion Value (AV) is calculated as the mean value of the measured weight loss in milligrams after 5 minutes testing time, i.e. 100 revolutions.

Abrasion Value Cutter Steel (AVS) and Soil Abrasion Test (SAT)

Prepare 2 - 4 numbered cutter ring test pieces by grinding them to the specified dimensions.

Follow the steps given for Abrasion Value (AV), apart from the testing time.

Note:

The testing time for the Abrasion Value Cutter Steel (AVS) and Soil Abrasion Test (SAT) are 1 min, i.e. 20 revolutions.

The Abrasion Value Cutter Steel (AVS) and Soil Abrasion Test (SAT) are calculated as the mean value of the measured weight loss in milligrams after 1 minute testing time, i.e. 20 revolutions.

References

Nilsen, B., Dahl, F., Holzhäuser, J., Raleigh, P. (2006a): Abrasivity of soils in TBM tunnelling. *Tunnels & Tunnelling International*, March 2006, 36 - 38.

Nilsen, B., Dahl, F., Holzhäuser, J., Raleigh, P. (2006b): Abrasivity testing for rock and soils. *Tunnels & Tunnelling International*, April 2006, 47 - 49.

Nilsen, B., Dahl, F., Holzhäuser, J., Raleigh, P. (2006c): SAT: NTNU's new soil abrasion test. *Tunnels & Tunnelling International*, May 2006, 43 - 45.

Nilsen, B., Dahl, F., Holzhäuser, J., Raleigh, P. (2007): New test methodology for estimating the abrasiveness of soils for TBM tunneling. *RETC 2007 Proceedings*, 104 - 116.

COMMENTS AND REMARKS ON SAT TESTING AND TEST RESULTS

The percentages of sample material < 1.0 mm and < 4.0 mm which are given in the tables on page 4 are subsequent to preparation according to the given procedures.

All samples were tested on the sieved portion < 4.0 mm by use of modified SAT pieces. These samples have all an original portion of particles < 4.0 mm which constitutes higher than 90 % of the total sample volume. The SAT values for these samples can hence be regarded as very representative.

There is currently no available classification for SAT values. The SAT is however based on the AVS test and the classification (*see Table 1.*) based on the so far 1747 recorded test results from this test are useful also for describing/evaluating the abrasiveness of soils.

Category	Cumulative %	AVS
Extremely low	0-5%	<1
Very low	5-15%	2-3
Low	15-35%	4-12
Medium	35-65%	13-25
High	65-85%	26-35
Very high	85-95%	36-44
Extremely high	95-100%	>44

Table 1. Classification of AVS for rock samples.

A summary of soil samples tested by use of AVS and SAT per April 2008 is shown in Figure 8.

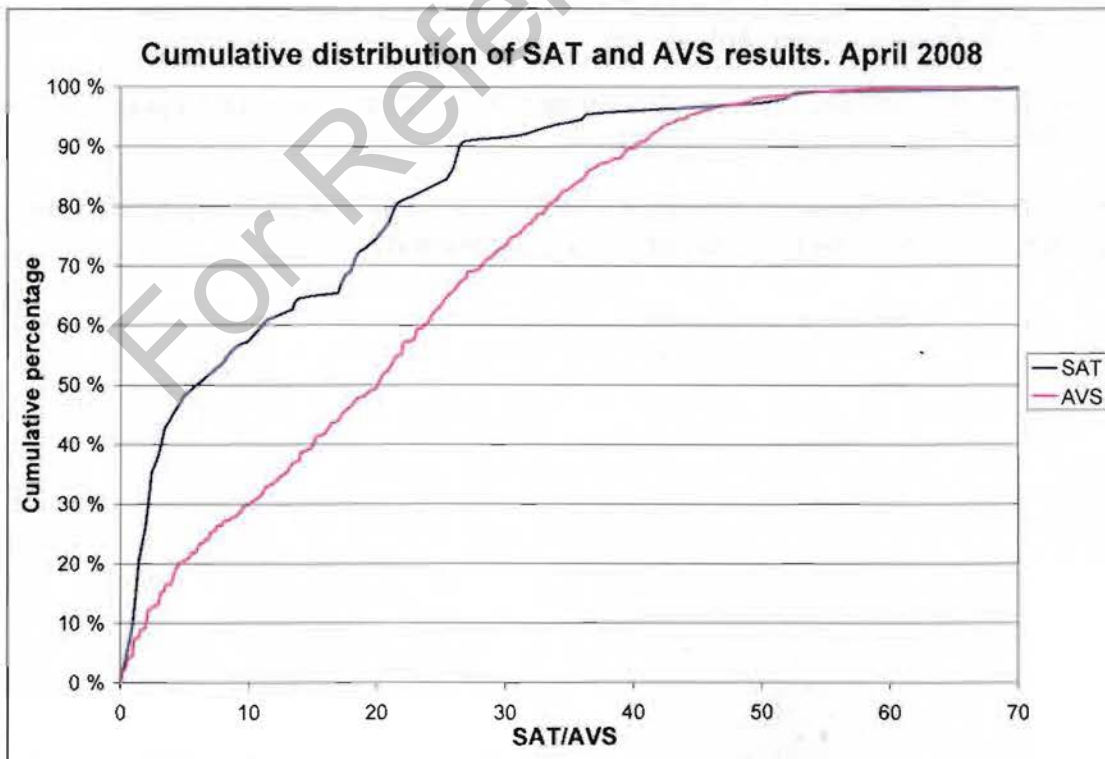

Figure 8. Cumulative distribution of AVS and SAT results. The distribution curves are based on the results from 1747 AVS and 115 SAT tests recorded so far in our database.

Tunnelling in soil is quite different from TBM hard rock excavation, and it is therefore not possible to use the SAT results directly for estimation of wear of cutter tools. There is however evidently similarities concerning cutter tool abrasion, and useful indications of the abrasiveness of soil samples could be obtained by comparing the results with the results for rock. The SAT is therefore believed to represent a great potential for describing/evaluating the abrasiveness of soils.

Based on rock testing, the content of quartz and other hard minerals like garnet and epidote have a major impact on the abrasion on the test pieces, but grain shape and grain binding may also contribute substantially.

In Table 2, AVS results for some sedimentary rocks tested at SINTEF are shown, illustrating that there is a considerable difference in AVS values between the softest (i.e. limestone) and hardest (i.e. quartzite) rocks. As also shown, the AVS value may differ significantly within one type of rock.

Rock type	Number of samples	AVS
Limestone	17	0.2 – 1.4
Shale	17	0.4 – 10
Siltstone	4	0.4 – 44
Sandstone	36	0.4 – 52
Quartzite	20	17 – 63

Table 2. AVS values for some sedimentary rock samples tested at SINTEF

For quality control, calibration of the test apparatus is performed at regular intervals (normally every 9 -12 months) by use of reference samples from three different rock types.

Rock type	AVS category	AVS test results ^{*)} Calibration	Acceptance range for AVS calibration
Quartzite (Metamorphic sandstone) 98% quartz	Extremely high	58	55 – 60
Trondhjemite (Tonalite) 25% quartz, 30% alkali feldspar, 15% plagioclase, 19% mica	Very high	37	35 – 40
Limestone (Jura limestone) 99% carbonate (calcite)	Extremely low	0.5	0 – 1

^{*)} Mean value of 4 separate tests

Table 3. The most recent calibration performed by use of reference samples.

“Steel against steel” testing (running the test without abrasion powder) show no measurable abrasion on the test pieces.

PHOTOGRAPHS OF THE SAMPLES PRIOR TO PREPARATION



Sample No. 1, BH-12/S-6. SAT powder was prepared by use of soft hammer and sieving with steel balls. Of the total sample volume, 100.0 % was < 1.0 mm after preparation.



Sample No. 2, BH-31/S-4. SAT powder was prepared by sieving with steel balls. Of the total sample volume, 92.6 % was < 4 mm and 81.7 % was < 1.0 mm after preparation.



Sample No. 3, MW-61. SAT powder was prepared by sieving with steel balls. Of the total sample volume, 99.1 % was < 4 mm and 84.7 % was < 1.0 mm after preparation.



Sample No. 4, MW-8B. SAT powder was prepared by sieving with steel balls. Of the total sample volume, 91.1 % was < 4 mm and 51.9 % was < 1.0 mm after preparation.

Soil Abrasion Test

(SAT: NTNU's new soil abrasion test,
Tunnels & Tunnelling International,
May 2006, 43-45)



The University of Texas at Austin

**Geotechnical Engineering Center
Department of Civil, Architectural
and Environmental Engineering**

Project name	Silicon Valley Rapid Transit Project
project No.	ADM 329
UT reference	2008_HMM/Bechtel_001_01
Test Date	09/08/2008
Tested by	Seung Han Kim

Sample moisture condition	Dried in ventilated oven at 30°C for 3 days
Steel test piece condition	Ground and polished by bench grinder, 20 mm test piece
Boring number	MW-8B
Sample top depth	25.5 ft
USCS soil type	GP-GM

Result of Soil Abrasion Test (2 cm test piece, passing 4 mm sieve)

Portion No.	1		2	
Sample description	Soil fraction less than 4 mm without gravel size particles		Soil fraction less than 4 mm with gravel size particles crushed to less than 4 mm	
Test No.	A	B	A	B
Test piece weight loss (mg)	6	4	4	5
AVS	5		4.5	

Photographs of the sample



Note:

Refer to the next page to have the result of SAT using 1 cm test pieces and samples crushed to less than 1 mm.

301 East Dean Keaton building ECJ B220 1 University Station C1792, Austin TX 78712 USA	Dr. Fulvio Tonon Phone: +1-512-471-4929 Fax: +1-512-471-6548
---	--

Soil Abrasion Test

(SAT: NTNU's new soil abrasion test, Tunnels & Tunnelling International, May 2006, 43-45)



The University of Texas at Austin

Geotechnical Engineering Center
Department of Civil, Architectural
and Environmental Engineering

Observed problem during the test when using 2 cm test piece.

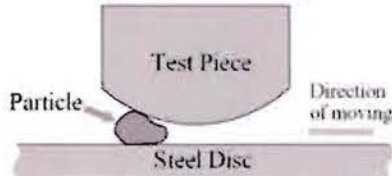

Larger particles stuck between the rotating steel disc and the test piece. Smaller particles passed beneath the test piece without making contact with the test piece, leading an underestimation of the AVS. This happened several times during the 60 second test period and lasted about 2~10 seconds. To mitigate the risk of having influenced abrasion value, another set of test results, obtained using 1 cm test pieces and soils passing 1mm sieve, are provided below

Result of Soil Abrasion Test (1 cm test piece, passing 1 mm sieve)

Portion No.	1		2	
Sample description	Soil fraction less than 1 mm without gravel size partides		Soil fraction less than 1 mm with gravel size particles crushed to less than 1 mm	
Test No.	A	8	A	B
Test piece weight loss (mg)	11	14	17	20
AVS	12.5		18.5	

Photographs of the sample



301 East Dean Keaton building ECJ B220
1 University Station C1792, Austin TX 78712 USA

Dr. Fulvio Tonon
Phone: +1-512-471-4929
Fax: +1-512-471-6548



Parikh Consultant's Inc.

Job #: 204104.T03 Project Engineer: D.A.V.
Project: SURV-BART TO SAN JASK
Location: SAN JASK Date: 7/25/08
To: D.A.V.
From: PRAV DAYAH

Attached are the final results of the laboratory test acquired.

Signed By: [Signature]

Q C Checked By: [Signature]
Lab Supervisor

Samples:
BH-12/S-6
BH-31/S-4
MW-6I
MW-8B

PLEASE NOTE: Lab not responsible for missing data after 48 hours from the above date:

SVRT - TUNNEL SEGMENT

LABORATORY TEST ASSIGNMENT FORM

Boring Number:

Project Name: SVRT - Bart to San Jose
 Project Number: 213213
 Assigned By: AJ

Date Assigned: 07/17/2008
 Date in: _____ Date Out: _____
 Tested By: _____

Reference No.: _____
 Page: 1 of 1

Sample Number	Boring Number	Sample type	Soil Type	Depth Interval (R)	U.C. Moisture Content, Dry Density	Moisture Content, Dry Density	Moisture Content	Plasticity Index	Sieve Analysis: 2"-#200	Sieve Analysis: #4-#200	Sieve Analysis: #200	Hydrometer	pH	Sulfate	Calcium Carbonate	Laboratory Vane Shear	1-D Consolidation	1-D Consolidation (CRS)	UU Triaxial Compression	CU Triaxial Compression	CD Triaxial Compression	Ko CU Triaxial Compression	X-Ray Radiography	Static Simple Shear	Cyclic Simple Shear	Strain-Controlled Cyclic Simple Shear	Resonant Column	Extrusion	Visual Classification Test	Special Instructions and/ or Comments
1	BH-12/S-6	SH	CL	55 - 57.5																										
2	BH-31/S-4	SH	SC	55 - 57.5																									Sieve Analysis performed during 35% PE phase	
3	MW-6I	Bucket	SP-SM	69 - 70.5																										
4	MW-8B	Bucket	GW	25.5 - 26																										

8 HRS.



MOISTURE / DENSITY

Project #: 204104.703

Lab # G 623

Tested By: PRAV

Page #: 1/1

Project Name: SURT - BART TO SJ

Date Tested: 7/23/08

	Sieve		Sieve	
Boring #	BH-12/S-6	BH-31/S-4	MW-6I	MW-8I
Sample #	1	2		
Depth	55-57'	55-57'	69-70'	25.5-28
Ht of Sample				
Tare #	G64	G41		
Gross Wet Wt.	378.2	396.7		
Gross Dry Wt.	305.6	356.8		
Tare Wt.	84.9	85.0		
Wt. of Water	72.6	39.9		
Net dry Wt.	220.7	271.8		
% Moisture	32.9	14.7		
Dry Density				
Wet Density				
Pocket Pen	2.25			
$\phi = 2.416" f = 0.831$ $yd = \frac{Wds (g) \times f}{L (in)}$ $yd = \frac{4.8493 \times Wds (g)}{(\phi)^2 (in) \times L (in)}$ $yd = pcf \times 0.1572 = KN/m-cub$	<p>Top to Bottom</p> <p>LENGTH 27" - TOTAL WET WT. 5233.5g</p> <p>MOIST, HARD FAT CLAY. GRAY.</p> <p>TOTAL LENGTH 21" TOTAL WET WT 4113.6g</p> <p>MOIST, LOOSE SILTY SAND WITH SOME GRAVEL, BROWN</p>			

PARIKH CONSULTANTS, INC.



SIEVE ANALYSIS

ASTM C117 & C136, D422 or CAL 202

Project Name: SVRT - BART To San Jose Lab # G623 Project #: 204104.T03
 Sample #: MW-61 Depth: 69' Tested By: PD Date Tested: 7/25/08

U.S. Standard Sieve	Weight Retained		Percent RETAINED Cumulative	Percent PASSING Cumulative	Percent PASSING Cumulative		
	Cumulative/ Individual	Tare:					
2-in. (50-mm)			0.0%	100.0%			
1 1/2-in. (37.5-mm)	0.0		0.0%	100.0%		Dry Wt + Tare	100.0
1-in. (25.0-mm)	1.0		1.0%	99.0%		Tare Wt	0.0
3/4-in. (19.0-mm)	1.4		1.4%	98.6%		Dry Wt of Soil	100.0
1/2-in. (12.5-mm)	7.0		7.0%	93.0%			
3/8-in. (9.5-mm)	10.5		10.5%	89.5%			
No. 4 (4.75-mm)	17.8		17.8%	82.2%		Gravel	17.8%
No. 8 (2.36mm)	22.6		22.6%	77.4%			
No.16 (1.18 - μm)	27.9		27.9%	72.1%		Sand	77.5%
No.30 (600 - μm)	41.1		41.1%	58.9%			
No.50 (300 - μm)	72.2		72.2%	27.8%		Fines	4.7%
No.100 (150 - μm)	91.1		91.1%	8.9%			
No.200 (75 - μm)	95.3		95.3%	4.7%		Dry Wt + #4	1,009 gm
Wash - #200 + Pan			0.0%	100.0%		Dry Wt - #4	4,642 gm
TOTAL	100.0					Total Dry Wt	5,651 gm

GRAIN SIZE CLASSIFICATION

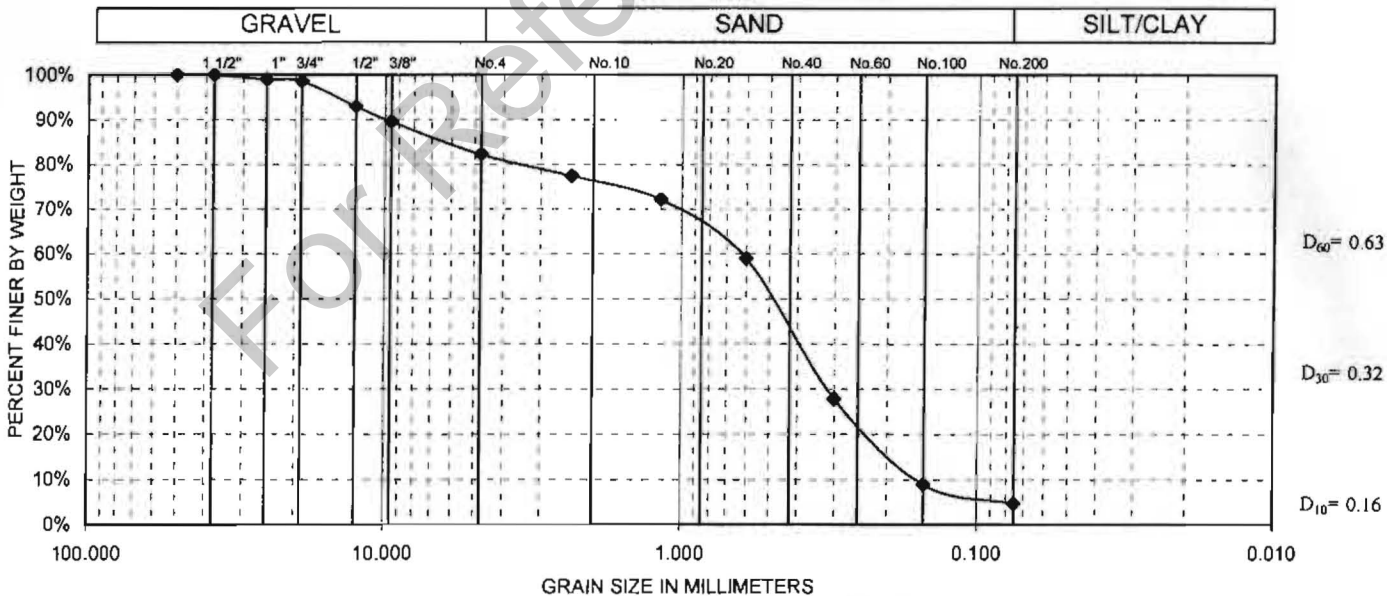

SAMPLE NO.	DEPTH	U.S.C.	CLASSIFICATION	Cu	Cc
MW-61	69'	SP	POORLY-GRADED SAND WITH GRAVEL	4.06	1.00

PARIKH CONSULTANTS, INC.

C:sieves

09/23/07 (FYW)



SIEVE ANALYSIS

ASTM C117 & C136, D422 or CAL 202

Project Name:	SVRT - BART To San Jose	Lab #	G623	Project #:	204104.T03
Sample #:	MW-8B	Depth:	25.5'	Tested By::	PD
				Date Tested:	7/25/08

U.S. Standard Sieve	Weight Retained		Percent RETAINED Cumulative	Percent PASSING Cumulative	Percent PASSING Cumulative		
	Cumulative/ Individual	Tare:					
2-in. (50-mm)			0.0%	100.0%			
1 1/2-in. (37.5-mm)	2.5		2.5%	97.5%		Dry Wt + Tare	100.0
1-in. (25.0-mm)	14.0		14.0%	86.0%		Tare Wt	0.0
3/4-in. (19.0-mm)	22.2		22.2%	77.8%		Dry Wt of Soil	100.0
1/2-in. (12.5-mm)	38.8		38.8%	61.2%			
3/8-in. (9.5-mm)	48.5		48.5%	51.5%			
No. 4 (4.75-mm)	67.2		67.2%	32.8%		Gravel	67.2%
No. 8 (2.36mm)	78.5		78.5%	21.5%			
No.16 (1.18 - μm)	84.4		84.4%	15.6%		Sand	27.0%
No.30 (600 - μm)	87.7		87.7%	12.3%			
No.50 (300 - μm)	90.1		90.1%	9.9%		Fines	5.8%
No.100 (150 - μm)	92.2		92.2%	7.8%			
No.200 (75 - μm)	94.2		94.2%	5.8%		Dry Wt + #4	16,517 gm
Wash - #200 + Pan			0.0%	100.0%		Dry Wt - #4	8,050 gm
TOTAL	100.0					Total Dry Wt	24,567 gm

GRAIN SIZE CLASSIFICATION

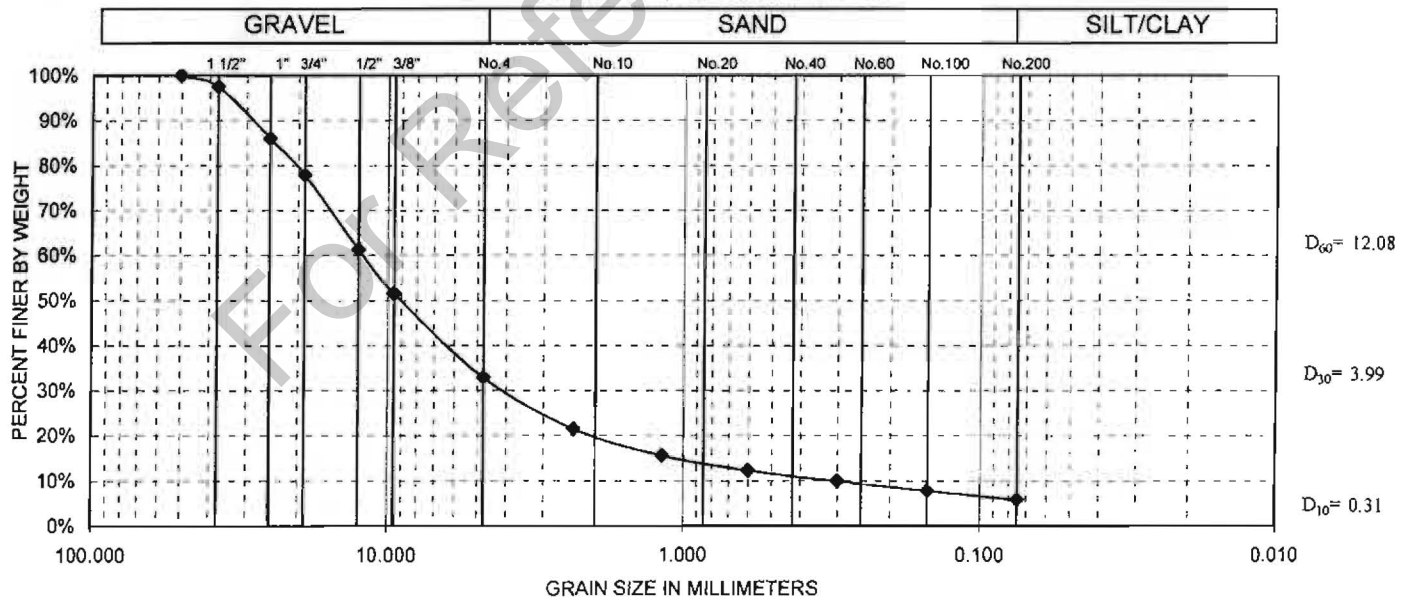

SAMPLE NO.	DEPTH	U.S.C.	CLASSIFICATION	Cu	Cc
MW-8B	25.5'	GP-GM	POORLY-GRADED GRAVEL WITH SILT AND SAND	39.13	4.28

PAARIKH CONSULTANTS, INC.

For Reference Only

Appendix 12: Mineralogy Test Results

For Reference Only

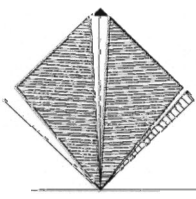

Anil Dean, PE, GE
 Hatch Mott MacDonald
 3825 Hopyard Road, Suite 240
 Pleasanton, CA 94588

July 7, 2008

RE: Soil Mineralogy Testing - SVRT Project
 P.O. No.: 24965-PO-00012
 Report No.: 60060108

It was requested to test a total of eleven (11) soils for abrasivity by mineralogical and petrographic evaluations. The soil samples received were labeled and classified as follows:

Silicon Valley Rapid Transit Project

S.	Boring	Depth	Sample	Soil Type
1	BH-20	57.2	S-12	GW-GC
2	BH-21	56.5	S-8	GW-GC
3	BH-26	56.7	S-8	SP-SC
4	BH-28	67.7	S-11	CL
5	BH-31	61.2	S-5	GP-GM
6	BH-46	50.9	S-18A	ML/CL
7	BH-78	26	S-6	GW-GC
8	MW-6I	69		SP w/ gravel
9	MW-2G	70.5		SW-SM
10	MW-8B	25.5		GW-GM w/ sand
11	MW-8B	39		SP-SM

Below are the specific test assignments requested for each soil sample:

S. No.	XRD	Sieve/H yd	XRF	Clay ID	Petrograph y	Durability
1	1	1	1			
2	1	1	1			
3	1	1	1		1	
4	1		1	1		
5	1	1	1		1	
6	1		1	1		
7	1	1	1		1	
8	1	1	1		1	1
9	1	1	1		1	1
10	1	1	1		1	1
11	1	1	1		1	1

TEST PROCEDURES [a]

XRD (X-ray powder diffraction analysis) was performed on a horizontal Rigaku powder diffractometer using $\text{CuK}\alpha$ radiation with a diffracted beam monochromator. The specifics of the XRD techniques used are described in the RESULTS section of this report.

Sieve/Hydrometer tests were performed in accordance with ASTM D422-07.

XRF (wavelength dispersive X-ray fluorescence analysis) was performed using methods outlined in "The Practical Guide for Preparation of Specimens for X-ray Fluorescence and X-ray Diffraction Analysis".

Clay ID was determined by the method described in Reference 3.

Petrography was performed in accordance with ASTM C295.

Durability was performed in accordance with accordance with ASTM D3744

RESULTS

XRD and Clay ID

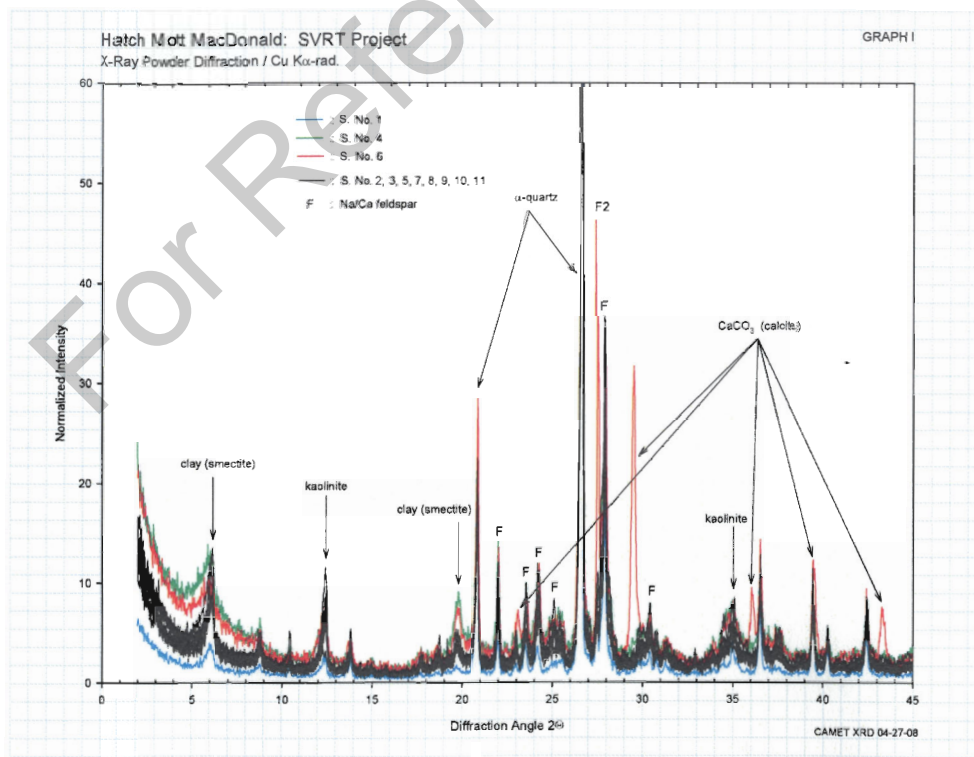

X-ray powder diffraction patterns were produced from fractions passing through a 325 mesh sieve (<45 μm) of each homogenized soil. GRAPH I shows all the XRD patterns combined which were obtained from each of the 11 soils. Except for soil No. 6, all materials exhibit very similar concentrations of the rock forming minerals quartz, feldspar, expansive clay (smectite) and non-expansive clay (kaolinite, mica). Only soil No. 6 shows a considerable amount of calcite (CaCO_3) in addition to these minerals. With respect to expansive clay content, the eleven soils appear to fall into three distinctive groups: soil No. 1, soil No. 4 & 6 and the remaining soils No. 2, 3, 5, 7, 8, 9, 10 and 11. The presence of expansive clay was confirmed in soils No. 4 and 6 (GRAPH II) by ethylene glycol treatment while the presence of kaolinite was found in soil No. 6 by heat treatment in air (GRAPH III).

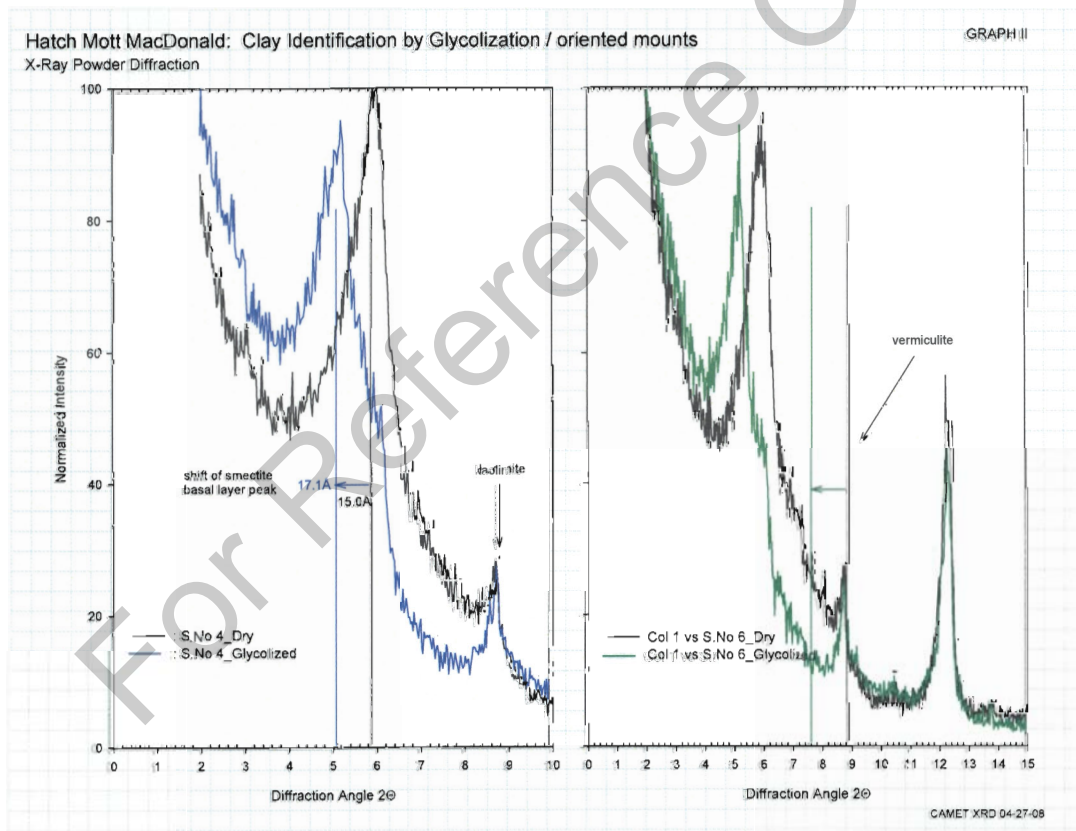

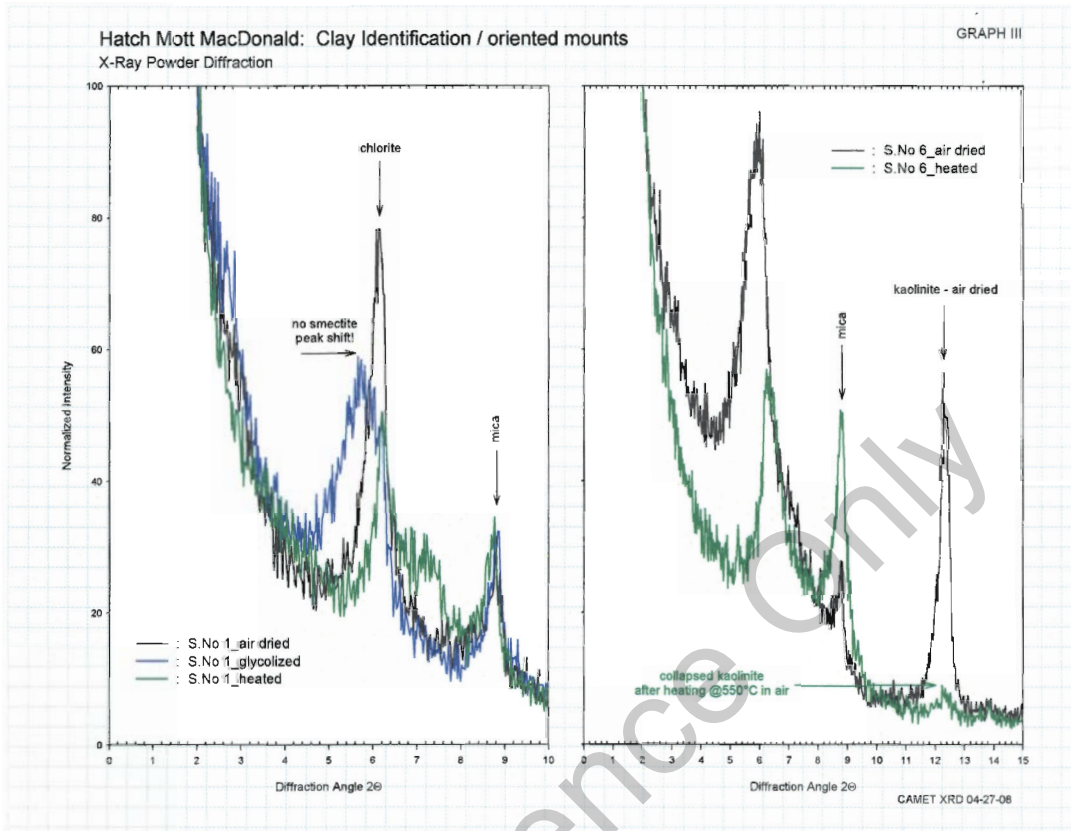

The actual mineral concentrations of the three soil groups were obtained by least squares analysis of the full diffraction pattern (FULLPAT) of soils No. 1, 2 and 6.

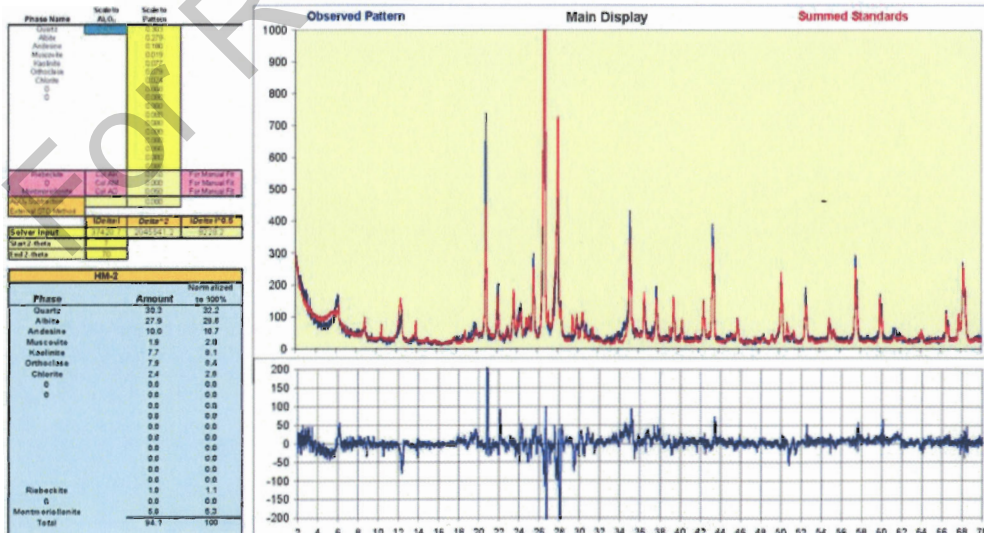

Determination of mineral content of soil No. 2 by full pattern analysis (FULLPAT)

The table below lists the approximate(!) mineral concentrations for the three soil groups. The actual concentrations within each group can be expected to vary from the values listed in the table.

Mineral	Hardness	Soil No. 1	Soil No. 2, 3, 5, 7, 8, 9, 10, 11	Soil No. 4, 6
	(Mohs)	wt%	wt%	wt%
Quartz	7	51.0	32.0	24.0
Albite	6-6.5	21.0	30.0	22.0
Andesine	5-6	10.0	10.5	13.0
Orthoclase	6-6.5	8.5	8.5	12.0
Riebeckite	5	1.0	1.0	
Calcite	3-4			6*
<u>Clay mineral:</u>				
Muscovite	2.5-3	1.0	2.0	1.0
Kaolinite	2-2.5	5.5	8.0	11.0
Chlorite	1-2	1.5	3.0	3.0
Montmorillonite	1-2	--	5.0	8.0
Total Clay content		10	18	23

Nonexpansive clays: muscovite kaolinite chlorite

Expansive clay (smectite): montmorillonite

Feldspars: Albite, Andesine, Orthoclase

* no CaCO₃ content in soil No. 4

WDXRF

The material received was dried at 60°C to remove excess water, pulverized in a SPEX ball-type mill to pass a 150µm sieve (No.100) and subsequently homogenized and dried at 110°C to constant weight (oven dry weight). Approximately three grams of material were placed in a porcelain crucible and calcined at 950°C in a muffle furnace. Samples 4 and 6 (clays) showed an elevated weight loss when compared to the other samples. It should be noted that XRD could identify calcium carbonate (CaCO₃) in sample 6. When heated in air at 900° CaCO₃ starts to decompose to calcium oxide CaO and carbon dioxide gas CO₂.

Prior to the fusion process, the mass loss associated with the calcination is reported as loss on ignition (LOI) and accounts in general for free moisture (a), combined water/organics (b) and CO₂/organics (c). The materials calcined were mixed with a lithium borate flux and fused to beads at 1000°C in a muffle furnace. The glass beads were ground and polished to produce a flat surface for the X-ray analysis. Elemental data sets were collected on a Siemens SRS200 wavelength dispersive XRF spectrometer for which instrument calibration was established with USGS and Estonia reference rocks .

The table below lists the elemental composition (expressed in oxide) of the homogenized fraction of each soil:

Analyte	Soil No.										
	1	2	3	4	5	6	7	8	9	10	11
	wt%	wt%	wt%	wt%	wt%	wt%	wt%	wt%	wt%	wt%	wt%
SiO ₂	76.47	67.19	68.74	62.13	66.51	61.84	67.36	68.82	71.63	65.61	71.89
Al ₂ O ₃	10.54	12.60	11.74	15.23	12.72	12.49	13.91	12.39	12.76	13.74	13.33
Fe ₂ O ₃	4.19	5.52	5.62	6.06	5.60	5.83	6.04	5.68	5.84	6.19	4.24
CaO	2.05	2.27	1.99	1.82	2.66	2.69	2.59	2.06	2.22	2.88	1.68
MgO	1.95	2.67	2.54	2.82	2.67	2.62	2.88	2.92	2.72	2.86	1.89
Na ₂ O	2.56	2.77	2.72	2.48	3.34	3.59	4.48	3.17	2.61	3.66	2.87
K ₂ O	1.66	1.79	1.49	2.44	1.64	1.64	1.54	1.69	1.45	1.74	2.39
TiO ₂	0.45	0.59	0.60	0.78	0.59	0.59	0.70	0.59	0.65	0.64	0.52
P ₂ O ₅	0.11	0.15	0.15	0.14	0.16	0.16	0.17	0.17	0.18	0.14	0.15
LOI	2.51	3.31	3.36	5.02	3.25	7.68	2.69	2.99	3.76	2.27	2.58
Total	102.48	98.86	98.96	98.92	99.13	99.14	102.37	100.49	103.83	99.73	101.55

It should be noted that the higher LOI in Sample 6 is consistent with the presence of calcium carbonate that was found in that sample only by XRD

Ludwig Keller, Ph.D.
CAMET RESEARCH, INC.

[a] XRD measurements were carried out by CAMET Research, Inc.

Sieve/Hydrometer tests were carried out by Pacific Materials Laboratory, 35S La Patera Ln, Goleta, CA 93117

Tel. 805.964.6901)

XRF measurements were carried out by Chemistry of Concrete, 6409 Camino Vista #E, Goleta, CA 93117
Tel. 805.965.9844

Clay ID measurements were carried out by CAMET Research, Inc.

Petrographic analysis was carried out by Analytical Consulting Group, Inc, 1746F Victoria Ave., Ventura, CA
93003 Tel 805.642.8180

Durability tests were carried out by Twining Laboratories of Southern California, 2883 East Spring Street,
Long Beach, CA Tel 562.426.3355

- [1] Buhrke, VE, Jenkins R, Smith DK, A Practical Guide for the Preparation of Specimens for X-ray Fluorescence and X-ray Diffraction Analysis, Chapter 3, Whole Rock Analysis, Wiley-VCH, 1998.
- [2] Chipera, S.J. and Bish, D.L., "FULLPAT: a full pattern quantitative analysis program for X-ray powder diffraction using measured and calculated patterns", J. Appl. Cryst. 35, 744-749 2002
- [3] T. Kiipli, R.A. Batchelor, R.M. Rousseau, et al., "Seven Sedimentary Rock Reference Samples from Estonia", Oil Shale, 2000, Vol. 17, No. 3, p. 215-223

For Reference Only

Pacific

Materials

Laboratory

of Santa Barbara, Inc.

35-A South La Patera Lane
P.O. Box 96
Goleta, CA 93116
Ph: (805) 964-6901

Santa Ynez
Ph: (805) 688-7587

FAX No: (805) 964-6239
E-mail: pml@pml.sbcoxmail.com

April 18, 2008
Lab No: 79546-2
File No: 08-12785-2

Chemistry of Concrete
Attn: Michael Neff, SM PE
6409 Camino Vista #E
Goleta, CA 93117

SUBJECT: Sieve and Hydrometer Tests (ASTM D422)
Soil Samples Delivered to PML
SVRT project

Dear Mr. Neff:

In accordance with the request of Thomas Holzheu, sieve and hydrometer tests (ASTM D422) were performed per your chain of custody on eleven (11) soil samples delivered to this laboratory on April 4, 2008.

It should be noted; all of the samples containing material larger than the No. 10 sieve did not have enough material to meet the minimum quantity specified in ASTM D422 section 5.1.1 based on the nominal diameter of largest particles. The results of the testing is shown graphically in Appendix A.

If you have any questions concerning this matter, please do not hesitate to call. Thank you for the opportunity of providing this service.

Respectfully submitted,

PACIFIC MATERIALS LABORATORY, INC.



Ronald J. Pike, C. E. 42788

RJP:kfb

"We Test The Earth"

APPENDIX A
LABORATORY TESTS

For Reference Only

April 18, 2008

Lab No: 79546-2

File No: 08-12785-2

Sample size 387.86 g

Sample No. 1

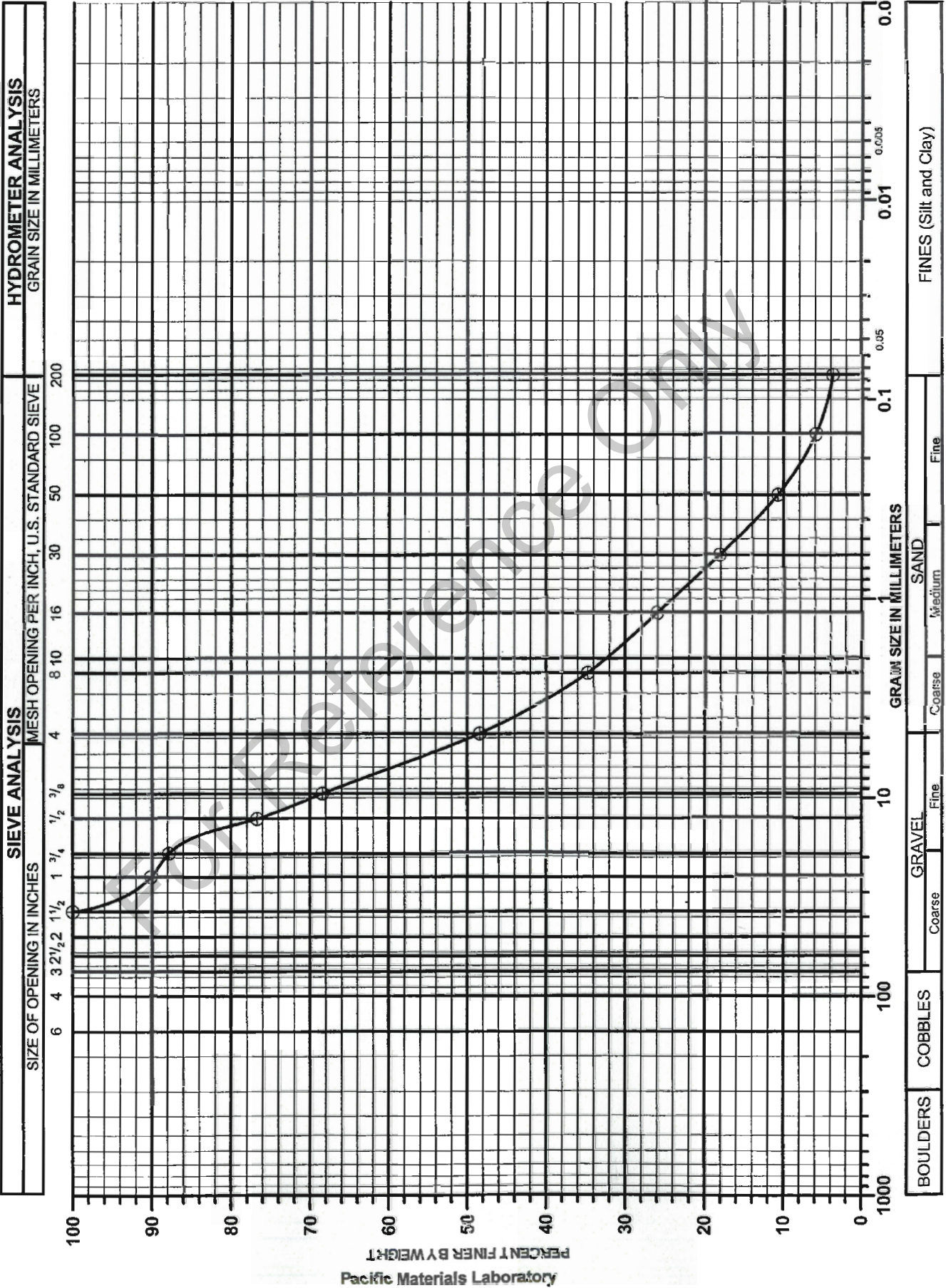

Pacific Materials Laboratory

Sample size 350.56 g

Sample No. 2

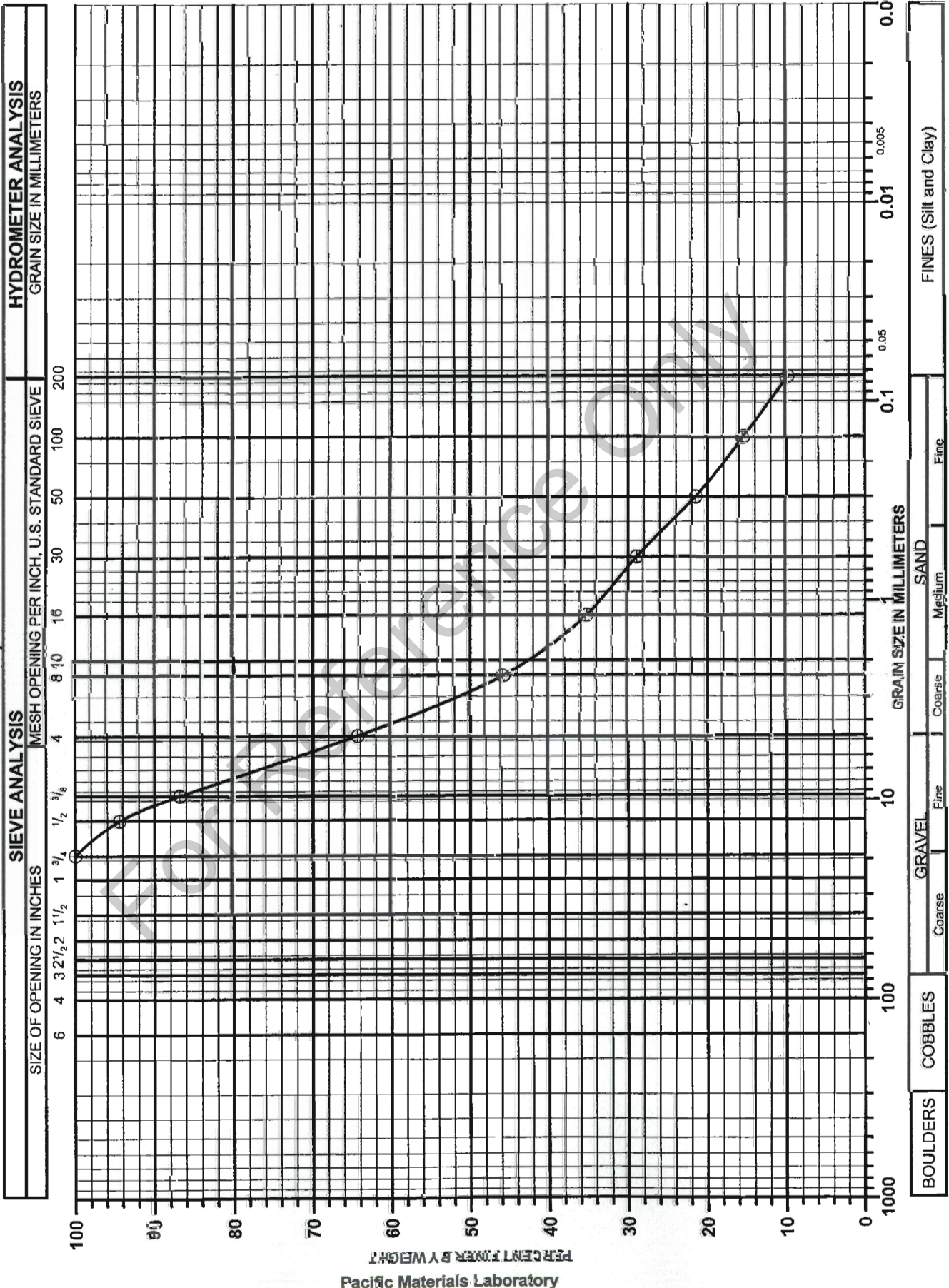

Pacific Materials Laboratory

Sample size 525.13 g

Sample No. 3

SIEVE ANALYSIS		HYDROMETER ANALYSIS	
SIZE OF OPENING IN INCHES	MESH OPENING PER INCH, U.S. STANDARD SIEVE	GRAIN SIZE IN MILLIMETERS	

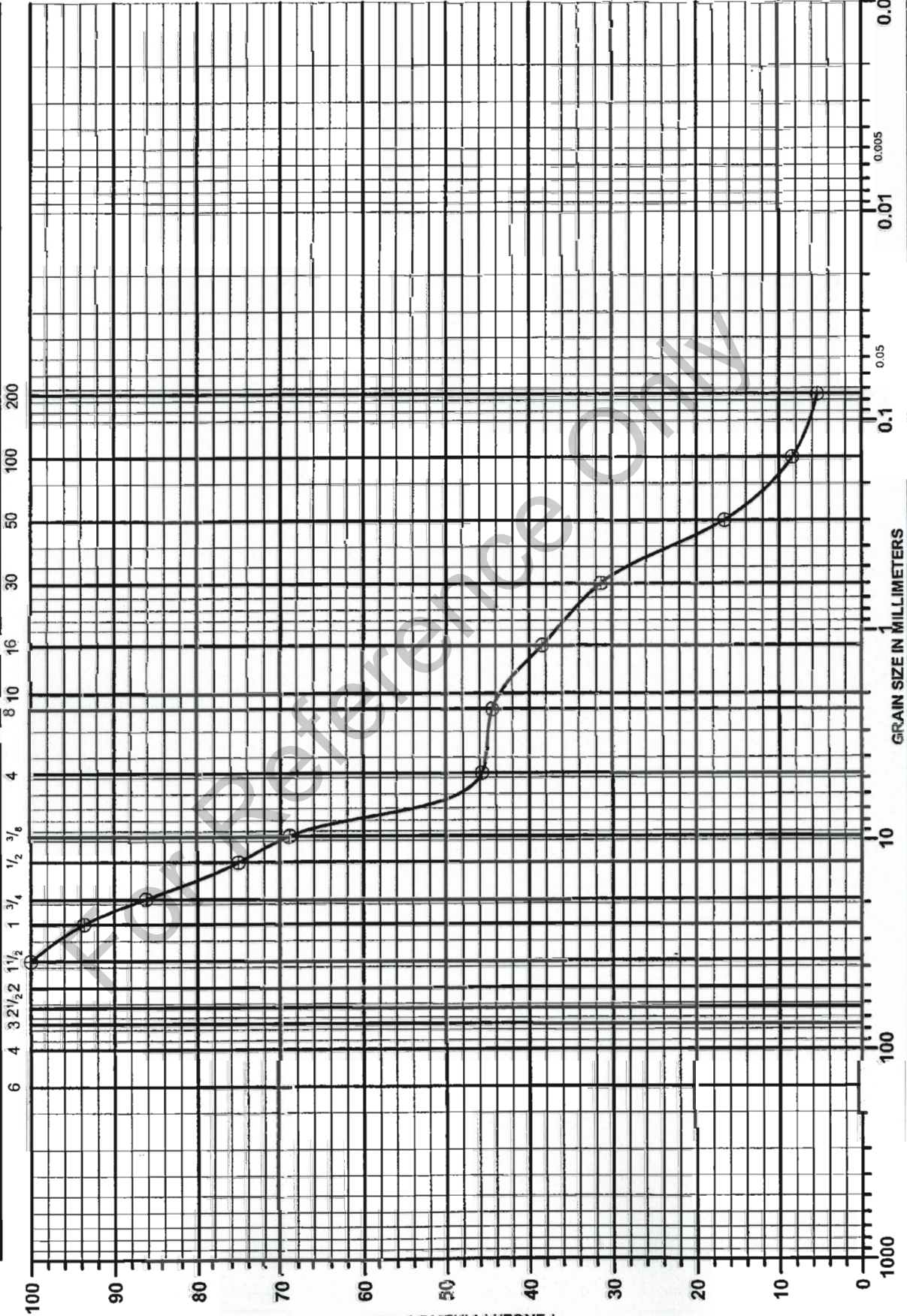

GRAVEL		SAND		FINES (Silt and Clay)	
Coarse	Fine	Coarse	Medium	Fine	

Pacific Materials Laboratory

Sample size 44.07g

Sample No. 4

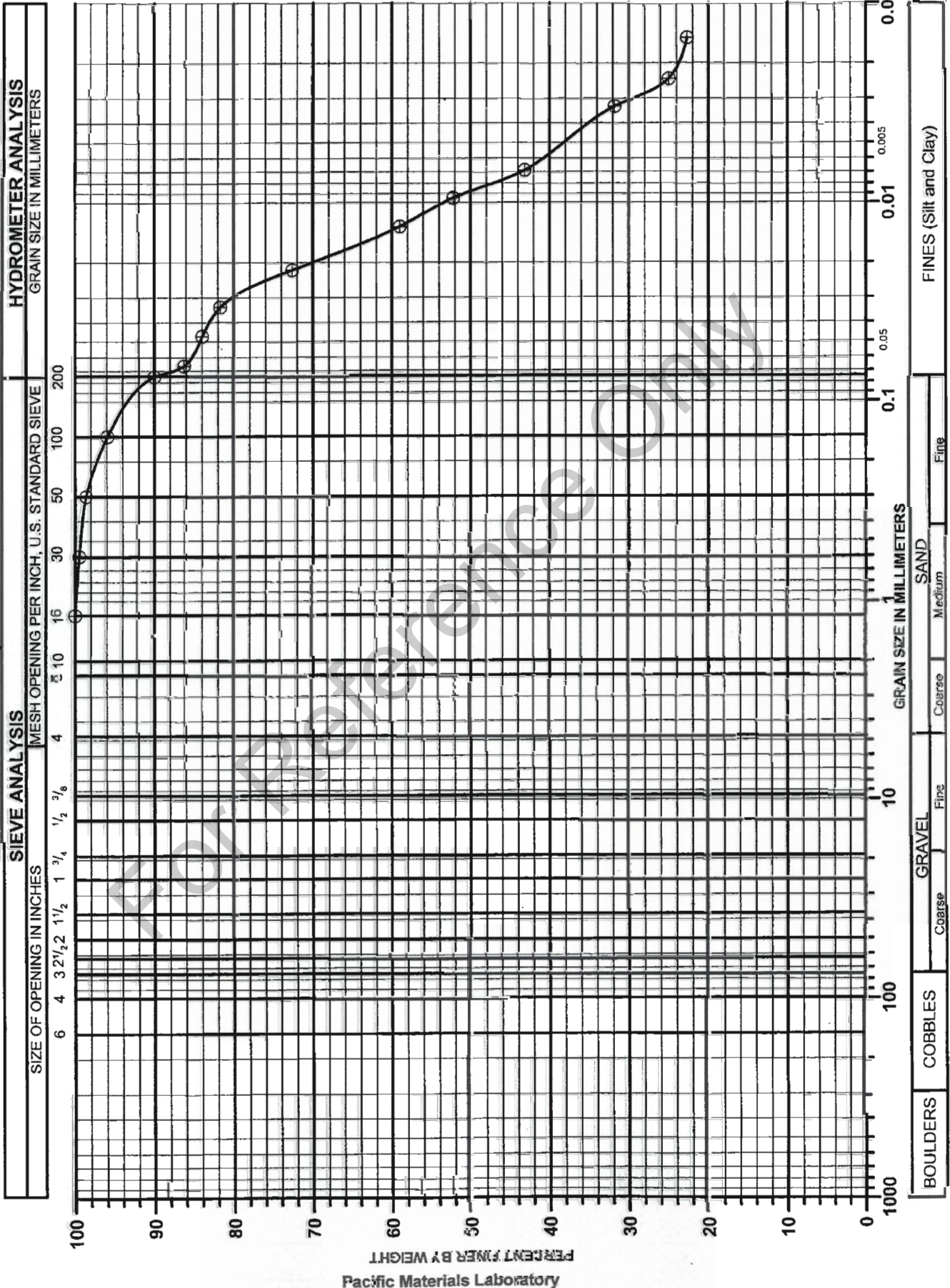

Sample size 474.45 g

Sample No. 5

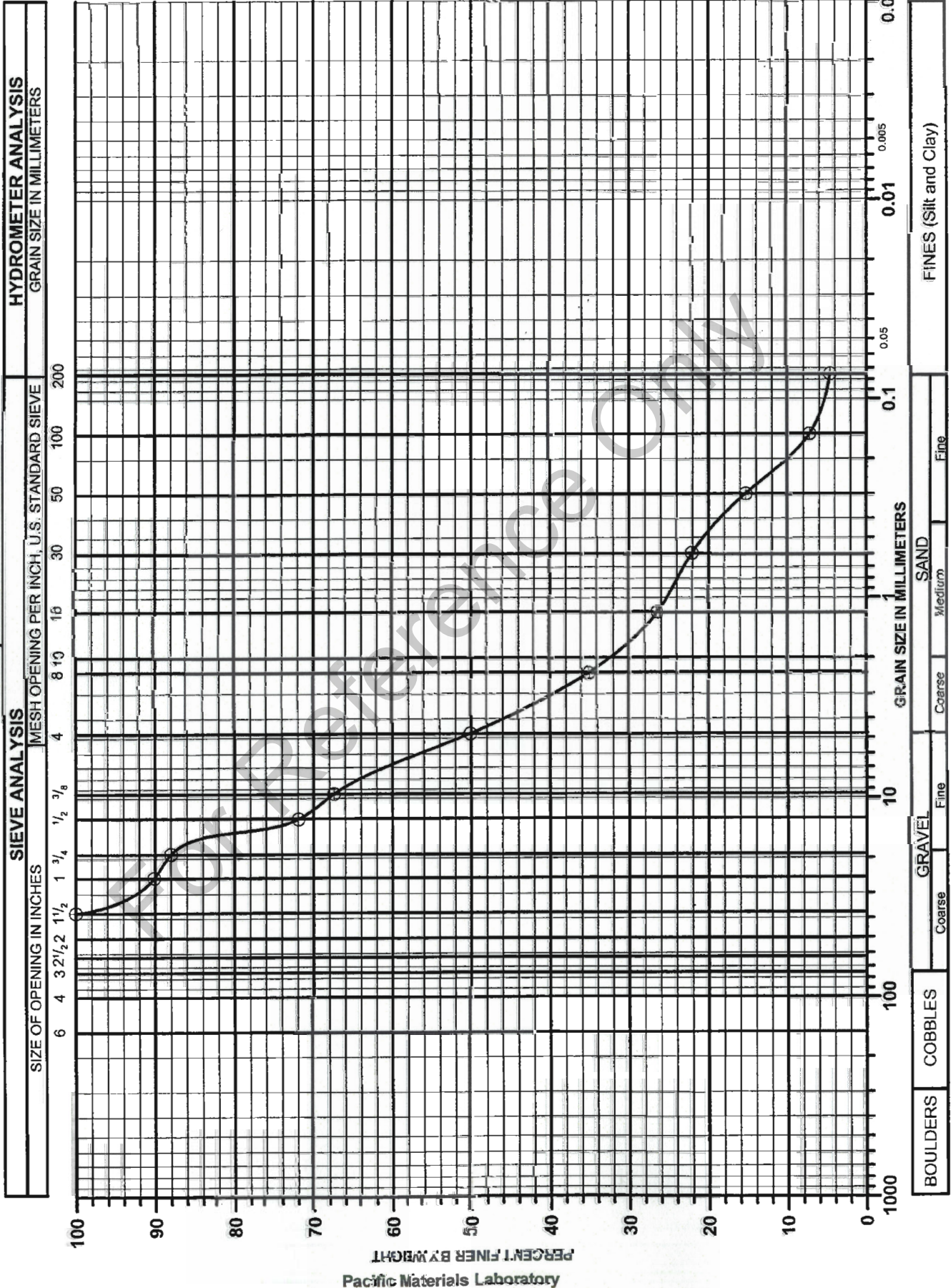

Sample size 43.1g

Sample No. 6

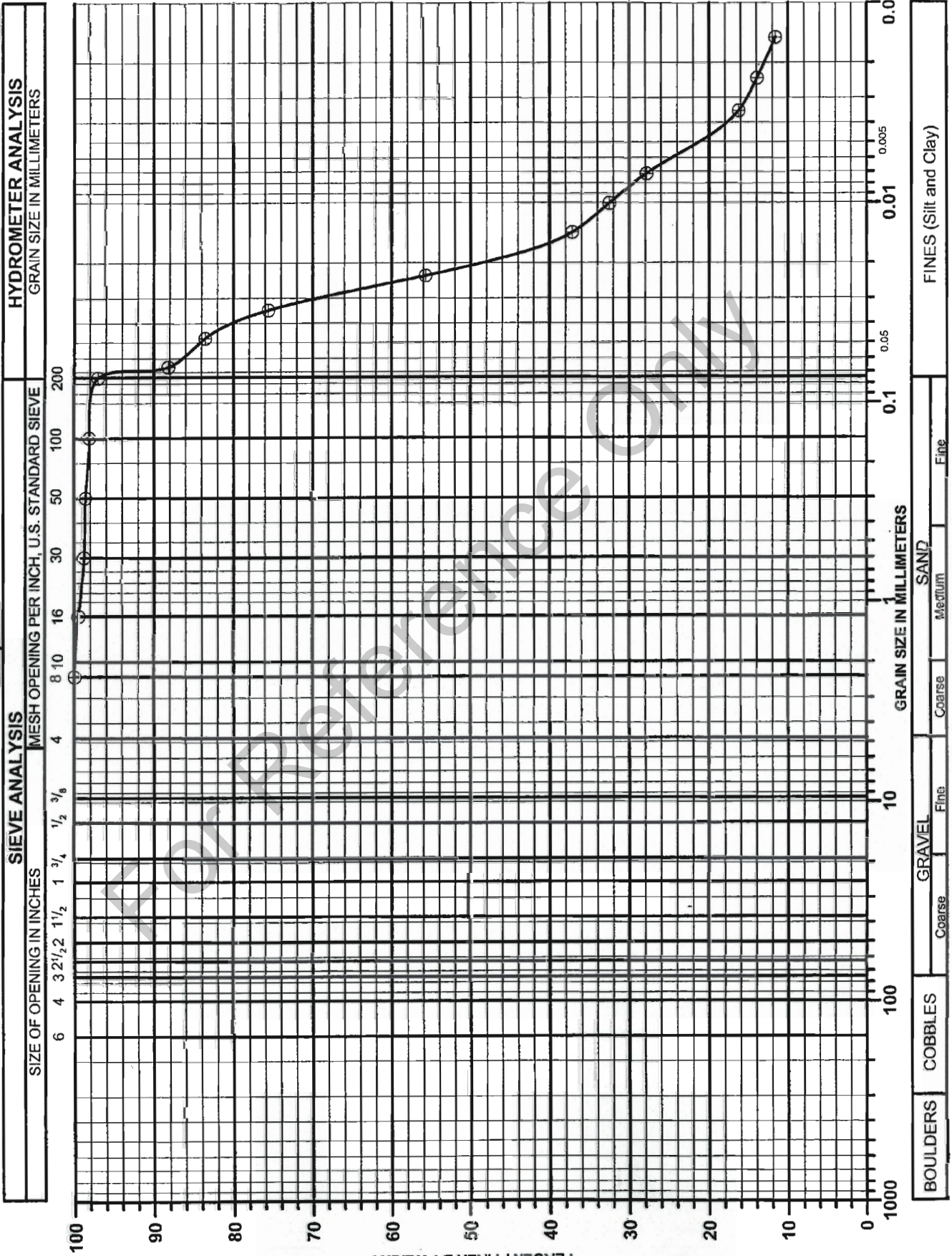

SIEVE ANALYSIS

HYDROMETER ANALYSIS

SIZE OF OPENING IN INCHES

MESH OPENING PER INCH, U.S. STANDARD SIEVE

GRAIN SIZE IN MILLIMETERS

6 4 3 2 1 1/2 1 3/4 1/2 3/8 3/16

200

100

50

30

16

8 10

4

1/2 3/8

1 1 1/2 2

3 4

6

10

20

40

80

100

PERCENT FINER BY WEIGHT

Pacific Materials Laboratory

FINES (Silt and Clay)

SAND
 Coarse Medium Fine

GRAVEL
 Coarse Fine

COBBLES
 Coarse

Sample size 326.63g

Sample No. 7

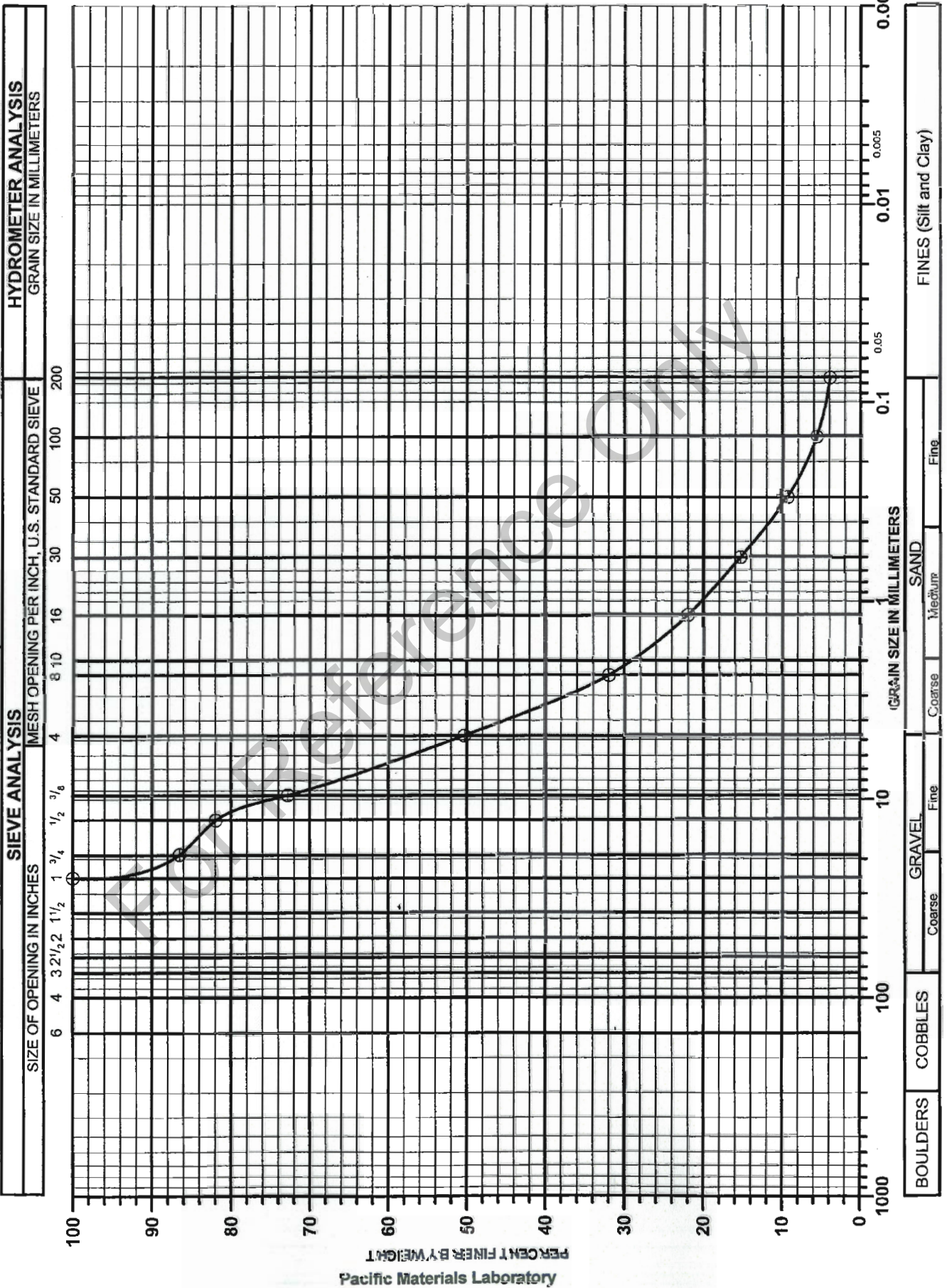

Sample size 515.42g

Sample No. 8

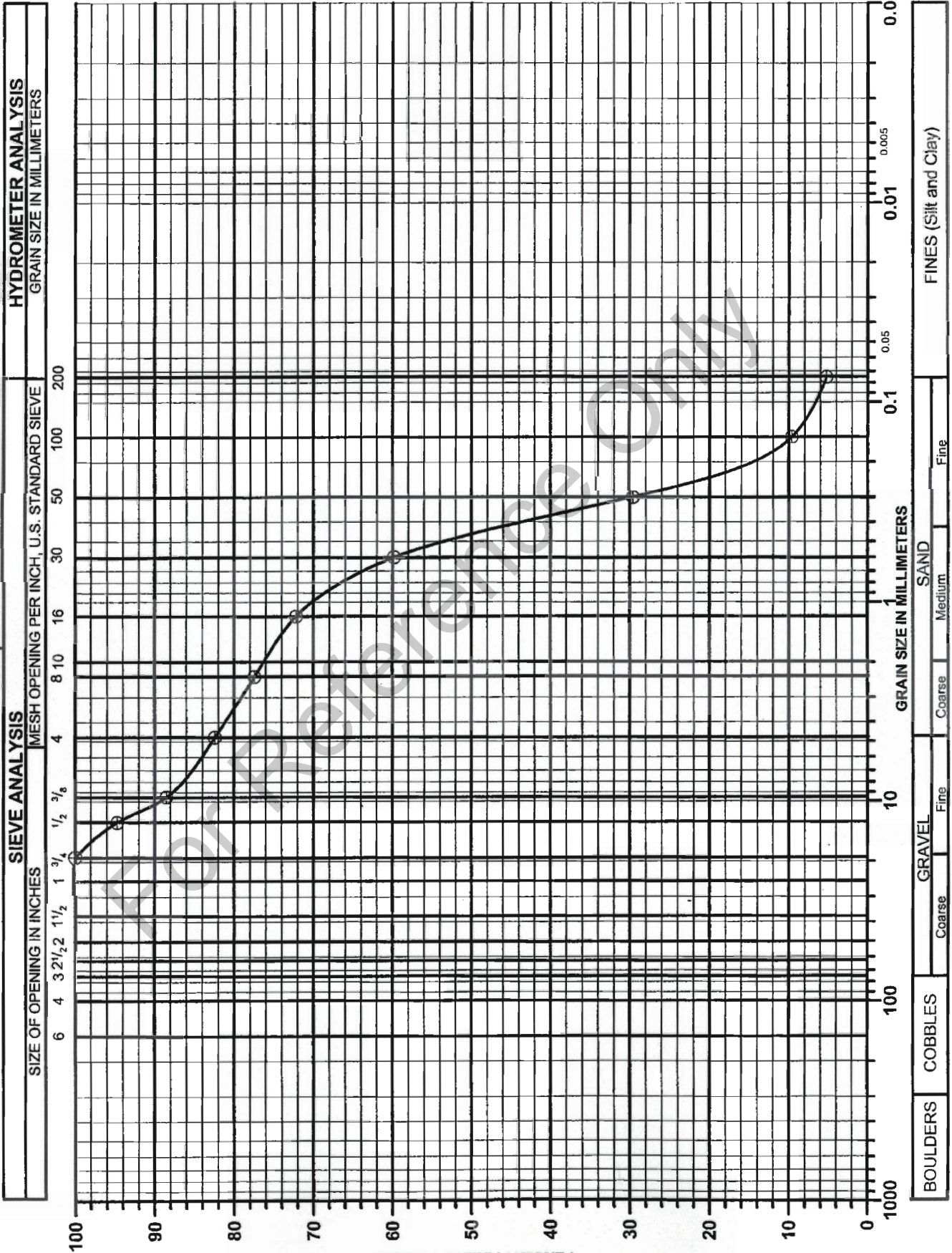

Sample size 848.76g

Sample No. 9

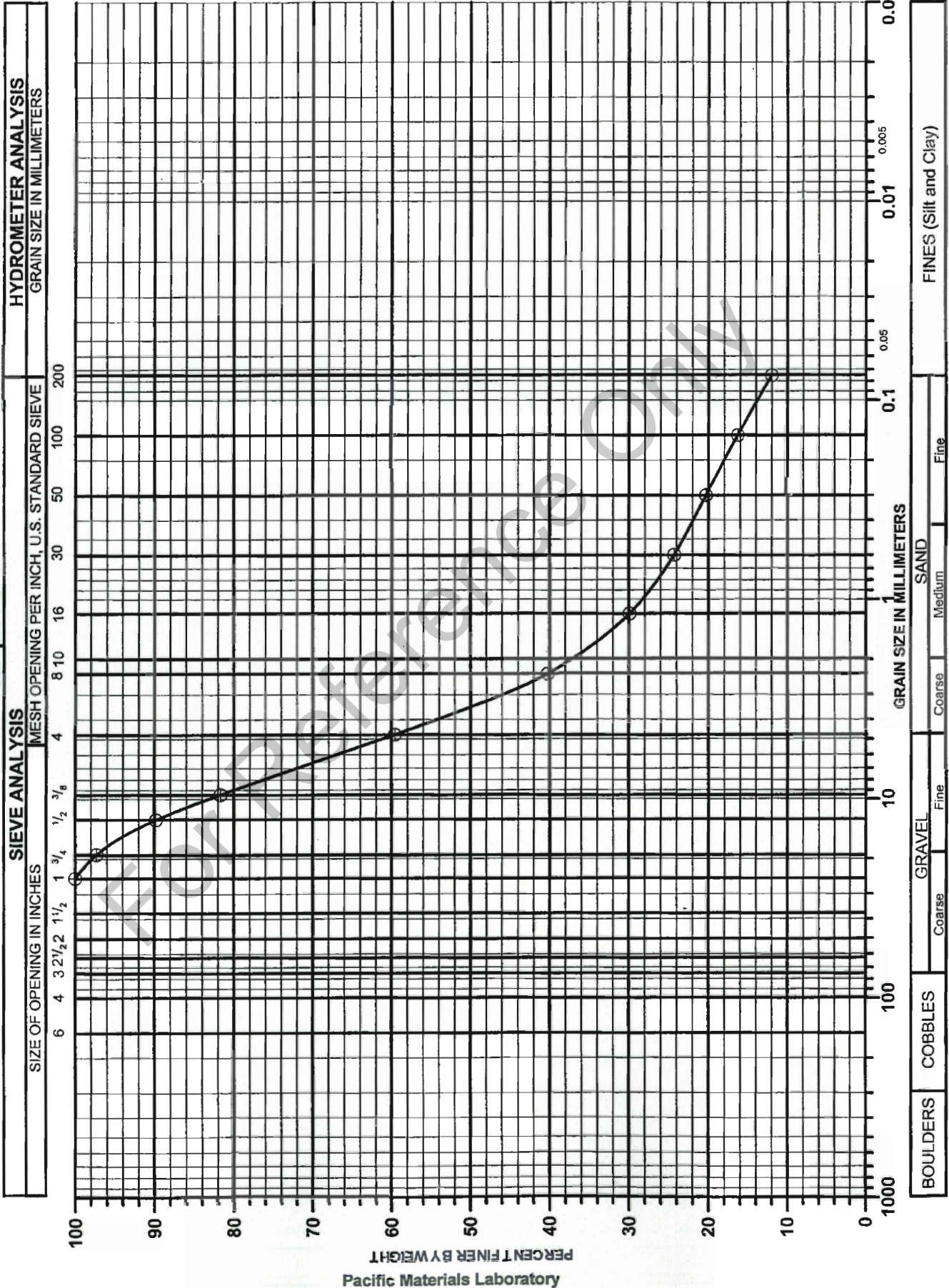

Pacific Materials Laboratory

Sample size 9578.7g

Sample No. 10

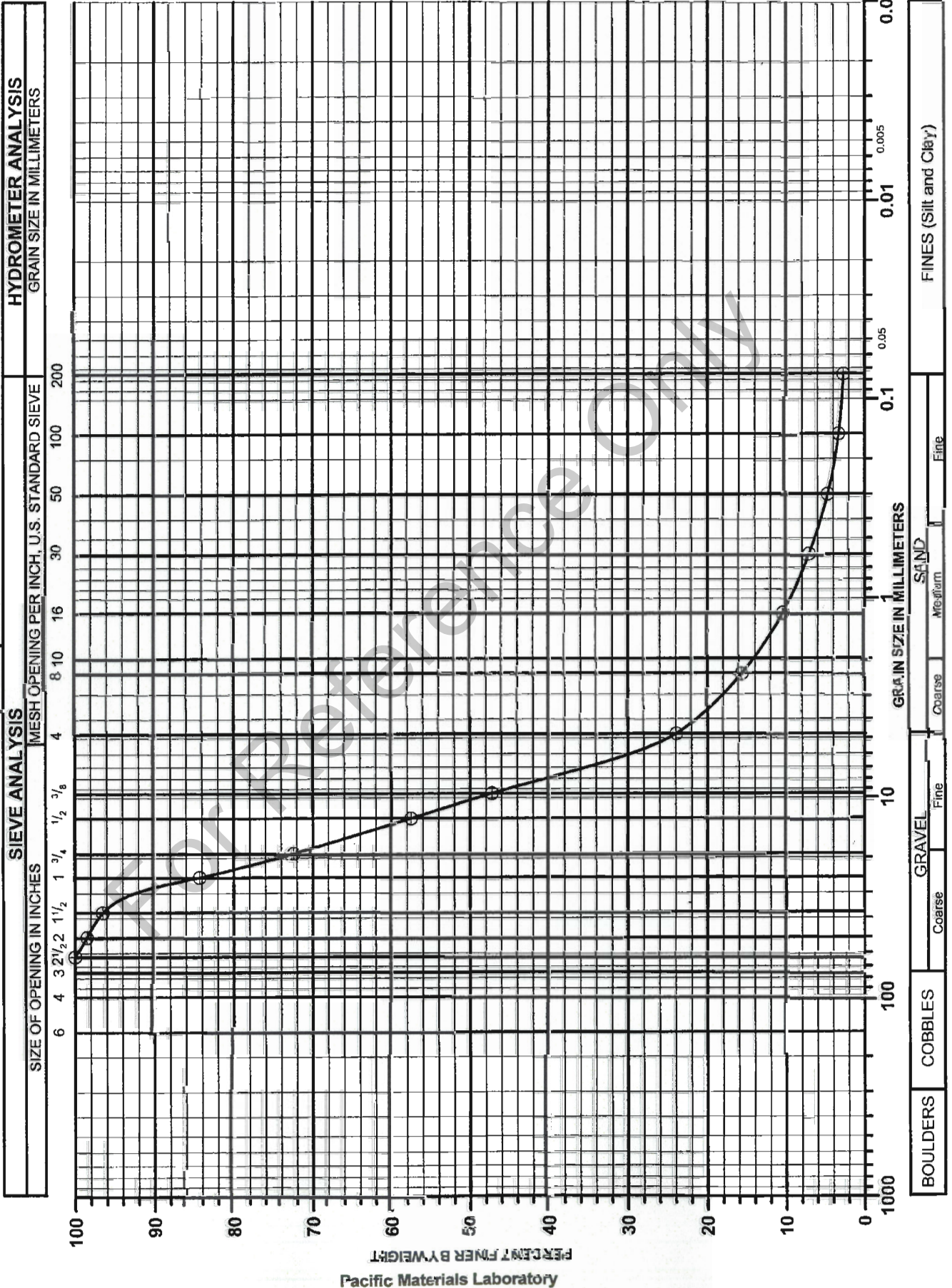

Sample size 326.60g

Sample No. 11

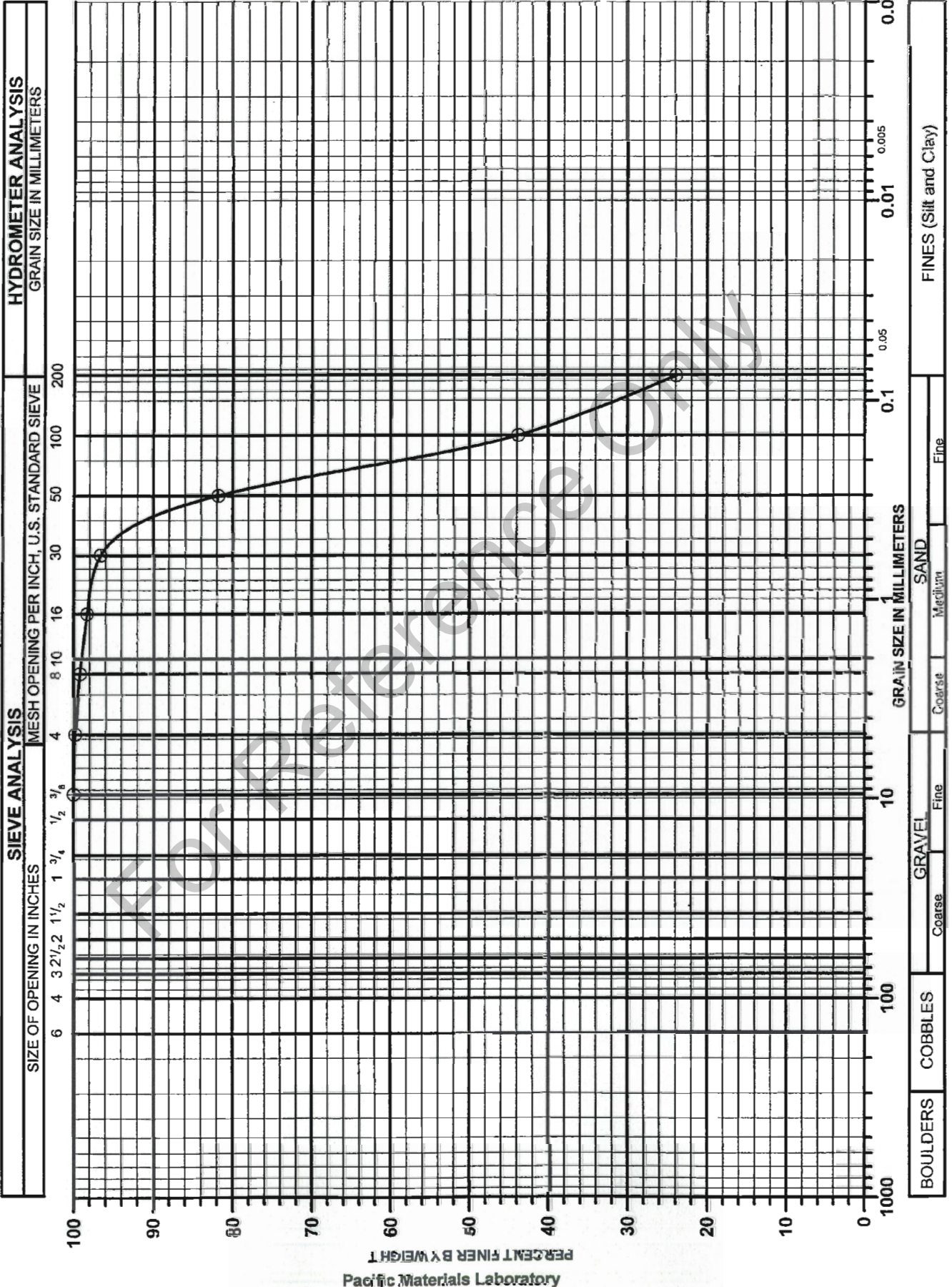

Pacific Materials Laboratory

Analytical Consulting Group, Inc.

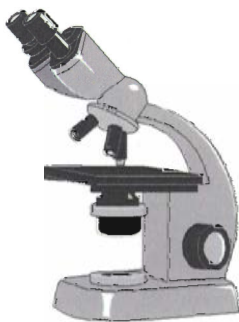

June 25, 2008

ACG Lab No. P0804-555

CAMET Research, Inc.
6409 Camino Vista
Goleta, CA 93117
Attn: Dr. Ludwig Keller

Subject: ASTM C-295 Petrographic Examination of Soil Sample, SVRT Project

One sample of sandy gravel, identified as SVRT Sample 3: **BH-26 @ 56.7 ft**, was submitted to Analytical Consulting Group, Inc. (ACG) for petrographic examination. The purpose of the examination was to determine the lithological composition of the sample. The sample identification and the USCS classification assigned by the client is listed in the attached table.

The sample was sieved into fractions retained on the $\frac{3}{8}$ -in, #4, #8, #16, #30, #50, #100, #200, and passing #200 sieves. Each fraction (except the $+\frac{3}{8}$ -in) was further split to yield approximately 100 particles for analysis.

The examination was conducted in accordance with ASTM C-295. The examination was performed using a stereobinocular microscope at 5x to 40x magnification. The finest sand fractions and some crushed grains from coarser fractions were examined immersed in refractive index liquid, using the polarized-light microscope at up to 400x magnification. The enclosed table and charts present the lithologic data for the samples, given as percent by particle count (approximate weight percent) for each size fraction except for the $+\frac{3}{8}$ ". The composition of the $+\frac{3}{8}$ " sample was determined by weighing each type of rock due to the range of particle sizes. A weighted average is calculated for the sample using the fraction weights determined by the sieve analysis. The sample data is presented in the attached table and chart. The analytical sensitivity for this method is approximately 0.1% for the weighted average of the sample.

The sample is composed primarily of fine-grained sandstones, siltstones, and mineral grains (principally quartz and feldspar) derived from the rocks. Volcanic and plutonic rocks are also present. Lithic clasts dominate in the larger size fractions and discrete mineral grains in the finer fractions.

Sandstones make up about 45% of the sample. The sandstones range from greywacke to quartz wacke, with lithic to arkosic types dominating. The sandstones are well cemented and some have probably undergone some metamorphism. The matrix consists of clay, mica, and/or chlorite, with variable amounts of iron oxide. No carbonates are present. Thin quartz veins are frequent in the greywackes. The sandstone particles are tan, grey, green, or reddish in color, generally equant, and rounded to subangular, with a few angular crushed particles.

Dark grey siltstone and shale constitute about 7% of the sample. These rocks consist primarily of silt-sized quartz and feldspar grains with clay, mica, and/or chlorite. Some of these rocks are transitional to slate or schist. Thin quartz veins are frequent. The siltstone/shale particles are typically rounded to subrounded and equant to elongated in shape. About $\frac{2}{3}$ of the siltstone and shale particles are flat.

Other rock types present in the coarser fractions include volcanic (21%) and plutonic (11%) rocks. The volcanic rocks include a variety of holocrystalline intermediate to siliceous rocks and a few basalts. The groundmass of these rocks generally consists of microgranular quartz and feldspar or chert. Most of the volcanic rocks are metamorphosed to varying degrees, with some grading into quartz schist. The plutonic rocks in this sample are mostly medium-grained granitic rocks.

The proportion of free mineral grains increases with decreasing grain size. Mineral grains in the fine fractions consist primarily of quartz and feldspar, with small amounts of mafic minerals. Some fine-grained rock fragments, mostly siltstone/shale and metavolcanic rocks, persist into the finer fractions.

The sandstones in the #4+ fractions are generally fresh, sound, hard, and tough. Most grains require a light hammer blow (with a 3-lb hammer on a steel anvil) to break. Two percent of the sandstone particles in the #8 fraction were weathered. The weathered sandstone is much less tough but generally not friable. The sandstone particles in the finer fractions are less tough and can be crushed with forceps. The sandstones break down to a mixture of hard grains, mostly quartz, and soft clay/mica matrix.

The siltstone/shale particles are fresh, sound, moderately hard, and moderately tough (can be crushed by a very light tap from the hammer). Grains with quartz veins are hard and quite tough. The volcanic and granitic rocks are generally very hard and tough.

The observations and conclusions given above are ACG's professional opinions based on laboratory observation of the samples as submitted and on information supplied by the client. Extension of these observations or conclusions to the product represented by the samples is the responsibility of the user. No warranty, express or implied, is made or intended in connection with the above investigation, or by the furnishing of this report, or by any other oral or written statement.

We appreciate the opportunity to be of service to you. If you have any questions, please call us at (805) 642-8180.

Respectfully submitted,
Analytical Consulting Group, Inc.

Michael R. Tiffany, Petrographer
Analytical Consulting Group, Inc.
Professional Geologist No. 6750



ASTM C-295 Petrographic Analysis
 SVRT Sample 3: BH-26 @ 56.7 ft
 SP-SC

Rock/Mineral Type	Size Fraction									Weighted Average
	3/8-in	#4	#8	#16	#30	#50	#100	#200	PAN	
Sandstone	58.5%	61.0%	49.0%	51.0%	40.0%	16.8%	31.1%	5.9%		45.0%
Sandstone ^w			2.0%							0.2%
Siltstone	2.0%	11.0%	13.0%	10.0%	4.0%	5.9%	8.7%	10.9%	20.0%	6.7%
Volcanic Rocks	17.7%	14.0%	29.0%	30.0%	29.0%	23.8%	12.6%	18.8%	10.0%	20.5%
Plutonic Rocks	21.8%	13.0%	6.0%	7.0%	7.0%	2.0%	1.9%		0.0%	11.0%
Quartz		1.0%	0.0%	2.0%	9.0%	38.6%	35.0%	53.5%	40.0%	12.2%
Feldspar			1.0%		11.0%	12.9%	9.7%	9.9%	20.0%	4.2%
Mafic Minerals							1.0%	1.0%	10.0%	0.1%
Weight Fraction	32.2%	14.7%	10.2%	7.0%	6.8%	16.2%	9.7%	3.1%	0.1%	

^w = weathered

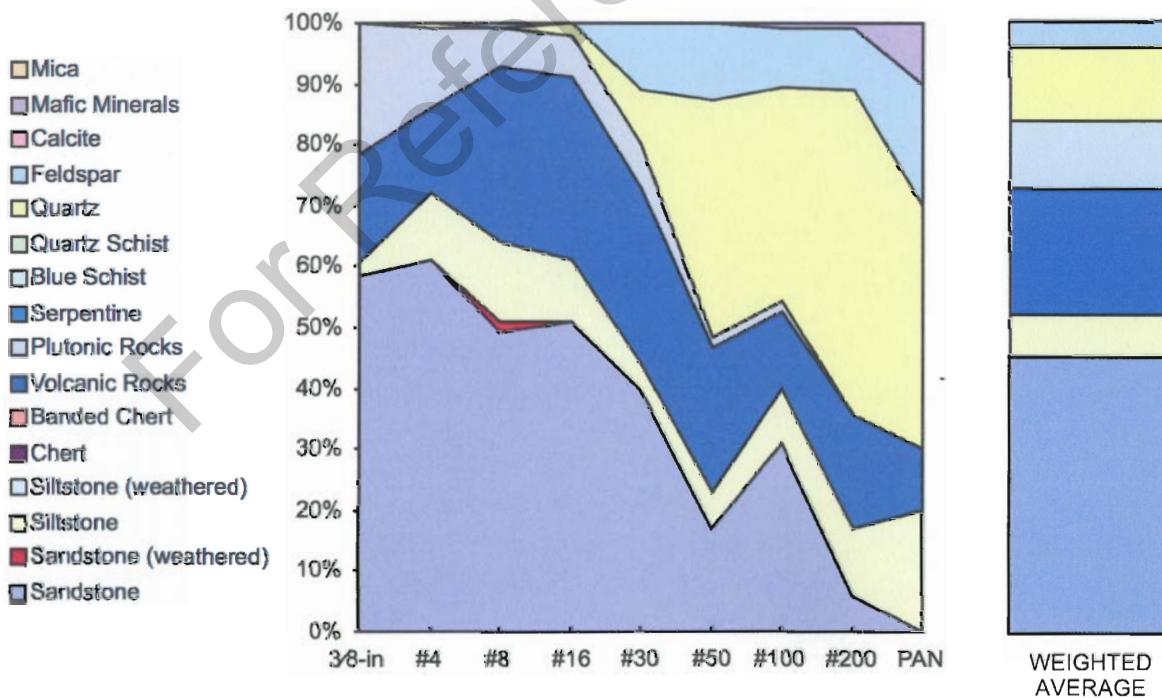

SVRT Sample 3: BH-26 @ 56.7 ft



+3/8"



#4



#8



#16

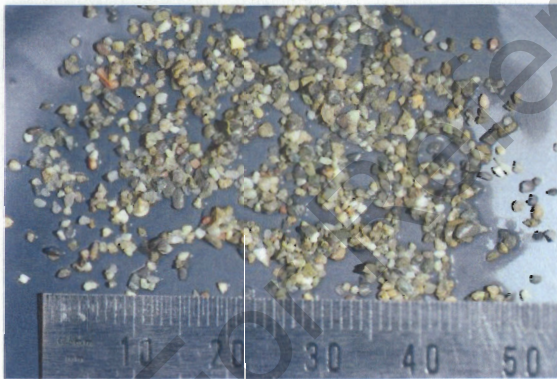

#30

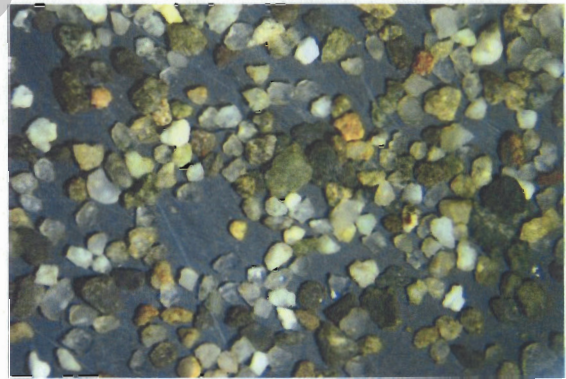

#50

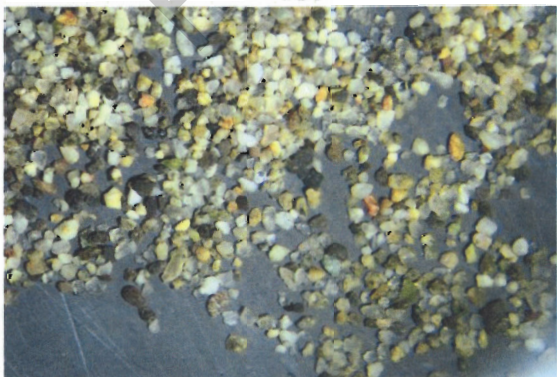

#100





June 26, 2008

ACG Lab No. P0804-555

CAMET Research, Inc.
6409 Camino Vista
Goleta, CA 93117
Attn: Dr. Ludwig Keller

Subject: ASTM C-295 Petrographic Examination of Soil Sample, SVRT Project

One sample of sandy gravel, identified as SVRT Sample 5: **BH-31 @ 61.2 ft**, was submitted to Analytical Consulting Group, Inc. (ACG) for petrographic examination. The purpose of the examination was to determine the lithological composition of the sample. The sample identification and the USCS classification assigned by the client is listed in the attached table.

The sample was sieved into fractions retained on the $\frac{3}{8}$ -in, #4, #8, #16, #30, #50, #100, #200, and passing #200 sieves. Each fraction (except the $\frac{3}{8}$ -in) was further split to yield approximately 100 particles for analysis.

The examination was conducted in accordance with ASTM C-295. The examination was performed using a stereobinocular microscope at 5x to 40x magnification. The finest sand fractions and some crushed grains from coarser fractions were examined immersed in refractive index liquid, using the polarized-light microscope at up to 400x magnification. The enclosed table and charts present the lithologic data for the samples, given as percent by particle count (approximate weight percent) for each size fraction. A weighted average is calculated for the sample using the fraction weights determined by the sieve analysis. The sample data is presented in the attached table and chart. The analytical sensitivity for this method is approximately 0.1% for the weighted average of the sample.

In general, the sample is composed primarily of fine-grained sandstones, siltstones, and mineral grains (quartz and feldspar) derived from the rocks. Lithic clasts dominate in the larger size fractions and discrete mineral grains in the finer fractions.

Sandstones make up about 52% of the sample. The sandstones range from greywacke to quartz wacke, with lithic to arkosic types dominating. The sandstones are well cemented and some have probably undergone some metamorphism. The matrix consists of clay, mica, and/or chlorite, with variable amounts of iron oxide. No carbonates are present. Thin quartz veins are frequent in the greywackes. The sandstone particles are tan, grey, green, or reddish in color, generally equant, and rounded to subangular, with a few angular crushed particles.

Dark grey siltstone and shale constitute about 7% of the sample. These rocks consist primarily of silt-sized or smaller quartz grains with clay, mica, and/or chlorite. Some of these rocks are transitional to slate or schist. Thin quartz veins are frequent. The siltstone/shale particles are

typically rounded to subrounded and equant to elongated in shape. About $\frac{2}{3}$ of the siltstone and shale particles are flat.

Other rock types present in the coarser fractions include volcanic and plutonic rocks. The volcanic rocks include a variety of holocrystalline intermediate to siliceous rocks and a few basalts. The groundmass of these rocks generally consists of microgranular quartz and feldspar or chert. Most of the volcanic rocks are metamorphosed to varying degrees, with some grading into quartz schist. The plutonic rocks consist primarily of a variety of granitic rocks and some diabase.

The proportion of free mineral grains increases with decreasing grain size. Mineral grains in the fine fractions consist primarily of quartz and feldspar, with trace amounts of amphibole, chlorite, biotite, epidote, and iron oxides. Some fine-grained rock fragments, mostly siltstone/shale and metavolcanic rocks, persist into the finer fractions.

The sandstones in the #4+ fractions are generally fresh, sound, hard, and tough. Most grains require a light hammer blow (with a 3-lb hammer on a steel anvil) to break. The sandstone particles in the finer fractions are less tough and can be crushed with forceps. The sandstones break down to a mixture of hard grains, mostly quartz, and soft clay/mica matrix.

The siltstone/shale particles are fresh, sound, moderately hard, and moderately tough (can be crushed by a very light tap from the hammer) to moderately soft (crush easily with forceps). Grains with quartz veins are hard and quite tough. The volcanic and plutonic rocks are generally very hard and tough.

The observations and conclusions given above are ACG's professional opinions based on laboratory observation of the samples as submitted and on information supplied by the client. Extension of these observations or conclusions to the product represented by the samples is the responsibility of the user. No warranty, express or implied, is made or intended in connection with the above investigation, or by the furnishing of this report, or by any other oral or written statement.

We appreciate the opportunity to be of service to you. If you have any questions, please call us at (805) 642-8180.

Respectfully submitted,
Analytical Consulting Group, Inc.

Michael R. Tiffany, Petrographer
Analytical Consulting Group, Inc.
Professional Geologist No. 6750



ASTM C-295 Petrographic Analysis
SVRT Sample 5: BH-31 @ 61.2 ft
GP-GM

Rock/Mineral Type	Size Fraction									Weighted Average
	3/8-in	#4	#8	#16	#30	#50	#100	#200	PAN	
Sandstone	85.7%	53.5%	50.5%	40.4%	29.7%	9.0%	1.9%			52.4%
Siltstone		4.0%	15.2%	7.7%	9.9%	6.0%	1.9%	5.0%	15.0%	4.9%
Shale		6.9%	4.0%		2.0%					2.0%
Volcanic Rocks	4.8%	19.8%	23.2%	32.7%	33.7%	18.0%	20.0%	15.0%	10.0%	16.8%
Plutonic Rocks	9.5%	15.8%	7.1%	14.4%	15.8%	1.0%				9.3%
Quartz				1.0%	8.9%	54.0%	67.6%	40.0%	30.0%	11.6%
Feldspar				3.8%		10.0%	7.6%	15.0%	15.0%	2.2%
Mafic Minerals						1.0%	1.0%	25.0%	30.0%	0.9%
Mica						1.0%				0.1%
Weight Fraction	34.0%	18.1%	15.1%	9.4%	4.4%	7.1%	9.0%	2.7%	0.2%	

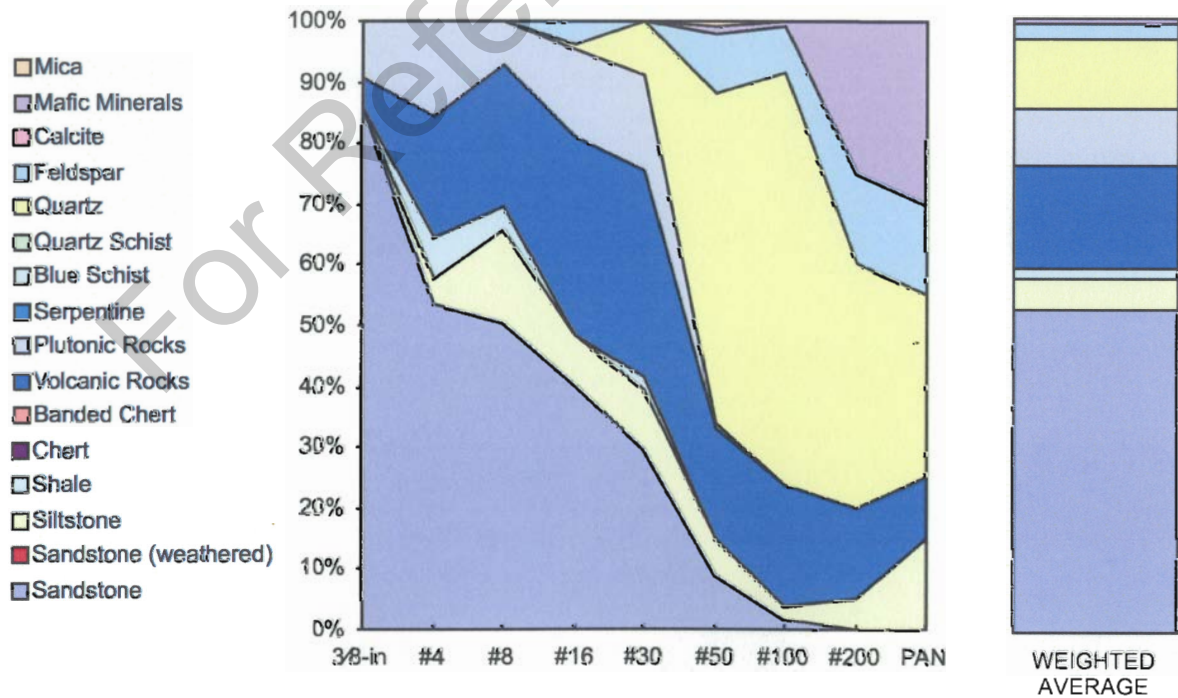

SVRT Sample 5: BH-31 @ 61.2 ft



3/8"



#4



#8



#16



#30

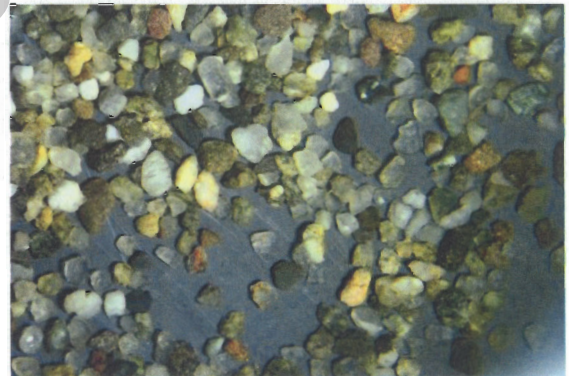

#50

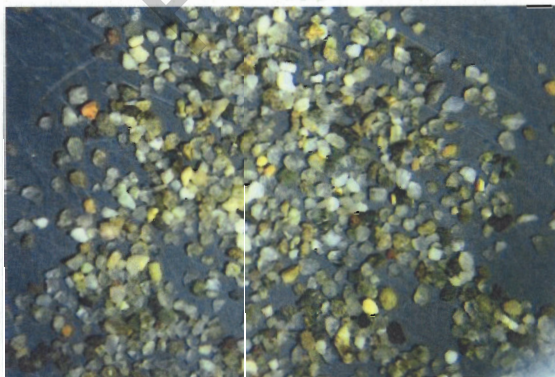

#100





June 30, 2008

ACG Lab No. P0804-555

CAMET Research, Inc.
6409 Camino Vista
Goleta, CA 93117
Attn: Dr. Ludwig Keller

Subject: ASTM C-295 Petrographic Examination of Soil Sample, SVRT Project

One sample of soil, identified as SVRT Sample 7: **BH-78 @ 26 ft**, was submitted to Analytical Consulting Group, Inc. (ACG) for petrographic examination. The purpose of the examination was to determine the lithological composition of the sample. The sample identification and the USCS classification assigned by the client is given in the attached table.

The sample was sieved into fractions retained on the $\frac{3}{8}$ -in, #4, #8, #16, #30, #50, #100, #200, and passing #200 sieves. Each fraction (except the $\frac{3}{8}$ -in) was further split to yield approximately 100 particles for analysis.

The examination was conducted in accordance with ASTM C-295 using a stereobinocular microscope at 5x to 40x magnification. The finest sand fractions and some crushed grains from coarser fractions were examined immersed in refractive index liquid, using the polarized-light microscope at up to 400x magnification. The enclosed table and charts present the lithologic data for the samples, given as percent by particle count (approximate weight percent) for each size fraction. The composition of the $\frac{3}{8}$ " sample was determined by weighing each type of rock rather than particle count. A weighted average is calculated for the sample using the fraction weights determined by the sieve analysis. The sample data is presented in the attached table and chart. The analytical sensitivity for this method is approximately 0.1% for the weighted average of the sample.

In general, the sample is composed primarily of fine-grained sandstones, siltstones, and mineral grains (quartz and feldspar) derived from the rocks. Lithic clasts dominate in the larger size fractions and discrete mineral grains in the finer fractions.

Sandstones make up about 65% of the sample. The sandstones range from greywacke to quartz wacke, with lithic to arkosic types dominating. The sandstones are well cemented and some have probably undergone some metamorphism. The matrix consists of clay, mica, and/or chlorite, with variable amounts of iron oxide. No carbonates are present. Thin quartz veins are frequent in the greywackes. The sandstone particles are tan, grey, green, or reddish in color, generally equant, and rounded to subangular, with a few angular crushed particles. A few weathered sandstone particles are present in the coarsest fractions.

Dark grey siltstone and shale constitute about 12% of the sample. These rocks consist primarily of silt-sized quartz grains with clay, mica, and/or chlorite. Some of these rocks are transitional to slate

or schist. Thin quartz veins are frequent. The siltstone/shale particles are typically rounded to subrounded and equant to elongated in shape. About $\frac{2}{3}$ of the siltstone and shale particles are flat.

Minor rock types present in the coarser fractions include volcanic rocks, granitic rocks, and diabase. The granitic rocks and diabase are grouped as plutonic rocks. The volcanic rocks include a variety of holocrystalline intermediate to siliceous rocks. The groundmass of these rocks generally consists of microgranular quartz and feldspar or chert. Most of the volcanic rocks are metamorphosed to varying degrees, with some grading into quartz schist.

The proportion of free mineral grains increases with decreasing grain size. Mineral grains in the fine fractions consist primarily of quartz and feldspar, with trace amounts of amphibole, chlorite, biotite, epidote, and iron oxides. Some fine-grained rock fragments, mostly siltstone/shale and metavolcanic rocks, persist into the finer fractions.

The sandstones in the #4+ fractions are generally fresh, sound, hard, and tough. Most grains require a light hammer blow (with a 3-lb hammer on a steel anvil) to break. Some samples have small quantities of weathered sandstone in the coarse fractions. The weathered sandstone is much less tough but generally not friable. The sandstone particles in the finer fractions are less tough and can be crushed with forceps. The sandstones break down to a mixture of hard grains, mostly quartz, and soft clay/mica matrix material.

The siltstone/shale particles are fresh, sound, moderately hard, and moderately tough (can be crushed by a very light tap from the hammer). Grains with quartz veins are hard and quite tough. The volcanic and plutonic rocks are generally very hard and tough.

The observations and conclusions given above are ACG's professional opinions based on laboratory observation of the samples as submitted and on information supplied by the client. Extension of these observations or conclusions to the product represented by the samples is the responsibility of the user. No warranty, express or implied, is made or intended in connection with the above investigation, or by the furnishing of this report, or by any other oral or written statement.

We appreciate the opportunity to be of service to you. If you have any questions, please call us at (805) 642-8180.

Respectfully submitted,
Analytical Consulting Group, Inc.

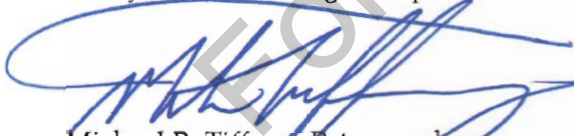

Michael R. Tiffany, Petrographer
Analytical Consulting Group, Inc.
Professional Geologist No. 6750



ASTM C-295 Petrographic Analysis
SVRT Sample 7: BH-78 @ 26 ft
GW-GC

Rock/Mineral Type	Size Fraction									Weighted Average
	3/8-in	#4	#8	#16	#30	#50	#100	#200	PAN	
Sandstone	81.1%	69.0%	71.0%	64.0%	38.0%	28.6%	7.9%			63.6%
Sandstone ^W	3.1%	1.9%								1.3%
Siltstone	6.5%	13.5%	14.0%	13.0%	22.2%	14.3%	5.9%	10.0%	25.0%	11.8%
Volcanic Rocks		8.4%	7.0%	14.0%	7.4%	5.4%	1.0%			5.6%
Plutonic Rocks	7.7%	5.8%	7.0%	2.0%	9.3%	6.3%				6.0%
Quartz	1.6%	1.3%	1.0%	7.0%	16.7%	33.0%	54.5%	60.0%	30.0%	8.4%
Feldspar					6.5%	11.6%	28.7%	30.0%	15.0%	3.0%
Calcite						0.9%				0.1%
Mafic Minerals							2.0%		30.0%	0.1%
Weight Fraction	28.9%	23.4%	17.2%	10.9%	6.6%	6.6%	4.1%	1.8%	0.2%	

^W = weathered

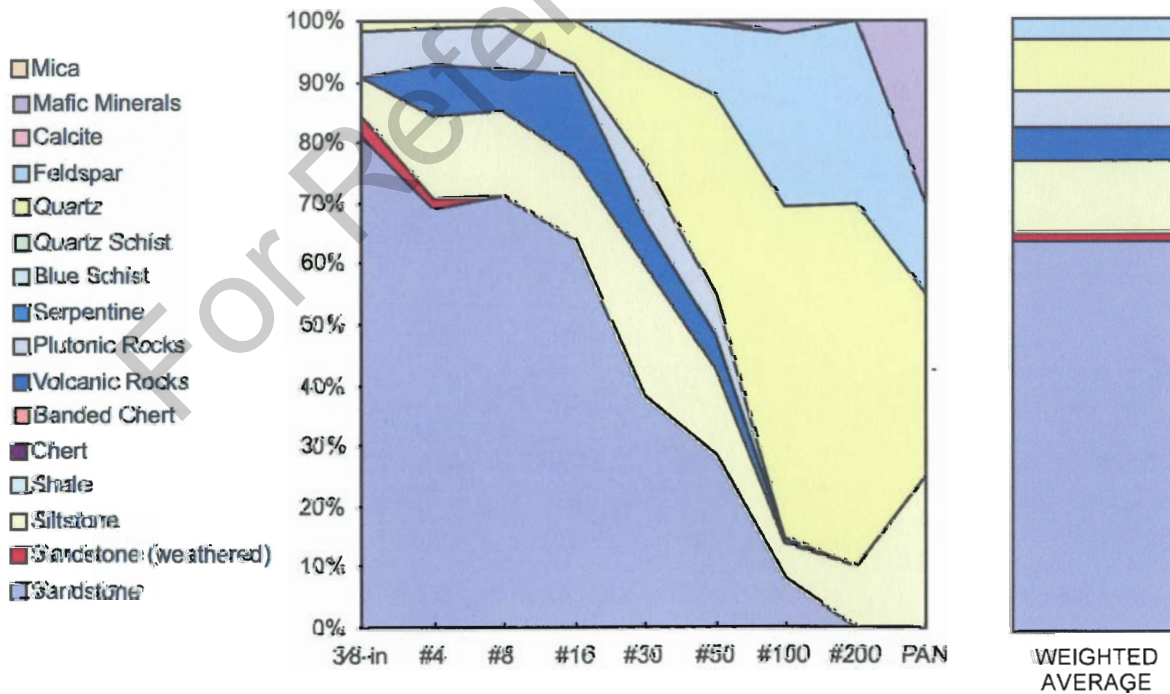

SVRT Sample 7: BH-78 @ 25 ft



3/8"



#4



#8



#16

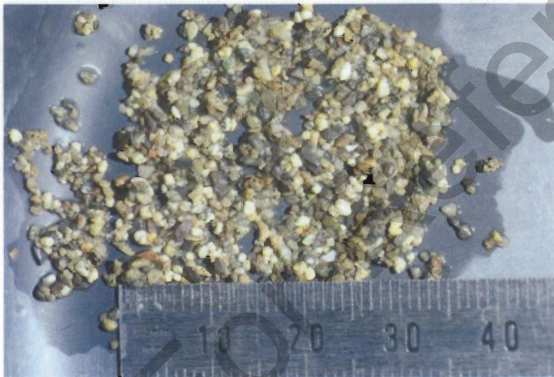

#30

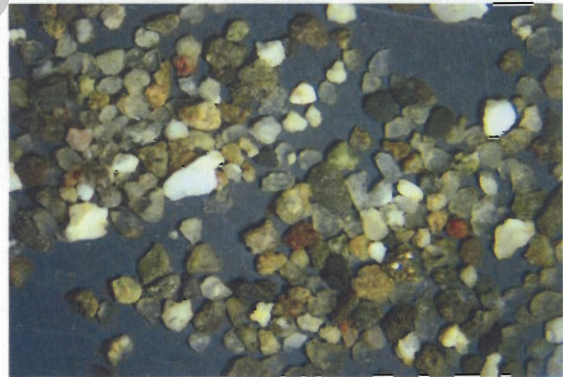

#50

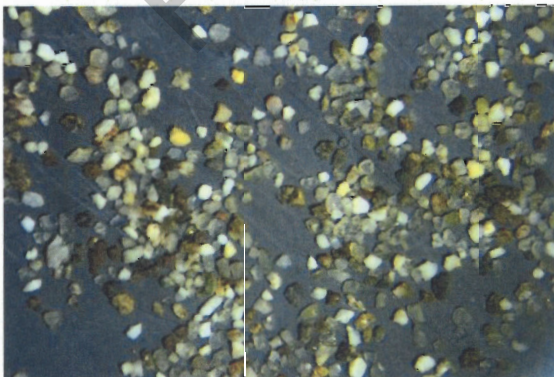

#100



Analytical Consulting Group, Inc.

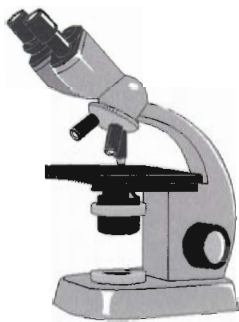

June 2, 2008

ACG Lab No. P0804-555

CAMET Research, Inc.
6409 Camino Vista
Goleta, CA 93117
Attn: Dr. Ludwig Keller

Subject: ASTM C-295 Petrographic Examination of Soil Sample, SVRT Project

One sample of soil, identified as SVRT Sample 8: **MW-6I @ 69 ft**, was submitted to Analytical Consulting Group, Inc. (ACG) for petrographic examination. The purpose of the examination was to determine the lithological composition of the sample. The sample identification and the USCS classification assigned by the client is listed in the attached table.

The sample was sieved into fractions retained on the $\frac{3}{8}$ -in, #4, #8, #16, #30, #50, #100, #200, and passing #200 sieves. Each fraction (except the $\frac{3}{8}$ -in) was further split to yield approximately 100 particles for analysis. The $\frac{3}{8}$ -in sample consisted of just 17 particles.

The examinations were conducted in accordance with ASTM C-295. The examinations were performed using a stereobinocular microscope at 5x to 40x magnification. The finest sand fractions and some crushed grains from coarser fractions were examined immersed in refractive index liquid, using the polarized-light microscope at up to 400x magnification. Selected grains were thin-sectioned and examined with the polarized-light microscope to assist in rock identification. The enclosed table and charts present the lithologic data for the samples, given as percent by particle count (approximate weight percent) for each size fraction. The composition of the $\frac{3}{8}$ " sample was determined by weight rather than particle count. A weighted average is calculated for the sample using the fraction weights determined by the sieve analysis. The sample data is presented in the attached table and chart. The analytical sensitivity for this method is approximately 0.1% for the weighted average of the sample.

In general, the sample is composed primarily of fine-grained sandstones, volcanic rocks, and mineral grains (quartz and feldspar) derived from the rocks. Lithic clasts dominate in the larger size fractions and discrete mineral grains in the finer fractions.

Volcanic rocks constitute about 25% of the sample. The volcanic rocks include a variety of holocrystalline intermediate to siliceous rocks and a few basalts. The groundmass of these rocks generally consists of microgranular quartz and feldspar or chert. Most of the volcanic rocks are metamorphosed to varying degrees, with some grading into quartz schist.

Sandstones make up about 17% of the sample. The sandstones range from greywacke to quartz wacke, with lithic to arkosic types dominating. The sandstones are well cemented and some have probably undergone some metamorphism. The matrix consists of clay, mica, and/or chlorite, with

variable amounts of iron oxide. No carbonates are present. Thin quartz veins are frequent in the greywackes. The sandstone particles are tan, grey, green, or reddish in color, generally equant, and rounded to subangular, with a few angular crushed particles.

Dark grey siltstone and shale constitute about 14% of the sample. These rocks consist primarily of silt-sized quartz grains with clay, mica, and/or chlorite. Some of these rocks are transitional to slate or schist. Thin quartz veins are frequent. The siltstone/shale particles are typically rounded to subrounded and equant to elongated in shape. About $\frac{2}{3}$ of the siltstone and shale particles are flat. A few weathered siltstone particles are present.

Other rock types present in the coarser fractions include granitic rocks, gabbro, and diabase. These rocks are grouped as plutonic rocks.

The proportion of free mineral grains increases with decreasing grain size. Mineral grains in the fine fractions consist primarily of quartz, with smaller amounts of feldspar, amphibole, chlorite, biotite, epidote, and iron oxides. Some fine-grained rock fragments, mostly siltstone and metavolcanic rocks, persist into the finer fractions.

The sandstones in the #4+ fractions are generally fresh, sound, hard, and tough. Most grains require a light hammer blow (with a 3-lb hammer on a steel anvil) to break. The sandstone particles in the finer fractions are less tough and can be crushed with forceps. The sandstones break down to a mixture of hard grains, mostly quartz, and soft clay/mica matrix.

The siltstone/shale particles are fresh, sound, moderately hard, and moderately tough (can be crushed by a very light tap from the hammer). Grains with quartz veins are hard and quite tough. The volcanic rocks and plutonic rocks are generally very hard and tough. Small quantities of weathered siltstone are present in the coarse fractions. These particles are generally soft to friable.

The observations and conclusions given above are ACG's professional opinions based on laboratory observation of the samples as submitted and on information supplied by the client. Extension of these observations or conclusions to the product represented by the samples is the responsibility of the user. No warranty, express or implied, is made or intended in connection with the above investigation, or by the furnishing of this report, or by any other oral or written statement.

We appreciate the opportunity to be of service to you. If you have any questions, please call us at (805) 642-8180.

Respectfully submitted,
Analytical Consulting Group, Inc.



Michael R. Tiffany, Petrographer
Analytical Consulting Group, Inc.
Professional Geologist No. 6750

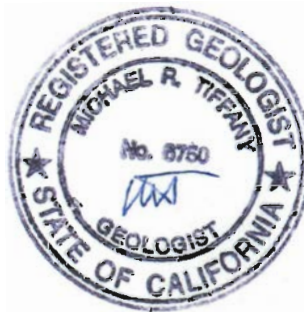

ASTM C-295 Petrographic Analysis
SVRT Sample 8: MW-6I @ 69 ft
SP with gravel

Rock/Mineral Type	Size Fraction									Weighted Average
	3/8-in	#4	#8	#16	#30	#50	#100	#200	PAN	
Sandstone	52.9%	59.7%	39.0%	40.6%	16.8%	4.3%				16.9%
Siltstone	5.9%	8.1%	17.0%	11.9%	12.9%	17.0%	12.5%	15.0%	20.0%	13.2%
Siltstone ^w	5.9%		2.0%							0.8%
Volcanic Rocks	11.8%	29.0%	30.0%	29.7%	43.6%	29.8%	16.3%	5.0%	5.0%	24.8%
Plutonic Rocks	17.6%	3.2%	10.0%	12.9%	5.0%					3.8%
Quartz Schist	5.9%		2.0%		1.0%					0.9%
Quartz				3.0%	15.8%	42.6%	66.3%	50.0%	35.0%	34.2%
Feldspar				2.0%	5.0%	5.3%	3.8%	20.0%	15.0%	4.3%
Mafic Minerals							1.0%	10.0%	25.0%	0.7%
Mica						1.1%				0.4%
Weight Fraction	12.7%	6.8%	3.1%	3.6%	12.1%	33.3%	23.6%	4.7%	0.2%	

^w = weathered

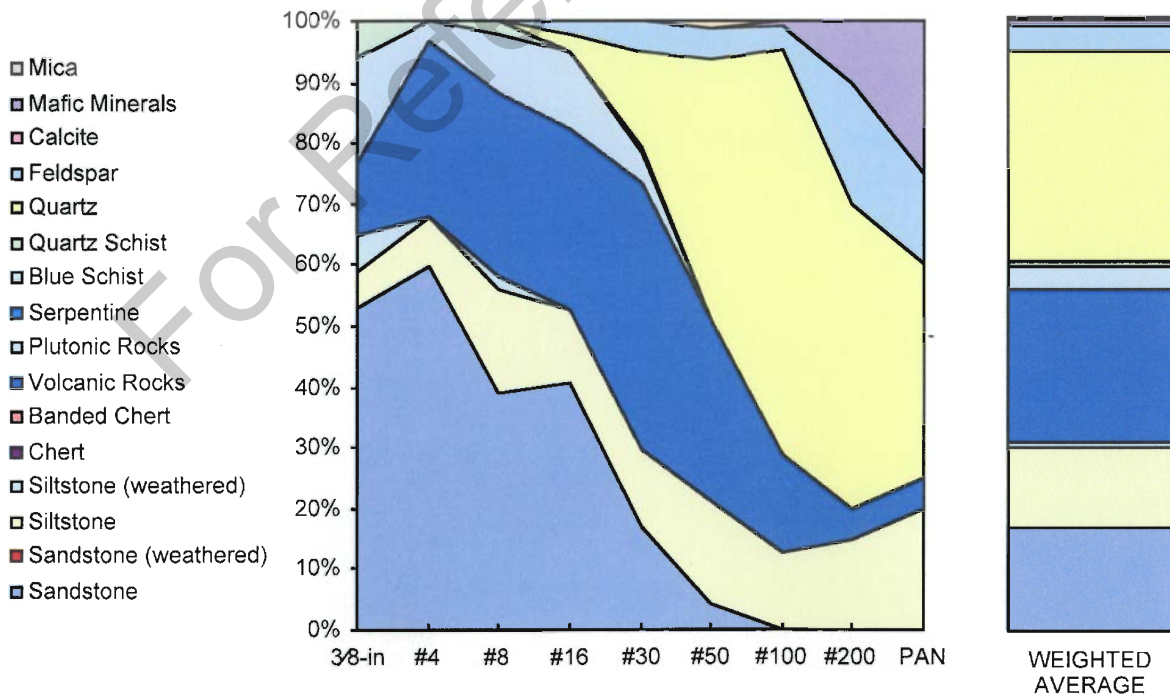

Sample 8: MW-61 @ 69 ft



3/8"



#4



#8



#16



#30

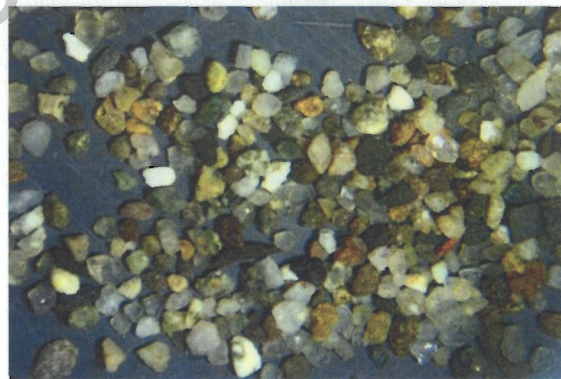

#50

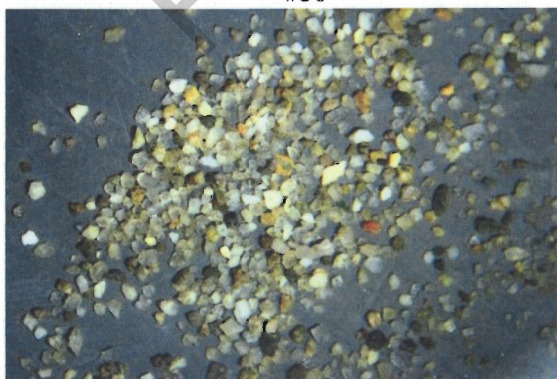

#100



Analytical Consulting Group, Inc.

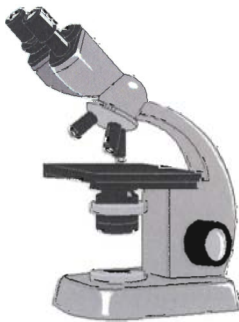

June 3, 2008

ACG Lab No. P0804-555

CAMET Research, Inc.
6409 Camino Vista
Goleta, CA 93117
Attn: Dr. Ludwig Keller

Subject: ASTM C-295 Petrographic Examination of Soil Sample, SVRT Project

One sample of soil, identified as SVRT Sample 9: **MW-2G @ 70.5 ft**, was submitted to Analytical Consulting Group, Inc. (ACG) for petrographic examination. The purpose of the examination was to determine the lithological composition of the sample. The sample identification and the USCS classification assigned by the client is listed in the attached table.

The sample was sieved into fractions retained on the $\frac{3}{8}$ -in, #4, #8, #16, #30, #50, #100, #200, and passing #200 sieves. Each fraction (except the $\frac{3}{8}$ -in) was further split to yield approximately 100 particles for analysis.

The examinations were conducted in accordance with ASTM C-295. The examinations were performed using a stereobinocular microscope at 5x to 40x magnification. The finest sand fractions and some crushed grains from coarser fractions were examined immersed in refractive index liquid, using the polarized-light microscope at up to 400x magnification. The enclosed table and charts present the lithologic data for the samples, given as percent by particle count (approximate weight percent) for each size fraction. A weighted average is calculated for the sample using the fraction weights determined by the sieve analysis. The sample data is presented in the attached table and chart. The analytical sensitivity for this method is approximately 0.1% for the weighted average of the sample.

This sample is composed primarily of fine-grained sandstones, chert, and mineral grains (quartz and feldspar) derived from coarser rocks. Lithic clasts dominate in the larger size fractions and discrete mineral grains in the finer fractions.

Sandstones make up about 56% of the sample. The sandstones range from greywacke to quartz wacke, with lithic to arkosic types dominating. The sandstones are well cemented and some have probably undergone some metamorphism. The matrix consists of clay, mica, and/or chlorite, with variable amounts of iron oxide. No carbonates are present. Thin quartz veins are frequent in the greywackes. The sandstone particles are tan, grey, green, or reddish in color, generally equant, and rounded to subangular, with a few angular crushed particles.

Chert makes up about 15% of the sample. The cherts consist of microgranular quartz and chalcedony and are mostly red, green, or tan in color. About $\frac{1}{4}$ of the cherts are banded, with thin lamellae of different grain sizes.

Volcanic rocks make up about 9% of the sample. The volcanic rocks include a variety of holocrystalline intermediate to siliceous rocks. The groundmass of these rocks generally consists of microgranular quartz and feldspar or chert. Most of the volcanic rocks are metamorphosed to varying degrees, with some grading into quartz schist.

Granitic rocks and diabase are grouped as plutonic rocks. The plutonic rocks make up about 5% of the sample. The plutonic rocks are variable but are generally medium-grained rocks consisting of feldspar with quartz and/or mafic minerals.

Dark grey siltstone and shale constitute about 2% of the sample. These rocks consist primarily of silt-sized quartz grains with clay, mica, and/or chlorite. Some of these rocks are transitional to slate or schist. Thin quartz veins are frequent. The siltstone/shale particles are typically rounded to subrounded and equant to elongated in shape. About $\frac{2}{3}$ of the siltstone and shale particles are flat.

The proportion of free mineral grains increases with decreasing grain size. Mineral grains in the fine fractions consist primarily of quartz and feldspar, with trace amounts of amphibole, chlorite, biotite, epidote, and iron oxides. Some fine-grained rock fragments, mostly siltstone/shale, chert, and metavolcanic rocks, persist into the finer fractions.

The sandstones in the #4+ fractions are generally fresh, sound, hard, and tough. Most grains require a light hammer blow (with a 3-lb hammer on a steel anvil) to break. Some samples have small quantities of weathered sandstone in the coarse fractions. The sandstone particles in the finer fractions are less tough and can be crushed with forceps. The sandstones break down to a mixture of hard grains, mostly quartz, and soft clay/mica matrix.

The siltstone/shale particles are fresh, sound, moderately hard, and moderately tough (can be crushed by a very light tap from the hammer). Grains with quartz veins are hard and quite tough. The cherts are very hard and extremely tough, requiring a heavy hammer blow to break them. The volcanic rocks, and plutonic rocks are generally very hard and tough.

The observations and conclusions given above are ACG's professional opinions based on laboratory observation of the samples as submitted and on information supplied by the client. Extension of these observations or conclusions to the product represented by the samples is the responsibility of the user. No warranty, express or implied, is made or intended in connection with the above investigation, or by the furnishing of this report, or by any other oral or written statement.

We appreciate the opportunity to be of service to you. If you have any questions, please call us at (805) 642-8180.

Respectfully submitted,
Analytical Consulting Group, Inc.

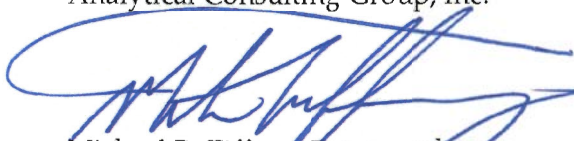

Michael R. Tiffany, Petrographer
Analytical Consulting Group, Inc.
Professional Geologist No. 6750



ASTM C-295 Petrographic Analysis
SVRT Sample 9: MW-2G @ 70.5 ft
SW-SM

Rock/Mineral Type	Size Fraction									Weighted Average
	3/8-in	#4	#8	#16	#30	#50	#100	#200	PAN	
Sandstone	71.1%	72.0%	57.0%	43.1%	45.0%	42.2%	12.6%			55.8%
Siltstone				2.9%	12.2%	1.8%	3.9%	10.0%		1.8%
Chert	8.9%	7.0%	11.0%	13.7%	11.5%	22.0%	7.8%	15.0%	25.0%	10.5%
Banded Chert		7.0%	4.0%	9.8%	0.8%					3.9%
Volcanic Rocks	15.6%	7.0%	5.0%	12.7%	6.1%	1.8%				8.9%
Plutonic Rocks		5.0%	15.0%	2.9%	0.8%					4.8%
Quartz Schist			1.0%							0.2%
Quartz	4.4%	2.0%	5.0%	10.8%	17.6%	26.6%	66.0%	50.0%	50.0%	11.7%
Feldspar			2.0%	3.9%	6.1%	5.5%	9.7%	20.0%	10.0%	2.9%
Clay									10.0%	0.0%
Mica								5.0%	5%	0.2%
Weight Fraction	20.9%	26.0%	20.5%	12.2%	6.0%	4.8%	4.9%	4.6%	0.1%	

^w = weathered

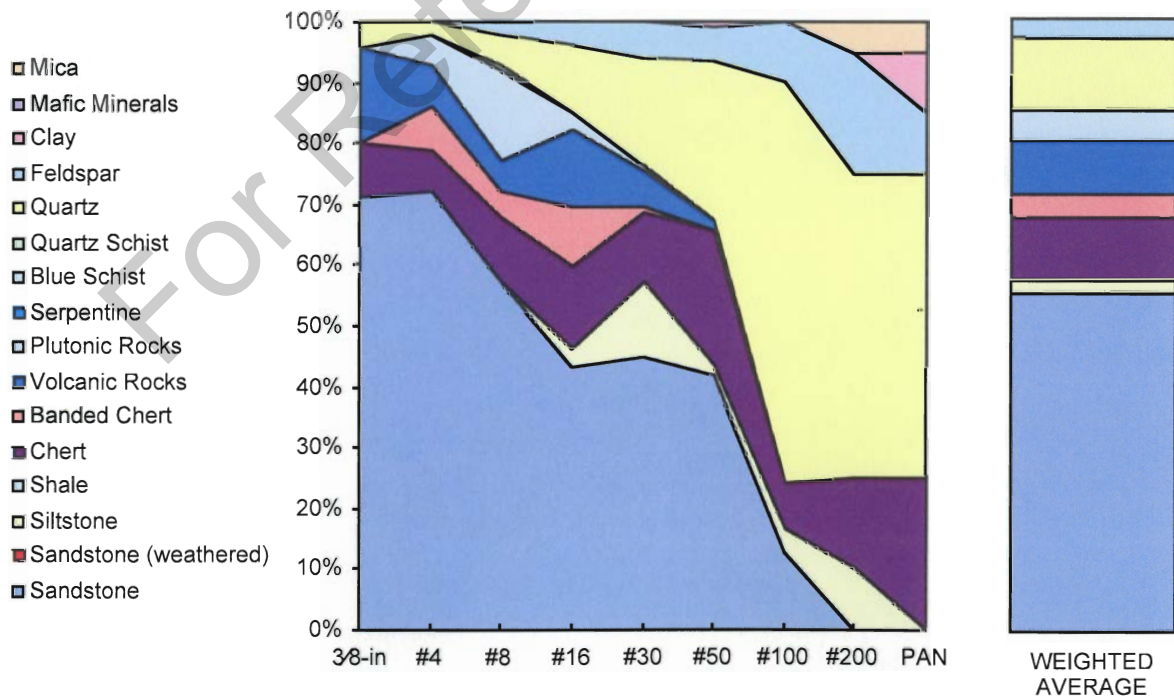

Sample 9: MW-2G @ 70.5



3/8"



#4



#8



#16



#30

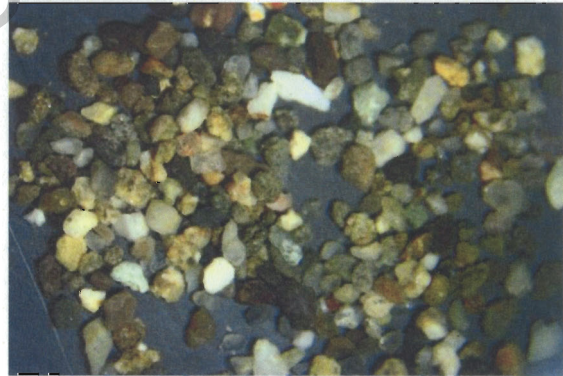

#50

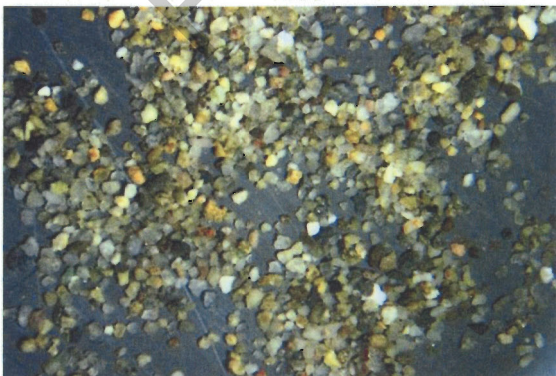

#100



Analytical Consulting Group, Inc.



June 3, 2008

ACG Lab No. P0804-555

CAMET Research, Inc.
6409 Camino Vista
Goleta, CA 93117
Attn: Dr. Ludwig Keller

Subject: ASTM C-295 Petrographic Examination of Soil Sample, SVRT Project

One sample of soil, identified as SVRT Sample 10: **MW-8B @ 25.5 ft**, was submitted to Analytical Consulting Group, Inc. (ACG) for petrographic examination. The purpose of the examination was to determine the lithological composition of the sample. The sample identification and the USCS classification assigned by the client is listed in the attached table.

The sample was sieved into fractions retained on the $\frac{3}{8}$ -in, #4, #8, #16, #30, #50, #100, #200, and passing #200 sieves. Each fraction (except the $\frac{3}{8}$ -in) was further split to yield approximately 100 particles for analysis.

The examinations were conducted in accordance with ASTM C-295. The examinations were performed using a stereobinocular microscope at 5x to 40x magnification. The finest sand fractions and some crushed grains from coarser fractions were examined immersed in refractive index liquid, using the polarized-light microscope at up to 400x magnification. Selected grains were thin-sectioned and examined with the polarized-light microscope to assist in rock identification. The enclosed table and charts present the lithologic data for the samples, given as percent by particle count (approximate weight percent) for each size fraction. The composition of the $\frac{3}{8}$ " sample was determined by weight. A weighted average is calculated for the sample using the fraction weights determined by the sieve analysis. The sample data is presented in the attached table and chart. The analytical sensitivity for this method is approximately 0.1% for the weighted average of the sample.

In general, the sample is composed primarily of fine-grained sandstones, siltstones, volcanic rocks, and mineral grains (quartz and feldspar) derived from coarser rocks. Lithic clasts dominate in the larger size fractions and discrete mineral grains in the finer fractions.

Sandstones make up about 55% of the sample. The sandstones range from greywacke to quartz wacke, with lithic to arkosic types dominating. The sandstones are well cemented and some have probably undergone some metamorphism. The matrix consists of clay, mica, and/or chlorite, with variable amounts of iron oxide. No carbonates are present. Thin quartz veins are frequent in the greywackes. The sandstone particles are tan, grey, green, or reddish in color, generally equant, and rounded to subangular, with a few angular crushed particles.

Volcanic rocks constitute about 21% of the sample. The volcanic rocks include a variety of holocrystalline intermediate to siliceous rocks. The groundmass of these rocks generally consists of

microgranular quartz and feldspar or chert. Most of the volcanic rocks are metamorphosed to varying degrees, with some grading into quartz schist.

Dark grey siltstone and shale constitute about 9% of the sample. These rocks consist primarily of silt-sized quartz grains with clay, mica, and/or chlorite. Some of these rocks are transitional to slate or schist. Thin quartz veins are frequent. The siltstone/shale particles are typically rounded to subrounded and equant to elongated in shape. About $\frac{2}{3}$ of the siltstone and shale particles are flat.

Minor constituents include granitic rocks, diabase, chert, blueschist, and serpentine. The granitic rocks and diabase are grouped as plutonic rocks. The two serpentine particles found were partially serpentinized peridotite or greenstone, harder than pure serpentine.

The proportion of free mineral grains increases with decreasing grain size. Mineral grains in the fine fractions consist primarily of quartz and feldspar, with trace amounts of amphibole, chlorite, biotite, epidote, and iron oxides. Some fine-grained rock fragments, mostly siltstone/shale, chert, and metavolcanic rocks, persist into the finer fractions.

The sandstones in the #4+ fractions are generally fresh, sound, hard, and tough. Most grains require a light hammer blow (with a 3-lb hammer on a steel anvil) to break. The sandstone particles in the finer fractions are less tough and can be crushed with forceps. The sandstones break down to a mixture of hard grains, mostly quartz, and soft clay/mica matrix.

The siltstone/shale particles are fresh, sound, moderately hard, and moderately tough (can be crushed by a very light tap from the hammer). Grains with quartz veins are hard and quite tough. The chert, volcanic rocks, and plutonic rocks are generally very hard and tough.

The observations and conclusions given above are ACG's professional opinions based on laboratory observation of the samples as submitted and on information supplied by the client. Extension of these observations or conclusions to the product represented by the samples is the responsibility of the user. No warranty, express or implied, is made or intended in connection with the above investigation, or by the furnishing of this report, or by any other oral or written statement.

We appreciate the opportunity to be of service to you. If you have any questions, please call us at (805) 642-8180.

Respectfully submitted,
Analytical Consulting Group, Inc.

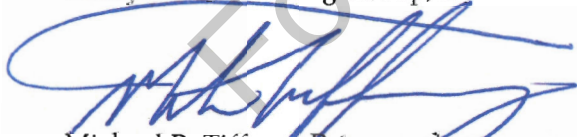

Michael R. Tiffany, Petrographer
Analytical Consulting Group, Inc.
Professional Geologist No. 6750



ASTM C-295 Petrographic Analysis
SVRT Sample 10: MW-8B @ 25.5 ft
GW-GM with sand

Rock/Mineral Type	Size Fraction									Weighted Average
	3/8-in	#4	#8	#16	#30	#50	#100	#200	PAN	
Sandstone	84.3%	57.0%	45.5%	31.7%	8.0%	2.2%				54.7%
Siltstone		8.0%	18.2%	20.8%	26.0%	2.2%	1.7%	20.0%		8.6%
Chert	1.6%	2.0%	2.0%							1.3%
Volcanic Rocks	6.0%	25.0%	28.3%	32.7%	34.0%	54.8%	25.2%	10.0%		20.5%
Plutonic Rocks	7.3%	8.0%	4.0%	4.0%	1.0%					5.3%
Serpentine	0.5%									0.2%
Blueschist	0.2%									0.1%
Quartz				3.0%	23.0%	31.2%	62.6%	45.0%		6.2%
Feldspar			2.0%	6.9%	8.0%	8.6%	8.7%	20.0%		2.7%
Mafic Minerals				1.0%		1.1%	1.7%	5.0%		0.3%
Weight Fraction	41.6%	14.5%	15.8%	11.3%	6.5%	5.6%	3.2%	1.5%	0.0%	

W = weathered

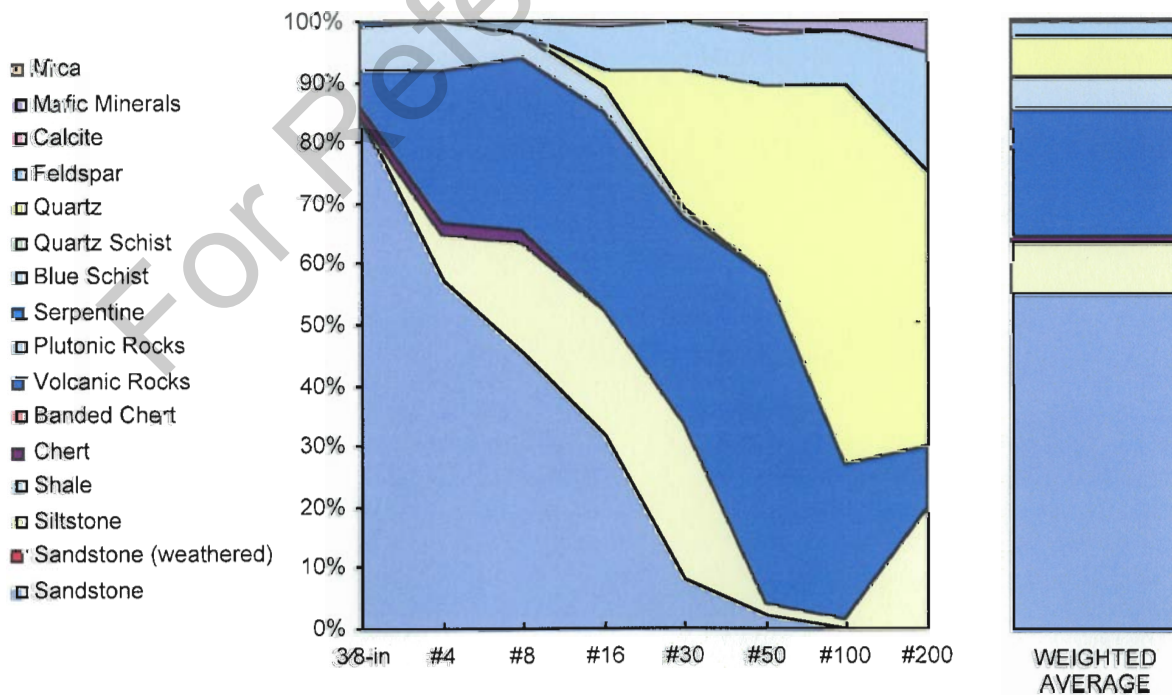

Sample 10: MW-8B @ 25.5'



3/8"+



#4



#8



#16



#30

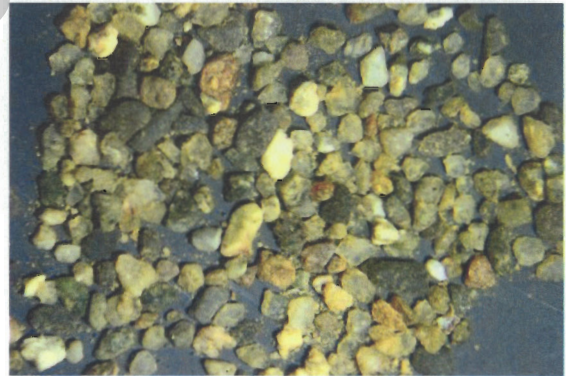

#50



#100



Analytical Consulting Group, Inc.



June 3, 2008

ACG Lab No. P0804-555

CAMET Research, Inc.
6409 Camino Vista
Goleta, CA 93117
Attn: Dr. Ludwig Keller

Subject: ASTM C-295 Petrographic Examination of Soil Sample, SVRT Project

One sample of soil, identified as SVRT Sample 11: **MW-8B @ 39 ft**, was submitted to Analytical Consulting Group, Inc. (ACG) for petrographic examination. The purpose of the examination was to determine the lithological composition of the sample. The sample identification and the USCS classification assigned by the client is listed in the attached table.

The sample was sieved into fractions retained on the #4, #8, #16, #30, #50, #100, #200, and passing #200 sieves. Each fraction (except the #4 and #8) was further split to yield approximately 100 particles for analysis.

The examinations were conducted in accordance with ASTM C-295. The examinations were performed using a stereobinocular microscope at 5x to 40x magnification. The finest sand fractions and some crushed grains from coarser fractions were examined immersed in refractive index liquid, using the polarized-light microscope at up to 400x magnification. The enclosed table and charts present the lithologic data for the samples, given as percent by particle count (approximate weight percent) for each size fraction. A weighted average is calculated for the sample using the fraction weights determined by the sieve analysis. The sample data is presented in the attached table and chart. The analytical sensitivity for this method is approximately 0.1% for the weighted average of the sample.

This sample is composed primarily of quartz grains, with smaller quantities of rock fragments and other mineral grains. Lithic clasts dominate in the larger size fractions and discrete mineral grains in the finer fractions. Because of the fineness of the material in this sample (SP-SM), quartz comprises about 59% of the sample.

Sandstones make up about 14% of the sample. The sandstones range from greywacke to quartz wacke, with lithic to arkosic types dominating. The sandstones are well cemented and some have probably undergone some metamorphism. The matrix consists of clay, mica, and/or chlorite, with variable amounts of iron oxide. No carbonates are present. Thin quartz veins are frequent in the greywackes. The sandstone particles are tan, grey, green, or reddish in color, generally equant, and rounded to subangular, with a few angular crushed particles. A few weathered sandstone particles are present.

Dark grey siltstone and shale constitute about 12% of the sample. These rocks consist primarily of silt-sized quartz grains with clay, mica, and/or chlorite. Some of these rocks are transitional to slate or schist. Thin quartz veins are frequent. The siltstone/shale particles are typically rounded to subrounded and equant to elongated in shape. About $\frac{2}{3}$ of the siltstone and shale particles are flat.

Minor lithic constituents include chert, volcanic rocks, and granitic (plutonic) rocks. The proportion of free mineral grains increases with decreasing grain size. Mineral grains in the finer fractions consist primarily of quartz and feldspar, with trace amounts of biotite, amphibole, chlorite, epidote, and iron oxides. Some fine-grained fragments of siltstone and chert persist into the finer fractions.

The sandstones in the #4+ fractions are generally fresh, sound, hard, and moderately tough. The sandstone particles can be crushed with forceps. Very small quantities of weathered sandstone are present. The weathered sandstone is much less tough but generally not friable. The sandstones break down to a mixture of hard grains, mostly quartz, and soft clay/mica matrix.

The siltstone/shale particles are fresh, sound, moderately hard, and moderately tough (can be crushed by a very light tap from the hammer). Grains with quartz veins are hard and quite tough. The chert, volcanic rocks, and plutonic rocks are generally very hard and tough.

The observations and conclusions given above are ACG's professional opinions based on laboratory observation of the samples as submitted and on information supplied by the client. Extension of these observations or conclusions to the product represented by the samples is the responsibility of the user. No warranty, express or implied, is made or intended in connection with the above investigation, or by the furnishing of this report, or by any other oral or written statement.

We appreciate the opportunity to be of service to you. If you have any questions, please call us at (805) 642-8180.

Respectfully submitted,
Analytical Consulting Group, Inc.

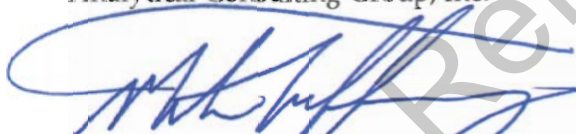

Michael R. Tiffany, Petrographer
Analytical Consulting Group, Inc.
Professional Geologist No. 6750



ASTM C-295 Petrographic Analysis
SVRT Sample 11: MW-8B @ 39 ft
SP-SM

Rock/Mineral Type	Size Fraction									Weighted Average
	3/8-in	#4	#8	#16	#30	#50	#100	#200	PAN	
Sandstone		100.0%	55.3%	58.9%	51.0%	32.4%	10.2%			14.0%
Sandstone ^w						1.9%				0.3%
Siltstone			18.4%	22.1%	20.2%	7.4%	12.0%	11.9%	10.0%	11.5%
Chert			5.3%	5.3%	5.8%	3.7%	1.9%	1.8%	15.0%	2.4%
Volcanic Rocks			5.3%	1.1%	1.0%					0.1%
Plutonic Rocks			7.9%	2.1%						0.1%
Quartz				6.3%	12.5%	44.4%	63.0%	73.4%	40.0%	59.2%
Feldspar			7.9%	4.2%	8.7%	9.3%	9.3%	9.2%	10.0%	9.1%
Mafic Minerals					1.0%	0.9%	2.8%	3.7%	20.0%	2.7%
Mica							0.9%		5.0%	0.5%
Weight Fraction	0.0%	0.5%	1.1%	1.5%	2.2%	17.5%	51.5%	25.0%	0.8%	

^w = weathered

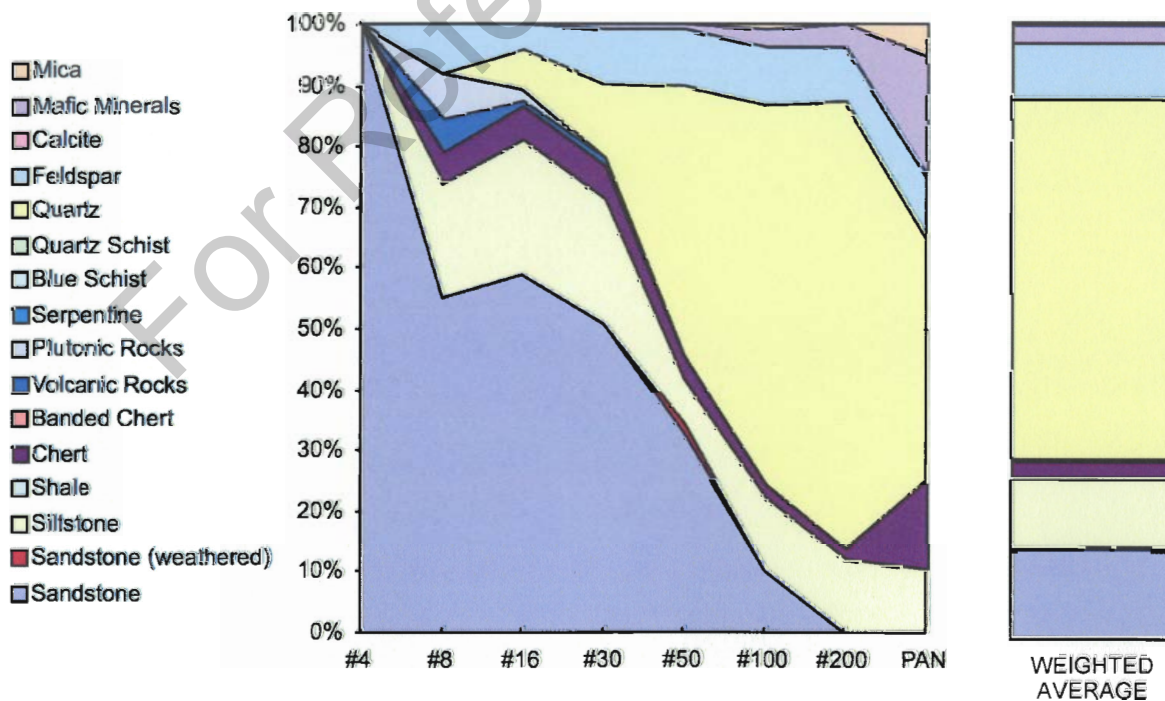

Sample 11: MW-8B @ 39'



#4



#8



#16



#30

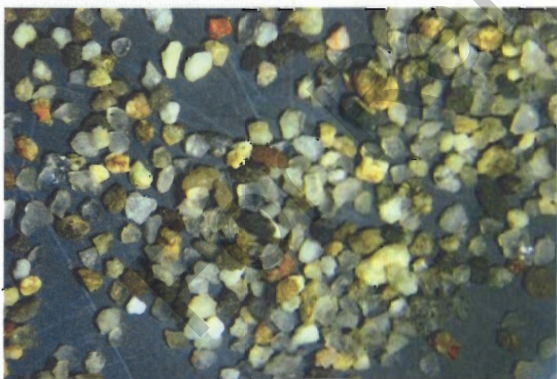

#50

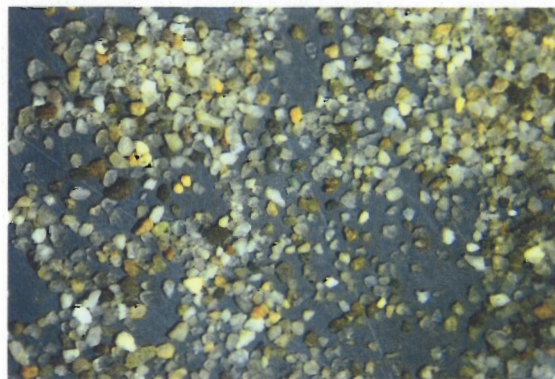

#100



Durability Index (Fine)
ASTM D3744/ CAL T229

Project Name: Hatch-Mott-McDonald 8 Tested By: JN
 Project No.: 080333.3 Input By: 5-1-08
 Client: Chemistry of Concrete Date Tested: _____
 Sampled By: Client Checked By: _____
 Date Sampled: 4/18/08 Sample No.: 1
 Sample Location: N/A Lab No.: 97916
 USCS Description: SP
 Material Description: poorly graded sand w/ gravel

Trial No.	Soak Time	End Soak Time	Start Sedimentation Time	Sedimentation Time	Clay Reading	Sand Reading	D.I. (%)
1	60	60	38:45	13:45	83	43	52
2							
REMARKS:						TOTAL =	52
						AVG. =	52
						DI =	52

DI = Sand Reading / Clay Reading * 100

For Reference ONLY

Durability Index (Fine)
 ASTM D3744/ CAL T229

Project Name: Hatch-Mott-Medonald a Tested By: JN
 Project No.: 0803333 Input By: 5-2-08
 Client: Chemistry of concrete Date Tested: _____
 Sampled By: Client Checked By: _____
 Date Sampled: 4/18/08 Sample No.: 2
 Sample Location: N/A Lab No.: 97917
 USCS Description: SW-SM
 Material Description: _____

Trial No.	Soak Time	End Soak Time	Start Sedimentation Time	Sedimentation Time	Clay Reading	Sand Reading	D.I. (%)
1	60	50	38:45	18:45	90	38	43
2							
REMARKS:						TOTAL =	43
						AVG. =	43
						DI =	43

DI = Sand Reading / Clay Reading * 100

For Reference Only

Durability Index (Fine)
ASTM D3744/ CAL T229

Project Name: Hatch-Mott-Wedensald 10 Tested By: JR
 Project No.: 080333.3 Input By: 5-2-08
 Client: Chemistry of concrete Date Tested: _____
 Sampled By: Client Checked By: _____
 Date Sampled: 4/10/08 Sample No.: 3
 Sample Location: N/A Lab No.: 97918
 USCS Description: GW-GM
 Material Description: _____

Trial No.	Soak Time	End Soak Time	Start Sedimentation Time	Sedimentation Time	Clay Reading	Sand Reading	D.I. (%)
1	60	50	3:24.5	18:00	72	41	57
2							57
REMARKS:						TOTAL =	
						AVG. =	57
						DI =	57

DI = Sand Reading / Clay Reading * 100

For Reference Only

Durability Index (Fine)
ASTM D3744/ CAL T229

Project Name: Hatch-Mott-McDonald 11
 Project No.: 080833.3
 Client: Chemistry of Concrete
 Sampled By: client
 Date Sampled: 4/18/08
 Sample Location: N/A
 USCS Description: SP-SM
 Material Description: _____

Tested By: JR
 Input By: 5-2-08
 Date Tested: _____
 Checked By: _____
 Sample No.: 4
 Lab No.: 97919

Trial No.	Soak Time	End Soak Time	Start Sedimentation Time	Sedimentation Time	Clay Reading	Sand Reading	D.I. (%)	
1	60	SD	38:45	18:45	105	42	40	
2								
REMARKS:							TOTAL =	40
							AVG. =	40
							DI =	40

DI = Sand Reading / Clay Reading * 100