

VTA's BART SILICON VALLEY— PHASE II EXTENSION PROJECT TRANSPORTATION IMPACT ANALYSIS OF THE BART EXTENSION ONLY

PREPARED FOR:

Santa Clara Valley Transportation Authority
U.S. Department of Transportation
Federal Transit Administration



PREPARED BY:

Hexagon Transportation Consultants, Inc.
4 North Second Street, Suite 400
San Jose, CA 95113

November 2016

Hexagon Transportation Consultants, Inc. 2016. VTA's BART Silicon Valley—
Phase II Extension Project Transportation Impact Analysis of the BART
Extension Only. November. San Jose, CA. Prepared for the Santa Clara Valley
Transportation Authority, San Jose, CA, and the Federal Transit Administration,
Washington, D.C.

Table of Contents

1.	Introduction.....	1
2.	Existing Transportation System	26
3.	Year 2025 No Project/Phase I Conditions.....	58
4.	Year 2025 Phase II Project Conditions – Alum Rock/28 th Street Station.....	84
5.	Year 2025 Phase II Project Conditions – Diridon Station	98
6.	Year 2025 Phase II Project Conditions – Santa Clara Station.....	112
7.	Year 2035 No Project/Phase I Conditions.....	124
8.	Year 2035 Phase II Project Conditions – Alum Rock/28 th Street Station.....	146
9.	Year 2035 Phase II Project Conditions – Diridon Station	159
10.	Year 2035 Phase II Project Conditions – Santa Clara Station.....	174
11.	Conclusions.....	187

Appendices

Appendix A: Study Intersections for the “BART Extension TIA” and the “BART Extension with TOJD TIA”

Appendix B: Existing Plus Project Traffic Analysis

Appendix C: Traffic Count Data

Appendix D: Volume Summary Tables

Appendix E: Level of Service Calculations – Alum Rock/28th Street Station

Appendix F: Level of Service Calculations – Diridon Station

Appendix G: Level of Service Calculations – Santa Clara Station

List of Tables

Table 1	ABAG Projections for Santa Clara County.....	15
Table 2	Signalized Intersection Level of Service Definitions Based on Control Delay	18
Table 3	Unsignalized Intersection Level of Service Definitions Based on Control Delay	18
Table 4	Freeway Segment Level of Service Definitions Based on Density	21
Table 5	Existing Bus Services by BART Station.....	39
Table 6	Existing Intersection Levels of Service – Alum Rock/28 th Street Station.....	50
Table 7	Existing Intersection Levels of Service – Diridon Station.....	51
Table 8	Existing Intersection Levels of Service – Santa Clara Station.....	52
Table 9	Existing Freeway Levels of Service – Alum Rock/28 th Street Station.....	54
Table 10	Existing Freeway Levels of Service – Diridon Station.....	55

Table 11 Existing Freeway Levels of Service – Santa Clara Station..... 56

Table 12 Existing Freeway Ramp Queuing Analysis 57

Table 13 2025 Projected Number of Households and Employment by County..... 59

Table 14 2025 Transportation Network Improvements..... 60

Table 15 2025 Bicycle/Pedestrian Facility Improvements 61

Table 16 2025 Transit Improvements (Santa Clara County) 62

Table 17 2025 No Project/Phase I Conditions Intersection Levels of Service – Alum Rock Station.... 72

Table 18 2025 No Project/Phase I Conditions Intersection Levels of Service – Diridon Station 74

Table 19 2025 No Project/Phase I Conditions Intersection Levels of Service – Santa Clara Station .. 77

Table 20 2025 No Project/Phase I Conditions Freeway Levels of Service – Alum Rock Station..... 79

Table 21 2025 No Project/Phase I Conditions Freeway Levels of Service – Diridon Station..... 80

Table 22 2025 No Project/Phase I Conditions Freeway Levels of Service – Santa Clara Station 81

Table 23 2025 No Project/Phase I Conditions Freeway Ramp Queuing Analysis 83

Table 24 PNR and KNR Peak-Hour Factors by Mode..... 85

Table 25 Alum Rock/28th Station Trip Generation Estimates – 2025 Phase II Project Conditions..... 87

Table 26 2025 Phase II Project Conditions Intersection Levels of Service - Alum Rock Station 92

Table 27 2025 Phase II Project Conditions Freeway Levels of Service - Alum Rock Station 95

Table 28 2025 Phase II Project Conditions Freeway Ramp Queuing Analysis 96

Table 29 Diridon Station Trip Generation Estimates – 2025 Phase II Project Conditions..... 100

Table 30 2025 Phase II Project Conditions Intersection Levels of Service - Diridon Station 109

Table 31 2025 Phase II Project Conditions Freeway Levels of Service - Diridon Station 111

Table 32 Santa Clara Station Trip Generation Estimates – 2025 Phase II Project Conditions 114

Table 33 2025 Phase II Project Conditions Intersection Levels of Service – Santa Clara Station..... 119

Table 34 2025 Phase II Project Conditions Freeway Levels of Service – Santa Clara Station..... 122

Table 35 2035 Projected Number of Households and Employment by County..... 125

Table 36 2035 Transportation Network Improvements..... 126

Table 37 2035 Transit Improvements (Santa Clara County) 128

Table 38 2035 No Project/Phase I Conditions Intersection Levels of Service – Alum Rock Station.. 135

Table 39 2035 No Project/Phase I Conditions Intersection Levels of Service – Diridon Station..... 137

Table 40 2035 No Project/Phase I Conditions Intersection Levels of Service – Santa Clara Station 139

Table 41 2035 No Project/Phase I Conditions Freeway Levels of Service – Alum Rock Station..... 142

Table 42 2035 No Project/Phase I Conditions Freeway Levels of Service – Diridon Station..... 143

Table 43 2035 No Project/Phase I Conditions Freeway Levels of Service – Santa Clara Station 144

Table 44 2035 No Project/Phase I Conditions Freeway Ramp Queuing Analysis 145

Table 45 Alum Rock Station Trip Generation Estimates – 2035 Phase II Project Conditions 148

Table 46 2035 Phase II Project Conditions Intersection Levels of Service – Alum Rock Station 153

Table 47 2035 Phase II Project Conditions Freeway Levels of Service - Alum Rock Station 155

Table 48 2035 Phase II Project Conditions Freeway Ramp Queuing Analysis 156

Table 49 Diridon Station Trip Generation Estimates – 2035 Phase II Project Conditions 160

Table 50 2035 Phase II Project Conditions Intersection Levels of Service - Diridon Station 169

Table 51 2035 Phase II Project Conditions Freeway Levels of Service - Diridon Station 171

Table 52 Santa Clara Station Trip Generation Estimates – 2035 Phase II Project Conditions 175

Table 53 2035 Phase II Project Conditions Intersection Levels of Service – Santa Clara Station 181

Table 54 2035 Phase II Project Conditions Freeway Levels of Service – Santa Clara Station 184

List of Figures

Figure 1 VTA’s BART Silicon Valley - Phase II Extension Project Alignment and Stations 3

Figure 2 Alum Rock/28th Street Station 5

Figure 3 Diridon Station 6

Figure 4 Santa Clara Station and Alignment 7

Figure 5 Alum Rock/28th Street BART Station Location and Study Intersections 8

Figure 6 Diridon BART Station Location and Study Intersections 9

Figure 7 Santa Clara BART Station Location and Study Intersections 10

Figure 8 Existing Bicycle Facilities – Alum Rock/28th Street Station Area 30

Figure 9 Existing Bicycle Facilities – Diridon Station Area 31

Figure 10 Existing Bicycle Facilities – Santa Clara Station Area 32

Figure 11 Existing Transit Services – Alum Rock/28th Street Station Area 36

Figure 12 Existing Transit Services – Diridon Station Area 37

Figure 13 Existing Transit Services – Santa Clara Station Area 38

Figure 14 Existing Intersection Lane Configurations – Alum Rock/28th Street Station 42

Figure 15 Existing Intersection Lane Configurations – Diridon Station 43

Figure 16 Existing Intersection Lane Configurations – Santa Clara Station 45

Figure 17 Existing Traffic Volumes – Alum Rock/28th Street Station 46

Figure 18 Existing Traffic Volumes – Diridon Station 47

Figure 19 Existing Traffic Volumes – Santa Clara Station 49

Figure 20 2025 No Project/Phase I Conditions Intersection Lane Configurations – Alum Rock Station 64

Figure 21 2025 No Project/Phase I Conditions Intersection Lane Configurations – Diridon Station..... 65

Figure 22 2025 No Project/Phase I Conditions Intersection Lane Configurations – Santa Clara Station67

Figure 23 2025 No Project/Phase I Conditions Traffic Volumes – Alum Rock Station..... 68

Figure 24 2025 No Project/Phase I Conditions Traffic Volumes – Diridon Station..... 69

Figure 25 2025 No Project/Phase I Conditions Traffic Volumes – Santa Clara Station 71

Figure 26 2025 No Project/Phase I Conditions Deficient LOS Intersections – Alum Rock Station 73

Figure 27 2025 No Project/Phase I Conditions Deficient LOS Intersections – Diridon Station 75

Figure 28 2025 No Project/Phase I Conditions Deficient LOS Intersections – Santa Clara Station 78

Figure 29 2025 Phase II Project Conditions Station (Drive Access) Trips – Alum Rock Station..... 88

Figure 30 2025 Phase II Project Conditions Net Project Trips – Alum Rock Station..... 89

Figure 31 2025 Phase II Project Conditions Traffic Volumes – Alum Rock Station 91

Figure 32 2025 Phase II Project Conditions Deficient LOS Intersections – Alum Rock Station..... 93

Figure 33 2025 Phase II Project Conditions Station (Drive Access) Trips – Diridon Station..... 101

Figure 34 2025 Phase II Project Conditions Net Project Trips – Diridon Station..... 103

Figure 35 2025 Phase II Project Conditions Traffic Volumes – Diridon Station 105

Figure 36 2025 Phase II Project Conditions Deficient LOS Intersections – Diridon Station..... 110

Figure 37 2025 Phase II Project Conditions Station (Drive Access) Trips – Santa Clara Station 115

Figure 38 2025 Phase II Project Conditions Net Project Trips – Santa Clara Station 116

Figure 39 2025 Phase II Project Conditions Traffic Volumes – Santa Clara Station..... 118

Figure 40 2025 Phase II Project Conditions Deficient LOS Intersections – Santa Clara Station 120

Figure 41 2035 No Project/Phase I Conditions Traffic Volumes – Alum Rock Station..... 130

Figure 42 2035 No Project/Phase I Conditions Traffic Volumes – Diridon Station..... 131

Figure 43 2035 No Project/Phase I Conditions Traffic Volumes – Santa Clara Station 133

Figure 44 2035 No Project/Phase I Conditions Deficient LOS Intersections – Alum Rock Station 136

Figure 45 2035 No Project/Phase I Conditions Deficient LOS Intersections – Diridon Station 138

Figure 46 2035 No Project/Phase I Conditions Deficient LOS Intersections – Santa Clara Station 140

Figure 47 2035 Phase II Project Conditions Station (Drive Access) Trips – Alum Rock Station..... 149

Figure 48 2035 Phase II Project Conditions Net Project Trips – Alum Rock Station..... 150

Figure 49 2035 Phase II Project Conditions Traffic Volumes – Alum Rock Station 151

Figure 50 2035 Phase II Project Conditions Deficient LOS Intersections – Alum Rock Station..... 154

Figure 51 2035 Phase II Project Conditions Station (Drive Access) Trips – Diridon Station..... 162

Figure 52 2035 Phase II Project Conditions Net Project Trips – Diridon Station..... 164

Figure 53 2035 Phase II Project Conditions Traffic Volumes – Diridon Station 166

Figure 54 2035 Phase II Project Conditions Deficient LOS Intersections – Diridon Station..... 170

Figure 55 2035 Phase II Project Conditions Station (Drive Access) Trips – Santa Clara Station 177

Figure 56 2035 Phase II Project Conditions Net Project Trips – Santa Clara Station..... 178

Figure 57 2035 Phase II Project Conditions Traffic Volumes – Santa Clara Station..... 180

Figure 58 2035 Phase II Project Conditions Deficient LOS Intersections – Santa Clara Station 182

1. Introduction

“This Transportation Impact Analysis (TIA) includes an analysis of only the 6-mile extension of BART from Berryessa Station to Santa Clara, which is also called the NEPA/BART Extension Alternative in the Supplemental Environmental Impact Statement/Subsequent Environmental Impact Report (SEIS/SEIR) prepared for VTA’s BART Silicon Valley – Phase II Extension Project. VTA’s transit-oriented joint development (TOJD) is not included in this TIA. A separate TIA which includes both the BART extension and TOJD was finalized in November 2016, called the *Transportation Impact Analysis of the BART Extension and VTA’s Transit-Oriented Joint Development* (“BART Extension with TOJD TIA”). Therefore, for purposes of this “TIA of the BART Extension Only”, the word “Project” refers to the NEPA BART Extension Alternative.”

The purpose of this traffic study is to evaluate traffic impacts associated with the proposed Valley Transportation Authority’s (VTA) Bay Area Rapid Transit (BART) Silicon Valley – Phase II Extension Project and the proposed BART Stations associated with this project. The proposed VTA’s BART Silicon Valley – Phase II Extension Project¹ (hereafter referred to as the *Phase II Project*) is the second phase of the BART Silicon Valley Program which would provide for the extension of the BART service to the Cities of San Jose and Santa Clara. The Phase II Project includes four of the six BART Stations proposed along the Silicon Valley Rapid Transit Corridor (SVRTC). The new stations under the Phase II Project are located in the Cities of San Jose and Santa Clara and include:

- Alum Rock/28th Street Station
- Downtown San Jose Station
- Diridon Station
- Santa Clara Station

Figure 1 presents the proposed Phase II Project corridor alignment and stations. Phase I (also known as VTA’s BART Silicon Valley – Phase I Extension Project, or Phase I Project) of the BART Silicon Valley Program includes the first two of the six stations located in the Cities of Milpitas (Milpitas Station) and San Jose (Berryessa Station). A traffic analysis of the Phase I Project was completed in March 2013. The Phase I Project will be completed in late 2017. Passenger service for the Phase II Project is planned to begin in 2025.

¹ This TIA uses the terminology “No Project/Phase I Conditions” to refer to conditions without the Phase II BART extension and its proposed stations. It is the equivalent of the “No Build Alternative” in the Supplemental Environmental Impact Statement and Subsequent Environmental Impact Report (SEIS/SEIR) which includes the results of this analysis. The terms “Project” and “Phase II Project” in this TIA are the equivalent of the “BART Extension Alternative” in the SEIS/SEIR. The “BART Extension with TOJD Alternative” in the SEIS/SEIR is not included in this TIA.

The Phase II Project consists of an approximately 6-mile extension of the BART system beginning at the terminus of the Phase I Project, east of US 101 and south of Mabury Road in San Jose, descending into an approximately 5-mile-long subway tunnel, and terminating at grade in Santa Clara near the Caltrain Station.

There are two construction methods proposed for the 5-mile-long tunnel portion of the Phase II BART extension: the Twin-Bore and Single-Bore Options. Under the Twin-Bore Option, two tunnels would be excavated with one track in each, and each tunnel bore would have an outer diameter of approximately 20 feet. Under the Single-Bore Option, one tunnel bore with an outer diameter of approximately 45 feet would be excavated and would contain both northbound and southbound tracks. All transportation-related impacts evaluated in this TIA would be the same for both options, so this report does not distinguish between the two tunnel options in its analysis and discussion of transportation impacts.

The stations analyzed in this report are the proposed stations under the Phase II Project that would provide Park-and-Ride (PNR) and/or Kiss-and-Ride (KNR) facilities on site. Two of the proposed stations under the Phase II Project would provide PNR and KNR facilities for BART users: the Alum Rock/28th Street and Santa Clara Stations. KNR facilities would be provided at the Diridon Station, while the Downtown San Jose Station would not provide KNR or PNR facilities and, therefore, would not generate a significant amount of vehicular traffic on the surrounding roadway network. Because patrons would access the Downtown San Jose station by walking, biking, or taking transit, it is deemed unnecessary to evaluate traffic conditions at the Downtown San Jose Station, but instead its effects are reflected at the proposed surrounding stations. Therefore, only three of the proposed stations under the Phase II Project are discussed in this analysis. Each of these station sites has been described as follows:

Alum Rock/28th Street Station

The Alum Rock/28th Street Station would be located in the general area west of US 101 and north of East Santa Clara Street. The proposed Alum Rock/28th Street Station site is located on the east side of North 28th Street, between McKee Road and East Santa Clara Street (see Figure 2). The station campus would include an underground station with street-level entrance portals with elevators, escalators and stairs. The station would include system facilities both above and below ground. A 1,200-space parking structure with up to seven levels for PNR BART commuters would also be constructed. A KNR facility would be provided along North 28th Street and/or on the station campus. Additionally, shuttle/bus drop-off areas would be provided within the station campus or along North 28th Street.

Access to the station area would be from North 28th Street, via McKee Road from the north and East Santa Clara Street from the south. A pedestrian connection along the south side of the station area at North 28th Street from East Santa Clara Street would link the station entrances with buses and Bus Rapid Transit (BRT) operating on East Santa Clara Street/Alum Rock Avenue.

Diridon Station

There are two station location options for the Diridon Station: the South Option and the North Option, both of which would be located in the general area of the Diridon Caltrain Station and both of which would consist of an underground boarding platform level, a mezzanine level, and entrances at street-level portals. Under either the North or South option, Diridon Station would be generally located between Los Gatos Creek (to the east) and the Diridon Caltrain Station (to the west) and south of/parallel to West Santa Clara Street (see Figure 3). The South Option would be located midway between Santa Clara Street and Stover Street. The North Option would be located adjacent to, and just south of, Santa Clara Street. For purposes of analyzing traffic impacts, however, there would be no difference between the North and South options, so this TIA does not analyze the options separately. Figure 3 shows the South Option location, but the North Option would be the same for all purposes of evaluating transportation-related impacts.

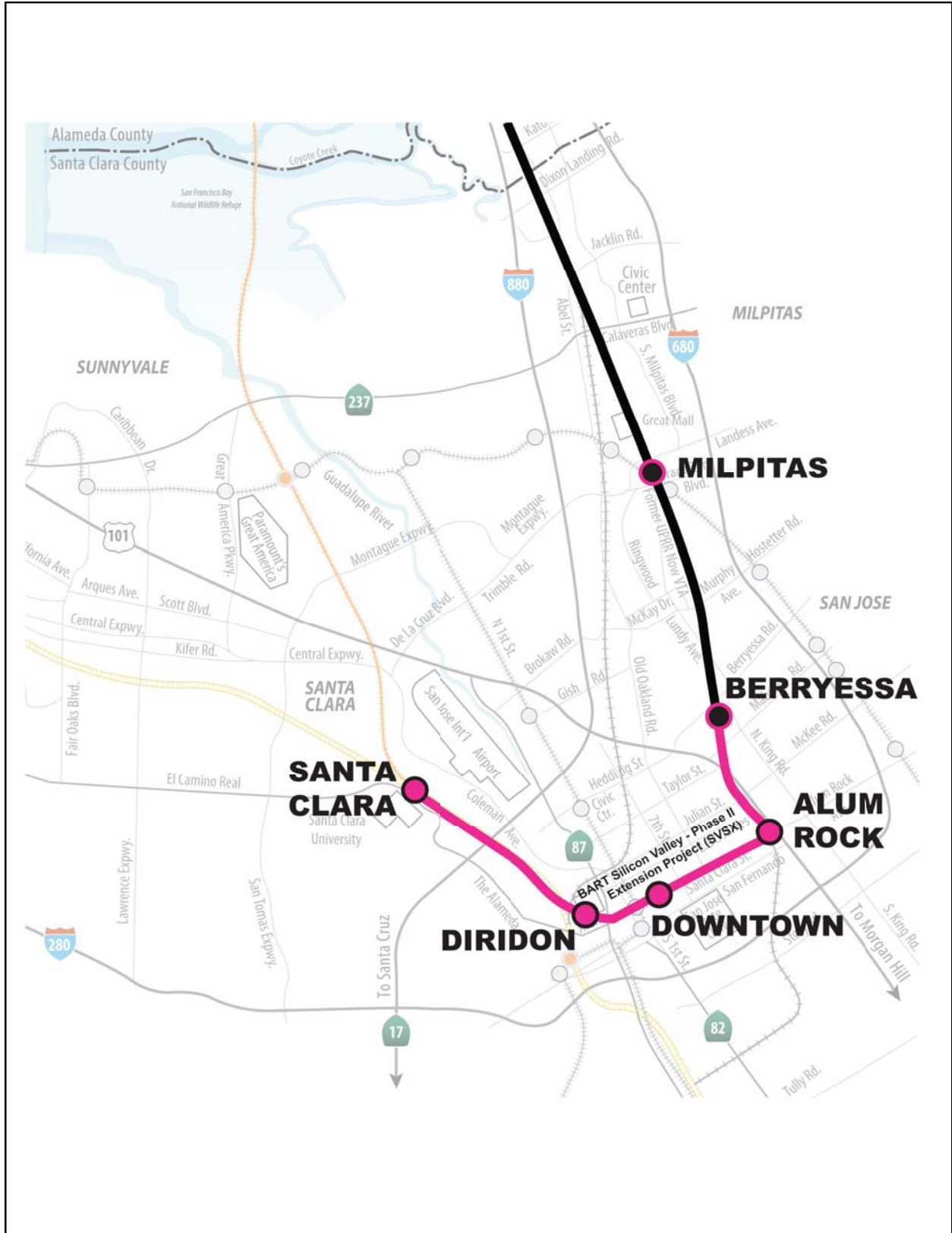

Figure 1
VTA's BART Silicon Valley - Phase II Extension Project Alignment and Stations

The existing VTA bus transit center would be expanded to accommodate projected bus/shuttle transfers to and from the BART station. A KNR facility would be located along Cahill Street. No park-and-ride parking would be provided at this location.

Access to the station area would be provided from Cahill, North Montgomery, and North Autumn Streets via West Santa Clara Street from the north and San Fernando Street from the south. Street-level station entrance portals would provide pedestrian linkages to the Diridon Caltrain Station and SAP Center.

Santa Clara Station

The Santa Clara Station would be located in the general area of the Santa Clara Caltrain Station. The proposed Santa Clara Station would be located at grade just northeast of the Caltrain tracks and the Santa Clara Caltrain Station (between Coleman Avenue and El Camino Real), at the western end of Brokaw Road (see Figure 4). A KNR facility and bus/shuttle loading areas would be provided along Brokaw Road. In addition, Brokaw Road would be widened between the Santa Clara Station and Coleman Avenue, resulting in a newly reconfigured intersection at Coleman Avenue. An approximately 240-foot-long pedestrian tunnel would connect from the Santa Clara BART Station to the Santa Clara Caltrain Station plaza, and an approximately 175-foot-long pedestrian tunnel would connect from the BART station to a new BART plaza on Brokaw Road.

The PNR demand would be accommodated in a 500-space parking structure located north of Brokaw Road and east of the Caltrain tracks. Vehicular access to the parking structure would be provided from Brokaw Road and Coleman Avenue. Pedestrian access from the parking structure to the Santa Clara BART Station would be provided through a pedestrian tunnel from Brokaw Road to the station.

Scope of Study

This study was conducted for the purpose of identifying the potential transportation impacts related to the proposed Phase II Project and associated BART Stations. The impacts of the stations were evaluated following the standards and methodologies set forth by the Cities of San Jose and Santa Clara, the Congestion Management Program (CMP) of Santa Clara County, the National Environmental Protection Act (NEPA), and California Environmental Quality Act (CEQA). The results of this study have been incorporated into a Supplemental Environmental Impact Statement and Subsequent Environmental Impact Report (SEIS/SEIR). The traffic analysis is based on peak-hour levels of service for signalized intersections and freeway segments. The study also includes an evaluation of project impacts on pedestrian and bicycle facilities as well as transit service in the study areas. Evaluations of parking and of nearby event centers are also included. The study area and study intersections for each of the proposed stations analyzed are shown on Figures 5, 6, and 7.

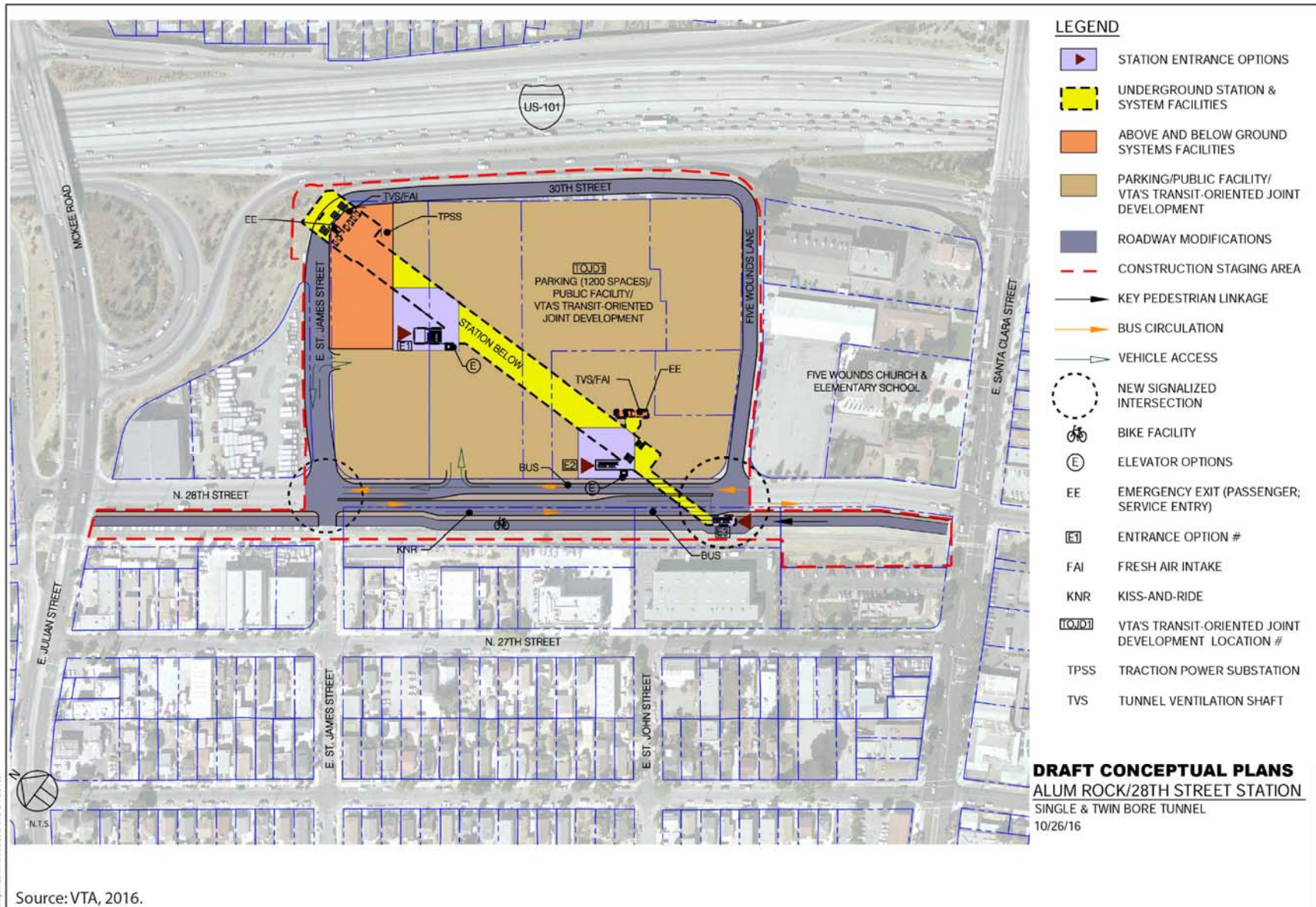

Figure 2
 Alum Rock Station

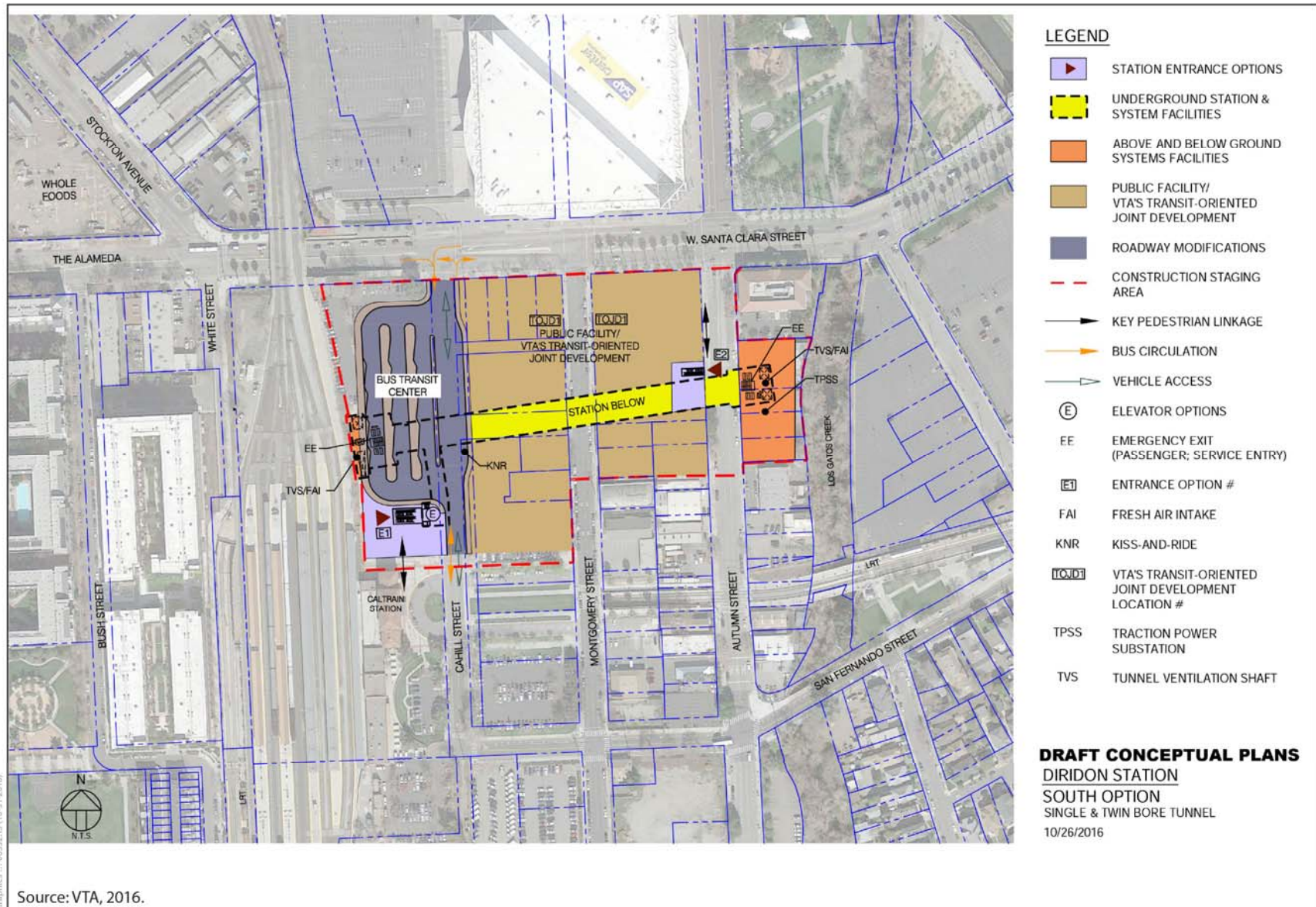

Figure 3
Diridon Station (South Option)

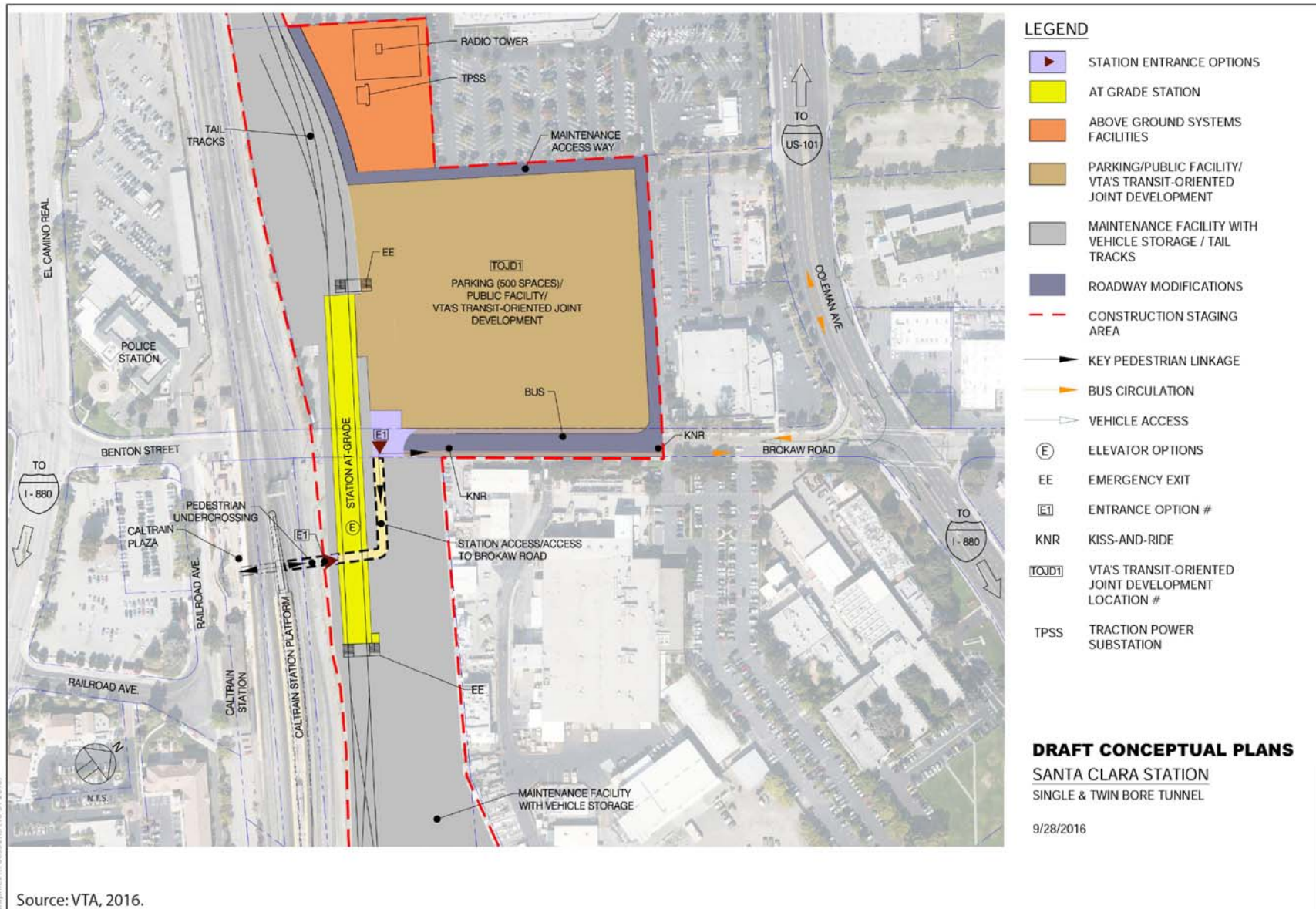

Figure 4
Santa Clara Station



Figure 5
Alum Rock/28th Street BART Station Location and Study Intersections



Figure 6
Diridon BART Station Location and Study Intersections



Figure 7
Santa Clara BART Station Location and Study Intersections

This analysis consists of the evaluation of the effects of the proposed Phase II Project and associated traffic on the immediate and surrounding transportation system under opening day of the project (Year 2025) and long-term (Year 2035) traffic conditions. In addition, Year 2025 and Year 2035 traffic conditions without the Phase II Project or its associated BART Stations (assuming only the Phase I Project in place) were analyzed. The proposed Project and No Project condition scenarios are described in more detail in the following sections.

The study intersections and freeway segments for each of the stations in this TIA are listed below. Additional intersections are included in the "BART Extension with TOJD TIA," because the trips generated by the TOJD would result in more intersections where there may be more than 10 additional vehicles per lane per hour. Tables presenting the intersections that are discussed in this TIA, in the "BART Extension with TOJD TIA," and in the SEIS/SEIR are included in Appendix A.

Alum Rock/28th Street Station

Intersections

- (1) 21st Street and East Julian Street
- (2) 24th Street and East Julian Street
- (3) North 28th Street and East Julian Street
- (4) US 101 and East Julian Street
- (5) US 101 and McKee Road
- (6) King Road and McKee Road
- (7) 17th Street and East Santa Clara Street
- (8) 24th Street and East Santa Clara Street
- (9) North 28th Street and East Santa Clara Street
- (10) US 101 and East Santa Clara Street *
- (11) US 101 and Alum Rock Avenue*
- (12) 24th Street and San Antonio Street
- (13) 24th Street and East William Street
- (14) McLaughlin Avenue and I-280 SB Ramp *
- (15) McLaughlin Avenue and Story Road
- (16) 21st Street and East Santa Clara Street
- (17) 26th Street and East Santa Clara Street

CMP intersections are denoted with an asterisk (*)

Freeway Segments

US 101, Tully Road to Story Road
US 101, Story Road to I-280
US 101, I-280 to East Santa Clara Street
US 101, East Santa Clara Street to McKee Road
I-280, South 10th Street to McLaughlin Avenue
I-280, McLaughlin Avenue to US 101
I-680, US 101 to King Road
I-680, King Road to Capitol Avenue
I-680, Capitol Avenue to Alum Rock Avenue
I-680, Alum Rock Avenue to McKee Road

Diridon Station

Intersections

- (1) The Alameda and Taylor Street/Naglee Avenue*
- (2) Stockton Avenue and West Julian Street
- (3) North Montgomery Street and West Julian Street
- (4) North Autumn Street and West Julian Street
- (5) SR 87 (W) and West Julian Street*

- (6) SR 87 (E) and West Julian Street*
- (7) The Alameda and West Julian Street
- (8) Race Street and The Alameda*
- (9) Stockton Avenue and The Alameda
- (10) Cahill Street and West Santa Clara Street
- (11) South Montgomery Street and West Santa Clara Street*
- (12) South Autumn Street and West Santa Clara Street*
- (13) SR 87 and West Santa Clara Street*
- (14) South Montgomery Street and San Fernando Street
- (15) South Autumn Street and San Fernando Street
- (16) Delmas Avenue and San Fernando Street
- (17) South Montgomery/Autumn Street and Park Avenue
- (18) Delmas Avenue and Park Avenue
- (19) Meridian Avenue and San Carlos Street
- (20) Race Street and San Carlos Street
- (21) Lincoln Avenue and San Carlos Street
- (22) Bird Avenue and San Carlos Street*
- (23) Bird Avenue and Auzerais Avenue
- (24) Meridian Avenue and Parkmoor Avenue
- (25) Lincoln Avenue and Parkmoor Avenue
- (26) Bird Avenue and I-280 (N)*
- (27) Bird Avenue and I-280 (S)*
- (28) Southwest Expressway and Fruitdale Avenue
- (29) Meridian Avenue and Fruitdale Avenue

CMP intersections are denoted with an asterisk (*)

Freeway Segments

- SR 87, Curtner Avenue to Almaden Expressway
- SR 87, Almaden Expressway to Alma Street
- SR 87, Alma Street to I-280
- SR 87, I-280 to Julian Street
- SR 87, Julian Street to Coleman Avenue
- I-280, I-880 to Meridian Avenue
- I-280, Meridian Avenue to Bird Avenue
- I-280, Bird Avenue to SR 87
- I-280, SR 87 to South 10th Street

Santa Clara Station

Intersections

- (1) Lafayette Street and Reed Street
- (2) De La Cruz Boulevard and Reed Street
- (3) San Tomas Expressway and El Camino Real*
- (4) Scott Boulevard and El Camino Real*
- (5) Monroe Street and El Camino Real*
- (6) Lafayette Street and El Camino Real*
- (7) El Camino Real and Benton Street
- (8) El Camino Real and Railroad Avenue
- (9) El Camino Real and The Alameda*
- (10) Lafayette Street and Benton Street
- (11) Coleman Avenue and Brokaw Road
- (12) Coleman Avenue and Aviation Avenue
- (13) Coleman Avenue and Newhall Drive
- (14) Lafayette Street and Lewis Street
- (15) Lafayette Street and Harrison Street (unsignalized)

- (16) De La Cruz Boulevard and Central Expressway*
- (17) De La Cruz Boulevard and Martin Avenue

CMP intersections are denoted with an asterisk (*)

Freeway Segments

US 101, I-880 to Old Bayshore Road
US 101, Old Bayshore Road to First Street
US 101, First Street to Guadalupe
US 101, Guadalupe to De La Cruz Boulevard
US 101, De La Cruz Boulevard to Montague Expressway
US 101, Montague Expressway to Great America Parkway
I-880, I-280 to Stevens Creek Boulevard
I-880, Stevens Creek Boulevard to Bascom Avenue
I-880, Bascom Avenue to The Alameda
I-880, The Alameda to Coleman Avenue
I-880, Coleman Avenue to SR 87
I-880, SR 87 to First Street
I-880, First Street to US 101

In summary, this traffic study includes an analysis of the proposed Phase II Project and the three BART Stations that would provide PNR and/or KNR facilities to serve BART riders. The study includes the analysis of a total of seventeen signalized intersections and 10 freeway segments (20 directional segments) in the vicinity of the Alum Rock/28th Street Station, a total of twenty-nine signalized intersections and 9 freeway segments (18 directional segments) in the vicinity of the Diridon Station, and a total of sixteen signalized intersections, one unsignalized intersection, and 13 freeway segments (26 directional segments) in the vicinity of the Santa Clara Station. All study intersections are located within the Cities of San Jose and Santa Clara.

Study Time Periods

Traffic conditions at the study intersections and freeway segments were analyzed for the weekday AM and PM peak hours of traffic. The AM peak hour of traffic is generally an hour between 7:00 and 9:00 AM, and the PM peak hour is typically between 4:00 and 6:00 PM. It is during these periods that the most congested traffic conditions occur on an average day.

Study Scenarios

Traffic conditions were evaluated for the scenarios described below.

Existing Conditions

Traffic conditions were evaluated for existing conditions. Existing conditions were represented by existing peak-hour traffic volumes on the existing roadway network. Existing traffic volumes were obtained from manual turning movement traffic counts (see Appendix C). Traffic conditions on the existing roadway network with the existing traffic counts were evaluated. It should be noted that the existing traffic information is presented merely to identify possible constraints to development near the proposed stations' sites.

Additionally, for informational purposes, existing conditions with the proposed project also were evaluated. Existing Plus Phase II Project conditions are presented merely to disclose the traffic conditions that can be expected to occur if the project were completed and operating today. The results of the level of service analysis under Existing Plus Phase II Project conditions are summarized in Appendix B.

Year 2025 Conditions

Two scenarios were analyzed for the “opening day” of the project (Year 2025): Year 2025 Phase I (No Project) conditions and Year 2025 Phase II Project conditions. Year 2025 traffic conditions represent traffic conditions that would occur in the year 2025 without and with the proposed Phase II Project and Stations. Traffic projections for these scenarios were developed using VTA’s county-wide Travel Forecasting Model (2012 PD Phase II, December 2014) which estimates traffic volumes and transit ridership levels associated with near-term (Year 2025) conditions. The scenarios are described below:

Year 2025 No Project/Phase I Conditions. Year 2025 traffic conditions without the proposed Phase II Project or its stations were analyzed. This scenario evaluates traffic conditions in the year 2025 with the Phase I Project (Milpitas and Berryessa BART Stations only), the addition of planned improvements expected to be completed by the year 2025 identified in the Metropolitan Transportation Commission (MTC) Bay Area’s Regional Transportation Plan (RTP), *Transportation 2035 Plan for the San Francisco Bay Area* (Transportation 2035 Plan), and the *Valley Transportation Plan 2040* (VTP 2040). Traffic projections for this scenario include traffic associated with near-term future development in and outside of the Cities of San Jose and Santa Clara, excluding the Phase II Project.

Year 2025 Phase II Project Conditions. This scenario evaluates traffic conditions in the year 2025 with the Phase I Project, the addition of planned improvements identified in the Bay Area’s RTP, Transportation 2035 Plan, and VTP 2040 (expected to be completed by the year 2025), and the proposed Phase II Project. Traffic projections for this scenario include traffic associated with near-term future development in and outside of the Cities of San Jose and Santa Clara, including the Phase II Project. Year 2025 Phase II Project conditions were analyzed and compared to the Year 2025 Phase I (No Project) conditions in order to identify potential transportation network impacts associated with the proposed Phase II BART Stations.

Year 2035 Conditions

As with the Year 2025, two scenarios were analyzed for the long-term (Year 2035) analysis²: Year 2035 Phase I (No Project) conditions and Year 2035 Phase II Project conditions. Year 2035 traffic conditions represent traffic conditions that would occur in the year 2035 without and with the proposed Phase II Project and Stations. Traffic projections for these scenarios were developed using VTA’s county-wide Travel Forecasting Model (2012 PD Phase II, December 2014) which estimates traffic volumes and transit ridership levels associated with long-term (Year 2035) conditions. The scenarios are described below:

Year 2035 No Project/Phase I Conditions. Year 2035 traffic conditions without the proposed Phase II Project or its stations were analyzed. This scenario evaluates traffic conditions in the year 2035 with the Phase I Project, the addition of planned improvements identified in the Bay Area’s RTP, Transportation 2035 Plan, and the VTP 2040. Traffic projections for this scenario include traffic associated with long-term future development in and outside of the Cities of San Jose and Santa Clara, excluding the Phase II Project.

Year 2035 Phase II Project Conditions. This scenario evaluates traffic conditions in the year 2035 with the Phase I Project, the addition of planned improvements identified in the Bay Area’s RTP, Transportation 2035 Plan, and VTP 2040, and the proposed Phase II Project. Traffic projections for this scenario include traffic associated with long-term future development in and outside of the Cities of San Jose and Santa Clara, including the Phase II Project. Year 2035 Phase II Project conditions were analyzed and compared to the Year 2035 Phase I (No Project) conditions in order to identify potential transportation network impacts associated with the proposed Phase II BART Stations.

² In the SEIS/SEIR that has been prepared for the Phase II Extension Project, the traffic scenarios for the year 2035 are called “2035 Forecast Year.” In accordance with the City of San Jose’s TIA Handbook and VTA’s TIA Guidelines, however, the term “Cumulative” is used throughout this TIA and the “BART Extension with TOJD TIA” when referring to 2035 conditions

Methodology

This section presents the methods used to determine the traffic conditions for each scenario described above. It includes descriptions of the data requirements, the analysis methodologies, and the applicable level of service standards.

Data Requirements

The data required for the analysis were obtained from new traffic count data, previous traffic studies, the Cities of San Jose and Santa Clara, the CMP Annual Monitoring Report, and field observations. The following data were collected from these sources:

- existing traffic volumes
- existing and planned lane configurations
- signal timing and phasing (for signalized intersections only)
- average speed (for freeway segments only)

VTA Travel Demand Forecasting Model

This section describes the travel demand modeling methodology used for the analysis. The model chosen for use in the analysis is the VTA's 2012 PD Phase II, December 2014 Travel Forecasting Model, hereafter referred to as the VTA Model. The VTA Model was developed as an extension and refinement of the Metropolitan Transportation Commission's Regional Model (MTC Model). The VTA Model relies extensively upon MTC Model structure, coding conventions and calculation procedures. This was done to ensure consistency between the two modeling systems. The VTA Model expands on the MTC Model structure in order to provide significantly more detail and forecasting precision within and surrounding Santa Clara County.

The VTA Model also uses demographic projections that are consistent with those prepared by the Association of Bay Area Governments (ABAG). The travel forecasts developed for this project were based on ABAG *Projections 2013*. The ABAG land use and demographic projections include, among other variables, number of households, total population, employed residents and number of jobs. Table 1 shows these land use variables for Santa Clara County for the years 2025 and 2035.

Table 1
ABAG Projections for Santa Clara County

	Year	
	2025	2035
Households	711,200	781,800
Population	2,044,500	2,237,800
Employed Residents	948,000	1,052,600
Jobs	1,096,300	1,190,800

Source: ABAG Projections 2013

The VTA Model uses 2,654 traffic zones to represent 14 counties. These include all nine Bay Area Counties plus Santa Cruz, Monterey, San Benito, San Joaquin and Merced Counties. Santa Clara County has been subdivided into 1,490 traffic zones in order to provide the best possible representation of travel demand for transportation planning purposes. Network features are coded "as they are or will be" based on the best available GIS mapping information.

The VTA Model represents all motorized modes of travel used within the Bay Area, including nearly 100 individual transit operators. The VTA Model also provides estimates of the change in non-motorized travel for user defined analysis scenarios. The VTA Model's projections of roadway traffic demand include several modal stratifications, including: Single occupant autos, 2-person carpools, 3+ person carpools and trucks. Roadway traffic forecasts are available for AM and PM peak one and four-hour periods, midday and night periods.

Traffic Forecast

Turn-Movement Adjustments

Adjustments were made to the forecasted volumes to account for the coarse turn-movements produced by the VTA Model. Although the VTA Model used for this analysis was updated to include all of the study intersections, the general regional roadway network used by the VTA Model does not represent all minor streets. The lack of coding of these minor facilities causes the VTA Model to over-assign traffic volumes to those facilities that are represented in the network. This results in inaccurate forecasted turn-movement volumes that require adjustments to calibrate them with actual travel patterns and use of proper facilities. The adjustment process begins by comparing and adjusting base model forecasts (year 2015 forecasts representing existing conditions) with existing traffic counts. By adjusting the base model forecasts with existing volumes, model projections are calibrated with actual travel patterns and use of proper facilities. Once the base model forecasts are calibrated, future model forecasts are developed for the study scenarios. These are all considered "raw" model volume forecasts which on their own do not represent future volume conditions, but are simply used to forecast growth and travel pattern changes expected in the future.

To obtain the final traffic volume forecasts, raw model volume forecasts in conjunction with existing count data are used. Future traffic volume forecasts are developed by adding to the existing traffic count data the projected growth between the base (year 2015) and the future (year 2025 and 2035) model volume forecasts. The adjustment process is outlined below:

$$\text{Existing Count} + (\text{Future Forecast} - \text{2015 Forecast})$$

It should be noted that as a conservative approach, it was assumed in this analysis that, unless a major change in the roadway network or existing land use is projected for the future conditions scenarios, all future model forecast volumes would be no less than the existing traffic counts.

Traffic Volume Components

Traffic volumes for all the scenarios analyzed were derived based on existing turn-movement volumes and model forecasts obtained from the VTA Model. All traffic volume components utilized in the analysis of the proposed project are summarized below (and described in more detail in the following chapters) and included in Appendix D.

Existing (2015) Conditions. New turning-movement counts were conducted in the fall of 2014 at all of the study intersections. However, due to non-typical conditions at four of the study intersections in the fall of 2014, 2013 and 2015 counts were utilized at these locations.

Year 2025 No Project/Phase I Conditions. Year 2025 No Project traffic volumes were obtained from the VTA Model. These volumes represent traffic conditions in the year 2025 without the proposed project (No Project/Phase I background) and include BART commuter trips to the Berryessa (end of the line) Station.

Year 2025 Phase II Project Conditions. Year 2025 Phase II Project conditions traffic volumes were obtained from the VTA Model. These volumes represent traffic conditions in the year 2025 (Phase I volumes) plus the addition of the proposed Phase II net project trips (including new Phase II station trips and projected change in background traffic as BART users switch from the passenger vehicle to BART).

Year 2035 No Project/Phase I Conditions. Year 2035 No Project traffic volumes were obtained from the VTA Model. These volumes represent traffic conditions in the year 2035 without the proposed project (No Project/Phase I background) and include BART commuter trips to the Berryessa (end of the line) Station.

[Year 2035 Phase II Project Conditions](#). Year 2035 Phase II Project conditions traffic volumes were obtained from the VTA Model. These volumes represent traffic conditions in the year 2035 (Phase I volumes) plus the addition of the proposed Phase II net project trips (including new Phase II station trips and projected change in background traffic as BART users switch from the passenger vehicle to BART).

Intersection Analysis Methodologies and Level of Service Standards

The Valley Transportation Authority (VTA), which is the Congestion Management Agency of Santa Clara County, requires new developments projected to generate 100 or more peak hour trips to complete a Transportation Impact Analysis (TIA). The TIA includes an evaluation of traffic conditions with the proposed project on the surrounding transportation network, and identifies potential impacts on the transportation network directly associated with the proposed project. Traffic conditions are evaluated using level of service (LOS). *Level of Service* is a qualitative description of operating conditions ranging from LOS A, or free-flow conditions with little or no delay, to LOS F, or jammed conditions with excessive delays. The transportation facilities included in this analysis and the analysis methods are described below.

Signalized Intersections

All of the signalized study intersections are located within the Cities of San Jose and Santa Clara and are therefore subject to their corresponding City's Level of Service standards. Both of the Cities' level of service methodology is based on the *Highway Capacity Manual* (HCM) method for signalized intersections. Signalized intersection operations are evaluated using the 2000 HCM Operations Method and TRAFFIX software. The method evaluates intersection level of service (LOS) on the basis of average control delay time for all vehicles at the intersection. Since TRAFFIX is also the CMP-designated intersection level of service software, the City of San Jose and City of Santa Clara methodologies employ the CMP default values for the analysis parameters.

The City of San Jose level of service standard for signalized intersections is LOS D or better. The City of Santa Clara level of service standard is LOS D or better at all city-controlled intersections and LOS E or better at all expressway and CMP intersections. The CMP level of service standard for signalized intersections is LOS E or better. For Year 2025 conditions, the only difference between the San Jose/Santa Clara and CMP intersection analyses is that project impacts are determined on the basis of different level of service standards. The correlation between average delay and level of service is shown in Table 2.

It should be noted that for the purposes of this analysis, all City of San Jose and City of Santa Clara study intersections were analyzed based on their corresponding level of service standards, while the CMP study intersections were also analyzed following the CMP level of service standards. For example, if a CMP intersection in the City of San Jose would operate at LOS E, it is noted that it would be unacceptable under City of San Jose standards, but acceptable under CMP standards.

Unsignalized Intersections

One unsignalized intersection is being analyzed: the intersection of Lafayette Street and Harrison Street. The unsignalized study intersection is located in the City of Santa Clara. The City of Santa Clara does not have a level of service standard for unsignalized intersections. Therefore, the analysis of the unsignalized study intersection is presented for informational purposes only.

The unsignalized study intersection was analyzed using TRAFFIX software, which is based on the Highway Capacity Manual (HCM) 2000 method. This method is applicable for both two-way and all-way stop-controlled intersections. For the analysis of stop-controlled intersections, the 2000 HCM methodology evaluates intersection operations on the basis of average control delay time for all vehicles on the stop-controlled approaches. For the purpose of reporting level of service for one- and two-way stop-controlled intersections, the delay and corresponding level of service for the stop-controlled minor street approach with the highest delay is reported. For all-way stop-controlled intersections, the reported average delay and corresponding level of service is the average for all approaches at the intersection.

The correlation between average control delay and level of service for unsignalized intersections is shown in Table 3.

Table 2
Signalized Intersection Level of Service Definitions Based on Control Delay

Level of Service	Description	Average Control Delay Per Vehicle (Sec.)
A	Operations with very low delay occurring with favorable progression and/or short cycle lengths.	Up to 10.0
B	Operations with low delay occurring with good progression and/or short cycle lengths.	10.1 to 20.0
C	Operations with average delays resulting from fair progression and/or longer cycle lengths. Individual cycle failures begin to appear.	20.1 to 35.0
D	Operations with longer delays due to a combination of unfavorable progression, long cycle lengths, or high V/C ratios. Many vehicles stop and individual cycle failures are noticeable.	35.1 to 55.0
E	Operations with high delay values indicating poor progression, long cycle lengths, and high V/C ratios. Individual cycle failures are frequent occurrences. This is considered to be the limit of acceptable delay.	55.1 to 80.0
F	Operation with delays unacceptable to most drivers occurring due to over saturation, poor progression, or very long cycle lengths.	Greater than 80.0

Source: Transportation Research Board, 2000 Highway Capacity Manual. (Washington, D.C., 2000)

Table 3
Unsignalized Intersection Level of Service Definitions Based on Control Delay

Level of Service	Description	Average Control Delay Per Vehicle (sec.)
A	Operations with very low delays occurring with favorable progression.	Up to 10.0
B	Operations with low delays occurring with good progression.	10.1 to 15.0
C	Operations with average delays resulting from fair progression.	15.1 to 25.0
D	Operation with longer delays due to a combination of unfavorable progression and high V/C ratios.	25.1 to 35.0
E	Operation with high delay values indicating poor progression and high V/C ratios. This is considered to be the limited of acceptable delay.	35.1 to 50.0
F	Operation with delays unacceptable to most drivers occurring due to oversaturation and poor progression.	Greater than 50.0

Source: Transportation Research Board, 2000 Highway Capacity Manual. (Washington, D.C., 2000)

City of San Jose Downtown Core Area Intersections

According to the City of San Jose traffic impact analysis guidelines (contained in the *San Jose Traffic Impact Analysis Handbook*, August 2008), in recognition of the unique position of the Downtown Core Area as the transit hub of Santa Clara County and as the center for financial, business, institutional, and cultural activities, development within the Downtown Core Area is exempted from traffic mitigation requirements. The Downtown Core Area is generally bounded by Coleman Avenue and Julian Street to the north, 4th Street to the east, Reed Street to the south, and Stockton Avenue and the Caltrain railroad line to the west. Downtown Core Area intersections are also exempted from the Level of Service D performance criterion adopted by the City of San Jose.

Study intersections that are located within the Downtown Core Area include:

In the vicinity of the Diridon Station

- (2) Stockton Avenue and West Julian Street
- (3) North Montgomery Street and West Julian Street
- (4) North Autumn Street and West Julian Street
- (5) SR 87 (W) and West Julian Street*
- (6) SR 87 (E) and West Julian Street*
- (9) Stockton Avenue and The Alameda
- (10) Cahill Street and West Santa Clara Street
- (11) South Montgomery Street and West Santa Clara Street*
- (12) South Autumn Street and West Santa Clara Street*
- (13) SR 87 and West Santa Clara Street*
- (14) South Montgomery Street and San Fernando Street
- (15) South Autumn Street and San Fernando Street
- (16) Delmas Avenue and San Fernando Street
- (17) South Montgomery/Autumn Street and Park Avenue
- (18) Delmas Avenue and Park Avenue
- (22) Bird Avenue and San Carlos Street*
- (23) Bird Avenue and Auzerais Avenue
- (26) Bird Avenue and I-280 (N)*

City of San Jose Protected Intersections

The City of San Jose has identified various intersections throughout the City for which no further vehicle capacity improvements are planned. These intersections are built to their maximum capacity, where further expansion would negatively affect existing or approved transit facilities, nearby land uses, and/or local neighborhoods. These intersections are referred to as the *Protected Intersections*.

According to the *San Jose Traffic Impact Analysis Handbook*, if a proposed development project will cause a significant LOS impact at one or more of the Protected Intersections, the proposed development will be required to construct specific improvements to other segments of the citywide transportation system to improve overall person-trip capacity and/or enhance non-auto travel modes. The threshold of significance for protected intersections is one-half that of non-protected intersections. By funding these improvements to the City's overall multi-modal transportation system, the development project will contribute substantially to achieving General Plan goals for improving and expanding the City's multi-modal transportation system. The development project would, therefore, be consistent with the City's General Plan multi-modal Transportation Policies, including the Traffic Level of Service Policy. The current list of protected intersections includes a total of 25 intersections.

Study locations that are part of the protected intersections include:

In the vicinity of the Alum Rock/28th Street Station

- (8) 24th Street and East Santa Clara Street

In the vicinity of the Diridon Station

(19) Meridian Avenue and San Carlos Street

Signal Warrants

The level of service analysis at unsignalized intersections is supplemented with an assessment of the need for signalization of the intersection. The need for signalization of unsignalized intersections is assessed based on the Peak Hour Volume Warrant (Warrant 3) described in the *California Manual on Uniform Traffic Control Devices for Streets and Highways (CA MUTCD)*, Part 4, Highway Traffic Signals, 2012. This method makes no evaluation of intersection level of service, but simply provides an indication whether vehicular peak hour traffic volumes are, or would be, sufficient to justify installation of a traffic signal. The decision to install a traffic signal should not be based purely on the warrants alone. Instead, the installation of a signal should be considered and further analysis performed when one or more of the warrants are met. Additionally, engineering judgment is exercised on a case-by-case basis to evaluate the effect a traffic signal will have on certain types of accidents and traffic conditions at the subject intersection as well as at adjacent intersections. Intersections that meet the peak hour warrant are subject to further analysis before determining that a traffic signal is necessary. Other options such as traffic control devices, signage, or geometric changes may be preferable based on existing field conditions.

Freeway Segments

As prescribed in the CMP technical guidelines, the level of service for freeway segments is estimated based on vehicle density. Density is calculated by the following formula:

$$D = V / (N * S)$$

where:

D= density, in vehicles per mile per lane (vpml)

V= peak hour volume, in vehicles per hour (vph)

N= number of travel lanes

S= average travel speed, in miles per hour (mph)

The vehicle density on a segment is correlated to level of service as shown in Table 4. The CMP requires that mixed-flow lanes and auxiliary lanes be analyzed separately from HOV (carpool) lanes. The CMP specifies that a capacity of 2,300 vehicles per hour per lane (vphpl) be used for segments six lanes or wider in both directions and a capacity of 2,200 vphpl be used for segments four lanes wide in both directions. The CMP defines an acceptable level of service for freeway segments as LOS E or better.

Freeway Interchange Ramp Analysis

An assessment of queue lengths and operations on freeway ramps serving the Phase II Project Station areas was performed where traffic volumes are projected to increase as a result of the proposed project. Only those ramps where the proposed Phase II Project is projected to add 10 or more trips per lane to the freeway ramps were included in this analysis.

The analysis was based on queue length projections at the following freeway ramps:

US 101/McKee Road Southbound On-Ramp

US 101/McKee Road Southbound Loop Off-Ramp

US 101/Santa Clara Street Southbound On-Ramp

US 101/Alum Rock Avenue Northbound Off-Ramp

All other freeway ramps serving the Phase II Project area are not projected to experience increases in traffic of 10 or more peak hour trips per lane with implementation of the Phase II Project.

Table 4
Freeway Segment Level of Service Definitions Based on Density

Level of Service	Description	Density (vehicles/mile/lane)
A	Average operating speeds at the free-flow speed generally prevail. Vehicles are almost completely unimpeded in their ability to maneuver within the traffic stream.	0-11
B	Speeds at the free-flow speed are generally maintained. The ability to maneuver within the traffic stream is only slightly restricted, and the general level of physical and psychological comfort provided to drivers is still high.	>11-18
C	Speeds at or near the free-flow speed of the freeway prevail. Freedom to maneuver within the traffic stream is noticeably restricted, and lane changes require more vigilance on the part of the driver.	>18-26
D	Speeds begin to decline slightly with increased flows at this level. Freedom to maneuver within the traffic stream is more noticeably limited, and the driver experiences reduced physical and psychological comfort levels.	>26-46
E	At this level, the freeway operates at or near capacity. Operations in this level are volatile, because there are virtually no usable gaps in the traffic stream, leaving little room to maneuver within the traffic stream.	>46-58
F	Vehicular flow breakdowns occur. Large queues form behind breakdown points.	>58

Source: Transportation Research Board, *Highway Capacity Manual (2000)*, Washington, D.C.

Freeway Ramp Queue Lengths

Queue lengths for the off-ramps were obtained from TRAFFIX level of service calculations for the intersections serving the off-ramp. Each of the ramp meters on the freeway on-ramps are not currently active and therefore, these ramps do not experience measurable queues. However, the freeway on-ramps are planned to be metered in the future (ramp meters are currently installed on the on-ramps but are not operational). Therefore, future queue lengths at the on-ramps were estimated based on the projected traffic volumes on the ramp (using Poisson's probability distribution) and assuming a maximum ramp meter rate of 900 vehicles per hour (vph). Once the demand on the ramp exceeds the capacity (the meter's service rate), the queue length can be estimated by calculating the excess ramp demand (or the difference between the ramp demand and the ramp meter rate). This simply states that any demand that cannot be served during the hour will accumulate in the queue, with the longest queue occurring at the end of the hour. The 900 vph meter rate is based on previous correspondence with Caltrans where it was determined that 4.0 seconds per vehicle is the maximum meter rate output for District 4, or approximately 900 vph. This rate is applicable to both mixed-flow and HOV traffic volumes, regardless of the number of lanes. Therefore, metered ramps will not serve more than 900 mixed-flow vehicles and 900 HOV during an hour.

The freeway ramp queue analysis is presented to identify locations where the projected queue length currently exceeds or is projected to exceed the available queue storage capacity. However, neither the Cities of San Jose and Santa Clara nor the CMP have standards that define vehicle queue impacts.

Therefore, the ramp queue analysis presented in this report is provided as supplemental analysis to the intersection level of service analysis and is presented for informational purposes only.

Significant Impact Criteria

Significance criteria are used to establish what constitutes an impact. Impacts of the project are based on No Project/Phase I traffic conditions with the proposed Project compared to No Project/Phase I traffic conditions without the proposed Project. For this analysis, the criteria used to determine significant impacts on signalized intersections are based on City of San Jose, City of Santa Clara, and VTA's Congestion Management Program (CMP) Level of Service standards. The LOS Policies of these cities and the CMP are the adopted thresholds for CEQA purposes. Project impacts on CMP study intersections and freeway segments were analyzed according to the CMP methodology.

The City of San Jose level of service standard for signalized intersections is LOS D or better. The City of Santa Clara level of service standard is LOS D or better at all city-controlled intersections and LOS E or better at all expressway and CMP intersections. The CMP level of service standard for CMP signalized intersections is LOS E or better.

City of San Jose Definition of Significant Intersection Impacts

The project is said to create a significant impact on year 2025 traffic conditions at a signalized intersection in the City of San Jose if, for either peak hour,

1. The level of service at the intersection degrades from an acceptable LOS D or better under 2025 No Project/Phase I Conditions to an unacceptable LOS E or F under 2025 Phase II Project Conditions.
or
2. The level of service at the intersection is an unacceptable LOS E or F under 2025 No Project/Phase I Conditions and the addition of project trips causes both the critical-movement delay at the intersection to increase by four (4) or more seconds and the critical volume-to-capacity ratio (V/C) to increase by one percent (.01) or more under 2025 Phase II Project Conditions, **or**
3. The level of service at a designated City of San Jose Protected Intersection is an unacceptable LOS E or F under 2025 No Project/Phase I Conditions and the addition of project trips causes the volume-to-capacity ratio (V/C) to increase by one-half percent (.005) or more under 2025 Phase II Project Conditions.

An exception to rule #2 above applies when the addition of project-generated traffic reduces the amount of average control delay for critical movements (i.e. the change in average control delay for critical movements is negative). In this case, the threshold of significance is an increase in the critical V/C value by one percent (0.01) or more.

In the City of San Jose, the evaluation of whether a project would cause a significant impact under the 2035 Phase II Project scenario is different from the evaluation process used for 2025 Phase II Project scenario. The City of San Jose's 2035 Phase II Project evaluation methodology requires comparison of the 2035 Phase II Project scenario to the 2025 No Project/Phase I scenario, and then determining if the proposed Phase II Project would contribute more than 25% of the total increase in traffic between the 2025 No Project/Phase I scenario and the 2035 Phase II Project scenario. Note that the term "2035 project trips" in San Jose's definition of significant impact below refers to all of the trips generated by **all** of the projects or land uses that are included in the 2035 Phase II Project scenario (including the proposed Phase II Project) that were not included in the 2025 No Project/Phase I scenario.

In the City of San Jose, a significant 2035 traffic impact at an intersection is identified by comparing 2035 Phase II Project against 2025 No Project/Phase I Conditions. The future projects included in the Year 2035 Phase II Project scenario **collectively** would create a significant impact on traffic conditions at a signalized intersection in the City of San Jose if during either the AM or PM peak hour:

1. The level of service at the intersection degrades from an acceptable LOS D or better under 2025 No Project/Phase I Conditions to an unacceptable LOS E or F under 2035 Phase II Project Conditions, or
2. The level of service at the intersection is an unacceptable LOS E or F under 2025 No Project/Phase I Conditions and the addition of 2035 Phase II Project trips causes both the critical-movement delay at the intersection to increase by four (4) or more seconds and the volume-to-capacity ratio (V/C) to increase by 0.01 or more under 2035 Phase II Project Conditions, or
3. The level of service at a designated Protected Intersection is an unacceptable LOS E or F under 2025 No Project/Phase I Conditions and the addition of 2035 Phase II Project trips causes the volume-to-capacity ratio (V/C) to increase by one-half percent (.005) or more under 2035 Cumulative Plus Project Conditions.

An exception to rule #2 above applies when the addition of project traffic reduces the amount of average delay for critical movements (i.e., change in average delay for critical movements is negative). In this case, the threshold of significance is an increase in the critical V/C value by 0.01 or more.

A single project's contribution to a 2035 Phase II Project intersection impact is deemed considerable in the City of San Jose if the proportion of project traffic represents 25 percent or more of the increase in total volume from 2025 No Project/Phase I traffic conditions to 2035 Phase II Project traffic conditions.

City of Santa Clara Definition of Significant Intersection Impacts

The project is said to create a significant impact on traffic conditions at a signalized intersection in the City of Santa Clara if, for either peak hour:

1. The level of service at the intersection degrades from an acceptable level (LOS D or better at all city-controlled intersections and LOS E or better at all expressway and CMP intersections) under 2025/2035 No Project/Phase I Conditions to an unacceptable level (LOS E or F at city-controlled intersections and LOS F at expressway and CMP intersections) under 2025/2035 Phase II Project Conditions, or.
2. The level of service at the intersection is an unacceptable level (LOS E or F at city-controlled intersections and LOS F at expressway and CMP intersections) under 2025/2035 No Project/Phase I Conditions and the addition of project traffic causes both the average critical delay at the intersection to increase by four or more seconds and the volume-to-capacity ratio (V/C) to increase by one percent (0.01) or more under 2025/2035 Phase II Project Conditions.

An exception to rule #2 above applies when the addition of project-generated traffic reduces the amount of average control delay for critical movements (i.e., the change in average control delay for critical movements is negative). In this case, the threshold of significance is an increase in the critical V/C value by one percent (0.01) or more.

CMP Definition of Significant Intersection Impacts

The Project is said to create a significant impact on traffic conditions at a CMP intersection if, for either peak hour

1. The level of service at a CMP-designated intersection degrades from an acceptable LOS E or better under 2025/2035 No Project/Phase I Conditions to an unacceptable LOS F under 2025/2035 Phase II Project Conditions, or.
2. The level of service at a CMP-designated intersection is an unacceptable LOS F under 2025/2035 No Project/Phase I Conditions and the addition of project traffic causes both the critical-movement delay at the intersection to increase by four or more seconds and the critical volume-to-capacity ratio (V/C) to increase by 0.01 or more under 2025/2035 Phase II Project Conditions.

An exception to rule #2 above applies when the addition of project-generated traffic reduces the amount of average control delay for critical movements (i.e. the change in average control delay for critical movements is negative). In this case, the threshold of significance is an increase in the critical V/C value by one percent (0.01) or more.

CMP Definition of Significant Freeway Impacts

The CMP defines an acceptable level of service for freeway segments as LOS E or better. A project is said to create a significant impact on traffic conditions on a freeway segment if, for either peak hour:

1. The LOS on a freeway segment degrades from an acceptable LOS E or better under better under 2025/2035 No Project/Phase I Conditions to an unacceptable LOS F under 2025/2035 Phase II Project Conditions, **or**
2. The LOS on a freeway segment is an unacceptable LOS F under 2025/2035 No Project/Phase I conditions, **and** the amount of net project traffic on that segment constitutes at least one percent of capacity on that segment.

A significant impact is considered substantially mitigated when 2025/2035 Phase II Project Mitigated conditions intersection operations are compared against 2025/2035 No Project/Phase I conditions and no significant adverse impact criteria are triggered.

Report Organization

The remainder of this report is divided into the following ten chapters:

- Chapter 2 describes existing conditions in terms of the existing roadway network, transit service, and existing bicycle and pedestrian facilities. Existing Plus Project conditions are addressed in Appendix B of this TIA.
- Chapter 3 presents traffic operations under Year 2025 Phase I/No Project conditions for all station areas.
- Chapter 4 describes the method used to estimate traffic associated with the proposed Phase II Project, discusses projections of traffic associated with the Alum Rock/28th Street Station, and presents traffic conditions and potential project impacts in the vicinity of the Alum Rock/28th Street Station under the Year 2025 Phase II Project conditions.
- Chapter 5 includes projections of traffic associated with the proposed Diridon Station and presents traffic conditions and potential project impacts in the vicinity of the Diridon Station under the Year 2025 Phase II conditions.
- Chapter 6 includes projections of traffic associated with the proposed Santa Clara Station and presents traffic conditions and potential project impacts in the vicinity of the Santa Clara Station under the Year 2025 Phase II conditions under both PNR facility concepts.
- Chapter 7 presents traffic operations under Year 2035 Phase I/No Project conditions for all station areas.
- Chapter 8 includes projections of traffic associated with the proposed Alum Rock/28th Street Station and presents traffic conditions and potential project impacts in the vicinity of the Alum Rock/28th Street Station under the Year 2035 Phase II Project conditions.
- Chapter 9 includes projections of traffic associated with the proposed Diridon Station and presents traffic conditions and potential project impacts in the vicinity of the Diridon Station under the Year 2035 Phase II conditions.

- Chapter 10 includes projections of traffic associated with the proposed Santa Clara Station and presents traffic conditions and potential project impacts in the vicinity of the Santa Clara Station under the Year 2035 Phase II conditions.
- Chapter 11 presents the conclusions of the transportation impact analysis.

2. Existing Transportation System

This chapter describes the existing conditions for all of the major transportation facilities in the vicinity of the proposed Phase II station sites, including the roadway network, transit service, and bicycle and pedestrian facilities.

Existing Roadway Network

Regional access to the station sites is provided via US 101, I-280, SR 87, and I-880. These facilities are described below:

US 101 is a north-south freeway that extends northward through San Francisco and southward through Gilroy. Within the study area, US 101 is an eight-lane facility that includes two high-occupancy vehicle (HOV) lanes. During the peak commute hours, the mixed-flow lanes operate under stop-and-go conditions in the peak direction of travel—northbound in the AM and southbound in the PM. Within the HOV lane, traffic flows well, although volumes at certain locations are approaching capacity during the peak periods. US 101 would provide access to the Alum Rock/28th Street Station site via its full interchanges at East Santa Clara Street and McKee Road.

Interstate 280 (I-280) is generally an eight-lane freeway in the vicinity of Downtown San Jose with auxiliary lanes between some interchanges. It extends from US 101 in San Jose to I-80 in San Francisco. The section of I-280 just north of the Bascom Avenue overcrossing has six mixed-flow lanes and two high-occupancy-vehicle (HOV) lanes. Connections from I-280 to Downtown San Jose are provided via a full interchange at Bird Avenue, and partial interchanges at Seventh Street (no north on-ramp), at Almaden Boulevard/Vine Street (ramps to/from north), First Street (ramp to south), and Fourth Street (ramp to north). I-280 provides access to the Diridon Station via its interchange at Bird Avenue. Connections are also available indirectly via an interchange with SR 87 (to the Diridon Station) and an interchange with US 101 (to the Alum Rock/28th Street Station).

State Route 87 (SR 87) connects from SR 85 in south San Jose to US 101 near the San Jose International Airport. It is generally a six-lane freeway (two mixed-flow lanes plus one HOV lane in each direction) with auxiliary lanes near the I-280 interchange. Connections from SR 87 to Downtown San Jose and the Diridon Station are provided via a full interchange at West Julian Street and partial interchanges at Park Avenue (ramps to/from north only), at Auzerais Avenue (ramps to/from south only), and at West Santa Clara Street (northbound off-ramp only).

Interstate 880 (I-880) extends in a north-south direction from its junction with I-280 near Downtown San Jose to I-80 in Oakland. Within the study area, I-880 has six mixed-flow lanes. Near the Santa Clara Station site, the peak direction of travel is northbound during the morning commute and southbound

during the afternoon commute. I-880 provides access to the Santa Clara Station site via interchanges with The Alameda and Coleman Avenue.

Roadways providing local access to each of the station sites and their configurations in the area of the stations are described below:

Alum Rock/28th Street Station

North 28th Street is a two-lane north-south roadway that extends from East Julian Street southward to San Antonio Street. North 28th Street provides direct access to the Alum Rock/28th Street Station site via both East Julian Street and East Santa Clara Street.

McKee Road is an east-west roadway with full freeway interchanges at I-680 and US 101. McKee Road extends from the foothills in East San Jose to North 28th Street (west of US 101). At North 28th Street, McKee Road becomes East Julian Street, which traverses westward through Downtown San Jose. McKee Road has four travel lanes between US 101 and King Road. East of King Road, McKee Road widens to six lanes. East of Jackson Avenue, it narrows back to two lanes in each direction.

Alum Rock Avenue is an east-west roadway with a partial cloverleaf interchange at I-680 and a diamond interchange at US 101. Alum Rock Avenue extends from Alum Rock Park near the foothills in East San Jose to US 101. At US 101, Alum Rock Avenue becomes East Santa Clara Street, which traverses westward through Downtown San Jose. Alum Rock Avenue consists of four travel lanes within the study area.

San Antonio Street is a two-lane east-west roadway that runs between San Jose State University and Capitol Expressway. At I-680, San Antonio Street merges to Capitol Expressway and traverses southward.

Diridon Station

West Santa Clara Street is a four-lane east-west roadway that transverses the San Jose Downtown core area. East of 1st Street, West Santa Clara Street becomes East Santa Clara Street and west of the Caltrain bridge (located just east of Stockton Avenue) it becomes The Alameda. West Santa Clara Street would provide direct access to the Diridon Station via Cahill Street.

The Alameda (State Route 82) is generally a four-lane arterial that is oriented in a north-south direction and runs from Santa Clara University to the Downtown San Jose area where it becomes West Santa Clara Street east of Stockton Avenue.

Stockton Avenue is a two- to three-lane roadway [one lane in each direction plus a two-way left-turn lane (TWLTL)] that extends in a northwest direction from south of The Alameda to Emory Street, just south of the Caltrain railroad tracks. North of the Caltrain railroad tracks, Stockton Avenue extends north of (without connection to) I-880, where it terminates.

Julian Street is primarily a one-way westbound two-lane roadway within the San Jose Downtown core area. West and east of the Downtown core area at SR 87 and 17th Street, respectively, Julian Street is generally a two-way two-lane facility. The City of San Jose plans to remove the S-shape segment of West Julian Street between Market Street and the SR 87 Northbound Ramps and replace it with a straight, two-way extension from North Market Street to Terraine Street. Additionally, the segment of West St. James Street, between the SR 87 Northbound Ramps and North Market Street, would become a two-way roadway, forming a grid system roadway network. West Julian Street provides regional access to the Diridon Station via its full interchange with SR 87.

San Fernando Street is a two-lane roadway that is oriented in an east-west direction and runs from 17th Street to Race Street. Within the San Jose Downtown area, specifically between South 10th Street and South 1st Street, San Fernando Street consists of a two-lane plus a TWLT lane roadway. In the vicinity of the Diridon Caltrain Station, San Fernando Street terminates at Cahill Street, east of the Caltrain railroad tracks, and continues to Race Street west of the Caltrain railroad tracks.

San Carlos Street is a four-lane east-west arterial that runs from 4th Street to Bascom Avenue, just east of I-880, at which point it becomes Stevens Creek Boulevard.

Autumn Street is currently a two- to three-lane roadway that is oriented in a north-south direction and extends from Park Avenue to Cinnabar Street, north of West Julian Street. The segment of South Autumn Street between Park Avenue and West Santa Clara Street is a three-lane one-way (northbound) roadway and works as a couplet with South Montgomery Street (southbound). The City of San Jose plans to extend North Autumn Street to connect to Coleman Avenue (at New Autumn Street) and change the existing one-way segment to a four-lane two-way roadway. The reconfigured two-way Autumn Street segment will become the north-south connection between Santa Clara Street and Park Avenue.

Montgomery Street is currently a two-lane roadway that runs between West San Carlos Street and West Santa Clara Street. North of the SAP Center, North Montgomery Street extends between West St. John Street and Cinnabar Street as a two-lane two-way roadway. South of West San Carlos Street, Montgomery Street transitions into Bird Avenue. The segment of South Montgomery Street, between Park Avenue and West Santa Clara Street, is a two-lane one-way (southbound) roadway and works as a couplet with South Autumn Street (northbound). The City of San Jose plans to change the existing one-way segment of South Montgomery Street to a two-lane two-way roadway terminating in a cul-de-sac just north of its current intersection with Park Avenue. The reconfigured two-way Montgomery Street segment will become a local street providing direct access to the existing surrounding land uses, including the Diridon Caltrain Station.

Bird Avenue is a four-lane arterial that is oriented in a north-south direction and provides access to I-280 and the downtown area. Bird Avenue runs from the Willow Glen Area of San Jose to West San Carlos Street, where it transitions into South Montgomery Street.

Santa Clara Station

El Camino Real (State Route 82) is a six-lane major arterial that is oriented in an east-west direction extending westward from The Alameda towards the City of Sunnyvale, and then continuing northward through the peninsula to Daly City, at the northern edge of San Mateo County.

Coleman Avenue is four- to six-lane roadway that is oriented in a north-south direction. Coleman Avenue begins at De La Cruz Boulevard in Santa Clara and extends southward into Downtown San Jose where it becomes North Market Street at its intersection with West Julian Street. Coleman Avenue would provide access to the Santa Clara Station site via its intersection with Brokaw Road.

Brokaw Road is a two-lane east-west roadway that runs from Martin Avenue westward to its termination point at the railroad lines. Direct access to the proposed Santa Clara Station site is provided via Brokaw Road.

San Tomas Expressway is a six to eight-lane major arterial that is oriented in a north-south direction. There is one high-occupancy-vehicle lane along San Tomas Expressway (restricted hours only) in each direction of travel. Access to the proposed Santa Clara Station site is provided via El Camino Real.

Lafayette Street is a four-lane roadway that is oriented in a north-south direction. Lafayette Street extends from SR 237 southward through the City of Santa Clara to Market Street where it changes designation to Washington Street.

Benton Street is a two to four-lane roadway that is oriented in an east-west direction. Benton Street extends between the Santa Clara Caltrain Station, near El Camino Real, and Lawrence Expressway. West of Lawrence Expressway, Benton Street becomes a two-lane residential street.

De La Cruz Boulevard is a six-lane arterial that extends from US 101 to Coleman Avenue. North of US 101, De La Cruz Boulevard becomes Trimble Road. The 3-way intersection of De La Cruz Boulevard and Coleman Avenue is composed entirely of ramps, after which De La Cruz extends west over the railroad tracks and El Camino Real and then transitions to Lewis Street.

Existing Bicycle Facilities

There are several bicycle facilities in each of the station areas. As defined by the California Department of Transportation (Caltrans), bicycle facilities include Class I bikeways (defined as bike paths off street, which are shared with pedestrians and exclude general motor vehicle traffic), Class II bikeways (defined as striped bike lanes on street), and Class III bike routes (defined as roads with bike route signage where bicyclists share the road with motor vehicles), and Class IV cycle tracks (bike lanes physically separated from vehicle traffic by a vertical element). Streets may be rated as high caution (heavy traffic volumes with high traffic speeds), alert (moderate traffic volumes and speeds), and moderate (low traffic volumes and moderate to low traffic speeds). With the exception of limited access highways, bicyclists are allowed to ride on any roadway, even if there is no bicycle facility present.

In Santa Clara County, bicycle facilities are typically constructed and maintained by local jurisdictions. Bikeways that serve the stations fall within City of San Jose, the City of Santa Clara, and Santa Clara County jurisdictions, and are maintained by the agencies. .

The *Santa Clara Countywide Bicycle Plan*, adopted by VTA in August 2008, identifies various existing and/or planned cross county bicycle corridors in the vicinity of the proposed BART Stations. The purpose of the Cross County Bicycle Corridors, as described in the above document, is to provide continuous connections between Santa Clara county jurisdictions and to adjacent counties, and to serve the major regional trip-attractors in the County. The cross county bicycle corridors serving the station areas are discussed below.

Bicycle facilities in the area of each of the stations are presented in Figures 8, 9, and 10 and described below.

Alum Rock/28th Street Station

The Alum Rock/28th Street Station site is moderately accessible by bicycle. The station site is surrounded by bicycle facilities, but none provide a direct connection to the site. Class II bike lanes are provided on Mabury Road, 21st Street, portions of San Antonio Street, and Jackson Avenue. There are no Class I bikeways that serve the station area. The streets near the station site, Santa Clara Street/Alum Rock Avenue and McKee Road, are identified as “high caution” roads in VTA’s Bikeways Map (May 2016).

Access to the station site from the east is constrained by U.S. Highway 101 (U.S. 101); the closest freeway crossings to the site are at McKee Road and Alum Rock interchanges. Neither are designed well for bicyclists. Access from the west is constrained by Coyote Creek; bicyclists may cross Coyote Creek on Julian Street (identified as “Alert” in VTA’s Bikeways Map), Santa Clara Street (“High Caution”), or San Antonio Street. None of these roads have bike lanes, and only San Antonio Street is designated as a Class III bike route. No nearby bicycle facilities connect from the north. From the south, there are bicycle lanes on 24th Street; however, these stop half a mile before the station, and bicyclists traveling on 24th Street must bike through an interchange with I-280.

VTA’s 2008 Santa Clara Countywide Bicycle Plan identifies San Antonio Street as a Cross County Bicycle Corridor (CCBC). This is the closest CCBC to the Alum Rock/28th Street Station Site.

The Countywide Bicycle Plan identifies the interchange of Julian Street/McKee Road and U.S. 101, and Santa Clara Street over U.S. 101 as “Across Barrier Connections” needing bicycle improvements.

There are no nearby Bay Area Bikeshare stations.

The City of San Jose’s planned Coyote Creek Trail will complete a Class I bikeway along Coyote Creek between Milpitas (Dixon Landing Road) and Coyote Lake in the South County. Currently, bicycle facilities along this corridor are missing between Montague Expressway and Tully Road and Anderson Lake County Park and Coyote Lake County Park. Coyote Creek runs west of the Alum Rock/28th Street Station.

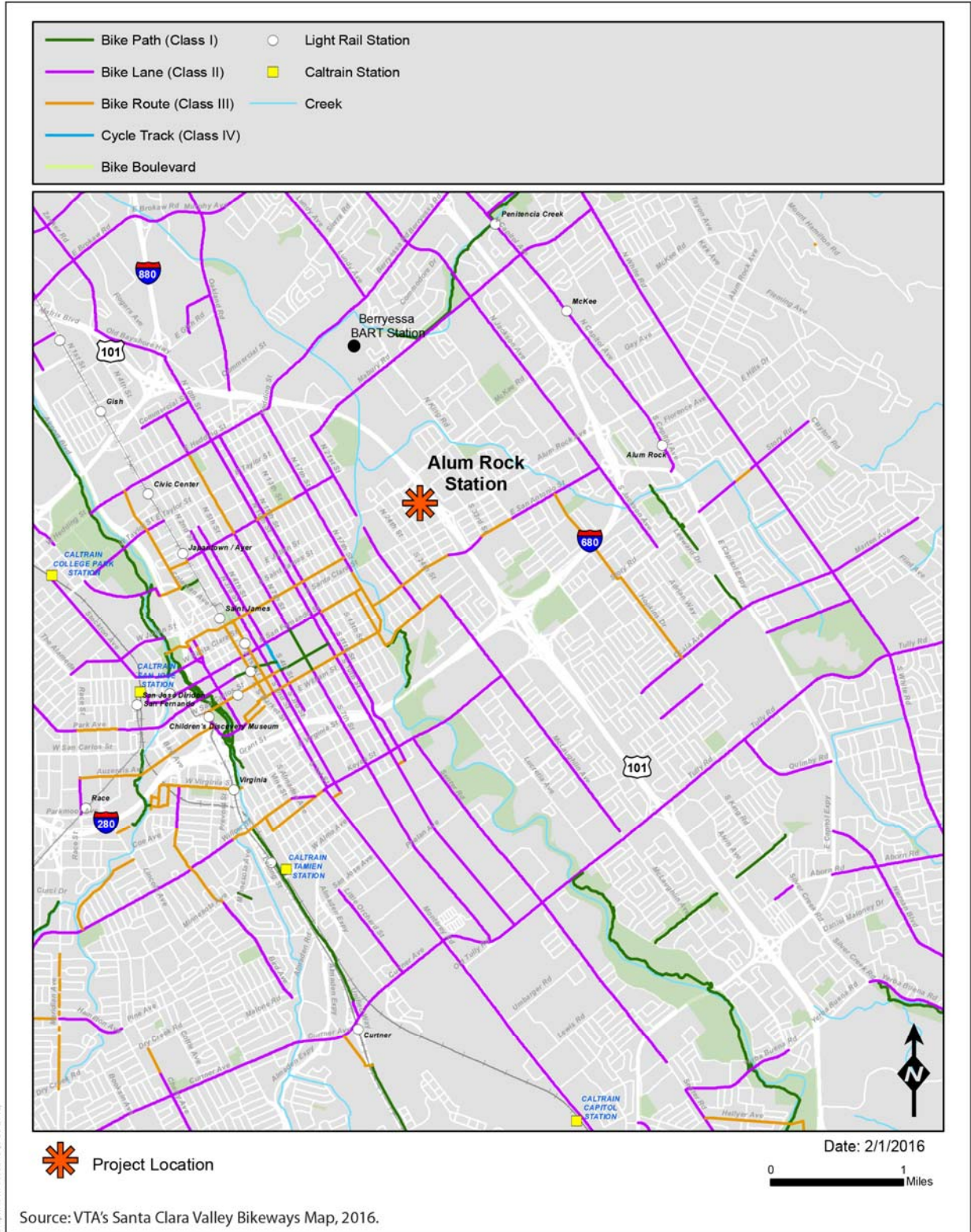

Figure 8
Existing Bicycle Facilities – Alum Rock/28th Street Station Area

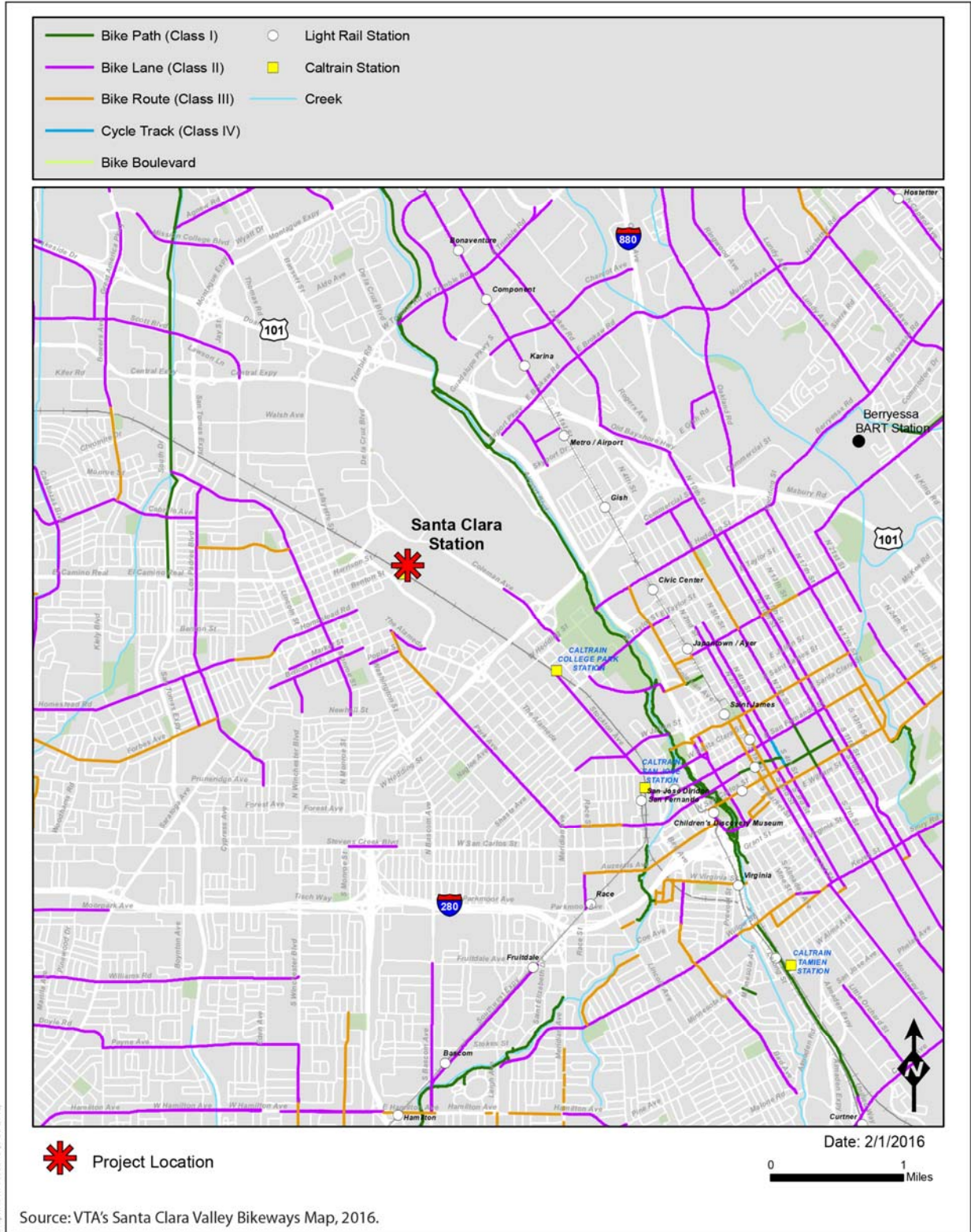

Figure 10
Existing Bicycle Facilities – Santa Clara Station Area

Diridon Station

Diridon Station is generally accessible by bicycle, and very close to two major bicycle paths. Diridon Station is served by Class II bicycle lanes on Stockton Avenue, Santa Clara Street, San Fernando Street, and Park Avenue. There are few low-stress bicycle connections from Diridon Station directly south. Montgomery Avenue, which provides the most direct connection south, is rated as “High Alert” on the VTA Bikeways Map.

The Guadalupe River Trail is one-third of a mile to the east, and provides high quality bicycle access south to Virginia Street and north to Alviso, with connections to the Highway 237 Bicycle Path and the Bay Trail. Bicyclists can access the trail at San Fernando Street, Park Avenue, and Santa Clara Street. There is no wayfinding signage directing bicyclists from the station to the trailheads.

The Los Gatos Creek Trail (Class I bikeway) is one-third of a mile south of Diridon Station, and provides low-stress bicycle access south to the Willow Glen neighborhood. Bicyclists can access the trail at West San Carlos Street. There is no wayfinding signage directing bicyclists from the station to the trailhead. After a gap between Lonus Street and Meridian Avenue, the Los Gatos Creek Trail continues south to Main Street in Los Gatos, connecting Willow Glen, Downtown Campbell, and Downtown Los Gatos.

The Countywide Bicycle Plan identifies the following locations as “Across Barrier Connections” needing bicycle improvements: the San Carlos Street undercrossing of SR 87 and the interchange of Park Avenue and SR 87.

Within the vicinity of the station site, VTA’s 2008 Santa Clara Countywide Bicycle Plan identifies the following streets or trails as Cross County Bicycle Corridors: Montgomery Street, Park Avenue, San Carlos Street, The Alameda, San Fernando Street, Los Gatos Creek Trail, and Guadalupe River Trail.

Bike lockers and a Bay Area Bikeshare station are provided at the existing San Jose Diridon Transit Center.

Santa Clara Station

The existing Santa Clara Transit Center (Caltrain Station) is difficult to access by bicycle, particularly from the north, east, and south, and the proposed Santa Clara BART Station would also be difficult to access under existing conditions. A Class III bicycle route on Benton Street provides direct access to the Santa Clara Transit Center (Caltrain station) from the west. No other bicycle facilities directly serve the station. Within two-thirds of a mile of the station, Class II bicycle lanes are provided on Monroe Street, Homestead Road, and portions of Coleman Avenue, the Alameda, Poplar Street, Market Street, and Bellomy Street, and a Class III bike route is provided on Park Avenue. Santa Clara University, located adjacent to the existing Santa Clara Transit Center, includes some disconnected Class I bikeways.

De La Cruz Avenue and Coleman Avenue are identified on VTA’s Countywide Bicycle Map as “High Caution” streets. The section of El Camino Real adjacent to the Caltrain station is identified as an “Alert” street.

Bicycle access is constrained by the rail lines, the Mineta San Jose International Airport, I-880, U.S. 101, SR 87, and the Guadalupe River. Bicyclists wishing to access the station from these directions must travel through high-stress freeway interchanges and major roadway intersections. East of the station site is the Guadalupe River Trail system, extending between Alviso and South San Jose. Although the Guadalupe River Trail is a mile to the east, there are no low-stress connections to the trail from the Santa Clara Station. There is no wayfinding signage directing bicyclists to the Guadalupe River Trail from the Santa Clara Station. Further from the Santa Clara Station site, the San Tomas Aquinas Creek Trail is a Class I bike trail that is west of the San Tomas Expressway and extends north to SR 237, near the San Francisco Bay.

Within the vicinity of the station site, VTA’s 2008 Santa Clara Countywide Bicycle Plan identifies the following streets or trails as “Cross County Bicycle Corridors”: Coleman Avenue, Brokaw Road, El Camino Real/The Alameda, Benton Street, Monroe Street, Park Avenue, Hedding Street, Airport Boulevard, and the Guadalupe River Trail. The Countywide Bicycle Plan identifies the following locations as places where bicycle crossing improvements need to be made: The Alameda/880 Interchange, and the railroad crossing of De La Cruz/El Camino Real/Lewis Street. The Countywide Bicycle Plan identifies

the need for a new bicycle/pedestrian bridge or undercrossing of the Caltrain Union Pacific Railroad tracks between De La Cruz Boulevard and Hedding Street. VTA is currently working on the design and construction of a bicycle/pedestrian undercrossing of the tracks at the Santa Clara Caltrain Station.

Bike lockers are provided at the existing Santa Clara Transit Center (Caltrain Station). There are no Bay Area Bikeshare Stations in the vicinity.

Existing Pedestrian Facilities

Pedestrian facilities in the study areas consist primarily of sidewalks, crosswalks, pedestrian push buttons, and signal heads at intersections. With a few exceptions, sidewalks are found along virtually all of the local roadways in the study areas and along the local residential streets and collectors near the station sites.

VTA is developing a Pedestrian Access to Transit Plan (anticipated adoption December 2016) to identify high-priority areas (Focus Areas) for pedestrian improvements. Several of the proposed BART stations fall within the Plan's Focus Areas. The Plan identifies specific infrastructure that could improve pedestrian comfort, safety, and convenience in these areas. Findings from field work conducted in the area are presented below.

Alum Rock/28th Street Station

Overall, the existing network of sidewalks has good connectivity and provides pedestrians with adequate routes to the surrounding land uses and transit services near the Alum Rock/28th Street Station campus. With the exception of the west side and most of the east side of North 28th Street between McKee Road and Santa Clara Street, and along some of the industrial areas north of the station site, sidewalks are found along previously described local roadways in the Alum Rock/28th Street Station study area and along the local residential streets and collectors near the station site. Additionally, all signalized intersections in the vicinity of the Alum Rock/28th Street Station have marked crosswalks on all or most of the legs of the intersection, combined with pedestrian push buttons and pedestrian signal heads.

For pedestrians who may walk between the residential neighborhood east of U.S. 101 and the Alum Rock/28th Street Station site or between the TOJD site and VTA bus routes along King Street, there are continuous sidewalks and crosswalks along Alum Rock Avenue, including pedestrian push buttons and signal heads for the crosswalks on the U.S. 101 on- and off-ramps, at 33rd Street, and at King Road. There are also continuous sidewalks and crosswalks along McKee Road between 28th Street and King Road, including pedestrian push buttons and signal heads for the crosswalks on the U.S. 101 on- and off-ramps, at 33rd Street, and at King Road.

However, although the pedestrian facilities in the vicinity of the Alum Rock/28th Street Station are minimally adequate as described above, the area is not an especially pedestrian-friendly environment at present. There are locations, such as the crosswalks near the U.S. 101 on- and off-ramps, where walking is not as comfortable as it could be. The City of San Jose plans to improve the pedestrian environment in this area through its ongoing efforts to promote greater usage of alternative modes of travel.

Diridon Station

Near the Diridon Station, sidewalks are found along virtually all local roadways. Signalized intersections along Santa Clara Street have marked crosswalks on all or most of the legs of the intersection, combined with pedestrian push buttons and pedestrian signal heads. Midblock crosswalks at Stover Street and Crandall are marked across Cahill Street, South Montgomery Street, and South Autumn Street, but are not signalized.

The Pedestrian Access to Transit Plan identified the following challenges to walking within the area of Diridon Station:

- Pathway and uncontrolled crossing between Diridon Station and San Fernando Light Rail unclear, blocked by parked vehicles.

- Missing curb ramps and worn crosswalk markings at sidewalks that provide access to Diridon Station entrance.
- At San Fernando VTA Light Rail Station, it is unclear that main route to San Fernando Street is through San Fernando VTA Station. Suggest wayfinding.
- Drivers observed not yielding to pedestrians at Delmas/Santa Clara uncontrolled crossing.
- Opportunity to provide pedestrian scramble at Montgomery/ Santa Clara intersection.
- At Santa Clara/Cahill intersection, pedestrians are prohibited from crossing the west leg, and curb radii are wide, yet there are high pedestrian volumes.
- Sidewalks missing at Laurel Grove Lane/ Park Avenue.

Santa Clara Station

Near the existing Santa Clara Transit Center (Caltrain Station) site, sidewalks are found along virtually all of the local roadways in the study area and along the local residential streets and collectors, with the exception of the east side of Lafayette Street. Additionally, signalized intersections in the vicinity of the Caltrain Station have marked crosswalks on all or most of the legs of the intersection, combined with pedestrian push buttons and pedestrian signal heads. However, there is less connectivity in the pedestrian facilities near the Santa Clara BART Station campus, due to the Caltrain tracks, the nearby Mineta San Jose International Airport, and the fact that some of the nearby streets serving industrial land uses do not include sidewalks.

There is a continuous sidewalk along the east side of De La Cruz Boulevard that connects with the sidewalk along Coleman Avenue, leading to the intersection at Brokaw Road where the Santa Clara Station would be located. However, the De La Cruz Boulevard overpass over El Camino Real and the Caltrain tracks and most portions of the interchange of De La Cruz Boulevard and Coleman Avenue do not include sidewalks. West of De La Cruz Boulevard, there is a bike and pedestrian bridge over the Caltrain tracks next to the Lafayette Street undercrossing. There is currently no convenient pedestrian access across the Caltrain tracks from the vicinity of the Santa Clara Caltrain Station to the site where the Santa Clara BART Station and TOJD would be located. However, a pedestrian undercrossing from the Caltrain center platform to Brokaw Road is under construction and planned to be completed in mid-2017.

Existing Transit Service

Existing transit service to the station areas is provided by VTA, Altamont Corridor Express (ACE), Amtrak, and Caltrain. The transit services are described below and shown on Figures 11, 12, and 13.

VTA Bus Service

The station areas are served directly by numerous local and express bus routes. Table 5 presents bus lines, service terminus points, and headway times during commute hours for each of the stations.

Shuttle Services

VTA also provides shuttle services. The Downtown Area Shuttle (DASH) provides shuttle service from the Diridon Caltrain Station to San Jose State University, the San Jose McEnery Convention Center LRT Station, and the Downtown San Jose area via San Fernando Street, West San Carlos Street, Almaden Boulevard, and Fourth Street with approximately 10-minute headways during the commute hours. The Free Airport Flyer (Route 10) provides shuttle service from the Santa Clara Transit Center to the Metro Airport LRT Station via the San Jose International Airport with approximately 15-minute headways during the commute hours.

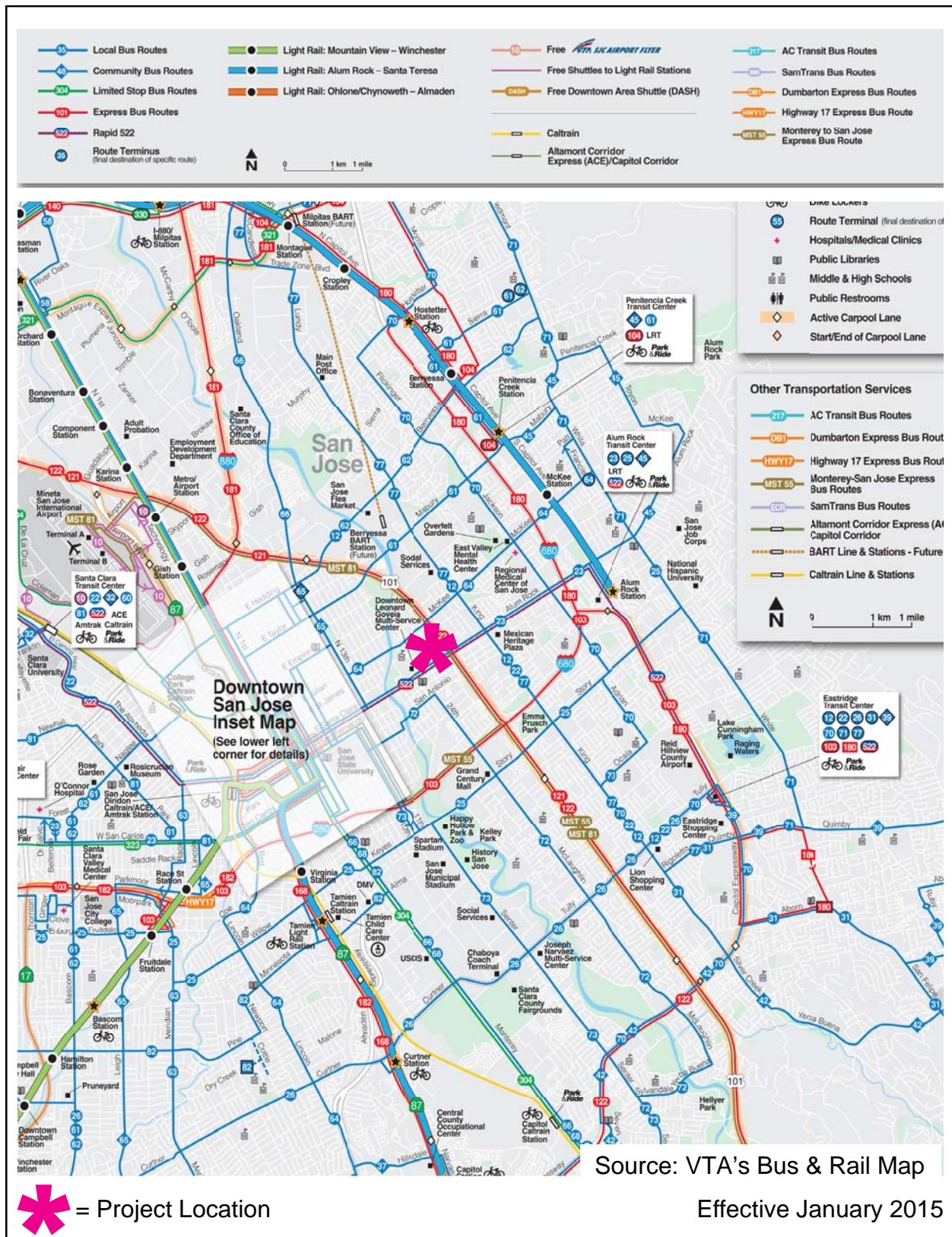

Figure 11 Existing Transit Services – Alum Rock/28th Street Station Area

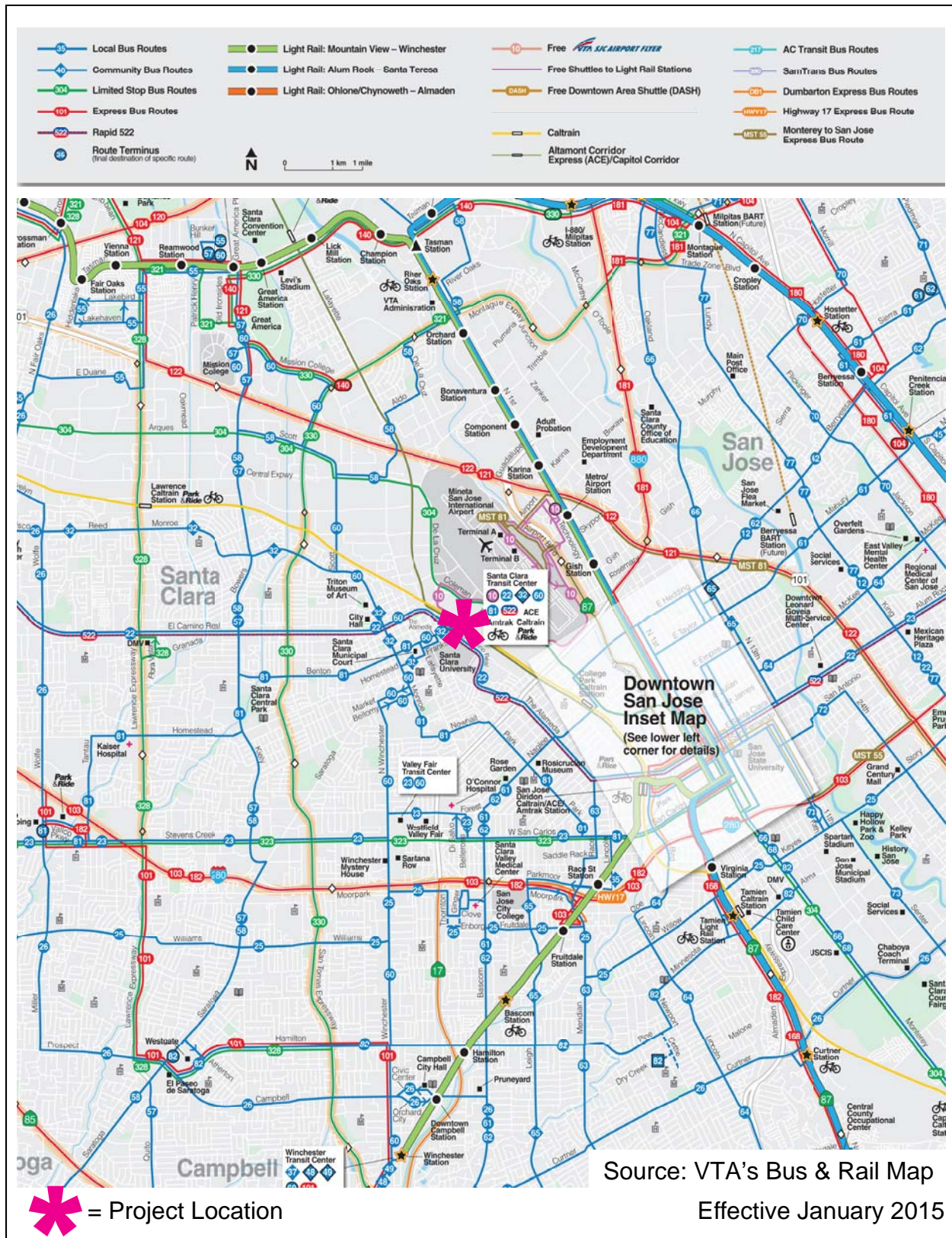

Figure 13
Existing Transit Services – Santa Clara Station Area

Table 5
Existing Bus Services by BART Station

Bus Lines	Route Description	Commute Hour Headways (min)	Stations Served
VTA Bus Routes			
22	Eastridge Transit Center to Palo Alto Transit Center	12	AR, Dir, SC
23	De Anza College to Alum Rock Transit Center	12	AR
32	San Antonio Shopping Center to Santa Clara Transit Center	30	SC
60	Winchester Transit Center to Great America	15	SC
63	Almaden Expressway & Camden to San Jose State University	30	Dir
64	Almaden LRT Station to McKee & White	15	AR, Dir
65	Kooser & Blossom Hill to Hedding & 13 th	45	Dir
68	Gilroy Transit Center to San Jose Diridon Transit Center	15-20	Dir
81	San Jose State University to Vallco	30	Dir, SC
VTA Express Bus Routes			
168	Gilroy Transit Center to Diridon Transit Center	20-30	Dir
181	Fremont BART Station to San Jose Diridon Transit Center	15	Dir
522	Eastridge Transit Center to Palo Alto Transit Center	15	AR, Dir, SC
Inter-county Bus Service			
HWY17	Downtown San Jose to Santa Cruz/Scott's Valley (Express)	15-45	Dir
MST 55	Monterey to Downtown San Jose (Express)	---	Dir
MST 81	Fort Hunter Liggett to Downtown San Jose (Express)	---	Dir
Free Shuttles			
10	Santa Clara Transit Center to Metro Airport LRT Station	15	SC
DASH	Downtown San Jose Area Shuttle	10-12	Dir

Notes:

AR = Alum Rock Station

Dir = Diridon Station

SC = Santa Clara Station

Source: VTA Santa Clara Valley Bus and Rail Map, January 2014, and the Monterey-Salinas Transit website.

Inter-County Bus Service (Diridon Station Only)

Inter-county bus service is provided by VTA, Santa Cruz Metro, and the Monterey Salinas Transit.

Highway 17 Express Bus provides service from Santa Cruz/Scott's Valley to Downtown San Jose (Diridon Caltrain Station) on 15-45 minute headways during the commute hours.

The Monterey Salinas Transit (MST) 55 Express line provides service between Monterey and the San Jose Diridon Station with three daily trips (one during the morning, one midday, and one in the evening).

The MST 81 Express line provides service between Fort Hunter Liggett (south of Soledad) to the San Jose Airport and Diridon Caltrain Station with two daily trips, one in the morning and one in the evening.

Light Rail Transit (LRT) Service (Diridon Station Only)

Light Rail Transit service is provided in the Downtown San Jose area by VTA. The Guadalupe Corridor (Alum Rock-Santa Teresa) and the Vasona Corridor (Mountain View-Winchester) LRT provide service to the Downtown San Jose area. The Guadalupe Corridor LRT provides service between the Alum Rock Station in East San Jose to the Santa Teresa Station in South San Jose, and the Vasona Corridor LRT provides service between the Mountain View Transit Center and the Winchester Transit Center, in Campbell. Both LRT lines run directly through Downtown San Jose alongside First and Second Streets. At San Carlos Street and SR 87, the Guadalupe Corridor LRT continues to South San Jose along SR 87 while the Vasona Corridor LRT continues to the Winchester Station after stopping at the Diridon Transit Center. Both lines provide service on 15-minute headways during commute hours. There are various LRT stations within the Downtown area that provide connections to virtually every bus line described above.

Caltrain (Diridon and Santa Clara Stations)

Caltrain operates a commuter rail service seven days a week between San Jose and San Francisco. During weekday commuting hours, Caltrain also serves the south county including Gilroy, San Martin and Morgan Hill. Caltrain provides shuttle service to businesses in the Silicon Valley and on the Peninsula.

The existing Diridon Caltrain Station (located west of Cahill Street) is located south of the proposed Diridon BART Station site. The existing Santa Clara Caltrain/ACE Station (located at Railroad Avenue and El Camino Real) is located on the opposite side of the rail tracks near the proposed Santa Clara BART Station site. The Diridon Caltrain Station provides service to the Downtown San Jose area via connections with bus lines 63, 64, 65, and 68 described above, express bus routes 168, 181, and Highway 17, in addition to the DASH, LRT, MST 55, MST 81, and ACE/Amtrak connections. The Santa Clara Caltrain Station provides service to the Santa Clara area via connections with bus lines 22, 32, 60, and 81 described above, rapid bus route 522, in addition bus route 10 and ACE/Amtrak connections. Caltrain provides service with 15- to 30-minute headways during commute hours.

ACE (Diridon and Santa Clara Stations)

The Altamont Commuter Express (ACE) provides commuter rail service between the Central Valley and Silicon Valley. Four trains are in operation during weekday commuting hours with westbound trains heading to San Jose in the morning and eastbound trains heading to Stockton in the evening. ACE Stations are located at the Santa Clara Transit Center and the Diridon Transit Center. Shuttle service from the stations to employment centers are provided by various public transit agencies.

Amtrak Capitol Corridor Inter-City Rail (Diridon and Santa Clara Stations)

Amtrak provides intercity passenger rail service between Auburn in Placer County and San Jose. There are seven round trips between Sacramento and San Jose on weekdays and weekends. An additional eight round trips operate only between Sacramento and Oakland. There is one round trip per day that serves Auburn. The trains share the Diridon Caltrain Station and the Santa Clara Caltrain Station facilities. In addition, Amtrak provides a daily Coast Starlight line from Los Angeles to Seattle..

Existing Intersection Lane Configurations

The existing lane configurations at the study intersections were determined by observations in the field. Figures 14, 15, and 16 presents existing intersection lane configurations for each of the station study intersections.

Existing Traffic Volumes

Existing peak-hour traffic volumes at most study intersections were obtained from manual turning-movement counts conducted in the fall of 2014. At four locations where construction was underway at the time of the 2014 counts, 2013 and 2015 counts were utilized. The existing peak-hour intersection volumes at each study intersection are shown on Figures 17, 18, and 19. The existing conditions level of service tables (described in the following section) include counts dates/count year for each of the study intersections. The traffic count data are included in Appendix C.

Existing Intersection Levels of Service

The near-term traffic information is presented merely to identify possible constraints to transportation improvements near the proposed station sites. A total of 17 intersections were evaluated in the vicinity of the proposed Alum Rock/28th Street Station, 29 intersections in the vicinity of the proposed Diridon Station, and 17 intersections in the vicinity of the proposed Santa Clara Station.

Alum Rock/28th Street Station

The results of the level of service analysis under existing conditions for the Alum Rock/28th Street Station are summarized in Table 6. The results show that all of the study intersections, both local City of San Jose and CMP intersections, currently operate at an acceptable level of service (LOS D or better for local City of San Jose intersections, and LOS E or better for CMP intersections) according to City of San Jose and the CMP level of service standards. The level of service calculation sheets for the Alum Rock/28th Street Station are included in Appendix E.

Diridon Station

The results of the level of service analysis under existing conditions for the Diridon Station are summarized in Table 7. The results show that all of the study intersections, both local City of San Jose and CMP intersections, currently operate at an acceptable level of service (LOS D or better for local City of San Jose intersections, and LOS E or better for CMP intersections) according to City of San Jose and the CMP level of service standards. The level of service calculation sheets for the Diridon Station are included in Appendix F.

Santa Clara Station

The results of the level of service analysis under existing conditions for the Santa Clara Station are summarized in Table 8. The results show that the following study intersections currently operate at unacceptable levels of service (LOS E or worse for local City of Santa Clara intersections and LOS F for expressways and CMP intersections) during at least one peak hour, according to City of Santa Clara and CMP level of service standards. The CMP intersections are denoted by an asterisk (*).

- (11) Coleman Avenue and Brokaw Road (LOS F – PM peak hour)
- (16) De La Cruz Boulevard and Central Expressway * (LOS F – AM and PM peak hours)

Although the City of Santa Clara does not have a level of service standard for unsignalized intersections, an evaluation of the unsignalized study intersection was performed for informational purposes. The level of service analysis shows that the intersection of Lafayette Street and Harrison Street (#15) currently operates at LOS E and F during the AM and PM peak hours, respectively. However, the peak-hour traffic signal warrant checks indicate that the intersection does not currently have traffic volumes that meet thresholds that warrant signalization.

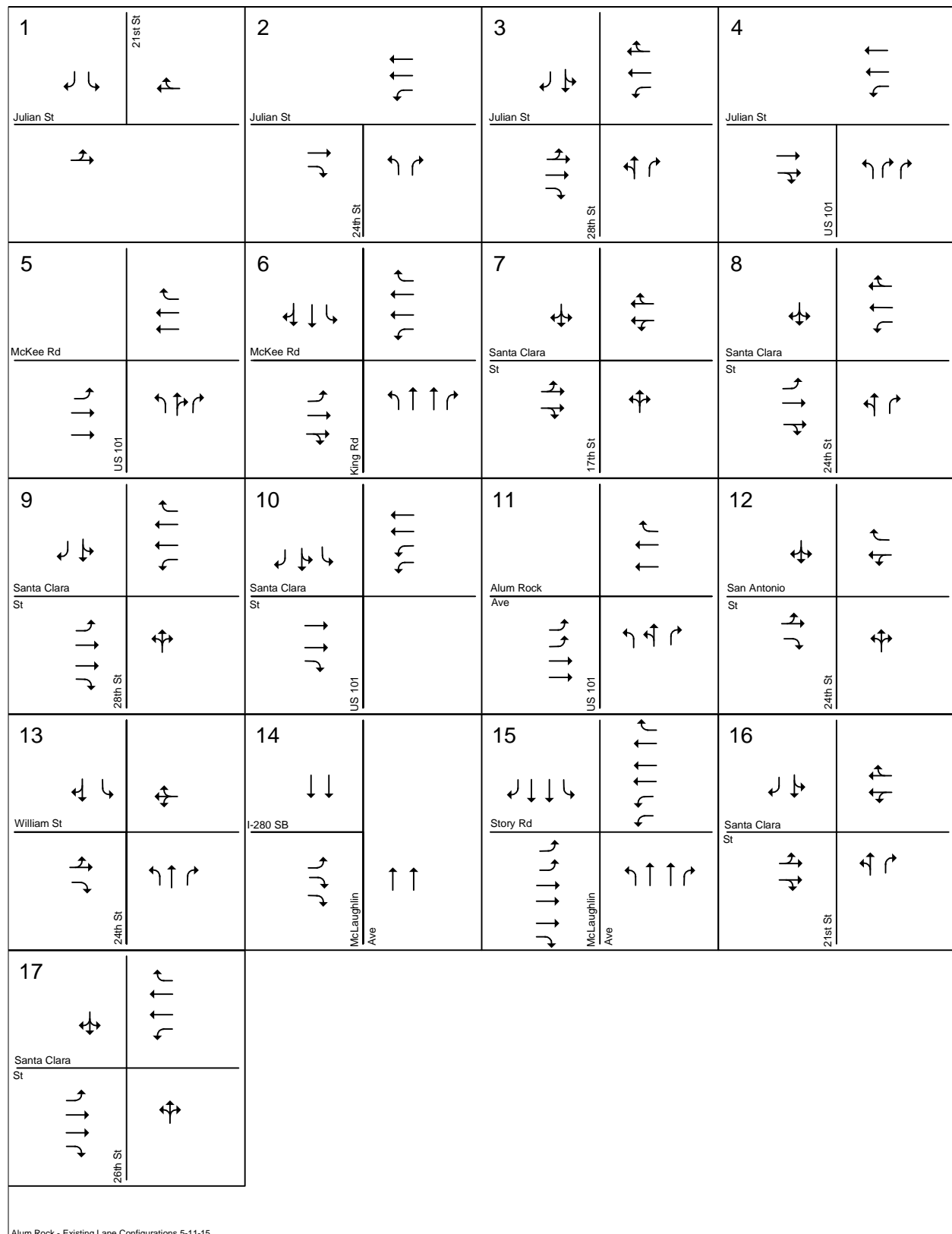

Alum Rock - Existing Lane Configurations 5-11-15

Figure 14
Existing Intersection Lane Configurations – Alum Rock/28th Street Station

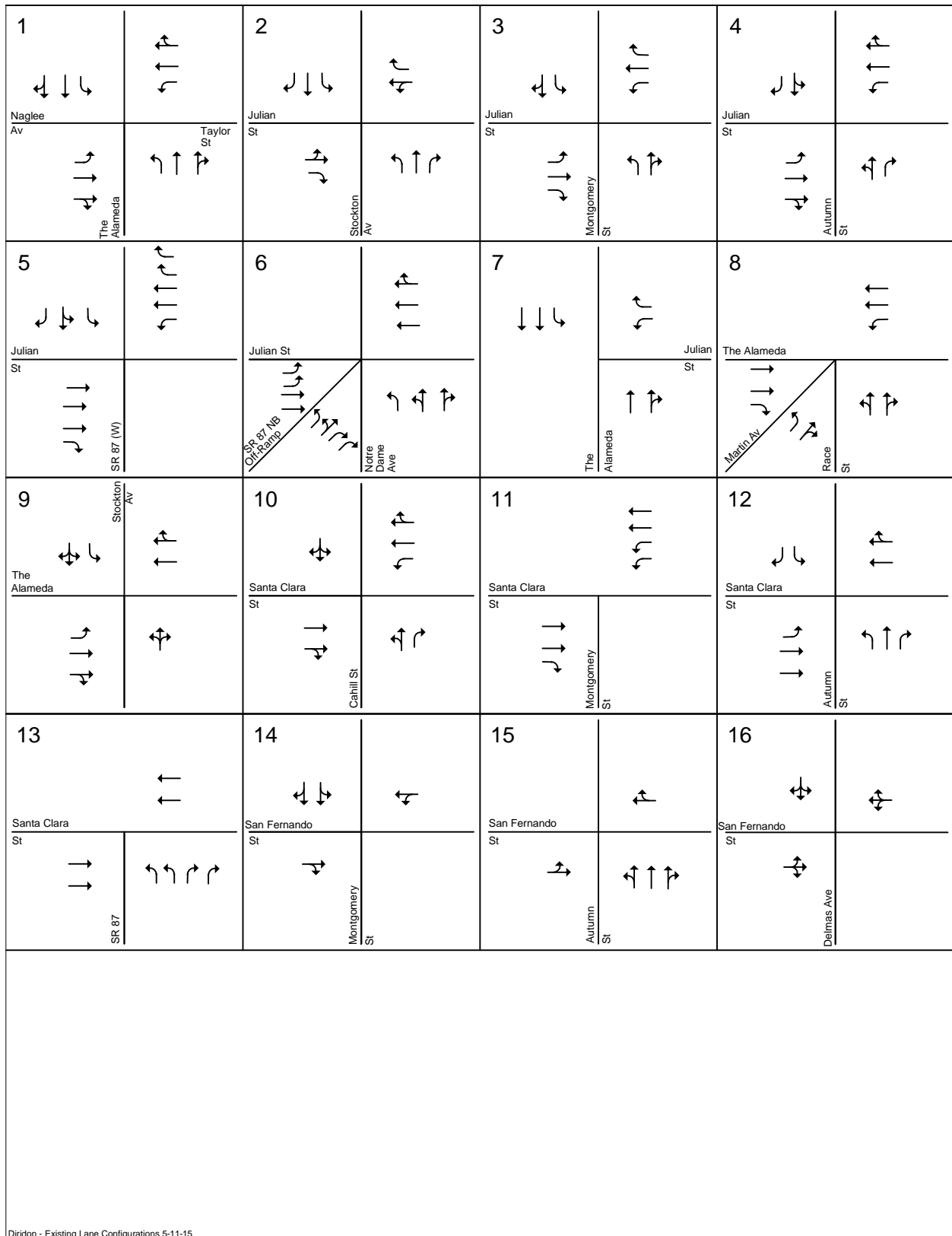

Diridon - Existing Lane Configurations 5-11-15

Figure 15
Existing Intersection Lane Configurations – Diridon Station

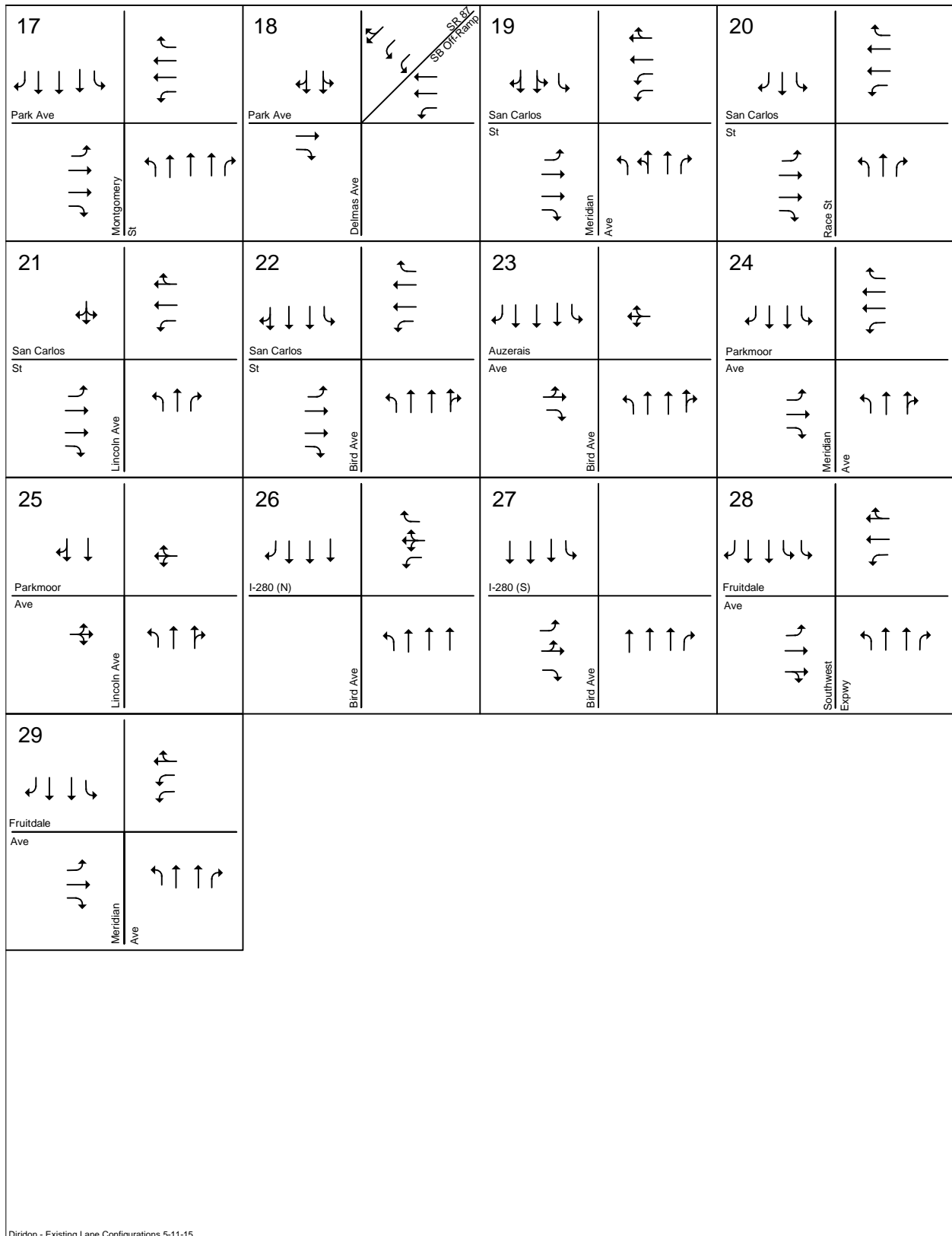

Diridon - Existing Lane Configurations 5-11-15

Figure 15 (Continued)
Existing Intersection Lane Configurations – Diridon Station

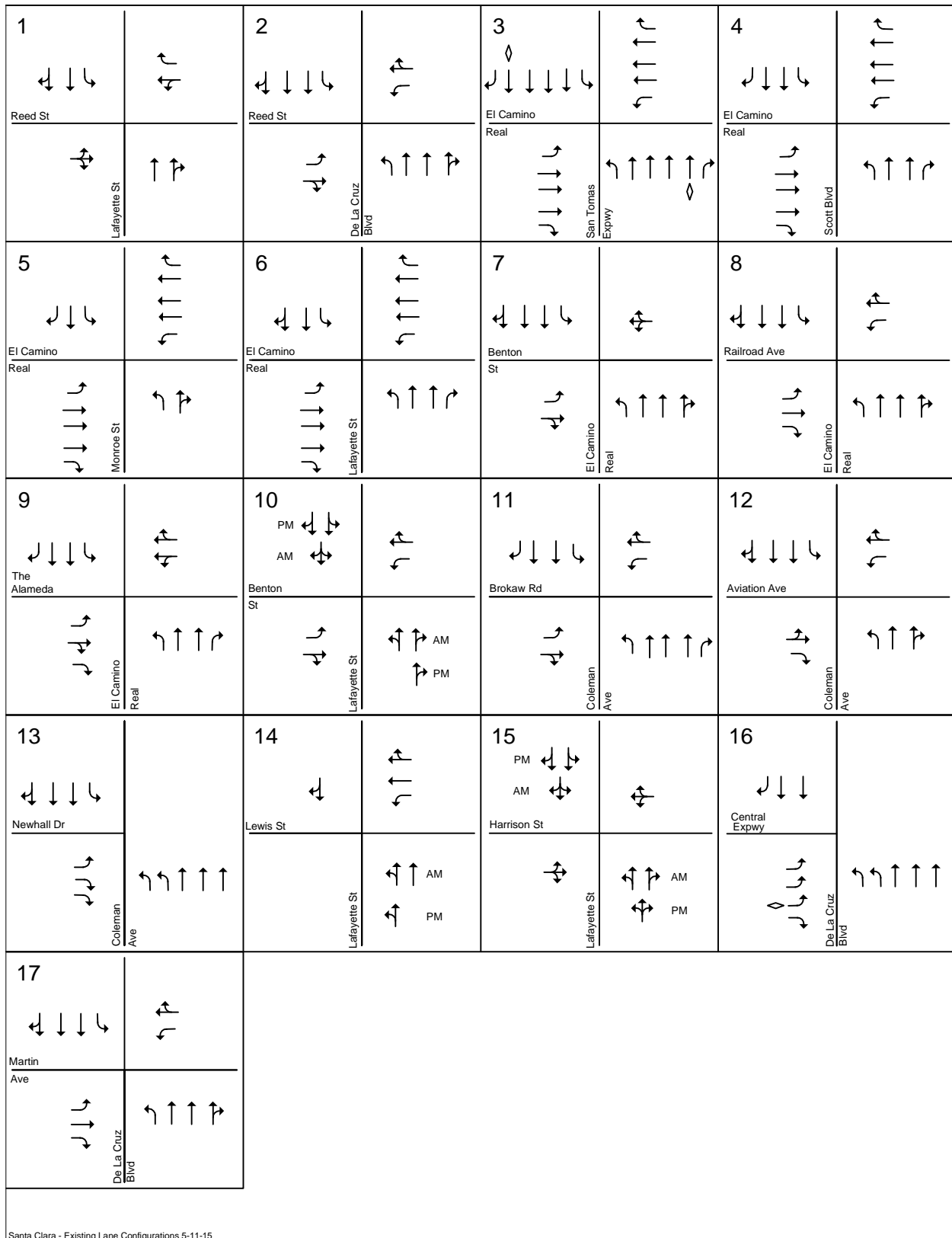

Santa Clara - Existing Lane Configurations 5-11-15

Figure 16
Existing Intersection Lane Configurations – Santa Clara Station

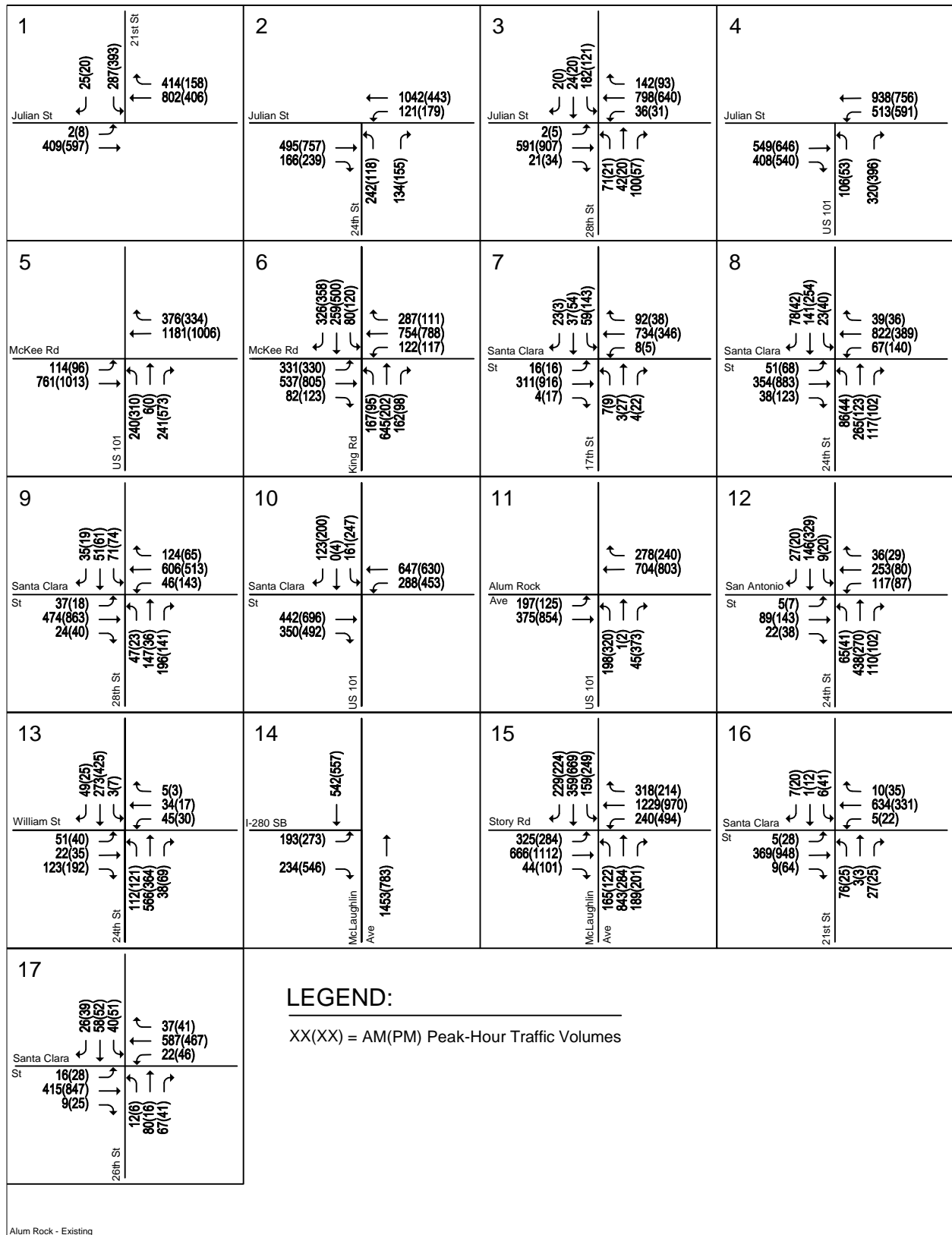
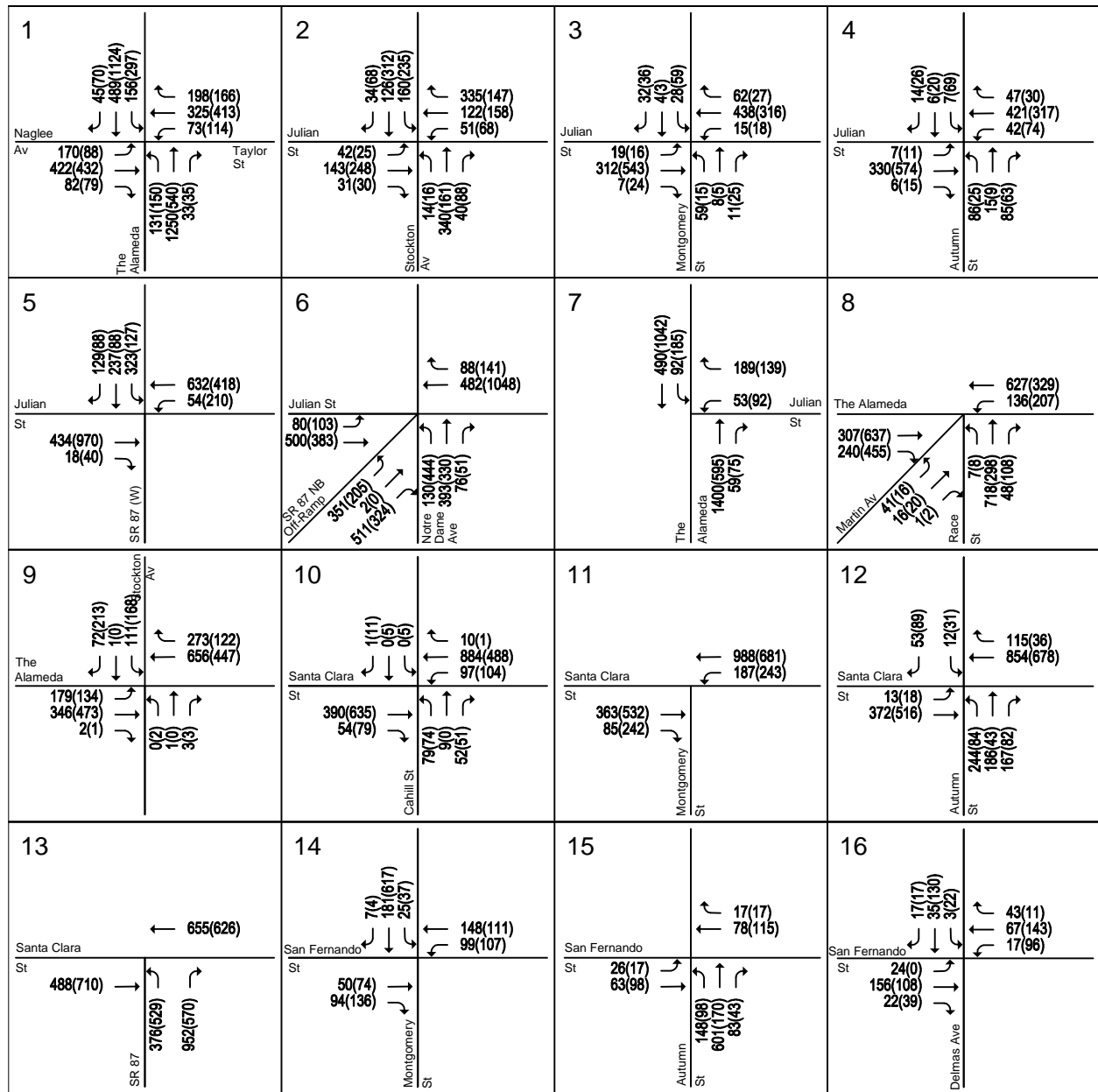

Figure 17
 Existing Traffic Volumes – Alum Rock/28th Street Station



LEGEND:

XX(XX) = AM(PM) Peak-Hour Traffic Volumes

Diridon - Existing

Figure 18
Existing Traffic Volumes – Diridon Station

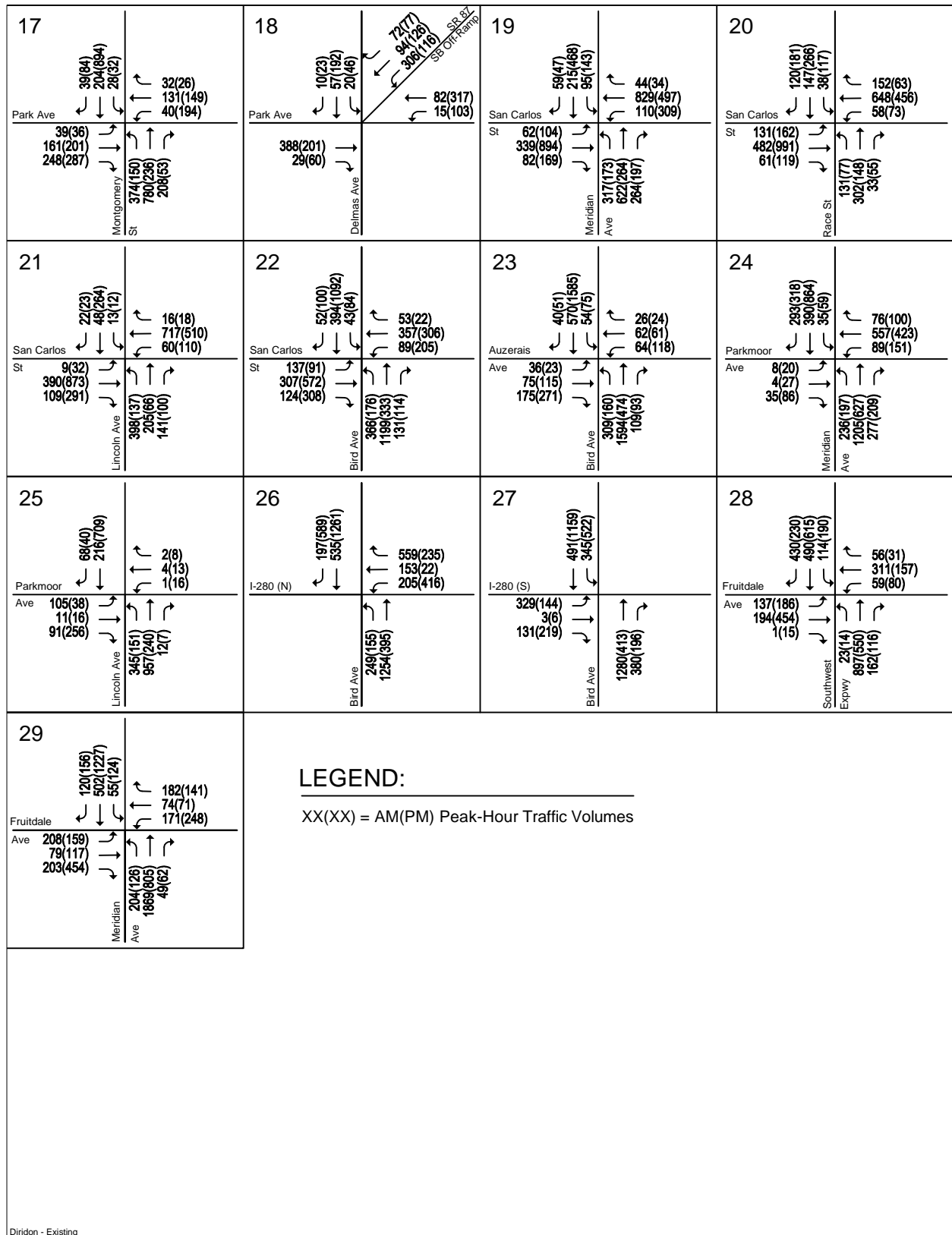

Figure 18 (Continued)
 Existing Traffic Volumes – Diridon Station

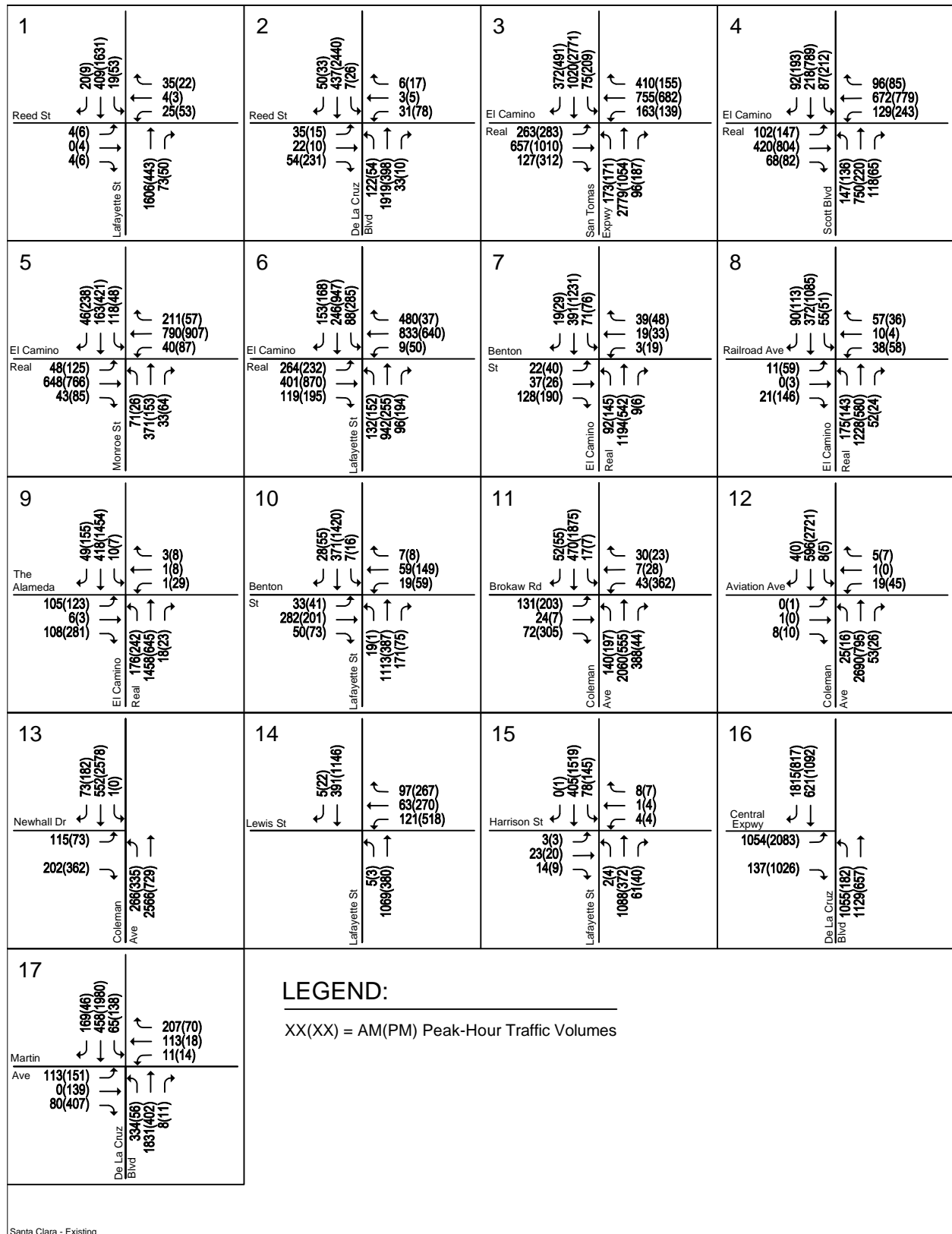

Figure 19
Existing Traffic Volumes – Santa Clara Station

Table 6
Existing Intersection Levels of Service – Alum Rock/28th Street Station

Study Number	Intersection	Peak Hour	Count Date	Avg. Delay	LOS
1	21st Street and East Julian Street	AM	10/09/14	20.9	C
		PM	10/09/14	12.2	B
2	24th Street and East Julian Street	AM	10/09/14	17.2	B
		PM	10/09/14	17.1	B
3	North 28th Street and East Julian Street	AM	04/09/15	27.2	C
		PM	04/09/15	14.2	B
4	US 101 and East Julian Street	AM	10/09/14	23.1	C
		PM	10/09/14	26.8	C
5	US 101 and McKee Road	AM	10/09/14	22.1	C
		PM	10/09/14	26.9	C
6	King Road and McKee Road	AM	10/09/14	46.8	D
		PM	10/08/14	47.2	D
7	17th Street and East Santa Clara Street	AM	10/09/14	6.5	A
		PM	10/09/14	9.3	A
8	24th Street and East Santa Clara Street	AM	11/05/13	19.5	B
		PM	11/05/13	21.1	C
9	North 28th Street and East Santa Clara Street	AM	10/09/14	20.9	C
		PM	10/09/14	18.4	B
10	US 101 and East Santa Clara Street*	AM	10/09/14	11.5	B
		PM	09/09/14	16.2	B
11	US 101 and Alum Rock Avenue*	AM	10/09/14	11.0	B
		PM	09/09/14	15.9	B
12	24th Street and San Antonio Street	AM	10/09/14	16.0	B
		PM	10/09/14	12.6	B
13	24th Street and East William Street	AM	10/09/14	15.8	B
		PM	10/09/14	19.4	B
14	McLaughlin Avenue and I-280 SB*	AM	10/09/14	9.5	A
		PM	09/24/14	14.5	B
15	McLaughlin Avenue and Story Road	AM	10/09/14	42.4	D
		PM	10/09/14	48.5	D
16	21st Street and East Santa Clara Street	AM	10/09/14	5.7	A
		PM	10/09/14	4.6	A
17	26th Street and East Santa Clara Street	AM	10/09/14	16.5	B
		PM	10/09/14	14.4	B

* Denotes CMP Intersection

**Table 7
Existing Intersection Levels of Service – Diridon Station**

Study Number	Intersection	Peak Hour	Count Date	Avg. Delay	LOS
1	The Alameda and Taylor Street/Naglee Avenue*	AM	10/07/14	45.6	D
		PM	09/30/14	43.4	D
2	Stockton Avenue and West Julian Street	AM	10/07/14	33.8	C
		PM	10/07/14	33.7	C
3	North Montgomery Street and West Julian Street	AM	10/07/14	11.8	B
		PM	10/07/14	11.8	B
4	North Autumn Street and West Julian Street	AM	10/07/14	13.2	B
		PM	10/07/14	13.1	B
5	SR 87 (W) and West Julian Street*	AM	10/07/14	20.8	C
		PM	09/23/14	18.8	B
6	SR 87 (E) and West Julian Street*	AM	10/07/14	53.8	D
		PM	09/23/14	42.3	D
7	The Alameda and West Julian Street	AM	10/07/14	19.0	B
		PM	10/07/14	20.2	C
8	Race Street/Martin Avenue and The Alameda*	AM	10/07/14	37.2	D
		PM	09/30/14	33.0	C
9	Stockton Avenue and The Alameda	AM	10/07/14	24.2	C
		PM	10/07/14	29.5	C
10	Cahill Street and West Santa Clara Street	AM	10/07/14	17.0	B
		PM	10/07/14	18.2	B
11	South Montgomery Street and West Santa Clara Street*	AM	10/07/14	6.2	A
		PM	09/17/14	9.0	A
12	South Autumn Street and West Santa Clara Street*	AM	10/07/14	25.7	C
		PM	09/16/14	21.2	C
13	SR 87 and West Santa Clara Street*	AM	10/07/14	17.9	B
		PM	09/23/14	17.1	B
14	South Montgomery Street and San Fernando Street	AM	10/07/14	9.1	A
		PM	10/07/14	10.4	B
15	South Autumn Street and San Fernando Street	AM	10/07/14	6.7	A
		PM	10/07/14	10.1	B
16	Delmas Avenue and San Fernando Street	AM	10/07/14	5.9	A
		PM	10/07/14	10.2	B
17	South Montgomery Street/Autumn Street and Park Avenue	AM	10/07/14	32.0	C
		PM	10/07/14	38.3	D
18	Delmas Avenue and Park Avenue	AM	10/07/14	23.5	C
		PM	10/07/14	25.1	C
19	Meridian Avenue and San Carlos Street	AM	10/07/14	38.2	D
		PM	10/07/14	47.5	D
20	Race Street and San Carlos Street	AM	10/07/14	36.2	D
		PM	10/07/14	36.7	D
21	Lincoln Avenue and San Carlos Street	AM	11/06/13	34.5	C
		PM	11/06/13	39.8	D
22	Bird Avenue and San Carlos Street*	AM	10/07/14	33.1	C
		PM	09/18/14	39.6	D
23	Bird Avenue and Auzerais Avenue	AM	10/07/14	22.1	C
		PM	10/07/14	26.8	C
24	Meridian Avenue and Parkmoor Avenue	AM	10/07/14	32.2	C
		PM	10/07/14	36.1	D
25	Lincoln Avenue and Parkmoor Avenue	AM	10/07/14	24.3	C
		PM	10/07/14	35.3	D
26	Bird Avenue and I-280 (N)*	AM	10/07/14	29.6	C
		PM	09/24/14	24.4	C
27	Bird Avenue and I-280 (S)*	AM	10/07/14	27.4	C
		PM	09/24/14	22.8	C
28	Southwest Expressway and Fruitdale Avenue	AM	10/07/14	28.7	C
		PM	10/07/14	32.1	C
29	Meridian Avenue and Fruitdale Avenue	AM	10/07/14	45.8	D
		PM	10/07/14	50.4	D

* Denotes CMP Intersection

**Table 8
Existing Intersection Levels of Service – Santa Clara Station**

Study Number	Intersection	Peak Hour	Count Date ¹	Avg. Delay ²	LOS
1	Lafayette Street and Reed Street	AM	2013	6.8	A
		PM	2013	7.4	A
2	De La Cruz Boulevard and Reed Street	AM	10/08/14	11.1	B
		PM	10/08/14	18.1	B
3	San Tomas Expressway and El Camino Real *	AM	10/08/14	66.1	E
		PM	09/23/14	79.7	E
4	Scott Boulevard and El Camino Real *	AM	10/08/14	33.8	C
		PM	09/17/14	37.7	D
5	Monroe Street and El Camino Real *	AM	10/08/14	35.5	D
		PM	09/17/14	32.9	C
6	Lafayette Street and El Camino Real *	AM	10/08/14	40.8	D
		PM	09/17/14	41.3	D
7	El Camino Real and Benton Street	AM	10/08/14	12.8	B
		PM	10/08/14	15.4	B
8	El Camino Real and Railroad Avenue	AM	10/08/14	10.5	B
		PM	10/08/14	12.4	B
9	El Camino Real and The Alameda *	AM	10/08/14	13.0	B
		PM	09/17/14	17.2	B
10	Lafayette Street and Benton Street	AM	10/08/14	17.1	B
		PM	10/08/14	15.7	B
11	Coleman Avenue and Brokaw Road	AM	10/08/14	17.0	B
		PM	10/08/14	88.0	F
12	Coleman Avenue and Aviation Avenue	AM	10/08/14	14.6	B
		PM	10/08/14	7.2	A
13	Coleman Avenue and Newhall Drive	AM	10/08/14	15.8	B
		PM	10/08/14	24.1	C
14	Lafayette Street and Lewis Street	AM	10/08/14	10.7	B
		PM	10/08/14	44.9	D
15	Lafayette Street and Harrison Street (unsignalized) ³	AM	10/08/14	48.9	E
		PM	10/08/14	176.9	F
16	De La Cruz Boulevard and Central Expressway *	AM	10/08/14	270.6	F
		PM	10/02/14	95.8	F
17	De La Cruz Boulevard and Martin Avenue	AM	10/08/14	34.9	C
		PM	10/08/14	30.7	C

* Denotes CMP Intersection

Entries denoted in **bold** indicate conditions that exceed the applicable level of service standard.

¹Count date of "2013" indicates that existing counts were factored to year 2013 conditions.

²The reported delay and corresponding level of service for signalized intersections represents the average delay for all approaches at the intersection. The reported delay and corresponding level of service for unsignalized (two-way stop-controlled) intersections are based on the stop-controlled approach with the highest delay.

³The City of Santa Clara does not have a level of service standard nor impact criteria for unsignalized intersections. The analysis of this intersection is presented for informational purposes only.

Level of service F at two-way stop-controlled (TWSC) intersections can occur when gaps of traffic on the major street are limited, resulting in long delays for the minor-street traffic as they attempt to enter or cross the major street. Thus, the overall performance at a TWSC intersection may be controlled by the minor street traffic, or critical movement traffic. At the study intersection of Lafayette Street and Harrison Street, the relatively high traffic volumes along Lafayette Street (major street) cause the delay on the low-volume Harrison Street (minor street) to be worse than the LOS E and F thresholds. However, the low traffic volumes on Harrison Street result in the peak hour traffic signal warrant not being met.

All other CMP and local City of Santa Clara study intersections currently operate at an acceptable level of service. The level of service calculation sheets for the Santa Clara Station are included in Appendix G.

Existing Freeway Segment Levels of Service

Traffic volumes on selected freeway segments were obtained from the CMP Monitoring and Conformance Report, 2014. This is the latest available report. The results of the analysis are summarized in Tables 9, 10, and 11 for each of the stations. The results show that:

- 13 (plus 4 HOV segments) of the 20 directional freeway segments analyzed for the Alum Rock/28th Street Station currently operate at an unacceptable LOS F during at least one peak hour.
- 16 (plus 5 HOV segments) of the 18 directional freeway segments analyzed for the Diridon Station currently operate at an unacceptable LOS F during at least one peak hour.
- 24 (plus 9 HOV segments) of the 26 directional freeway segments analyzed for the Santa Clara Station currently operate at an unacceptable LOS F during at least one peak hour.

Existing Freeway Ramp Analysis

Existing peak-hour ramp volumes were obtained from the turn-movement volumes at the adjacent ramp intersections.

Existing Freeway Ramp Configurations

The freeway ramps consist of three diagonal ramps and one loop-ramp. Each of the off-ramps are currently controlled by a traffic signal at their intersection with the local street. Meters at each of the on-ramps are not currently active,

The study freeway ramps are described below:

US 101 at McKee Road interchange – this interchange would provide access to and from the Alum Rock/28th Street Station. The following freeway ramps are projected to experience increases in traffic greater than 10 trips per lane during at least one of the peak hours analyzed:

- US 101/McKee Road Southbound On-Ramp – this on-ramp consists of two receiving lanes at its intersection with McKee Road and narrows to a single lane prior to reaching the ramp meter. The total queue storage capacity on the on-ramp is approximately 800 feet. Although a ramp meter is located on this ramp, the ramp meters is not currently active.
- US 101/McKee Road Southbound Loop Off-Ramp – at its diverging point from the freeway, this southbound off-ramp consists of a single lane that widens to two lanes as it loops around then widens to three lanes just prior to its intersection with McKee Road. The total queue storage capacity within this ramp is approximately 2,300 feet. This ramp is currently controlled by a traffic signal at its intersection with McKee Road.

Table 9
Existing Freeway Levels of Service – Alum Rock/28th Street Station

Freeway Segment	Direction	Peak Hour	Mixed-Flow Lane					HOV Lane				
			Avg. Speed	# of Lanes	Volume	Density	LOS	Avg. Speed	# of Lanes	Volume	Density	LOS
US 101 Tully to Story	NB	AM	25.0	3.0	5,400	72	F	15.0	1.0	1430	95	F
		PM	66.0	3.0	4,950	25	C	70.0	1.0	910	13	B
US 101 Story to I-280	NB	AM	22.0	3.0	5,220	79	F	19.0	1.0	1640	86	F
		PM	67.0	3.0	3,000	15	B	70.0	1.0	350	5	A
US 101 I-280 to Santa Clara	NB	AM	13.0	3.0	4,020	103	F	13.0	1.0	1330	102	F
		PM	66.0	3.0	4,560	23	C	70.0	1.0	700	10	A
US 101 Santa Clara to McKee	NB	AM	11.0	3.0	3,700	112	F	16.0	1.0	1480	92	F
		PM	66.0	3.0	3,960	20	C	70.0	1.0	1050	15	B
I-280 10th to McLaughlin	EB	AM	66.0	4.0	5,020	19	C	---	---	---	---	---
		PM	54.0	4.0	8,860	41	D	---	---	---	---	---
I-280 McLaughlin to US 101	EB	AM	66.0	4.0	5,810	22	C	---	---	---	---	---
		PM	54.0	4.0	8,860	41	D	---	---	---	---	---
I-680 US 101 to King	NB	AM	33.0	4.0	7,920	60	F	---	---	---	---	---
		PM	66.0	4.0	7,080	27	D	---	---	---	---	---
I-680 King to Capitol	NB	AM	20.0	4.0	6,560	82	F	---	---	---	---	---
		PM	47.0	4.0	8,650	46	D	---	---	---	---	---
I-680 Capitol to Alum Rock	NB	AM	18.0	4.0	6,270	87	F	---	---	---	---	---
		PM	65.0	4.0	7,800	30	D	---	---	---	---	---
I-680 Alum Rock to McKee	NB	AM	27.0	4.0	7,350	68	F	---	---	---	---	---
		PM	66.0	4.0	5,810	22	C	---	---	---	---	---
I-680 McKee to Alum Rock	SB	AM	63.0	4.0	8,570	34	D	---	---	---	---	---
		PM	47.0	4.0	8,650	46	D	---	---	---	---	---
I-680 Alum Rock to Capitol	SB	AM	23.0	4.0	7,090	77	F	---	---	---	---	---
		PM	65.0	4.0	7,540	29	D	---	---	---	---	---
I-680 Capitol to King	SB	AM	21.0	4.0	7,490	81	F	---	---	---	---	---
		PM	66.0	4.0	7,790	27	D	---	---	---	---	---
I-680 King to US 101	SB	AM	12.0	4.0	5,140	107	F	---	---	---	---	---
		PM	66.0	4.0	5,550	21	C	---	---	---	---	---
I-280 US 101 to McLaughlin	WB	AM	14.0	4.0	5,660	101	F	---	---	---	---	---
		PM	66.0	4.0	6,340	24	C	---	---	---	---	---
I-280 McLaughlin to 10th	WB	AM	19.0	4.0	6,390	84	F	---	---	---	---	---
		PM	65.0	4.0	7,540	29	D	---	---	---	---	---
US 101 McKee to Santa Clara	SB	AM	67.0	3.0	2,800	14	B	67.0	1.0	810	12	B
		PM	62.0	3.0	6,510	35	D	70.0	1.0	1400	20	C
US 101 Santa Clara to I-280	SB	AM	67.0	3.0	3,600	18	B	67.0	1.0	270	4	A
		PM	63.0	3.0	6,430	34	D	70.0	1.0	1960	28	D
US 101 I-280 to Story	SB	AM	67.0	3.0	3,200	16	B	67.0	1.0	470	7	A
		PM	54.0	3.0	6,650	41	D	70.0	1.0	1470	21	C
US 101 Story to Tully	SB	AM	66.0	3.0	3,960	20	C	67.0	1.0	470	7	A
		PM	45.0	3.0	6,480	48	E	70.0	1.0	1820	26	C

Source: Santa Clara Valley Transportation Authority Congestion Management Program Monitoring Study, 2014.
Bold indicates unacceptable LOS.

Table 10
Existing Freeway Levels of Service – Diridon Station

Freeway Segment	Direction	Peak Hour	Mixed-Flow Lane					HOV Lane				
			Avg. Speed	# of Lanes	Volume	Density	LOS	Avg. Speed	# of Lanes	Volume	Density	LOS
SR 87 Curtner to Almaden Expressway	NB	AM	13.0	2.0	2,660	102	F	22.0	1.0	1,720	78	F
		PM	65.0	2.0	3,900	30	D	70.0	1.0	1,190	17	B
SR 87 Almaden Expressway to Alma	NB	AM	29.0	2.0	3,770	65	F	43.0	1.0	2,110	49	E
		PM	41.0	2.0	4,190	51	E	70.0	1.0	1,540	22	C
SR 87 Alma to I-280	NB	AM	33.0	2.0	3,960	60	F	61.0	1.0	2,200	36	D
		PM	66.0	2.0	3,440	26	C	70.0	1.0	420	6	A
SR 87 I-280 to Julian	NB	AM	16.0	2.0	2,980	93	F	30.0	1.0	1,920	64	F
		PM	67.0	2.0	2,400	18	B	70.0	1.0	630	9	A
SR 87 Julian to Coleman	NB	AM	14.0	2.0	2,800	100	F	32.0	1.0	1,960	61	F
		PM	67.0	2.0	2,130	16	B	70.0	1.0	490	7	A
I-280 I-880 to Meridian	EB	AM	66.0	3.0	5,150	26	C	67.0	1.0	670	18	B
		PM	17.0	3.0	4,590	90	F	20.0	1.0	1,740	30	F
I-280 Meridian to Bird	EB	AM	61.0	4.0	8,790	36	D	---	---	---	---	---
		PM	21.0	4.0	6,810	81	F	---	---	---	---	---
I-280 Bird to SR 87	EB	AM	66.0	4.0	5,280	20	C	---	---	---	---	---
		PM	25.0	4.0	7,200	72	F	---	---	---	---	---
I-280 SR 87 to 10th	EB	AM	67.0	4.0	4,530	17	B	---	---	---	---	---
		PM	27.0	4.0	7,460	69	F	---	---	---	---	---
I-280 10th to SR 87	WB	AM	21.0	4.0	6,720	80	F	---	---	---	---	---
		PM	65.0	4.0	7,800	30	D	---	---	---	---	---
I-280 SR 87 to Bird	WB	AM	20.0	4.0	6,640	83	F	---	---	---	---	---
		PM	62.0	4.0	8,680	35	D	---	---	---	---	---
I-280 Bird to Meridian	WB	AM	18.0	4.0	6,410	89	F	---	---	---	---	---
		PM	58.0	4.0	8,820	38	D	---	---	---	---	---
I-280 Meridian to I-880	WB	AM	14.0	3.0	4,760	100	F	26.0	1.0	1,820	70	F
		PM	66.0	3.0	4,720	21	C	70.0	1.0	1,330	19	C
SR 87 Coleman to Julian	SB	AM	66.0	2.0	3,540	27	D	67.0	1.0	670	10	A
		PM	32.0	2.0	3,910	61	F	50.0	1.0	2,200	44	D
SR 87 Julian to I-280	SB	AM	67.0	2.0	1,870	14	B	67.0	1.0	410	6	A
		PM	36.0	2.0	4,040	56	E	70.0	1.0	2,030	29	D
SR 87 I-280 to Alma	SB	AM	67.0	2.0	1,870	14	B	67.0	1.0	210	3	A
		PM	15.0	2.0	3,900	95	F	60.0	1.0	1,190	41	D
SR 87 Alma to Almaden Expressway	SB	AM	66.0	2.0	2,910	22	C	67.0	1.0	610	9	A
		PM	27.0	2.0	3,040	69	F	60.0	1.0	840	38	D
SR 87 Almaden Expressway to Curtner	SB	AM	66.0	2.0	2,640	20	C	67.0	1.0	410	6	A
		PM	36.0	2.0	4,040	56	E	70.0	1.0	1,960	28	D

Source: Santa Clara Valley Transportation Authority Congestion Management Program Monitoring Study, 2014.
Bold indicates unacceptable LOS.

**Table 11
Existing Freeway Levels of Service – Santa Clara Station**

Freeway Segment	Direction	Peak Hour	Mixed-Flow Lane						HOV Lane					
			Avg. Speed	# of Lanes	Volume	Density	LOS	Avg. Speed	# of Lanes	Volume	Density	LOS		
US 101 I-880 to Old Bayshore	NB	AM	14.0	3.0	4,200	100	F	19.0	1.0	1,600	84	F		
		PM	67.0	3.0	3,600	18	B	70.0	1.0	420	6	A		
US 101 Old Bayshore to First	NB	AM	12.0	3.0	3,930	109	F	13.0	1.0	1,360	104	F		
		PM	66.0	3.0	3,960	20	C	70.0	1.0	560	8	A		
US 101 First to SR 87	NB	AM	19.0	3.0	4,850	85	F	19.0	1.0	1,600	84	F		
		PM	67.0	3.0	3,400	17	B	70.0	1.0	630	9	A		
US 101 SR 87 to De La Cruz	NB	AM	12.0	3.0	3,860	107	F	14.0	1.0	1,400	100	F		
		PM	66.0	3.0	4,160	21	C	70.0	1.0	420	6	A		
US 101 De La Cruz to Montague	NB	AM	26.0	3.0	5,460	70	F	39.0	1.0	2,070	53	E		
		PM	65.0	3.0	6,050	31	D	70.0	1.0	980	14	B		
US 101 Montague to Great America	NB	AM	21.0	3.0	5,110	81	F	41.0	1.0	2,100	51	E		
		PM	58.0	3.0	6,620	38	D	70.0	1.0	1,820	26	C		
I-880 I-280 to Stevens Creek	NB	AM	15.0	3.0	4,370	97	F	---	---	---	---	---		
		PM	66.0	3.0	4,160	21	C	---	---	---	---	---		
I-880 Stevens Creek to Bascom	NB	AM	20.0	3.0	4,920	82	F	---	---	---	---	---		
		PM	16.0	3.0	4,420	92	F	---	---	---	---	---		
I-880 Bascom to The Alameda	NB	AM	27.0	3.0	5,590	69	F	---	---	---	---	---		
		PM	13.0	3.0	4,060	104	F	---	---	---	---	---		
I-880 The Alameda to Coleman	NB	AM	31.0	3.0	5,860	63	F	---	---	---	---	---		
		PM	15.0	3.0	4,320	96	F	---	---	---	---	---		
I-880 Coleman to SR 87	NB	AM	22.0	3.0	5,150	78	F	---	---	---	---	---		
		PM	24.0	3.0	5,330	74	F	---	---	---	---	---		
I-880 SR 87 to First	NB	AM	48.0	3.0	6,480	45	D	---	---	---	---	---		
		PM	22.0	3.0	5,220	79	F	---	---	---	---	---		
I-880 First to US 101	NB	AM	36.0	3.0	6,160	57	E	---	---	---	---	---		
		PM	51.0	3.0	6,580	43	D	---	---	---	---	---		
I-880 US 101 to First	SB	AM	16.0	3.0	4,470	93	F	---	---	---	---	---		
		PM	14.0	3.0	4,250	101	F	---	---	---	---	---		
I-880 First to SR 87	SB	AM	25.0	3.0	5,480	73	F	---	---	---	---	---		
		PM	14.0	3.0	4,160	99	F	---	---	---	---	---		
I-880 SR 87 to Coleman	SB	AM	65.0	3.0	5,850	30	D	---	---	---	---	---		
		PM	23.0	3.0	5,250	76	F	---	---	---	---	---		
I-880 Coleman to The Alameda	SB	AM	66.0	3.0	5,310	27	D	---	---	---	---	---		
		PM	23.0	3.0	5,250	76	F	---	---	---	---	---		
I-880 The Alameda to Bascom	SB	AM	66.0	3.0	4,950	25	C	---	---	---	---	---		
		PM	25.0	3.0	5,480	73	F	---	---	---	---	---		
I-880 Bascom to Stevens Creek	SB	AM	50.0	3.0	6,600	44	D	---	---	---	---	---		
		PM	30.0	3.0	5,760	64	F	---	---	---	---	---		
I-880 Stevens Creek to I-280	SB	AM	66.0	3.0	3,960	20	C	---	---	---	---	---		
		PM	65.0	3.0	5,850	30	D	---	---	---	---	---		
US 101 Great America to Montague	SB	AM	66.0	3.0	4,950	25	C	67.0	1.0	1,080	16	B		
		PM	14.0	3.0	4,160	99	F	20.0	1.0	1,820	91	F		
US 101 Montague to De La Cruz	SB	AM	66.0	3.0	5,310	27	D	67.0	1.0	940	14	B		
		PM	13.0	3.0	4,060	104	F	40.0	1.0	2,520	63	F		
US 101 De La Cruz to SR 87	SB	AM	62.0	3.0	6,510	35	D	67.0	1.0	610	9	A		
		PM	18.0	3.0	4,700	87	F	50.0	1.0	2,400	48	E		
US 101 SR 87 to First	SB	AM	67.0	3.0	2,600	13	B	67.0	1.0	410	6	A		
		PM	16.0	3.0	4,520	94	F	30.0	1.0	2,340	78	F		
US 101 First to Old Bayshore	SB	AM	67.0	3.0	3,400	17	B	67.0	1.0	410	6	A		
		PM	6.0	3.0	2,650	147	F	20.0	1.0	1,820	91	F		
US 101 Old Bayshore to I-880	SB	AM	67.0	3.0	2,400	12	B	67.0	1.0	540	8	A		
		PM	8.0	3.0	3,030	126	F	30.0	1.0	2,160	72	F		

Source: Santa Clara Valley Transportation Authority Congestion Management Program Monitoring Study, 2014.
Bold indicates unacceptable LOS.

US 101 at Santa Clara Street/Alum Rock Avenue interchange – this interchange would provide access to and from the Alum Rock/28th Street Station. The following freeway ramps are projected to experience increases in traffic greater than 10 trips per lane during at least one of the peak hours analyzed:

- US 101/Santa Clara Street Southbound On-Ramp (SB on-ramp) – this on-ramp consists of two lanes from its intersection with Santa Clara Street to the ramp meter. The total queue storage capacity within this ramp is approximately 850 feet. Although a ramp meter is currently found at the freeway merging point on this ramp, the ramp meter is not currently active.
- US 101/Alum Rock Avenue Northbound Off-Ramp (NB off-ramp) – at its diverging point from the freeway, this northbound off-ramp consists of a single lane and flares into three lanes at the northbound approach to its intersection with Alum Rock Avenue. The total queue storage capacity on this ramp is approximately 1,675 feet. This ramp is currently controlled by a traffic signal at its intersection with Alum Rock Avenue.

Estimated queue lengths at the freeway off-ramp intersections were obtained from TRAFFIX calculations. Ramp meters on each of the freeway on-ramps are not currently active. Thus, the freeway on-ramps evaluated do not currently experience measurable queues.

Table 12 shows the existing ramp volumes and estimated queue lengths. All freeway ramps studied currently have adequate queue storage capacity to accommodate the existing vehicle queue lengths.

**Table 12
Existing Freeway Ramp Queuing Analysis**

Freeway Ramp	Total Storage (Vehicle) ¹	Volume and Queue Projections (Vehicles)	
		Existing	
US 101 SB On-Ramp at McKee Road	32		
PM Volume ²		1131	
Projected Queue Length ³		--	
US 101 SB Loop Off-Ramp at McKee Road	92		
AM Volume ²		426	
Projected Queue Length ⁴		27	
US 101 SB On-Ramp at Santa Clara Street	34		
PM Volume ²		949	
Projected Queue Length ³		--	
US 101 NB Off-Ramp at Alum Rock Avenue	67		
AM Volume ²		244	
Projected Queue Length ⁴		10	
PM Volume ²		695	
Projected Queue Length ⁴		24	
Notes:			
¹ Total number of vehicles that can store within the ramp.			
² Peak-hour ramp volume projections.			
³ Currently, the ramp meter at these on-ramps is not operational during the PM peak hour, therefore, no measurable queues are currently experienced at these locations.			
⁴ Total number of vehicles in the queue, as obtained from TRAFFIX.			

3.

Year 2025 No Project/Phase I Conditions

This chapter describes traffic conditions in the year 2025 (opening day of the project) without the Phase II Project. This scenario assumes that the Phase I Project (Milpitas and Berryessa BART Stations only) would be completed. Included are descriptions of the year 2025 land uses, roadway network, and transit service. The analysis includes intersection and freeway segment level of service analysis for the Year 2025 No Project/Phase I conditions.

2025 Land Use

The future land use assumptions used for the 2025 No Project/Phase I conditions are based on projections compiled by the Association of Bay Area Governments (ABAG), Association of Monterey Bay Area Governments (AMBAG), and San Joaquin Council of Governments (SJCOG). The ABAG demographic assumption bases the travel forecasts on socio-economic/land use forecast series *Projections 2013*. The future land use assumptions include all near-term approved projects. The number of households and jobs projected for the year 2025 are presented in Table 13. As shown in the table, households and jobs in the region are expected to increase by 10 percent and 11 percent, respectively.

2025 Roadway Network

Several transportation improvements in the Phase II Project study area are planned and would be operational by 2025. These improvements are identified in the MTC Bay Area's Regional Transportation Plan (RTP), *Transportation 2035 Plan for the San Francisco Bay Area* (Transportation 2035 Plan), adopted by MTC in April 2009, and the *Valley Transportation Plan 2040* (VTP 2040), adopted by VTA in October 2013. The improvements consist of freeway widenings and interchange improvements as well as improvements to regional and local facilities. There are no new freeways planned.

Information on local intersection improvements also were obtained from both the Cities of San Jose and Santa Clara. These include funded improvements at intersections that will be in place by the year 2025. The planned roadway improvements in the vicinity of the Phase II Project are identified in Table 14.

In addition, VTA staff provided information on the Santa Clara-Alum Rock Bus Rapid Transit (BRT) Project. The Santa Clara-Alum Rock BRT Project would provide BRT service along Santa Clara Street and Alum Rock Avenue, extending from Cahill Street (western Santa Clara Street end) to Capitol Avenue. This project will result in roadway and traffic signal modifications along Santa Clara Street/Alum Rock Avenue, including at some of the study intersections. However, the lane configurations at the study intersections along Santa Clara Street/Alum Rock Avenue will remain unchanged. Traffic signal modifications will occur at the following study intersection:

Table 13
2025 Projected Number of Households and Employment by County

County	2015		2025		Growth 2015 to 2025	
	Households	Employment	Households	Employment	Households	Employment
San Francisco	362,400	617,400	396,300	675,200	9%	9%
San Mateo	267,200	378,700	286,300	409,800	7%	8%
Santa Clara	640,400	1,006,600	711,200	1,107,000	11%	10%
Alameda	571,400	757,000	624,800	833,900	9%	10%
Contra Costa	387,900	374,500	418,000	412,100	8%	10%
Solano	146,100	143,100	155,200	157,800	6%	10%
Napa	50,100	75,700	52,600	81,300	5%	7%
Sonoma	191,500	208,200	203,200	228,000	6%	10%
Marin	104,700	115,100	107,600	120,700	3%	5%
Santa Cruz	97,600	139,600	108,300	165,400	11%	18%
Monterey	136,000	214,500	159,600	275,300	17%	28%
San Benito	18,000	20,200	22,200	26,500	23%	31%
San Joaquin	239,000	227,800	277,700	247,600	16%	9%
Region	3,212,300	4,278,400	3,523,000	4,740,600	10%	11%

Source: ABAG Projections 2013.

(7) 17th Street and Santa Clara Street (Alum Rock/28th Street Station) – with the Santa Clara-Alum Rock BRT Project, the traffic signal phasing for the eastbound/westbound direction will change from permitted left-turn to split phase.

The Alameda-El Camino Real BRT Project would extend along El Camino Real in the City of Santa Clara. According to VTA staff, this BRT project is currently in the planning phase.

2025 Bicycle and Pedestrian Facilities

The Santa Clara Countywide Bicycle Plan, adopted by VTA in August 2008, identifies various existing and/or planned cross county bicycle corridors in the vicinity of the proposed BART Stations. The bicycle plan also identifies planned/potential projects that would enhance existing pedestrian and bicycle facilities and improve connectivity between facilities.

In addition, the VTP 2040 document identifies various funded bicycle projects, some which are located within the study station areas. These projects are listed on Table 15.

Table 14
2025 Transportation Network Improvements

Improvement	Implementation Period 2025
1 Converting all existing freeway HOV lanes to express lanes.	*
2 I-880 between SR 237 and US 101 – add express lanes.	*
3 Widen Coleman Avenue from 4-lanes to 6-lanes between I-880 and Taylor Street.	*
4 Conversion of one-way couplets to two-way streets along 10th and 11th Streets, Almaden Avenue and Vine Street, and 2nd and 3rd Streets.	*
5 Widen Central Expressway from 4-lanes to 6-lanes between Lawrence and San Tomas Expressway.	*
6 Conversion HOV lanes on Central Expressway to mixed-flow lanes between De La Cruz Boulevard and San Tomas Expressway.	*
7 Widen San Tomas Expressway to 8 lanes between Williams to El Camino Real.	*
8 Replace and widen San Carlos Street bridge at Caltrain/Vasona LRT.	*
9 Realignment of Julian Street between SR 87 and North 1 st Street to extend the downtown urban grid system.	*
10 Conversion of St. James Street from one-way to two-way street from Notre Dame/SR 87 to Market Street (part of the Julian Realignment project).	*
11 Complete the Autumn Street realignment and extension between St. John Street and Coleman Avenue.	*
12 Convert Autumn Street between Santa Clara Street and Park Avenue from a one-way (northbound) street to a two-way street. Autumn Street will become a 4-lane street.	*
13 Convert Montgomery Street between Santa Clara Street and San Fernando Street from a one-way (southbound) street to a two-way street. Montgomery Street will remain a two-lane street.	*
14 Create cul-de-sac at southerly end of Montgomery Street , just north of Park Avenue.	*
Other Local Intersection Improvements	
19 King Road and McKee Road (SJ) - addition of second eastbound left-turn lane.	*
20 SR 87 (E) and Julian Street (SJ) - conversion of the existing northbound shared right-through lane to separate through and right-turn lanes; conversion of the existing westbound shared right-through lane to a dedicated right-turn lane.	*
21 Montgomery Street and Santa Clara Street (SJ) - addition of a left-turn and right turn lane on the northbound approach; elimination of one of the existing westbound left-turn lanes.	*
22 Autumn Street and Santa Clara Street (SJ) - addition of a southbound through lane and conversion of the existing southbound right turn lane to shared right-through lane; addition of a eastbound right-turn lane; and addition of two westbound left-turn lanes and a separate westbound right-turn lane.	*
23 Montgomery Street and San Fernando Street (SJ) - addition of an all-movement lane on the northbound approach and conversion of all intersection approaches to single all-movement lanes.	*
24 Autumn Street and San Fernando Street (SJ) - conversion of the existing northbound shared left-through lane to a dedicated left-turn lane; addition of one left-turn, one through, and one shared right-through lane on the southbound approach; and conversion of the existing westbound through lane to a shared left-through lane.	*
25 Montgomery Street and Park Avenue (SJ) - this intersection will become Autumn/Park.	*
26 Autumn Street and Park Avenue (SJ) - intersection lane configuration will include one left, one through, and one shared right-through lane on the northbound approach; one left, one through, and one shared right-through lane on the southbound approach; one left and one shared right-through lane on the eastbound approach; and two left-turn and one shared right-through lane on the westbound approach.	*
27 Bird Avenue and San Carlos Street (SJ) - addition of a second left-turn lane and conversion of the shared right-through lane to exclusive right-turn lane (reducing the number of through lanes by one) on the northbound approach; and elimination of one southbound through lane.	*
28 Autumn Street and Julian Street (SJ) - reconfiguration of the northbound and southbound approaches to include one left-turn, one through, and one shared right-through lane.	*
29 Lafayette Street and El Camino Real (SC) - addition of second left-turn lanes on both the southbound and eastbound approaches.	*
30 Coleman Avenue and Brokaw Road (SC) - Widening of Coleman Avenue to accommodate a third southbound through lane.	*
31 San Tomas Expressway and El Camino Real (SC) - addition of second left-turn lanes on both the eastbound and westbound approaches.	*

Source: VTA staff, Cities of San Jose and Santa Clara staff, 2008 County's Expressway Plan, and VTP 2040 (VTA 2013). (SJ) = San Jose, (SC) = Santa Clara

Table 15
2025 Bicycle/Pedestrian Facility Improvements

VTP ID	Project Title	Description
B12	Airport Boulevard: Guadalupe River Trail Bike and Pedestrian Connection	Construct a multi-use path along the north side of Airport Blvd. (at south end of Mineta San Jose International Airport) from the Guadalupe River Trail to Coleman Ave. connecting with existing Coleman Ave. bike lanes and future Santa Clara BART Station (via Brokaw Rd.). Construct a crosswalk on Airport Blvd., south of Skyport Dr. to Airport Blvd. at Coleman.
B13	Auzerais Avenue Bicycle and Pedestrian Improvements: Sunol Street to Race Street	Construct Class II bikeways, sidewalk improvements, crossing improvements, and bicycle parking.
B14	Bird Avenue Bicycle and Pedestrian Corridor: Montgomery Street at Santa Clara to Bird Avenue at West Virginia	Construct Class II and III bikeways, enhanced crossing/detection, and sidewalk improvements.
B18	Brokaw-Coleman Airport Bikeway: Airport Blvd. and the Guadalupe Trail to Airport Blvd. and Coleman Ave.	Construct Class II bikeways, bicycle crossing improvements, and Class I multi-use path.
B27	Los Gatos Creek Trail Reach 5d: Park Ave./Montgomery Ave. to Santa Clara Ave. (Diridon Station Segment)	Completion of the last reach of the Los Gatos Creek Trail, including design, land acquisition and environmental review.
B28	Los Gatos Creek Trail Reach 5b and 5c: Auzerais Ave. South of W. San Carlos Ave. to Park Ave./Montgomery Ave. (Trail and Undercrossing)	Completion of the last reach of the Los Gatos Creek Trail including design, land acquisition and environmental review.
B32	Park Ave./San Fernando St./San Antonio Bikeway	Provide enhanced on-street crosstown bikeway (bike lanes, sharrows, signs) between San Jose/Santa Clara city limits with Diridon Transit Center, Downtown San Jose, San Jose Creek Trails (Los Gatos, Guadalupe, Coyote), SJSU and east San Jose.
B33	Three Creeks Trail: West from Los Gatos Creek Trail/Lonus St. to Guadalupe River	Construct landscaped trail system, with paved alignment along a former railway right-of-way. Signage, striping, mileage markers, seating, fitness stations, and decorative gateway elements at all at-grade roadway crossings.
B37	Lafayette St. Bike Lanes: Agnew Rd. to Reed St.	Install Class II bicycle lanes with bicycle detection at signalized intersections.
B41	San Tomas Aquino Creek Spur Trail Phase 2: El Camino Real to Homestead Rd.	Construct an extension of the San Tomas Aquino Spur Trail on the west side of San Tomas Expwy. from El Camino Real to Homestead Rd. The trail will be separated from the expressway by a concrete safety barrier and lined with a community wall to provide a security barrier for the adjacent residential properties.
B69	Santa Clara Caltrain Station Undercrossing Extension	Construct an extension of the recently opened pedestrian/bike tunnel under the Caltrain tracks at the Santa Clara Caltrain/Altamont Commuter Express (ACE) station on the east side of the Union Pacific Railroad tracks. Construct ramp and pathway to connect tunnel to Brokaw road.

Source: VTP 2040 Project List.

2025 Transit Service

Transit improvements for the year 2025 primarily consist of enhancement of regional bus lines and commuter trains that also serve San Jose and Santa Clara. Some of these improvements include bus rapid transit (BRT) projects, Light Rail Transit (LRT) extensions and service improvements, and rail service upgrades. Table 16 presents the numerous new transit services and capital projects that would affect travel in the study area.

**Table 16
2025 Transit Improvements (Santa Clara County)**

No.	Transit Projects	Implementation Period 2025	Notes
1	BART Extension from Fremont to Berryessa	*	Project connects the existing BART system from the Warm Springs Station in Southern Fremont through Milpitas to the Berryessa District of San Jose.
2	Bus Rapid Transit (BRT) Line 523 – Stevens Creek Boulevard (previously Line 23)	*	Downtown San Jose to Cupertino, offering 10-minute service each direction
3	El Camino BRT Line 522 (previously Lines 22/Line 300)	*	Limited stop service at 10-minute intervals; target is minimum 15 percent travel time reduction on El Camino Real from Downtown San Jose to Palo Alto (Line 22).
4	Santa Clara/Alum Rock (SCAR) BRT	*	Project constructs enhancements in the County's highest ridership corridor, including two miles of dedicated lanes.
5	Capitol Corridor Commuter and Intercity Rail	*	11 round trips/day between Sacramento and San Jose; new Oakland Coliseum and Union City intermodal stations in service.
6	LRT – Guadalupe Express Service	*	A Guadalupe Express service between Ohlone/Chynoweth and San Jose Convention Center, with local service provided by a through-routed Almaden line.
7	LRT – Additional Line – Long T	*	Operate an additional line (the “Long T”) that would travel from Downtown Mountain View to Alum Rock during peak periods, with express service from Downtown Mountain View to Old Ironsides and an intermediate stop at Lockheed Martin. The off-peak service would operate from Old Ironsides to Alum Rock.
8	LRT – Expanded Service between Campbell and Downtown San Jose	*	An independent Vasona (Mountain View – Winchester) branch, operating between Campbell and Downtown San Jose, allowing three-car trains originating from the Almaden line to serve North First Street corridor and Mountain View.
9	Implementation of Caltrain Modernization/Electrification Projects	*	Improve train performance and increase service, shorter headways and increased travel speeds, reduce noise and air pollution.
10	Caltrain/HSR Station Improvements: Diridon Station	*	Provide station improvements needed to accommodate and support the high-speed rail service.

Source: *Transportation 2035 Plan for the San Francisco Bay Area (MTC, 2009), VTP 2040 (VTA 2013).*

Year 2025 No Project/Phase I Conditions Intersection Lane Configurations

The study intersection lane configurations under the Year 2025 No Project/Phase I conditions were assumed to be the same as under existing conditions, with the exception of the previously described roadway and intersection improvements. Figures 20, 21, and 22 show the intersection lane configurations under Year 2025 No Project/Phase I conditions for each of the stations analyzed.

Year 2025 No Project/Phase I Conditions Traffic Volumes

Peak-hour traffic volumes for the year 2025 were produced with the VTA Model using the method described earlier in this report. The 2025 traffic volumes include traffic associated with future development included in the ABAG projections and the projected future transportation network, as described above. Traffic volumes for Year 2025 No Project/Phase I conditions are presented in Figures 23, 24, 25 and included in Appendix D.

Year 2025 No Project/Phase I Conditions Intersection Levels of Service

Intersection level of service was used to evaluate traffic operations at the study intersections under Year 2025 No Project/Phase I conditions. Adjusted 2025 model volume forecasts were used to calculate intersection levels of service. The intersection level of service results for the Year 2025 No Project/Phase I conditions are described below.

Alum Rock/28th Street Station

The results of the level of service analysis under Year 2025 No Project/Phase I conditions for the Alum Rock/28th Street Station are summarized in Table 17. The results show that the following two study intersections are projected to operate at unacceptable levels of service during at least one peak hour, according to City of San Jose level of service standards (see Figure 26).

- (4) US 101 and East Julian Street (LOS E – PM peak hour)
- (6) King Road and McKee Road (LOS E – AM and PM peak hours)

All other CMP and local San Jose study intersections are projected to operate at an acceptable level of service. The level of service calculation sheets for the Alum Rock/28th Street Station are included in Appendix E.

Diridon Station

The results of the level of service analysis under Year 2025 No Project/Phase I conditions for the Diridon Station are summarized in Table 18. The results show that the following study intersection is projected to operate at unacceptable levels of service during one or both peak hours, according to City of San Jose level of service standards (see Figure 27).

- (1) The Alameda and Taylor Street/Naglee Avenue* (LOS E – AM peak hour)
- (29) Meridian Avenue and Fruitdale Avenue (LOS E – AM and PM peak hours)

All other CMP and local San Jose study intersections are projected to operate at an acceptable level of service. The level of service calculation sheets for the Diridon Station are included in Appendix F.

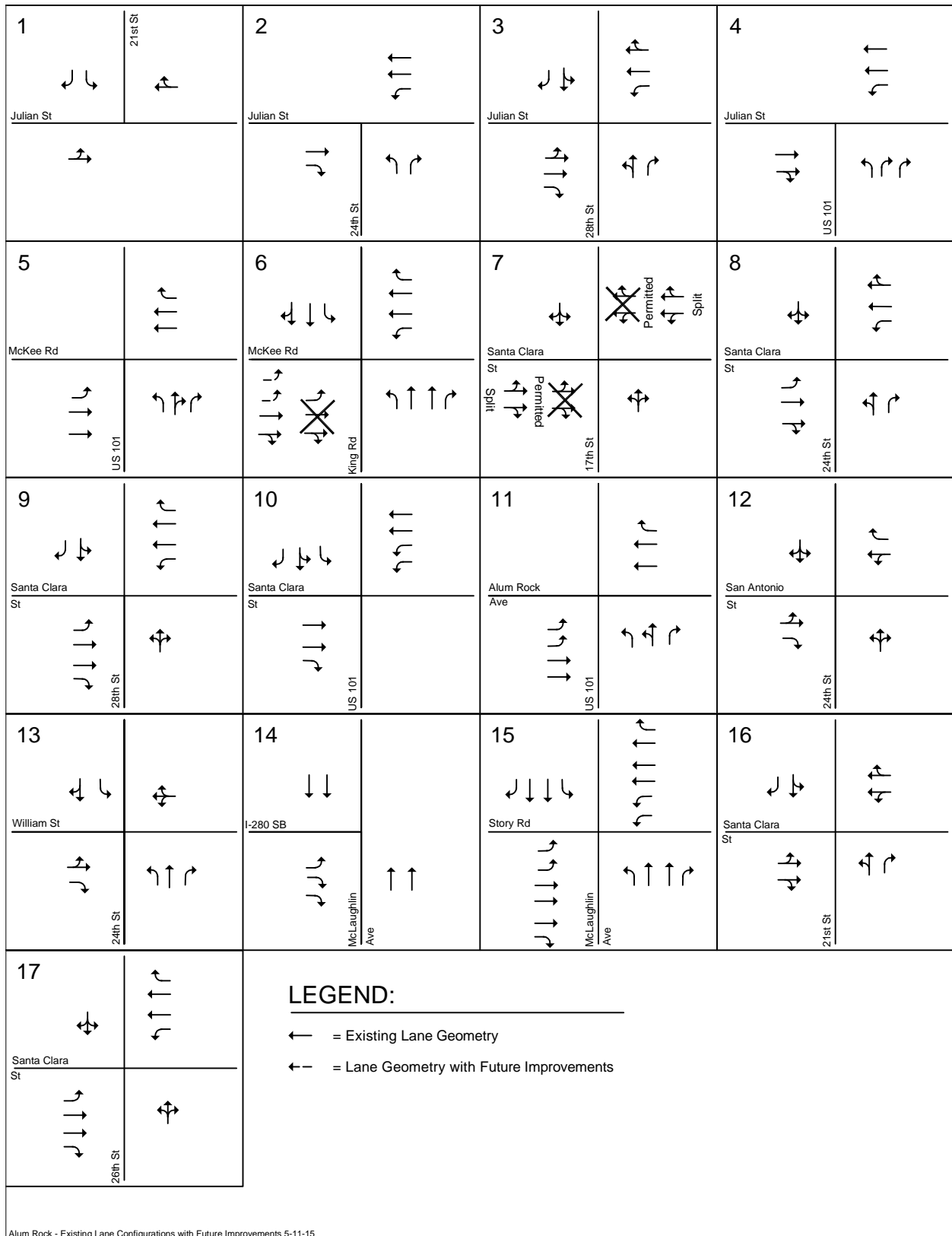

Alum Rock - Existing Lane Configurations with Future Improvements 5-11-15

Figure 20
2025 No Project/Phase I Conditions Intersection Lane Configurations – Alum Rock/28th Station

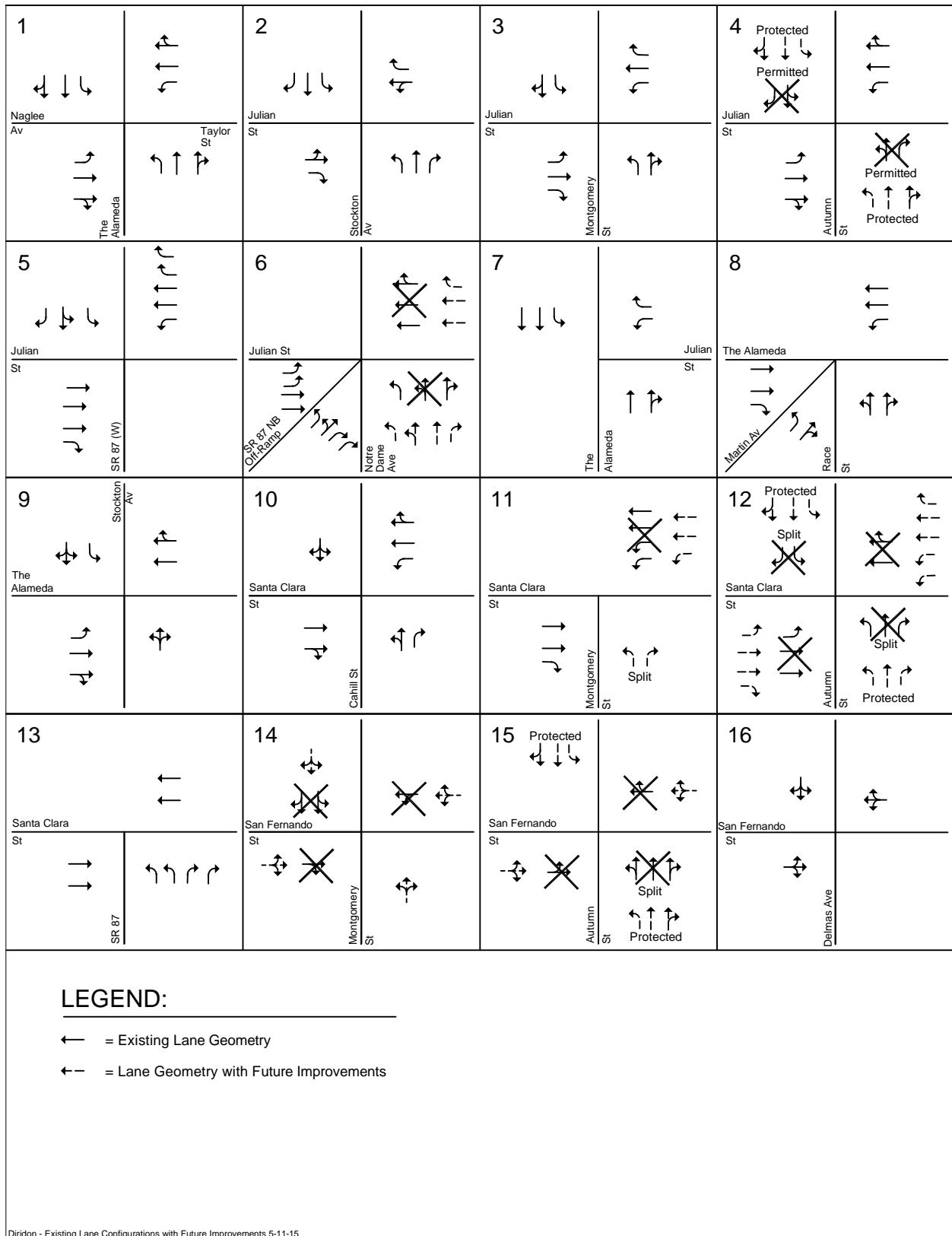

Diridon - Existing Lane Configurations with Future Improvements 5-11-15

Figure 21
2025 No Project/Phase I Conditions Intersection Lane Configurations – Diridon Station

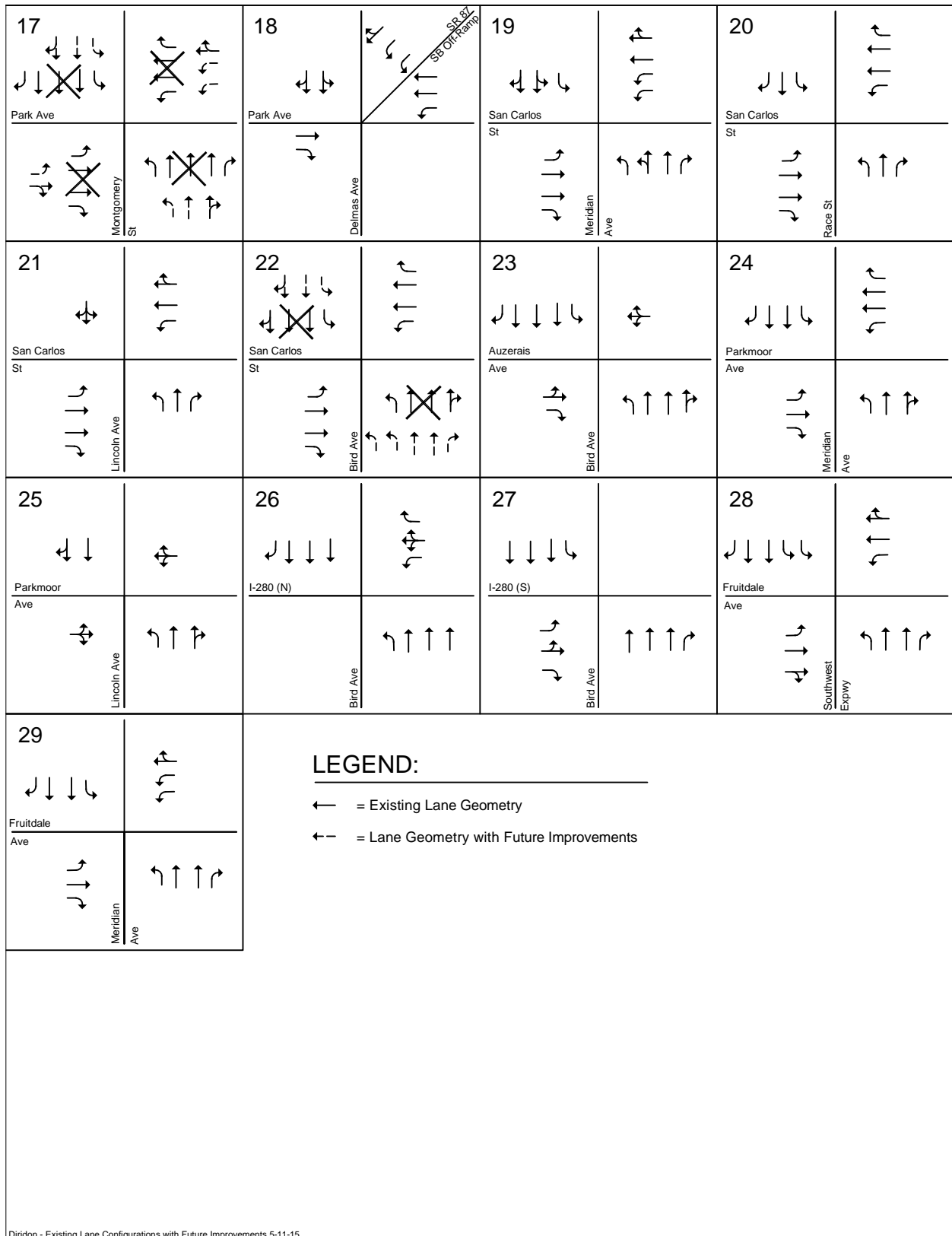

Diridon - Existing Lane Configurations with Future Improvements 5-11-15

Figure 21 (Continued)
2025 No Project/Phase I Conditions Intersection Lane Configurations – Diridon Station

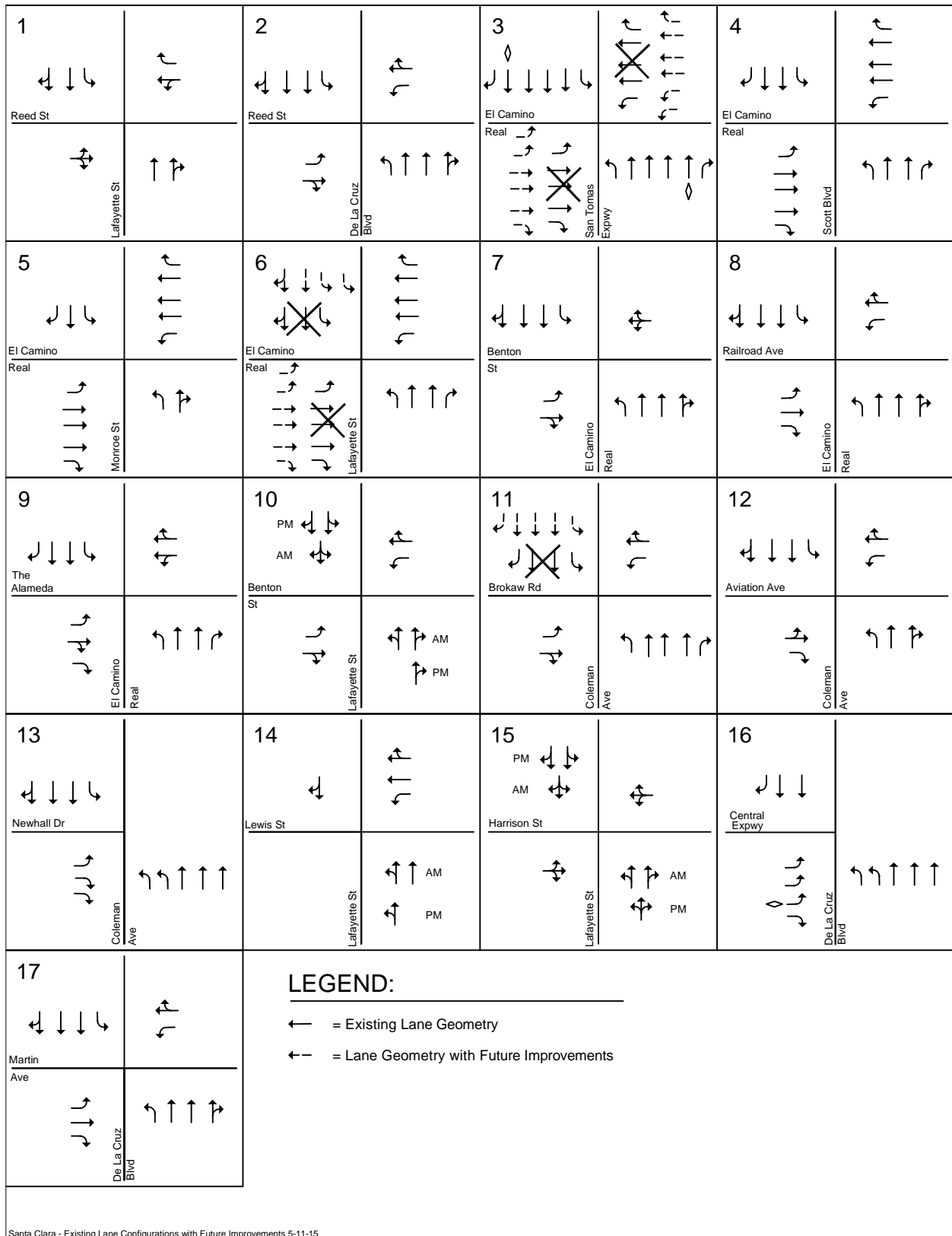

Santa Clara - Existing Lane Configurations with Future Improvements 5-11-15

Figure 22
2025 No Project/Phase I Conditions Intersection Lane Configurations – Santa Clara Station

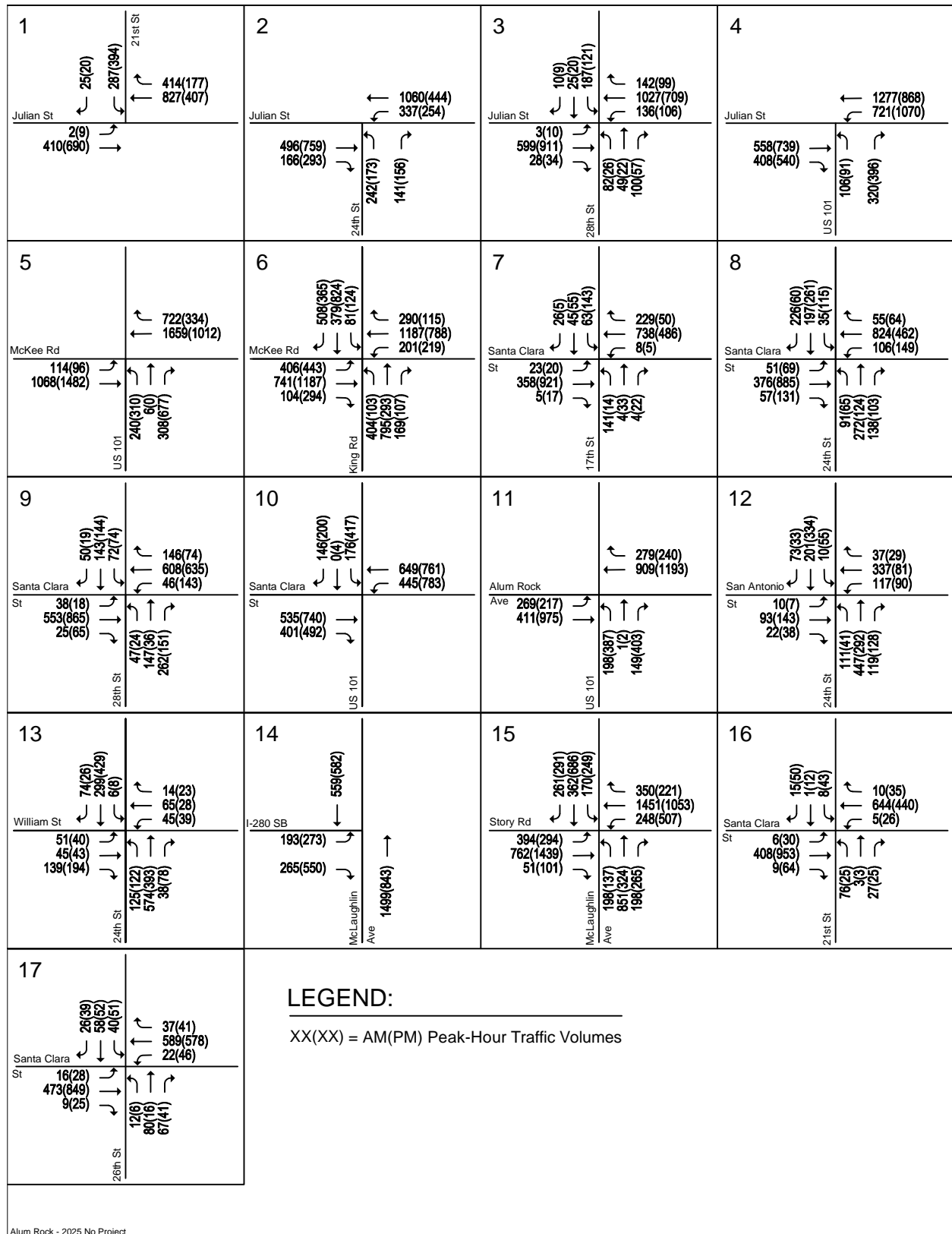

Alum Rock - 2025 No Project

Figure 23
 2025 No Project/Phase I Conditions Traffic Volumes – Alum Rock/28th Street Station

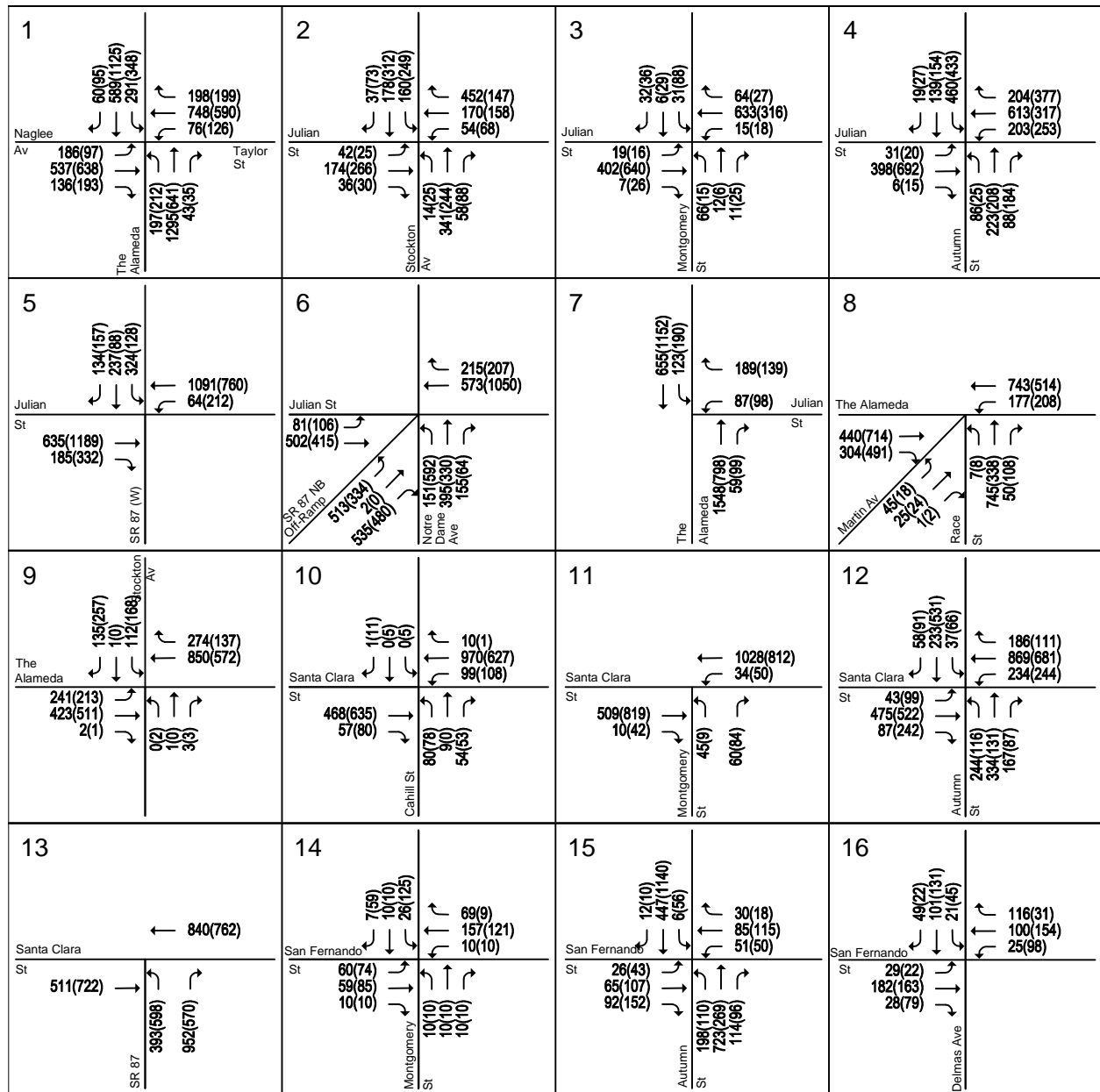

LEGEND:

XX(X) = AM(PM) Peak-Hour Traffic Volumes

Diridon - 2025 No Project

Figure 24
2025 No Project/Phase I Conditions Traffic Volumes – Diridon Station

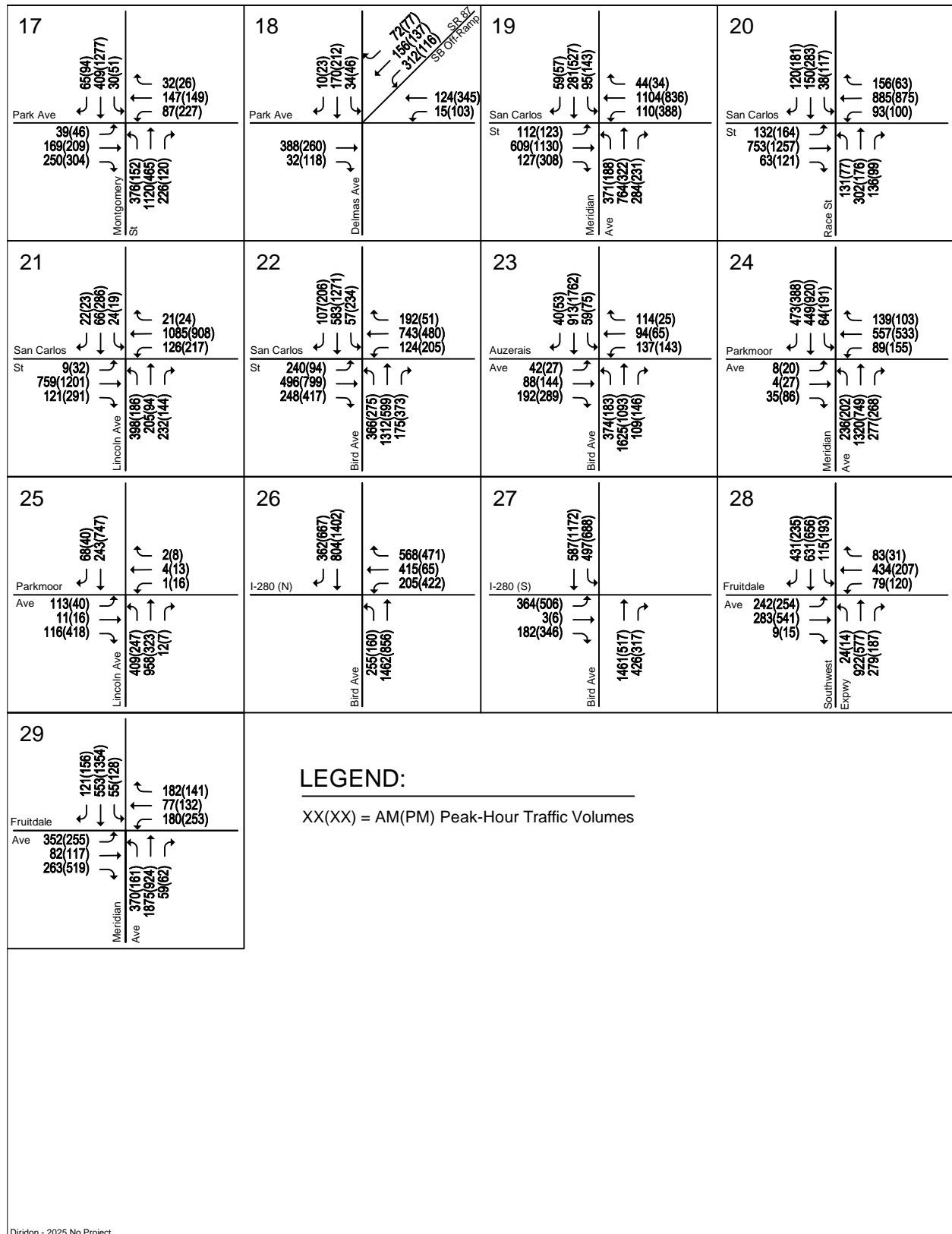

Diridon - 2025 No Project

Figure 24 (Continued)
2025 No Project/Phase I Conditions Traffic Volumes – Diridon Station

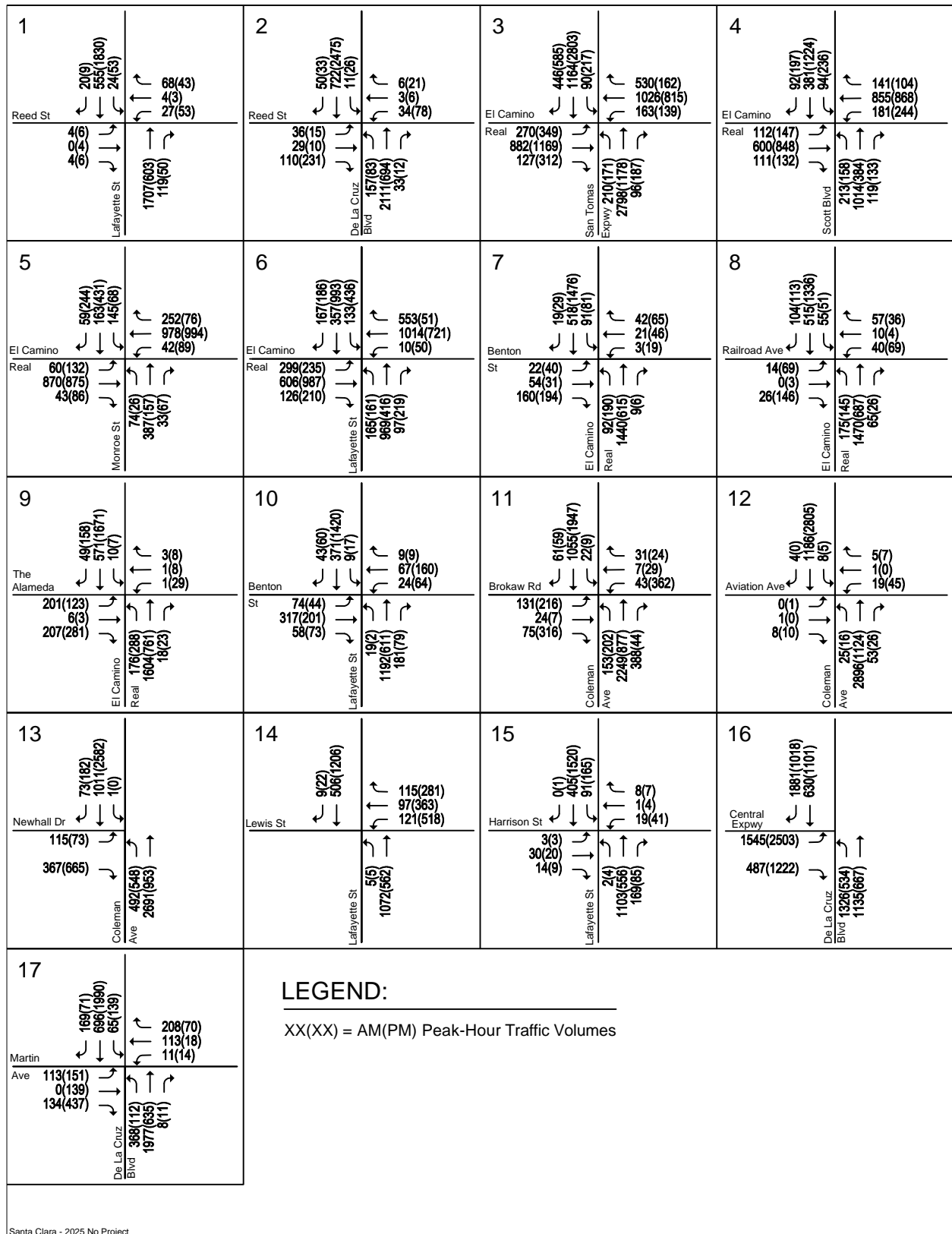

Figure 25
2025 No Project/Phase I Conditions Traffic Volumes – Santa Clara Station

Table 17
2025 No Project/Phase I Conditions Intersection Levels of Service – Alum Rock/28th St. Station

Study Number	Intersection	Peak Hour	Existing		2025 No Project	
			Avg. Delay	LOS	Avg. Delay	LOS
1	21st Street and East Julian Street	AM	20.9	C	22.4	C
		PM	12.2	B	12.5	B
2	24th Street and East Julian Street	AM	17.2	B	20.7	C
		PM	17.1	B	20.9	C
3	North 28th Street and East Julian Street	AM	27.2	C	26.9	C
		PM	14.2	B	17.6	B
4	US 101 and East Julian Street	AM	23.1	C	24.4	C
		PM	26.8	C	68.1	E
5	US 101 and McKee Road	AM	22.1	C	20.7	C
		PM	26.9	C	26.7	C
6	King Road and McKee Road	AM	46.8	D	73.4	E
		PM	47.2	D	64.2	E
7	17th Street and East Santa Clara Street	AM	6.5	A	20.0	B
		PM	9.3	A	22.7	C
8	24th Street and East Santa Clara Street	AM	19.5	B	21.1	C
		PM	21.1	C	22.9	C
9	North 28th Street and East Santa Clara Street	AM	20.9	C	21.4	C
		PM	18.4	B	18.6	B
10	US 101 and East Santa Clara Street*	AM	11.5	B	13.0	B
		PM	16.2	B	19.7	B
11	US 101 and Alum Rock Avenue*	AM	11.0	B	12.5	B
		PM	15.9	B	17.0	B
12	24th Street and San Antonio Street	AM	16.0	B	17.6	B
		PM	12.6	B	12.2	B
13	24th Street and East William Street	AM	15.8	B	17.0	B
		PM	19.4	B	19.5	B
14	McLaughlin Avenue and I-280 SB*	AM	9.5	A	9.7	A
		PM	14.5	B	14.4	B
15	McLaughlin Avenue and Story Road	AM	42.4	D	44.2	D
		PM	48.5	D	50.2	D
16	21st Street and East Santa Clara Street	AM	5.7	A	5.8	A
		PM	4.6	A	4.9	A
17	26th Street and East Santa Clara Street	AM	16.5	B	16.8	B
		PM	14.4	B	14.2	B

* Denotes CMP Intersection
 Entries denoted in **bold** indicate conditions that exceed the applicable level of service standard.



Figure 26
2025 No Project/Phase I Conditions Deficient LOS Intersections – Alum Rock/28th Street Station

Table 18
2025 No Project/Phase I Conditions Intersection Levels of Service – Diridon Station

Study Number	Intersection	Peak Hour	Existing		2025 No Project	
			Avg. Delay	LOS	Avg. Delay	LOS
1	The Alameda and Taylor Street/Naglee Avenue*	AM	45.6	D	64.9	E
		PM	43.4	D	50.4	D
2	Stockton Avenue and West Julian Street	AM	33.8	C	36.5	D
		PM	33.7	C	34.5	C
3	North Montgomery Street and West Julian Street	AM	11.8	B	11.7	B
		PM	11.8	B	12.6	B
4	North Autumn Street and West Julian Street	AM	13.2	B	30.1	C
		PM	13.1	B	33.6	C
5	SR 87 (W) and West Julian Street*	AM	20.8	C	19.3	B
		PM	18.8	B	17.8	B
6	SR 87 (E) and West Julian Street*	AM	53.8	D	52.4	D
		PM	42.3	D	45.6	D
7	The Alameda and West Julian Street	AM	19.0	B	20.1	C
		PM	20.2	C	18.8	B
8	Race Street/Martin Avenue and The Alameda*	AM	37.2	D	38.5	D
		PM	33.0	C	32.0	C
9	Stockton Avenue and The Alameda	AM	24.2	C	28.3	C
		PM	29.5	C	31.9	C
10	Cahill Street and West Santa Clara Street	AM	17.0	B	16.4	B
		PM	18.2	B	17.7	B
11	South Montgomery Street and West Santa Clara Street*	AM	6.2	A	9.5	A
		PM	9.0	A	10.1	B
12	South Autumn Street and West Santa Clara Street*	AM	25.7	C	32.9	C
		PM	21.2	C	36.2	D
13	SR 87 and West Santa Clara Street*	AM	17.9	B	18.6	B
		PM	17.1	B	17.4	B
14	South Montgomery Street and San Fernando Street	AM	9.1	A	5.6	A
		PM	10.4	B	10.4	B
15	South Autumn Street and San Fernando Street	AM	6.7	A	13.9	B
		PM	10.1	B	16.1	B
16	Delmas Avenue and San Fernando Street	AM	5.9	A	10.2	B
		PM	10.2	B	10.4	B
17	South Montgomery Street/Autumn Street and Park Avenue	AM	32.0	C	36.2	D
		PM	38.3	D	47.6	D
18	Delmas Avenue and Park Avenue	AM	23.5	C	24.7	C
		PM	25.1	C	24.9	C
19	Meridian Avenue and San Carlos Street	AM	38.2	D	41.1	D
		PM	47.5	D	49.3	D
20	Race Street and San Carlos Street	AM	36.2	D	33.9	C
		PM	36.7	D	36.0	D
21	Lincoln Avenue and San Carlos Street	AM	34.5	C	36.0	D
		PM	39.8	D	44.0	D
22	Bird Avenue and San Carlos Street*	AM	33.1	C	39.9	D
		PM	39.6	D	49.4	D
23	Bird Avenue and Auzerais Avenue	AM	22.1	C	29.9	C
		PM	26.8	C	25.6	C
24	Meridian Avenue and Parkmoor Avenue	AM	32.2	C	32.9	C
		PM	36.1	D	39.6	D
25	Lincoln Avenue and Parkmoor Avenue	AM	24.3	C	25.6	C
		PM	35.3	D	42.9	D
26	Bird Avenue and I-280 (N)*	AM	29.6	C	34.8	C
		PM	24.4	C	27.1	C
27	Bird Avenue and I-280 (S)*	AM	27.4	C	31.5	C
		PM	22.8	C	32.1	C
28	Southwest Expressway and Fruitdale Avenue	AM	28.7	C	34.2	C
		PM	32.1	C	33.8	C
29	Meridian Avenue and Fruitdale Avenue	AM	45.8	D	58.5	E
		PM	50.4	D	57.1	E

* Denotes CMP Intersection
 Entries denoted in **bold** indicate conditions that exceed the applicable level of service standard.



Figure 27
2025 No Project/Phase I Conditions Deficient LOS Intersections – Diridon Station

Santa Clara Station

The results of the level of service analysis under Year 2025 No Project/Phase I conditions for the Santa Clara Station are summarized in Table 19. The results show that the following study intersection is projected to operate at unacceptable levels of service (LOS F for expressways and CMP intersections) during both peak hours, according to CMP level of service standards (see Figure 28). CMP intersections are denoted by an asterisk (*).

(16) De La Cruz Boulevard and Central Expressway * (LOS F – AM and PM peak hours)

Although the City of Santa Clara does not have a level of service standard for unsignalized intersections, an evaluation of the unsignalized study intersection was performed for informational purposes. The level of service analysis shows that the intersection of Lafayette Street and Harrison Street (#15) is projected to operate at LOS F during both the AM and PM peak hours under Year 2025 No Project/Phase I conditions. However, the peak-hour traffic signal warrant checks indicate that the intersection would not have traffic volumes under 2025 No Project/Phase I conditions that meet thresholds that warrant signalization.

Level of service F at two-way stop-controlled (TWSC) intersections can occur when gaps of traffic on the major street are limited, resulting in long delays for the minor-street traffic as they attempt to enter or cross the major street. At the study intersection of Lafayette Street and Harrison Street, the relatively high traffic volumes along Lafayette Street (major street) cause the delay on the low-volume Harrison Street (minor street) to be worse than the LOS F threshold. However, the low traffic volumes on Harrison Street result in the peak hour traffic signal warrant not being met.

All other CMP and local Santa Clara study intersections currently operate at an acceptable level of service. The level of service calculation sheets for the Santa Clara Station are included in Appendix G.

2025 No Project/Phase I Freeway Segment Levels of Service

Year 2025 No Project/Phase I conditions traffic volumes for the study freeway segments were obtained from the VTA Model. No adjustments were made to the volumes produced by the VTA Model since the freeway network contained in the VTA Model is represented more accurately than local roadways.

The results of the analysis under Year 2025 No Project/Phase I conditions are summarized in Tables 20, 21, and 22. The results show that:

- 12 (plus 4 HOV segments) of the 20 directional freeway segments analyzed for the Alum Rock/28th Street Station are projected to operate at an unacceptable LOS F during at least one peak hour.
- 17 (plus 1 HOV segment) of the 18 directional freeway segments analyzed for the Diridon Station are projected to operate at an unacceptable LOS F during at least one peak hour.
- 24 (plus 7 HOV segments) of the 26 directional freeway segments analyzed for the Santa Clara Station are projected to operate at an unacceptable LOS F during at least one peak hour.

Table 19
2025 No Project/Phase I Conditions Intersection Levels of Service – Santa Clara Station

Study Number	Intersection	Peak Hour	Existing		2025 No Project	
			Avg. Delay ¹	LOS	Avg. Delay ¹	LOS
1	Lafayette Street and Reed Street	AM	6.8	A	7.5	A
		PM	7.4	A	7.4	A
2	De La Cruz Boulevard and Reed Street	AM	11.1	B	14.4	B
		PM	18.1	B	18.7	B
3	San Tomas Expressway and El Camino Real *	AM	66.1	E	65.8	E
		PM	79.7	E	79.6	E
4	Scott Boulevard and El Camino Real *	AM	33.8	C	35.7	D
		PM	37.7	D	40.1	D
5	Monroe Street and El Camino Real *	AM	35.5	D	35.9	D
		PM	32.9	C	32.9	C
6	Lafayette Street and El Camino Real *	AM	40.8	D	39.4	D
		PM	41.3	D	40.0	D
7	El Camino Real and Benton Street	AM	12.8	B	13.7	B
		PM	15.4	B	16.0	B
8	El Camino Real and Railroad Avenue	AM	10.5	B	10.6	B
		PM	12.4	B	12.3	B
9	El Camino Real and The Alameda *	AM	13.0	B	17.2	B
		PM	17.2	B	18.7	B
10	Lafayette Street and Benton Street	AM	17.1	B	18.6	B
		PM	15.7	B	15.7	B
11	Coleman Avenue and Brokaw Road	AM	17.0	B	17.2	B
		PM	88.0	F	45.9	D
12	Coleman Avenue and Aviation Avenue	AM	14.6	B	19.9	B
		PM	7.2	A	7.0	A
13	Coleman Avenue and Newhall Drive	AM	15.8	B	22.7	C
		PM	24.1	C	41.4	D
14	Lafayette Street and Lewis Street	AM	10.7	B	11.3	B
		PM	44.9	D	48.6	D
15	Lafayette Street and Harrison Street (unsignalized) ²	AM	48.9	E	166.1	F
		PM	176.9	F	³	F
16	De La Cruz Boulevard and Central Expressway *	AM	270.6	F	357.2	F
		PM	95.8	F	171.8	F
17	De La Cruz Boulevard and Martin Avenue	AM	34.9	C	35.5	D
		PM	30.7	C	32.6	C

* Denotes CMP Intersection

Entries denoted in **bold** indicate conditions that exceed the applicable level of service standard.

¹The reported delay and corresponding level of service for signalized intersections represents the average delay for all approaches at the intersection. The reported delay and corresponding level of service for unsignalized (two-way stop-controlled) intersections are based on the stop-controlled approach with the highest delay.

²The City of Santa Clara does not have a level of service standard nor impact criteria for unsignalized intersections. Reported intersection delay is presented for informational purposes only.

³Worst approach intersection delay is projected to be greater than 200 seconds per vehicle.

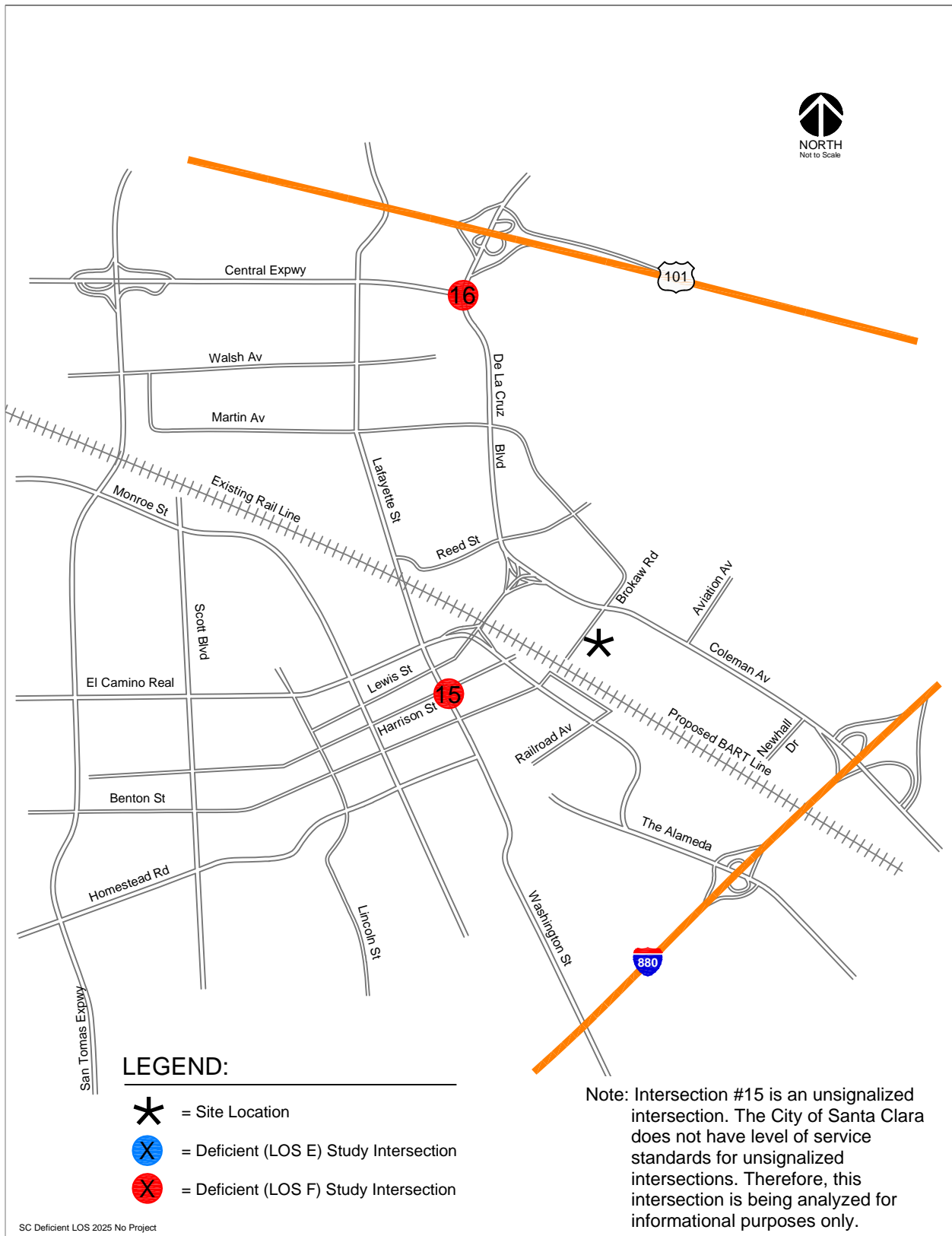

Figure 28
2025 No Project/Phase I Conditions Deficient LOS Intersections – Santa Clara Station

Table 20
2025 No Project/Phase I Conditions Freeway Levels of Service – Alum Rock/28th Street Station

Freeway	Segment	Direction	Peak Hour	Mixed-Flow Lane					HOV Lane				
				Avg. Speed	# of Lanes	Volume	Density	LOS	Avg. Speed	# of Lanes	Volume	Density	LOS
US 101	Tully to Story	NB	AM	25.0	3.0	8,782	117	F	15.0	1.0	2031	135	F
			PM	66.0	3.0	7,569	38	D	70.0	1.0	1180	17	B
US 101	Story to I-280	NB	AM	22.0	3.0	5,098	77	F	19.0	1.0	1528	80	F
			PM	67.0	3.0	3,751	19	C	70.0	1.0	756	11	A
US 101	I-280 to Santa Clara	NB	AM	13.0	3.0	7,614	195	F	13.0	1.0	1761	135	F
			PM	66.0	3.0	5,428	27	D	70.0	1.0	808	12	B
US 101	Santa Clara to McKee	NB	AM	11.0	3.0	7,921	240	F	16.0	1.0	1527	95	F
			PM	66.0	3.0	5,340	27	D	70.0	1.0	719	10	A
I-280	10th to McLaughlin	EB	AM	66.0	4.0	7,635	29	D	---	---	---	---	---
			PM	54.0	4.0	10,240	47	E	---	---	---	---	---
I-280	McLaughlin to US 101	EB	AM	66.0	4.0	5,653	21	C	---	---	---	---	---
			PM	54.0	4.0	6,816	32	D	---	---	---	---	---
I-680	US 101 to King	NB	AM	33.0	4.0	5,583	42	D	---	---	---	---	---
			PM	66.0	4.0	6,605	25	C	---	---	---	---	---
I-680	King to Capitol	NB	AM	20.0	5.0	7,726	77	F	55.0	1.0	423	8	A
			PM	47.0	5.0	9,745	41	D	55.0	1.0	386	7	A
I-680	Capitol to Alum Rock	NB	AM	18.0	4.0	6,243	87	F	55.0	1.0	423	8	A
			PM	65.0	4.0	6,450	25	C	55.0	1.0	386	7	A
I-680	Alum Rock to McKee	NB	AM	27.0	4.0	7,242	67	F	55.0	1.0	619	11	A
			PM	66.0	4.0	6,975	26	C	55.0	1.0	495	9	A
I-680	McKee to Alum Rock	SB	AM	63.0	4.0	6,752	27	D	55.0	1.0	493	9	A
			PM	47.0	4.0	7,420	39	D	55.0	1.0	500	9	A
I-680	Alum Rock to Capitol	SB	AM	23.0	4.0	6,513	71	F	55.0	1.0	493	9	A
			PM	65.0	4.0	5,683	22	C	55.0	1.0	500	9	A
I-680	Capitol to King	SB	AM	21.0	4.0	9,578	114	F	55.0	1.0	356	6	A
			PM	66.0	4.0	7,710	29	D	55.0	1.0	223	4	A
I-680	King to US 101	SB	AM	12.0	4.0	6,605	138	F	---	---	---	---	---
			PM	66.0	4.0	5,330	20	C	---	---	---	---	---
I-280	US 101 to McLaughlin	WB	AM	14.0	4.0	6,605	118	F	---	---	---	---	---
			PM	66.0	4.0	5,330	20	C	---	---	---	---	---
I-280	McLaughlin to 10th	WB	AM	19.0	4.0	10,700	141	F	---	---	---	---	---
			PM	65.0	4.0	8,012	31	D	---	---	---	---	---
US 101	McKee to Santa Clara	SB	AM	67.0	3.0	4,876	24	C	67.0	1.0	585	9	A
			PM	62.0	3.0	6,883	37	D	70.0	1.0	1557	22	C
US 101	Santa Clara to I-280	SB	AM	67.0	3.0	5,496	27	D	67.0	1.0	651	10	A
			PM	63.0	3.0	7,295	39	D	70.0	1.0	1671	24	C
US 101	I-280 to Story	SB	AM	67.0	3.0	3,586	18	B	67.0	1.0	572	9	A
			PM	54.0	3.0	5,048	31	D	70.0	1.0	1276	18	B
US 101	Story to Tully	SB	AM	66.0	4.0	8,175	31	D	67.0	1.0	851	13	B
			PM	45.0	4.0	10,019	56	E	70.0	1.0	1611	23	C

Source: Santa Clara Valley Transportation Authority Congestion Management Program Monitoring Study, 2014.

The average speed for future HOV lanes are assumed to be 55 MPH.

Bold indicates unacceptable LOS.

Table 21
2025 No Project/Phase I Conditions Freeway Levels of Service – Diridon Station

Freeway Segment	Direction	Peak Hour	Mixed-Flow Lane						HOV Lane				
			Avg. Speed	# of Lanes	Volume	Density	LOS	Avg. Speed	# of Lanes	Volume	Density	LOS	
SR 87 Curtner to Almaden Expressway	NB	AM	13.0	2.0	3,772	145	F	22.0	1.0	1736	79	F	
		PM	65.0	2.0	3,161	24	C	70.0	1.0	669	10	A	
SR 87 Almaden Expressway to Alma	NB	AM	29.0	2.0	4,700	81	F	43.0	1.0	1993	46	D	
		PM	41.0	2.0	3,890	47	E	70.0	1.0	731	10	A	
SR 87 Alma to I-280	NB	AM	33.0	2.0	5,651	86	F	61.0	1.0	2015	33	D	
		PM	66.0	2.0	4,362	33	D	70.0	1.0	797	11	A	
SR 87 I-280 to Julian	NB	AM	16.0	2.0	3,320	104	F	30.0	1.0	1314	44	D	
		PM	67.0	2.0	1,800	13	B	70.0	1.0	400	6	A	
SR 87 Julian to Coleman	NB	AM	14.0	2.0	4,595	164	F	32.0	1.0	1547	48	E	
		PM	67.0	2.0	2,767	21	C	70.0	1.0	527	8	A	
I-280 I-880 to Meridian	EB	AM	66.0	4.0	6,444	24	C	67.0	1.0	547	8	A	
		PM	17.0	4.0	6,886	101	F	20.0	1.0	840	42	D	
I-280 Meridian to Bird	EB	AM	61.0	4.0	8,651	35	D	---	---	---	---	---	
		PM	21.0	4.0	9,367	112	F	---	---	---	---	---	
I-280 Bird to SR 87	EB	AM	66.0	4.0	4,689	18	B	---	---	---	---	---	
		PM	25.0	4.0	5,974	60	F	---	---	---	---	---	
I-280 SR 87 to 10th	EB	AM	67.0	4.0	6,435	24	C	---	---	---	---	---	
		PM	27.0	4.0	8,504	79	F	---	---	---	---	---	
I-280 10th to SR 87	WB	AM	21.0	4.0	10,147	121	F	---	---	---	---	---	
		PM	65.0	4.0	8,331	32	D	---	---	---	---	---	
I-280 SR 87 to Bird	WB	AM	20.0	4.0	6,191	77	F	---	---	---	---	---	
		PM	62.0	4.0	5,318	21	C	---	---	---	---	---	
I-280 Bird to Meridian	WB	AM	18.0	4.0	9,752	135	F	---	---	---	---	---	
		PM	58.0	4.0	8,914	38	D	---	---	---	---	---	
I-280 Meridian to I-880	WB	AM	14.0	3.0	7,295	174	F	26.0	1.0	776	30	D	
		PM	66.0	3.0	6,445	33	D	70.0	1.0	465	7	A	
SR 87 Coleman to Julian	SB	AM	66.0	2.0	2,284	17	B	67.0	1.0	229	3	A	
		PM	32.0	2.0	4,013	63	F	50.0	1.0	1114	22	C	
SR 87 Julian to I-280	SB	AM	67.0	2.0	2,675	20	C	67.0	1.0	293	4	A	
		PM	36.0	2.0	4,616	64	F	70.0	1.0	1231	18	B	
SR 87 I-280 to Alma	SB	AM	67.0	2.0	3,744	28	D	67.0	1.0	573	9	A	
		PM	15.0	2.0	3,794	126	F	60.0	1.0	1757	29	D	
SR 87 Alma to Almaden Expressway	SB	AM	66.0	2.0	3,736	28	D	67.0	1.0	560	8	A	
		PM	27.0	2.0	4,425	82	F	60.0	1.0	1720	29	D	
SR 87 Almaden Expressway to Curtner	SB	AM	66.0	2.0	2,866	22	C	67.0	1.0	499	7	A	
		PM	36.0	2.0	3,480	48	E	70.0	1.0	1520	22	C	

Source: Santa Clara Valley Transportation Authority Congestion Management Program Monitoring Study, 2014.

The average speed for future HOV lanes are assumed to be 55 MPH.

Bold indicates unacceptable LOS.

Table 22
2025 No Project/Phase I Conditions Freeway Levels of Service – Santa Clara Station

Freeway	Segment	Direction	Peak Hour	Mixed-Flow Lane					HOV Lane				
				Avg. Speed	# of Lanes	Volume	Density	LOS	Avg. Speed	# of Lanes	Volume	Density	LOS
US 101	I-880 to Old Bayshore	NB	AM	14.0	3.0	5,900	140	F	19.0	1.0	1794	94	F
			PM	67.0	3.0	3,747	19	C	70.0	1.0	627	9	A
US 101	Old Bayshore to First	NB	AM	12.0	3.0	6,255	174	F	13.0	1.0	1715	132	F
			PM	66.0	3.0	4,226	21	C	70.0	1.0	632	9	A
US 101	First to SR 87	NB	AM	19.0	3.0	6,824	120	F	19.0	1.0	1573	83	F
			PM	67.0	3.0	5,178	26	C	70.0	1.0	744	11	A
US 101	SR 87 to De La Cruz	NB	AM	12.0	3.0	6,658	185	F	14.0	1.0	1482	106	F
			PM	66.0	3.0	5,427	27	D	70.0	1.0	744	11	A
US 101	De La Cruz to Montague	NB	AM	26.0	3.0	6,349	81	F	39.0	1.0	2026	52	E
			PM	65.0	3.0	5,481	28	D	70.0	1.0	1201	17	B
US 101	Montague to Great America	NB	AM	21.0	3.0	6,722	107	F	41.0	1.0	1695	41	D
			PM	58.0	3.0	5,829	34	D	70.0	1.0	1260	18	B
I-880	I-280 to Stevens Creek	NB	AM	15.0	3.0	5,213	116	F	55.0	1.0	647	12	B
			PM	66.0	3.0	4,764	24	C	55.0	1.0	815	15	B
I-880	Stevens Creek to Bascom	NB	AM	20.0	3.0	6,683	111	F	55.0	1.0	647	12	B
			PM	16.0	3.0	5,522	115	F	55.0	1.0	815	15	B
I-880	Bascom to The Alameda	NB	AM	27.0	3.0	6,124	76	F	55.0	1.0	695	13	B
			PM	13.0	3.0	6,092	156	F	55.0	1.0	919	17	B
I-880	The Alameda to Coleman	NB	AM	31.0	3.0	6,375	69	F	55.0	1.0	705	13	B
			PM	15.0	3.0	6,463	144	F	55.0	1.0	1096	20	C
I-880	Coleman to SR 87	NB	AM	22.0	3.0	6,116	93	F	55.0	1.0	813	15	B
			PM	24.0	3.0	6,350	88	F	55.0	1.0	1279	23	C
I-880	SR 87 to First	NB	AM	48.0	3.0	6,116	42	D	55.0	1.0	813	15	B
			PM	22.0	3.0	6,350	96	F	55.0	1.0	1279	23	C
I-880	First to US 101	NB	AM	36.0	3.0	5,750	53	E	55.0	1.0	641	12	B
			PM	51.0	3.0	6,921	45	D	55.0	1.0	1075	20	C
I-880	US 101 to First	SB	AM	16.0	3.0	6,211	129	F	55.0	1.0	1093	20	C
			PM	14.0	3.0	5,685	135	F	55.0	1.0	873	16	B
I-880	First to SR 87	SB	AM	25.0	3.0	5,741	77	F	55.0	1.0	1140	21	C
			PM	14.0	3.0	5,705	136	F	55.0	1.0	969	18	B
I-880	SR 87 to Coleman	SB	AM	65.0	3.0	5,741	29	D	55.0	1.0	1140	21	C
			PM	23.0	3.0	5,705	83	F	55.0	1.0	969	18	B
I-880	Coleman to The Alameda	SB	AM	66.0	3.0	6,345	32	D	55.0	1.0	912	17	B
			PM	23.0	3.0	6,731	98	F	55.0	1.0	869	16	B
I-880	The Alameda to Bascom	SB	AM	66.0	3.0	6,009	30	D	55.0	1.0	842	15	B
			PM	25.0	3.0	6,651	89	F	55.0	1.0	928	17	B
I-880	Bascom to Stevens Creek	SB	AM	50.0	3.0	5,835	39	D	55.0	1.0	842	15	B
			PM	30.0	3.0	6,638	74	F	55.0	1.0	944	17	B
I-880	Stevens Creek to I-280	SB	AM	66.0	3.0	4,496	23	C	55.0	1.0	734	13	B
			PM	65.0	3.0	4,825	25	C	55.0	1.0	860	16	B
US 101	Great America to Montague	SB	AM	66.0	3.0	6,100	31	D	67.0	1.0	1219	18	B
			PM	14.0	3.0	6,858	163	F	20.0	1.0	1760	88	F
US 101	Montague to De La Cruz	SB	AM	66.0	3.0	5,528	28	D	67.0	1.0	1133	17	B
			PM	13.0	3.0	6,306	162	F	40.0	1.0	1949	49	E
US 101	De La Cruz to SR 87	SB	AM	62.0	3.0	6,620	36	D	67.0	1.0	1051	16	B
			PM	18.0	3.0	8,087	150	F	50.0	1.0	2003	40	D
US 101	SR 87 to First	SB	AM	67.0	3.0	4,708	23	C	67.0	1.0	820	12	B
			PM	16.0	3.0	5,994	125	F	30.0	1.0	1762	59	F
US 101	First to Old Bayshore	SB	AM	67.0	3.0	3,513	17	B	67.0	1.0	588	9	A
			PM	6.0	3.0	4,844	269	F	20.0	1.0	1507	75	F
US 101	Old Bayshore to I-880	SB	AM	67.0	3.0	4,420	22	C	67.0	1.0	640	10	A
			PM	8.0	3.0	6,045	252	F	30.0	1.0	1730	58	E

Source: Santa Clara Valley Transportation Authority Congestion Management Program Monitoring Study, 2014.

The average speed for future HOV lanes are assumed to be 55 MPH.

Bold indicates unacceptable LOS.

2025 No Project/Phase I Freeway Ramp Queuing Analysis

The results of the freeway ramp queuing analysis under Year 2025 No Project/Phase I conditions are described below and summarized in Table 23.

Freeway Ramp Lane Geometrics

The lane geometrics at the study freeway ramps were assumed to be the same as described under existing conditions. However, it was assumed that under Year 2025 No Project/Phase I conditions, the on-ramp meters would be operational.

Capacities at the freeway on-ramps with ramp metering are dependent on the ramp meter rate. As discussed in Chapter 1 of this report, based on Caltrans' maximum meter rate output for District 4, metered on-ramps will serve a maximum of 900 total vehicles during an hour.

Freeway Ramp Volumes

Traffic volumes on each of the freeway ramps were derived from the forecasted turn-movement volumes at the adjacent ramp intersections.

Freeway Ramp Queue Lengths

Based on the projected queue lengths obtained from TRAFFIX, it was determined that the available queue storage space for the freeway off-ramps studied would be sufficient to serve the projected demand under Year 2025 No Project/Phase I conditions.

The queue length projections for the freeway on-ramps show that the on-ramps studied would experience excessive queue lengths that would spill out of the ramps onto the adjacent street under Year 2025 No Project/Phase I conditions. This is the result of the projected on-ramp demand exceeding the assumed ramp capacity.

It should be noted that these projections assume a very conservative meter rate of 900 vph for the entire peak hour analyzed.

The projected queue lengths under Year 2025 No Project/Phase I conditions are summarized in Table 23 below.

Table 23
2025 No Project/Phase I Conditions Freeway Ramp Queuing Analysis

Freeway Ramp	Total Storage (Vehicle) ¹	Volume and Queue Projections (Vehicles)	
		Existing	2025 No Project
<u>US 101 at McKee Road Interchange</u>			
US 101 SB On-Ramp at McKee Road	32		
PM Volume ²		1131	1610
Projected Queue Length ³		-- ⁵	710
US 101 SB Loop Off-Ramp at McKee Road	92		
AM Volume ²		426	426
Projected Queue Length ⁴		27	27
<u>US 101 at Santa Clara Street/Alum Rock Avenue Interchange</u>			
US 101 SB On-Ramp at Santa Clara Street	34		
PM Volume ²		949	1279
Projected Queue Length ³		-- ⁵	379
US 101 NB Off-Ramp at Alum Rock Avenue	67		
AM Volume ²		244	348
Projected Queue Length ⁴		10	14
PM Volume ²		695	792
Projected Queue Length ⁴		24	32
Notes:			
¹ Total number of vehicles that can store within the ramp.			
² Peak-hour ramp volume projections.			
³ Total number of vehicles in the queue, as calculated based on the ramp meter rate and projected traffic volumes.			
⁴ Total number of vehicles in the queue, as obtained from TRAFFIX.			
⁵ Currently, the ramp meter at these on-ramps is not operational during the PM peak hour, therefore, no measurable queues are currently experienced at these locations.			
Bold queue lengths exceed the available queue storage capacity within the ramp.			

4.

Year 2025 Phase II Project Conditions – Alum Rock/28th Street Station

This chapter describes traffic conditions in the year 2025 with the proposed Phase II Project. Alum Rock/28th Street Station is one of the four stations proposed along the Phase II Project corridor that would provide for the extension of BART service to the Cities of San Jose and Santa Clara (see Figure 1). Year 2025 Phase II Project conditions analyzed traffic conditions for the year 2025 (opening day of the project) in the vicinity of the Alum Rock/28th Street Station with the addition of the proposed four BART Stations. The analysis includes intersection and freeway segment level of service analysis.

A detailed description of the method used to estimate station-generated traffic is included in the next few sections. Estimates of the station-generated traffic, identification of impacts, and recommended mitigation measures for the Alum Rock/28th Street Station under Year 2025 Phase II Project conditions also are included within this chapter. Year 2025 Phase II Project conditions were evaluated relative to Year 2025 No Project/Phase I conditions in order to determine potential project impacts on the future transportation network. The significant impact criteria are discussed in Chapter 1 of this report.

Intersection and Freeway Analysis Methodology - All Stations

Trip Generation

Trip generation for the proposed stations was estimated based on daily transit ridership projections by mode of access, which includes PNR and KNR person trips, forecasted by the VTA Model. The PNR and KNR daily person trips were converted to auto access trips to BART by applying an average vehicle occupancy rate of 1.1 persons/vehicle for PNR trips and 2.1 persons/vehicle for KNR trips. The 2.1 persons per vehicle for KNR include the driver and 1.1 transit riders that are dropped off or picked up at the transit station. Peak-hour factors were then applied to the daily trips to obtain drive access (PNR and KNR) trips for the AM and PM peak-hours. These peak-hour factors by mode of access are presented in Table 24. The PNR auto trips were then assigned to the BART Station parking lots and the KNR trips were assigned to the BART drop-off areas of the BART Stations. The trip generation estimates for the proposed stations under the 2025 Phase II Project conditions are presented in subsequent sections within this chapter.

Table 24
PNR and KNR Peak-Hour Factors by Mode

	Peak Hour	
	AM	PM
BART → PNR	1.0%	23.1%
BART → KNR	2.1%	20.2%
PNR → BART	29.6%	2.7%
KNR → BART	19.3%	5.0%

Source: BART Survey Data.

The peak-hour traffic volumes used in the traffic analysis implicitly account for the number of buses. Buses are included in the traffic counts and are therefore reflected in the traffic projections. Most, if not all, future bus trips under project conditions are already on the roadway network. The project would not cause a measurable increase in the number of bus trips in the area. However, bus routing may be altered to serve the Phase II BART Stations and there may be a change in routing through a limited number of study intersections.

Station Trip Types

Passenger projections obtained from the VTA Model are comprised of daily PNR, KNR, bus, walk, and transfer passenger trips. Of the daily passenger trip projections, only the PNR and KNR trips represent vehicular trips to the station. These trip types are described below.

Park-and-Ride Trips

Park-and-ride trips represent those vehicular trips made by BART passengers to the station wishing to park their vehicles in the provided PNR lot/structure and commute to their final destination via BART. PNR vehicles represent two daily station trips: one primarily inbound in the morning and one primarily outbound in the evening.

Kiss-and-Ride Trips

Kiss-and-ride trips consist of the vehicular trips made by two or more people per vehicle which include at least one BART commuter. These vehicles will access the station, drop-off (or pick-up in the evening) the BART commuter, and continue on to another destination. KNR vehicles represent four daily station trips: one inbound and one outbound in the morning (drop-off) and one inbound and one outbound in the evening (pick-up).

Trip Distribution and Assignment

Distribution patterns and assignment of station-generated traffic (PNR and KNR trips) for the Year 2025 Phase II Project conditions were obtained from the VTA Model.

2025 Phase II Project Conditions Intersection Lane Configurations

The intersection lane configurations under the Year 2025 Phase II Project conditions were assumed to be the same as described under 2025 No Project/Phase I conditions.

2025 Phase II Project Conditions Intersection Traffic Volumes

Traffic volumes for the Year 2025 Phase II Project conditions were obtained from the VTA Model. These traffic volumes represent traffic projections for the year 2025 (opening day of the project) with the addition of planned improvements and the Phase II Project and proposed stations. Year 2025 Phase II Project conditions model volume forecasts were adjusted using the method previously described (Introduction chapter).

2025 Phase II Project Conditions Freeway Volumes

Traffic volumes for the Year 2025 Phase II Project conditions for the study freeway segments were obtained from the VTA Model. These volumes represent traffic projections for the year 2025 with the addition of planned improvements and the Phase II Project and proposed stations. Unlike intersection forecast volumes, no adjustments were made to the freeway volumes produced by the VTA Model since the freeway network contained in the VTA Model is represented more accurately than local roadways.

Station Description – Alum Rock/28th Street Station

The proposed Alum Rock/28th Street Station site is located on the east side of North 28th Street, between McKee Road and East Santa Clara Street (see Figure 2). The station site would include an underground station and both above-ground and below-ground system facilities, including a 1,200-space parking structure for PNR BART commuters. KNR facilities would be provided along North 28th Street and/or on the station site. Additionally, shuttle/bus drop-off areas would be provided within the station site or along North 28th Street. Access to the station area would be from North 28th Street, via McKee Road from the north and East Santa Clara Street from the south.

The Alum Rock/28th Street Station site and the surrounding study area are shown on Figure 5.

Station Trip Generation Estimates – Alum Rock/28th Street Station

The trip generation estimates for the proposed Alum Rock/28th Street Station under the Year 2025 Phase II Project conditions were developed using the VTA Model and based on the method previously described. Ridership projections total about 10,000 daily BART riders (5,000 boardings and 5,000 alightings) at the Alum Rock/28th Street Station under the Year 2025 Phase II Project conditions. Table 25 presents the daily and peak hour trip generation estimates for each of the drive access modes to the Alum Rock/28th Street Station, described in the following sections.

Park-and-Ride Trips

Model projections of passenger volumes for the Alum Rock/28th Street Station indicate that 2,632 daily PNR trips would access/egress the station under the 2025 Phase II Project conditions. A total of 366 (354 inbound and 12 outbound) and 308 (32 inbound and 276 outbound) PNR trips are estimated to occur during the AM and PM peak hours, respectively.

Kiss-and-Ride Trips

Model projections of passenger volumes for the Alum Rock/28th Street Station indicate that 407 daily KNR trips would utilize the station under the 2025 Phase II Project conditions scenario. Since KNR trips consist of vehicles entering the station site to drop off a BART commuter and then exiting the site and proceeding on to another destination, station trip generation estimates for peak hour inbound and outbound KNR vehicle trips are equivalent. It is estimated that a total of 80 (40 inbound/40 outbound) KNR trips would occur during the AM peak hour and a total of 94 (47 inbound/47 outbound) KNR trips would occur during the PM peak hour.

Table 25
Alum Rock/28th Street Station Trip Generation Estimates – 2025 Phase II Project Conditions

Mode of Access by Station	Daily Trips	Parking Demand (# of Spaces)	AM Peak Hour Trips			PM Peak Hour Trips		
			In	Out	Total	In	Out	Total
<i>Alum Rock Station:</i>								
Kiss and Ride Trips	407		40	40	80	47	47	94
Park and Ride Trips	2,632	1196	354	12	366	32	276	308
Total	3,039		394	52	446	79	323	402

Source: VTA Model, December 2014.

Trip Distribution and Assignment

Distribution pattern and assignment of station-generated traffic (PNR and KNR trips) to the proposed Alum Rock/28th Street Station under the Year 2025 Phase II Project conditions were developed from traffic assignments using the VTA Model. As mentioned previously, implementation of the proposed project would result in a shift in travel patterns, as the result of some commuters modifying their travel route to access the station area, and in the removal of auto trips from the roadway network, as some commuters shift from auto to transit modes of travel. Thus, station-generated traffic consists of two components: 1.) new vehicular trips accessing the proposed Alum Rock/28th Street Station, referred to as *station drive access* trips, and 2.) all the trips that would no longer be on the roadway as a result of the Phase II Project, represented by negative trips on the roadway network. It is projected that under Year 2025 Phase II Project conditions, approximately 950 and 800 AM and PM peak-hour trips, respectively, would be removed from the roadway transportation system as the result of the Phase II Project and proposed Stations. The total *net project trips* generated by the Alum Rock/28th Street Station are therefore calculated by adding the new station drive access trips (positive trips) and the trips removed from the roadway network as a result of the Alum Rock/28th Street Station and Phase II Project (negative trips). The Alum Rock/28th Street Station drive access trips for the Year 2025 Phase II Project conditions are shown graphically on Figure 29 while the net project trips are shown on Figure 30.

As an example of the trip assignment process, the calculation of Year 2025 Phase II Project conditions volumes during the AM peak hour for the inbound movements (westbound through and northbound left-turn movements) at the intersection of US 101 and East Julian Street (Study Intersection #4) is explained in further detail below:

- The turn movements feeding into the proposed Alum Rock/28th Street Station from the intersection of US 101 and East Julian Street are projected to be 1,277 westbound through and 106 northbound left-turn movements during the AM peak hour under Year 2025 No Project/Phase I conditions (see Figure 23).
- One of the two access intersections to the proposed Alum Rock/28th Street Station would be the intersection of North 28th Street and East Julian Street, west of US 101. Vehicles are anticipated to use North 28th Street to access the proposed Alum Rock/28th Street Station, located on the east side of 28th Street. As shown in Figure 29, it is projected that 82 vehicles would access the station by making a westbound through movement at the US 101/East Julian Street intersection and 47 vehicles would make a northbound left-turn movement from US 101 towards North 28th Street. Note that both PNR and KNR facilities are accessible from the North 28th Street/East Julian Street intersection. These vehicles are added to the Year 2025 No Project/Phase I conditions traffic volumes.

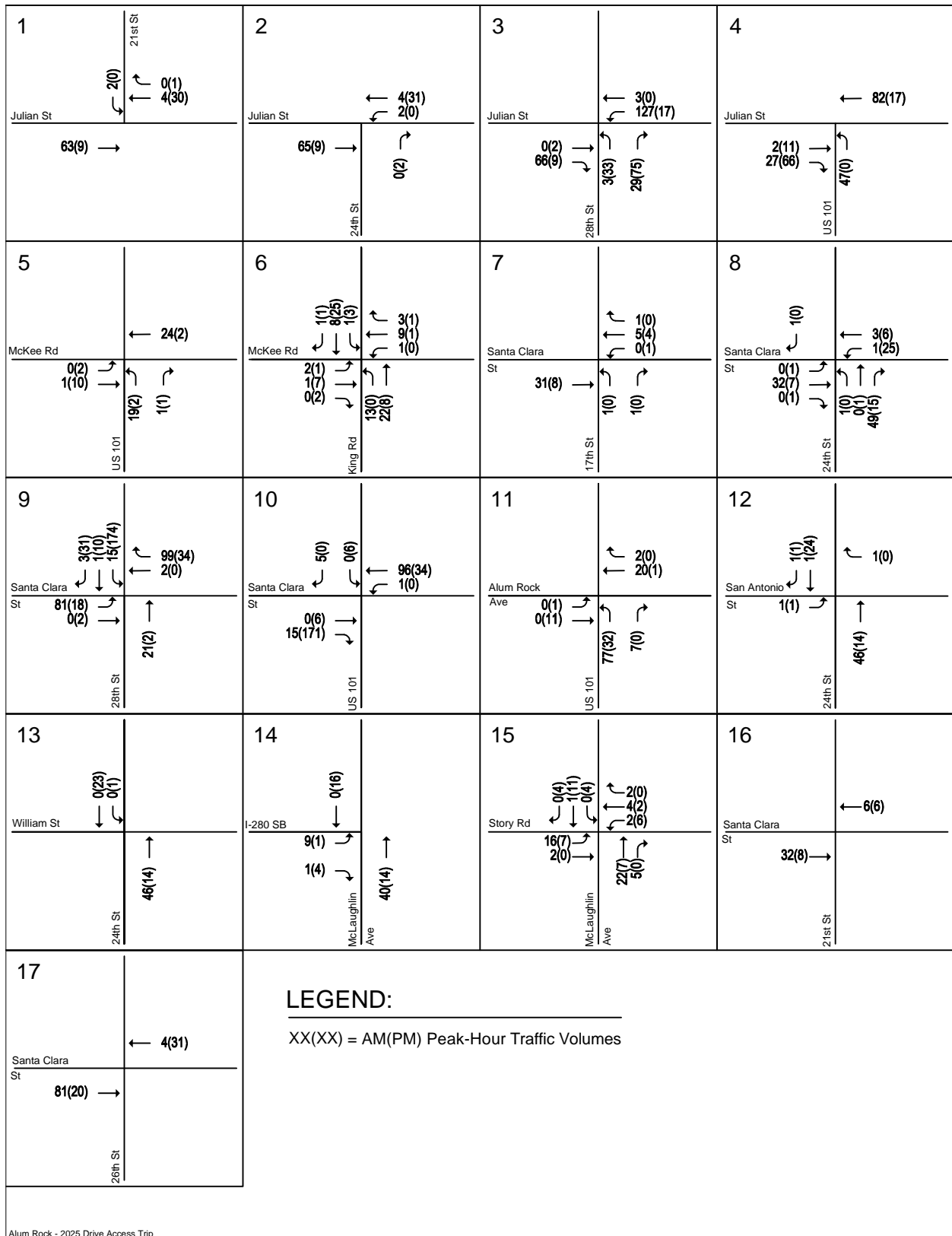

Figure 29
2025 Phase II Project Conditions Station (Drive Access) Trips – Alum Rock/28th Street Station

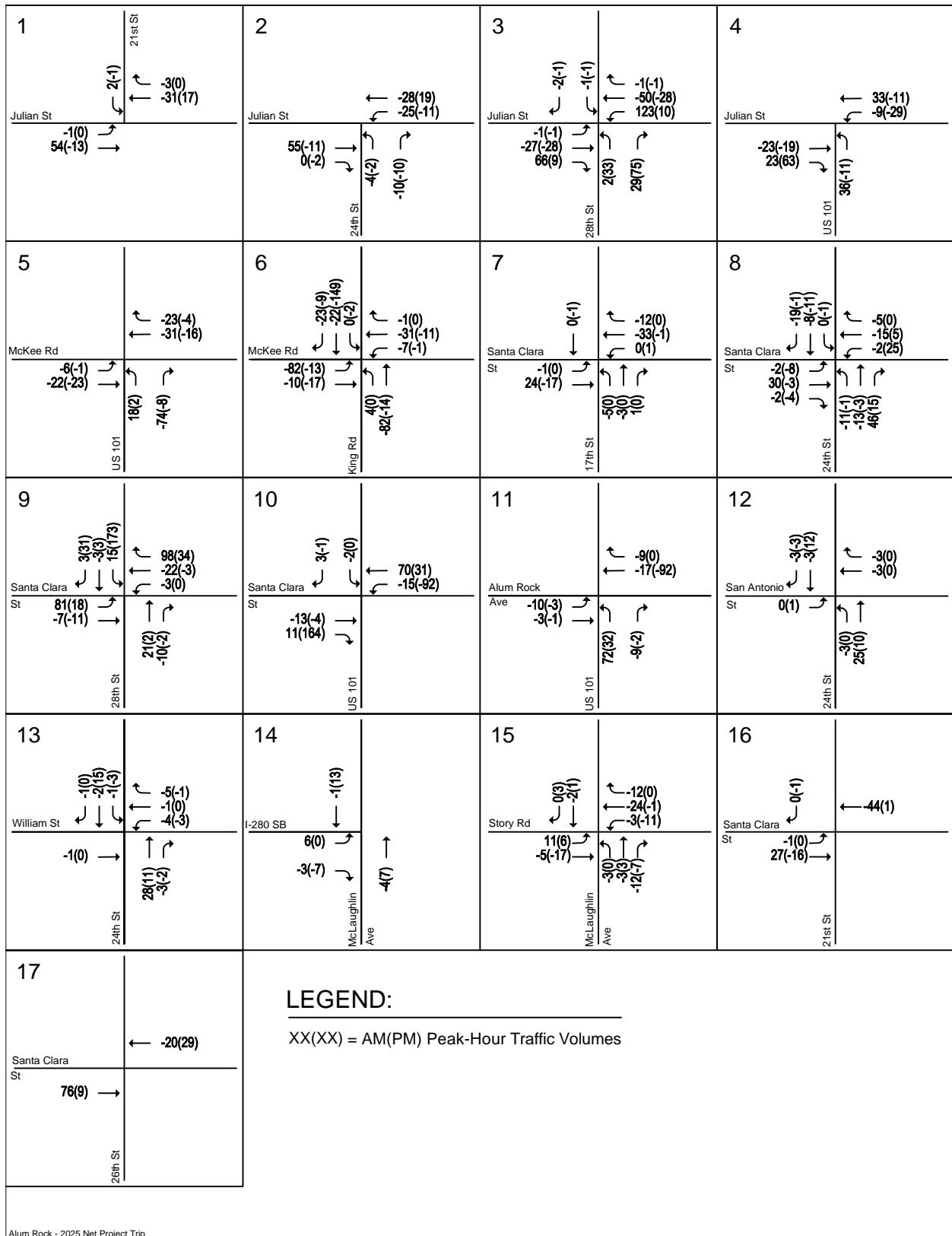

Figure 30
 2025 Phase II Project Conditions Net Project Trips – Alum Rock/28th Street Station

- However, a number of vehicles would be removed from the roadway network due to the proposed project. Vehicles that would use the US 101/East Julian Street intersection to/from US 101 may instead take transit, walk, or bike to the Alum Rock/28th Street Station to access BART and would no longer be on the roadway network. Additionally, vehicles that would use US 101 and East Julian Street to access businesses or retail in the vicinity of the Alum Rock/28th Street Station would instead use BART to access the area around the station. It is projected that 49 vehicles making a westbound through movement and 11 vehicles making a northbound left-turn movement at the US 101/East Julian Street intersection under the Year 2025 Phase II Project conditions would be removed from the roadway network due to the proposed project.
- Summing the additional traffic associated with accessing the station with the reduction in traffic associated with mode shift to BART or other transit results in the total net project trips. For the intersection of US 101 and East Julian Street, the project results in a net increase of 33 vehicles ($+82 - 49 = 33$) for the westbound through movement, and a net increase of 36 vehicles ($+47 - 11 = +36$) for the northbound left-turn movement under Year 2025 Phase II Project Conditions. This is illustrated on Figure 30.
- Summing the net project traffic with the baseline (Year 2025 No Project/Phase I) traffic volumes results in the with Phase II Project traffic volume total. For the example location, under Year 2025 Phase II Project conditions, there would be 1,310 westbound through movements ($1,277 + 33 = 1,310$) and 142 northbound left-turn movements ($106 + 36 = 142$) during the AM peak hour. See Figure 31 for Year 2025 Phase II Project conditions volumes.

This methodology was repeated at all study intersections for all analysis scenarios. At some locations, particularly for those movements leading directly to the station area, the number of vehicles accessing the station is larger than the number of vehicles shifted from the roadway network to transit modes, and the project results in a net increase in traffic volumes. At many locations, particularly for those movements either not leading to the station area or leading to freeways, the number of vehicles shifted from the roadway network to transit modes is greater than the number of vehicles using that movement to access the station, and the project results in a net decrease in traffic volumes.

2025 Phase II Project Conditions Traffic Volumes

Traffic volumes for the Year 2025 Phase II Project conditions were obtained by adding to the Year 2025 No Project/Phase I traffic volumes, the traffic projected to be generated by the proposed BART Stations (net project trips, as described above). The net project traffic projections under the Year 2025 Phase II Project conditions were obtained from the VTA Model. The Year 2025 Phase II Project conditions traffic volumes are presented on Figure 31 and included in Appendix D.

2025 Phase II Project Conditions Intersection Levels of Service

The results of the level of service analysis for the Alum Rock/28th Street Station under the Year 2025 Phase II Project conditions are summarized in Table 26. The results show that the same study intersections identified to operate at unacceptable levels under Year 2025 No Project/Phase I conditions are projected to continue to operate at unacceptable levels of service during at least one peak hour (see Figure 32).

- (4) US 101 and East Julian Street (LOS E – PM peak hour)
- (6) King Road and McKee Road (LOS E – AM and PM peak hours)

However, based on City of San Jose and CMP level of service impact criteria, the proposed project would not cause an adverse impact that would exceed the significance thresholds at any of the study intersections in the vicinity of the Alum Rock/28th Street Station. Therefore, no mitigation is required. All other CMP and local San Jose study intersections are projected to operate at an acceptable level of service. The level of service calculation sheets for the Alum Rock/28th Street Station are included in Appendix E.

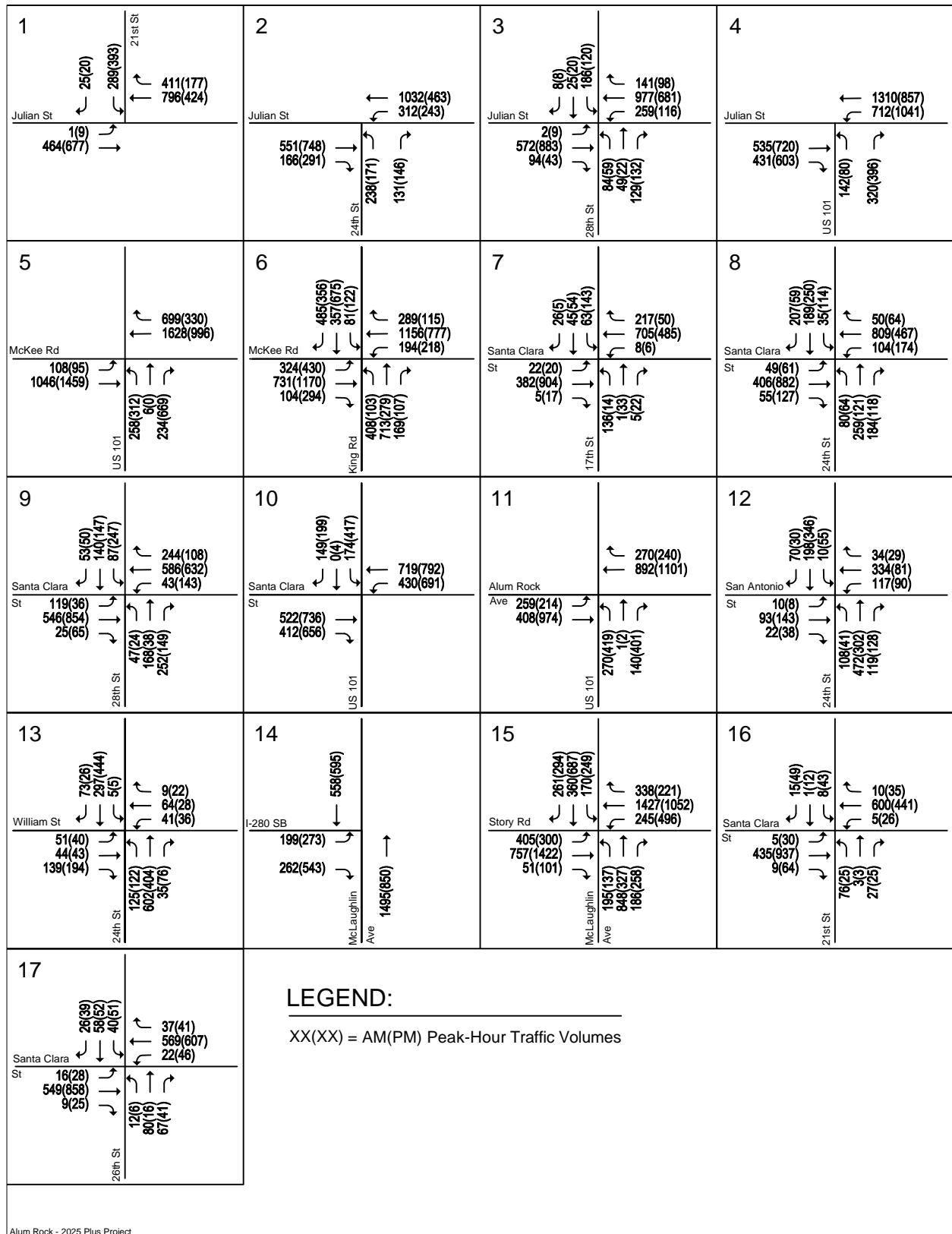

Figure 31
 2025 Phase II Project Conditions Traffic Volumes – Alum Rock/28th Street Station

Table 26
2025 Phase II Project Conditions Intersection Levels of Service - Alum Rock/28th Street Station

Study Number	Intersection	Peak Hour	2025 No Project		2025 Phase II Project			
			Avg. Delay	LOS	Avg. Delay	LOS	Incr. In Crit. Delay	Incr. In Crit. V/C
1	21st Street and East Julian Street	AM	22.4	C	20.1	C	-2.4	-0.019
		PM	12.5	B	12.4	B	-0.2	-0.009
2	24th Street and East Julian Street	AM	20.7	C	20.5	C	-0.3	0.014
		PM	20.9	C	20.0	B	-0.7	-0.015
3	North 28th Street and East Julian Street	AM	26.9	C	26.0	C	23.7	-0.014
		PM	17.6	B	19.9	B	1.0	-0.003
4	US 101 and East Julian Street	AM	24.4	C	25.8	C	2.3	0.017
		PM	68.1	E	67.0	E	-2.2	-0.012
5	US 101 and McKee Road	AM	20.7	C	20.7	C	0.7	-0.001
		PM	26.7	C	26.6	C	-0.2	-0.009
6	King Road and McKee Road	AM	73.4	E	66.4	E	-14.4	-0.049
		PM	64.2	E	56.7	E	-10.9	-0.052
7	17th Street and East Santa Clara Street	AM	20.0	B	20.3	C	0.2	-0.011
		PM	22.7	C	22.7	C	0.0	-0.006
8	24th Street and East Santa Clara Street	AM	21.1	C	20.8	C	-0.6	-0.025
		PM	22.9	C	23.3	C	0.6	0.006
9	North 28th Street and East Santa Clara Street	AM	21.4	C	22.6	C	2.2	0.053
		PM	18.6	B	21.4	C	3.7	0.107
10	US 101 and East Santa Clara Street*	AM	13.0	B	12.7	B	0.0	0.001
		PM	19.7	B	21.0	C	3.7	0.074
11	US 101 and Alum Rock Avenue*	AM	12.5	B	12.5	B	0.2	0.015
		PM	17.0	B	16.9	B	-0.3	-0.030
12	24th Street and San Antonio Street	AM	17.6	B	17.8	B	0.2	0.012
		PM	12.2	B	12.2	B	-0.1	0.006
13	24th Street and East William Street	AM	17.0	B	16.8	B	-0.2	0.016
		PM	19.5	B	19.4	B	-0.1	0.009
14	McLaughlin Avenue and I-280 SB*	AM	9.7	A	9.8	A	0.2	0.003
		PM	14.4	B	14.3	B	-0.1	0.000
15	McLaughlin Avenue and Story Road	AM	44.2	D	44.2	D	0.1	-0.002
		PM	50.2	D	50.0	D	-0.6	-0.011
16	21st Street and East Santa Clara Street	AM	5.8	A	5.9	A	0.3	-0.013
		PM	4.9	A	4.9	A	0.0	-0.005
17	26th Street and East Santa Clara Street	AM	16.8	B	16.8	B	0.2	-0.006
		PM	14.2	B	14.0	B	0.0	0.003

* Denotes CMP Intersection

Entries denoted in **bold** indicate conditions that exceed the applicable level of service standard.



Figure 32
2025 Phase II Project Conditions Deficient LOS Intersections – Alum Rock/28th Street Station

2025 Phase II Project Conditions Freeway Segment Levels of Service

Traffic volumes for the Year 2025 Phase II Project conditions for the study freeway segments were obtained from the VTA Model. These volumes represent traffic projections for the year 2025 with the addition of planned improvements and the Phase II Project and proposed stations. Note that the project would result in a decrease in traffic volumes on the freeway network as commuters use BART as an alternative to regional freeway travel. While a portion of traffic accessing the station areas would use the freeway network to do so, generally those trips are already on the freeway network and do not represent an increase in traffic from Year 2025 No Project/Phase I conditions. However, a number of others accessing the station would do so via transit or local streets, and therefore would result in a net reduction in freeway volumes. The net reduction in peak hour freeway volumes along the study freeway segments as a result of the implementation of the Phase II Project and the Alum Rock/28th Street Station are presented in Table 27.

The results of the freeway analysis are summarized in Table 27. The results show that 12 of the 20 directional freeway segments (and 4 HOV segments) analyzed for the Alum Rock/28th Street Station would operate at an unacceptable LOS F during at least one of the peak hours. Since the project would not add traffic representing one percent or more of the segment's capacity to any of the study freeway segments projected to operate at LOS F (including HOV segments), the project would not cause an adverse impact that would exceed the significance thresholds on any of the freeway segments analyzed under the Year 2025 Phase II Project conditions according to VTA CMP level of service impact criteria for freeways. Therefore, no mitigation is required.

2025 Phase II Project Conditions Freeway Ramp Analysis

The results of the freeway ramp analysis under Year 2025 Phase II Project conditions are described below and summarized in Table 28.

Freeway Ramp Lane Geometrics

The ramp lane geometrics were assumed to remain the same as described under Year 2025 No Project/Phase I conditions.

Freeway Ramp Volumes

All freeway ramp traffic volumes were calculated from the projected turn-movement volumes at the adjacent ramp intersections, as described under Year 2025 No Project/Phase I conditions.

Freeway Ramp Queue Lengths

Based on the projected queue lengths obtained from TRAFFIX, it was determined that the available queue storage space for the freeway off-ramps studied would be sufficient to serve the projected demand under Year 2025 Phase II Project conditions. The proposed project is projected to increase queue lengths at the study off-ramps by no more than 4 vehicles during the peak hours.

The queue length projections for the freeway on-ramps show that the on-ramps studied would experience excessive queue lengths that would spill out of the ramps onto the adjacent street under Year 2025 No Project/Phase I conditions and the proposed project is projected to increase the queue length under Year 2025 Phase II Project conditions. This is the result of the of the projected on-ramp demand exceeding the assumed ramp capacity.

The queuing analysis shows that under Year 2025 Phase II Project conditions, the queue length at the US 101 southbound on-ramp at McKee Road is projected to increase by 34 vehicles and the queue length at the US 101 southbound on-ramp at Santa Clara Street is projected to increase by 72 vehicles during the PM peak hour. Therefore, under Year 2025 Phase II Project conditions, the vehicular queue at the US 101 southbound on-ramp at McKee Road is projected to extend out of the ramp by approximately 712 vehicles during the PM peak hour, while the queue at the US 101 southbound on-ramp at Santa

Table 27
2025 Phase II Project Conditions Freeway Levels of Service - Alum Rock/28th Street Station

Freeway Segment		2025 Phase II Project Conditions														Net Project Trips			
		Direction	Peak Hour	Mixed-Flow Lane						HOV Lane						Mixed-Flow Lane		HOV Lane	
				Avg. Speed	# of Lanes	Capacity	Project Volume	Density	LOS	Avg. Speed	# of Lanes	Capacity	Project Volume	Density	LOS	Volume	% of Capacity	Volume	% of Capacity
US 101	Tully to Story	NB	AM	25.0	3.0	6,900	8,682	116	F	15.0	1.0	1,650	1,979	132	F	-100	-1.45	-52	-3.15
			PM	66.0	3.0	6,900	7,547	38	D	70.0	1.0	1,650	1,159	17	B	-22	-0.32	-21	-1.27
US 101	Story to I-280	NB	AM	22.0	3.0	6,900	5,070	77	F	19.0	1.0	1,650	1,483	78	F	-28	-0.41	-45	-2.73
			PM	67.0	3.0	6,900	3,740	19	C	70.0	1.0	1,650	748	11	A	-11	-0.16	-8	-0.48
US 101	I-280 to Santa Clara	NB	AM	13.0	3.0	6,900	7,544	193	F	13.0	1.0	1,650	1,711	132	F	-70	-1.01	-50	-3.03
			PM	66.0	3.0	6,900	5,401	27	D	70.0	1.0	1,650	799	11	A	-27	-0.39	-9	-0.55
US 101	Santa Clara to McKee	NB	AM	11.0	3.0	6,900	7,765	235	F	16.0	1.0	1,650	1,483	93	F	-156	-2.26	-44	-2.67
			PM	66.0	3.0	6,900	5,282	27	D	70.0	1.0	1,650	710	10	A	-58	-0.84	-9	-0.55
I-280	10th to McLaughlin	EB	AM	66.0	4.0	9,200	7,502	28	D	---	---	---	---	---	---	-133	-1.45	---	---
			PM	54.0	4.0	9,200	10,106	47	E	---	---	---	---	---	---	-134	-1.46	---	---
I-280	McLaughlin to US 101	EB	AM	66.0	4.0	9,200	5,524	21	C	---	---	---	---	---	---	-129	-1.40	---	---
			PM	54.0	4.0	9,200	6,713	31	D	---	---	---	---	---	---	-103	-1.12	---	---
I-680	US 101 to King	NB	AM	33.0	4.0	9,200	5,459	41	D	---	---	---	---	---	---	-124	-1.35	---	---
			PM	66.0	4.0	9,200	6,509	25	C	---	---	---	---	---	---	-96	-1.04	---	---
I-680	King to Capitol	NB	AM	20.0	5.0	11,500	7,620	76	F	55.0	1.0	1,650	415	8	A	-106	-0.92	-8	-0.48
			PM	47.0	5.0	11,500	9,656	41	D	55.0	1.0	1,650	365	7	A	-89	-0.77	-21	-1.27
I-680	Capitol to Alum Rock	NB	AM	18.0	4.0	9,200	6,135	85	F	55.0	1.0	1,650	415	8	A	-108	-1.17	-8	-0.48
			PM	65.0	4.0	9,200	6,391	25	C	55.0	1.0	1,650	365	7	A	-59	-0.64	-21	-1.27
I-680	Alum Rock to McKee	NB	AM	27.0	4.0	9,200	7,119	66	F	55.0	1.0	1,650	609	11	A	-123	-1.34	-10	-0.61
			PM	66.0	4.0	9,200	6,916	26	C	55.0	1.0	1,650	471	9	A	-59	-0.64	-24	-1.45
I-680	McKee to Alum Rock	SB	AM	63.0	4.0	9,200	6,675	26	C	55.0	1.0	1,650	461	8	A	-77	-0.84	-32	-1.94
			PM	47.0	4.0	9,200	7,320	39	D	55.0	1.0	1,650	493	9	A	-100	-1.09	-7	-0.42
I-680	Alum Rock to Capitol	SB	AM	23.0	4.0	9,200	6,427	70	F	55.0	1.0	1,650	461	8	A	-86	-0.93	-32	-1.94
			PM	65.0	4.0	9,200	5,600	22	C	55.0	1.0	1,650	493	9	A	-83	-0.90	-7	-0.42
I-680	Capitol to King	SB	AM	21.0	4.0	9,200	9,444	112	F	55.0	1.0	1,650	325	6	A	-134	-1.46	-31	-1.88
			PM	66.0	4.0	9,200	7,619	29	D	55.0	1.0	1,650	219	4	A	-91	-0.99	-4	-0.24
I-680	King to US 101	SB	AM	12.0	4.0	9,200	6,439	134	F	---	---	---	---	---	---	-166	-1.80	---	---
			PM	66.0	4.0	9,200	5,224	20	C	---	---	---	---	---	---	-106	-1.15	---	---
I-280	US 101 to McLaughlin	WB	AM	14.0	4.0	9,200	6,439	115	F	---	---	---	---	---	---	-166	-1.80	---	---
			PM	66.0	4.0	9,200	5,224	20	C	---	---	---	---	---	---	-106	-1.15	---	---
I-280	McLaughlin to 10th	WB	AM	19.0	4.0	9,200	10,443	137	F	---	---	---	---	---	---	-257	-2.79	---	---
			PM	65.0	4.0	9,200	7,969	31	D	---	---	---	---	---	---	-43	-0.47	---	---
US 101	McKee to Santa Clara	SB	AM	67.0	3.0	6,900	4,856	24	C	67.0	1.0	1,650	576	9	A	-20	-0.29	-9	-0.55
			PM	62.0	3.0	6,900	6,874	37	D	70.0	1.0	1,650	1,536	22	C	-9	-0.13	-21	-1.27
US 101	Santa Clara to I-280	SB	AM	67.0	3.0	6,900	5,470	27	D	67.0	1.0	1,650	642	10	A	-26	-0.38	-9	-0.55
			PM	63.0	3.0	6,900	7,366	39	D	70.0	1.0	1,650	1,645	24	C	-71	-1.03	-26	-1.58
US 101	I-280 to Story	SB	AM	67.0	3.0	6,900	3,577	18	B	67.0	1.0	1,650	565	8	A	-9	-0.13	-7	-0.42
			PM	54.0	3.0	6,900	5,043	31	D	70.0	1.0	1,650	1,255	18	B	-5	-0.07	-21	-1.27
US 101	Story to Tully	SB	AM	66.0	4.0	9,200	8,142	31	D	67.0	1.0	1,650	841	13	B	-33	-0.36	-10	-0.61
			PM	45.0	4.0	9,200	9,982	55	E	70.0	1.0	1,650	1,583	23	C	-37	-0.40	-28	-1.70

Source: Santa Clara Valley Transportation Authority Congestion Management Program Monitoring Study, 2014.
 The average speed for future HOV lanes are assumed to be 55 MPH.
Bold indicates unacceptable LOS.

Table 28
2025 Phase II Project Conditions Freeway Ramp Queuing Analysis

Freeway Ramp	Total Storage (Vehicle) ¹	Volume and Queue Projections (Vehicles)		
		2025 No Project	2025 Phase II Project	Change
<u>US 101 at McKee Road Interchange</u>				
US 101 SB On-Ramp at McKee Road	32			
PM Volume ²		1610	1644	34
Projected Queue Length ³		710	744	34
US 101 SB Loop Off-Ramp at McKee Road	92			
AM Volume ²		426	462	36
Projected Queue Length ⁴		27	30	3
<u>US 101 at Santa Clara Street/Alum Rock Avenue Interchange</u>				
US 101 SB On-Ramp at Santa Clara Street	34			
PM Volume ²		1279	1351	72
Projected Queue Length ³		379	451	72
US 101 NB Off-Ramp at Alum Rock Avenue	67			
AM Volume ²		348	411	63
Projected Queue Length ⁴		14	18	4
PM Volume ²		792	822	30
Projected Queue Length ⁴		32	33	1
Notes:				
¹ Total number of vehicles that can store within the ramp.				
² Peak-hour ramp volume projections.				
³ Total number of vehicles in the queue, as calculated based on the ramp meter rate and projected traffic volumes.				
⁴ Total number of vehicles in the queue, as obtained from TRAFFIX.				
Bold queue lengths exceed the available queue storage capacity within the ramp.				

Clara Street is projected to extend out of the ramp by approximately 417 vehicles during the PM peak hour. The AM peak hour queue lengths at these ramps would not be affected by the proposed project.

The available queue storage capacity at the study freeway on-ramps would be inadequate to serve the projected queue length under Year 2025 No Project/Phase I conditions and the proposed Phase II Project would worsen the projected deficiency under Year 2025 Phase II Project conditions. However, it should be noted that these projections assume a very conservative meter rate of 900 vph for the entire peak hour analyzed. If the future meter rate at these locations is greater than the assumed 900 vph, the projected demand on these ramps would be dissipated faster and the projected queues would be shorter. Alternatively, setting the ramp meter rate to allow no more than 900 vph could potentially result in peak-hour spreading (drivers accessing these ramps before or after the peak hour to avoid the long queues), use of alternative freeway ramps, and/or use of alternative modes of transportation, such as walk/bike/public transportation.

Bicycle, Pedestrian, and Transit Facilities Analyses

With the proposed project, a pedestrian connection along the south side of the Alum Rock/28th Street Station area at North 28th Street from East Santa Clara Street would be provided. This pedestrian connection, which would include such amenities as street trees, wide sidewalks, bicycle facilities, and pedestrian-scaled lighting, would link the station entrances with buses and BRT operating on East Santa Clara Street/Alum Rock Avenue, enhancing connectivity of pedestrian facilities surrounding the station. Additionally, the project would add sidewalks around the perimeter of the Alum Rock/28th Street Station and the west side of 28th Street from the station entrance to Santa Clara Street. Crosswalks at the signalized intersections of North 28th Street/East St. James Street and North 28th Street/Five Wounds Lane would also be provided, including pedestrian push buttons and signal heads. In combination with planned pedestrian/bicycle improvements in the study area, the project-sponsored pedestrian/bicycle improvements would help enhance pedestrian/bicycle facilities in the area. Therefore, the Phase II Project would improve connectivity and would not result in any significant impacts on bicycle and pedestrian circulation. No mitigation measures are required.

The Phase II Project *is* a transit project and therefore represents a substantial improvement to the transit system in the study area. Additionally, the Phase II Project is being integrated with VTA's light rail and bus systems and would not adversely impact transit facilities or services within the Cities of San Jose and Santa Clara in the vicinity of the BART extension or the proposed BART stations.

5. Year 2025 Phase II Project Conditions – Diridon Station

This chapter describes traffic conditions in the year 2025 with the proposed Phase II Project. The Diridon Station is one of the four stations proposed along the Phase II Project corridor that would provide for the extension of BART service to the Cities of San Jose and Santa Clara (see Figure 1). Year 2025 Phase II Project conditions analyzed traffic conditions for the year 2025 (opening day of the project) in the vicinity of the Diridon Station with the addition of the proposed four BART Stations. The analysis includes intersection and freeway segment level of service analysis.

A detailed description of the method used to estimate station-generated traffic is included in Chapter 4 of this report. Estimates of the station-generated traffic, identification of impacts, and recommended mitigation measures for the Diridon Station under Year 2025 Phase II Project conditions are included within this chapter. Year 2025 Phase II Project conditions were evaluated relative to Year 2025 No Project/Phase I conditions in order to determine potential project impacts on the future transportation network. The significant impact criteria are discussed in Chapter 1 of this report.

Although some of the information provided below on intersection and freeway analysis methodology has already been described in previous chapters, it is presented again within this chapter for the reader's convenience.

Intersection and Freeway Analysis Methodology - All Stations

Trip Generation, Distribution and Assignment

As previously described, trip generation for the proposed stations was estimated based on passenger projections for the station obtained from the VTA Model. A detailed description of the method used to estimate station-generated traffic is included in Chapter 4. Actual trip generation estimates for the proposed Diridon Station under 2025 Phase II Project conditions are presented in subsequent sections within this chapter.

Distribution patterns and assignment of station-generated traffic (PNR and KNR trips) for the Year 2025 Phase II Project conditions were obtained from the VTA Model.

2025 Phase II Project Conditions Intersection Lane Configurations

The intersection lane configurations under the 2025 Phase II Project conditions were assumed to be the same as described under 2025 No Project/Phase I conditions.

2025 Phase II Project Conditions Intersection Traffic Volumes

Traffic volumes for the Year 2025 Phase II Project conditions were obtained from the VTA Model. These traffic volumes represent traffic projections for the year 2025 (opening day of the project) with the addition of planned improvements and the Phase II Project and proposed stations. Year 2025 Phase II Project conditions model volume forecasts were adjusted using the method previously described (Introduction chapter).

2025 Phase II Project Conditions Freeway Volumes

Traffic volumes for the Year 2025 Phase II Project conditions for the study freeway segments were obtained from the VTA Model. These volumes represent traffic projections for the year 2025 with the addition of planned improvements and the Phase II Project and proposed stations. Unlike intersection forecast volumes, no adjustments were made to the freeway volumes produced by the VTA Model since the freeway network contained in the VTA Model is represented more accurately than local roadways.

Station Description – Diridon Station

The proposed Diridon Station would be located between Los Gatos Creek (to the east) and the Diridon Caltrain Station (to the west) and south of/parallel to West Santa Clara Street (see Figure 3). There are two station location options for the Diridon Station: The South Option and the North Option, both of which would be located in the general area of the Diridon Caltrain Station and both of which would consist of an underground boarding platform level, a mezzanine level, and entrances at street-level portals. The South Option would be located midway between Santa Clara Street and Stover Street. The North Option would be located adjacent to, and just south of, Santa Clara Street. For purposes of analyzing traffic impacts, however, there would be no difference between the North and South options, so this TIA does not analyze the options separately.

The existing VTA bus transit center would be expanded to accommodate projected bus/shuttle transfers to and from the BART station. No PNR facilities would be provided at this station. A KNR facility would be located along Cahill Street.

Access to the station area would be provided from Cahill, North Montgomery, and North Autumn Streets via West Santa Clara Street from the north and San Fernando Street from the south. Street-level station entrance portals would provide pedestrian linkages to the Diridon Caltrain Station and SAP Center.

The Diridon Station site and the surrounding study area are shown on Figure 6.

Station Trip Generation Estimates – Diridon Station

The trip generation estimates for the proposed Diridon Station under the Year 2025 Phase II Project conditions were developed using the VTA Model and based on the method previously described. Ridership projections total about 7,220 daily BART riders (3,610 boardings and 3,610 alightings) at the Diridon Station under the Year 2025 Phase II Project conditions. Table 29 presents the daily and peak hour trip generation estimates for each of the drive access modes to the Diridon Station, described in the following sections.

Park-and-Ride Trips

No PNR facilities would be provided at the Diridon Station.

Kiss-and-Ride Trips

Model projections of passenger volumes for the Diridon Station indicate that 314 daily KNR trips would utilize the station under the year 2025 Phase II Project conditions scenario. Since KNR trips consist of vehicles entering the station site to drop off a BART commuter and then exiting the site and proceeding on to another destination, station trip generation estimates for peak hour inbound and outbound KNR

vehicle trips are equivalent. It is estimated that a total of 62 (31 inbound/31 outbound) KNR trips would occur during the AM peak hour and a total of 72 (36 inbound/36 outbound) KNR trips would occur during the PM peak hour.

Table 29
Diridon Station Trip Generation Estimates – 2025 Phase II Project Conditions

Mode of Access by Station	Daily Trips	Parking Demand (# of Spaces)	AM Peak Hour Trips			PM Peak Hour Trips		
			In	Out	Total	In	Out	Total
Diridon Station:								
Kiss and Ride Trips	314		31	31	62	36	36	72
Park and Ride Trips	0	0	0	0	0	0	0	0
Total	314		31	31	62	36	36	72

Source: VTA Model, December 2014.

Trip Distribution and Assignment

Distribution pattern and assignment of station-generated traffic (KNR trips) to the proposed Diridon Station under the Year 2025 Phase II Project conditions were developed from traffic assignments using the VTA Model. As mentioned previously, implementation of the proposed project would result in a shift in travel pattern, as the result of some commuters modifying their travel route to access the station area, and in the removal of auto trips from the roadway network, as some commuters shift from auto to transit modes of travel. Thus, station-generated traffic consists of two components: 1.) new vehicular trips accessing the proposed Diridon Station, referred to as *station drive access* trips, and 2.) all the trips that would no longer be on the roadway as a result of the Phase II Project, represented by negative trips on the roadway network. It is projected that under Year 2025 Phase II Project conditions, approximately 950 and 800 AM and PM peak-hour trips, respectively, would be removed from the roadway transportation system as the result of the Phase II Project and proposed Stations. The total *net project trips* generated by the Diridon Station are therefore calculated by adding the new station drive access trips (positive trips) and the trips removed from the roadway network as a result of the Diridon Station and Phase II Project (negative trips). The Diridon Station drive access trips for the Year 2025 Phase II Project conditions are shown graphically on Figure 33 while the net project trips are shown on Figure 34.

An example of the trip assignment process and method used to estimate traffic with the project is presented in Chapter 4.

The trip assignment process shows that at some locations, particularly for those movements leading directly to the station area, the number of vehicles accessing the station is larger than the number of vehicles shifted from the roadway network to transit modes, thus, the project results in a net increase in traffic volumes. At many locations, particularly for those movements either not leading to the station area or leading to freeways, the number of vehicles shifted from the roadway network to transit modes is greater than the number of vehicles using that movement to access the station, and the project results in a net decrease in traffic volumes.

2025 Phase II Project Conditions Traffic Volumes

Traffic volumes for the Year 2025 Phase II Project conditions were obtained by adding to the Year 2025 No Project/Phase I traffic volumes, the traffic projected to be generated by the proposed BART Stations (net project trips, as described above). The net project traffic projections under the Year 2025 Phase II Project conditions were obtained from the VTA Model. The Year 2025 Phase II Project conditions traffic volumes are presented on Figure 35 and included in Appendix D.

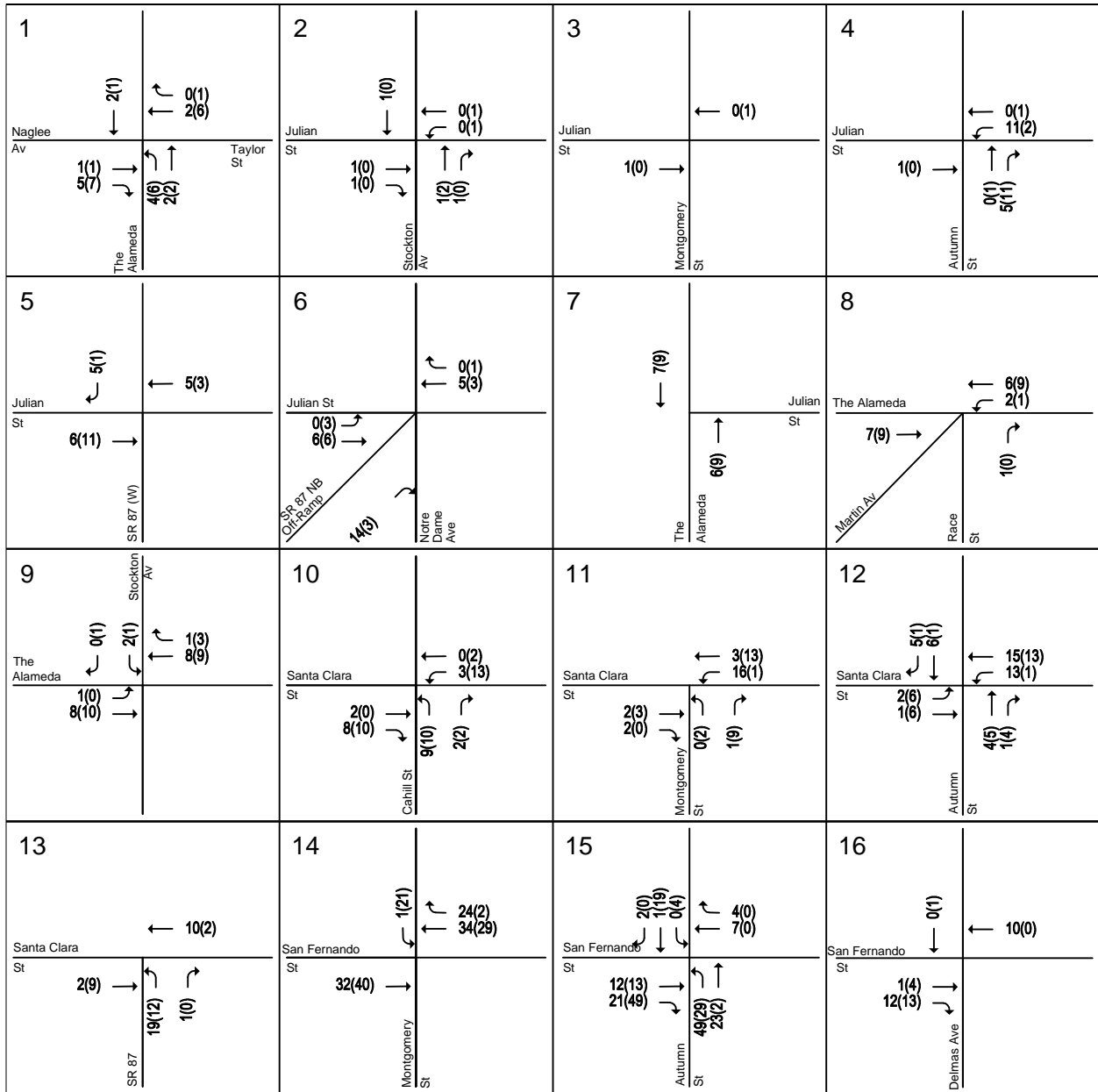

LEGEND:

XX(XX) = AM(PM) Peak-Hour Traffic Volumes

Diridon - 2025 Drive Access Trip

Figure 33
2025 Phase II Project Conditions Station (Drive Access) Trips – Diridon Station

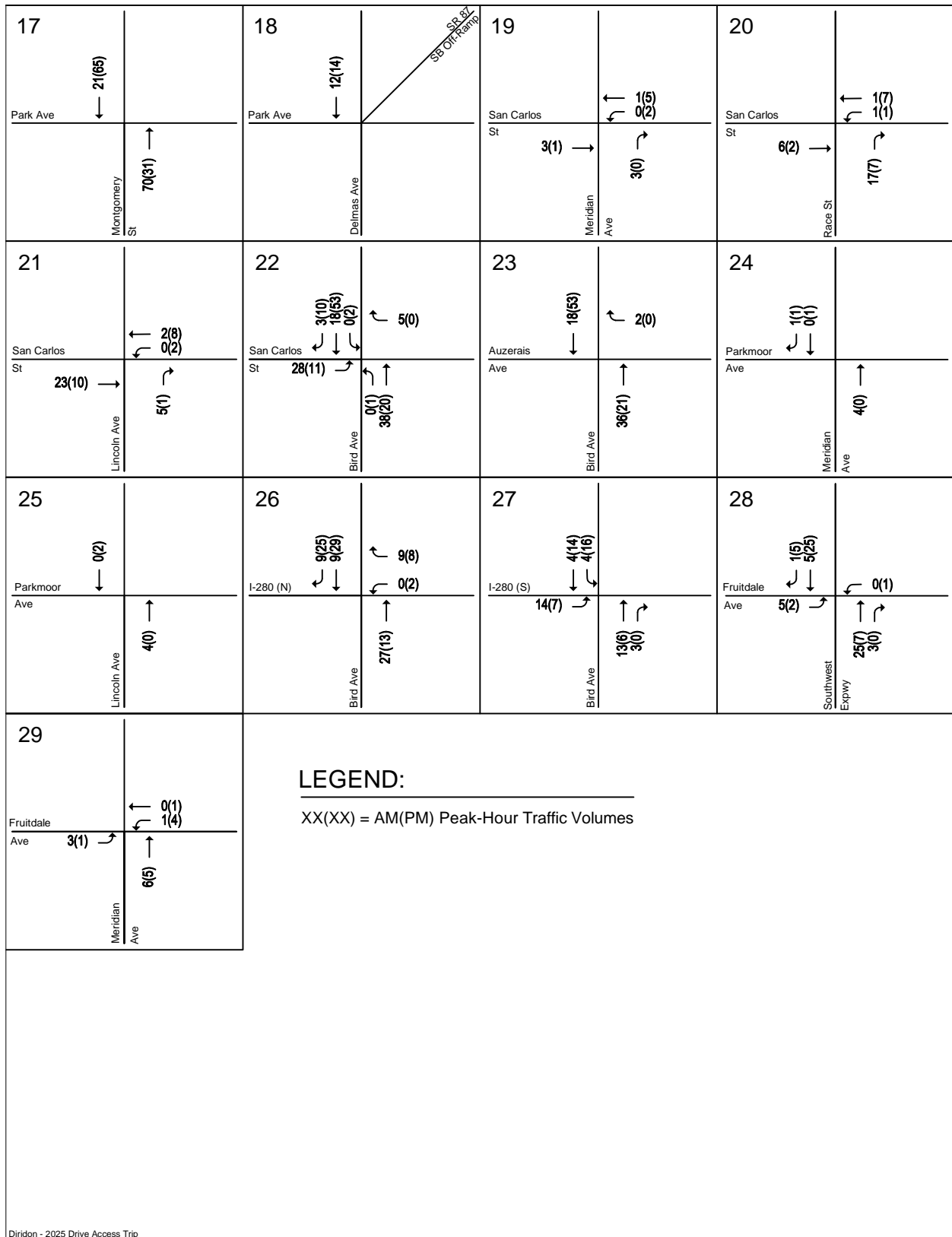
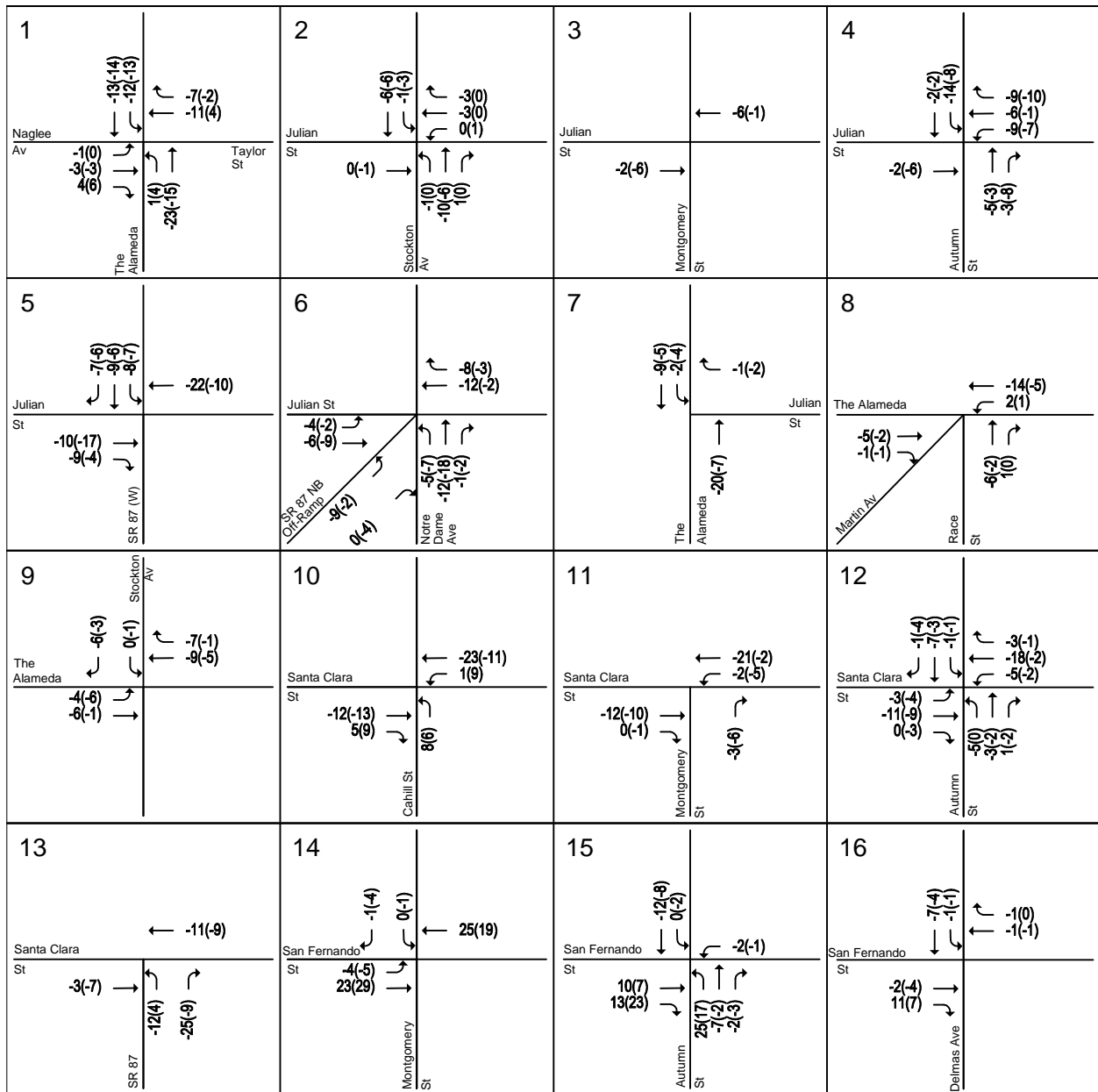

Figure 33 (Continued)
2025 Phase II Project Conditions Station (Drive Access) Trips – Diridon Station



LEGEND:

XX(X) = AM(PM) Peak-Hour Traffic Volumes

Diridon - 2025 Net Project Trip

Figure 34
2025 Phase II Project Conditions Net Project Trips – Diridon Station

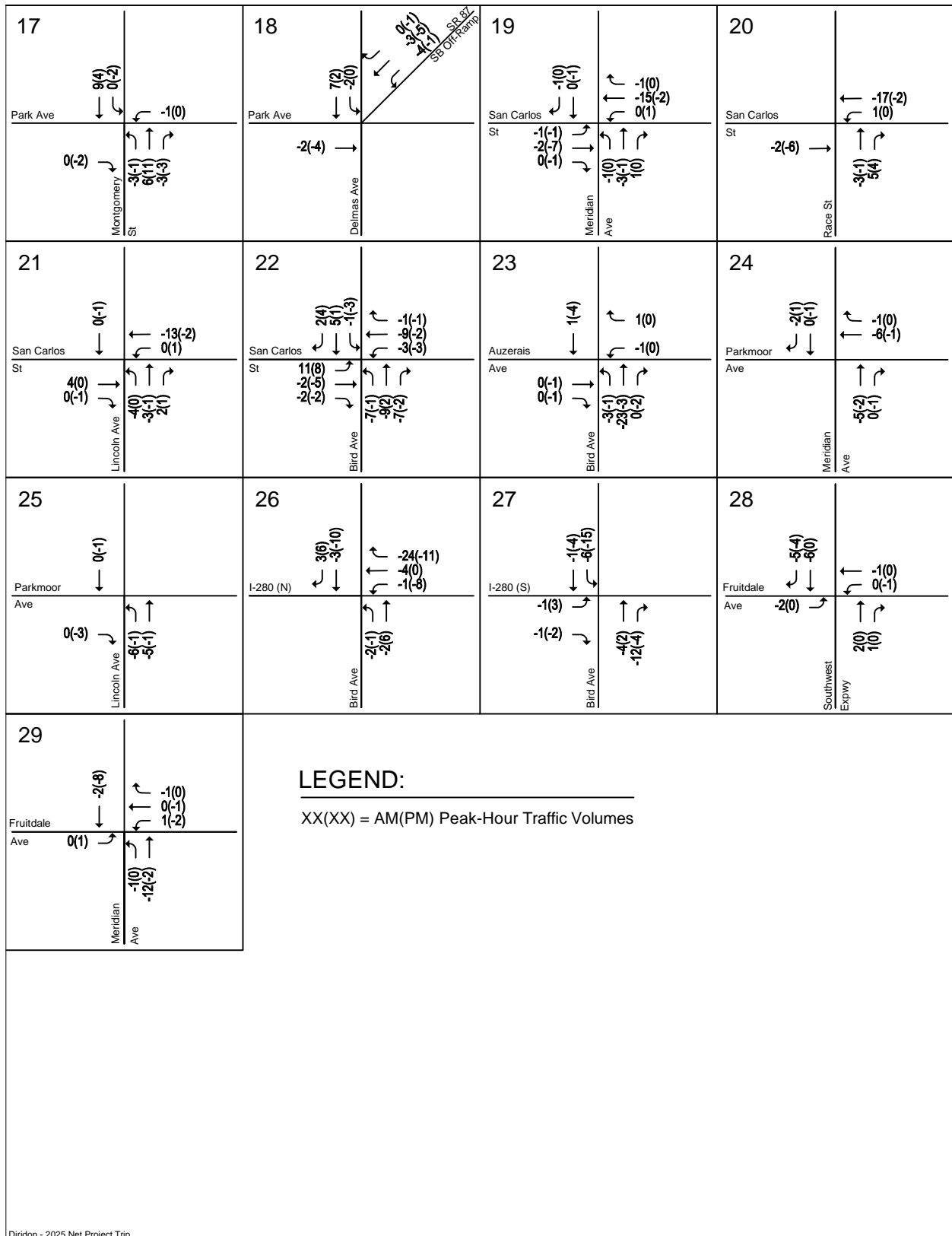

Diridon - 2025 Net Project Trips

Figure 34 (Continued)
2025 Phase II Project Conditions Net Project Trips – Diridon Station

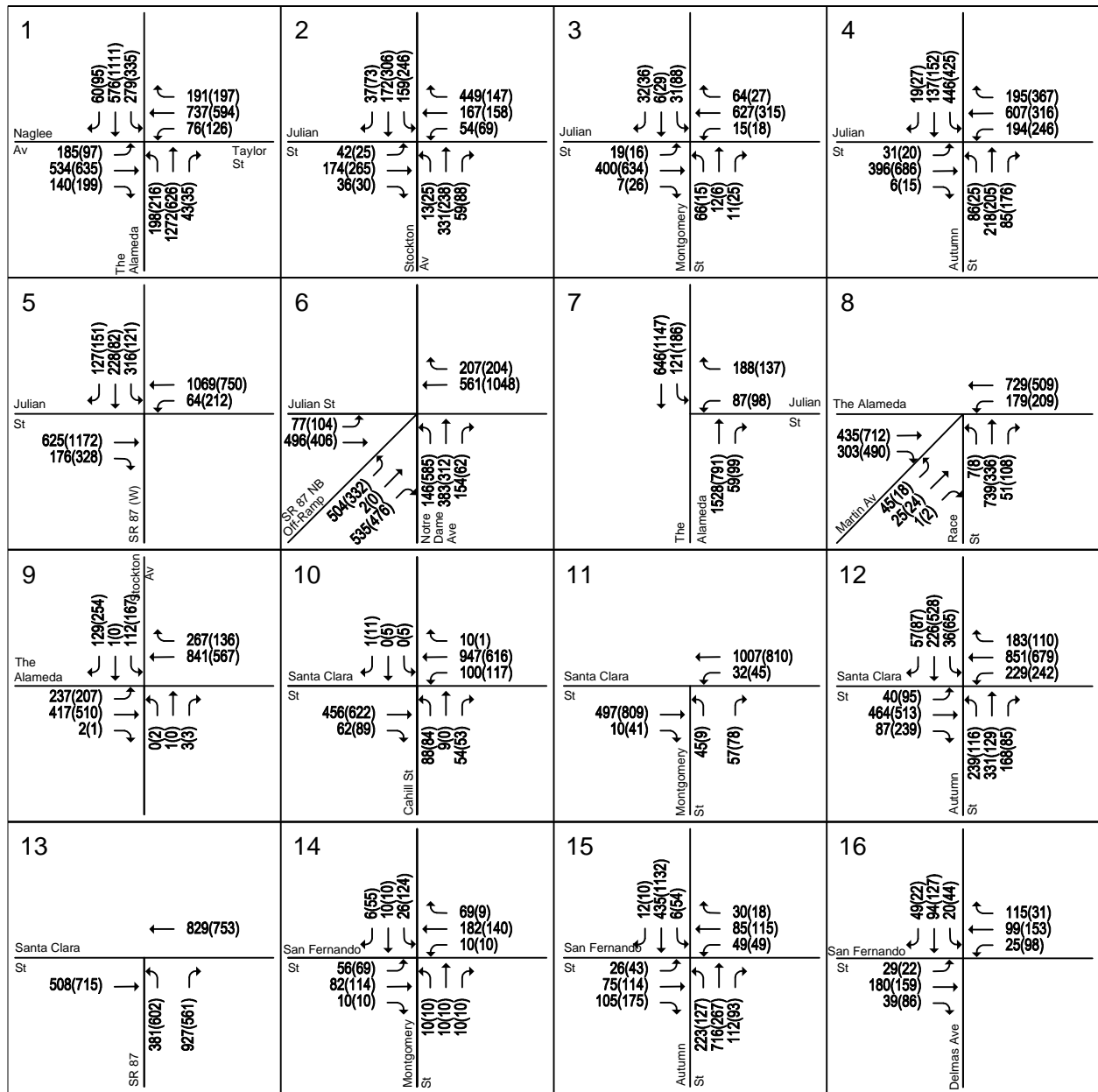

LEGEND:

XX(X) = AM(PM) Peak-Hour Traffic Volumes

Diridon - 2025 Plus Project

Figure 35
2025 Phase II Project Conditions Traffic Volumes – Diridon Station

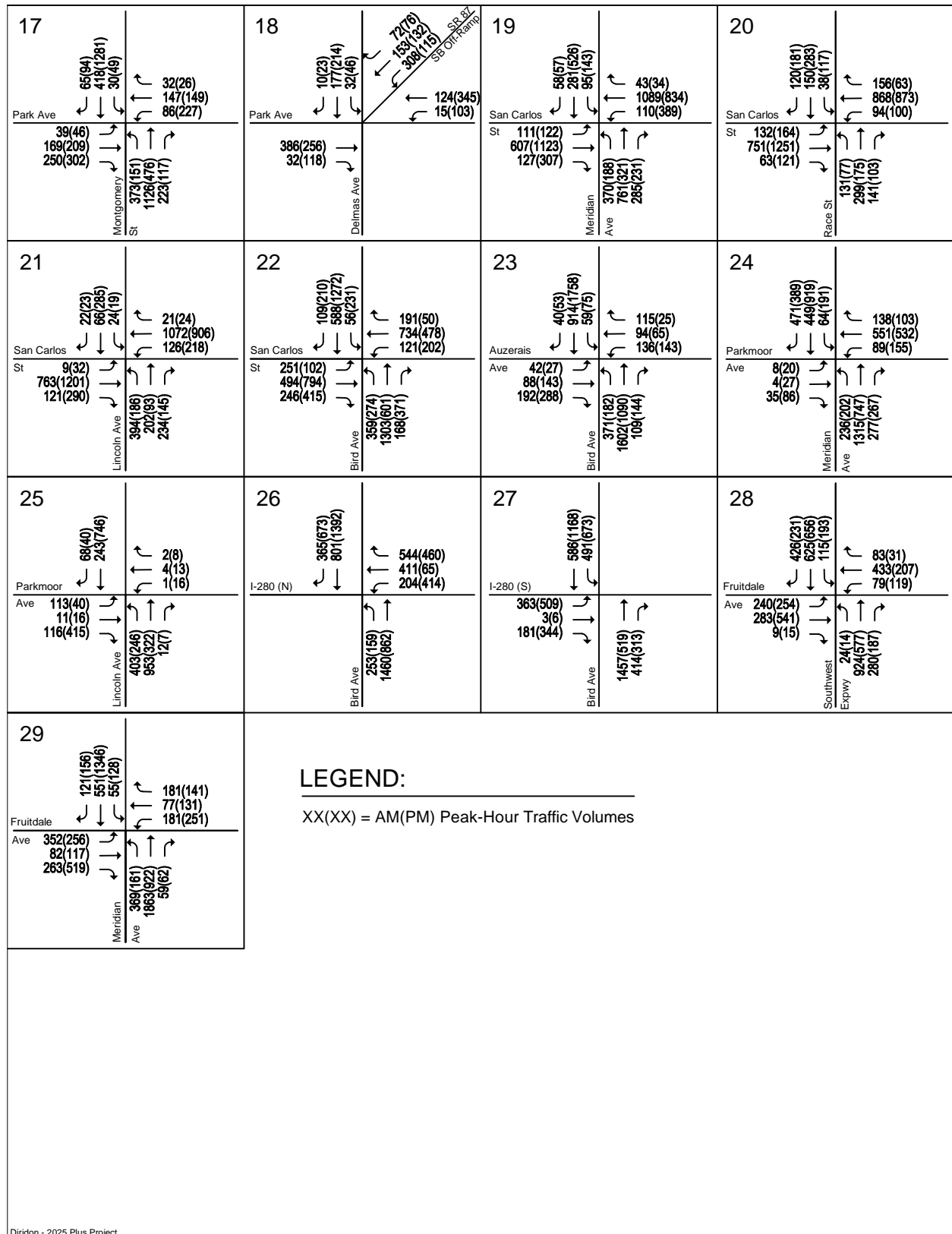

Diridon - 2025 Plus Project

Figure 35 (Continued)
 2025 Phase II Project Conditions Traffic Volumes – Diridon Station

2025 Phase II Project Conditions Intersection Levels of Service

The results of the level of service analysis for the Diridon Station under the Year 2025 Phase II Project conditions are summarized in Table 30. The results show that the same study intersections identified to operate at unacceptable levels under Year 2025 No Project/Phase I conditions are projected to continue to operate at unacceptable levels of service during one or both peak hours (see Figure 36).

- (1) The Alameda and Taylor Street/Naglee Avenue* (LOS E – AM peak hour)
- (29) Meridian Avenue and Fruitdale Avenue (LOS E – AM and PM peak hours)

However, based on City of San Jose and CMP level of service impact criteria, the proposed project would not cause an impact that would exceed the significance thresholds at any of the study intersections in the vicinity of the Diridon Station. Therefore, no mitigation is required. All other CMP and local San Jose study intersections are projected to operate at an acceptable level of service. The level of service calculation sheets for the Diridon Station are included in Appendix F.

2025 Phase II Project Conditions Freeway Segment Levels of Service

Traffic volumes for the Year 2025 Phase II Project conditions for the study freeway segments were obtained from the VTA Model. These volumes represent traffic projections for the year 2025 with the addition of planned improvements and the Phase II Project and proposed stations. Note that the project would result in a decrease in traffic volumes on the freeway network, as commuters use BART as an alternative to regional freeway travel. While a portion of traffic accessing the station areas would use the freeway network to do so, generally those trips are already on the freeway network and do not represent an increase in traffic from Year 2025 No Project/Phase I conditions. However, a number of others accessing the station would do so via transit or local streets, and therefore would result in a net reduction in freeway volumes. The net reduction in peak hour freeway volumes along the study freeway segments as a result of the implementation of the Phase II Project and the Diridon Station are presented in Table 31.

The results of the freeway analysis are summarized in Table 31. The results show that 17 of the 18 directional freeway segments (and 1 HOV segment) analyzed for the Diridon Station would operate at an unacceptable LOS F during at least one of the peak hours. Since the project would not add traffic representing one percent or more of the segment's capacity to any of the study freeway segments projected to operate at LOS F (including HOV segments), the project would not cause an adverse impact that would exceed the significance thresholds on any of the freeway segments analyzed under the Year 2025 Phase II Project conditions according to VTA CMP level of service impact criteria for freeways. Therefore, no mitigation is required.

2025 Phase II Project Conditions Freeway Ramp Analysis

Based on the traffic volume projections obtained from the VTA Model, the Phase II Project is not projected to increase freeway ramp volumes by 10 or more peak-hour trips at any freeway ramp in the vicinity of the Diridon Station.

Bicycle, Pedestrian, and Transit Facilities Analyses

Street-level station entrance portals would provide pedestrian linkages to the Diridon Caltrain Station and SAP Center. Additionally, sidewalks are found along all local roadways in the Diridon Station study area and along the local residential streets and collectors near the station site. All signalized intersections in the vicinity of the Diridon Station have marked crosswalks on all or most of the legs of the intersection combined with pedestrian push buttons and pedestrian signal heads. In combination with planned pedestrian/bicycle improvements in the study area, the project-sponsored pedestrian/bicycle improvements would help enhance pedestrian/bicycle facilities in the area. Therefore, the Phase II Project

would not result in any significant impacts on bicycle and pedestrian circulation, and no mitigation measures are required.

The Phase II Project *is* a transit project and therefore represents a substantial improvement to the transit system in the study area. Additionally, the Phase II Project is being integrated with VTA's light rail and bus systems and would not adversely impact transit facilities or services within the Cities of San Jose and Santa Clara in the vicinity of the BART extension or the proposed BART stations.

Table 30
2025 Phase II Project Conditions Intersection Levels of Service - Diridon Station

Study Number	Intersection	Peak Hour	2025 No Project		2025 Phase II Project			
			Avg. Delay	LOS	Avg. Delay	LOS	Incr. In Crit. Delay	Incr. In Crit. V/C
1	The Alameda and Taylor Street/Naglee Avenue*	AM	64.9	E	62.1	E	-4.3	-0.020
		PM	50.4	D	50.3	D	0.1	-0.001
2	Stockton Avenue and West Julian Street	AM	36.5	D	36.1	D	-0.5	-0.009
		PM	34.5	C	34.5	C	-0.2	-0.006
3	North Montgomery Street and West Julian Street	AM	11.7	B	11.6	B	0.0	-0.004
		PM	12.6	B	12.6	B	0.0	-0.004
4	North Autumn Street and West Julian Street	AM	30.1	C	28.8	C	-1.6	-0.017
		PM	33.6	C	32.4	C	-1.6	-0.016
5	SR 87 (W) and West Julian Street*	AM	19.3	B	19.2	B	-0.2	-0.012
		PM	17.8	B	17.6	B	-0.1	-0.007
6	SR 87 (E) and West Julian Street*	AM	52.4	D	52.2	D	-0.3	-0.008
		PM	45.6	D	45.3	D	-0.3	-0.008
7	The Alameda and West Julian Street	AM	20.1	C	20.0	C	-0.2	-0.008
		PM	18.8	B	18.7	B	-0.2	-0.006
8	Race Street/Martin Avenue and The Alameda*	AM	38.5	D	38.5	D	0.1	-0.001
		PM	32.0	C	32.0	C	0.0	-0.001
9	Stockton Avenue and The Alameda	AM	28.3	C	28.0	C	-0.5	-0.011
		PM	31.9	C	31.7	C	-0.3	-0.008
10	Cahill Street and West Santa Clara Street	AM	16.4	B	17.1	B	0.8	-0.002
		PM	17.7	B	18.6	B	1.1	0.008
11	South Montgomery Street and West Santa Clara Street*	AM	9.5	A	9.4	A	-0.1	-0.006
		PM	10.1	B	9.4	A	-0.9	-0.006
12	South Autumn Street and West Santa Clara Street*	AM	32.9	C	32.7	C	-0.1	-0.010
		PM	36.2	D	36.1	D	-0.2	-0.005
13	SR 87 and West Santa Clara Street*	AM	18.6	B	18.5	B	-0.2	-0.012
		PM	17.4	B	17.4	B	0.0	-0.001
14	South Montgomery Street and San Fernando Street	AM	5.6	A	5.3	A	-0.3	0.015
		PM	10.4	B	10.2	B	0.1	0.012
15	South Autumn Street and San Fernando Street	AM	13.9	B	14.6	B	0.7	0.013
		PM	16.1	B	17.0	B	1.2	0.029
16	Delmas Avenue and San Fernando Street	AM	10.2	B	9.9	A	-0.2	-0.001
		PM	10.4	B	10.3	B	-0.1	-0.004
17	South Montgomery Street/Autumn Street and Park Avenue	AM	36.2	D	36.2	D	0.0	0.001
		PM	47.6	D	47.4	D	-0.2	-0.001
18	Delmas Avenue and Park Avenue	AM	24.7	C	24.8	C	0.0	-0.002
		PM	24.9	C	24.9	C	0.0	-0.006
19	Meridian Avenue and San Carlos Street	AM	41.1	D	41.0	D	-0.2	-0.006
		PM	49.3	D	49.2	D	0.0	-0.002
20	Race Street and San Carlos Street	AM	33.9	C	34.0	C	0.0	-0.007
		PM	36.0	D	36.0	D	0.0	-0.002
21	Lincoln Avenue and San Carlos Street	AM	36.0	D	35.9	D	-0.2	-0.006
		PM	44.0	D	44.0	D	0.0	0.000
22	Bird Avenue and San Carlos Street*	AM	39.9	D	40.1	D	0.3	0.001
		PM	49.4	D	49.1	D	-0.5	-0.002
23	Bird Avenue and Auzerais Avenue	AM	29.9	C	30.0	C	-0.1	-0.002
		PM	25.6	C	25.6	C	-0.1	-0.002
24	Meridian Avenue and Parkmoor Avenue	AM	32.9	C	32.8	C	-0.2	-0.003
		PM	39.6	D	39.6	D	0.0	-0.001
25	Lincoln Avenue and Parkmoor Avenue	AM	25.6	C	25.6	C	0.0	-0.004
		PM	42.9	D	42.8	D	-0.2	-0.003
26	Bird Avenue and I-280 (N)*	AM	34.8	C	34.4	C	-0.6	-0.009
		PM	27.1	C	26.8	C	-0.2	-0.003
27	Bird Avenue and I-280 (S)*	AM	31.5	C	31.2	C	-0.2	-0.005
		PM	32.1	C	31.6	C	-1.1	-0.013
28	Southwest Expressway and Fruitdale Avenue	AM	34.2	C	34.3	C	-1.8	0.020
		PM	33.8	C	33.7	C	0.0	-0.001
29	Meridian Avenue and Fruitdale Avenue	AM	58.5	E	58.1	E	-0.7	-0.004
		PM	57.1	E	56.9	E	-0.3	-0.003

* Denotes CMP Intersection
Entries denoted in **bold** indicate conditions that exceed the applicable level of service standard.



DIR Deficient LOS 2025 Plus Project

Figure 36
2025 Phase II Project Conditions Deficient LOS Intersections – Diridon Station

Table 31
2025 Phase II Project Conditions Freeway Levels of Service - Diridon Station

Freeway Segment		2025 Phase II Project Conditions														Net Project Trips			
		Direction	Peak Hour	Mixed-Flow Lane						HOV Lane						Mixed-Flow Lane		HOV Lane	
				Avg. Speed	# of Lanes	Capacity	Project Volume	Density	LOS	Avg. Speed	# of Lanes	Capacity	Project Volume	Density	LOS	Volume	% of Capacity	Volume	% of Capacity
SR 87	Curtner to Almaden Expressway	NB	AM	13.0	2.0	4,400	3,746	144	F	22.0	1.0	1,650	1,709	78	F	-26	-0.59	-27	-1.64
			PM	65.0	2.0	4,400	3,157	24	C	70.0	1.0	1,650	664	9	A	-4	-0.09	-5	-0.30
SR 87	Almaden Expressway to Alma	NB	AM	29.0	2.0	4,400	4,670	81	F	43.0	1.0	1,650	1,958	46	D	-30	-0.68	-35	-2.12
			PM	41.0	2.0	4,400	3,884	47	E	70.0	1.0	1,650	726	10	A	-6	-0.14	-5	-0.30
SR 87	Alma to I-280	NB	AM	33.0	2.0	4,400	5,613	85	F	61.0	1.0	1,650	1,982	32	D	-38	-0.86	-33	-2.00
			PM	66.0	2.0	4,400	4,355	33	D	70.0	1.0	1,650	790	11	A	-7	-0.16	-7	-0.42
SR 87	I-280 to Julian	NB	AM	16.0	2.0	4,400	3,301	103	F	30.0	1.0	1,650	1,294	43	D	-19	-0.43	-20	-1.21
			PM	67.0	2.0	4,400	1,794	13	B	70.0	1.0	1,650	396	6	A	-6	-0.14	-4	-0.24
SR 87	Julian to Coleman	NB	AM	14.0	2.0	4,400	4,544	162	F	32.0	1.0	1,650	1,517	47	E	-51	-1.16	-30	-1.82
			PM	67.0	2.0	4,400	2,720	20	C	70.0	1.0	1,650	520	7	A	-47	-1.07	-7	-0.42
I-280	I-880 to Meridian	EB	AM	66.0	4.0	9,200	6,402	24	C	67.0	1.0	1,650	514	8	A	-42	-0.46	-33	-2.00
			PM	17.0	4.0	9,200	6,846	101	F	20.0	1.0	1,650	824	41	D	-40	-0.43	-16	-0.97
I-280	Meridian to Bird	EB	AM	61.0	4.0	9,200	8,575	35	D	---	---	---	---	---	---	-76	-0.83	---	---
			PM	21.0	4.0	9,200	9,311	111	F	---	---	---	---	---	---	-56	-0.61	---	---
I-280	Bird to SR 87	EB	AM	66.0	4.0	9,200	4,636	18	B	---	---	---	---	---	---	-53	-0.58	---	---
			PM	25.0	4.0	9,200	5,932	59	F	---	---	---	---	---	---	-42	-0.46	---	---
I-280	SR 87 to 10th	EB	AM	67.0	4.0	9,200	6,348	24	C	---	---	---	---	---	---	-87	-0.95	---	---
			PM	27.0	4.0	9,200	8,432	78	F	---	---	---	---	---	---	-72	-0.78	---	---
I-280	10th to SR 87	WB	AM	21.0	4.0	9,200	9,956	119	F	---	---	---	---	---	---	-191	-2.08	---	---
			PM	65.0	4.0	9,200	8,299	32	D	---	---	---	---	---	---	-32	-0.35	---	---
I-280	SR 87 to Bird	WB	AM	20.0	4.0	9,200	6,095	76	F	---	---	---	---	---	---	-96	-1.04	---	---
			PM	62.0	4.0	9,200	5,318	21	C	---	---	---	---	---	---	0	0.00	---	---
I-280	Bird to Meridian	WB	AM	18.0	4.0	9,200	9,631	134	F	---	---	---	---	---	---	-121	-1.32	---	---
			PM	58.0	4.0	9,200	8,904	38	D	---	---	---	---	---	---	-10	-0.11	---	---
I-280	Meridian to I-880	WB	AM	14.0	3.0	6,900	7,205	172	F	26.0	1.0	1,650	753	29	D	-90	-1.30	-23	-1.39
			PM	66.0	3.0	6,900	6,465	33	D	70.0	1.0	1,650	439	6	A	20	0.29	-26	-1.58
SR 87	Coleman to Julian	SB	AM	66.0	2.0	4,400	2,253	17	B	67.0	1.0	1,650	225	3	A	-31	-0.70	-4	-0.24
			PM	32.0	2.0	4,400	3,987	62	F	50.0	1.0	1,650	1,087	22	C	-26	-0.59	-27	-1.64
SR 87	Julian to I-280	SB	AM	67.0	2.0	4,400	2,660	20	C	67.0	1.0	1,650	288	4	A	-15	-0.34	-5	-0.30
			PM	36.0	2.0	4,400	4,593	64	F	70.0	1.0	1,650	1,209	17	B	-23	-0.52	-22	-1.33
SR 87	I-280 to Alma	SB	AM	67.0	2.0	4,400	3,742	28	D	67.0	1.0	1,650	555	8	A	-2	-0.05	-18	-1.09
			PM	15.0	2.0	4,400	3,786	126	F	60.0	1.0	1,650	1,734	29	D	-8	-0.18	-23	-1.39
SR 87	Alma to Almaden Expressway	SB	AM	66.0	2.0	4,400	3,733	28	D	67.0	1.0	1,650	542	8	A	-3	-0.07	-18	-1.09
			PM	27.0	2.0	4,400	4,413	82	F	60.0	1.0	1,650	1,697	28	D	-12	-0.27	-23	-1.39
SR 87	Almaden Expressway to Curtner	SB	AM	66.0	2.0	4,400	2,865	22	C	67.0	1.0	1,650	482	7	A	-1	-0.02	-17	-1.03
			PM	36.0	2.0	4,400	3,471	48	E	70.0	1.0	1,650	1,501	21	C	-9	-0.20	-19	-1.15

Source: Santa Clara Valley Transportation Authority Congestion Management Program Monitoring Study, 2014.
The average speed for future HOV lanes are assumed to be 55 MPH.
Bold indicates unacceptable LOS.

6. Year 2025 Phase II Project Conditions – Santa Clara Station

This chapter describes traffic conditions in the year 2025 with the proposed Phase II Project. The Santa Clara Station is one of the four stations proposed along the Phase II Project corridor that would provide for the extension of BART service to the Cities of San Jose and Santa Clara (see Figure 1). Year 2025 Phase II Project conditions analyzed traffic conditions for the year 2025 (opening day of the project) in the vicinity of the Santa Clara Station with the addition of the proposed four BART Stations. The analysis includes intersection and freeway segment level of service analysis.

A detailed description of the method used to estimate station-generated traffic is included in Chapter 4 of this report. Estimates of the station-generated traffic, identification of impacts, and recommended mitigation measures for the Santa Clara Station under Year 2025 Phase II Project conditions are included within this chapter. Year 2025 Phase II Project conditions were evaluated relative to Year 2025 No Project/Phase I conditions in order to determine potential project impacts on the future transportation network. The significant impact criteria are discussed in Chapter 1 of this report.

Although some of the information provided below on intersection and freeway analysis methodology has already been described in previous chapters, it is presented again within this chapter for the reader's convenience.

Intersection and Freeway Analysis Methodology – All Stations

Trip Generation, Distribution and Assignment

As previously described, trip generation for the proposed stations was estimated based on passenger projections for the station obtained from the VTA Model. A detailed description of the method used to estimate station-generated traffic is included in Chapter 4. Actual trip generation estimates for the proposed Santa Clara Station under 2025 Phase II Project conditions are presented in subsequent sections within this chapter.

Distribution patterns and assignment of station-generated traffic (PNR and KNR trips) for the Year 2025 Phase II Project conditions were obtained from the VTA Model.

2025 Phase II Project Conditions Intersection Lane Configurations

The intersection lane configurations under the 2025 Phase II Project conditions were assumed to be the same as described under 2025 No Project/Phase I conditions.

2025 Phase II Project Conditions Intersection Traffic Volumes

Traffic volumes for the Year 2025 Phase II Project conditions were obtained from the VTA Model. These traffic volumes represent traffic projections for the year 2025 (opening day of the project) with the addition of planned improvements and the Phase II Project and proposed stations. Year 2025 Phase II Project conditions model volume forecasts were adjusted using the method previously described (Introduction chapter).

2025 Phase II Project Conditions Freeway Volumes

Traffic volumes for the Year 2025 Phase II Project conditions for the study freeway segments were obtained from the VTA Model. These volumes represent traffic projections for the year 2025 with the addition of planned improvements and the Phase II Project and proposed stations. Unlike intersection forecast volumes, no adjustments were made to the freeway volumes produced by the VTA Model since the freeway network contained in the VTA Model is represented more accurately than local roadways.

Station Description – Santa Clara Station

The proposed Santa Clara Station would be located at grade just northeast of the Caltrain tracks and the existing Santa Clara Caltrain Station (between Coleman Avenue and El Camino Real), at the western end of Brokaw Road (see Figure 4). KNR facilities and bus/shuttle loading areas would be provided along Brokaw Road. In addition, Brokaw Road would be widened between the Santa Clara Station and Coleman Avenue, resulting in a newly reconfigured intersection at Coleman Avenue. An approximately 240-foot-long pedestrian tunnel would connect from the Santa Clara BART Station to the Santa Clara Caltrain Station plaza, and an approximately 175-foot-long pedestrian tunnel would connect from the BART station to a new BART plaza on Brokaw Road.

The PNR demand would be accommodated in a 500-space parking structure located north of Brokaw Road and east of the Caltrain tracks. Vehicular access to the parking structure would be provided from Brokaw Road and Coleman Avenue. Pedestrian access from the parking structure to the Santa Clara BART Station would be provided through a pedestrian tunnel from Brokaw Road to the station.

The station site and the surrounding study area are shown on Figure 7.

Station Trip Generation Estimates – Santa Clara Station

The trip generation estimates for the proposed Santa Clara Station under the year 2025 Phase II Project conditions were developed using the VTA Model and based on the method previously described. Ridership projections total about 6,580 daily BART riders (3,290 boardings and 3,290 alightings) at the Santa Clara Station under the year 2025 Phase II Project conditions. Table 32 presents the daily and peak hour trip generation estimates for each of the drive access modes to the Santa Clara Station, described in the following sections.

Park-and-Ride Trips

Model projections of passenger volumes for the Santa Clara Station indicate that 455 daily PNR trips would access/egress the station under the year 2025 Phase II Project conditions. A total of 63 (61 inbound and 2 outbound) and 54 (6 inbound and 48 outbound) PNR trips are estimated to occur during the AM and PM peak hours, respectively.

Kiss-and-Ride Trips

Model projections of passenger volumes for the Santa Clara Station indicate that 110 daily KNR trips would utilize the station under the year 2025 Phase II Project conditions scenario. Since KNR trips consist of vehicles entering the station site to drop off a BART commuter and then exiting the site and proceeding on to another destination, station trip generation estimates for peak hour inbound and outbound KNR vehicle trips are equivalent. It is estimated that a total of 22 (11 inbound/11 outbound) KNR trips would

occur during the AM peak hour and a total of 26 (13 inbound/13 outbound) KNR trips would occur during the PM peak hour.

Table 32
Santa Clara Station Trip Generation Estimates – 2025 Phase II Project Conditions

Mode of Access by Station	Daily Trips	Parking Demand (# of Spaces)	AM Peak Hour Trips			PM Peak Hour Trips		
			In	Out	Total	In	Out	Total
Santa Clara Station:								
Kiss and Ride Trips	110		11	11	22	13	13	26
Park and Ride Trips	455	207	61	2	63	6	48	54
Total	565		72	13	85	19	61	80

Source: VTA Model, December 2014.

Trip Distribution and Assignment

Distribution pattern and assignment of station-generated traffic (PNR and KNR trips) to the proposed Santa Clara Station under the Year 2025 Phase II Project conditions were developed from traffic assignments using the VTA Model. As mentioned previously, implementation of the proposed project would result in a shift in travel pattern, as the result of some commuters modifying their travel route to access the station area, and in the removal of auto trips from the roadway network, as some commuters shift from auto to transit modes of travel. Thus, station-generated traffic consists of two components: 1.) new vehicular trips accessing the proposed Santa Clara Station, referred to as *station drive access* trips, and 2.) all the trips that would no longer be on the roadway as a result of the Phase II Project, represented by negative trips on the roadway network. It is projected that under Year 2025 Phase II Project conditions, approximately 950 and 800 AM and PM peak-hour trips, respectively, would be removed from the roadway transportation system as the result of the Phase II Project and proposed Stations. The total *net project trips* generated by the Santa Clara Station are therefore calculated by adding the new station drive access trips (positive trips) and the trips removed from the roadway network as a result of the Santa Clara Station and Phase II Project (negative trips). The Santa Clara Station drive access trips for the Year 2025 Phase II Project conditions are shown graphically on Figure 37 while the net project trips are shown on Figure 38.

An example of the trip assignment process and method used to estimate traffic with the project is presented in Chapter 4. The trip assignment process shows that at some locations, particularly for those movements leading directly to the station area, the number of vehicles accessing the station is larger than the number of vehicles shifted from the roadway network to transit modes, thus, the project results in a net increase in traffic volumes. At many locations, particularly for those movements either not leading to the station area or leading to freeways, the number of vehicles shifted from the roadway network to transit modes is greater than the number of vehicles using that movement to access the station, and the project results in a net decrease in traffic volumes.

2025 Phase II Project Conditions Traffic Volumes – Santa Clara Station

Traffic volumes for the Year 2025 Phase II Project conditions were obtained by adding to the Year 2025 No Project/Phase I traffic volumes, the traffic projected to be generated by the proposed BART Stations (net project trips, as described above). The net project traffic projections under the Year 2025 Phase II Project conditions were obtained from the VTA Model.

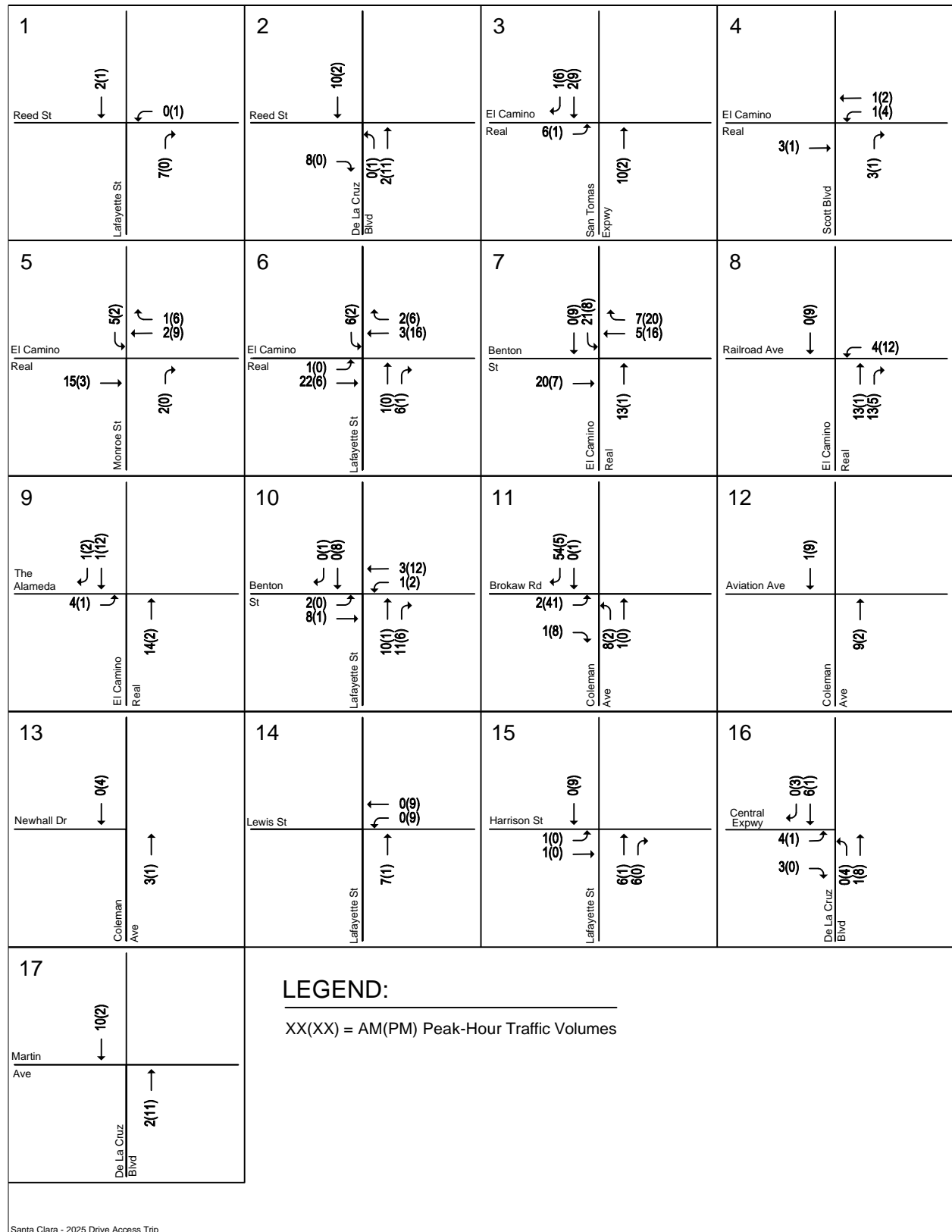

Figure 37
 2025 Phase II Project Conditions Station (Drive Access) Trips – Santa Clara Station

The Year 2025 Phase II Project conditions traffic volumes are presented on Figure 39 and included in Appendix D.

2025 Phase II Project Conditions Intersection Levels of Service

The results of the level of service analysis for the Santa Clara Station under the Year 2025 Phase II Project conditions are summarized in Table 33. The results show that the same study intersection identified to operate at unacceptable levels under Year 2025 No Project/Phase I conditions is projected to continue to operate at unacceptable levels of service during both peak hours (see Figure 40). CMP intersections are denoted by an asterisk (*).

(16) De La Cruz Boulevard and Central Expressway * (LOS F – AM and PM peak hours)

However, based on the CMP level of service impact criteria, the proposed project would not cause an adverse impact that would exceed the significance thresholds at any of the study intersections in the vicinity of the Santa Clara Station. Therefore, no mitigation is required.

Although the City of Santa Clara does not have a level of service standard for unsignalized intersections, an evaluation of the unsignalized study intersection was performed for informational purposes. The level of service analysis shows that the intersection of Lafayette Street and Harrison Street (#15) is projected to operate at LOS F during both the AM and PM peak hours under Year 2025 Phase II Project conditions. However, the peak-hour traffic signal warrant checks indicate that the intersection would not have traffic volumes under 2025 Phase II Project conditions that meet thresholds that warrant signalization.

Level of service F at two-way stop-controlled (TWSC) intersections can occur when gaps of traffic on the major street are limited, resulting in long delays for the minor-street traffic as they attempt to enter or cross the major street. At the study intersection of Lafayette Street and Harrison Street, the relatively high traffic volumes along Lafayette Street (major street) cause the delay on the low-volume Harrison Street (minor street) to be worse than the LOS F threshold. However, the low traffic volumes on Harrison Street result in the peak hour traffic signal warrant not being met.

All other CMP and local Santa Clara study intersections are projected to operate at an acceptable level of service. The level of service calculation sheets for the Santa Clara Station are included in Appendix G.

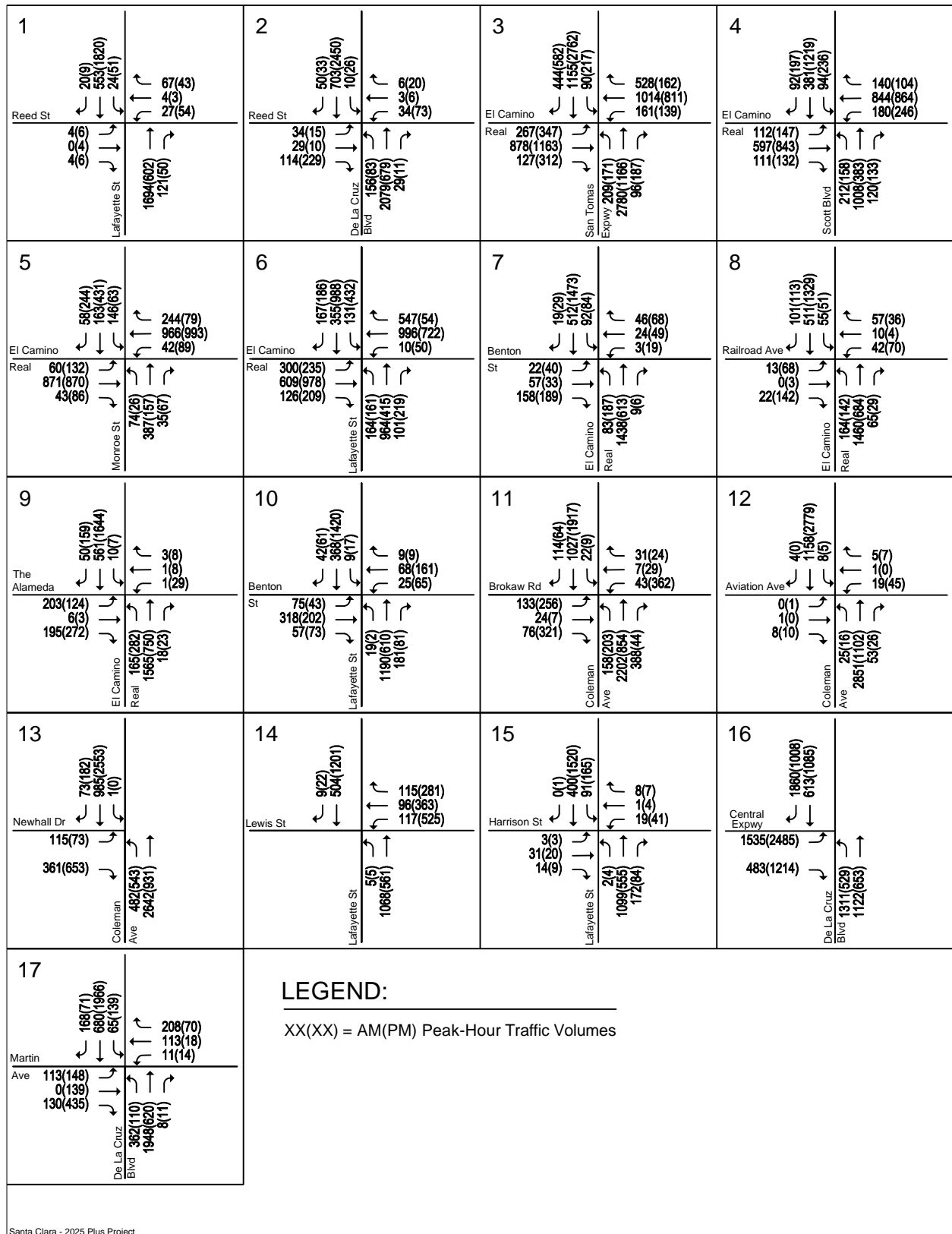

Figure 39
2025 Phase II Project Conditions Traffic Volumes – Santa Clara Station

Table 33
2025 Phase II Project Conditions Intersection Levels of Service – Santa Clara Station

Study Number	Intersection	Peak Hour	2025 No Project		2025 Phase II Project			
			Avg. Delay ¹	LOS	Avg. Delay ¹	LOS	Incr. In Crit. Delay	Incr. In Crit. V/C
1	Lafayette Street and Reed Street	AM	7.5	A	7.5	A	0.0	-0.003
		PM	7.4	A	7.4	A	0.0	-0.002
2	De La Cruz Boulevard and Reed Street	AM	14.4	B	14.6	B	0.3	-0.005
		PM	18.7	B	18.6	B	-0.1	-0.006
3	San Tomas Expressway and El Camino Real *	AM	65.8	E	65.5	E	-0.6	-0.005
		PM	79.6	E	78.6	E	-1.8	-0.009
4	Scott Boulevard and El Camino Real *	AM	35.7	D	35.6	D	-1.0	0.002
		PM	40.1	D	40.0	D	0.0	-0.001
5	Monroe Street and El Camino Real *	AM	35.9	D	36.0	D	0.1	0.000
		PM	32.9	C	32.9	C	0.0	0.000
6	Lafayette Street and El Camino Real *	AM	39.4	D	39.3	D	-0.2	-0.005
		PM	40.0	D	40.0	D	-0.1	-0.003
7	El Camino Real and Benton Street	AM	13.7	B	13.7	B	0.0	0.001
		PM	16.0	B	15.9	B	-0.2	-0.005
8	El Camino Real and Railroad Avenue	AM	10.6	B	10.6	B	0.0	-0.002
		PM	12.3	B	12.3	B	-0.1	-0.003
9	El Camino Real and The Alameda *	AM	17.2	B	17.1	B	0.0	-0.010
		PM	18.7	B	18.4	B	-0.4	-0.011
10	Lafayette Street and Benton Street	AM	18.6	B	18.6	B	0.0	-0.001
		PM	15.7	B	15.8	B	0.0	0.001
11	Coleman Avenue and Brokaw Road	AM	17.2	B	17.3	B	0.0	-0.008
		PM	45.9	D	45.8	D	-0.2	-0.002
12	Coleman Avenue and Aviation Avenue	AM	19.9	B	17.8	B	-3.0	-0.013
		PM	7.0	A	7.0	A	0.0	-0.005
13	Coleman Avenue and Newhall Drive	AM	22.7	C	22.5	C	-0.2	-0.011
		PM	41.4	D	40.2	D	-1.6	-0.011
14	Lafayette Street and Lewis Street	AM	11.3	B	11.2	B	-0.2	-0.004
		PM	48.6	D	48.9	D	0.6	0.001
15	Lafayette Street and Harrison Street (unsignalized) ²	AM	166.1	F	167.1	F	--- ²	--- ²
		PM	³	F	³	F	--- ²	--- ²
16	De La Cruz Boulevard and Central Expressway *	AM	357.2	F	351.6	F	-9.2	-0.021
		PM	171.8	F	168.1	F	-5.3	-0.012
17	De La Cruz Boulevard and Martin Avenue	AM	35.5	D	35.5	D	0.0	-0.006
		PM	32.6	C	32.5	C	-0.1	-0.006

* Denotes CMP Intersection

Entries denoted in **bold** indicate conditions that exceed the applicable level of service standard.

¹The reported delay and corresponding level of service for signalized intersections represents the average delay for all approaches at the intersection. The reported delay and corresponding level of service for unsignalized (two-way stop-controlled) intersections are based on the stop-controlled approach with the highest delay.

²The City of Santa Clara does not have a level of service standard nor impact criteria for unsignalized intersections. Reported intersection delay is presented for informational purposes only.

³Worst approach intersection delay is projected to be greater than 200 seconds per vehicle.

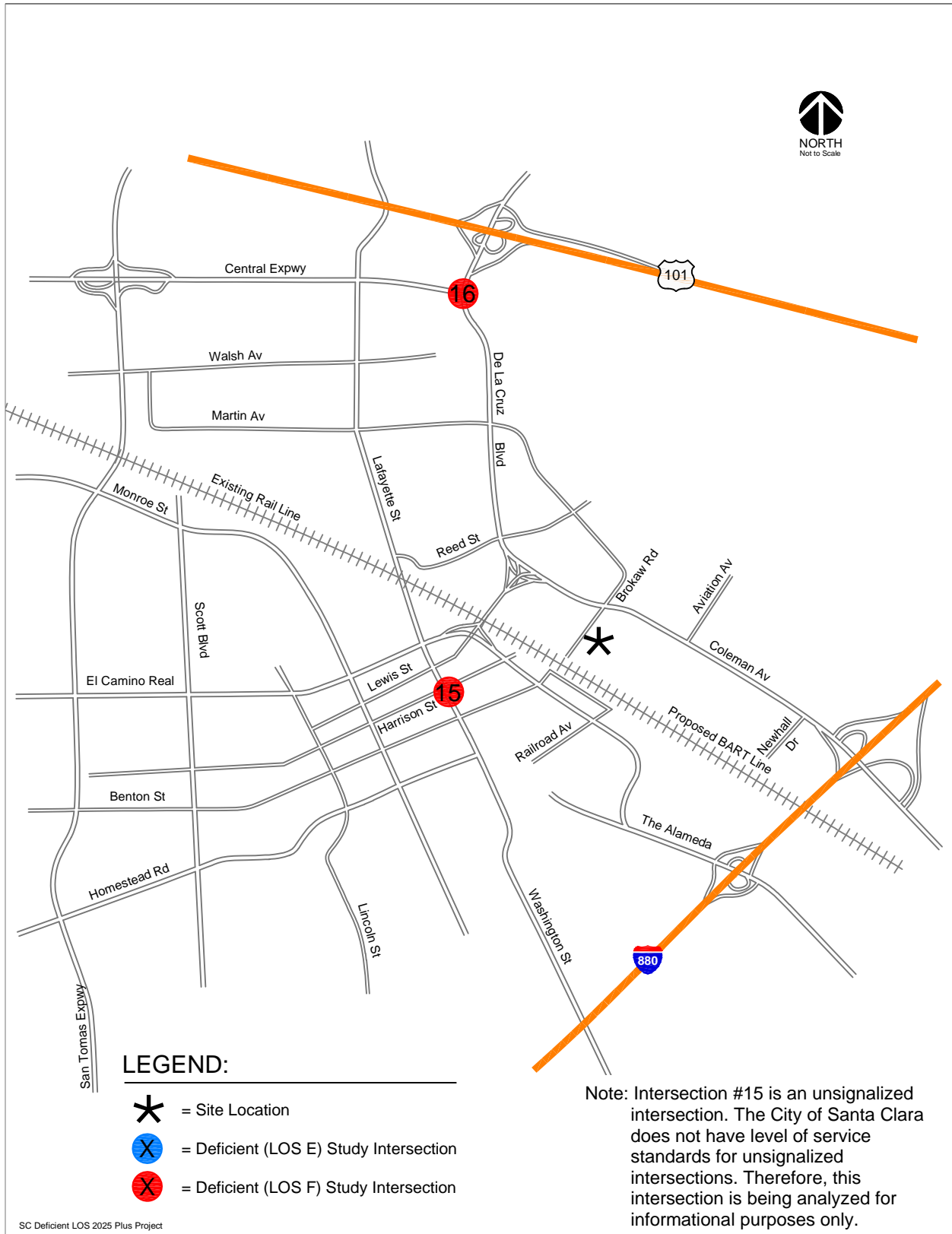

Figure 40
2025 Phase II Project Conditions Deficient LOS Intersections – Santa Clara Station

2025 Phase II Project Conditions Freeway Segment Levels of Service

Traffic volumes for the Year 2025 Phase II Project conditions for the study freeway segments were obtained from the VTA Model. These volumes represent traffic projections for the year 2025 with the addition of planned improvements and the Phase II Project and proposed stations. Note that the project would result in a decrease in traffic volumes on the freeway network, as commuters use BART as an alternative to regional freeway travel. While a portion of traffic accessing the station areas would use the freeway network to do so, generally those trips are already on the freeway network and do not represent an increase in traffic from Year 2025 No Project/Phase I conditions. However, a number of others accessing the station would do so via transit or local streets, and therefore would result in a net reduction in freeway volumes. The net reduction in peak hour freeway volumes along the study freeway segments as a result of the implementation of the Phase II Project and the Santa Clara Station are presented in Table 34.

The results of the freeway analysis are summarized in Table 34. The results show that 24 of the 26 directional freeway segments (and 6 HOV segments) analyzed for the Santa Clara Station would operate at an unacceptable LOS F during at least one of the peak hours. Since the project would not add traffic representing one percent or more of the segment's capacity to any of the study freeway segments projected to operate at LOS F (including HOV segments), the project would not cause an adverse impact that would exceed the significance thresholds on any of the freeway segments analyzed under the Year 2025 Phase II Project conditions according to VTA CMP level of service impact criteria for freeways. Therefore, no mitigation is required.

2025 Phase II Project Conditions Freeway Ramp Analysis

Based on the traffic volume projections obtained from the VTA Model, the Phase II Project is not projected to increase freeway ramp volumes by 10 or more peak-hour trips at any freeway ramp in the vicinity of the Santa Clara Station.

Bicycle, Pedestrian, and Transit Facilities Analyses

With the proposed project, an approximately 240-foot-long pedestrian tunnel would connect from the Santa Clara BART Station to the Santa Clara Caltrain Station plaza, and an approximately 175-foot-long pedestrian tunnel would connect from the BART station to a new BART plaza on Brokaw Road. This pedestrian connection would link the station with other pedestrian and transit facilities in the vicinity, enhancing connectivity of pedestrian facilities surrounding the station and transit services. Additionally, with the exception of the east side of Lafayette Street, sidewalks are found along most local roadways in the study area and along the local residential streets and collectors near the Santa Clara Station site. All signalized intersections in the vicinity of the Santa Clara Station have marked crosswalks on all or most of the legs of the intersection combined with pedestrian push buttons and pedestrian signal heads. In combination with planned pedestrian/bicycle improvements in the study area, the project-sponsored pedestrian/bicycle improvements would help enhance pedestrian/bicycle facilities in the area. Therefore, the Phase II Project would not result in any significant impacts on bicycle and pedestrian circulation, and no mitigation measures are required.

The Phase II Project is a transit project and therefore represents a substantial improvement to the transit system in the study area. Additionally, the Phase II Project is being integrated with VTA's light rail and bus systems and would not adversely impact transit facilities or services within the Cities of San Jose and Santa Clara in the vicinity of the BART extension or the proposed BART stations.

Table 34
2025 Phase II Project Conditions Freeway Levels of Service – Santa Clara Station

Freeway Segment		2025 Phase II Project Conditions														Net Project Trips			
		Direction	Peak Hour	Mixed-Flow Lane					HOV Lane					Mixed-Flow Lane		HOV Lane			
				Avg. Speed	# of Lanes	Capacity	Project Volume	Density	LOS	Avg. Speed	# of Lanes	Capacity	Project Volume	Density	LOS	Volume	% of Capacity	Volume	% of Capacity
US 101	I-880 to Old Bayshore	NB	AM	14.0	3.0	6,900	5,855	139	F	19.0	1.0	1,650	1,739	92	F	-45	-0.65	-55	-3.33
			PM	67.0	3.0	6,900	3,736	19	C	70.0	1.0	1,650	621	9	A	-11	-0.16	-6	-0.36
US 101	Old Bayshore to First	NB	AM	12.0	3.0	6,900	6,200	172	F	13.0	1.0	1,650	1,662	128	F	-55	-0.80	-53	-3.21
			PM	66.0	3.0	6,900	4,210	21	C	70.0	1.0	1,650	626	9	A	-16	-0.23	-6	-0.36
US 101	First to SR 87	NB	AM	19.0	3.0	6,900	6,752	118	F	19.0	1.0	1,650	1,524	80	F	-72	-1.04	-49	-2.97
			PM	67.0	3.0	6,900	5,155	26	C	70.0	1.0	1,650	734	10	A	-23	-0.33	-10	-0.61
US 101	SR 87 to De La Cruz	NB	AM	12.0	3.0	6,900	6,588	183	F	14.0	1.0	1,650	1,437	103	F	-70	-1.01	-45	-2.73
			PM	66.0	3.0	6,900	5,396	27	D	70.0	1.0	1,650	734	10	A	-31	-0.45	-10	-0.61
US 101	De La Cruz to Montague	NB	AM	26.0	3.0	6,900	6,292	81	F	39.0	1.0	1,650	1,964	50	E	-57	-0.83	-62	-3.76
			PM	65.0	3.0	6,900	5,457	28	D	70.0	1.0	1,650	1,178	17	B	-24	-0.35	-23	-1.39
US 101	Montague to Great America	NB	AM	21.0	3.0	6,900	6,666	106	F	41.0	1.0	1,650	1,640	40	D	-56	-0.81	-55	-3.33
			PM	58.0	3.0	6,900	5,803	33	D	70.0	1.0	1,650	1,233	18	B	-26	-0.38	-27	-1.64
I-880	I-280 to Stevens Creek	NB	AM	15.0	3.0	6,900	5,159	115	F	55.0	1.0	1,650	611	11	A	-54	-0.78	-36	-2.18
			PM	66.0	3.0	6,900	4,730	24	C	55.0	1.0	1,650	796	14	B	-34	-0.49	-19	-1.15
I-880	Stevens Creek to Bascom	NB	AM	20.0	3.0	6,900	6,606	110	F	55.0	1.0	1,650	611	11	A	-77	-1.12	-36	-2.18
			PM	16.0	3.0	6,900	5,478	114	F	55.0	1.0	1,650	796	14	B	-44	-0.64	-19	-1.15
I-880	Bascom to The Alameda	NB	AM	27.0	3.0	6,900	6,049	75	F	55.0	1.0	1,650	659	12	B	-75	-1.09	-36	-2.18
			PM	13.0	3.0	6,900	6,038	155	F	55.0	1.0	1,650	898	16	B	-54	-0.78	-21	-1.27
I-880	The Alameda to Coleman	NB	AM	31.0	3.0	6,900	6,280	68	F	55.0	1.0	1,650	672	12	B	-95	-1.38	-33	-2.00
			PM	15.0	3.0	6,900	6,390	142	F	55.0	1.0	1,650	1,070	19	C	-73	-1.06	-26	-1.58
I-880	Coleman to SR 87	NB	AM	22.0	3.0	6,900	6,021	91	F	55.0	1.0	1,650	775	14	B	-95	-1.38	-38	-2.30
			PM	24.0	3.0	6,900	6,266	87	F	55.0	1.0	1,650	1,243	23	C	-84	-1.22	-36	-2.18
I-880	SR 87 to First	NB	AM	48.0	3.0	6,900	6,021	42	D	55.0	1.0	1,650	775	14	B	-95	-1.38	-38	-2.30
			PM	22.0	3.0	6,900	6,266	95	F	55.0	1.0	1,650	1,243	23	C	-84	-1.22	-36	-2.18
I-880	First to US 101	NB	AM	36.0	3.0	6,900	5,649	52	E	55.0	1.0	1,650	617	11	A	-101	-1.46	-24	-1.45
			PM	51.0	3.0	6,900	6,812	45	D	55.0	1.0	1,650	1,043	19	C	-109	-1.58	-32	-1.94

Table 34 (Continued)
2025 Phase II Project Conditions Freeway Levels of Service – Santa Clara Station

Freeway Segment	Direction	Peak Hour	Mixed-Flow Lane							HOV Lane					Mixed-Flow Lane		HOV Lane	
			Avg. Speed	# of Lanes	Capacity	Project Volume	Density	LOS	Avg. Speed	# of Lanes	Capacity	Project Volume	Density	LOS	Volume	% of Capacity	Volume	% of Capacity
I-880 US 101 to First	SB	AM	16.0	3.0	6,900	6,118	127	F	55.0	1.0	1,650	1,027	19	C	-93	-1.35	-66	-4.00
		PM	14.0	3.0	6,900	5,554	132	F	55.0	1.0	1,650	712	13	B	-131	-1.90	-161	-9.76
I-880 First to SR 87	SB	AM	25.0	3.0	6,900	5,662	75	F	55.0	1.0	1,650	1,072	19	C	-79	-1.14	-68	-4.12
		PM	14.0	3.0	6,900	5,581	133	F	55.0	1.0	1,650	768	14	B	-124	-1.80	-201	-12.18
I-880 SR 87 to Coleman	SB	AM	65.0	3.0	6,900	5,662	29	D	55.0	1.0	1,650	1,072	19	C	-79	-1.14	-68	-4.12
		PM	23.0	3.0	6,900	5,581	81	F	55.0	1.0	1,650	768	14	B	-124	-1.80	-201	-12.18
I-880 Coleman to The Alameda	SB	AM	66.0	3.0	6,900	6,256	32	D	55.0	1.0	1,650	860	16	B	-89	-1.29	-52	-3.15
		PM	23.0	3.0	6,900	6,580	95	F	55.0	1.0	1,650	672	12	B	-151	-2.19	-197	-11.94
I-880 The Alameda to Bascom	SB	AM	66.0	3.0	6,900	5,949	30	D	55.0	1.0	1,650	794	14	B	-60	-0.87	-48	-2.91
		PM	25.0	3.0	6,900	6,536	87	F	55.0	1.0	1,650	707	13	B	-115	-1.67	-221	-13.39
I-880 Bascom to Stevens Creek	SB	AM	50.0	3.0	6,900	5,790	39	D	55.0	1.0	1,650	794	14	B	-45	-0.65	-48	-2.91
		PM	30.0	3.0	6,900	6,531	73	F	55.0	1.0	1,650	720	13	B	-107	-1.55	-224	-13.58
I-880 Stevens Creek to I-280	SB	AM	66.0	3.0	6,900	4,460	23	C	55.0	1.0	1,650	690	13	B	-36	-0.52	-44	-2.67
		PM	65.0	3.0	6,900	4,741	24	C	55.0	1.0	1,650	642	12	B	-84	-1.22	-218	-13.21
US 101 Great America to Montague	SB	AM	66.0	3.0	6,900	6,072	31	D	67.0	1.0	1,650	1,195	18	B	-28	-0.41	-24	-1.45
		PM	14.0	3.0	6,900	6,823	162	F	20.0	1.0	1,650	1,738	87	F	-35	-0.51	-22	-1.33
US 101 Montague to De La Cruz	SB	AM	66.0	3.0	6,900	5,502	28	D	67.0	1.0	1,650	1,110	17	B	-26	-0.38	-23	-1.39
		PM	13.0	3.0	6,900	6,276	161	F	40.0	1.0	1,650	1,925	48	E	-30	-0.43	-24	-1.45
US 101 De La Cruz to SR 87	SB	AM	62.0	3.0	6,900	6,589	35	D	67.0	1.0	1,650	1,032	15	B	-31	-0.45	-19	-1.15
		PM	18.0	3.0	6,900	8,040	149	F	50.0	1.0	1,650	1,977	40	D	-47	-0.68	-26	-1.58
US 101 SR 87 to First	SB	AM	67.0	3.0	6,900	4,686	23	C	67.0	1.0	1,650	807	12	B	-22	-0.32	-13	-0.79
		PM	16.0	3.0	6,900	5,966	124	F	30.0	1.0	1,650	1,739	58	E	-28	-0.41	-23	-1.39
US 101 First to Old Bayshore	SB	AM	67.0	3.0	6,900	3,495	17	B	67.0	1.0	1,650	578	9	A	-18	-0.26	-10	-0.61
		PM	6.0	3.0	6,900	4,823	268	F	20.0	1.0	1,650	1,487	74	F	-21	-0.30	-20	-1.21
US 101 Old Bayshore to I-880	SB	AM	67.0	3.0	6,900	4,400	22	C	67.0	1.0	1,650	630	9	A	-20	-0.29	-10	-0.61
		PM	8.0	3.0	6,900	6,007	250	F	30.0	1.0	1,650	1,706	57	E	-38	-0.55	-24	-1.45

Source: Santa Clara Valley Transportation Authority Congestion Management Program Monitoring Study, 2014.
 The average speed for future HOV lanes are assumed to be 55 MPH.
Bold indicates unacceptable LOS.

7. Year 2035 No Project/Phase I Conditions

This chapter describes traffic conditions in the year 2035 without the Phase II Project. This scenario assumes that the Phase I Project (Milpitas and Berryessa BART Stations only) would be completed. Included are descriptions of the year 2035 land uses, roadway network, and transit service. The analysis includes intersection and freeway segment level of service analysis for the Year 2035 No Project/Phase I conditions.

2035 Land Use

The future land use assumptions used for the 2035 No Project/Phase I conditions are based on projections compiled by the Association of Bay Area Governments (ABAG), Association of Monterey Bay Area Governments (AMBAG), and San Joaquin Council of Governments (SJCOG). The ABAG demographic assumption bases the travel forecasts on socio-economic/land use forecast series *Projections 2013*. The number of households and jobs projected for the year 2035 are presented in Table 35. As shown in the table, households and jobs in the region are expected to increase by 19 percent and 21 percent, respectively.

2035 Roadway Network

Several transportation improvements in the Phase II Project study area are planned and would be operational by 2035. These improvements are identified in the MTC Bay Area's Regional Transportation Plan (RTP), *Transportation 2035 Plan for the San Francisco Bay Area* (Transportation 2035 Plan), adopted by MTC in April 2009, and the *Valley Transportation Plan 2040* (VTP 2040), adopted by VTA in October 2013. The improvements consist of freeway widenings and interchange improvements as well as improvements to regional and local facilities. There are no new freeways planned.

Information on local intersection improvements also were obtained from both the Cities of San Jose and Santa Clara. These include funded improvements at intersections that will be in place by the year 2035. The planned roadway improvements in the vicinity of the Phase II Project are identified in Table 36.

In addition, VTA staff provided information on the Santa Clara-Alum Rock Bus Rapid Transit (BRT) Project. Traffic signal modifications as a result of the Santa Clara-Alum Rock BRT will occur at the following study intersection:

(7) 17th Street and Santa Clara Street (Alum Rock/28th Street Station) – with the Santa Clara-Alum Rock BRT Project, the traffic signal phasing for the eastbound/westbound direction will change from permitted left-turn to split phase.

Table 35
2035 Projected Number of Households and Employment by County

County	2015		2035		Growth 2015 to 2035	
	Households	Employment	Households	Employment	Households	Employment
San Francisco	362,400	617,400	430,100	733,000	19%	19%
San Mateo	267,200	378,700	305,400	440,700	14%	16%
Santa Clara	640,400	1,006,600	781,800	1,198,800	22%	19%
Alameda	571,400	757,000	678,100	910,600	19%	20%
Contra Costa	387,900	374,500	448,100	449,600	16%	20%
Solano	146,100	143,100	164,200	172,500	12%	21%
Napa	50,100	75,700	55,000	86,900	10%	15%
Sonoma	191,500	208,200	214,800	247,800	12%	19%
Marin	104,700	115,100	110,500	126,400	6%	10%
Santa Cruz	97,600	139,600	119,000	191,200	22%	37%
Monterey	136,000	214,500	183,100	336,100	35%	57%
San Benito	18,000	20,200	26,300	32,700	46%	62%
San Joaquin	239,000	227,800	316,400	267,500	32%	17%
Region	3,212,300	4,278,400	3,832,800	5,193,800	19%	21%

Source: ABAG Projections 2013.

2035 Bicycle and Pedestrian Facilities

The Santa Clara Countywide Bicycle Plan, adopted by VTA in August 2008, identifies various existing and/or planned cross county bicycle corridors in the vicinity of the proposed BART Stations. The bicycle plan also identifies planned/potential projects that would enhance existing pedestrian and bicycle facilities and improve connectivity between facilities.

In addition, the VTP 2040 document identifies various funded bicycle projects, some which are located within the study station areas. These projects were assumed to be in place by the year 2025, and are listed on Table 15 in Chapter 3 of this report.

2035 Transit Service

Transit improvements for the year 2035 primarily consist of enhancement of regional bus lines and commuter trains that also serve San Jose and Santa Clara. Some of these improvements include bus rapid transit (BRT) projects, Light Rail Transit (LRT) extensions and service improvements, and rail service upgrades. Table 37 presents the numerous new transit services and capital projects that would affect travel in the study area.

Table 36
2035 Transportation Network Improvements

Improvement	Implementation Period	
	2025	2035
1 Converting all existing freeway HOV lanes to express lanes.	*	*
2 I-880 between SR 237 and US 101 – add express lanes.	*	*
3 Widen Coleman Avenue from 4-lanes to 6-lanes between I-880 and Taylor Street.	*	*
4 Conversion of one-way couplets to two-way streets along 10th and 11th Streets, Almaden Avenue and Vine Street, and 2nd and 3rd Streets.	*	*
5 Widen Central Expressway from 4-lanes to 6-lanes between Lawrence and San Tomas Expressway.	*	*
6 Conversion HOV lanes on Central Expressway to mixed-flow lanes between De La Cruz Boulevard and San Tomas Expressway.	*	*
7 Widen San Tomas Expressway to 8 lanes between Williams to El Camino Real.	*	*
8 Replace and widen San Carlos Street bridge at Caltrain/Vasona LRT.		
9 Realignment of Julian Street between SR 87 and North 1 st Street to extend the downtown urban grid system.	*	*
10 Conversion of St. James Street from one-way to two-way street from Notre Dame/SR 87 to Market Street (part of the Julian Realignment project).	*	*
11 Complete the Autumn Street realignment and extension between St. John Street and Coleman Avenue.	*	*
12 Convert Autumn Street between Santa Clara Street and Park Avenue from a one-way (northbound) street to a two-way street. Autumn Street will become a 4-lane street.	*	*
13 Convert Montgomery Street between Santa Clara Street and San Fernando Street from a one-way (southbound) street to a two-way street. Montgomery Street will remain a two-lane street.	*	*
14 Create cul-de-sac at southerly end of Montgomery Street , just north of Park Avenue.	*	*
15 I-280 between US 101 and Leland Avenue - convert one mixed-flow lane to express lanes.		*
16 I-680 between Montague Expressway and US 101 - convert one mixed-flow lane to express lanes.		*
17 I-280 Downtown San Jose access improvements between 3rd and 7th Streets - reconstruct existing ramps at 7th and 4th Streets. The existing off-ramp connection at 5th Street will be eliminated.		*
18 I-280/Senter Road interchange - extend Senter Road and construct new on-/off-ramps and modify existing on-/off-ramps into a collector/distributor ramp system.		*
19 US 101 Southbound/Trimble Rd./De La Cruz Blvd./Central Expwy interchange improvements - Modify existing loop cloverleaf ramp from SB US 101 to Trimble Rd. into a partial cloverleaf ramp. Modify the SB US 101 on-ramp from De La Cruz Blvd./Central Expwy to 1 mixed-flow and 1 HOV lane with ramp meter. The De La Cruz Blvd. bridge to be widened from 4 to 6 lanes.		*

Source: VTA staff, Cities of San Jose and Santa Clara staff, 2008 County's Expressway Plan, and VTP 2040 (VTA 2013). (SJ) = San Jose, (SC) = Santa Clara

Table 36 (Continued)
2035 Transportation Network Improvements

Improvement	Implementation Period	
	2025	2035
Other Local Intersection Improvements		
19 King Road and McKee Road (SJ) - addition of second eastbound left-turn lane.	*	*
20 SR 87 (E) and Julian Street (SJ) - conversion of the existing northbound shared right-through lane to separate through and right-turn lanes; conversion of the existing westbound shared right-through lane to a dedicated right-turn lane.	*	*
21 Montgomery Street and Santa Clara Street (SJ) - addition of a left-turn and right turn lane on the northbound approach; elimination of one of the existing westbound left-turn lanes.	*	*
22 Autumn Street and Santa Clara Street (SJ) - addition of a southbound through lane and conversion of the existing southbound right turn lane to shared right-through lane; addition of a eastbound right-turn lane; and addition of two westbound left-turn lanes and a separate westbound right-turn lane.	*	*
23 Montgomery Street and San Fernando Street (SJ) - addition of an all-movement lane on the northbound approach and conversion of all intersection approaches to single all-movement lanes.	*	*
24 Autumn Street and San Fernando Street (SJ) - conversion of the existing northbound shared left-through lane to a dedicated left-turn lane; addition of one left-turn, one through, and one shared right-through lane on the southbound approach; and conversion of the existing westbound through lane to a shared left-through lane.	*	*
25 Montgomery Street and Park Avenue (SJ) - this intersection will become Autumn/Park.	*	*
26 Autumn Street and Park Avenue (SJ) - intersection lane configuration will include one left, one through, and one shared right-through lane on the northbound approach; one left, one through, and one shared right-through lane on the southbound approach; one left and one shared right-through lane on the eastbound approach; and two left-turn and one shared right-through lane on the westbound approach.	*	*
27 Bird Avenue and San Carlos Street (SJ) - addition of a second left-turn lane and conversion of the shared right-through lane to exclusive right-turn lane (reducing the number of through lanes by one) on the northbound approach; and elimination of one southbound through lane.	*	*
28 Autumn Street and Julian Street (SJ) - reconfiguration of the northbound and southbound approaches to include one left-turn, one through, and one shared right-through lane.	*	*
29 Lafayette Street and El Camino Real (SC) - addition of second left-turn lanes on both the southbound and eastbound approaches.	*	*
30 Coleman Avenue and Brokaw Road (SC) - Widening of Coleman Avenue to accommodate a third southbound through lane.	*	*
31 San Tomas Expressway and El Camino Real (SC) - addition of second left-turn lanes on both the eastbound and westbound approaches.	*	*

Source: VTA staff, Cities of San Jose and Santa Clara staff, 2008 County's Expressway Plan, and VTP 2040 (VTA 2013).
 (SJ) = San Jose, (SC) = Santa Clara

**Table 37
2035 Transit Improvements (Santa Clara County)**

No.	Transit Projects	Implementation Period		Notes
		2025	2035	
1	BART Extension from Fremont to Berryessa	*	*	Project connects the existing BART system from the Warm Springs Station in Southern Fremont through Milpitas to the Berryessa District of San Jose.
2	Bus Rapid Transit (BRT) Line 523 – Stevens Creek Boulevard (previously Line 23)	*	*	Downtown San Jose to Cupertino, offering 10-minute service each direction
3	El Camino BRT Line 522 (previously Lines 22/Line 300)	*	*	Limited stop service at 10-minute intervals; target is minimum 15 percent travel time reduction on El Camino Real from Downtown San Jose to Palo Alto (Line 22).
4	Santa Clara/Alum Rock (SCAR) BRT	*	*	Project constructs enhancements in the County's highest ridership corridor, including two miles of dedicated lanes.
5	Capitol Corridor Commuter and Intercity Rail	*	*	11 round trips/day between Sacramento and San Jose; new Oakland Coliseum and Union City intermodal stations in service.
6	LRT – Guadalupe Express Service	*	*	A Guadalupe Express service between Ohlone/Chynoweth and San Jose Convention Center, with local service provided by a through-routed Almaden line.
7	LRT – Additional Line – Long T	*	*	Operate an additional line (the "Long T") that would travel from Downtown Mountain View to Alum Rock during peak periods, with express service from Downtown Mountain View to Old Ironsides and an intermediate stop at Lockheed Martin. The off-peak service would operate from Old Ironsides to Alum Rock.
8	LRT – Expanded Service between Campbell and Downtown San Jose	*	*	An independent Vasona (Mountain View – Winchester) branch, operating between Campbell and Downtown San Jose, allowing three-car trains originating from the Almaden line to serve North First Street corridor and Mountain View.
9	Implementation of Caltrain Modernization/Electrification Projects	*	*	Improve train performance and increase service, shorter headways and increased travel speeds, reduce noise and air pollution.
10	Caltrain/HSR Station Improvements: Diridon Station	*	*	Provide station improvements needed to accommodate and support the high-speed rail service.
11	Mineta San Jose International Airport APM Connector		*	Project would provide transit link to San Jose International Airport from VTA's Guadalupe LRT line, and from Caltrain and future BART in Santa Clara using Automated People Mover (APM) technology.

Source: *Transportation 2035 Plan for the San Francisco Bay Area* (MTC, 2009), *VTP 2040* (VTA 2013).

Year 2035 No Project/Phase I Conditions Intersection Lane Configurations

The study intersection lane configurations under the Year 2035 No Project/Phase I conditions were assumed to be the same as described under Year 2025 No Project/Phase I conditions (Chapter 3). The intersection lane configurations under Year 2035 No Project/Phase I conditions are shown graphically in Figures 20, 21, and 22, Chapter 3 of this report.

Year 2035 No Project/Phase I Conditions Traffic Volumes

Peak-hour traffic volumes for the year 2035 were produced with the VTA Model using the method described earlier in this report. The 2035 traffic volumes include traffic associated with future development included in the ABAG projections and the projected future transportation network, as described above. Traffic volumes for Year 2035 No Project/Phase I conditions are presented in Figures 41, 42, 43 and included in Appendix D.

Year 2035 No Project/Phase I Conditions Intersection Levels of Service

Intersection level of service was used to evaluate traffic operations at the study intersections under Year 2035 No Project/Phase I conditions. Adjusted 2035 model volume forecasts were used to calculate intersection levels of service. The intersection level of service results for the Year 2035 No Project/Phase I conditions are described below.

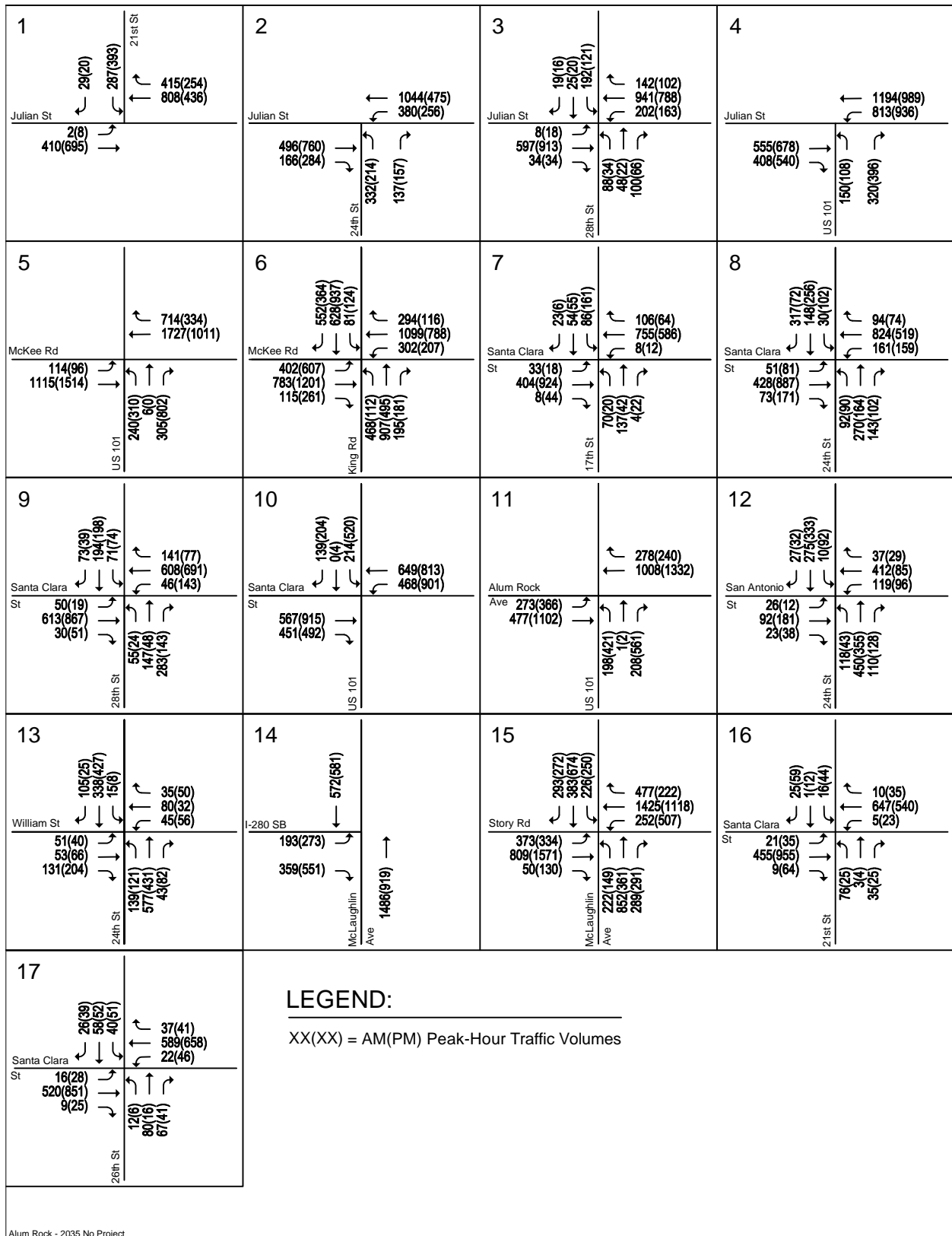
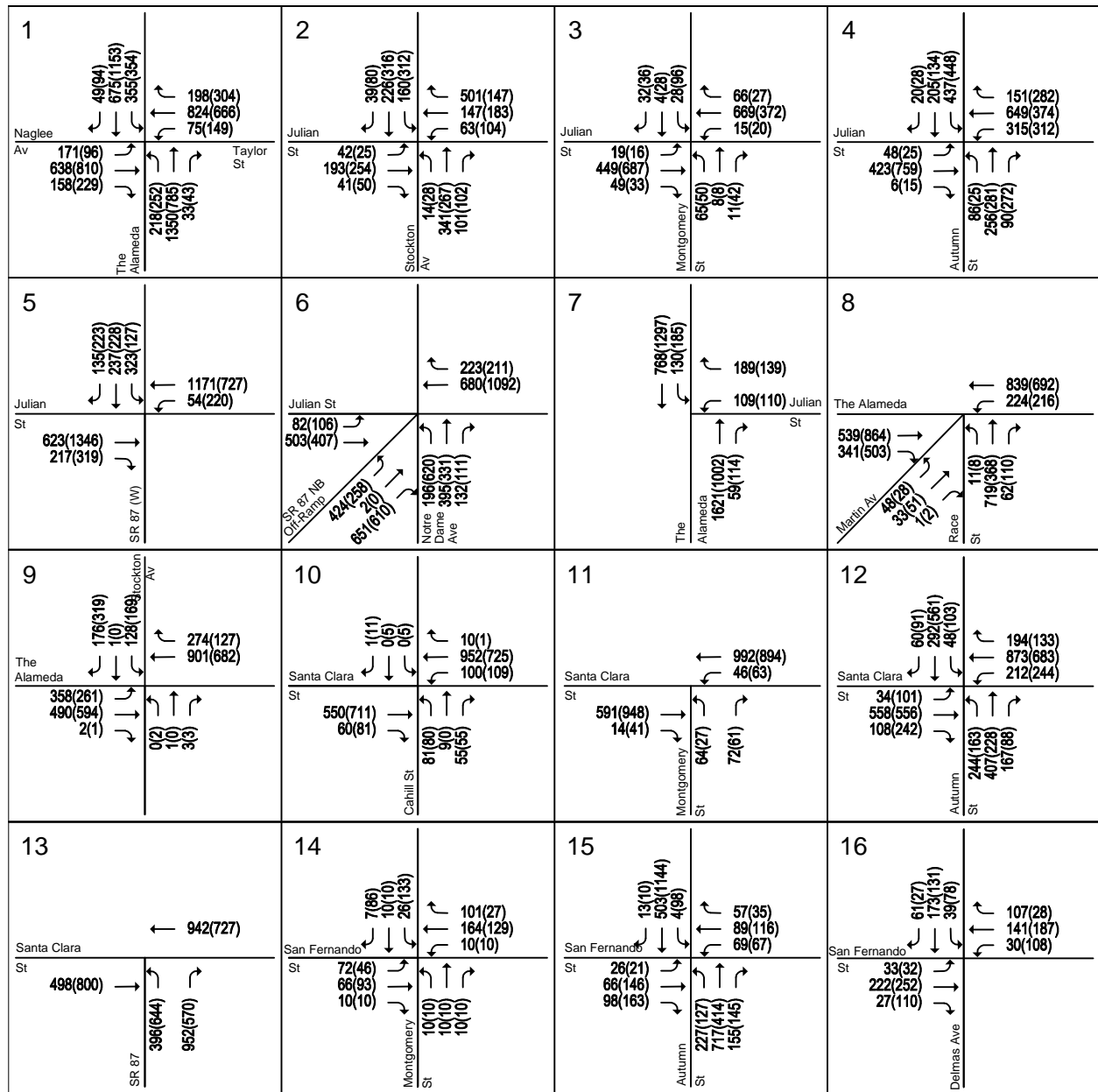

Figure 41
 2035 No Project/Phase I Conditions Traffic Volumes – Alum Rock/28th Street Station



LEGEND:

XX(X) = AM(PM) Peak-Hour Traffic Volumes

Diridon - 2035 No Project

Figure 42
2035 No Project/Phase I Conditions Traffic Volumes – Diridon Station

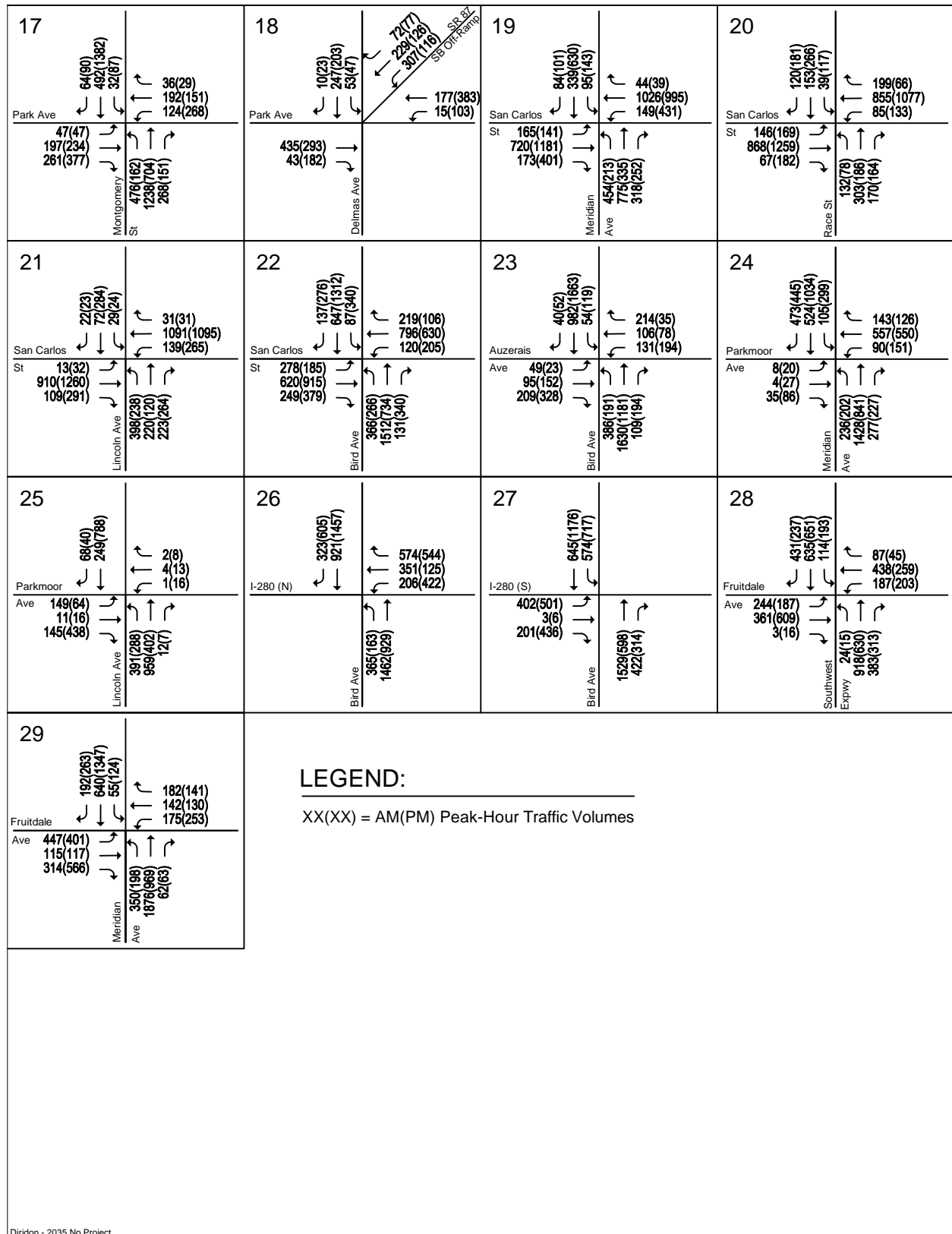

Figure 42 (Continued)
 2035 No Project/Phase I Conditions Traffic Volumes – Diridon Station

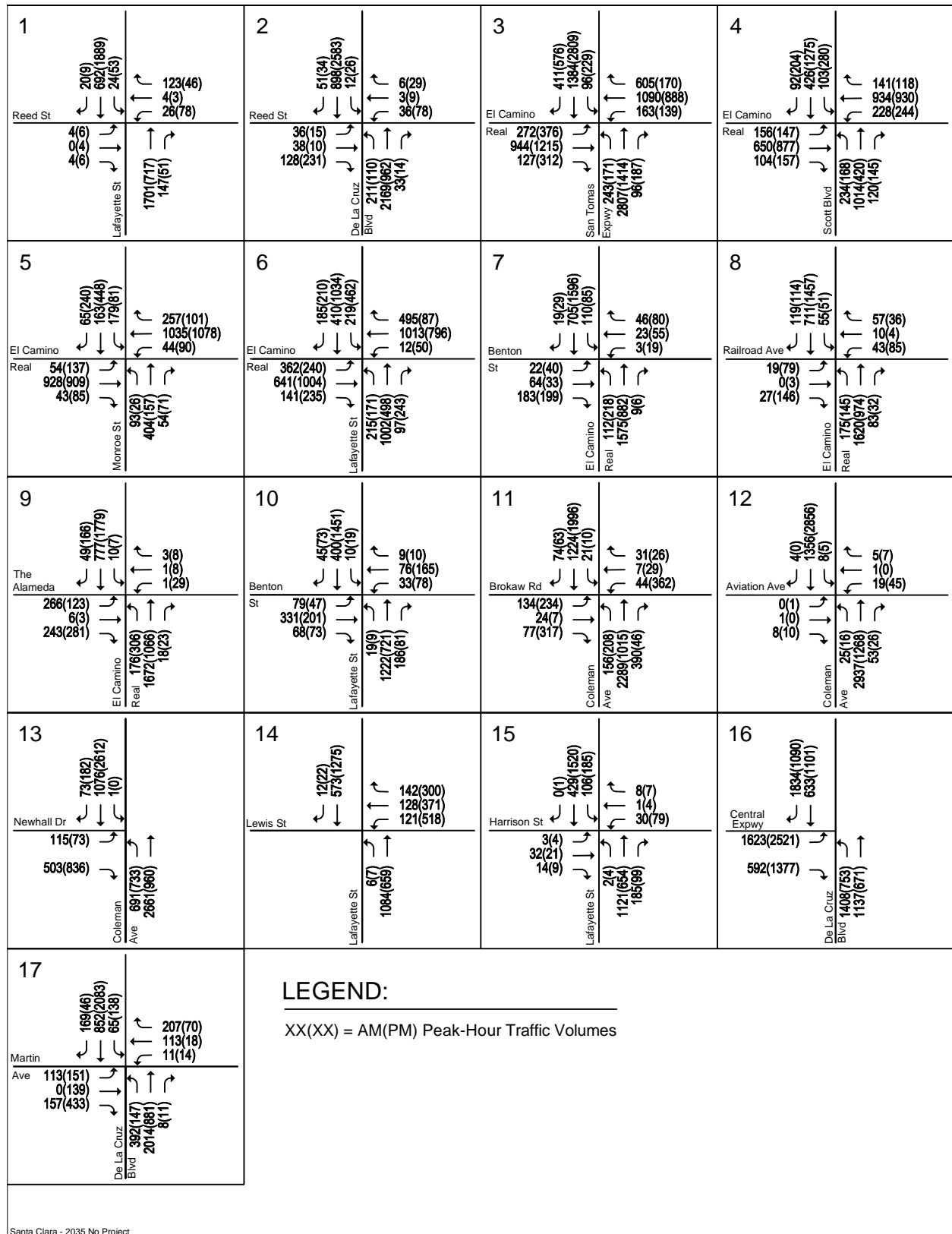

Figure 43
2035 No Project/Phase I Conditions Traffic Volumes – Santa Clara Station

Alum Rock/28th Street Station

The results of the level of service analysis under Year 2035 No Project/Phase I conditions for the Alum Rock/28th Street Station are summarized in Table 38. The results show that the following study intersection is projected to operate at an unacceptable level of service (LOS E or F) during both peak hours, according to City of San Jose level of service standards (see Figure 44).

- (6) King Road and McKee Road (LOS F – AM peak hour, LOS E – PM peak hour)

All other CMP and local San Jose study intersections are projected to operate at an acceptable level of service. The level of service calculation sheets for the Alum Rock/28th Street Station are included in Appendix E.

Diridon Station

The results of the level of service analysis under Year 2035 No Project/Phase I conditions for the Diridon Station are summarized in Table 39. The results show that the following four study intersections are projected to operate at unacceptable levels of service (LOS E or F) during at least one peak hour, according to City of San Jose level of service standards (see Figure 45).

- (1) The Alameda and Taylor Street/Naglee Avenue* (LOS E – AM and PM peak hours)
- (17) South Autumn/Montgomery Street and Park Avenue (LOS E – PM peak hour)
- (22) Bird Avenue and San Carlos Street* (LOS E – PM peak hour)
- (29) Meridian Avenue and Fruitdale Avenue (LOS E – AM and PM peak hours)

However, the two CMP intersections above (#1 and #22) would meet the CMP standard of LOS E. All other CMP and local San Jose study intersections are projected to operate at an acceptable level of service. The level of service calculation sheets for the Diridon Station are included in Appendix F.

Santa Clara Station

The results of the level of service analysis under Year 2035 No Project/Phase I conditions for the Santa Clara Station are summarized in Table 40. The results show that the following study intersections are projected to operate at unacceptable levels of service (LOS E or worse for local City of Santa Clara intersections and LOS F for expressways and CMP intersections) during at least one peak hour, according to City of Santa Clara and CMP level of service standards (see Figure 46). CMP intersections are denoted by an asterisk (*).

- (13) Coleman Avenue and Newhall Drive (LOS E – PM peak hour)
- (14) Lafayette Street and Lewis Street (LOS E – PM peak hour)
- (16) De La Cruz Boulevard and Central Expressway * (LOS F – AM and PM peak hours)

Although the City of Santa Clara does not have a level of service standard for unsignalized intersections, an evaluation of the unsignalized study intersection was performed for informational purposes. The level of service analysis shows that the intersection of Lafayette Street and Harrison Street (#15) is projected to operate at LOS F during both the AM and PM peak hours under Year 2035 No Project/Phase I conditions. However, the peak-hour traffic signal warrant checks indicate that the intersection would not have traffic volumes under 2035 No Project/Phase I conditions that meet thresholds that warrant signalization.

Level of service F at two-way stop-controlled (TWSC) intersections can occur when gaps of traffic on the major street are limited, resulting in long delays for the minor-street traffic as they attempt to enter or cross the major street. At the study intersection of Lafayette Street and Harrison Street, the relatively high traffic volumes along Lafayette Street (major street) cause the delay on the low-volume Harrison Street (minor street) to be worse than the LOS F threshold. However, the low traffic volumes on Harrison Street result in the peak hour traffic signal warrant not being met.

All other CMP and local Santa Clara study intersections currently operate at an acceptable level of service. The level of service calculation sheets for the Santa Clara Station are included in Appendix G.

Table 38
2035 No Project/Phase I Conditions Intersection Levels of Service – Alum Rock/28th Street Station

Study Number	Intersection	Peak Hour	Existing		2035 No Project	
			Avg. Delay	LOS	Avg. Delay	LOS
1	21st Street and East Julian Street	AM	20.9	C	21.3	C
		PM	12.2	B	12.9	B
2	24th Street and East Julian Street	AM	17.2	B	24.2	C
		PM	17.1	B	21.9	C
3	North 28th Street and East Julian Street	AM	27.2	C	27.3	C
		PM	14.2	B	19.5	B
4	US 101 and East Julian Street	AM	23.1	C	29.8	C
		PM	26.8	C	45.4	D
5	US 101 and McKee Road	AM	22.1	C	20.4	C
		PM	26.9	C	28.6	C
6	King Road and McKee Road	AM	46.8	D	98.3	F
		PM	47.2	D	69.1	E
7	17th Street and East Santa Clara Street	AM	6.5	A	22.4	C
		PM	9.3	A	24.3	C
8	24th Street and East Santa Clara Street	AM	19.5	B	22.0	C
		PM	21.1	C	23.1	C
9	North 28th Street and East Santa Clara Street	AM	20.9	C	21.7	C
		PM	18.4	B	19.4	B
10	US 101 and East Santa Clara Street*	AM	11.5	B	13.4	B
		PM	16.2	B	22.5	C
11	US 101 and Alum Rock Avenue*	AM	11.0	B	13.6	B
		PM	15.9	B	25.4	C
12	24th Street and San Antonio Street	AM	16.0	B	19.2	B
		PM	12.6	B	12.7	B
13	24th Street and East William Street	AM	15.8	B	17.7	B
		PM	19.4	B	19.9	B
14	McLaughlin Avenue and I-280 SB*	AM	9.5	A	10.7	B
		PM	14.5	B	14.3	B
15	McLaughlin Avenue and Story Road	AM	42.4	D	46.4	D
		PM	48.5	D	51.4	D
16	21st Street and East Santa Clara Street	AM	5.7	A	6.1	A
		PM	4.6	A	5.0	A
17	26th Street and East Santa Clara Street	AM	16.5	B	16.7	B
		PM	14.4	B	14.0	B

* Denotes CMP Intersection

Entries denoted in **bold** indicate conditions that exceed the applicable level of service standard.



Figure 44
2035 No Project/Phase I Conditions Deficient LOS Intersections – Alum Rock/28th Street Station

Table 39
2035 No Project/Phase I Conditions Intersection Levels of Service – Diridon Station

Study Number	Intersection	Peak Hour	Existing		2035 No Project	
			Avg. Delay	LOS	Avg. Delay	LOS
1	The Alameda and Taylor Street/Naglee Avenue*	AM	45.6	D	76.2	E
		PM	43.4	D	58.9	E
2	Stockton Avenue and West Julian Street	AM	33.8	C	38.5	D
		PM	33.7	C	36.7	D
3	North Montgomery Street and West Julian Street	AM	11.8	B	11.5	B
		PM	11.8	B	13.1	B
4	North Autumn Street and West Julian Street	AM	13.2	B	31.5	C
		PM	13.1	B	47.3	D
5	SR 87 (W) and West Julian Street*	AM	20.8	C	18.7	B
		PM	18.8	B	20.1	C
6	SR 87 (E) and West Julian Street*	AM	53.8	D	52.9	D
		PM	42.3	D	47.9	D
7	The Alameda and West Julian Street	AM	19.0	B	20.2	C
		PM	20.2	C	17.5	B
8	Race Street/Martin Avenue and The Alameda*	AM	37.2	D	39.4	D
		PM	33.0	C	32.3	C
9	Stockton Avenue and The Alameda	AM	24.2	C	34.8	C
		PM	29.5	C	34.7	C
10	Cahill Street and West Santa Clara Street	AM	17.0	B	16.5	B
		PM	18.2	B	17.0	B
11	South Montgomery Street and West Santa Clara Street*	AM	6.2	A	10.8	B
		PM	9.0	A	8.1	A
12	South Autumn Street and West Santa Clara Street*	AM	25.7	C	33.8	C
		PM	21.2	C	37.7	D
13	SR 87 and West Santa Clara Street*	AM	17.9	B	18.9	B
		PM	17.1	B	17.6	B
14	South Montgomery Street and San Fernando Street	AM	9.1	A	5.3	A
		PM	10.4	B	10.7	B
15	South Autumn Street and San Fernando Street	AM	6.7	A	14.8	B
		PM	10.1	B	17.1	B
16	Delmas Avenue and San Fernando Street	AM	5.9	A	12.0	B
		PM	10.2	B	10.3	B
17	South Montgomery Street/Autumn Street and Park Avenue	AM	32.0	C	40.8	D
		PM	38.3	D	63.9	E
18	Delmas Avenue and Park Avenue	AM	23.5	C	26.6	C
		PM	25.1	C	24.2	C
19	Meridian Avenue and San Carlos Street	AM	38.2	D	44.4	D
		PM	47.5	D	54.2	D
20	Race Street and San Carlos Street	AM	36.2	D	34.0	C
		PM	36.7	D	36.6	D
21	Lincoln Avenue and San Carlos Street	AM	34.5	C	37.2	D
		PM	39.8	D	51.8	D
22	Bird Avenue and San Carlos Street*	AM	33.1	C	45.4	D
		PM	39.6	D	55.4	E
23	Bird Avenue and Auzerais Avenue	AM	22.1	C	32.8	C
		PM	26.8	C	27.9	C
24	Meridian Avenue and Parkmoor Avenue	AM	32.2	C	34.9	C
		PM	36.1	D	41.0	D
25	Lincoln Avenue and Parkmoor Avenue	AM	24.3	C	28.3	C
		PM	35.3	D	46.2	D
26	Bird Avenue and I-280 (N)*	AM	29.6	C	36.1	D
		PM	24.4	C	29.8	C
27	Bird Avenue and I-280 (S)*	AM	27.4	C	34.0	C
		PM	22.8	C	36.9	D
28	Southwest Expressway and Fruitdale Avenue	AM	28.7	C	35.0	C
		PM	32.1	C	37.0	D
29	Meridian Avenue and Fruitdale Avenue	AM	45.8	D	77.7	E
		PM	50.4	D	64.6	E

* Denotes CMP Intersection
 Entries denoted in **bold** indicate conditions that exceed the applicable level of service standard.



Figure 45
2035 No Project/Phase I Conditions Deficient LOS Intersections – Diridon Station

Table 40
2035 No Project/Phase I Conditions Intersection Levels of Service – Santa Clara Station

Study Number	Intersection	Peak Hour	Existing		2035 No Project	
			Avg. Delay ¹	LOS	Avg. Delay ¹	LOS
1	Lafayette Street and Reed Street	AM	6.8	A	8.1	A
		PM	7.4	A	7.8	A
2	De La Cruz Boulevard and Reed Street	AM	11.1	B	16.6	B
		PM	18.1	B	19.2	B
3	San Tomas Expressway and El Camino Real *	AM	66.1	E	70.3	E
		PM	79.7	E	80.0	E
4	Scott Boulevard and El Camino Real *	AM	33.8	C	37.6	D
		PM	37.7	D	41.0	D
5	Monroe Street and El Camino Real *	AM	35.5	D	37.2	D
		PM	32.9	C	33.1	C
6	Lafayette Street and El Camino Real *	AM	40.8	D	41.2	D
		PM	41.3	D	40.7	D
7	El Camino Real and Benton Street	AM	12.8	B	14.7	B
		PM	15.4	B	16.6	B
8	El Camino Real and Railroad Avenue	AM	10.5	B	11.0	B
		PM	12.4	B	12.5	B
9	El Camino Real and The Alameda *	AM	13.0	B	19.7	B
		PM	17.2	B	18.6	B
10	Lafayette Street and Benton Street	AM	17.1	B	19.4	B
		PM	15.7	B	15.7	B
11	Coleman Avenue and Brokaw Road	AM	17.0	B	17.3	B
		PM	88.0	F	47.3	D
12	Coleman Avenue and Aviation Avenue	AM	14.6	B	21.6	C
		PM	7.2	A	7.0	A
13	Coleman Avenue and Newhall Drive	AM	15.8	B	28.1	C
		PM	24.1	C	71.8	E
14	Lafayette Street and Lewis Street	AM	10.7	B	12.3	B
		PM	44.9	D	55.2	E
15	Lafayette Street and Harrison Street (unsignalized) ²	AM	48.9	E	³	F
		PM	176.9	F	³	F
16	De La Cruz Boulevard and Central Expressway *	AM	270.6	F	362.0	F
		PM	95.8	F	238.1	F
17	De La Cruz Boulevard and Martin Avenue	AM	34.9	C	36.3	D
		PM	30.7	C	31.9	C

* Denotes CMP Intersection

Entries denoted in **bold** indicate conditions that exceed the applicable level of service standard.

¹The reported delay and corresponding level of service for signalized intersections represents the average delay for all approaches at the intersection. The reported delay and corresponding level of service for unsignalized (two-way stop-controlled) intersections are based on the stop-controlled approach with the highest delay.

²The City of Santa Clara does not have a level of service standard nor impact criteria for unsignalized intersections. Reported intersection delay is presented for informational purposes only.

³Worst approach intersection delay is projected to be greater than 200 seconds per vehicle.

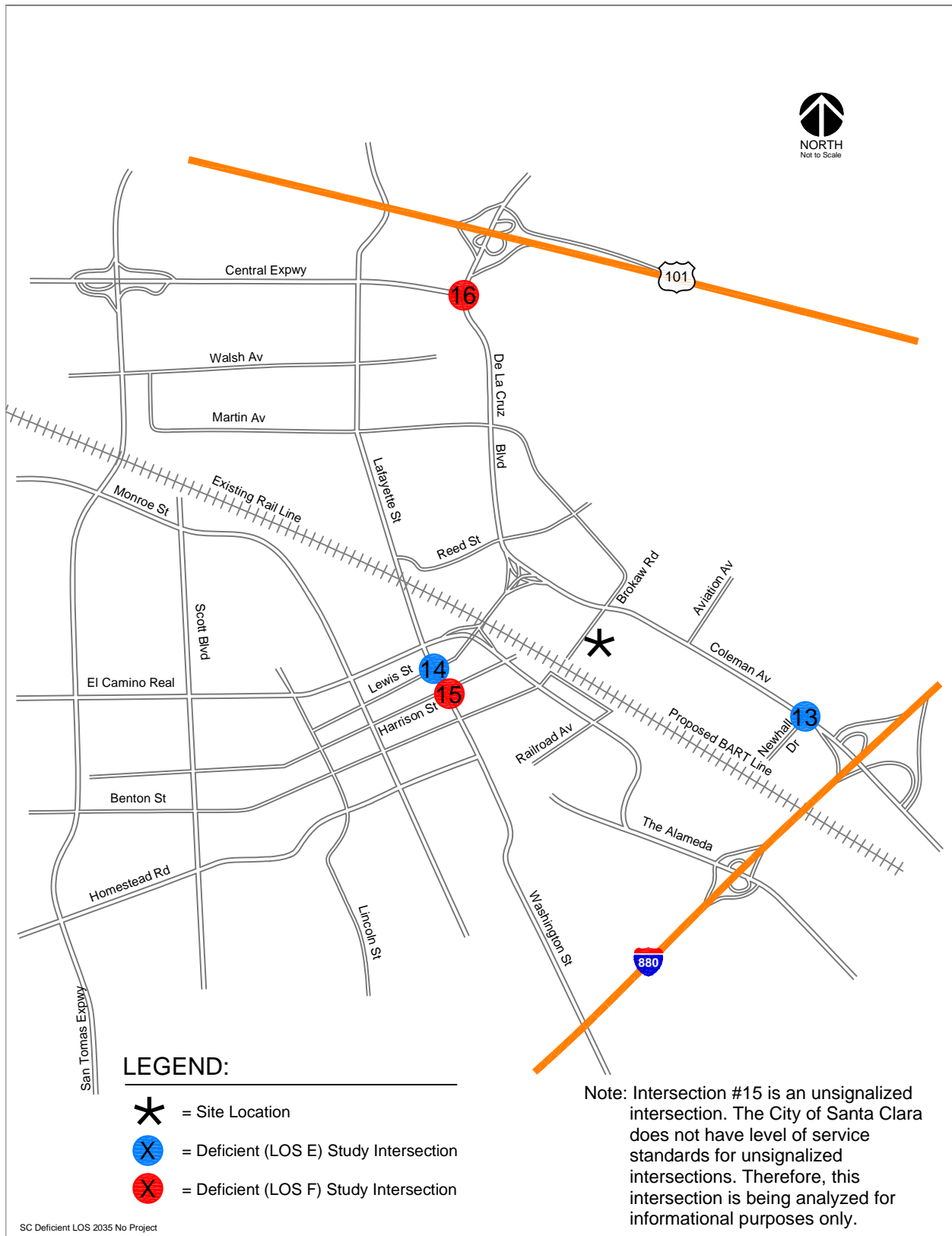

Figure 46
2035 No Project/Phase I Conditions Deficient LOS Intersections – Santa Clara Station

2035 No Project/Phase I Freeway Segment Levels of Service

Year 2035 No Project/Phase I conditions traffic volumes for the study freeway segments were obtained from the VTA Model. No adjustments were made to the volumes produced by the VTA Model since the freeway network contained in the VTA Model is represented more accurately than local roadways.

The results of the analysis under Year 2035 No Project/Phase I conditions are summarized in Tables 41, 42, and 43. The results show that:

- 12 (plus 4 HOV segments) of the 20 directional freeway segments analyzed for the Alum Rock/28th Street Station are projected to operate at an unacceptable LOS F during at least one peak hour.
- 17 (plus 3 HOV segments) of the 18 directional freeway segments analyzed for the Diridon Station are projected to operate at an unacceptable LOS F during at least one peak hour.
- 24 (plus 8 HOV segments) of the 26 directional freeway segments analyzed for the Santa Clara Station are projected to operate at an unacceptable LOS F during at least one peak hour.

2035 No Project/Phase I Freeway Ramp Analysis

The results of the freeway ramp analysis under Year 2035 No Project/Phase I conditions are described below and summarized in Table 44.

Freeway Ramp Lane Geometrics

The lane geometrics at the study freeway ramps were assumed to be the same as described under existing conditions. However, it was assumed that under Year 2035 No Project/Phase I conditions, the on-ramp meters would be operational.

Capacities at the freeway on-ramps with ramp metering are dependent on the ramp meter rate. As discussed in the introduction section of this report, based on Caltrans' maximum meter rate output for District 4, metered on-ramps will serve a maximum of 900 total vehicles during an hour.

Freeway Ramp Volumes

Traffic volumes on each of the freeway ramps were derived from the forecasted turn-movement volumes at the adjacent ramp intersections.

Freeway Ramp Queue Lengths

Based on the projected queue lengths obtained from TRAFFIX, it was determined that the available queue storage space for the freeway off-ramps studied would be sufficient to serve the projected demand under Year 2035 No Project/Phase I conditions.

The queue length projections for the freeway on-ramps show that the on-ramps studied would experience excessive queue lengths that would spill out of the ramps onto the adjacent street under Year 2035 No Project/Phase I conditions. This is the result of the of the projected on-ramp demand exceeding the assumed ramp capacity.

It should be noted that these projections assume a very conservative meter rate of 900 vph for the entire peak hour analyzed.

The projected queue lengths under Year 2035 No Project/Phase I conditions are summarized in Table 44 below.

Table 41
2035 No Project/Phase I Conditions Freeway Levels of Service – Alum Rock/28th Street Station

Freeway	Segment	Direction	Peak Hour	Mixed-Flow Lane					HOV Lane				
				Avg. Speed	# of Lanes	Volume	Density	LOS	Avg. Speed	# of Lanes	Volume	Density	LOS
US 101	Tully to Story	NB	AM	25.0	3.0	8,875	118	F	15.0	1.0	2140	143	F
			PM	66.0	3.0	7,774	39	D	70.0	1.0	1508	22	C
US 101	Story to I-280	NB	AM	22.0	3.0	5,160	78	F	19.0	1.0	1556	82	F
			PM	67.0	3.0	3,772	19	C	70.0	1.0	830	12	B
US 101	I-280 to Santa Clara	NB	AM	13.0	3.0	7,723	198	F	13.0	1.0	1781	137	F
			PM	66.0	3.0	5,667	29	D	70.0	1.0	875	13	B
US 101	Santa Clara to McKee	NB	AM	11.0	3.0	7,941	241	F	16.0	1.0	1570	98	F
			PM	66.0	3.0	5,548	28	D	70.0	1.0	769	11	A
I-280	10th to McLaughlin	EB	AM	66.0	4.0	7,678	29	D	55.0	1.0	418	8	A
			PM	54.0	4.0	10,436	48	E	55.0	1.0	1239	23	C
I-280	McLaughlin to US 101	EB	AM	66.0	4.0	5,731	22	C	55.0	1.0	418	8	A
			PM	54.0	4.0	6,973	32	D	55.0	1.0	1239	23	C
I-680	US 101 to King	NB	AM	33.0	4.0	5,648	43	D	55.0	1.0	418	8	A
			PM	66.0	4.0	6,710	25	C	55.0	1.0	1239	23	C
I-680	King to Capitol	NB	AM	20.0	5.0	7,755	78	F	55.0	1.0	418	8	A
			PM	47.0	5.0	10,087	43	D	55.0	1.0	1239	23	C
I-680	Capitol to Alum Rock	NB	AM	18.0	4.0	6,435	89	F	55.0	1.0	625	11	A
			PM	65.0	4.0	7,238	28	D	55.0	1.0	1181	21	C
I-680	Alum Rock to McKee	NB	AM	27.0	4.0	7,370	68	F	55.0	1.0	847	15	B
			PM	66.0	4.0	7,732	29	D	55.0	1.0	1192	22	C
I-680	McKee to Alum Rock	SB	AM	63.0	4.0	7,585	30	D	55.0	1.0	1402	25	C
			PM	47.0	4.0	7,577	40	D	55.0	1.0	685	12	B
I-680	Alum Rock to Capitol	SB	AM	23.0	4.0	7,323	80	F	55.0	1.0	1402	25	C
			PM	65.0	4.0	5,973	23	C	55.0	1.0	685	12	B
I-680	Capitol to King	SB	AM	21.0	4.0	10,226	122	F	55.0	1.0	1469	27	D
			PM	66.0	4.0	7,969	30	D	55.0	1.0	512	9	A
I-680	King to US 101	SB	AM	12.0	4.0	6,640	138	F	55.0	1.0	1469	27	D
			PM	66.0	4.0	5,372	20	C	55.0	1.0	512	9	A
I-280	US 101 to McLaughlin	WB	AM	14.0	4.0	6,640	119	F	55.0	1.0	1469	27	D
			PM	66.0	4.0	5,372	20	C	55.0	1.0	512	9	A
I-280	McLaughlin to 10th	WB	AM	19.0	4.0	10,841	143	F	55.0	1.0	1469	27	D
			PM	65.0	4.0	8,084	31	D	55.0	1.0	512	9	A
US 101	McKee to Santa Clara	SB	AM	67.0	3.0	5,178	26	C	67.0	1.0	739	11	A
			PM	62.0	3.0	6,947	37	D	70.0	1.0	1542	22	C
US 101	Santa Clara to I-280	SB	AM	67.0	3.0	5,815	29	D	67.0	1.0	831	12	B
			PM	63.0	3.0	7,207	38	D	70.0	1.0	1649	24	C
US 101	I-280 to Story	SB	AM	67.0	3.0	3,896	19	C	67.0	1.0	736	11	A
			PM	54.0	3.0	4,974	31	D	70.0	1.0	1263	18	B
US 101	Story to Tully	SB	AM	66.0	4.0	8,602	33	D	67.0	1.0	1203	18	B
			PM	45.0	4.0	10,026	56	E	70.0	1.0	1633	23	C

Source: Santa Clara Valley Transportation Authority Congestion Management Program Monitoring Study, 2014.
 The average speed for future HOV lanes are assumed to be 55 MPH.

Bold indicates unacceptable LOS.

Table 42
2035 No Project/Phase I Conditions Freeway Levels of Service – Diridon Station

Freeway Segment	Direction	Peak Hour	Mixed-Flow Lane						HOV Lane				
			Avg. Speed	# of Lanes	Volume	Density	LOS	Avg. Speed	# of Lanes	Volume	Density	LOS	
SR 87 Curtner to Almaden Expressway	NB	AM	13.0	2.0	3,791	146	F	22.0	1.0	1792	81	F	
		PM	65.0	2.0	3,251	25	C	70.0	1.0	792	11	A	
SR 87 Almaden Expressway to Alma	NB	AM	29.0	2.0	4,772	82	F	43.0	1.0	2076	48	E	
		PM	41.0	2.0	3,987	49	E	70.0	1.0	869	12	B	
SR 87 Alma to I-280	NB	AM	33.0	2.0	5,783	88	F	61.0	1.0	2132	35	D	
		PM	66.0	2.0	4,512	34	D	70.0	1.0	943	13	B	
SR 87 I-280 to Julian	NB	AM	16.0	2.0	3,292	103	F	30.0	1.0	1425	48	E	
		PM	67.0	2.0	1,859	14	B	70.0	1.0	422	6	A	
SR 87 Julian to Coleman	NB	AM	14.0	2.0	4,676	167	F	32.0	1.0	1675	52	E	
		PM	67.0	2.0	2,914	22	C	70.0	1.0	568	8	A	
I-280 I-880 to Meridian	EB	AM	66.0	4.0	6,643	25	C	67.0	1.0	757	11	A	
		PM	17.0	4.0	7,333	108	F	20.0	1.0	1632	82	F	
I-280 Meridian to Bird	EB	AM	61.0	4.0	8,664	36	D	55.0	1.0	465	8	A	
		PM	21.0	4.0	9,398	112	F	55.0	1.0	1352	25	C	
I-280 Bird to SR 87	EB	AM	66.0	4.0	4,532	17	B	55.0	1.0	465	8	A	
		PM	25.0	4.0	5,924	59	F	55.0	1.0	1352	25	C	
I-280 SR 87 to 10th	EB	AM	67.0	4.0	6,416	24	C	55.0	1.0	465	8	A	
		PM	27.0	4.0	8,732	81	F	55.0	1.0	1352	25	C	
I-280 10th to SR 87	WB	AM	21.0	4.0	10,240	122	F	55.0	1.0	1541	28	D	
		PM	65.0	4.0	8,418	32	D	55.0	1.0	536	10	A	
I-280 SR 87 to Bird	WB	AM	20.0	4.0	6,170	77	F	55.0	1.0	1541	28	D	
		PM	62.0	4.0	5,343	22	C	55.0	1.0	536	10	A	
I-280 Bird to Meridian	WB	AM	18.0	4.0	9,805	136	F	55.0	1.0	1541	28	D	
		PM	58.0	4.0	9,002	39	D	55.0	1.0	536	10	A	
I-280 Meridian to I-880	WB	AM	14.0	3.0	7,688	183	F	26.0	1.0	1807	70	F	
		PM	66.0	3.0	6,709	34	D	70.0	1.0	826	12	B	
SR 87 Coleman to Julian	SB	AM	66.0	2.0	2,553	19	C	67.0	1.0	271	4	A	
		PM	32.0	2.0	4,030	63	F	50.0	1.0	1221	24	C	
SR 87 Julian to I-280	SB	AM	67.0	2.0	2,871	21	C	67.0	1.0	337	5	A	
		PM	36.0	2.0	4,644	65	F	70.0	1.0	1333	19	C	
SR 87 I-280 to Alma	SB	AM	67.0	2.0	3,764	28	D	67.0	1.0	684	10	A	
		PM	15.0	2.0	3,794	126	F	60.0	1.0	1839	31	D	
SR 87 Alma to Almaden Expressway	SB	AM	66.0	2.0	3,946	30	D	67.0	1.0	661	10	A	
		PM	27.0	2.0	4,483	83	F	60.0	1.0	1799	30	D	
SR 87 Almaden Expressway to Curtner	SB	AM	66.0	2.0	2,997	23	C	67.0	1.0	575	9	A	
		PM	36.0	2.0	3,487	48	E	70.0	1.0	1568	22	C	

Source: Santa Clara Valley Transportation Authority Congestion Management Program Monitoring Study, 2014.
 The average speed for future HOV lanes are assumed to be 55 MPH.
Bold indicates unacceptable LOS.

Table 43
2035 No Project/Phase I Conditions Freeway Levels of Service – Santa Clara Station

Freeway	Segment	Direction	Peak Hour	Mixed-Flow Lane					HOV Lane				
				Avg. Speed	# of Lanes	Volume	Density	LOS	Avg. Speed	# of Lanes	Volume	Density	LOS
US 101	I-880 to Old Bayshore	NB	AM	14.0	3.0	6,050	144	F	19.0	1.0	1912	101	F
			PM	67.0	3.0	3,737	19	C	70.0	1.0	621	9	A
US 101	Old Bayshore to First	NB	AM	12.0	3.0	6,353	176	F	13.0	1.0	1797	138	F
			PM	66.0	3.0	4,205	21	C	70.0	1.0	610	9	A
US 101	First to SR 87	NB	AM	19.0	3.0	6,820	120	F	19.0	1.0	1622	85	F
			PM	67.0	3.0	5,239	26	C	70.0	1.0	729	10	A
US 101	SR 87 to De La Cruz	NB	AM	12.0	3.0	6,717	187	F	14.0	1.0	1591	114	F
			PM	66.0	3.0	5,642	28	D	70.0	1.0	729	10	A
US 101	De La Cruz to Montague	NB	AM	26.0	3.0	6,644	85	F	39.0	1.0	2141	55	E
			PM	65.0	3.0	5,597	29	D	70.0	1.0	1236	18	B
US 101	Montague to Great America	NB	AM	21.0	3.0	6,797	108	F	41.0	1.0	1730	42	D
			PM	58.0	3.0	5,921	34	D	70.0	1.0	1304	19	C
I-880	I-280 to Stevens Creek	NB	AM	15.0	3.0	5,221	116	F	55.0	1.0	662	12	B
			PM	66.0	3.0	4,903	25	C	55.0	1.0	648	12	B
I-880	Stevens Creek to Bascom	NB	AM	20.0	3.0	6,870	115	F	55.0	1.0	661	12	B
			PM	16.0	3.0	5,711	119	F	55.0	1.0	648	12	B
I-880	Bascom to The Alameda	NB	AM	27.0	3.0	6,230	77	F	55.0	1.0	710	13	B
			PM	13.0	3.0	6,258	160	F	55.0	1.0	731	13	B
I-880	The Alameda to Coleman	NB	AM	31.0	3.0	6,508	70	F	55.0	1.0	745	14	B
			PM	15.0	3.0	6,625	147	F	55.0	1.0	947	17	B
I-880	Coleman to SR 87	NB	AM	22.0	3.0	6,193	94	F	55.0	1.0	859	16	B
			PM	24.0	3.0	6,600	92	F	55.0	1.0	1100	20	C
I-880	SR 87 to First	NB	AM	48.0	3.0	6,193	43	D	55.0	1.0	859	16	B
			PM	22.0	3.0	6,600	100	F	55.0	1.0	1100	20	C
I-880	First to US 101	NB	AM	36.0	3.0	5,840	54	E	55.0	1.0	690	13	B
			PM	51.0	3.0	7,053	46	D	55.0	1.0	951	17	B
I-880	US 101 to First	SB	AM	16.0	3.0	6,291	131	F	55.0	1.0	1000	18	B
			PM	14.0	3.0	5,840	139	F	55.0	1.0	915	17	B
I-880	First to SR 87	SB	AM	25.0	3.0	5,831	78	F	55.0	1.0	1049	19	C
			PM	14.0	3.0	5,734	137	F	55.0	1.0	1010	18	B
I-880	SR 87 to Coleman	SB	AM	65.0	3.0	5,831	30	D	55.0	1.0	1049	19	C
			PM	23.0	3.0	5,734	83	F	55.0	1.0	1010	18	B
I-880	Coleman to The Alameda	SB	AM	66.0	3.0	6,401	32	D	55.0	1.0	755	14	B
			PM	23.0	3.0	6,746	98	F	55.0	1.0	851	15	B
I-880	The Alameda to Bascom	SB	AM	66.0	3.0	6,021	30	D	55.0	1.0	694	13	B
			PM	25.0	3.0	6,565	88	F	55.0	1.0	927	17	B
I-880	Bascom to Stevens Creek	SB	AM	50.0	3.0	6,002	40	D	55.0	1.0	695	13	B
			PM	30.0	3.0	6,638	74	F	55.0	1.0	951	17	B
I-880	Stevens Creek to I-280	SB	AM	66.0	3.0	4,617	23	C	55.0	1.0	592	11	A
			PM	65.0	3.0	4,719	24	C	55.0	1.0	864	16	B
US 101	Great America to Montague	SB	AM	66.0	3.0	6,124	31	D	67.0	1.0	1281	19	C
			PM	14.0	3.0	6,908	164	F	20.0	1.0	1784	89	F
US 101	Montague to De La Cruz	SB	AM	66.0	3.0	5,663	29	D	67.0	1.0	1227	18	B
			PM	13.0	3.0	6,431	165	F	40.0	1.0	2047	51	E
US 101	De La Cruz to SR 87	SB	AM	62.0	3.0	6,688	36	D	67.0	1.0	1137	17	B
			PM	18.0	3.0	8,295	154	F	50.0	1.0	2082	42	D
US 101	SR 87 to First	SB	AM	67.0	3.0	4,736	24	C	67.0	1.0	884	13	B
			PM	16.0	3.0	6,135	128	F	30.0	1.0	1837	61	F
US 101	First to Old Bayshore	SB	AM	67.0	3.0	3,543	18	B	67.0	1.0	642	10	A
			PM	6.0	3.0	4,975	276	F	20.0	1.0	1598	80	F
US 101	Old Bayshore to I-880	SB	AM	67.0	3.0	4,549	23	C	67.0	1.0	724	11	A
			PM	8.0	3.0	6,192	258	F	30.0	1.0	1824	61	F

Source: Santa Clara Valley Transportation Authority Congestion Management Program Monitoring Study, 2014.
 The average speed for future HOV lanes are assumed to be 55 MPH.
Bold indicates unacceptable LOS.

Table 44
2035 No Project/Phase I Conditions Freeway Ramp Queuing Analysis

Freeway Ramp	Total Storage (Vehicle) ¹	Volume and Queue Projections (Vehicles)	
		Existing	2035 No Project
<u>US 101 at McKee Road Interchange</u>			
US 101 SB On-Ramp at McKee Road	32		
PM Volume ²		1131	1476
Projected Queue Length ³		-- ⁵	576
US 101 SB Loop Off-Ramp at McKee Road	92		
AM Volume ²		426	470
Projected Queue Length ⁴		27	30
<u>US 101 at Santa Clara Street/Alum Rock Avenue Interchange</u>			
US 101 SB On-Ramp at Santa Clara Street	34		
PM Volume ²		949	1397
Projected Queue Length ³		-- ⁵	497
US 101 NB Off-Ramp at Alum Rock Avenue	67		
AM Volume ²		244	407
Projected Queue Length ⁴		10	14
PM Volume ²		695	984
Projected Queue Length ⁴		24	43
Notes:			
¹ Total number of vehicles that can store within the ramp.			
² Peak-hour ramp volume projections.			
³ Total number of vehicles in the queue, as calculated based on the ramp meter rate and projected traffic volumes.			
⁴ Total number of vehicles in the queue, as obtained from TRAFFIX.			
⁵ Currently, the ramp meter at these on-ramps is not operational during the PM peak hour, therefore, no measurable queues are currently experienced at these locations.			
Bold queue lengths exceed the available queue storage capacity within the ramp.			

8.

Year 2035 Phase II Project Conditions – Alum Rock/28th Street Station

This chapter describes traffic conditions in the year 2035 with the proposed Phase II Project. Alum Rock/28th Street Station is one of the four stations proposed along the Phase II Project corridor that would provide for the extension of BART service to the Cities of San Jose and Santa Clara (see Figure 1). Year 2035 Phase II Project conditions analyzed traffic conditions for the year 2035 in the vicinity of the Alum Rock/28th Street Station with the addition of the proposed four BART Stations. The analysis includes intersection and freeway segment level of service analysis.

A detailed description of the method used to estimate station-generated traffic is included in Chapter 4 of this report. Estimates of the station-generated traffic, identification of impacts, and recommended mitigation measures for the Alum Rock/28th Street Station under Year 2035 Phase II Project conditions also are included within this chapter. Year 2035 Phase II Project conditions were evaluated relative to Year 2035 No Project/Phase I conditions in order to determine potential project impacts on the future transportation network. The significant impact criteria are discussed in Chapter 1 of this report.

Although some of the information provided below has already been described in previous chapters, it is presented again within this chapter for the reader's convenience.

Intersection and Freeway Analysis Methodology – All Stations

Trip Generation, Distribution and Assignment

As previously described, trip generation for the proposed stations was estimated based on passenger projections for the station obtained from the VTA Model. A detailed description of the method used to estimate station-generated traffic is included in Chapter 4. Actual trip generation estimates for the proposed Alum Rock/28th Street Station under 2035 Phase II Project conditions are presented in subsequent sections within this chapter.

Distribution patterns and assignment of station-generated traffic (PNR and KNR trips) for the Year 2035 Phase II Project conditions were obtained from the VTA Model.

2035 Phase II Project Conditions Intersection Lane Configurations

The intersection lane configurations under the 2035 Phase II Project conditions were assumed to be the same as described under 2025 No Project/Phase I conditions.

2035 Phase II Project Conditions Intersection Traffic Volumes

Traffic volumes for the Year 2035 Phase II Project conditions were obtained from the VTA Model. These traffic volumes represent traffic projections for the year 2035 with the addition of planned improvements and the Phase II Project and proposed stations. Year 2035 Phase II Project conditions model volume forecasts were adjusted using the method previously described (Introduction chapter).

2035 Phase II Project Conditions Freeway Volumes

Traffic volumes for the Year 2035 Phase II Project conditions for the study freeway segments were obtained from the VTA Model. These volumes represent traffic projections for the year 2035 with the addition of planned improvements and the Phase II Project and proposed stations. Unlike intersection forecast volumes, no adjustments were made to the freeway volumes produced by the VTA Model since the freeway network contained in the VTA Model is represented more accurately than local roadways.

Station Description – Alum Rock/28th Street Station

The proposed Alum Rock/28th Street Station site is located on the east side of North 28th Street, between McKee Road and East Santa Clara Street (see Figure 2). A detailed description of proposed Alum Rock/28th Street Station is included in Chapters 1 and 4.

Station Trip Generation Estimates – Alum Rock/28th Street Station

The trip generation estimates for the proposed Alum Rock/28th Street Station under the year 2035 Phase II Project conditions were developed using the VTA Model and based on the method previously described. Ridership projections total about 15,000 daily BART riders (7,500 boardings and 7,500 alightings) at the Alum Rock/28th Street Station under the year 2035 Phase II Project conditions. Table 45 presents the daily and peak hour trip generation estimates for each of the drive access modes to the Alum Rock/28th Street Station, described in the following sections.

Park-and-Ride Trips

Model projections of passenger volumes for the Alum Rock/28th Street Station indicate that 3,421 daily PNR trips would access/egress the station under the Year 2035 Phase II Project conditions. A total of 476 (460 inbound and 16 outbound) and 401 (42 inbound and 359 outbound) PNR trips are estimated to occur during the AM and PM peak hours, respectively.

Kiss-and-Ride Trips

Model projections of passenger volumes for the Alum Rock/28th Street Station indicate that 506 daily KNR trips would utilize the station under the Year 2035 Phase II Project conditions scenario. Since KNR trips consist of vehicles entering the station site to drop-off a BART commuter and then exiting the site and proceeding on to another destination, station trip generation estimates for peak hour inbound and outbound KNR vehicle trips are equivalent. It is estimated that a total of 98 (49 inbound/49 outbound) KNR trips would occur during the AM peak hour and a total of 116 (58 inbound/58 outbound) KNR trips would occur during the PM peak hour.

**Table 45
Alum Rock/28th Street Station Trip Generation Estimates – 2035 Phase II Project Conditions**

Mode of Access by Station	Daily Trips	Parking Demand (# of Spaces)	AM Peak Hour Trips			PM Peak Hour Trips		
			In	Out	Total	In	Out	Total
<i>Alum Rock Station:</i>								
Kiss and Ride Trips	506		49	49	98	58	58	116
Park and Ride Trips	3,421	1555	460	16	476	42	359	401
Total	3,927		509	65	574	100	417	517

Source: VTA Model, December 2014.

Trip Distribution and Assignment

Distribution pattern and assignment of station-generated traffic (PNR and KNR trips) to the proposed Alum Rock/28th Street Station under the Year 2035 Phase II Project conditions were developed from traffic assignments using the VTA Model. As mentioned previously, implementation of the proposed project would result in a shift in travel patterns, as the result of some commuters modifying their travel route to access the station area, and in the removal of auto trips from the roadway network, as some commuters shift from auto to transit modes of travel. Thus, station-generated traffic consists of two components: 1.) new vehicular trips accessing the proposed Alum Rock/28th Street Station, referred to as *station drive access* trips, and 2.) all the trips that would no longer be on the roadway as a result of the Phase II Project, represented by negative trips on the roadway network. It is projected that under Year 2035 Phase II Project conditions, approximately 1,400 and 1,150 AM and PM peak-hour trips, respectively, would be removed from the roadway transportation system as the result of the Phase II Project and proposed Stations. The total *net project trips* generated by the Alum Rock/28th Street Station are therefore calculated by adding the new station drive access trips (positive trips) and the trips removed from the roadway network as a result of the Alum Rock/28th Street Station and Phase II Project (negative trips). The Alum Rock/28th Street Station drive access trips for the Year 2035 Phase II Project conditions are shown graphically on Figure 47 while the net project trips are shown on Figure 48.

An example of the trip assignment process and method used to estimate traffic with the project is presented in Chapter 4.

The trip assignment process shows that at some locations, particularly for those movements leading directly to the station area, the number of vehicles accessing the station is larger than the number of vehicles shifted from the roadway network to transit modes, thus, the project results in a net increase in traffic volumes. At many locations, particularly for those movements either not leading to the station area or leading to freeways, the number of vehicles shifted from the roadway network to transit modes is greater than the number of vehicles using that movement to access the station, and the project results in a net decrease in traffic volumes.

2035 Phase II Project Conditions Traffic Volumes

Traffic volumes for the Year 2035 Phase II Project conditions were obtained by adding to the Year 2035 No Project/Phase I traffic volumes the traffic projected to be generated by the proposed BART Stations (net project trips, as described above). The net project traffic projections under the Year 2035 Phase II Project conditions were obtained from the VTA Model.

The Year 2035 Phase II Project conditions traffic volumes are presented on Figure 49 and included in Appendix D.

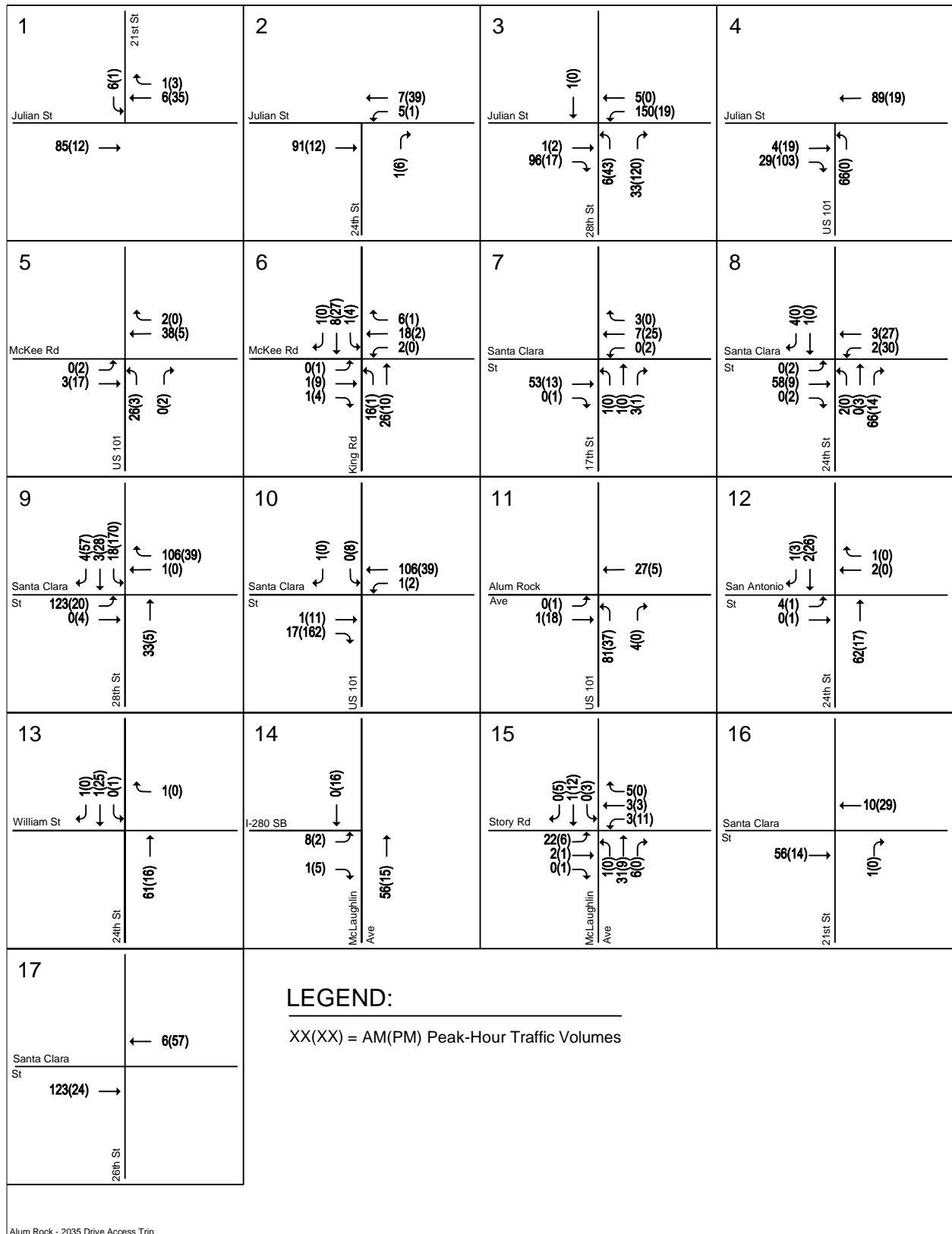

Figure 47
 2035 Phase II Project Conditions Station (Drive Access) Trips – Alum Rock/28th Street Station

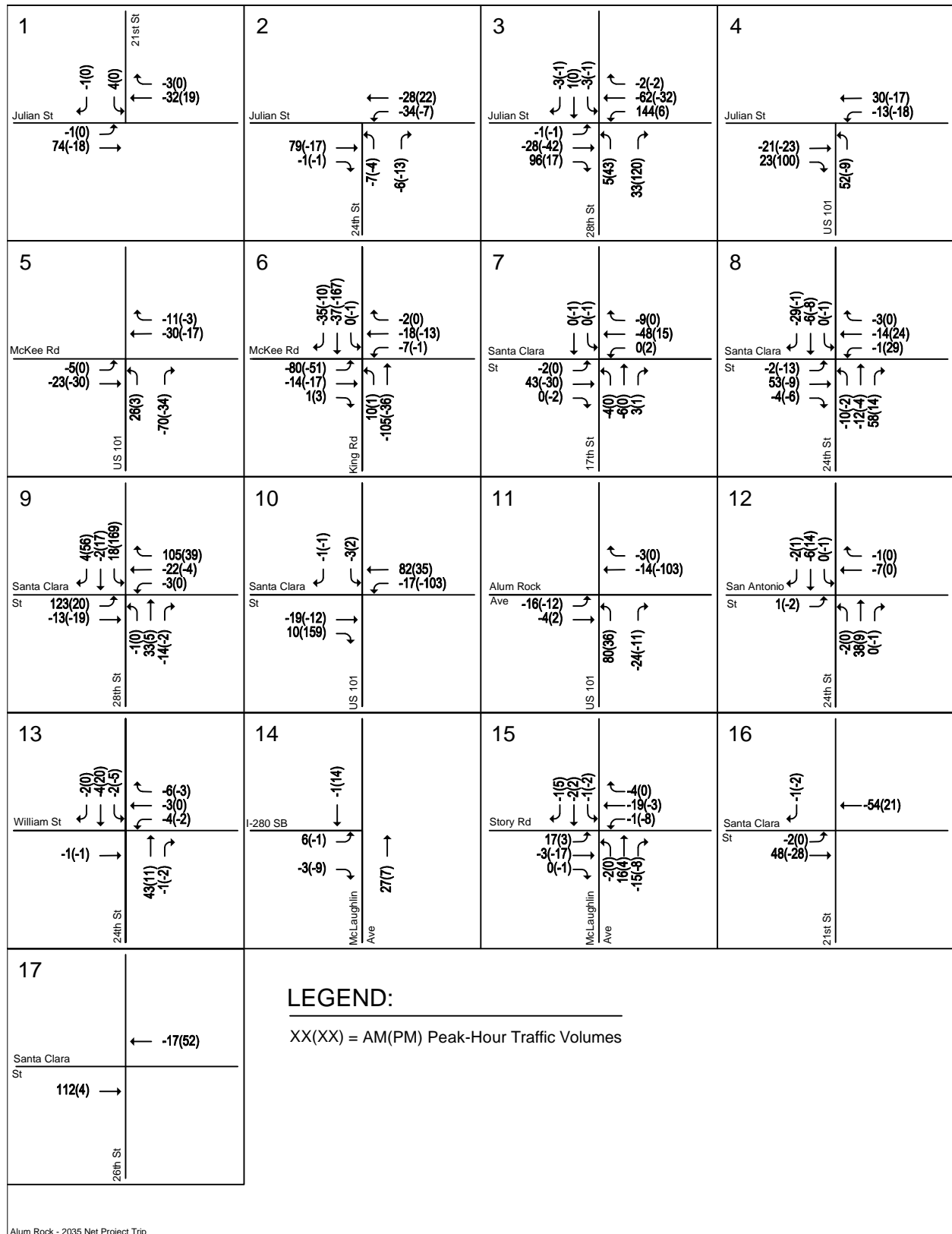

Figure 48
 2035 Phase II Project Conditions Net Project Trips – Alum Rock/28th Street Station

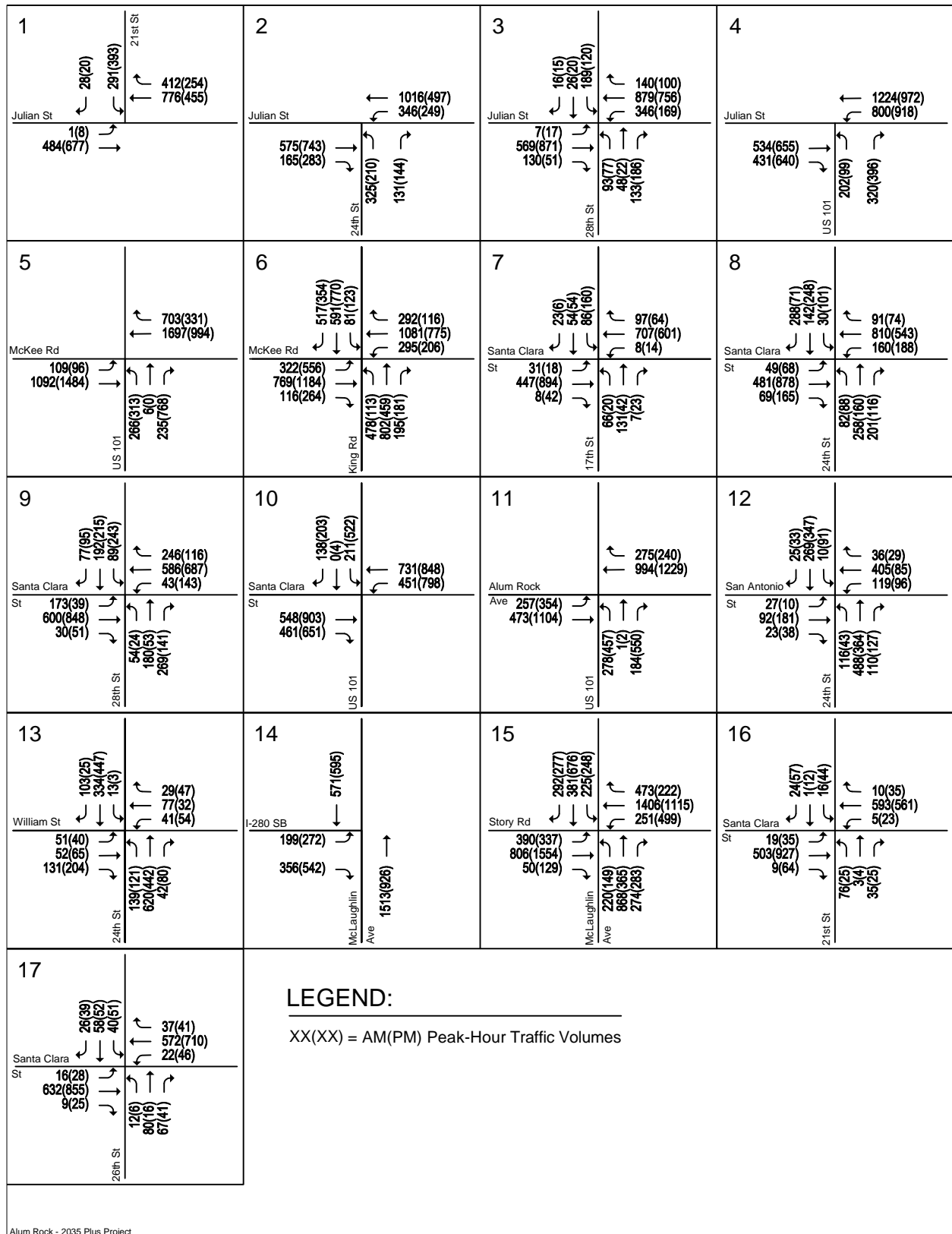

Figure 49
 2035 Phase II Project Conditions Traffic Volumes – Alum Rock/28th Street Station

2035 Phase II Project Conditions Intersection Levels of Service

The results of the level of service analysis for the Alum Rock/28th Street Station under the Year 2035 Phase II Project conditions are summarized in Table 46. The results show that the same study intersection identified to operate at unacceptable levels under Year 2035 No Project/Phase I conditions is projected to continue to operate at unacceptable levels of service during both peak hours (see Figure 50).

(6) King Road and McKee Road (LOS F – AM peak hour, LOS E – PM peak hour)

When measured against the City of San Jose significant impact criteria for 2035 conditions, the intersection of King Road and McKee Road would not be significantly impacted by the project under 2035 Phase II Project Conditions. The City of San Jose's significant impact criteria under cumulative conditions requires comparison of 2025 No Project/Phase I conditions and 2035 Phase II Project conditions to see if the Project would contribute a considerable amount (more than 25%) of the total increase in traffic between those two conditions. The Project's contribution to the increase in total volume from 2025 No Project/Phase I Conditions to 2035 Phase II Project Conditions would be less than 25 percent, since the 2035 Project Phase II project would result in 287 **fewer** vehicles during the AM peak hour and 292 **fewer** vehicles during the PM peak hour, compared to 2025 No Project/Phase I conditions. As shown in Figure 48, the net project trips at this intersection, when all turning movements are added together, is a negative number for both the AM and PM peak hours. Therefore, the Project would not have a significant impact on this intersection under 2035 Phase II Project Conditions, based on the City of San Jose significant impact criteria, and no mitigation is required.

Based on the CMP level of service impact criteria, the proposed project would not cause an adverse impact that would exceed the significance thresholds at any of the CMP study intersections in the vicinity of the Alum Rock/28th Street Station. Therefore, no mitigation is required. All other study intersections are projected to operate at an acceptable level of service under both City of San Jose and CMP standards. The level of service calculation sheets for the Alum Rock/28th Street Station are included in Appendix E.

2035 Phase II Project Conditions Freeway Segment Levels of Service

Traffic volumes for the Year 2035 Phase II Project conditions for the study freeway segments were obtained from the VTA Model. These volumes represent traffic projections for the year 2035 with the addition of planned improvements and the Phase II Project and proposed stations. Note that the project would result in a decrease in traffic volumes on the freeway network, as commuters use BART as an alternative to regional freeway travel. While a portion of traffic accessing the station areas would use the freeway network to do so, generally those trips are already on the freeway network and do not represent an increase in traffic from Year 2035 No Project/Phase I conditions. However, a number of others accessing the station would do so via transit or local streets, and therefore would result in a net reduction in freeway volumes. The net reduction in peak hour freeway volumes along the study freeway segments as a result of the implementation of the Phase II Project and the Alum Rock/28th Street Station are presented in Table 47.

The results of the freeway analysis are summarized in Table 47. The results show that 12 of the 20 directional freeway segments (and 4 HOV segments) analyzed for the Alum Rock/28th Street Station would operate at an unacceptable LOS F during at least one of the peak hours. Since the project would not add traffic representing one percent or more of the segment's capacity to any of the study freeway segments projected to operate at LOS F (including HOV segments), the project would not cause an adverse impact that would exceed the significance thresholds on any of the freeway segments analyzed under the Year 2035 Phase II Project conditions, according to VTA CMP level of service impact criteria for freeways. Therefore, mitigation is not required.

Table 46
2035 Phase II Project Conditions Intersection Levels of Service – Alum Rock/28th Street Station

Study Number	Intersection	Peak Hour	2025 No Project		2035 No Project		2035 Phase II Project			
			Avg. Delay	LOS	Avg. Delay	LOS	Avg. Delay	LOS	Incr. In Crit. Delay	Incr. In Crit. V/C
1	21st Street and East Julian Street	AM	22.4	C	21.3	C	19.1	B	-2.0	-0.019
		PM	12.5	B	12.9	B	12.9	B	0.1	0.004
2	24th Street and East Julian Street	AM	20.7	C	24.2	C	24.3	C	0.2	0.020
		PM	20.9	C	21.9	C	21.1	C	-0.8	-0.017
3	North 28th Street and East Julian Street	AM	26.9	C	27.3	C	27.7	C	24.5	0.064
		PM	17.6	B	19.5	B	23.5	C	3.5	0.021
4	US 101 and East Julian Street	AM	24.4	C	29.8	C	32.7	C	4.4	0.024
		PM	68.1	E	45.4	D	46.8	D	3.5	0.011
5	US 101 and McKee Road	AM	20.7	C	20.4	C	20.9	C	1.2	0.004
		PM	26.7	C	28.6	C	28.2	C	-0.7	-0.018
6	King Road and McKee Road	AM	73.4	E	98.3	F	87.7	F	-6.6	-0.025
		PM	64.2	E	69.1	E	60.0	E	-13.5	-0.056
7	17th Street and East Santa Clara Street	AM	20	B	22.4	C	22.8	C	0.3	-0.010
		PM	22.7	C	24.3	C	24.4	C	0.0	-0.006
8	24th Street and East Santa Clara Street	AM	21.1	C	22.0	C	21.5	C	-0.8	-0.029
		PM	22.9	C	23.1	C	23.5	C	0.8	0.008
9	North 28th Street and East Santa Clara Street	AM	21.4	C	21.7	C	23.6	C	3.8	0.084
		PM	18.6	B	19.4	B	22.2	C	3.5	0.111
10	US 101 and East Santa Clara Street*	AM	13	B	13.4	B	13.0	B	-0.1	-0.001
		PM	19.7	B	22.5	C	24.4	C	6.4	0.067
11	US 101 and Alum Rock Avenue*	AM	12.5	B	13.6	B	12.9	B	-0.8	0.016
		PM	17	B	25.4	C	23.1	C	-4.0	-0.043
12	24th Street and San Antonio Street	AM	17.6	B	19.2	B	19.6	B	0.5	0.018
		PM	12.2	B	12.7	B	12.6	B	-0.1	0.004
13	24th Street and East William Street	AM	17	B	17.7	B	17.2	B	-0.9	0.016
		PM	19.5	B	19.9	B	19.7	B	-0.2	0.012
14	McLaughlin Avenue and I-280 SB*	AM	9.7	A	10.7	B	10.7	B	0.1	0.011
		PM	14.4	B	14.3	B	14.2	B	-0.1	-0.001
15	McLaughlin Avenue and Story Road	AM	44.2	D	46.4	D	46.7	D	0.6	0.007
		PM	50.2	D	51.4	D	51.1	D	-0.8	-0.012
16	21st Street and East Santa Clara Street	AM	5.8	A	6.1	A	6.3	A	0.3	-0.016
		PM	4.9	A	5.0	A	4.9	A	0.0	-0.008
17	26th Street and East Santa Clara Street	AM	16.8	B	16.7	B	16.4	B	-0.2	0.017
		PM	14.2	B	14.0	B	13.8	B	0.0	0.001

* Denotes CMP Intersection

Entries denoted in **bold** indicate conditions that exceed the applicable level of service standard.



Figure 50
2035 Phase II Project Conditions Deficient LOS Intersections – Alum Rock/28th Street Station

Table 47
2035 Phase II Project Conditions Freeway Levels of Service - Alum Rock/28th Street Station

Freeway Segment		2035 Phase II Project Conditions														Net Project Trips			
		Direction	Peak Hour	Mixed-Flow Lane						HOV Lane						Mixed-Flow Lane		HOV Lane	
				Avg. Speed	# of Lanes	Capacity	Project Volume	Density	LOS	Avg. Speed	# of Lanes	Capacity	Project Volume	Density	LOS	Volume	% of Capacity	Volume	% of Capacity
US 101	Tully to Story	NB	AM	25.0	3.0	6,900	8,835	118	F	15.0	1.0	1,650	2,133	142	F	-40	-0.58	-7	-0.42
			PM	66.0	3.0	6,900	7,758	39	D	70.0	1.0	1,650	1,506	22	C	-16	-0.23	-2	-0.12
US 101	Story to I-280	NB	AM	22.0	3.0	6,900	5,141	78	F	19.0	1.0	1,650	1,552	82	F	-19	-0.28	-4	-0.24
			PM	67.0	3.0	6,900	3,765	19	C	70.0	1.0	1,650	829	12	B	-7	-0.10	-1	-0.06
US 101	I-280 to Santa Clara	NB	AM	13.0	3.0	6,900	7,683	197	F	13.0	1.0	1,650	1,776	137	F	-40	-0.58	-5	-0.30
			PM	66.0	3.0	6,900	5,644	29	D	70.0	1.0	1,650	874	12	B	-23	-0.33	-1	-0.06
US 101	Santa Clara to McKee	NB	AM	11.0	3.0	6,900	7,826	237	F	16.0	1.0	1,650	1,566	98	F	-115	-1.67	-4	-0.24
			PM	66.0	3.0	6,900	5,489	28	D	70.0	1.0	1,650	768	11	A	-59	-0.86	-1	-0.06
I-280	10th to McLaughlin	EB	AM	66.0	4.0	9,200	7,536	29	D	55.0	1.0	1,650	411	7	A	-142	-1.54	-7	-0.42
			PM	54.0	4.0	9,200	10,293	48	E	55.0	1.0	1,650	1,220	22	C	-143	-1.55	-19	-1.15
I-280	McLaughlin to US 101	EB	AM	66.0	4.0	9,200	5,591	21	C	55.0	1.0	1,650	411	7	A	-140	-1.52	-7	-0.42
			PM	54.0	4.0	9,200	6,855	32	D	55.0	1.0	1,650	1,220	22	C	-118	-1.28	-19	-1.15
I-680	US 101 to King	NB	AM	33.0	4.0	9,200	5,513	42	D	55.0	1.0	1,650	411	7	A	-135	-1.47	-7	-0.42
			PM	66.0	4.0	9,200	6,602	25	C	55.0	1.0	1,650	1,220	22	C	-108	-1.17	-19	-1.15
I-680	King to Capitol	NB	AM	20.0	5.0	11,500	7,669	77	F	55.0	1.0	1,650	411	7	A	-86	-0.75	-7	-0.42
			PM	47.0	5.0	11,500	10,007	43	D	55.0	1.0	1,650	1,220	22	C	-80	-0.70	-19	-1.15
I-680	Capitol to Alum Rock	NB	AM	18.0	4.0	9,200	6,352	88	F	55.0	1.0	1,650	616	11	A	-83	-0.90	-9	-0.55
			PM	65.0	4.0	9,200	7,165	28	D	55.0	1.0	1,650	1,165	21	C	-73	-0.79	-16	-0.97
I-680	Alum Rock to McKee	NB	AM	27.0	4.0	9,200	7,282	67	F	55.0	1.0	1,650	837	15	B	-88	-0.96	-10	-0.61
			PM	66.0	4.0	9,200	7,656	29	D	55.0	1.0	1,650	1,176	21	C	-76	-0.83	-16	-0.97
I-680	McKee to Alum Rock	SB	AM	63.0	4.0	9,200	7,482	30	D	55.0	1.0	1,650	1,376	25	C	-103	-1.12	-26	-1.58
			PM	47.0	4.0	9,200	7,493	40	D	55.0	1.0	1,650	676	12	B	-84	-0.91	-9	-0.55
I-680	Alum Rock to Capitol	SB	AM	23.0	4.0	9,200	7,213	78	F	55.0	1.0	1,650	1,376	25	C	-110	-1.20	-26	-1.58
			PM	65.0	4.0	9,200	5,896	23	C	55.0	1.0	1,650	676	12	B	-77	-0.84	-9	-0.55
I-680	Capitol to King	SB	AM	21.0	4.0	9,200	10,096	120	F	55.0	1.0	1,650	1,440	26	C	-130	-1.41	-29	-1.76
			PM	66.0	4.0	9,200	7,888	30	D	55.0	1.0	1,650	504	9	A	-81	-0.88	-8	-0.48
I-680	King to US 101	SB	AM	12.0	4.0	9,200	6,495	135	F	55.0	1.0	1,650	1,440	26	C	-145	-1.58	-29	-1.76
			PM	66.0	4.0	9,200	5,264	20	C	55.0	1.0	1,650	504	9	A	-108	-1.17	-8	-0.48
I-280	US 101 to McLaughlin	WB	AM	14.0	4.0	9,200	6,495	116	F	55.0	1.0	1,650	1,440	26	C	-145	-1.58	-29	-1.76
			PM	66.0	4.0	9,200	5,264	20	C	55.0	1.0	1,650	504	9	A	-108	-1.17	-8	-0.48
I-280	McLaughlin to 10th	WB	AM	19.0	4.0	9,200	10,655	140	F	55.0	1.0	1,650	1,440	26	C	-186	-2.02	-29	-1.76
			PM	65.0	4.0	9,200	8,038	31	D	55.0	1.0	1,650	504	9	A	-46	-0.50	-8	-0.48
US 101	McKee to Santa Clara	SB	AM	67.0	3.0	6,900	5,152	26	C	67.0	1.0	1,650	738	11	A	-26	-0.38	-1	-0.06
			PM	62.0	3.0	6,900	6,972	37	D	70.0	1.0	1,650	1,539	22	C	25	0.36	-3	-0.18
US 101	Santa Clara to I-280	SB	AM	67.0	3.0	6,900	5,788	29	D	67.0	1.0	1,650	829	12	B	-27	-0.39	-2	-0.12
			PM	63.0	3.0	6,900	7,288	39	D	70.0	1.0	1,650	1,646	24	C	-81	-1.17	-3	-0.18
US 101	I-280 to Story	SB	AM	67.0	3.0	6,900	3,889	19	C	67.0	1.0	1,650	735	11	A	-7	-0.10	-1	-0.06
			PM	54.0	3.0	6,900	4,979	31	D	70.0	1.0	1,650	1,261	18	B	5	0.07	-2	-0.12
US 101	Story to Tully	SB	AM	66.0	4.0	9,200	8,578	32	D	67.0	1.0	1,650	1,201	18	B	-24	-0.26	-2	-0.12
			PM	45.0	4.0	9,200	10,009	56	E	70.0	1.0	1,650	1,630	23	C	-17	-0.18	-3	-0.18

Source: Santa Clara Valley Transportation Authority Congestion Management Program Monitoring Study, 2014.
 The average speed for future HOV lanes are assumed to be 55 MPH.
Bold indicates unacceptable LOS.

2035 Phase II Project Conditions Freeway Ramp Analysis

The results of the freeway ramp analysis under Year 2035 Phase II Project conditions are described below and summarized in Table 48.

Freeway Ramp Lane Geometrics

The ramp lane geometrics were assumed to remain the same as described under Year 2035 No Project/Phase I conditions.

Freeway Ramp Volumes

All freeway ramp traffic volumes were calculated from the projected turn-movement volumes at the adjacent ramp intersections, as described under Year 2035 No Project/Phase I conditions.

Freeway Ramp Queue Lengths

Based on the projected queue lengths obtained from TRAFFIX, it was determined that the available queue storage space for the freeway off-ramps studied would be sufficient to serve the projected demand under Year 2035 Phase II Project conditions. The proposed project is projected to increase queue lengths at the study off-ramps by no more than 4 vehicles during the peak hours.

The queue length projections for the freeway on-ramps show that the on-ramps studied would experience excessive queue lengths that would spill out of the ramps onto the adjacent street under Year 2035 No Project/Phase I conditions and the proposed project is projected to increase the queue length under Year 2035 Phase II Project conditions. This is the result of the of the projected on-ramp demand exceeding the assumed ramp capacity.

The queuing analysis shows that under Year 2035 Phase II Project conditions, the queue length at the US 101 southbound on-ramp at McKee Road is projected to increase by 82 vehicles and the queue length at the US 101 southbound on-ramp at Santa Clara Street is projected to increase by 56 vehicles during the PM peak hour. Therefore, under Year 2035 Phase II Project conditions, the vehicular queue at the US 101 southbound on-ramp at McKee Road is projected to extend out of the ramp by approximately 626 vehicles during the PM peak hour, while the queue at the US 101 southbound on-ramp at Santa Clara Street is projected to extend out of the ramp by approximately 519 vehicles during the PM peak hour. The AM peak hour queue lengths at these ramps would not be affected by the proposed project.

The available queue storage capacity at the study freeway on-ramps would be inadequate to serve the projected queue length under Year 2035 No Project/Phase I conditions and the proposed Phase II Project would worsen the projected deficiency under Year 2035 Phase II Project conditions. However, it should be noted that these projections assume a very conservative meter rate of 900 vph for the entire peak hour analyzed. If the future meter rate at these locations is greater than the assumed 900 vph, the projected demand on these ramps would be dissipated faster and the projected queues would be shorter. Alternatively, setting the ramp meter rate to allow no more than 900 vph could potentially result in peak-hour spreading (drivers accessing these ramps before or after the peak hour to avoid the long queues), use of alternative freeway ramps, and/or use of alternative modes of transportation, such as walk/bike/public transportation.

Table 48
2035 Phase II Project Conditions Freeway Ramp Queuing Analysis

Freeway Ramp	Total Storage (Vehicle) ¹	Volume and Queue Projections (Vehicles)		
		2035 No Project	2035 Phase II Project	Change
<u>US 101 at McKee Road Interchange</u>				
US 101 SB On-Ramp at McKee Road	32			
PM Volume ²		1476	1558	82
Projected Queue Length ³		576	658	82
US 101 SB Loop Off-Ramp at McKee Road	92			
AM Volume ²		470	522	52
Projected Queue Length ⁴		30	34	4
<u>US 101 at Santa Clara Street/Alum Rock Avenue Interchange</u>				
US 101 SB On-Ramp at Santa Clara Street	34			
PM Volume ²		1397	1453	56
Projected Queue Length ³		497	553	56
US 101 NB Off-Ramp at Alum Rock Avenue	67			
AM Volume ²		407	463	56
Projected Queue Length ⁴		14	18	4
PM Volume ²		984	1009	25
Projected Queue Length ⁴		43	43	0
Notes:				
¹ Total number of vehicles that can store within the ramp.				
² Peak-hour ramp volume projections.				
³ Total number of vehicles in the queue, as calculated based on the ramp meter rate and projected traffic volumes.				
⁴ Total number of vehicles in the queue, as obtained from TRAFFIX.				
Bold queue lengths exceed the available queue storage capacity within the ramp.				

Bicycle, Pedestrian, and Transit Facilities Analyses

With the proposed project, a pedestrian connection along the south side of the Alum Rock/28th Street Station area at North 28th Street from East Santa Clara Street would be provided. This pedestrian connection, which would include such amenities as street trees, wide sidewalks, bicycle facilities, and pedestrian-scaled lighting, would link the station entrances with buses and BRT operating on East Santa Clara Street/Alum Rock Avenue, enhancing connectivity of pedestrian facilities surrounding the station. Additionally, the project would add sidewalks around the perimeter of the Alum Rock/28th Street Station and the west side of 28th Street from the station entrance to Santa Clara Street. Crosswalks at the signalized intersections of North 28th Street/East St. James Street and North 28th Street/Five Wounds Lane would also be provided, including pedestrian push buttons and signal heads. In combination with planned pedestrian/bicycle improvements in the study area, the project-sponsored pedestrian/bicycle

improvements would help enhance pedestrian/bicycle facilities in the area. Therefore, the Phase II Project would improve connectivity and would not result in any significant impacts on bicycle and pedestrian circulation. No mitigation measures are required.

The Phase II Project is a transit project and therefore represents a substantial improvement to the transit system in the study area. Additionally, the Phase II Project is being integrated with VTA's light rail and bus systems and would not adversely impact transit facilities or services within the Cities of San Jose and Santa Clara in the vicinity of the BART extension or the proposed BART stations.

Parking Analysis

Revisions to the significance thresholds for CEQA that became effective on January 1, 2010, eliminated effects on parking. The revisions to the CEQA thresholds were based on the decision in *San Franciscans Upholding the Downtown Plan v. City & County of SF*, 102 Cal.App.4th 65 (Sept. 30, 2002), in which the court ruled that parking deficits are an inconvenience to drivers but not a significant physical impact on the environment. As a result of this change to the State CEQA Guidelines, VTA adopted new significance thresholds that did not include the effects of parking on November 4, 2010.

Parking conditions evolve over time as people alter their modes and patterns of travel in response to changing land uses and transportation options. The availability of parking spaces is not part of the permanent physical environment subject to environmental review. Therefore, the loss of parking spaces by itself or the generation of parking demand by itself are not considered a direct significant impact on the physical environment in this TIA. However, parking losses caused by a project or parking demand generated by a project in excess of the parking provided could result in a significant indirect impact on the environment if drivers circling for parking cause significant secondary effects on traffic operations or air quality. The following discussion of parking is for information purposes for CEQA and impact analysis purposes for NEPA and as background to the evaluation of any secondary effects on traffic operations and air quality.

At the Alum Rock/28th Street Station, other than on-street curbside parking, there are no public or private surface parking lots or garages available for public parking within reasonable walking distance. The Alum Rock/28th Street Station is projected to require approximately 1,560 parking spaces to meet the 2035 PNR demand for BART service. VTA express and local bus services to the Alum Rock/28th Street Station would not generate substantial PNR demand. The station plans accommodate 1,200 parking spaces in an up to seven-story parking structure next to the station. Parking demand would be monitored and, if parking demand exceeds supply, VTA would evaluate measures to promote non-vehicular access to the station.

9. Year 2035 Phase II Project Conditions – Diridon Station

This chapter describes traffic conditions in the year 2035 with the proposed Phase II Project. The Diridon Station is one of the four stations proposed along the Phase II Project corridor that would provide for the extension of BART service to the Cities of San Jose and Santa Clara (see Figure 1). Year 2035 Phase II Project conditions analyzed traffic conditions for the year 2035 in the vicinity of the Diridon Station with the addition of the proposed four BART Stations. The analysis includes intersection and freeway segment level of service analysis.

A detailed description of the method used to estimate station-generated traffic is included in Chapter 4 of this report. Estimates of the station-generated traffic, identification of impacts, and recommended mitigation measures for the Diridon Station under Year 2035 Phase II Project conditions are included within this chapter. Year 2035 Phase II Project conditions were evaluated relative to Year 2035 No Project/Phase I conditions in order to determine potential project impacts on the future transportation network. The significant impact criteria are discussed in the introduction section of this report.

Although some of the information provided below has already been described in previous chapters, it is presented again within this chapter for the reader's convenience.

Intersection and Freeway Analysis Methodology – All Stations

Trip Generation, Distribution and Assignment

As previously described, trip generation for the proposed stations was estimated based on passenger projections for the station obtained from the VTA Model. A detailed description of the method used to estimate station-generated traffic is included in Chapter 4. Actual trip generation estimates for the proposed Diridon Station under 2035 Phase II Project conditions are presented in subsequent sections within this chapter.

Distribution patterns and assignment of station-generated traffic (PNR and KNR trips) for the Year 2035 Phase II Project conditions were obtained from the VTA Model.

2035 Phase II Project Conditions Intersection Lane Configurations

The intersection lane configurations under the 2035 Phase II Project conditions were assumed to be the same as described under 2025 No Project/Phase I conditions.

2035 Phase II Project Conditions Traffic Volumes

Traffic volumes for the Year 2035 Phase II Project conditions were obtained from the VTA Model. These traffic volumes represent traffic projections for the year 2035 with the addition of planned improvements and the Phase II Project and proposed stations. Year 2035 Phase II Project conditions model volume forecasts were adjusted using the method previously described (Introduction chapter).

2035 Phase II Project Conditions Freeway Volumes

Traffic volumes for the Year 2035 Phase II Project conditions for the study freeway segments were obtained from the VTA Model. These volumes represent traffic projections for the year 2035 with the addition of planned improvements and the Phase II Project and proposed stations. Unlike intersection forecast volumes, no adjustments were made to the freeway volumes produced by the VTA Model since the freeway network contained in the VTA Model is represented more accurately than local roadways.

Station Description – Diridon Station

The proposed Diridon Station would be located underground between Los Gatos Creek (to the east) and the Diridon Caltrain Station (to the west) and south of/parallel to Santa Clara Street (see Figure 3). A detailed description of proposed Diridon Station is included in Chapters 1 and 5.

Station Trip Generation Estimates – Diridon Station

The trip generation estimates for the proposed Diridon Station under the year 2035 Phase II Project conditions were developed using the VTA Model and based on the method previously described. Ridership projections total about 12,050 daily BART riders (6,025 boardings and 6,025 alightings) at the Diridon Station under the year 2035 Phase II Project conditions. Table 49 presents the daily and peak hour trip generation estimates for each of the drive access modes to the Diridon Station, described in the following sections.

Table 49
Diridon Station Trip Generation Estimates – 2035 Phase II Project Conditions

Mode of Access by Station	Daily Trips	Parking Demand (# of Spaces)	AM Peak Hour Trips			PM Peak Hour Trips		
			In	Out	Total	In	Out	Total
<i>Diridon Station:</i>								
Kiss and Ride Trips	440		43	43	86	50	50	100
Park and Ride Trips	0	0	0	0	0	0	0	0
Total	440		43	43	86	50	50	100
Source: VTA Model, December 2014.								

Park-and-Ride Trips

No PNR facilities would be provided at the Diridon Station.

Kiss-and-Ride Trips

Model projections of passenger volumes for the Diridon Station indicate that 440 daily KNR trips would utilize the station under the Year 2035 Phase II Project conditions scenario. Since KNR trips consist of vehicles entering the station site to drop-off a BART commuter and then exiting the site and proceeding

on to another destination, station trip generation estimates for peak hour inbound and outbound KNR vehicle trips are equivalent. It is estimated that a total of 86 (43 inbound/43 outbound) KNR trips would occur during the AM peak hour and a total of 100 (50 inbound/50 outbound) KNR trips would occur during the PM peak hour.

Trip Distribution and Assignment

Distribution pattern and assignment of station-generated traffic (KNR trips) to the proposed Diridon Station under the Year 2035 Phase II Project conditions were developed from traffic assignments using the VTA Model. As mentioned previously, implementation of the proposed project would result in a shift in travel pattern, as the result of some commuters modifying their travel route to access the station area, and in the removal of auto trips from the roadway network, as some commuters shift from auto to transit modes of travel. Thus, station-generated traffic consists of two components: 1.) new vehicular trips accessing the proposed Diridon Station, referred to as *station drive access* trips, and 2.) all the trips that would no longer be on the roadway as a result of the Phase II Project, represented by negative trips on the roadway network. It is projected that under Year 2035 Phase II Project conditions, approximately 1,400 and 1,150 AM and PM peak-hour trips, respectively, would be removed from the roadway transportation system as the result of the Phase II Project and proposed Stations. The total *net project trips* generated by the Diridon Station are therefore calculated by adding the new station drive access trips (positive trips) and the trips removed from the roadway network as a result of the Diridon Station and Phase II Project (negative trips). The Diridon Station drive access trips for the Year 2035 Phase II Project conditions are shown graphically on Figure 51 while the net project trips are shown on Figure 52.

An example of the trip assignment process and method used to estimate traffic with the project is presented in Chapter 4 for the Alum Rock/28th Street Station.

The trip assignment process shows that at some locations, particularly for those movements leading directly to the station area, the number of vehicles accessing the station is larger than the number of vehicles shifted from the roadway network to transit modes, thus, the project results in a net increase in traffic volumes. At many locations, particularly for those movements either not leading to the station area or leading to freeways, the number of vehicles shifted from the roadway network to transit modes is greater than the number of vehicles using that movement to access the station, and the project results in a net decrease in traffic volumes.

2035 Phase II Project Conditions Traffic Volumes

Traffic volumes for the Year 2035 Phase II Project conditions were obtained by adding to the Year 2035 No Project/Phase I traffic volumes the traffic projected to be generated by the proposed BART Stations (net project trips, as described above). The net project traffic projections under the Year 2035 Phase II Project conditions were obtained from the VTA Model.

The Year 2035 Phase II Project conditions traffic volumes are presented on Figure 53 and included in Appendix D.

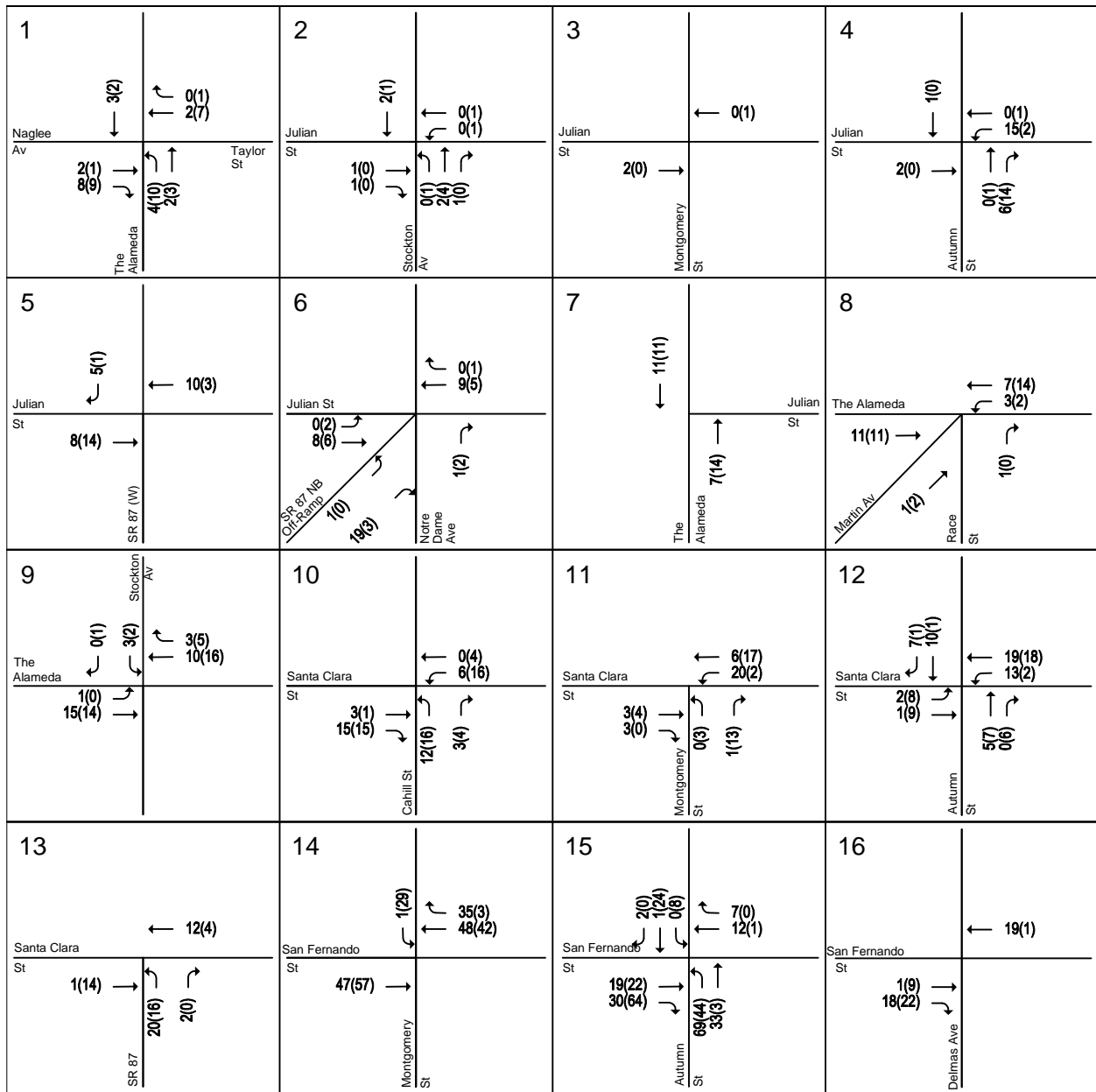

LEGEND:

XX(YY) = AM(PM) Peak-Hour Traffic Volumes

Diridon - 2035 Drive Access Trip

Figure 51
2035 Phase II Project Conditions Station (Drive Access) Trips – Diridon Station

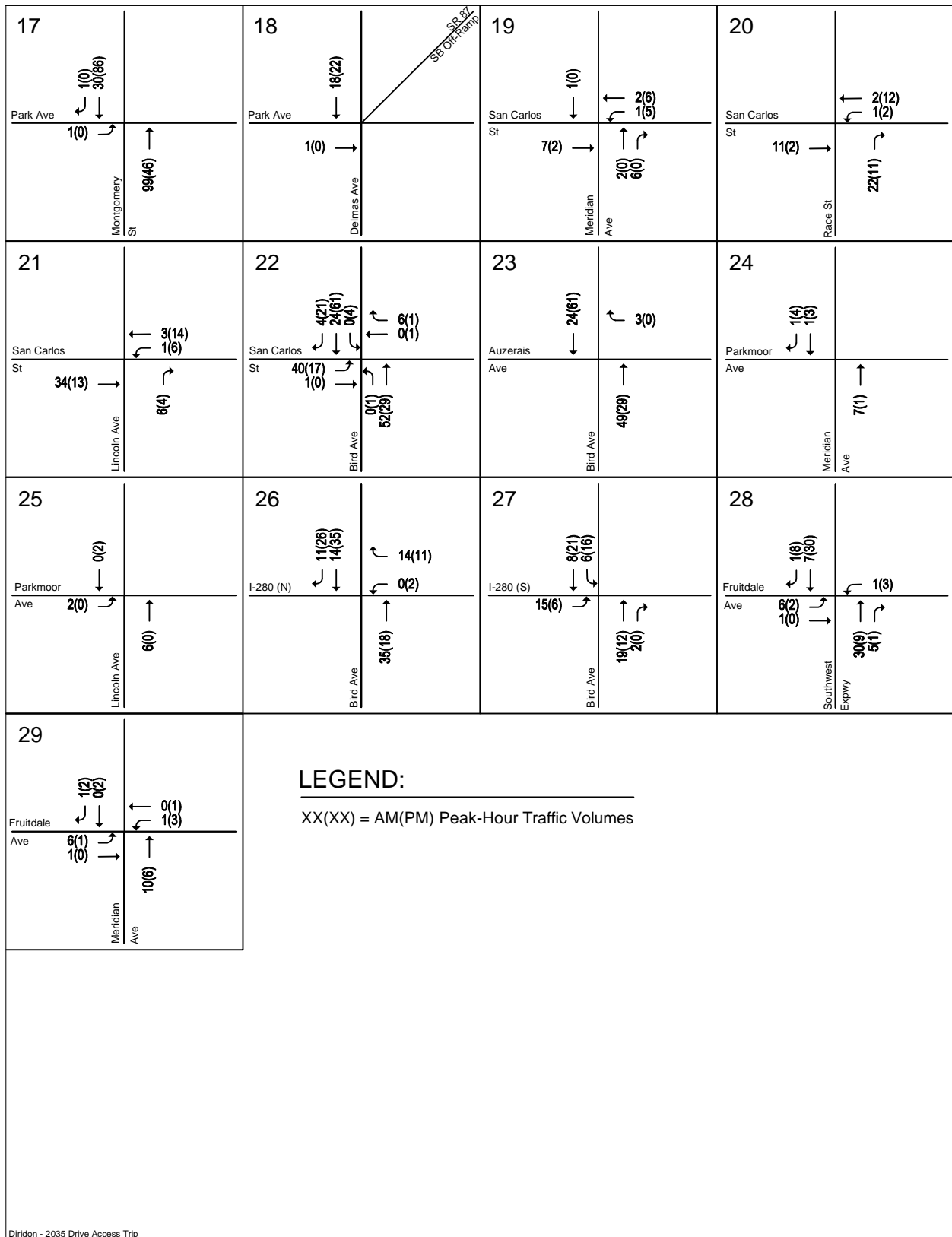

Diridon - 2035 Drive Access Trips

Figure 51 (Continued)
2035 Phase II Project Conditions Station (Drive Access) Trips – Diridon Station

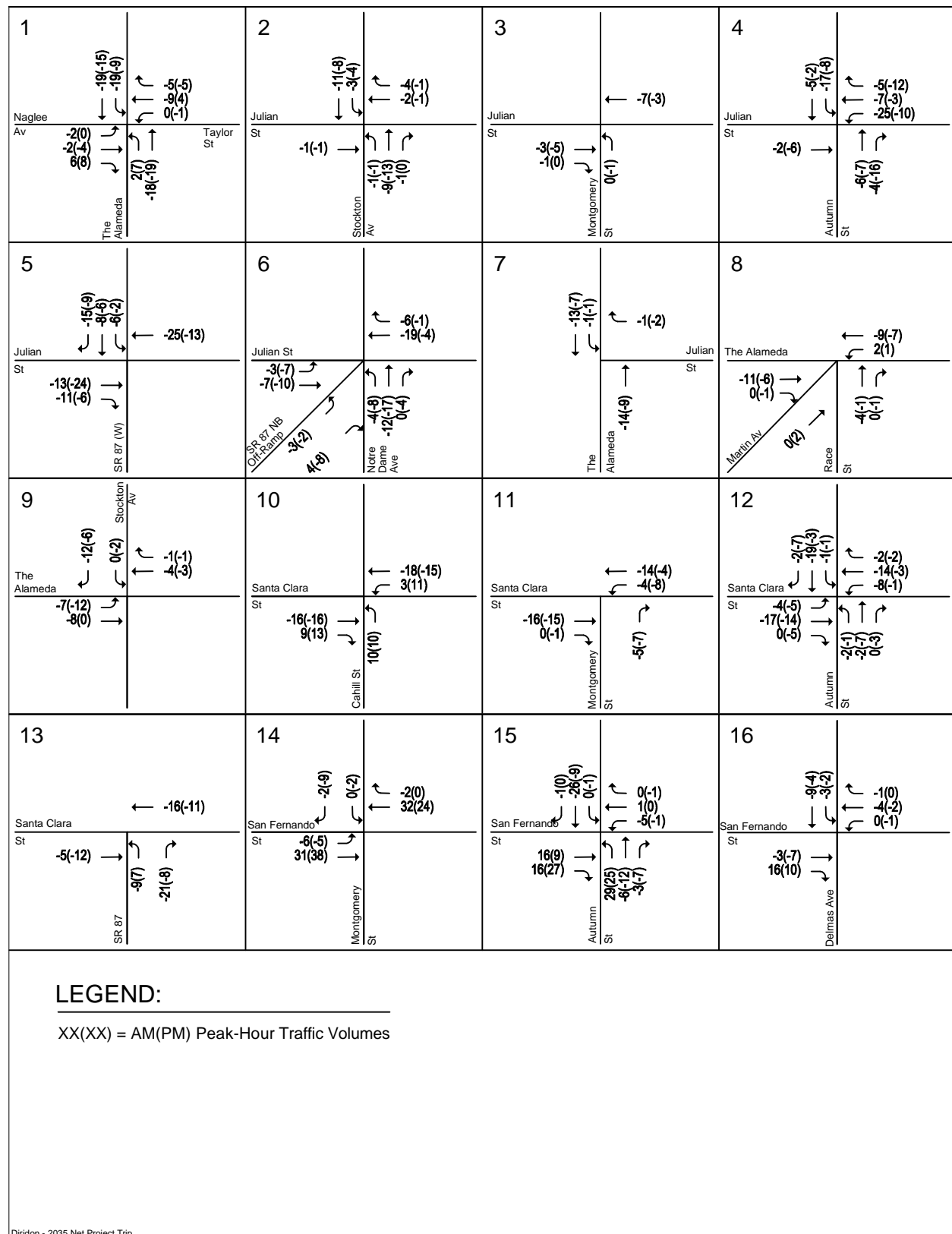
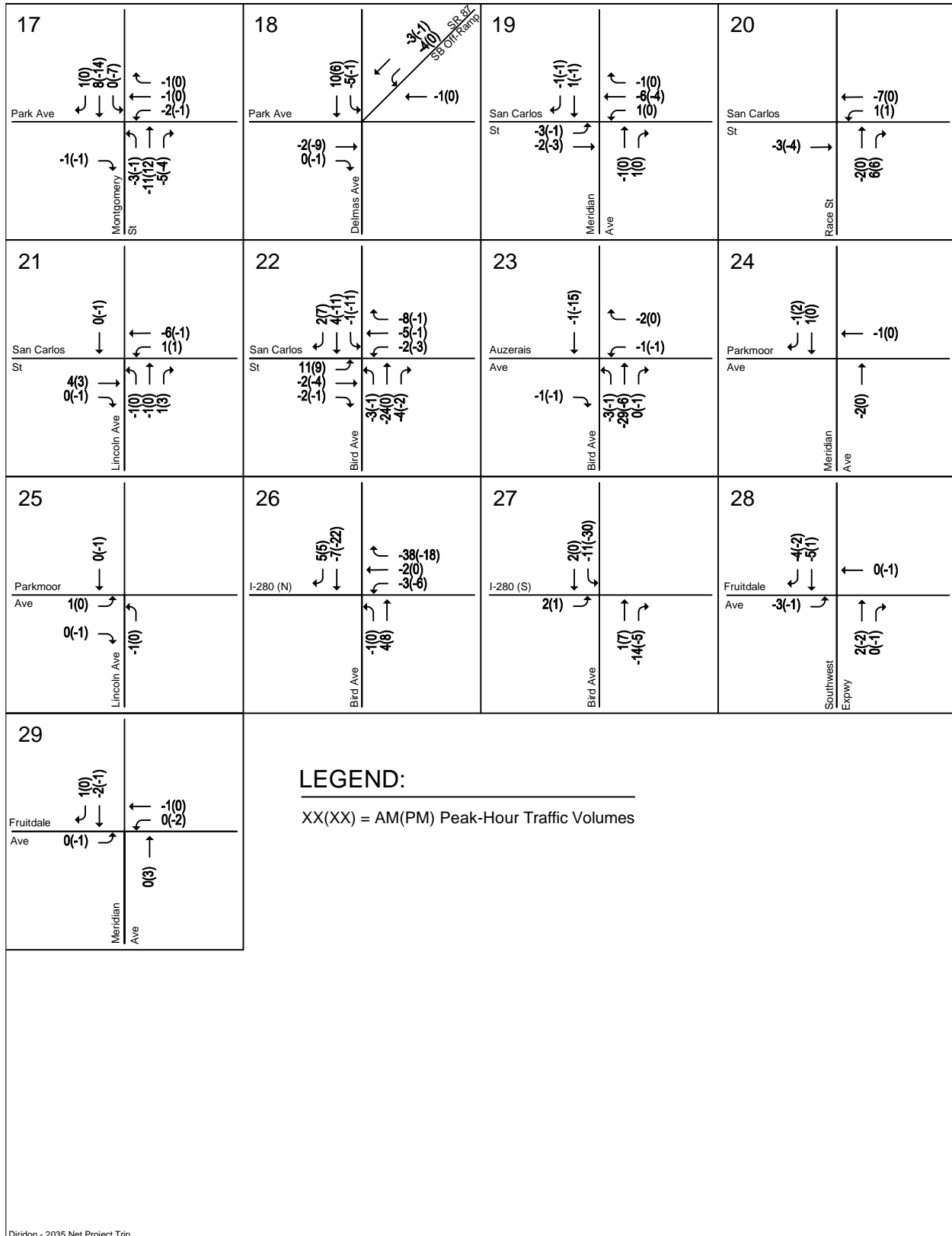

Figure 52
 2035 Phase II Project Conditions Net Project Trips – Diridon Station



Diridon - 2035 Net Project Trips

Figure 52 (Continued)
2035 Phase II Project Conditions Net Project Trips – Diridon Station

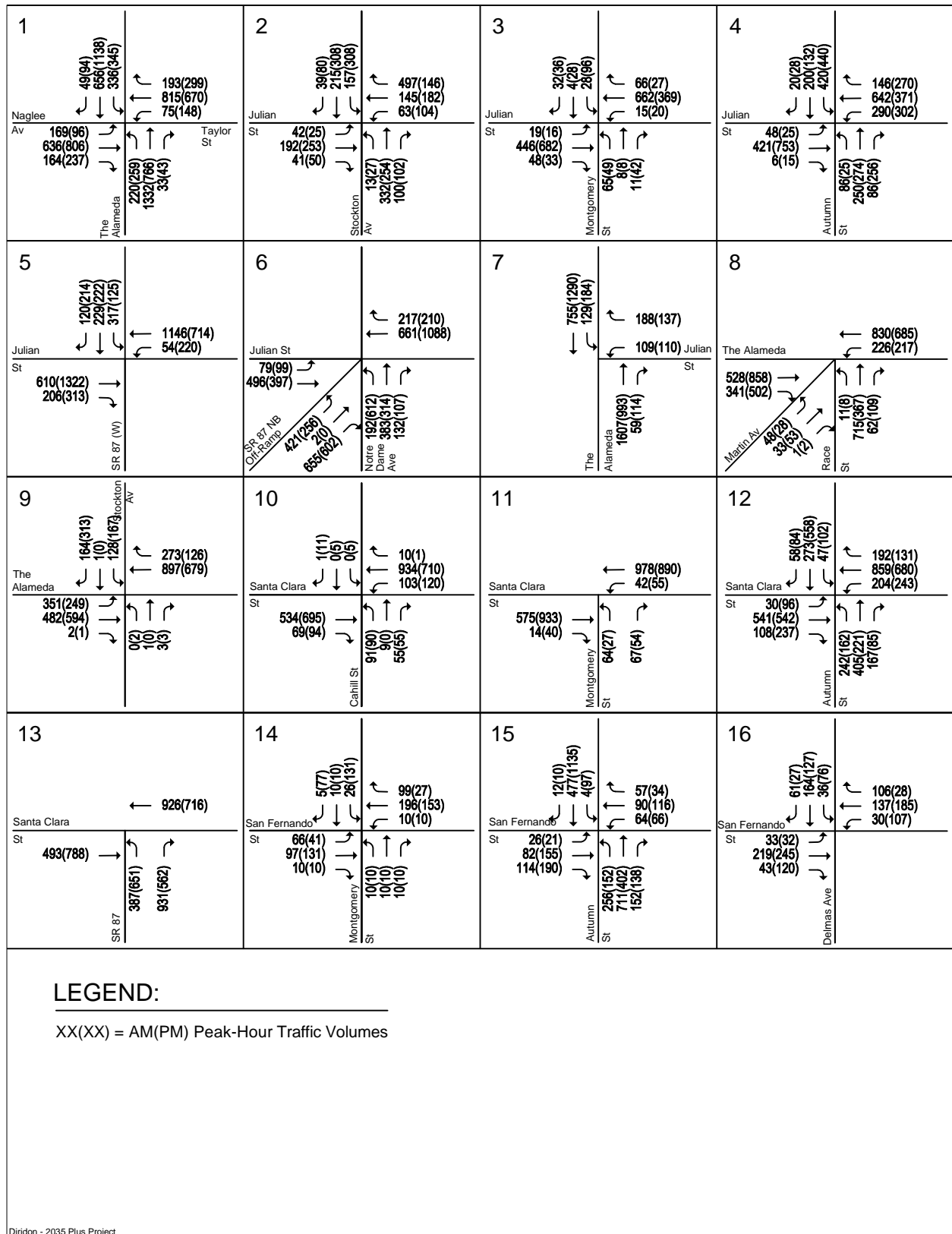

Figure 53
 2035 Phase II Project Conditions Traffic Volumes – Diridon Station

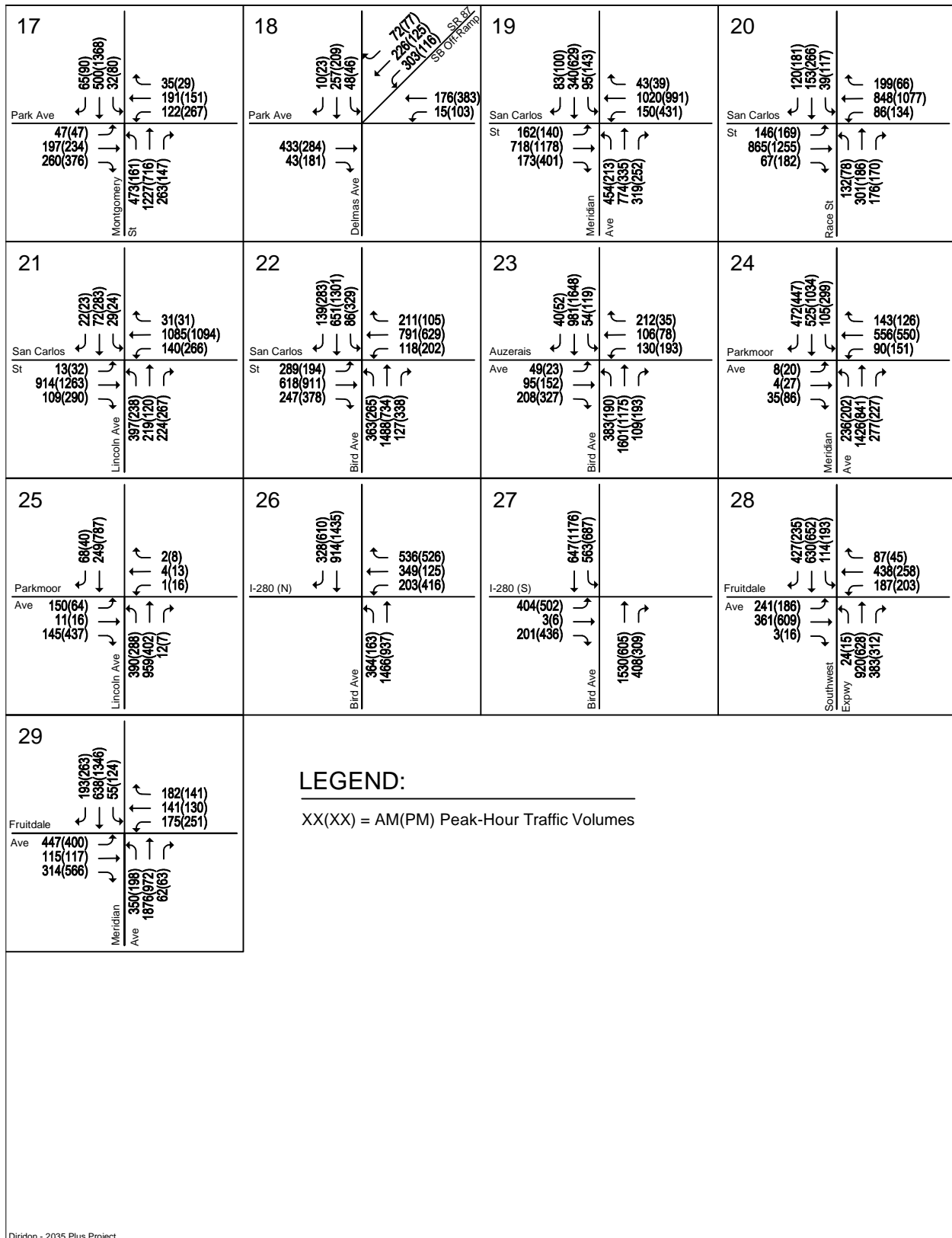

Figure 53 (Continued)
 2035 Phase II Project Conditions Traffic Volumes – Diridon Station

2035 Phase II Project Conditions Intersection Levels of Service

The results of the level of service analysis for the Diridon Station under the Year 2035 Phase II Project conditions are summarized in Table 50. The results show that three study intersections identified to operate at unacceptable levels under Year 2035 No Project/Phase I conditions are projected to continue to operate at unacceptable levels of service during at least one peak hour (see Figure 54).

- (1) The Alameda and Taylor Street/Naglee Avenue* (LOS E – AM & PM peak hours)
- (17) South Autumn Street and Park Avenue (LOS E – PM peak hour)
- (29) Meridian Avenue and Fruitdale Avenue (LOS E – AM & PM peak hours)

When measured against the City of San Jose significant impact criteria for 2035 conditions, these three intersections would not be significantly impacted by the project under 2035 Phase II Project Conditions. The City of San Jose's significant impact criteria under cumulative conditions requires comparison of 2025 No Project/Phase I conditions and 2035 Phase II Project conditions to see if the Project would contribute a considerable amount (more than 25%) of the total increase in traffic between those two conditions. The Project's contribution to the increase in total volume from 2025 No Project/Phase I Conditions to 2035 Phase II Project Conditions would be less than 25 percent, since the 2035 Phase II Project would result in **fewer** cars at these intersections compared to traffic volumes under 2025 No Project/Phase I conditions. As shown in Figure 52, the net project trips at these intersections, when all turning movements are added together, is a negative number for both the AM and PM peak hours. At the intersection of The Alameda and Taylor Street/Naglee Avenue, the project would add 66 **fewer** vehicles in AM peak hour and 34 **fewer** vehicles during the PM peak hour. At the intersection of South Autumn Street and Park Avenue the project would add 15 **fewer** vehicles in AM peak hour and 16 **fewer** vehicles during the PM peak hour. At the intersection of Meridian Avenue and Fruitdale Avenue the project would add 2 **fewer** vehicles in AM peak hour and 1 **fewer** vehicle during the PM peak hour. Therefore, the Project would not have a significant impact on these intersections under 2035 Phase II Project Conditions, based on the City of San Jose significant impact criteria, and no mitigation is required.

Based on the CMP significant impact criteria, the proposed project would not cause an adverse impact that would exceed the significance thresholds at any of the CMP study intersections in the vicinity of the Diridon Station. Therefore, no mitigation is required. All other study intersections are projected to operate at an acceptable level of service under both City of San Jose and CMP standards. The level of service calculation sheets for the Diridon Station are included in Appendix F.

2035 Phase II Project Conditions Freeway Segment Levels of Service

Traffic volumes for the Year 2035 Phase II Project conditions for the study freeway segments were obtained from the VTA Model. These volumes represent traffic projections for the year 2035 with the addition of planned improvements and the Phase II Project and proposed stations. Note that the project would result in a decrease in traffic volumes on the freeway network, as commuters use BART as an alternative to regional freeway travel. While a portion of traffic accessing the station areas would use the freeway network to do so, generally those trips are already on the freeway network and do not represent an increase in traffic from Year 2035 No Project/Phase I conditions. However, a number of others accessing the station would do so via transit or local streets, and therefore would result in a net reduction in freeway volumes. The net reduction in peak hour freeway volumes along the study freeway segments as a result of the implementation of the Phase II Project and the Diridon Station are presented in Table 51.

Table 50
2035 Phase II Project Conditions Intersection Levels of Service - Diridon Station

Study Number	Intersection	Peak Hour	2025 No Project		2035 No Project		2035 Phase II Project			
			Avg. Delay	LOS	Avg. Delay	LOS	Avg. Delay	LOS	Incr. In Crit. Delay	Incr. In Crit. V/C
1	The Alameda and Taylor Street/Naglee Avenue*	AM	64.9	E	76.2	E	72.1	E	-6.5	-0.022
		PM	50.4	D	58.9	E	58.7	E	0.3	0.001
2	Stockton Avenue and West Julian Street	AM	36.5	D	38.5	D	37.9	D	-0.8	-0.011
		PM	34.5	C	36.7	D	36.4	D	-0.6	-0.012
3	North Montgomery Street and West Julian Street	AM	11.7	B	11.5	B	11.5	B	-0.1	-0.004
		PM	12.6	B	13.1	B	13.1	B	0.0	-0.003
4	North Autumn Street and West Julian Street	AM	30.1	C	31.5	C	30.7	C	0.8	0.031
		PM	33.6	C	47.3	D	43.4	D	-4.7	-0.020
5	SR 87 (W) and West Julian Street*	AM	19.3	B	18.7	B	18.7	B	-0.2	-0.012
		PM	17.8	B	20.1	C	19.9	B	-0.2	-0.010
6	SR 87 (E) and West Julian Street*	AM	52.4	D	52.9	D	52.7	D	-0.3	-0.006
		PM	45.6	D	47.9	D	47.3	D	-0.6	-0.009
7	The Alameda and West Julian Street	AM	20.1	C	20.2	C	20.2	C	-0.1	-0.005
		PM	18.8	B	17.5	B	17.5	B	-0.1	-0.004
8	Race Street/Martin Avenue and The Alameda*	AM	38.5	D	39.4	D	39.4	D	0.1	0.000
		PM	32	C	32.3	C	32.3	C	0.0	0.001
9	Stockton Avenue and The Alameda	AM	28.3	C	34.8	C	33.9	C	-1.2	-0.013
		PM	31.9	C	34.7	C	34.1	C	-0.7	-0.013
10	Cahill Street and West Santa Clara Street	AM	16.4	B	16.5	B	17.3	B	0.9	0.001
		PM	17.7	B	17.0	B	18.1	B	1.5	0.012
11	South Montgomery Street and West Santa Clara Street*	AM	9.5	A	10.8	B	10.6	B	-0.1	-0.004
		PM	10.1	B	8.1	A	7.3	A	-1.0	-0.009
12	South Autumn Street and West Santa Clara Street*	AM	32.9	C	33.8	C	33.6	C	-0.1	-0.008
		PM	36.2	D	37.7	D	37.5	D	-0.3	-0.008
13	SR 87 and West Santa Clara Street*	AM	18.6	B	18.9	B	18.8	B	-0.2	-0.012
		PM	17.4	B	17.6	B	17.6	B	0.0	-0.001
14	South Montgomery Street and San Fernando Street	AM	5.6	A	5.3	A	5.0	A	-0.3	0.018
		PM	10.4	B	10.7	B	10.6	B	0.3	0.008
15	South Autumn Street and San Fernando Street	AM	13.9	B	14.8	B	15.2	B	0.2	0.002
		PM	16.1	B	17.1	B	18.4	B	1.8	0.038
16	Delmas Avenue and San Fernando Street	AM	10.2	B	12.0	B	11.6	B	0.0	0.001
		PM	10.4	B	10.3	B	10.2	B	-0.1	-0.002
17	South Montgomery Street/Autumn Street and Park Avenue	AM	36.2	D	40.8	D	40.7	D	-0.4	-0.006
		PM	47.6	D	63.9	E	62.8	E	-1.5	-0.006
18	Delmas Avenue and Park Avenue	AM	24.7	C	26.6	C	26.6	C	0.0	-0.002
		PM	24.9	C	24.2	C	24.3	C	0.0	-0.005
19	Meridian Avenue and San Carlos Street	AM	41.1	D	44.4	D	44.3	D	-0.2	-0.004
		PM	49.3	D	54.2	D	54.1	D	-0.1	-0.001
20	Race Street and San Carlos Street	AM	33.9	C	34.0	C	34.1	C	0.0	-0.003
		PM	36	D	36.6	D	36.7	D	0.1	-0.001
21	Lincoln Avenue and San Carlos Street	AM	36	D	37.2	D	37.2	D	-0.1	-0.002
		PM	44	D	51.8	D	52.0	D	0.4	0.003
22	Bird Avenue and San Carlos Street*	AM	39.9	D	45.4	D	45.4	D	0.1	-0.002
		PM	49.4	D	55.4	E	54.8	D	-1.1	-0.005
23	Bird Avenue and Auzerais Avenue	AM	29.9	C	32.8	C	32.7	C	-0.1	-0.004
		PM	25.6	C	27.9	C	27.9	C	0.0	-0.004
24	Meridian Avenue and Parkmoor Avenue	AM	32.9	C	34.9	C	34.8	C	-0.1	-0.001
		PM	39.6	D	41.0	D	41.0	D	0.0	0.000
25	Lincoln Avenue and Parkmoor Avenue	AM	25.6	C	28.3	C	28.3	C	0.0	0.000
		PM	42.9	D	46.2	D	46.1	D	-0.1	-0.001
26	Bird Avenue and I-280 (N)*	AM	34.8	C	36.1	D	35.4	D	-0.6	-0.011
		PM	27.1	C	29.8	C	29.4	C	-0.2	-0.004
27	Bird Avenue and I-280 (S)*	AM	31.5	C	34.0	C	33.6	C	-0.3	-0.006
		PM	32.1	C	36.9	D	35.5	D	-3.1	-0.022
28	Southwest Expressway and Fruitdale Avenue	AM	34.2	C	35.0	C	34.9	C	-1.8	0.018
		PM	33.8	C	37.0	D	37.0	D	0.0	-0.001
29	Meridian Avenue and Fruitdale Avenue	AM	58.5	E	77.7	E	77.5	E	-0.2	-0.001
		PM	57.1	E	64.6	E	64.4	E	-0.2	-0.001

* Denotes CMP Intersection

Entries denoted in **bold** indicate conditions that exceed the applicable level of service standard.



Figure 54
2035 Phase II Project Conditions Deficient LOS Intersections – Diridon Station

Table 51
2035 Phase II Project Conditions Freeway Levels of Service - Diridon Station

Freeway Segment		2035 Phase II Project Conditions														Net Project Trips			
		Direction	Peak Hour	Mixed-Flow Lane						HOV Lane						Mixed-Flow Lane		HOV Lane	
				Avg. Speed	# of Lanes	Capacity	Project Volume	Density	LOS	Avg. Speed	# of Lanes	Capacity	Project Volume	Density	LOS	Volume	% of Capacity	Volume	% of Capacity
SR 87	Curtner to Almaden Expressway	NB	AM	13.0	2.0	4,400	3,782	145	F	22.0	1.0	1,650	1,787	81	F	-9	-0.20	-5	-0.30
			PM	65.0	2.0	4,400	3,254	25	C	70.0	1.0	1,650	791	11	A	3	0.07	-1	-0.06
SR 87	Almaden Expressway to Alma	NB	AM	29.0	2.0	4,400	4,761	82	F	43.0	1.0	1,650	2,070	48	E	-11	-0.25	-6	-0.36
			PM	41.0	2.0	4,400	3,989	49	E	70.0	1.0	1,650	868	12	B	2	0.05	-1	-0.06
SR 87	Alma to I-280	NB	AM	33.0	2.0	4,400	5,771	87	F	61.0	1.0	1,650	2,126	35	D	-12	-0.27	-6	-0.36
			PM	66.0	2.0	4,400	4,514	34	D	70.0	1.0	1,650	941	13	B	2	0.05	-2	-0.12
SR 87	I-280 to Julian	NB	AM	16.0	2.0	4,400	3,289	103	F	30.0	1.0	1,650	1,422	47	E	-3	-0.07	-3	-0.18
			PM	67.0	2.0	4,400	1,856	14	B	70.0	1.0	1,650	421	6	A	-3	-0.07	-1	-0.06
SR 87	Julian to Coleman	NB	AM	14.0	2.0	4,400	4,642	166	F	32.0	1.0	1,650	1,669	52	E	-34	-0.77	-6	-0.36
			PM	67.0	2.0	4,400	2,869	21	C	70.0	1.0	1,650	566	8	A	-45	-1.02	-2	-0.12
I-280	I-880 to Meridian	EB	AM	66.0	4.0	9,200	6,598	25	C	67.0	1.0	1,650	753	11	A	-45	-0.49	-4	-0.24
			PM	17.0	4.0	9,200	7,295	107	F	20.0	1.0	1,650	1,625	81	F	-38	-0.41	-7	-0.42
I-280	Meridian to Bird	EB	AM	61.0	4.0	9,200	8,612	35	D	55.0	1.0	1,650	461	8	A	-52	-0.57	-4	-0.24
			PM	21.0	4.0	9,200	9,352	111	F	55.0	1.0	1,650	1,345	24	C	-46	-0.50	-7	-0.42
I-280	Bird to SR 87	EB	AM	66.0	4.0	9,200	4,488	17	B	55.0	1.0	1,650	461	8	A	-44	-0.48	-4	-0.24
			PM	25.0	4.0	9,200	5,885	59	F	55.0	1.0	1,650	1,345	24	C	-39	-0.42	-7	-0.42
I-280	SR 87 to 10th	EB	AM	67.0	4.0	9,200	6,337	24	C	55.0	1.0	1,650	461	8	A	-79	-0.86	-4	-0.24
			PM	27.0	4.0	9,200	8,645	80	F	55.0	1.0	1,650	1,345	24	C	-87	-0.95	-7	-0.42
I-280	10th to SR 87	WB	AM	21.0	4.0	9,200	10,089	120	F	55.0	1.0	1,650	1,528	28	D	-151	-1.64	-13	-0.79
			PM	65.0	4.0	9,200	8,388	32	D	55.0	1.0	1,650	533	10	A	-30	-0.33	-3	-0.18
I-280	SR 87 to Bird	WB	AM	20.0	4.0	9,200	6,105	76	F	55.0	1.0	1,650	1,528	28	D	-65	-0.71	-13	-0.79
			PM	62.0	4.0	9,200	5,353	22	C	55.0	1.0	1,650	533	10	A	10	0.11	-3	-0.18
I-280	Bird to Meridian	WB	AM	18.0	4.0	9,200	9,728	135	F	55.0	1.0	1,650	1,528	28	D	-77	-0.84	-13	-0.79
			PM	58.0	4.0	9,200	9,008	39	D	55.0	1.0	1,650	533	10	A	6	0.07	-3	-0.18
I-280	Meridian to I-880	WB	AM	14.0	3.0	6,900	7,626	182	F	26.0	1.0	1,650	1,793	69	F	-62	-0.90	-14	-0.85
			PM	66.0	3.0	6,900	6,725	34	D	70.0	1.0	1,650	822	12	B	16	0.23	-4	-0.24
SR 87	Coleman to Julian	SB	AM	66.0	2.0	4,400	2,518	19	C	67.0	1.0	1,650	271	4	A	-35	-0.80	0	0.00
			PM	32.0	2.0	4,400	4,012	63	F	50.0	1.0	1,650	1,218	24	C	-18	-0.41	-3	-0.18
SR 87	Julian to I-280	SB	AM	67.0	2.0	4,400	2,859	21	C	67.0	1.0	1,650	337	5	A	-12	-0.27	0	0.00
			PM	36.0	2.0	4,400	4,633	64	F	70.0	1.0	1,650	1,331	19	C	-11	-0.25	-2	-0.12
SR 87	I-280 to Alma	SB	AM	67.0	2.0	4,400	3,768	28	D	67.0	1.0	1,650	683	10	A	4	0.09	-1	-0.06
			PM	15.0	2.0	4,400	3,797	127	F	60.0	1.0	1,650	1,835	31	D	3	0.07	-4	-0.24
SR 87	Alma to Almaden Expressway	SB	AM	66.0	2.0	4,400	3,949	30	D	67.0	1.0	1,650	660	10	A	3	0.07	-1	-0.06
			PM	27.0	2.0	4,400	4,481	83	F	60.0	1.0	1,650	1,795	30	D	-2	-0.05	-4	-0.24
SR 87	Almaden Expressway to Curtner	SB	AM	66.0	2.0	4,400	3,000	23	C	67.0	1.0	1,650	574	9	A	3	0.07	-1	-0.06
			PM	36.0	2.0	4,400	3,486	48	E	70.0	1.0	1,650	1,564	22	C	-1	-0.02	-4	-0.24

Source: Santa Clara Valley Transportation Authority Congestion Management Program Monitoring Study, 2014.
The average speed for future HOV lanes are assumed to be 55 MPH.
Bold indicates unacceptable LOS.

The results of the freeway analysis are summarized in Table 51. The results show that 17 of the 18 directional freeway segments (and 3 HOV segments) analyzed for the Diridon Station would operate at an unacceptable LOS F during at least one of the peak hours. Since the project would not add traffic representing one percent or more of the segment's capacity to any of the study freeway segments projected to operate at LOS F (including HOV segments), the project would not cause an adverse impact that would exceed the significance thresholds on any of the freeway segments analyzed under the Year 2035 Phase II Project conditions, according to VTA CMP level of service impact criteria for freeways. Therefore, no mitigation is required.

2035 Phase II Project Conditions Freeway Ramp Analysis

Based on the traffic volume projections obtained from the VTA Model, the Phase II Project is not projected to increase freeway ramp volumes by 10 or more peak-hour trips at any freeway ramp in the vicinity of the Diridon Station.

Bicycle, Pedestrian, and Transit Facilities Analyses

Street-level station entrance portals would provide pedestrian linkages to the Diridon Caltrain Station and SAP Center. Additionally, sidewalks are found along all local roadways in the Diridon Station study area and along the local residential streets and collectors near the station site. All signalized intersections in the vicinity of the Diridon Station have marked crosswalks on all or most of the legs of the intersection, combined with pedestrian push buttons and pedestrian signal heads. In combination with planned pedestrian/bicycle improvements in the study area, the project sponsored pedestrian/bicycle improvements would help enhance pedestrian/bicycle facilities in the area. Therefore, the Phase II Project would not result in any significant impacts on bicycle and pedestrian circulation, and no mitigation measures are required.

The Phase II Project is a transit project and therefore represents a substantial improvement to the transit system in the study area. Additionally, the Phase II Project is being integrated with VTA's light rail and bus systems and would not adversely impact transit facilities or services within the Cities of San Jose and Santa Clara in the vicinity of the BART extension or the proposed BART stations.

Parking Analysis

Revisions to the significance thresholds for CEQA that became effective on January 1, 2010, eliminated effects on parking. The revisions to the CEQA thresholds were based on the decision in *San Franciscans Upholding the Downtown Plan v. City & County of SF*, 102 Cal.App.4th 65 (Sept. 30, 2002), in which the court ruled that parking deficits are an inconvenience to drivers but not a significant physical impact on the environment. As a result of this change to the State CEQA Guidelines, VTA adopted new significance thresholds that did not include the effects of parking on November 4, 2010.

Parking conditions evolve over time as people alter their modes and patterns of travel in response to changing land uses and transportation options. The availability of parking spaces is not part of the permanent physical environment subject to environmental review. Therefore, the loss of parking spaces by itself or the generation of parking demand by itself are not considered a direct significant impact on the physical environment in this TIA. However, parking losses caused by a project or parking demand generated by a project in excess of the parking provided could result in a significant indirect impact on the environment if drivers circling for parking cause significant secondary effects on traffic operations or air quality. The following discussion of parking is for information purposes for CEQA and impact analysis purposes for NEPA and as background to the evaluation of any secondary effects on traffic operations and air quality.

Caltrain currently provides parking for its patrons on three surface lots immediately east of the existing Diridon Caltrain Station. VTA owns one of the lots—1.3 acres south of Santa Clara Street and between Montgomery Street and Cahill Street. This site is currently leased to others and provides approximately

185 parking spaces. In addition, a large parking lot is immediately west of the SAP Center for patrons of this facility.

In July 2008, MTC awarded a Regional Transit Expansion Program grant to the City of San Jose to develop a Diridon Station Area Plan (DSAP). The DSAP was completed and the Final EIR was certified in the fall of 2014. One element of the DSAP is to develop a Transportation and Parking Management Plan for the Diridon Station area. This plan addresses the provision, location, and management of parking in the area, including parking demand for BART and High-Speed Rail. This includes an overall strategy for meeting near-term and long-term parking needs with stakeholders. VTA, in partnership with the City of San Jose, Caltrain, and area stakeholders, would work to develop a parking management plan that allows for shared parking among area transit providers, the SAP Center, and future development. The DSAP also evaluates strategies that would encourage transit-supportive access to the area and non-auto travel.

VTA would work with the Peninsula Corridor Joint Powers Board to evaluate parking demand at PNR lots such as Diridon Station, which are owned in whole or in part by VTA and utilized by Caltrain and other transit patrons, to ensure an adequate parking management plan is implemented. Evaluation will be based on updated transit patron mode of access data and/or VTA policies established for transit park-and-ride and/or joint development parking requirements.

Event Center Analysis

There are two major event facilities along the Phase II BART extension: the SAP Center near the Diridon Station and Avaya Stadium near the Santa Clara Station. Because potential interference with activities at event centers is not included in Appendix G of the State CEQA Guidelines, this discussion is provided for informational purposes only for CEQA and impact analysis purposes for NEPA.

The SAP Center is across Santa Clara Street from the Diridon Station. The SAP Center holds a substantial number of events throughout the year, primarily on weekends. The Diridon Station would not provide parking for BART riders. Ridership projections have been based on access from heavy and light rail, buses, KNR, bicycling, and walking. The Diridon Station design would be similar to other BART system Downtown stations where parking is not provided. If BART riders require parking, they could access either the BART Alum Rock/28th Street or Santa Clara Stations or one of several downtown parking garages. Because the Diridon Station would not provide parking for BART riders, traffic associated with the Diridon Station would be from KNR drop-offs and pick-ups and from those choosing to park in nearby parking lots in the area. The convenience of having a BART station across the street would also encourage a transit access alternative for those attending SAP Center events and reduce the number of vehicles traveling to SAP Center events. Therefore, the number of vehicles on the adjacent roadways associated with the BART Extension operations would not be substantial. There would be no adverse effects under NEPA, and no mitigation is required.

10. Year 2035 Phase II Project Conditions – Santa Clara Station

This chapter describes traffic conditions in the year 2035 with the proposed Phase II Project. The Santa Clara Station is one of the four stations proposed along the Phase II Project corridor that would provide for the extension of BART service to the Cities of San Jose and Santa Clara (see Figure 1). Year 2035 Phase II Project conditions analyzed traffic conditions for the year 2035 in the vicinity of the Santa Clara Station with the addition of the proposed four BART Stations. The analysis includes intersection and freeway segment level of service analysis.

A detailed description of the method used to estimate station-generated traffic is included in Chapter 4 of this report. Estimates of the station-generated traffic, identification of impacts, and recommended mitigation measures for the Santa Clara Station under Year 2035 Phase II Project conditions are included within this chapter. Year 2035 Phase II Project conditions were evaluated relative to Year 2035 No Project/Phase I conditions in order to determine potential project impacts on the future transportation network. The significant impact criteria are discussed in Chapter 1 of this report.

Although some of the information provided below has already been described in previous chapters, it is presented again within this chapter for the reader's convenience.

Intersection and Freeway Analysis Methodology – All Stations

Trip Generation, Distribution and Assignment

As previously described, trip generation for the proposed stations was estimated based on passenger projections for the station obtained from the VTA Model. A detailed description of the method used to estimate station-generated traffic is included in Chapter 4. Actual trip generation estimates for the proposed Santa Clara Station under 2035 Phase II Project conditions are presented in subsequent sections within this chapter.

Distribution patterns and assignment of station-generated traffic (PNR and KNR trips) for the Year 2035 Phase II Project conditions were obtained from the VTA Model.

2035 Phase II Project Conditions Intersection Lane Configurations

The intersection lane configurations under the 2035 Phase II Project conditions were assumed to be the same as described under 2035 No Project/Phase I conditions.

2035 Phase II Project Conditions Intersection Traffic Volumes

Traffic volumes for the Year 2035 Phase II Project conditions were obtained from the VTA Model. These traffic volumes represent traffic projections for the year 2035 with the addition of planned improvements and the Phase II Project and proposed stations. Year 2035 Phase II Project conditions model volume forecasts were adjusted using the method previously described (Introduction chapter).

2035 Phase II Project Conditions Freeway Volumes

Traffic volumes for the Year 2035 Phase II Project conditions for the study freeway segments were obtained from the VTA Model. These volumes represent traffic projections for the year 2035 with the addition of planned improvements and the Phase II Project and proposed stations. Unlike intersection forecast volumes, no adjustments were made to the freeway volumes produced by the VTA Model since the freeway network contained in the VTA Model is represented more accurately than local roadways.

Station Description – Santa Clara Station

The proposed Santa Clara Station would be located at grade just northeast of the Caltrain tracks and the Santa Clara Caltrain Station (between Coleman Avenue and El Camino Real), at the western end of Brokaw Road (see Figure 4). The PNR demand would be accommodated in a 500-space parking structure located north of Brokaw Road and east of the Caltrain tracks. A more detailed description of the Santa Clara Station is included in Chapters 1 and 6.

Station Trip Generation Estimates – Santa Clara Station

The trip generation estimates for the proposed Santa Clara Station under the Year 2035 Phase II Project conditions were developed using the VTA Model and based on the method previously described. Ridership projections total about 10,920 daily BART riders (5,460 boardings and 5,460 alightings) at the Santa Clara Station under the Year 2035 Phase II Project conditions. Table 52 presents the daily and peak hour trip generation estimates for each of the drive access modes to the Santa Clara Station, described in the following sections.

Table 52
Santa Clara Station Trip Generation Estimates – 2035 Phase II Project Conditions

Mode of Access by Station	Daily Trips	Parking Demand (# of Spaces)	AM Peak Hour Trips			PM Peak Hour Trips		
			In	Out	Total	In	Out	Total
<i>Santa Clara Station:</i>								
Kiss and Ride Trips	200		19	19	38	23	23	46
Park and Ride Trips	864	393	116	4	120	11	91	102
Total	1,064		135	23	158	34	114	148

Source: VTA Model, December 2014.

Park-and-Ride Trips

Model projections of passenger volumes for the Santa Clara Station indicate that 864 daily PNR trips would access/egress the station under the Year 2035 Phase II Project conditions. A total of 120 (116 inbound and 4 outbound) and 102 (11 inbound and 91 outbound) PNR trips are estimated to occur during the AM and PM peak hours, respectively.

Kiss-and-Ride Trips

Model projections of passenger volumes for the Santa Clara Station indicate that 200 daily KNR trips would utilize the station under the Year 2035 Phase II Project conditions scenario. Since KNR trips consist of vehicles entering the station site to drop-off a BART commuter and then exiting the site and proceeding on to another destination, station trip generation estimates for peak hour inbound and outbound KNR vehicle trips are equivalent. It is estimated that a total of 38 (19 inbound/19 outbound) KNR trips would occur during the AM peak hour and a total of 46 (23 inbound/23 outbound) KNR trips would occur during the PM peak hour.

Trip Distribution and Assignment

Distribution pattern and assignment of station-generated traffic (PNR and KNR trips) to the proposed Santa Clara Station under the Year 2035 Phase II Project conditions were developed from traffic assignments using the VTA Model. As mentioned previously, implementation of the proposed project would result in a shift in travel pattern, as the result of some commuters modifying their travel route to access the station area, and in the removal of auto trips from the roadway network, as some commuters shift from auto to transit modes of travel. Thus, station-generated traffic consists of two components: 1.) new vehicular trips accessing the proposed Santa Clara Station, referred to as *station drive access* trips, and 2.) all the trips that would no longer be on the roadway as a result of the Phase II Project, represented by negative trips on the roadway network. It is projected that under Year 2035 Phase II Project conditions, approximately 1,400 and 1,150 AM and PM peak-hour trips, respectively, would be removed from the roadway transportation system as the result of the Phase II Project and proposed Stations. The total *net project trips* generated by the Santa Clara Station are therefore calculated by adding the new station drive access trips (positive trips) and the trips removed from the roadway network as a result of the Santa Clara Station and Phase II Project (negative trips). The Santa Clara Station drive access trips for the Year 2035 Phase II Project conditions are shown graphically on Figure 55 while the net project trips are shown on Figure 56.

An example of the trip assignment process and method used to estimate traffic with the project is presented in Chapter 4 for the Alum Rock/28th Street Station.

The trip assignment process shows that at some locations, particularly for those movements leading directly to the station area, the number of vehicles accessing the station is larger than the number of vehicles shifted from the roadway network to transit modes, thus, the project results in a net increase in traffic volumes. At many locations, particularly for those movements either not leading to the station area or leading to freeways, the number of vehicles shifted from the roadway network to transit modes is greater than the number of vehicles using that movement to access the station, and the project results in a net decrease in traffic volumes.

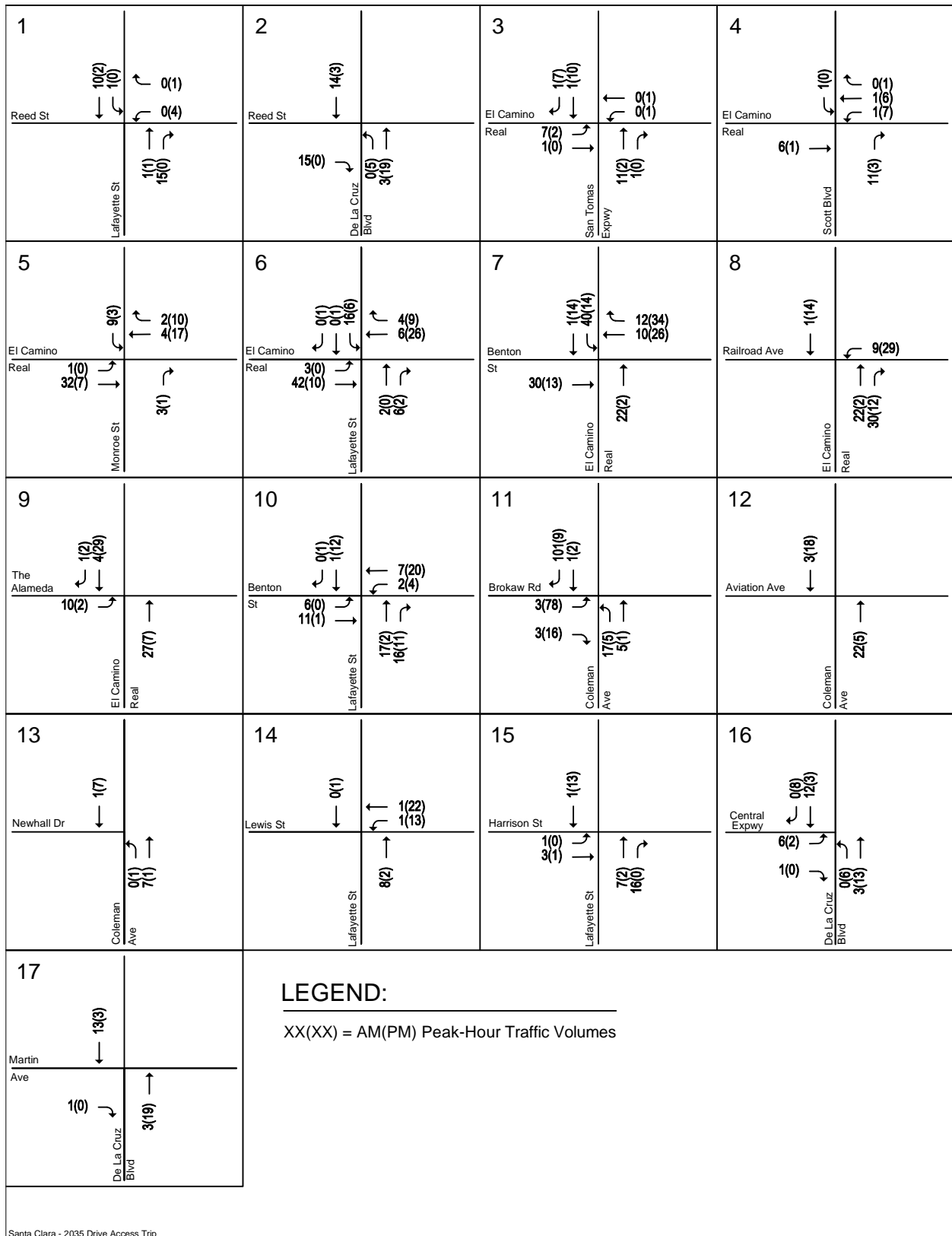

Santa Clara - 2035 Drive Access Trip

Figure 55
2035 Phase II Project Conditions Station (Drive Access) Trips – Santa Clara Station

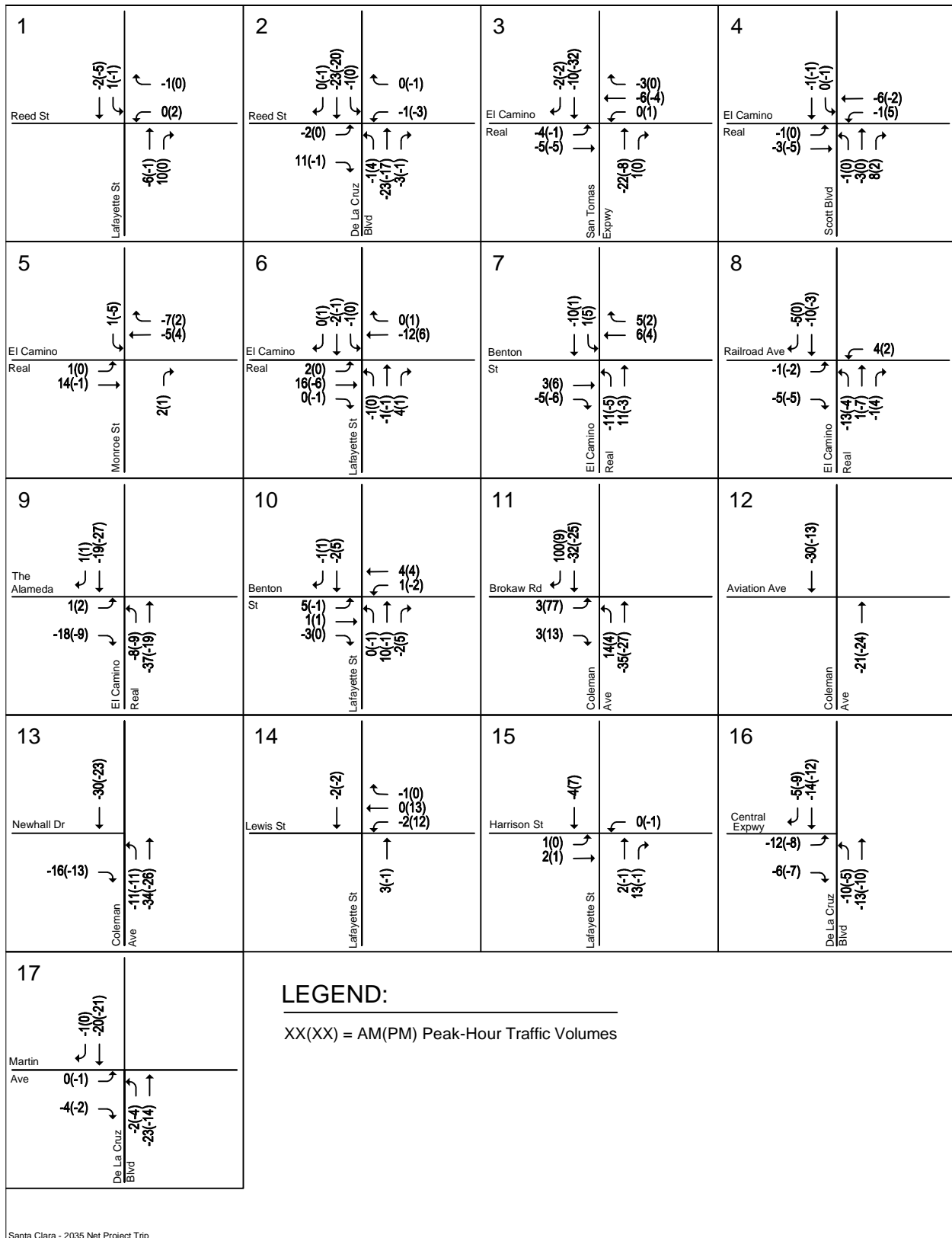

Santa Clara - 2035 Net Project Trip

Figure 56
2035 Phase II Project Conditions Net Project Trips – Santa Clara Station

2035 Phase II Project Conditions Traffic Volumes – Santa Clara Station

Traffic volumes for the Year 2035 Phase II Project conditions were obtained by adding to the Year 2035 No Project/Phase I traffic volumes the traffic projected to be generated by the proposed BART Stations (net project trips, as described above). The net project traffic projections under the Year 2035 Phase II Project conditions were obtained from the VTA Model. The Year 2035 Phase II Project conditions traffic volumes are presented on Figure 57 and included in Appendix D.

2035 Phase II Project Conditions Intersection Levels of Service

The results of the level of service analysis for the Santa Clara Station under the Year 2035 Phase II Project conditions are summarized in Table 53. The results show that the same study intersections identified to operate at unacceptable levels under Year 2035 No Project/Phase I conditions are projected to continue to operate at unacceptable levels of service during at least one peak hour (see Figure 58). CMP intersections are denoted by an asterisk (*).

- (13) Coleman Avenue and Newhall Drive (LOS E – PM peak hour) – San Jose Intersection
- (14) Lafayette Street and Lewis Street (LOS E – PM peak hour) – Santa Clara Intersection
- (16) De La Cruz Boulevard and Central Expressway * (LOS F – AM and PM peak hours) – Santa Clara Intersection

When measured against the City of San Jose significant impact criteria for 2035 conditions, the intersection of Coleman Avenue and Newhall Drive (# 13) would not be significantly impacted by the project. The City of San Jose's significant impact criteria under cumulative conditions requires comparison of 2025 No Project/Phase I conditions and 2035 Phase II Project conditions to see if the Project would contribute a considerable amount (more than 25%) of the total increase in traffic between those two conditions. The Project's contribution to the increase in total volume from 2025 No Project/Phase I Conditions to 2035 Phase II Project Conditions would be less than 25 percent, since the 2035 Phase II Project would result in 91 **fewer** vehicles in the AM peak hour and 73 **fewer** vehicles in the PM peak hour at this intersection compared to traffic volumes under 2025 No Project/Phase I conditions. As shown in Figure 56, the net project trips at this intersection, when all turning movements are added together, is a negative number for both the AM and PM peak hours. Therefore, the Project would not have a significant impact on this intersection under 2035 Phase II Project Conditions, based on the City of San Jose significant impact criteria, and no mitigation is required.

Based the City of Santa Clara and the CMP significant impact criteria, the proposed project would not cause an adverse impact that would exceed the significance thresholds at either of the two City of Santa Clara study intersections in the vicinity of the Santa Clara Station. Therefore, no mitigation is required.

Although the City of Santa Clara does not have a level of service standard for unsignalized intersections, an evaluation of the unsignalized study intersection was performed for informational purposes. The level of service analysis shows that the intersection of Lafayette Street and Harrison Street (#15) is projected to operate at LOS F during both the AM and PM peak hours under Year 2035 Phase II Project conditions. However, the peak-hour traffic signal warrant checks indicate that the intersection would not have traffic volumes under 2035 Phase II Project conditions that meet thresholds that warrant signalization. Level of service F at two-way stop-controlled (TWSC) intersections can occur when gaps of traffic on the major street are limited, resulting in long delays for the minor-street traffic as they attempt to enter or cross the major street. At the study intersection of Lafayette Street and Harrison Street, the relatively high traffic volumes along Lafayette Street (major street) cause the delay on the low-volume Harrison Street (minor street) to be worse than the LOS F threshold. However, the low traffic volumes on Harrison Street result in the peak hour traffic signal warrant not being met.

All other study intersections are projected to operate at an acceptable level of service under City of San Jose, City of Santa Clara, and CMP standards. The level of service calculation sheets for the Santa Clara Station are included in Appendix G.

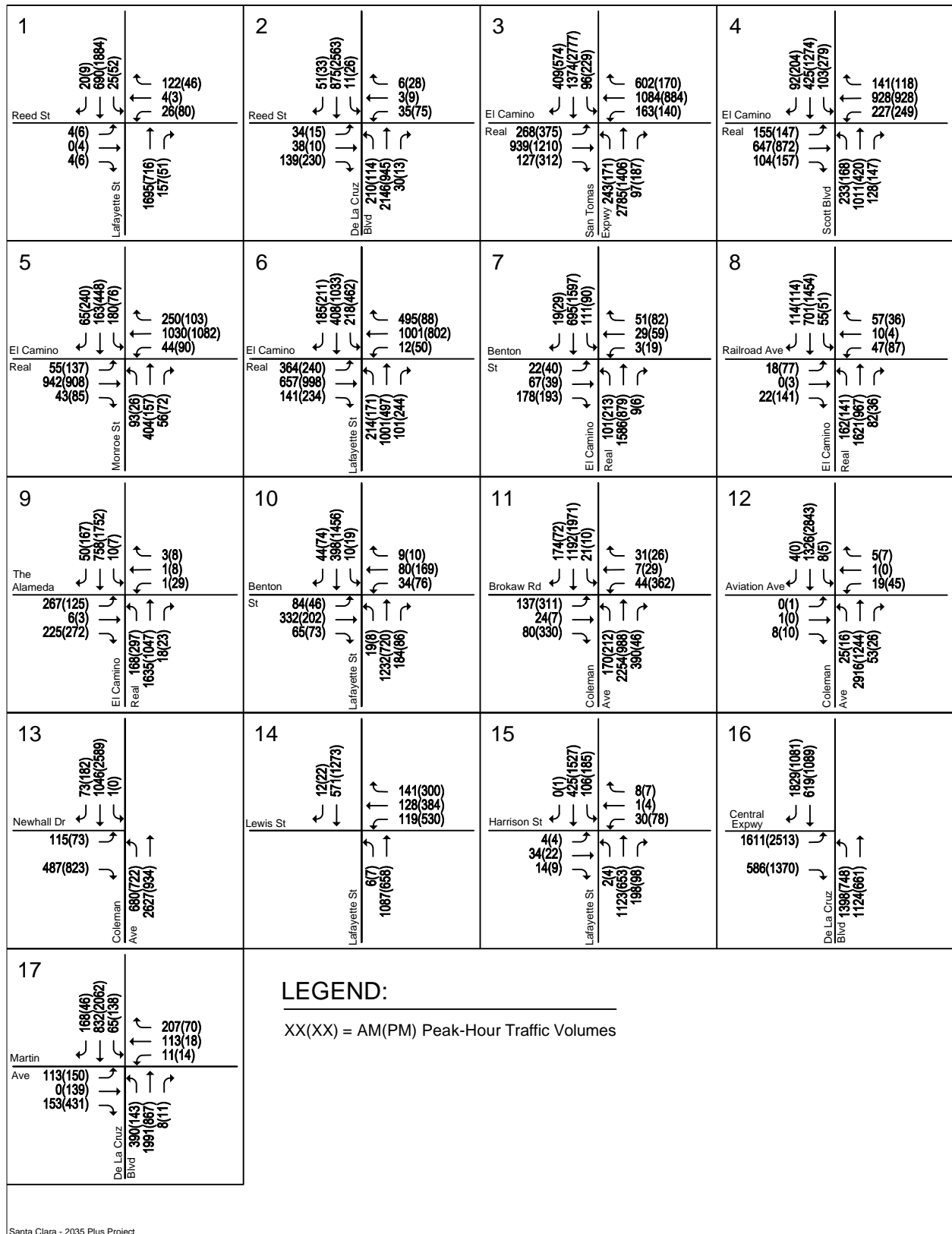

Figure 57
2035 Phase II Project Conditions Traffic Volumes – Santa Clara Station

Table 53
2035 Phase II Project Conditions Intersection Levels of Service – Santa Clara Station

Study Number	Intersection	Peak Hour	2025 No Project		2035 No Project		2035 Phase II Project			
			Avg. Delay ¹	LOS	Avg. Delay ¹	LOS	Avg. Delay ¹	LOS	Incr. In Crit. Delay	Incr. In Crit. V/C
1	Lafayette Street and Reed Street	AM	7.5	A	8.1	A	8.1	A	0.0	0.002
		PM	7.4	A	7.8	A	7.9	A	0.0	0.000
2	De La Cruz Boulevard and Reed Street	AM	14.4	B	16.6	B	17.1	B	0.6	0.001
		PM	18.7	B	19.2	B	19.4	B	0.2	-0.002
3	San Tomas Expressway and El Camino Real *	AM	65.8	E	70.3	E	69.6	E	-1.3	-0.007
		PM	79.6	E	80.0	E	79.2	E	-1.4	-0.007
4	Scott Boulevard and El Camino Real *	AM	35.7	D	37.6	D	37.5	D	-0.1	-0.003
		PM	40.1	D	41.0	D	41.0	D	0.2	0.002
5	Monroe Street and El Camino Real *	AM	35.9	D	37.2	D	37.3	D	0.1	0.002
		PM	32.9	C	33.1	C	33.1	C	0.0	0.001
6	Lafayette Street and El Camino Real *	AM	39.4	D	41.2	D	41.1	D	0.0	0.000
		PM	40	D	40.7	D	40.7	D	-0.1	-0.001
7	El Camino Real and Benton Street	AM	13.7	B	14.7	B	14.6	B	0.0	0.002
		PM	16	B	16.6	B	16.5	B	-0.1	-0.003
8	El Camino Real and Railroad Avenue	AM	10.6	B	11.0	B	11.0	B	0.0	0.000
		PM	12.3	B	12.5	B	12.4	B	-0.1	-0.002
9	El Camino Real and The Alameda *	AM	17.2	B	19.7	B	19.6	B	-0.1	-0.010
		PM	18.7	B	18.6	B	18.3	B	-0.6	-0.012
10	Lafayette Street and Benton Street	AM	18.6	B	19.4	B	19.4	B	-0.1	0.001
		PM	15.7	B	15.7	B	15.7	B	0.1	0.002
11	Coleman Avenue and Brokaw Road	AM	17.2	B	17.3	B	17.5	B	0.1	-0.005
		PM	45.9	D	47.3	D	48.7	D	2.0	0.006
12	Coleman Avenue and Aviation Avenue	AM	19.9	B	21.6	C	20.4	C	-1.8	-0.006
		PM	7	A	7.0	A	7.0	A	0.0	-0.002
13	Coleman Avenue and Newhall Drive	AM	22.7	C	28.1	C	27.6	C	-0.5	-0.012
		PM	41.4	D	71.8	E	68.3	E	-4.5	-0.013
14	Lafayette Street and Lewis Street	AM	11.3	B	12.3	B	12.2	B	-0.1	-0.002
		PM	48.6	D	55.2	E	56.6	E	2.4	0.006
15	Lafayette Street and Harrison Street (unsignalized) ²	AM	166.1	F	³	F	³	F	²	²
		PM	³	F	³	F	³	F	²	²
16	De La Cruz Boulevard and Central Expressway *	AM	357.2	F	362.0	F	360.0	F	-4.4	-0.010
		PM	171.8	F	238.1	F	234.7	F	-5.0	-0.009
17	De La Cruz Boulevard and Martin Avenue	AM	35.5	D	36.3	D	36.2	D	0.0	-0.005
		PM	32.6	C	31.9	C	31.9	C	-0.2	-0.005

* Denotes CMP Intersection

Entries denoted in **bold** indicate conditions that exceed the applicable level of service standard.

¹The reported delay and corresponding level of service for signalized intersections represents the average delay for all approaches at the intersection. The reported delay and corresponding level of service for unsignalized (two-way stop-controlled) intersections are based on the stop-controlled approach with the highest delay.

²The City of Santa Clara does not have a level of service standard nor impact criteria for unsignalized intersections. Reported intersection delay is presented for informational purposes only.

³Worst approach intersection delay is projected to be greater than 200 seconds per vehicle.

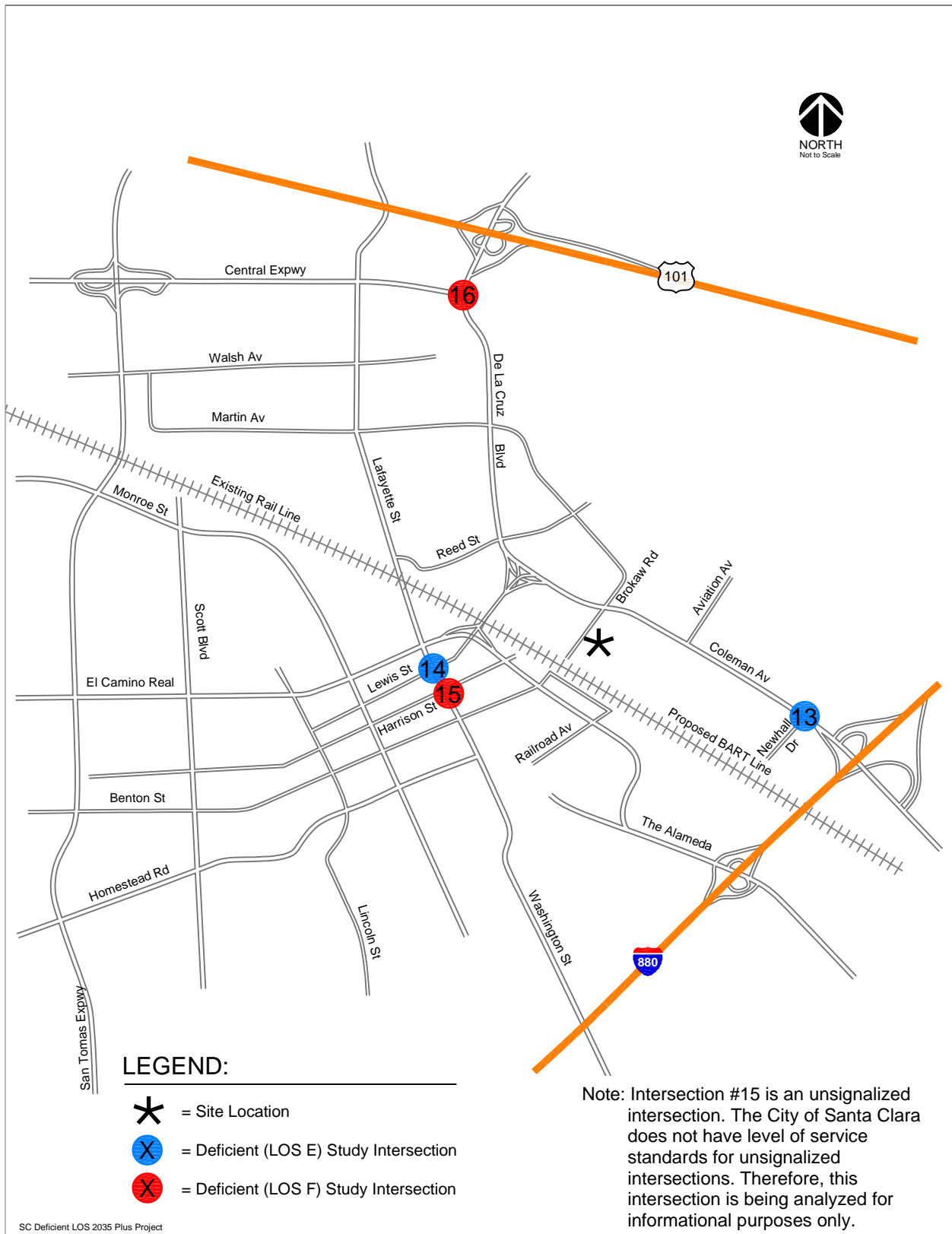

Figure 58
2035 Phase II Project Conditions Deficient LOS Intersections – Santa Clara Station

2035 Phase II Project Conditions Freeway Segment Levels of Service

Traffic volumes for the Year 2035 Phase II Project conditions for the study freeway segments were obtained from the VTA Model. These volumes represent traffic projections for the year 2035 with the addition of planned improvements and the Phase II Project and proposed stations. Note that the project would result in a decrease in traffic volumes on the freeway network, as commuters use BART as an alternative to regional freeway travel. While a portion of traffic accessing the station areas would use the freeway network to do so, generally those trips are already on the freeway network and do not represent an increase in traffic from Year 2035 No Project/Phase I conditions. However, a number of others accessing the station would do so via transit or local streets, and therefore would result in a net reduction in freeway volumes. The net reduction in peak hour freeway volumes along the study freeway segments as a result of the implementation of the Phase II Project and the Santa Clara Station are presented in Table 54.

The results of the freeway analysis are summarized in Table 54. The results show that 24 of the 26 directional freeway segments (and 8 HOV segments) analyzed for the Santa Clara Station would operate at an unacceptable LOS F during at least one of the peak hours. Since the project would not add traffic representing one percent or more of the segment's capacity to any of the study freeway segments projected to operate at LOS F (including HOV segments), the project would not cause an adverse impact that would exceed the significance thresholds on any of the freeway segments analyzed under the Year 2035 Phase II Project conditions, according to VTA CMP level of service impact criteria for freeways. Therefore, no mitigation is required.

2035 Phase II Project Conditions Freeway Ramp Analysis

Based on the traffic volume projections obtained from the VTA Model, the Phase II Project is not projected to increase freeway ramp volumes by 10 or more peak-hour trips at any freeway ramp in the vicinity of the Santa Clara Station.

Bicycle, Pedestrian, and Transit Facilities Analyses

With the proposed project, an approximately 240-foot-long pedestrian tunnel would connect from the Santa Clara BART Station to the Santa Clara Caltrain Station plaza, and an approximately 175-foot-long pedestrian tunnel would connect from the BART station to a new BART plaza on Brokaw Road. This pedestrian connection would link the station with other pedestrian and transit facilities in the vicinity, enhancing connectivity of pedestrian facilities surrounding the station and transit services. Additionally, with the exception of the east side of Lafayette Street, sidewalks are found along most local roadways in the study area and along the local residential streets and collectors near the Santa Clara Station site. All signalized intersections in the vicinity of the Santa Clara Station have marked crosswalks on all or most of the legs of the intersection combined with pedestrian push buttons and pedestrian signal heads. In combination with planned pedestrian/bicycle improvements in the study area, the project-sponsored pedestrian/bicycle improvements would help enhance pedestrian/bicycle facilities in the area. Therefore, the Phase II Project would not result in any significant impacts on bicycle and pedestrian circulation, and no mitigation measures are required.

The Phase II Project is a transit project and therefore represents a substantial improvement to the transit system in the study area. Additionally, the Phase II Project is being integrated with VTA's light rail and bus systems and would not adversely impact transit facilities or services within the Cities of San Jose and Santa Clara in the vicinity of the BART extension or the proposed BART stations.

Table 54
2035 Phase II Project Conditions Freeway Levels of Service – Santa Clara Station

Freeway Segment		Direction	Peak Hour	2035 Phase II Project Conditions											Net Project Trips				
				Mixed-Flow Lane					HOV Lane						Mixed-Flow Lane		HOV Lane		
				Avg. Speed	# of Lanes	Capacity	Project Volume	Density	LOS	Avg. Speed	# of Lanes	Capacity	Project Volume	Density	LOS	Volume	% of Capacity	Volume	% of Capacity
US 101	I-880 to Old Bayshore	NB	AM	14.0	3.0	6,900	6,039	144	F	19.0	1.0	1,650	1,905	100	F	-11	-0.16	-7	-0.42
			PM	67.0	3.0	6,900	3,732	19	C	70.0	1.0	1,650	620	9	A	-5	-0.07	-1	-0.06
US 101	Old Bayshore to First	NB	AM	12.0	3.0	6,900	6,330	176	F	13.0	1.0	1,650	1,790	138	F	-23	-0.33	-7	-0.42
			PM	66.0	3.0	6,900	4,191	21	C	70.0	1.0	1,650	609	9	A	-14	-0.20	-1	-0.06
US 101	First to SR 87	NB	AM	19.0	3.0	6,900	6,786	119	F	19.0	1.0	1,650	1,616	85	F	-34	-0.49	-6	-0.36
			PM	67.0	3.0	6,900	5,220	26	C	70.0	1.0	1,650	728	10	A	-19	-0.28	-1	-0.06
US 101	SR 87 to De La Cruz	NB	AM	12.0	3.0	6,900	6,687	186	F	14.0	1.0	1,650	1,585	113	F	-30	-0.43	-6	-0.36
			PM	66.0	3.0	6,900	5,621	28	D	70.0	1.0	1,650	728	10	A	-21	-0.30	-1	-0.06
US 101	De La Cruz to Montague	NB	AM	26.0	3.0	6,900	6,613	85	F	39.0	1.0	1,650	2,132	55	E	-31	-0.45	-9	-0.55
			PM	65.0	3.0	6,900	5,577	29	D	70.0	1.0	1,650	1,232	18	B	-20	-0.29	-4	-0.24
US 101	Montague to Great America	NB	AM	21.0	3.0	6,900	6,767	107	F	41.0	1.0	1,650	1,723	42	D	-30	-0.43	-7	-0.42
			PM	58.0	3.0	6,900	5,903	34	D	70.0	1.0	1,650	1,300	19	C	-18	-0.26	-4	-0.24
I-880	I-280 to Stevens Creek	NB	AM	15.0	3.0	6,900	5,179	115	F	55.0	1.0	1,650	660	12	B	-42	-0.61	-2	-0.12
			PM	66.0	3.0	6,900	4,874	25	C	55.0	1.0	1,650	645	12	B	-29	-0.42	-3	-0.18
I-880	Stevens Creek to Bascom	NB	AM	20.0	3.0	6,900	6,797	113	F	55.0	1.0	1,650	659	12	B	-73	-1.06	-2	-0.12
			PM	16.0	3.0	6,900	5,672	118	F	55.0	1.0	1,650	645	12	B	-39	-0.57	-3	-0.18
I-880	Bascom to The Alameda	NB	AM	27.0	3.0	6,900	6,149	76	F	55.0	1.0	1,650	707	13	B	-81	-1.17	-3	-0.18
			PM	13.0	3.0	6,900	6,205	159	F	55.0	1.0	1,650	727	13	B	-53	-0.77	-4	-0.24
I-880	The Alameda to Coleman	NB	AM	31.0	3.0	6,900	6,404	69	F	55.0	1.0	1,650	741	13	B	-104	-1.51	-4	-0.24
			PM	15.0	3.0	6,900	6,552	146	F	55.0	1.0	1,650	939	17	B	-73	-1.06	-8	-0.48
I-880	Coleman to SR 87	NB	AM	22.0	3.0	6,900	6,075	92	F	55.0	1.0	1,650	851	15	B	-118	-1.71	-8	-0.48
			PM	24.0	3.0	6,900	6,509	90	F	55.0	1.0	1,650	1,085	20	C	-91	-1.32	-15	-0.91
I-880	SR 87 to First	NB	AM	48.0	3.0	6,900	6,075	42	D	55.0	1.0	1,650	851	15	B	-118	-1.71	-8	-0.48
			PM	22.0	3.0	6,900	6,509	99	F	55.0	1.0	1,650	1,085	20	C	-91	-1.32	-15	-0.91
I-880	First to US 101	NB	AM	36.0	3.0	6,900	5,718	53	E	55.0	1.0	1,650	683	12	B	-122	-1.77	-7	-0.42
			PM	51.0	3.0	6,900	6,949	45	D	55.0	1.0	1,650	937	17	B	-104	-1.51	-14	-0.85

Table 54 (Continued)
2035 Phase II Project Conditions Freeway Levels of Service – Santa Clara Station

Freeway Segment		Direction	Peak Hour	2035 Phase II Project Conditions											Net Project Trips				
				Mixed-Flow Lane					HOV Lane						Mixed-Flow Lane		HOV Lane		
				Avg. Speed	# of Lanes	Capacity	Project Volume	Density	LOS	Avg. Speed	# of Lanes	Capacity	Project Volume	Density	LOS	Volume	% of Capacity	Volume	% of Capacity
I-880	US 101 to First	SB	AM	16.0	3.0	6,900	6,202	129	F	55.0	1.0	1,650	983	18	B	-89	-1.29	-17	-1.03
			PM	14.0	3.0	6,900	5,705	136	F	55.0	1.0	1,650	908	17	B	-135	-1.96	-7	-0.42
I-880	First to SR 87	SB	AM	25.0	3.0	6,900	5,754	77	F	55.0	1.0	1,650	1,032	19	C	-77	-1.12	-17	-1.03
			PM	14.0	3.0	6,900	5,613	134	F	55.0	1.0	1,650	1,003	18	B	-121	-1.75	-7	-0.42
I-880	SR 87 to Coleman	SB	AM	65.0	3.0	6,900	5,754	30	D	55.0	1.0	1,650	1,032	19	C	-77	-1.12	-17	-1.03
			PM	23.0	3.0	6,900	5,613	81	F	55.0	1.0	1,650	1,003	18	B	-121	-1.75	-7	-0.42
I-880	Coleman to The Alameda	SB	AM	66.0	3.0	6,900	6,319	32	D	55.0	1.0	1,650	750	14	B	-82	-1.19	-5	-0.30
			PM	23.0	3.0	6,900	6,625	96	F	55.0	1.0	1,650	848	15	B	-121	-1.75	-3	-0.18
I-880	The Alameda to Bascom	SB	AM	66.0	3.0	6,900	5,970	30	D	55.0	1.0	1,650	690	13	B	-51	-0.74	-4	-0.24
			PM	25.0	3.0	6,900	6,460	86	F	55.0	1.0	1,650	924	17	B	-105	-1.52	-3	-0.18
I-880	Bascom to Stevens Creek	SB	AM	50.0	3.0	6,900	5,959	40	D	55.0	1.0	1,650	691	13	B	-43	-0.62	-4	-0.24
			PM	30.0	3.0	6,900	6,546	73	F	55.0	1.0	1,650	948	17	B	-92	-1.33	-3	-0.18
I-880	Stevens Creek to I-280	SB	AM	66.0	3.0	6,900	4,585	23	C	55.0	1.0	1,650	589	11	A	-32	-0.46	-3	-0.18
			PM	65.0	3.0	6,900	4,650	24	C	55.0	1.0	1,650	861	16	B	-69	-1.00	-3	-0.18
US 101	Great America to Montague	SB	AM	66.0	3.0	6,900	6,090	31	D	67.0	1.0	1,650	1,276	19	C	-34	-0.49	-5	-0.30
			PM	14.0	3.0	6,900	6,887	164	F	20.0	1.0	1,650	1,778	89	F	-21	-0.30	-6	-0.36
US 101	Montague to De La Cruz	SB	AM	66.0	3.0	6,900	5,628	28	D	67.0	1.0	1,650	1,222	18	B	-35	-0.51	-5	-0.30
			PM	13.0	3.0	6,900	6,410	164	F	40.0	1.0	1,650	2,040	51	E	-21	-0.30	-7	-0.42
US 101	De La Cruz to SR 87	SB	AM	62.0	3.0	6,900	6,647	36	D	67.0	1.0	1,650	1,132	17	B	-41	-0.59	-5	-0.30
			PM	18.0	3.0	6,900	8,269	153	F	50.0	1.0	1,650	2,075	42	D	-26	-0.38	-7	-0.42
US 101	SR 87 to First	SB	AM	67.0	3.0	6,900	4,705	23	C	67.0	1.0	1,650	881	13	B	-31	-0.45	-3	-0.18
			PM	16.0	3.0	6,900	6,114	127	F	30.0	1.0	1,650	1,831	61	F	-21	-0.30	-6	-0.36
US 101	First to Old Bayshore	SB	AM	67.0	3.0	6,900	3,516	17	B	67.0	1.0	1,650	639	10	A	-27	-0.39	-3	-0.18
			PM	6.0	3.0	6,900	4,958	275	F	20.0	1.0	1,650	1,592	80	F	-17	-0.25	-6	-0.36
US 101	Old Bayshore to I-880	SB	AM	67.0	3.0	6,900	4,522	22	C	67.0	1.0	1,650	721	11	A	-27	-0.39	-3	-0.18
			PM	8.0	3.0	6,900	6,172	257	F	30.0	1.0	1,650	1,818	61	F	-20	-0.29	-6	-0.36

Source: Santa Clara Valley Transportation Authority Congestion Management Program Monitoring Study, 2014.
 The average speed for future HOV lanes are assumed to be 55 MPH.
Bold indicates unacceptable LOS.

Parking Analysis

Revisions to the significance thresholds for CEQA that became effective on January 1, 2010, eliminated effects on parking. The revisions to the CEQA thresholds were based on the decision in *San Franciscans Upholding the Downtown Plan v. City & County of SF*, 102 Cal.App.4th 65 (Sept. 30, 2002), in which the court ruled that parking deficits are an inconvenience to drivers but not a significant physical impact on the environment. As a result of this change to the State CEQA Guidelines, VTA adopted new significance thresholds that did not include the effects of parking on November 4, 2010.

Parking conditions evolve over time as people alter their modes and patterns of travel in response to changing land uses and transportation options. The availability of parking spaces is not part of the permanent physical environment subject to environmental review. Therefore, the loss of parking spaces by itself or the generation of parking demand by itself are not considered a direct significant impact on the physical environment in this TIA. However, parking losses caused by a project or parking demand generated by a project in excess of the parking provided could result in a significant indirect impact on the environment if drivers circling for parking cause significant secondary effects on traffic operations or air quality. The following discussion of parking is for information purposes for CEQA and impact analysis purposes for NEPA and as background to the evaluation of any secondary effects on traffic operations and air quality.

Near the Santa Clara Station, there are three surface parking lots west of the railroad tracks serving the Santa Clara Caltrain Station. The west lot is jointly owned by the City of Santa Clara and VTA and is designated for Caltrain patrons. The Santa Clara Station projected BART PNR demand is approximately 400 spaces. This demand would be accommodated by providing 500 parking spaces in an up to five-story parking structure.

Event Center Analysis

There are two major event facilities along the Phase II BART extension: the SAP Center near the Diridon Station and Avaya Stadium near the Santa Clara Station. Because potential interference with activities at event centers is not included in Appendix G of the State CEQA Guidelines, this discussion is provided for informational purposes only for CEQA and impact analysis purposes for NEPA.

The Avaya Stadium, which is the home of the San Jose Earthquakes soccer team, is at Coleman Avenue and Newhall Drive near the San Jose/Santa Clara City limit line. It is also close to the Newhall Maintenance Facility and Santa Clara Station.

During the 2015 season, almost all soccer games were played on weekend days. Four games were played on Friday evenings and started at 8:00 p.m., which is 2 hours after the typical commute hour ends. Only one soccer game was played on a (midweek) Wednesday, and it started at 7:30 p.m. Intersection counts at two main parking lots along Coleman Avenue were conducted on Friday, October 16, 2015, starting 3 hours before game time. Based on these traffic counts, it was estimated that about 18 percent of the soccer traffic arrived between the 5:00 and 6:00 p.m. commute hour, which is 2 to 3 hours before the game started. About 23 percent of the soccer traffic arrived between 1.5 and 2.5 hours before game time (between 5:30 and 6:30 p.m.). The majority of soccer traffic arrived within the hour before game time. Assuming that the Earthquakes soccer schedule in future years is similar to the 2015 schedule, soccer traffic would coincide with evening commute traffic only 5 days a year. The starting time of soccer games occurs after the peak (5:00 to 6:00 p.m.) commute hour, and the majority of soccer traffic arrives after the evening commute traffic has peaked. Therefore, because there are only a handful of soccer games per year that are played on weekday evenings and because most of the soccer traffic arrives after the peak commute hour has ended, weekday afternoon commute traffic conditions on game days, with or without the BART Extension, would be affected only infrequently. There would be no adverse effects under NEPA, and no mitigation is required.

11.

Conclusions

The potential impacts of the VTA's BART Silicon Valley – Phase II Extension Project were evaluated in accordance with the standards set forth by the Cities of San Jose and Santa Clara, the Congestion Management Program of Santa Clara County, the California Environmental Quality Act, and the National Environmental Protection Act. The study includes the analysis of a total of 17 signalized intersections and 10 freeway segments in the vicinity of the Alum Rock/28th Street Station, a total of 29 signalized intersections and 9 freeway segments in the vicinity of the Diridon Station, and a total of 16 signalized intersections, one unsignalized intersection, and 13 freeway segments in the vicinity of the Santa Clara Station. All study intersections are located within the Cities of San Jose and Santa Clara.

Year 2025 Phase II Project Conditions Results

Intersection Level of Service Analysis

Alum Rock/28th Street Station

The results of the level of service analysis for the Alum Rock/28th Street Station under the Year 2025 Phase II Project conditions show that the same study intersections identified to operate at unacceptable levels under Year 2025 No Project/Phase I conditions are projected to continue to operate at unacceptable levels of service during at least one peak hour.

- (4) US 101 and East Julian Street (LOS E – PM peak hour)
- (6) King Road and McKee Road (LOS E – AM and PM peak hours)

However, based on City of San Jose and the CMP level of service impact criteria, the proposed project would not cause an adverse impact that would exceed the significance thresholds at any of the study intersections in the vicinity of the Alum Rock/28th Street Station. Therefore, mitigation is not required.

Diridon Station

The results of the level of service analysis for the Diridon Station under the Year 2025 Phase II Project conditions show that the same study intersections identified to operate at unacceptable levels under Year 2025 No Project/Phase I conditions are projected to continue to operate at unacceptable levels of service during one or both peak hours.

- (1) The Alameda and Taylor Street/Naglee Avenue* (LOS E – AM peak hour)
- (29) Meridian Avenue and Fruitdale Avenue (LOS E – AM and PM peak hours)

However, based on City of San Jose and the CMP level of service impact criteria, the proposed project would not cause an adverse impact that would exceed the significance thresholds at any of the study intersections in the vicinity of the Diridon Station. Therefore, mitigation is not required.

Santa Clara Station

The results of the level of service analysis for the Santa Clara Station under the Year 2025 Phase II Project conditions show that the same study intersection identified to operate at unacceptable levels under Year 2025 No Project/Phase I conditions is projected to continue to operate at unacceptable levels of service during both peak hours. CMP intersections are denoted by an asterisk (*).

(16) De La Cruz Boulevard and Central Expressway * (LOS F – AM and PM peak hours)

However, based on City of San Jose, City of Santa Clara and the CMP level of service impact criteria, the proposed project would not cause an adverse impact that would exceed the significance thresholds at any of the study intersections in the vicinity of the Santa Clara Station. Therefore, mitigation is not required.

Although the City of Santa Clara does not have a level of service standard for unsignalized intersections, an evaluation of the unsignalized study intersection was performed for informational purposes. The level of service analysis shows that the intersection of Lafayette Street and Harrison Street (#15) is projected to operate at LOS F during both the AM and PM peak hours under Year 2025 Phase II Project conditions. However, the peak-hour traffic signal warrant checks indicate that the intersection would not have traffic volumes under 2025 Phase II Project conditions that meet thresholds that warrant signalization.

Freeway Level of Service Analysis

Alum Rock/28th Street Station

The results of the freeway level of service analysis show that 12 of the 20 directional freeway segments (and 4 HOV segments) analyzed for the Alum Rock/28th Street Station would operate at an unacceptable LOS F during at least one of the peak hours. Since the project would not add traffic representing one percent or more of the segment's capacity to any of the study freeway segments projected to operate at LOS F (including HOV segments), the project would not cause an adverse impact that would exceed the significance thresholds on any of the freeway segments analyzed under the Year 2025 Phase II Project conditions, according to VTA CMP level of service impact criteria for freeways. Therefore, mitigation is not required.

Diridon Station

The results of the freeway level of service analysis show that 17 of the 18 directional freeway segments (and 1 HOV segment) analyzed for the Diridon Station would operate at an unacceptable LOS F during at least one of the peak hours. Since the project would not add traffic representing one percent or more of the segment's capacity to any of the study freeway segments projected to operate at LOS F (including HOV segments), the project would not cause an adverse impact that would exceed the significance thresholds on any of the freeway segments analyzed under the Year 2025 Phase II Project conditions, according to VTA CMP level of service impact criteria for freeways. Therefore, mitigation is not required.

Santa Clara Station

The results of the freeway level of service analysis show that 24 of the 26 directional freeway segments (and 6 HOV segments) analyzed for the Santa Clara Station would operate at an unacceptable LOS F during at least one of the peak hours. Since the project would not add traffic representing one percent or more of the segment's capacity to any of the study freeway segments projected to operate at LOS F (including HOV segments), the project would not cause an adverse impact that would exceed the significance thresholds on any of the freeway segments analyzed under the Year 2025 Phase II Project conditions, according to VTA CMP level of service impact criteria for freeways. Therefore, mitigation is not required.

Freeway Ramp Queue Lengths

Based on the projected queue lengths obtained from TRAFFIX, it was determined that the available queue storage space for the freeway off-ramps studied would be sufficient to serve the projected demand

under Year 2025 Phase II Project conditions. The proposed project is projected to increase queue lengths at the study off-ramps by no more than 4 vehicles during the peak hours.

The queue length projections for the freeway on-ramps show that the on-ramps studied would experience excessive queue lengths that would spill out of the ramps onto the adjacent street under Year 2025 No Project/Phase I conditions and the proposed project is projected to increase the queue length under Year 2025 Phase II Project conditions. This is the result of the of the projected on-ramp demand exceeding the assumed ramp capacity.

Year 2035 Phase II Project Conditions Results

Intersection Level of Service Analysis

Alum Rock/28th Street Station

The results of the level of service analysis for the Alum Rock/28th Street Station under the Year 2035 Phase II Project conditions show that the same study intersection identified to operate at unacceptable levels under Year 2035 No Project/Phase I conditions is projected to continue to operate at unacceptable levels of service during both peak hours.

- (6) King Road and McKee Road (LOS F – AM peak hour, LOS E – PM peak hour)

However, based on City of San Jose and CMP level of service impact criteria, the proposed project would not cause an adverse impact that would exceed the significance thresholds at any of the study intersections in the vicinity of the Alum Rock/28th Street Station. Therefore, mitigation is not required.

Diridon Station

The results of the level of service analysis for the Diridon Station under the Year 2035 Phase II Project conditions show that three study intersections identified to operate at unacceptable levels under Year 2035 No Project/Phase I conditions are projected to continue to operate at unacceptable levels of service during at least one peak hour.

- 1) The Alameda and Taylor Street/Naglee Avenue* (LOS E – AM & PM peak hours)
- (17) South Autumn Street and Park Avenue (LOS E – PM peak hour)
- (29) Meridian Avenue and Fruitdale Avenue (LOS E – AM & PM peak hours)

However, based on City of San Jose and CMP level of service impact criteria, the proposed project would not cause an adverse impact that would exceed the significance thresholds at any of the study intersections in the vicinity of the Diridon Station. Therefore, mitigation is not required.

Santa Clara Station

The results of the level of service analysis for the Santa Clara Station under the Year 2035 Phase II Project conditions show that the same study intersections identified to operate at unacceptable levels under Year 2035 No Project/Phase I conditions are projected to continue to operate at unacceptable levels of service during at least one peak hour. CMP intersections are denoted by an asterisk (*).

- (13) Coleman Avenue and Newhall Drive (LOS E – PM peak hour)
- (14) Lafayette Street and Lewis Street (LOS E – PM peak hour)
- (16) De La Cruz Boulevard and Central Expressway * (LOS F – AM and PM peak hours)

However, based on City of San Jose, City of Santa Clara and the CMP level of service impact criteria, the proposed project would not cause an adverse impact that would exceed the significance thresholds at any of the study intersections in the vicinity of the Santa Clara Station. Therefore, mitigation is not required.

Although the City of Santa Clara does not have a level of service standard for unsignalized intersections, an evaluation of the unsignalized study intersection was performed for informational purposes. The level

of service analysis shows that the intersection of Lafayette Street and Harrison Street (#15) is projected to operate at LOS F during both the AM and PM peak hours under Year 2035 Phase II Project conditions. However, the peak-hour traffic signal warrant checks indicate that the intersection would not have traffic volumes under 2035 Phase II Project conditions that meet thresholds that warrant signalization.

Freeway Level of Service Analysis

Alum Rock/28th Street Station

The results of the freeway level of service analysis show that 12 of the 20 directional freeway segments (and 4 HOV segments) analyzed for the Alum Rock/28th Street Station would operate at an unacceptable LOS F during at least one of the peak hours. Since the project would not add traffic representing one percent or more of the segment's capacity to any of the study freeway segments projected to operate at LOS F (including HOV segments), the project would not cause an adverse impact that would exceed the significance thresholds on any of the freeway segments analyzed under the Year 2035 Phase II Project conditions, according to VTA CMP level of service impact criteria for freeways. Therefore, mitigation is not required.

Diridon Station

The results of the freeway level of service analysis show that 17 of the 18 directional freeway segments (and 3 HOV segments) analyzed for the Diridon Station would operate at an unacceptable LOS F during at least one of the peak hours. Since the project would not add traffic representing one percent or more of the segment's capacity to any of the study freeway segments projected to operate at LOS F (including HOV segments), the project would not cause an adverse impact that would exceed the significance thresholds on any of the freeway segments analyzed under the Year 2035 Phase II Project conditions, according to VTA CMP level of service impact criteria for freeways. Therefore, mitigation is not required.

Santa Clara Station

The results of the freeway level of service analysis show that 24 of the 26 directional freeway segments (and 8 HOV segments) analyzed for the Santa Clara Station would operate at an unacceptable LOS F during at least one of the peak hours. Since the project would not add traffic representing one percent or more of the segment's capacity to any of the study freeway segments projected to operate at LOS F (including HOV segments), the project would not cause an adverse impact that would exceed the significance thresholds on any of the freeway segments analyzed under the Year 2035 Phase II Project conditions, according to VTA CMP level of service impact criteria for freeways. Therefore, mitigation is not required.

Freeway Ramp Queue Lengths

Based on the projected queue lengths obtained from TRAFFIX, it was determined that the available queue storage space for the freeway off-ramps studied would be sufficient to serve the projected demand under Year 2035 Phase II Project conditions. The proposed project is projected to increase queue lengths at the study off-ramps by no more than 4 vehicles during the peak hours.

The queue length projections for the freeway on-ramps show that the on-ramps studied would experience excessive queue lengths that would spill out of the ramps onto the adjacent street under Year 2035 No Project/Phase I conditions and the proposed project is projected to increase the queue length under Year 2035 Phase II Project conditions. This is the result of the of the projected on-ramp demand exceeding the assumed ramp capacity.

Bicycle, Pedestrian, and Transit Facilities Analyses

Alum Rock/28th Street Station

With the proposed project, a pedestrian connection along the south side of the Alum Rock/28th Street Station area at North 28th Street from East Santa Clara Street would be provided. This pedestrian connection, which would include such amenities as street trees, wide sidewalks, bicycle facilities, and

pedestrian-scaled lighting, would link the station entrances with buses and BRT operating on East Santa Clara Street/Alum Rock Avenue, enhancing connectivity of pedestrian facilities surrounding the station. Additionally, the project would add sidewalks around the perimeter of the Alum Rock/28th Street Station and the west side of 28th Street from the station entrance to Santa Clara Street. Crosswalks at the signalized intersections of North 28th Street/East St. James Street and North 28th Street/Five Wounds Lane would also be provided, including pedestrian push buttons and signal heads. In combination with planned pedestrian/bicycle improvements in the study area, the project-sponsored pedestrian/bicycle improvements would enhance pedestrian/bicycle facilities in the area. Therefore, the Phase II Project would improve connectivity and would not result in any significant impacts on bicycle and pedestrian circulation. No mitigation measures are required.

Diridon Station

Street-level station entrance portals would provide pedestrian linkages to the Diridon Caltrain Station and SAP Center. Additionally, sidewalks are found along all local roadways in the Diridon Station study area and along the local residential streets and collectors near the station site. All signalized intersections in the vicinity of the Diridon Station have marked crosswalks on all or most of the legs of the intersection combined with pedestrian push buttons and pedestrian signal heads. In combination with planned pedestrian/bicycle improvements in the study area, the project-sponsored pedestrian/bicycle improvements will help enhance pedestrian/bicycle facilities in the area. Therefore, the Phase II Project would not result in any significant impacts on bicycle and pedestrian circulation, and no mitigation measures are required.

Santa Clara Station

With the proposed project, an approximately 240-foot-long pedestrian tunnel would connect from the Santa Clara BART Station to the Santa Clara Caltrain Station plaza, and an approximately 175-foot-long pedestrian tunnel would connect from the BART station to a new BART plaza on Brokaw Road. This pedestrian connection would link the station with other pedestrian and transit facilities in the vicinity, enhancing connectivity of pedestrian facilities surrounding the station and transit services. Additionally, with the exception of the east side of Lafayette Street, sidewalks are found along most local roadways in the study area and along the local residential streets and collectors near the Santa Clara Station site. All signalized intersections in the vicinity of the Santa Clara Station have marked crosswalks on all or most of the legs of the intersection combined with pedestrian push buttons and pedestrian signal heads. In combination with planned pedestrian/bicycle improvements in the study area, the project-sponsored pedestrian/bicycle improvements will help enhance pedestrian/bicycle facilities in the area. Therefore, the Phase II Project would not result in any significant impacts on bicycle and pedestrian circulation, and no mitigation measures are required.

Transit Analysis - All Stations

The Phase II Project *is* a transit project and therefore represents a substantial improvement to the transit system in the study area. Additionally, the Phase II Project is being integrated with VTA's light rail and bus systems and would not adversely impact transit facilities or services within the Cities of San Jose and Santa Clara in the vicinity of the BART extension or the proposed BART stations.

Transportation Impact Analysis of the BART Extension Only

Technical Appendices

Appendix A

**Study Intersections for the “BART Extension TIA,”
the “BART Extension with TOJD TIA,”
and the SEIS/SEIR**

Appendix A

Study Intersections in the “BART Extension TIA,” the “BART Extension with TOJD TIA,” and the SEIS/SEIR

Two separate Transportation Impact Analyses (TIAs) have been prepared by Hexagon Transportation Consultants, Inc. for VTA’s BART Silicon Valley – Phase II Extension Project:

- *Transportation Impact Analysis of the BART Extension Only* (“BART Extension TIA”)
- *Transportation Impact Analysis of the BART Extension and VTA’s Transit-Oriented Joint Development* (“BART Extension with TOJD TIA”)

The results of these TIAs have been incorporated into a single Supplemental Environmental Impact Statement/Subsequent Environmental Impact Report (SEIS/SEIR). The SEIS/SEIR identifies three alternatives for analysis:

1. The “No Build” Alternative (for NEPA and CEQA purposes) – which is referred to as the “No Project/Phase I” scenario in the BART Extension TIA and the “No Project” scenario in the BART Extension with TOJD TIA;
2. The BART Extension Alternative (for NEPA and CEQA purposes), which includes the results of the BART Extension TIA;
3. The BART Extension with TOJD Alternative (for CEQA purposes only), which includes the results of the BART Extension with TOJD TIA.

The two TIAs discuss a different number of intersections at different stations. Because the TOJD would generate additional trips, there are more intersections with the potential for 10 additional vehicles per lane per hour under the BART Extension with TOJD Alternative. The following table summarizes the total number of intersections (including CMP intersections) and the number of CMP intersections discussed at each station under each alternative.

**Table A-1
Summary of Intersections under Each Alternative**

Phase II BART Station	No Build Alternative Intersections		BART Extension Alternative Intersections		BART Extension with TOJD Alternative Intersections	
	Total	CMP	Total	CMP	Total	CMP
Alum Rock/28th Street Station	27	7	17	3	27	7
Diridon Station ^a	29	10	29	10	0	0
Santa Clara Station	35	15	17	6	35	15
TOTAL Intersections	91	32	63	19	62	22

Note:
(a) The Diridon Station was not included in the BART Extension with TOJD Alternative because the station is within the Downtown Core Area defined by the "San Jose Downtown Strategy 2000 EIR" and the proposed TOJD is fully consistent with that EIR.

The following three tables present the names of all intersections included in any of the alternatives at the three stations discussed in the SEIS/SEIR. Note that a different numbering system is used for the study intersections in the two TIAs. The intersection numbers used in the BART Extension TIA and in the BART Extension with TOJD TIA are shown for reference. Intersections were referred to only by name – and not by number – in the SEIS/SEIR.

Table A-2
Study Intersections Near the Alum Rock/28th Street Station

Intersection ¹	City	No Build Alternative in SEIS/SEIR	BART Extension Alternative/ Intersection # in BART Extension TIA	BART Ext. with TOJD Alternative/ Intersection # in BART Extension with TOJD TIA
Alum Rock/28th Street Station				
21st Street and E. Julian Street	San Jose	Yes	1	1
24th Street and E. Julian Street	San Jose	Yes	2	2
N. 28th Street and E. Julian Street	San Jose	Yes	3	3
US 101 SB ramps and E. Julian Street	San Jose	Yes	4	4
US 101 NB ramps and McKee Road	San Jose	Yes	5	5
33rd Street and McKee Road	San Jose	Yes		6
King Road and McKee Road	San Jose	Yes	6	7
Jackson Ave and McKee Road	San Jose	Yes		8
17th Street and E Santa Clara Street	San Jose	Yes	7	9
21st Street and E. Santa Clara Street	San Jose	Yes	16	10
24th Street and E. Santa Clara Street	San Jose	Yes	8	11
26th Street and E. Santa Clara Street	San Jose	Yes	17	12
N. 28th Street and E. Santa Clara Street	San Jose	Yes	9	13
US 101 and E. Santa Clara Street *	San Jose	Yes	10	14
US 101 and Alum Rock Avenue *	San Jose	Yes	11	15
33rd Street and Alum Rock Avenue	San Jose	Yes		16
King Road and Alum Rock Avenue*	San Jose	Yes		17
Jackson Ave and Alum Rock Avenue*	San Jose	Yes		18
I-680 South and Alum Rock Ave (West)*	San Jose	Yes		19
I-680 North and Alum Rock Ave (East)*	San Jose	Yes		20
24th Street and San Antonio Street	San Jose	Yes	12	21
King Road and E. San Antonio Street	San Jose	Yes		22
Jackson Ave and San Antonio/Capitol Expwy	San Jose	Yes		23
24th Street and East William Street	San Jose	Yes	13	24
McLaughlin Ave and I-280 SB Ramp *	San Jose	Yes	14	25
McLaughlin Ave and Story Road	San Jose	Yes	15	26
King Road and Mabury Road	San Jose	Yes		27
Notes:				
* Denotes a CMP intersection				
¹ There are 27 study intersections for the "No Build" Alternative and the "BART Extension with TOJD" Alternative. There are 17 study intersections for the "BART Extension" Alternative.				

**Table A-3
Study Intersections Near the Diridon Station**

Intersection ¹	City	No Build Alternative in SEIS/SEIR	BART Extension Alternative/ Intersection # in BART Extension TIA	BART Ext. with TOJD Alternative/ Intersection # in BART Extension with TOJD TIA
Diridon Station				
The Alameda and Taylor St/Naglee Ave*	San Jose	Yes	1	No
Stockton Ave and W. Julian Street	San Jose	Yes	2	No
N. Montgomery St and W. Julian Street	San Jose	Yes	3	No
N. Autumn St. and W. Julian Street	San Jose	Yes	4	No
SR 87 (W) and W. Julian Street*	San Jose	Yes	5	No
SR 87 (E) and W. Julian Street*	San Jose	Yes	6	No
The Alameda and W. Julian Street	San Jose	Yes	7	No
Race Street/Martin Ave and The Alameda*	San Jose	Yes	8	No
Stockton Avenue and The Alameda	San Jose	Yes	9	No
Cahill Street and W. Santa Clara Street	San Jose	Yes	10	No
S. Montgomery St and W Santa Clara St*	San Jose	Yes	11	No
S. Autumn St and W Santa Clara St*	San Jose	Yes	12	No
SR 87 and W Santa Clara St*	San Jose	Yes	13	No
S. Montgomery St and San Fernando St.	San Jose	Yes	14	No
S. Autumn St. and San Fernando St.	San Jose	Yes	15	No
Delmas Ave. and San Fernando St.	San Jose	Yes	16	No
S. Montgomery/Autumn St and Park Ave.	San Jose	Yes	17	No
Delmas Ave. and Park Ave.	San Jose	Yes	18	No
Meridian Ave. and San Carlos Street	San Jose	Yes	19	No
Race Street and San Carlos Street	San Jose	Yes	20	No
Lincoln Ave. and San Carlos Street	San Jose	Yes	21	No
Bird Avenue and San Carlos Street*	San Jose	Yes	22	No
Bird Avenue and Auzerais Avenue	San Jose	Yes	23	No
Meridian Ave. and Parkmoor Ave.	San Jose	Yes	24	No
Lincoln Ave. and Parkmoor Ave.	San Jose	Yes	25	No
Bird Avenue and I-280 (N)*	San Jose	Yes	26	No
Bird Avenue and I-280 (S)*	San Jose	Yes	27	No
Southwest Expressway and Fruitdale Ave	San Jose	Yes	28	No
Meridian Ave and Fruitdale Ave	San Jose	Yes	29	No
Notes:				
* Denotes a CMP intersection				
¹ There are 29 study intersections for the "No Build" Alternative and the "BART Extension" Alternative. The Diridon Station was not analyzed under the "BART Extension with TOJD" Alternative because the station is within the Downtown Core Area defined by the "San Jose Downtown Strategy 2000 EIR" and the proposed TOJD is fully consistent with that EIR.				

Table A-4
Study Intersections Near the Santa Clara Station

Intersection ¹	City	No Build Alternative in SEIS/SEIR	BART Extension Alternative/ Intersection # in BART Extension TIA	BART Ext. with TOJD Alternative/ Intersection # in BART Extension with TOJD TIA
Santa Clara Station				
Scott Blvd and Central Expwy*	Santa Clara	Yes		28
Lafayette and Central Expwy *	Santa Clara	Yes		29
De La Cruz Blvd and Central Expwy *	Santa Clara	Yes	16	30
De La Cruz Blvd and Martin Avenue	Santa Clara	Yes	17	31
De La Cruz Blvd and Reed Street	Santa Clara	Yes	2	32
Coleman Avenue and Brokaw Road	Santa Clara	Yes	11	33
Coleman Avenue and Aviation Avenue	San Jose	Yes	12	34
Coleman Avenue and Newhall Drive	San Jose	Yes	13	35
Coleman Avenue and I-880 SB Ramps*	San Jose	Yes		36
Coleman Avenue and I-880 NB Ramps*	San Jose	Yes		37
Coleman Avenue and W. Hedding St.	San Jose	Yes		38
Coleman Avenue and W. Taylor St	San Jose	Yes		39
SR 87 and W. Taylor Street	San Jose	Yes		40
San Tomas Expwy and El Camino Real*	Santa Clara	Yes	3	41
Scott Blvd and El Camino Real*	Santa Clara	Yes	4	42
Lincoln Street and El Camino Real*	Santa Clara	Yes		43
Monroe Street and El Camino Real*	Santa Clara	Yes	5	44
Lafayette St. and Reed Street	Santa Clara	Yes	1	45
Lafayette St. and El Camino Real*	Santa Clara	Yes	6	46
Lafayette Street and Lewis Street	Santa Clara	Yes	14	47
Lafayette St and Harrison St (unsignalized)	Santa Clara	Yes	15	48
Lafayette St. and Benton Street	Santa Clara	Yes	10	49
Lafayette St. and Homestead Road	Santa Clara	Yes		50
Lafayette St. and Market Street	Santa Clara	Yes		51
El Camino Real and Benton Street	Santa Clara	Yes	7	52
El Camino Real and Railroad Ave.	Santa Clara	Yes	8	53
El Camino Real and The Alameda*	Santa Clara	Yes	9	54
The Alameda and Newhall Dr	San Jose	Yes		55
The Alameda and I-880 (South)*	San Jose	Yes		56
The Alameda and I-880 (North)*	San Jose	Yes		57
The Alameda and W. Hedding Street*	San Jose	Yes		58
The Alameda and W. Taylor St/Naglee Ave*	San Jose	Yes		59
Homestead Rd and Lincoln St/Winchester Blvd	Santa Clara	Yes		60
Homestead Rd and Monroe Street	Santa Clara	Yes		61
U.S. 101 and Trimble Road	San Jose	Yes		62

Notes:
* Denotes a CMP intersection
¹ There are 35 study intersections for the "No Build" Alternative and the "BART Extension with TOJD" Alternative.
There are 17 study intersections for the "BART Extension" Alternative.

Appendix B

Existing Plus Project Traffic Analysis



Memorandum

Date: June 26, 2015
 To: Maggie Townsley, Shilpa Trisal
 From: At van den Hout
 Subject: Existing + VTA's BART Silicon Valley – Phase II Extension Project Conditions Analysis

This memorandum presents the results of the existing plus project conditions scenario conducted as part of the traffic impact analysis (TIA) for the proposed Valley Transportation Authority's (VTA) BART Silicon Valley – Phase II Extension Project. The proposed VTA's BART Silicon Valley – Phase II Extension Project (hereafter referred to as the *Phase II Project*) is the second phase of the BART Silicon Valley Program which would provide for the extension of the Bay Area Rapid Transit (BART) service to the Cities of Milpitas, San Jose, and Santa Clara. The Phase II Project includes four new BART Stations in the Cities of San Jose (three stations) and Santa Clara (one station). Existing conditions represent year 2015 roadway and traffic conditions. This memorandum is a supplement to the TIA completed for the Phase II Project, dated June 15, 2015, by Hexagon.

Existing conditions were calculated using existing (year 2014-2015) traffic counts. At three locations where construction was underway at the time the counts were conducted, 2013 counts were utilized. Under current (Existing) conditions, the BART lines terminate at the Fremont Station. Under Existing + Phase II Project conditions, it is assumed that BART is extended into Santa Clara County with stations at Irvington, Warm Springs, Milpitas, Berryessa, Alum Rock, Downtown San Jose, Diridon and Santa Clara. Under Existing conditions, BART operates with two lines, both at 15 minute headways: The Fremont to Richmond line and the Fremont to Daly City line. Under Existing + Phase II Project conditions, these BART lines would be extended to the City of Santa Clara and operate at 15 minute headways between the Santa Clara and Richmond Stations and between the Santa Clara and Daly City Stations.

Traffic volumes for Existing + Phase II Project conditions were obtained by adding to the existing counts, Park-and-Ride (PNR) and Kiss-and-Ride (KNR) traffic that would be generated by the aforementioned BART Stations, if the Phase II Project were in operation today.

Significance Criteria

Significance criteria are used to establish what constitutes an impact. For this analysis there are seven criteria by which intersection and freeway impacts are determined. Impacts of the project are typically based on traffic conditions with the proposed project compared to traffic conditions without the proposed project. Therefore, impacts of the project are based on year 2015 with the Phase II Project conditions compared to 2015 without the project (i.e. Existing) conditions. Project impacts will be determined based on the Cities of San Jose and Santa Clara, and the VTA CMP criteria for impacts on intersections. The City of San Jose level of service standard for signalized intersections is LOS D or better. The City of Santa Clara level of service standard is LOS D or better at all city-controlled intersections and LOS E or better at all expressway intersections. The CMP level of service standard for signalized intersections is LOS E or better.

It should be noted that for the purpose of this analysis, local City of San Jose and City of Santa Clara study intersections were analyzed based on their corresponding level of service standards, while the CMP study intersections were analyzed following the CMP level of service standards.

The project is said to create a significant impact under the Existing plus Phase II Project conditions if for either peak hour:



1. The level of service at a local intersection degrades from an acceptable LOS D or better under Existing conditions to an unacceptable LOS E or F under Existing plus Phase II Project conditions (City of San Jose Criteria).
2. The level of service at a local intersection is an unacceptable LOS E or F under Existing conditions and the addition of net project traffic causes both the critical-movement delay at the intersection to increase by four or more seconds and the critical demand-to-capacity ratio (V/C) to increase by .01 or more under Existing plus Phase II Project conditions.

An exception to this rule applies when the addition of station traffic reduces the amount of average control delay for critical movements (i.e. the change in average control delay for critical movements is negative). In this case, the threshold of significance is an increase in the critical V/C value by 0.01 or more (City of San Jose Criteria).

3. The level of service at a local intersection degrades from an acceptable level (LOS D or better at all city-controlled intersections and LOS E or better at all expressway intersections) under Existing conditions to an unacceptable level (LOS E or F at city-controlled intersections and LOS F at expressway intersections) under Existing plus Phase II Project conditions (City of Santa Clara Criteria).
4. The level of service at a local intersection is an unacceptable level (LOS E or F at city-controlled intersections and LOS F at expressway intersections) under Existing conditions and the addition of net project traffic causes both the average critical delay at the intersection to increase by four or more seconds *and* the volume-to-capacity ratio (V/C) to increase by 0.01 or more under Existing plus Phase II Project conditions.

An exception to this rule applies when the addition of station traffic reduces the amount of average delay for critical movements (i.e., the change in average control delay for critical movements is negative). In this case, the threshold of significance is an increase in the critical V/C value by 0.01 or more (City of Santa Clara Criteria).

5. The level of service at a CMP designated intersection degrades from an acceptable LOS E or better under Existing conditions to an unacceptable LOS F under Existing plus Phase II Project conditions (VTA Criteria).
6. The level of service at a CMP designated intersection is an unacceptable LOS F under Existing conditions and the addition of net project traffic causes both the critical-movement delay at the intersection to increase by four or more seconds and the critical demand-to-capacity ratio (V/C) to increase by .01 or more under Existing plus Phase II Project conditions.

An exception to this rule applies when the addition of station traffic reduces the amount of average control delay for critical movements (i.e. the change in average control delay for critical movements is negative). In this case, the threshold of significance is an increase in the critical V/C value by .01 or more (VTA Criteria).

7. The level of service on a freeway segment is an unacceptable LOS F under Existing conditions, and the amount of net project traffic on that segment constitutes at least one percent of capacity on that segment (VTA Criteria).

A significant impact is considered substantially mitigated when Existing plus Phase II Project Mitigated conditions intersection operations are compared against Existing conditions and no significant adverse impact criteria are triggered

Station Trip Generation

Trip generation for the proposed stations was estimated based on daily transit ridership projections by mode of access, which includes PNR and KNR person trips, forecasted by the VTA's 2012 PD Phase II, December 2014 Travel Forecasting Model, hereafter referred to as the VTA Model. The PNR and KNR daily person trips were converted to auto access trips to BART by applying an average vehicle occupancy rate of 1.1 persons/vehicle for PNR trips and 2.1 persons/vehicle for KNR trips. The 2.1 persons per vehicle for KNR

include the driver and 1.1 transit riders that are dropped off or picked up at the transit station. Peak-hour factors were then applied to the daily trips to obtain drive access (PNR and KNR) trips for the AM and PM peak-hours. The PNR auto trips were then assigned to the BART Station parking lots and the KNR trips were assigned to the BART drop-off areas of the BART Stations.

Table A-1 presents the daily and peak hour trip generation estimates for each of the drive access modes to the Alum Rock, Diridon and Santa Clara Stations.

Table A-1
Station Trip Generation Estimate: Existing Plus Phase II Project

Mode of Access by Station	Parking Demand (# of Spaces)	Daily Trips	AM Peak Hour Trips			PM Peak Hour Trips		
			In	Out	Total	In	Out	Total
Alum Rock Station:								
Kiss and Ride Trips		218	21	21	42	25	25	50
Park and Ride Trips	650	1,430	192	7	199	18	150	168
Total		1,648	213	28	241	43	175	218
Diridon Station:								
Kiss and Ride Trips		235	23	23	46	27	27	54
Park and Ride Trips	0	0	0	0	0	0	0	0
Total		235	23	23	46	27	27	54
Santa Clara Station:								
Kiss and Ride Trips		70	7	7	14	8	8	16
Park and Ride Trips	125	275	37	1	38	3	29	32
Total		345	44	8	52	11	37	48
Source: VTA Model, December 2014.								

Alum Rock Station

Model projections of passenger volumes for the Alum Rock Station indicate that 1,430 daily PNR trips would access/egress the station under Existing plus Phase II Project conditions. The maximum parking demand at the Alum Rock Station under Existing plus Phase II Project conditions would be 650 spaces. A total of 199 (192 inbound and 7 outbound) and 168 (18 inbound and 150 outbound) PNR trips are estimated to occur during the AM and PM peak hours, respectively. The Alum Rock Station would generate 218 daily KNR trips under Existing plus Phase II Project conditions. A total of 42 (21 inbound and 21 outbound) and 50 (25 inbound and 25 outbound) KNR trips are estimated to occur during the AM and PM peak hours, respectively.

Diridon Station

No PNR facilities would be provided at the Diridon Station. Model projections indicate that the Diridon Station would generate 235 daily KNR trips under Existing plus Phase II Project conditions. A total of 46 (23 inbound and 23 outbound) and 54 (27 inbound and 27 outbound) KNR trips are estimated to occur during the AM and PM peak hours, respectively.

Santa Clara

Model projections of passenger volumes for the Santa Clara Station indicate that 275 daily PNR trips would access/egress the station under Existing plus Phase II Project conditions. The maximum parking demand at the Santa Clara Station under Existing plus Phase II Project conditions would be 125 spaces. A total of 38 (37

inbound and 1 outbound) and 32 (3 inbound and 29 outbound) PNR trips are estimated to occur during the AM and PM peak hours, respectively. The Santa Clara Station would generate 70 daily KNR trips under Existing plus Phase II Project conditions. A total of 14 (7 inbound and 7 outbound) and 16 (8 inbound and 8 outbound) KNR trips are estimated to occur during the AM and PM peak hours, respectively.

It should be noted that, with implementation of the Phase II Project, shifts in travel modes would occur resulting from commuters that currently drive to work but would switch to BART under Phase II Project conditions. As a result, traffic in the immediate vicinity of the future BART stations would likely *increase* because of the PNR and KNR trips. However, traffic on regional arterials and freeways is expected to *decrease* because commuters would shift from auto to BART, removing vehicle trips from these roadways and intersections. The PNR and KNR vehicle trips generated by the BART Stations are shown in Table A-1. These trips were assigned to the roadway network and added to the intersection counts and freeway segment volumes. The “mode shift” from auto to BART was forecasted with the VTA Model and the resulting decrease in auto trips was subtracted from the intersection counts and freeway, this way estimating Existing plus Phase II Project conditions volumes.

Intersection Operations

Tables A-2, A-3 and A-4 present the level of service results for the Existing and Existing plus Phase II Project conditions scenarios at the study intersections near the Alum Rock, Diridon, and Santa Clara BART Stations, respectively. The level of service results indicate that under existing conditions, all intersections near the Alum Rock and Diridon BART stations currently operate at acceptable levels of service (LOS D or better). These intersections would continue to operate at LOS D or better with the implementation of the Phase II Project. Note that traffic conditions at most intersections would improve with implementation of the Phase II Project because auto commuters would shift to BART, thereby reducing the number of vehicles on the road.

All but three intersections near the Santa Clara BART station currently operate at acceptable LOS D (or LOS E at CMP intersections) and would continue to operate at acceptable conditions with the implementation of the Phase II Project. The following study intersections currently operate at unacceptable levels of service (the CMP intersections are denoted by an asterisk (*)):

- (11) Coleman Avenue and Brokaw Road (LOS F – PM peak hour)
- (15) Lafayette Street and Harrison Street (LOS E – AM peak hour, LOS F – PM peak hour)
- (16) De La Cruz Boulevard and Central Expressway * (LOS F – AM and PM peak hours)

Under Existing plus Phase II Project conditions, these intersections would continue to operate at an unacceptable level of service. However, based on City of Santa Clara and the CMP level of service impact criteria, the proposed project would not have a negative impact at any of the study intersections in the vicinity of the Santa Clara Station under Existing plus Phase II Project conditions.

Figures A-1 through A-9 show the existing traffic, the net Phase II Project trips, and the Existing plus Phase II Project conditions volumes at the intersections near the Alum Rock Station, the Diridon Station, and the Santa Clara Station.

Freeway Operations

Existing plus Phase II Project conditions traffic volumes on freeway segments were established by adding to the existing freeway volumes the projected net station trips on freeway segments. Note that the project would generally result in a decrease in traffic volumes on the freeway network, as commuters use the Phase II Project as alternative to regional freeway travel. While a portion of traffic accessing the station areas would use the freeway network to do so, generally those trips are already on the freeway network and do not represent an increase in traffic from existing conditions.

Table A-5, A-6 and A-7, present the Existing plus Phase II Project conditions at the freeway segments near the Alum Rock, Diridon, and Santa Clara stations, respectively.

The results show that:

- 13 (plus four HOV segments) of the 20 directional freeway segments analyzed for the Alum Rock Station would operate at an unacceptable LOS F during at least one peak hour under Existing plus Phase II Project conditions.
- 16 (plus five HOV segments) of the 18 directional freeway segments analyzed for the Diridon Station would operate at an unacceptable LOS F during at least one peak hour under Existing plus Phase II Project conditions
- 24 (plus nine HOV segments) of 26 directional freeway segments analyzed for the Santa Clara Station would operate at an unacceptable LOS F during at least one peak hour under Existing plus Phase II Project conditions.

Since the project would not add traffic representing one percent or more of the segment's capacity to any of the study freeway segments projected to operate at LOS F, none of the freeway segments analyzed would be impacted by the project under the Existing plus Phase II Project conditions, according to county CMP level of service standards for freeways.

Table A-2
Alum Rock Station Intersection Level of Service Summary
Existing and Existing + Phase II Project Conditions

Study Number	Intersection	Peak Hour	Existing		Existing Plus Phase II Project			
			Avg. Delay	LOS	Avg. Delay	LOS	Incr. In Crit. Delay	Incr. In Crit. V/C
1	21st Street and East Julian Street	AM	20.9	C	19.6	B	-1.3	-0.012
		PM	12.2	B	12.2	B	-0.1	-0.007
2	24th Street and East Julian Street	AM	17.2	B	16.7	B	-1.0	0.000
		PM	17.1	B	16.6	B	-0.4	-0.008
3	North 28th Street and East Julian Street	AM	27.2	C	27.6	C	0.2	-0.011
		PM	14.2	B	15.7	B	0.4	-0.005
4	US 101 and East Julian Street	AM	23.1	C	23.0	C	-0.2	-0.002
		PM	26.8	C	27.3	C	0.2	0.008
5	US 101 and McKee Road	AM	22.1	C	22.7	C	0.6	0.001
		PM	26.9	C	27.0	C	0.0	-0.003
6	King Road and McKee Road	AM	46.8	D	46.7	D	-0.3	-0.009
		PM	47.2	D	47.3	D	0.0	0.000
7	17th Street and East Santa Clara Street	AM	6.5	A	6.5	A	0.1	-0.008
		PM	9.3	A	9.4	A	0.1	-0.004
8	24th Street and East Santa Clara Street	AM	19.5	B	19.5	B	-0.2	-0.010
		PM	21.1	C	21.3	C	0.3	0.004
9	North 28th Street and East Santa Clara Street	AM	20.9	C	21.8	C	1.8	0.039
		PM	18.4	B	19.0	B	0.3	0.003
10	US 101 and East Santa Clara Street*	AM	11.5	B	11.2	B	0.0	-0.001
		PM	16.2	B	16.2	B	0.5	0.047
11	US 101 and Alum Rock Avenue*	AM	11.0	B	11.9	B	0.8	0.018
		PM	15.9	B	15.9	B	0.0	-0.001
12	24th Street and San Antonio Street	AM	16.0	B	16.1	B	0.1	0.016
		PM	12.6	B	12.5	B	0.0	0.003
13	24th Street and East William Street	AM	15.8	B	15.6	B	-0.2	0.018
		PM	19.4	B	19.3	B	-0.1	0.005
14	McLaughlin Avenue and I-280 SB*	AM	9.5	A	9.8	A	0.4	0.011
		PM	14.5	B	14.5	B	0.0	0.001
15	McLaughlin Avenue and Story Road	AM	42.4	D	42.6	D	0.2	0.004
		PM	48.5	D	48.5	D	-0.1	-0.002
16	21st Street and East Santa Clara Street	AM	5.7	A	5.8	A	0.2	-0.008
		PM	4.6	A	4.6	A	0.0	-0.004
17	26th Street and East Santa Clara Street	AM	16.5	B	16.9	B	0.1	-0.003
		PM	14.4	B	14.4	B	0.0	0.001

* Denotes CMP Intersection

Table A-3
Diridon Station Intersection Level of Service Summary
Existing and Existing + Phase II Project Conditions

Study Number	Intersection	Peak Hour	Existing		Existing Plus Phase II Project			
			Avg. Delay	LOS	Avg. Delay	LOS	Incr. In Crit. Delay	Incr. In Crit. V/C
1	The Alameda and Taylor Street/Naglee Avenue*	AM	45.6	D	45.4	D	-0.4	-0.009
		PM	43.4	D	43.3	D	0.1	-0.001
2	Stockton Avenue and West Julian Street	AM	33.8	C	33.7	C	-0.2	-0.005
		PM	33.7	C	33.6	C	-0.1	-0.003
3	North Montgomery Street and West Julian Street	AM	11.8	B	11.8	B	0.0	-0.002
		PM	11.8	B	11.8	B	0.0	-0.002
4	North Autumn Street and West Julian Street	AM	13.2	B	13.2	B	0.0	-0.001
		PM	13.1	B	13.1	B	-0.1	-0.002
5	SR 87 (W) and West Julian Street*	AM	20.8	C	20.7	C	0.2	-0.011
		PM	18.8	B	18.6	B	-0.1	-0.005
6	SR 87 (E) and West Julian Street*	AM	53.8	D	53.5	D	-0.1	-0.004
		PM	42.3	D	42.1	D	-0.3	-0.009
7	The Alameda and West Julian Street	AM	19.0	B	19.0	B	-0.1	-0.004
		PM	20.2	C	20.0	C	-0.1	-0.003
8	Race Street/Martin Avenue and The Alameda*	AM	37.2	D	37.2	D	0.0	-0.001
		PM	33.0	C	33.0	C	0.0	-0.001
9	Stockton Avenue and The Alameda	AM	24.2	C	24.1	C	-0.2	-0.004
		PM	29.5	C	29.5	C	-0.1	-0.004
10	Cahill Street and West Santa Clara Street	AM	17.0	B	17.4	B	0.4	-0.001
		PM	18.2	B	18.8	B	0.8	0.006
11	South Montgomery Street and West Santa Clara Street*	AM	6.2	A	6.2	A	0.0	-0.002
		PM	9.0	A	9.0	A	0.0	-0.003
12	South Autumn Street and West Santa Clara Street*	AM	25.7	C	25.7	C	-0.1	-0.005
		PM	21.2	C	21.1	C	-0.2	0.001
13	SR 87 and West Santa Clara Street*	AM	17.9	B	17.9	B	0.0	-0.007
		PM	17.1	B	17.1	B	0.0	-0.003
14	South Montgomery Street and San Fernando Street	AM	9.1	A	8.9	A	-0.1	0.010
		PM	10.4	B	10.6	B	0.4	0.009
15	South Autumn Street and San Fernando Street	AM	6.7	A	6.8	A	0.1	0.005
		PM	10.1	B	10.0	A	-0.2	0.004
16	Delmas Avenue and San Fernando Street	AM	5.9	A	5.4	A	-0.5	0.003
		PM	10.2	B	10.1	B	-0.1	-0.002
17	South Montgomery Street/Autumn Street and Park Avenue	AM	32.0	C	32.0	C	0.2	0.001
		PM	38.3	D	38.3	D	-0.1	0.001
18	Delmas Avenue and Park Avenue	AM	23.5	C	23.6	C	0.1	0.000
		PM	25.1	C	25.1	C	0.0	0.000
19	Meridian Avenue and San Carlos Street	AM	38.2	D	38.2	D	0.0	-0.001
		PM	47.5	D	47.5	D	0.0	0.000
20	Race Street and San Carlos Street	AM	36.2	D	36.1	D	0.0	-0.003
		PM	36.7	D	36.7	D	0.0	0.000
21	Lincoln Avenue and San Carlos Street	AM	34.5	C	34.5	C	0.0	0.000
		PM	39.8	D	39.8	D	-0.1	0.000
22	Bird Avenue and San Carlos Street*	AM	33.1	C	33.3	C	0.2	0.003
		PM	39.6	D	39.6	D	-0.1	0.001
23	Bird Avenue and Auzerais Avenue	AM	22.1	C	22.1	C	0.0	0.000
		PM	26.8	C	26.8	C	0.0	0.001
24	Meridian Avenue and Parkmoor Avenue	AM	32.2	C	32.2	C	0.0	0.000
		PM	36.1	D	36.1	D	0.0	0.000
25	Lincoln Avenue and Parkmoor Avenue	AM	24.3	C	24.3	C	0.0	0.000
		PM	35.3	D	35.3	D	0.0	0.000
26	Bird Avenue and I-280 (N)*	AM	29.6	C	29.4	C	0.3	0.002
		PM	24.4	C	24.2	C	0.1	0.004
27	Bird Avenue and I-280 (S)*	AM	27.4	C	27.4	C	0.1	0.001
		PM	22.8	C	22.8	C	-0.1	-0.005
28	Southwest Expressway and Fruitdale Avenue	AM	28.7	C	28.7	C	0.0	-0.001
		PM	32.1	C	32.0	C	0.0	0.002
29	Meridian Avenue and Fruitdale Avenue	AM	45.8	D	45.8	D	0.0	0.000
		PM	50.4	D	50.4	D	0.1	0.000

* Denotes CMP Intersection

Table A-4
Santa Clara Station Intersection Level of Service Summary
Existing and Existing + Phase II Project Conditions

Study Number	Intersection	Peak Hour	Existing		Existing Plus Phase II Project			
			Avg. Delay ¹	LOS	Avg. Delay ¹	LOS	Incr. In Crit. Delay	Incr. In Crit. V/C
1	Lafayette Street and Reed Street	AM	6.8	A	6.8	A	0.0	-0.001
		PM	7.4	A	7.4	A	0.0	0.000
2	De La Cruz Boulevard and Reed Street	AM	11.1	B	11.2	B	0.1	-0.002
		PM	18.1	B	18.0	B	-0.1	-0.003
3	San Tomas Expressway and El Camino Real *	AM	66.1	E	66.1	E	0.0	0.000
		PM	79.7	E	79.5	E	-0.2	-0.001
4	Scott Boulevard and El Camino Real *	AM	33.8	C	33.8	C	0.0	-0.001
		PM	37.7	D	37.7	D	0.1	0.001
5	Monroe Street and El Camino Real *	AM	35.5	D	35.6	D	0.1	0.001
		PM	32.9	C	32.9	C	0.0	0.000
6	Lafayette Street and El Camino Real *	AM	40.8	D	40.7	D	-0.1	-0.001
		PM	41.3	D	41.3	D	0.0	0.000
7	El Camino Real and Benton Street	AM	12.8	B	12.8	B	0.1	0.003
		PM	15.4	B	15.4	B	-0.1	-0.001
8	El Camino Real and Railroad Avenue	AM	10.5	B	10.4	B	0.0	0.000
		PM	12.4	B	12.4	B	-0.1	-0.002
9	El Camino Real and The Alameda *	AM	13.0	B	12.9	B	-0.1	-0.008
		PM	17.2	B	17.2	B	-0.1	-0.007
10	Lafayette Street and Benton Street	AM	17.1	B	17.1	B	0.0	0.002
		PM	15.7	B	15.7	B	0.0	0.002
11	Coleman Avenue and Brokaw Road	AM	17.0	B	16.9	B	0.0	-0.003
		PM	88.0	F	86.3	F	-2.2	-0.006
12	Coleman Avenue and Aviation Avenue	AM	14.6	B	14.3	B	-0.5	-0.005
		PM	7.2	A	7.2	A	0.0	-0.003
13	Coleman Avenue and Newhall Drive	AM	15.8	B	15.8	B	0.0	-0.003
		PM	24.1	C	24.1	C	-0.1	-0.004
14	Lafayette Street and Lewis Street	AM	10.7	B	10.7	B	-0.1	0.000
		PM	44.9	D	45.4	D	0.8	0.002
15	Lafayette Street and Harrison Street (unsignalized)	AM	48.9	E	49.1	E	--	--
		PM	176.9	F	178.7	F	--	--
16	De La Cruz Boulevard and Central Expressway *	AM	270.6	F	269.5	F	-2.3	-0.005
		PM	95.8	F	95.2	F	-0.7	-0.002
17	De La Cruz Boulevard and Martin Avenue	AM	34.9	C	34.9	C	0.0	-0.002
		PM	30.7	C	30.6	C	-0.1	-0.002

* Denotes CMP Intersection

Entries denoted in **bold** indicate conditions that exceed the applicable level of service standard.

¹The reported delay and corresponding level of service for signalized intersections represents the average delay for all approaches at the intersection. The reported delay and corresponding level of service for unsignalized (two-way stop-controlled) intersections are based on the stop-controlled approach with the highest delay.

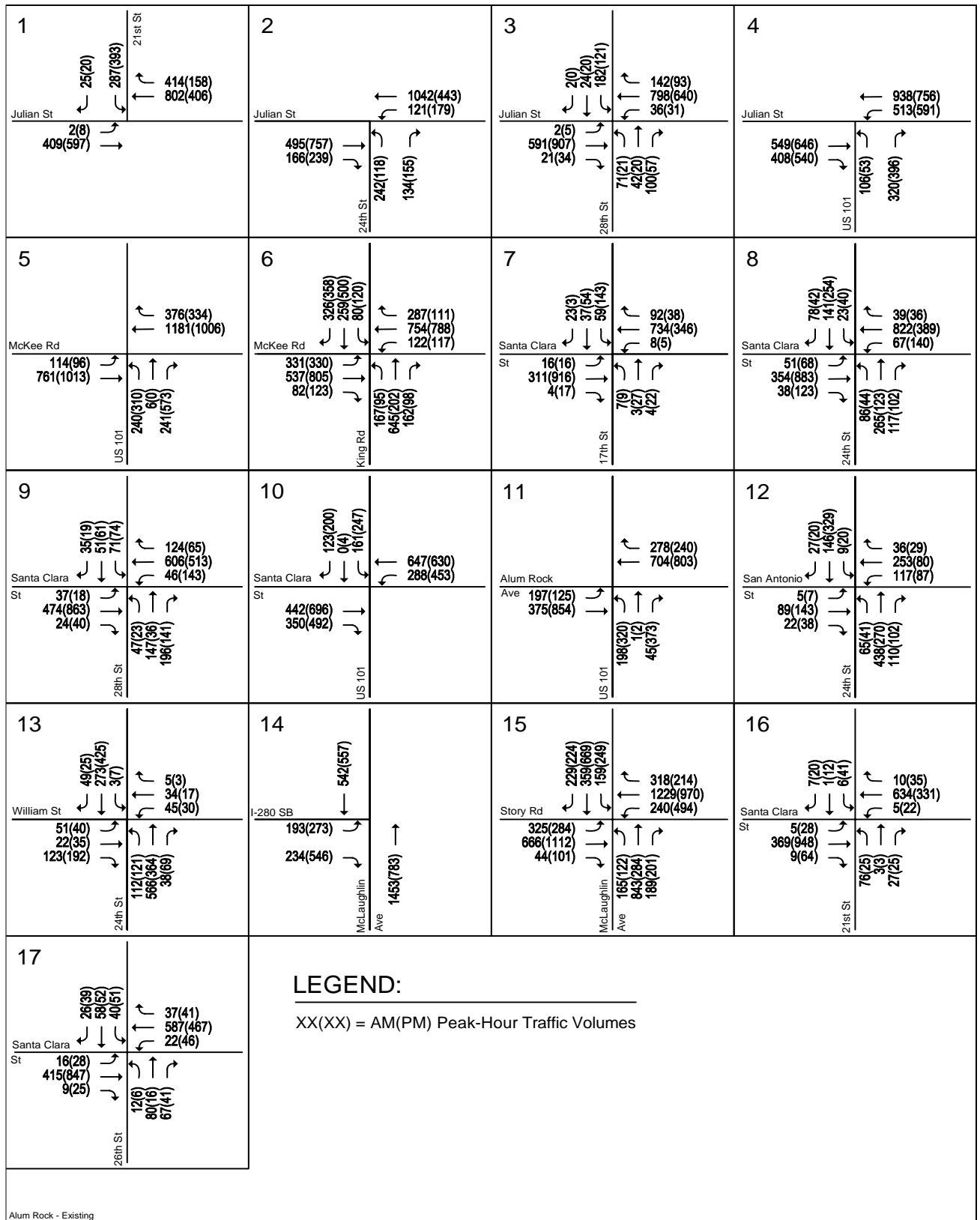

Figure A-1:
 Alum Rock Station Existing 2015 Conditions

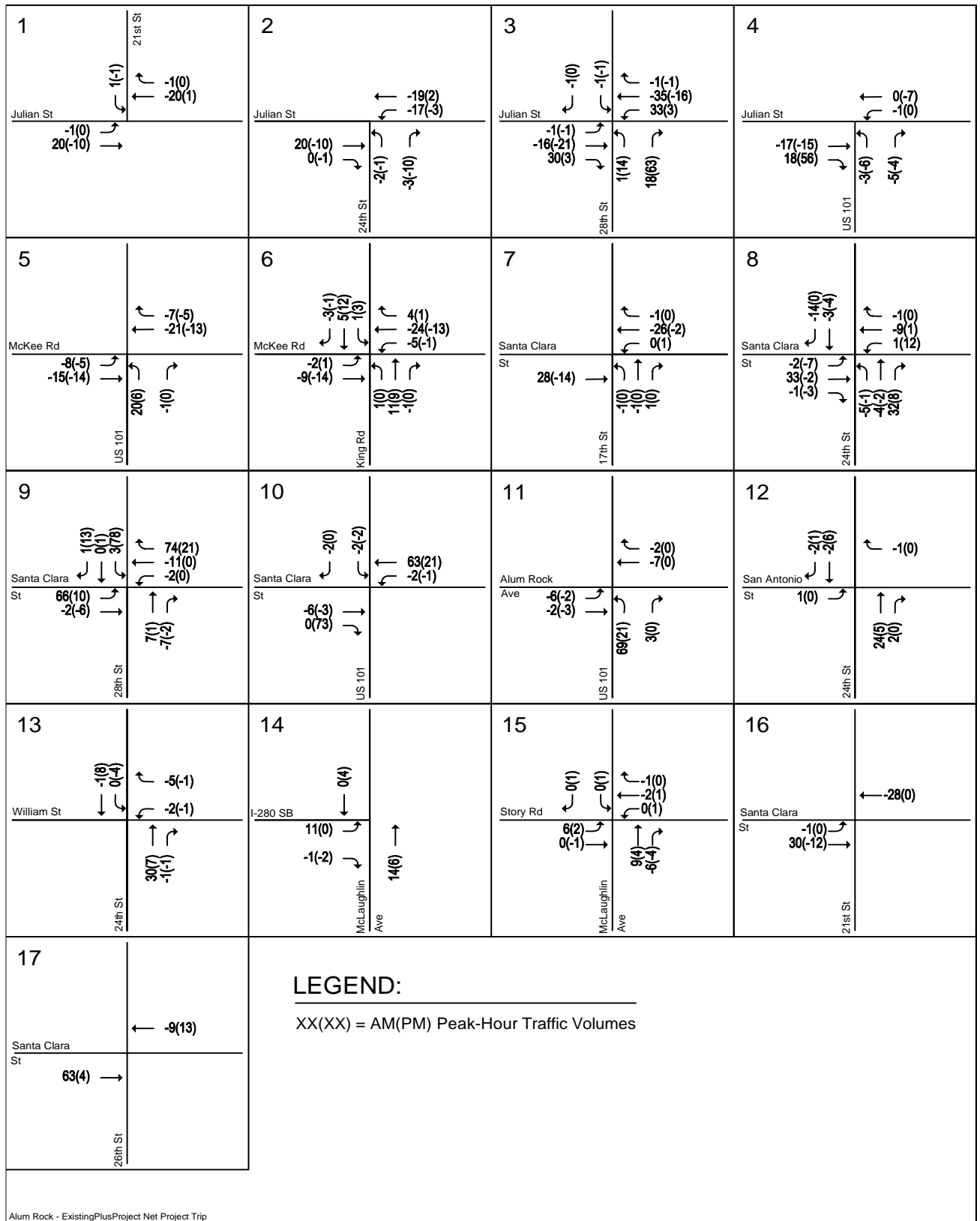

Figure A-2
Alum Rock Station Net Project Trips for Existing Plus Phase II Project Conditions

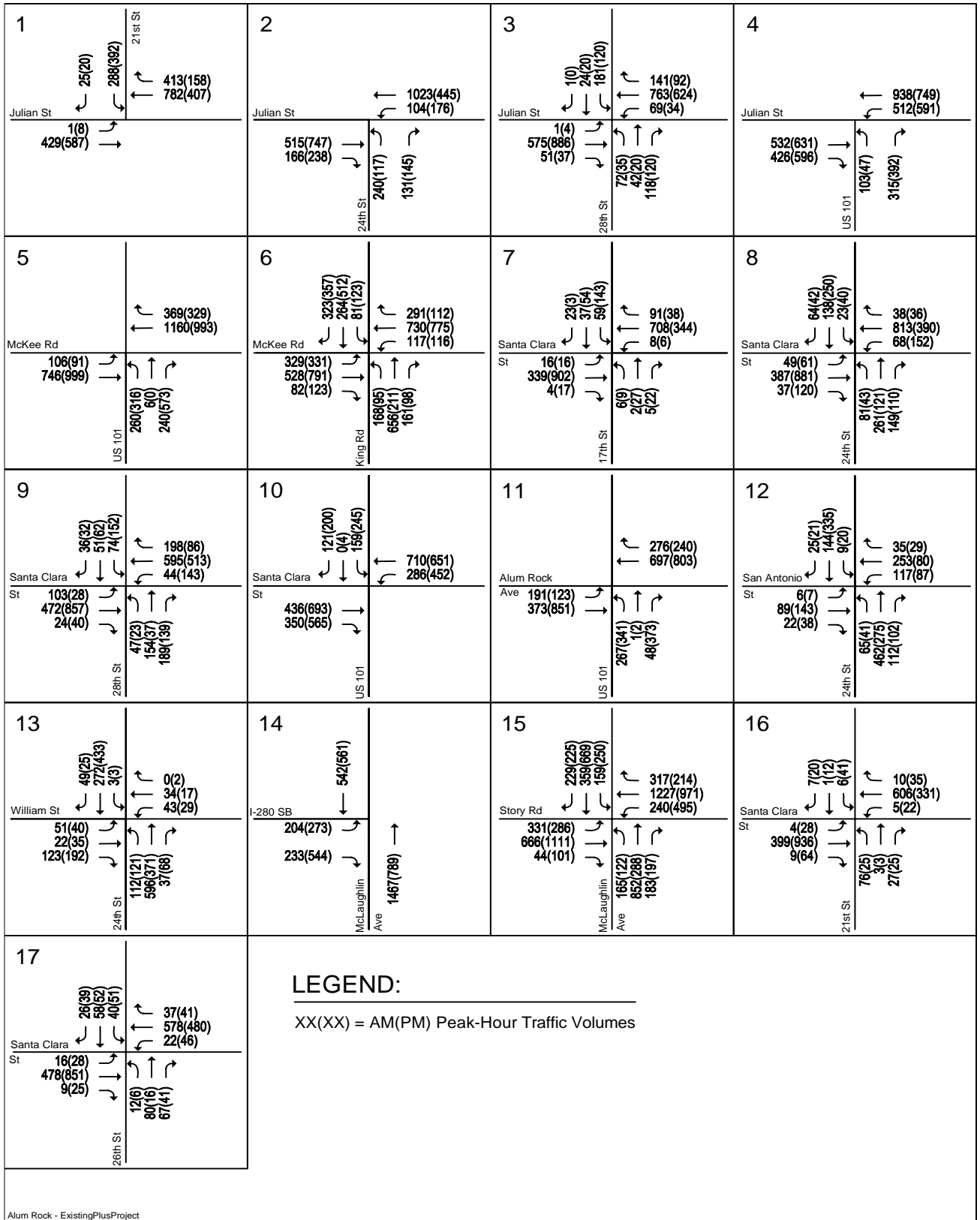
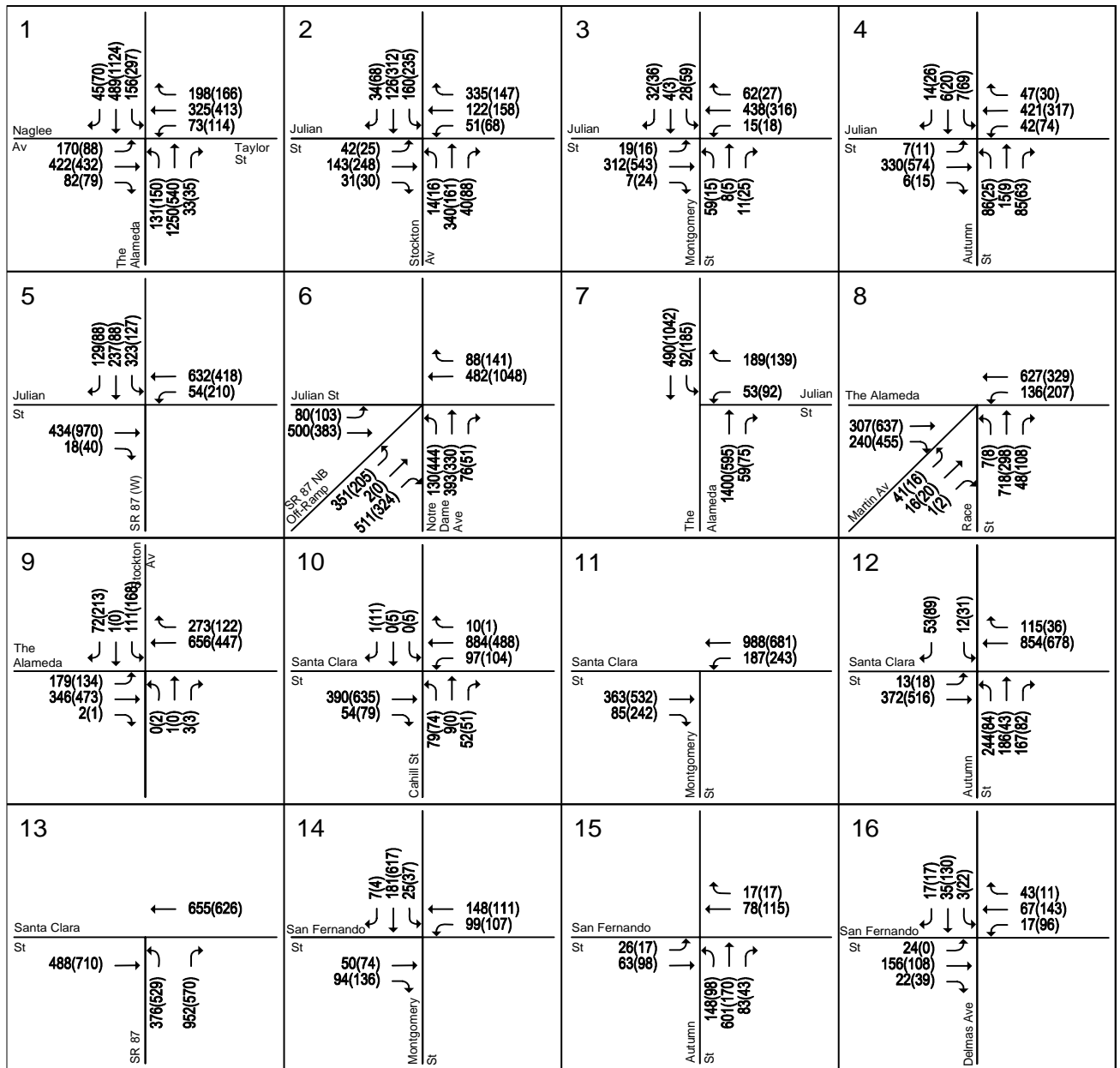

Figure A-3
 Alum Rock Station Existing Plus Phase II Project Conditions



LEGEND:

XX(XX) = AM(PM) Peak-Hour Traffic Volumes

Diridon - Existing

Figure A-4
Diridon Station Existing 2015 Conditions

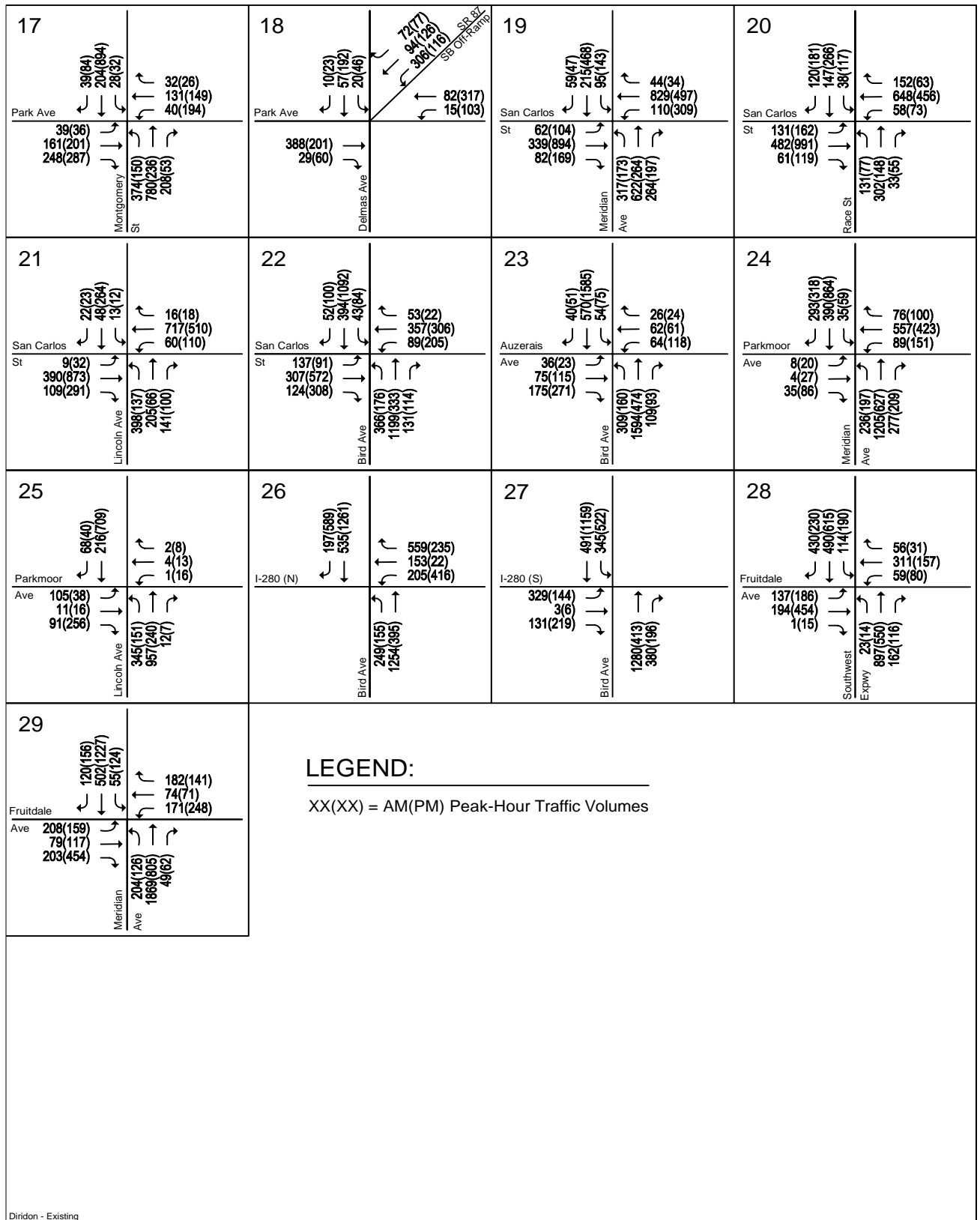
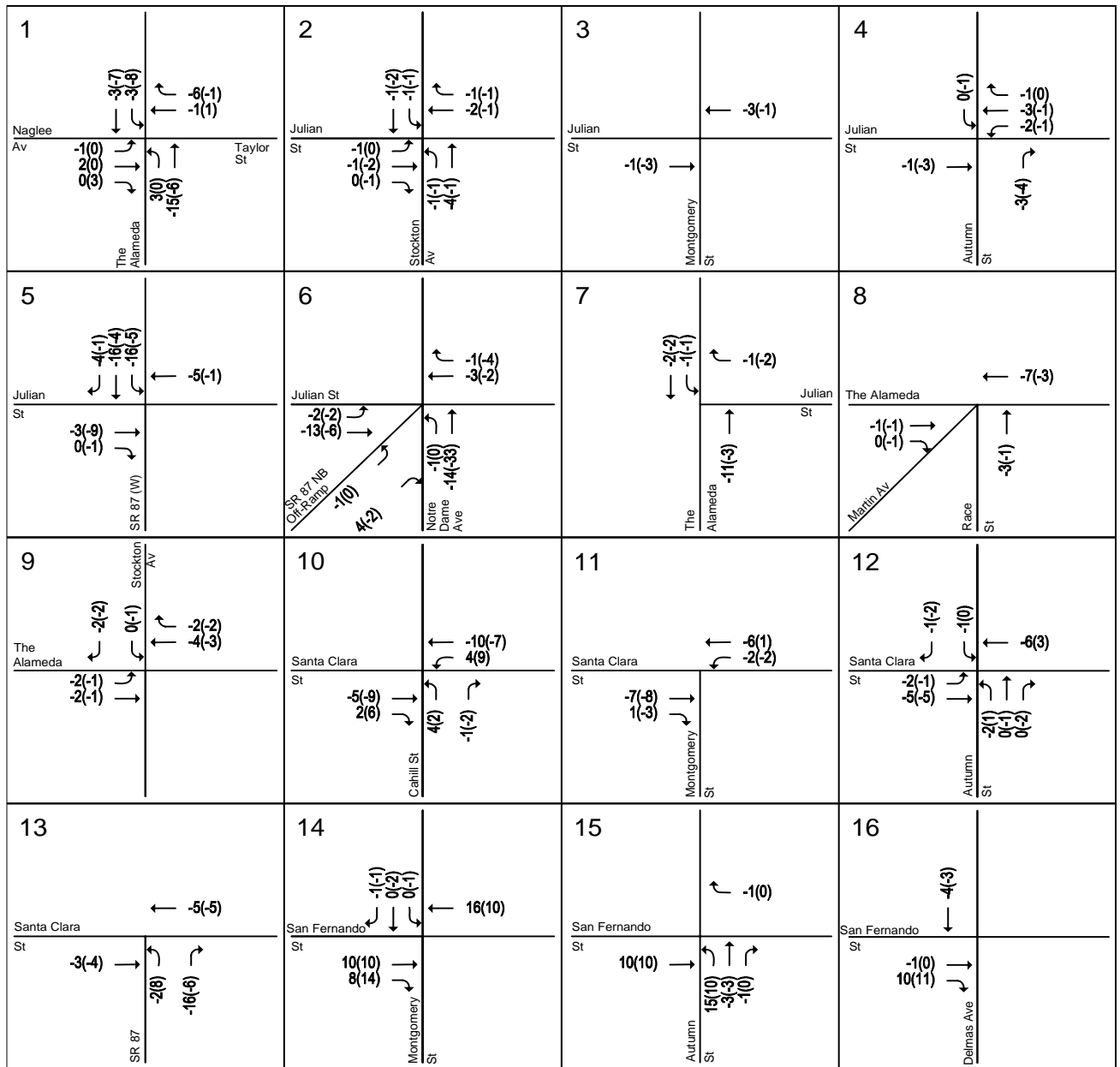

Figure A-4 (Continued)
 Diridon Station Existing 2015 Conditions



LEGEND:

XX(XY) = AM(PM) Peak-Hour Traffic Volumes

Diridon - ExistingPlusProject Net Project Trip

Figure A-5
Diridon Station Net Project Trips for Existing Plus Phase II Project Conditions

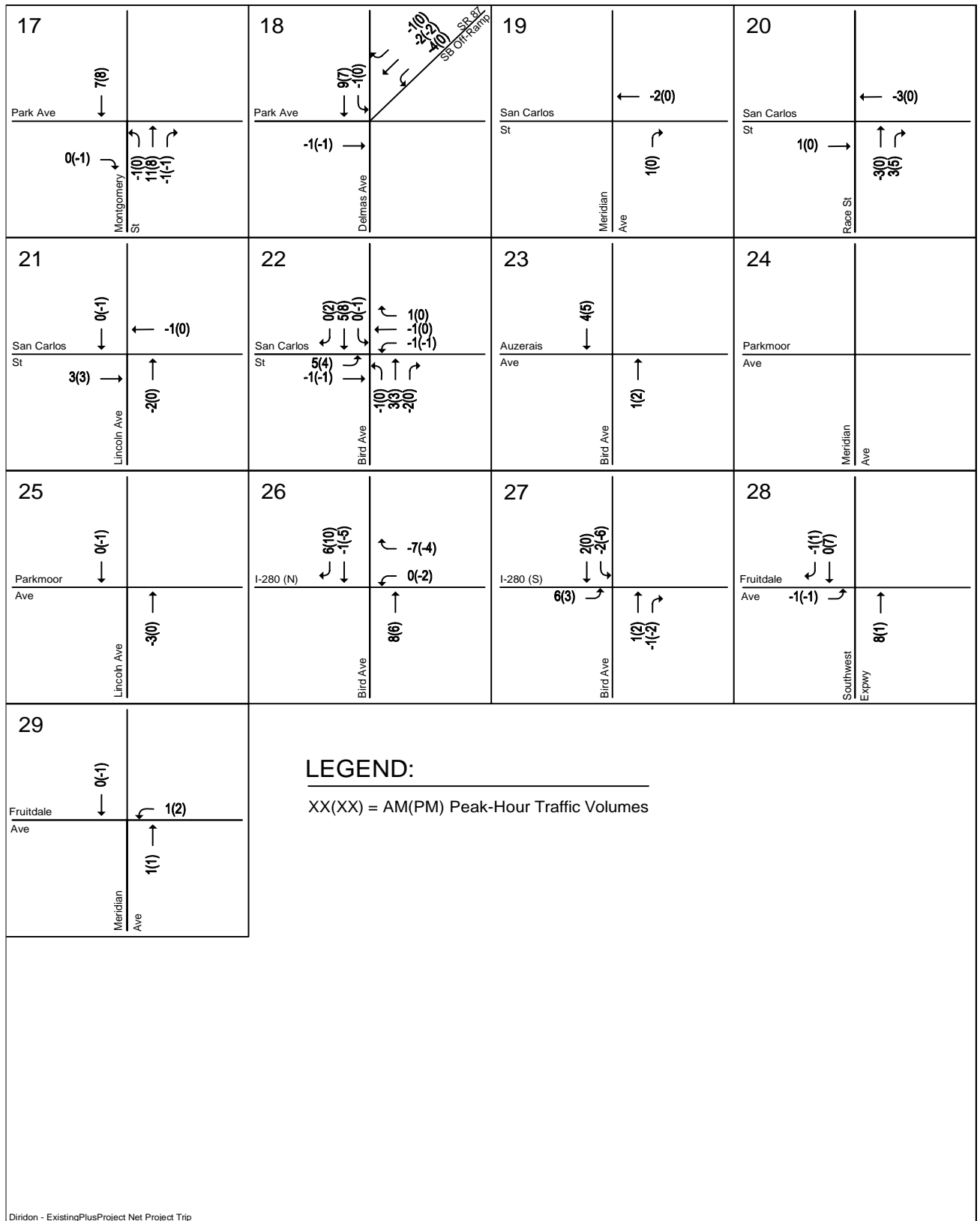

FigureA-5 (Continued)
Diridon Station Net Project Trips for Existing Plus Phase II Project Conditions

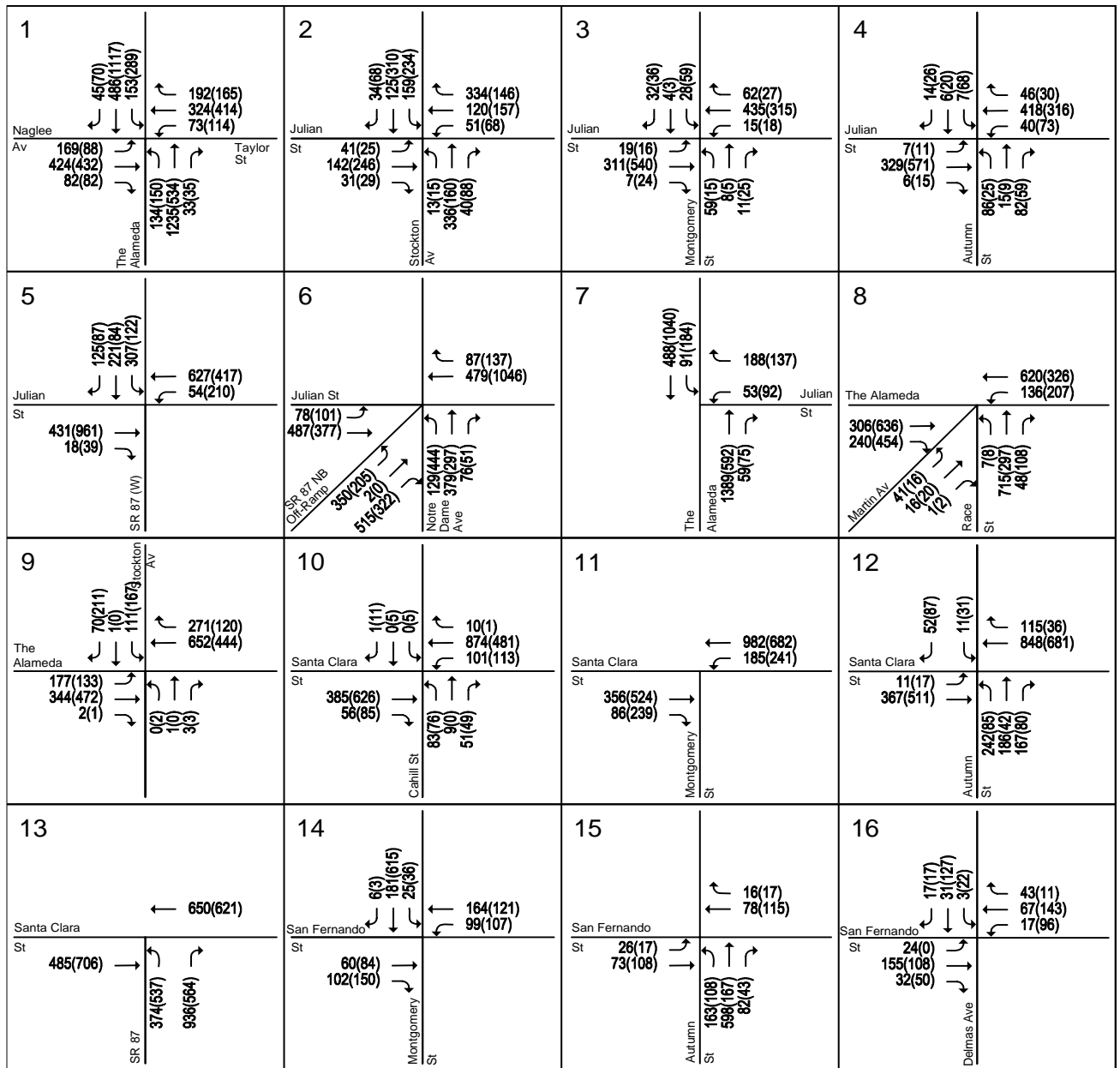

LEGEND:

XX(XX) = AM(PM) Peak-Hour Traffic Volumes

Diridon - ExistingPlusProject

Figure A-6
Diridon Station Existing Plus Phase II Project Conditions

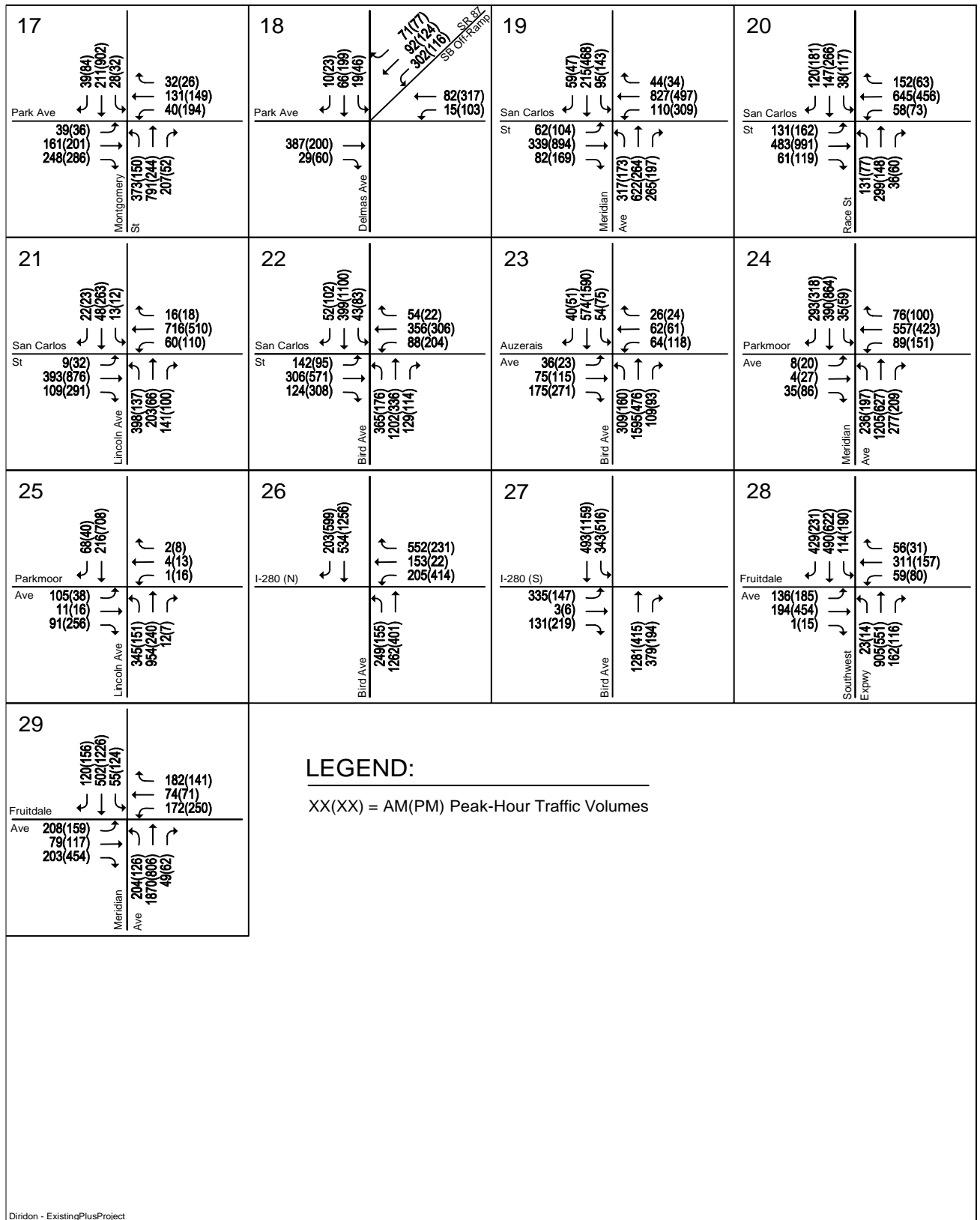

Figure A-6 (Continued)
 Diridon Station Existing Plus Phase II Project Conditions

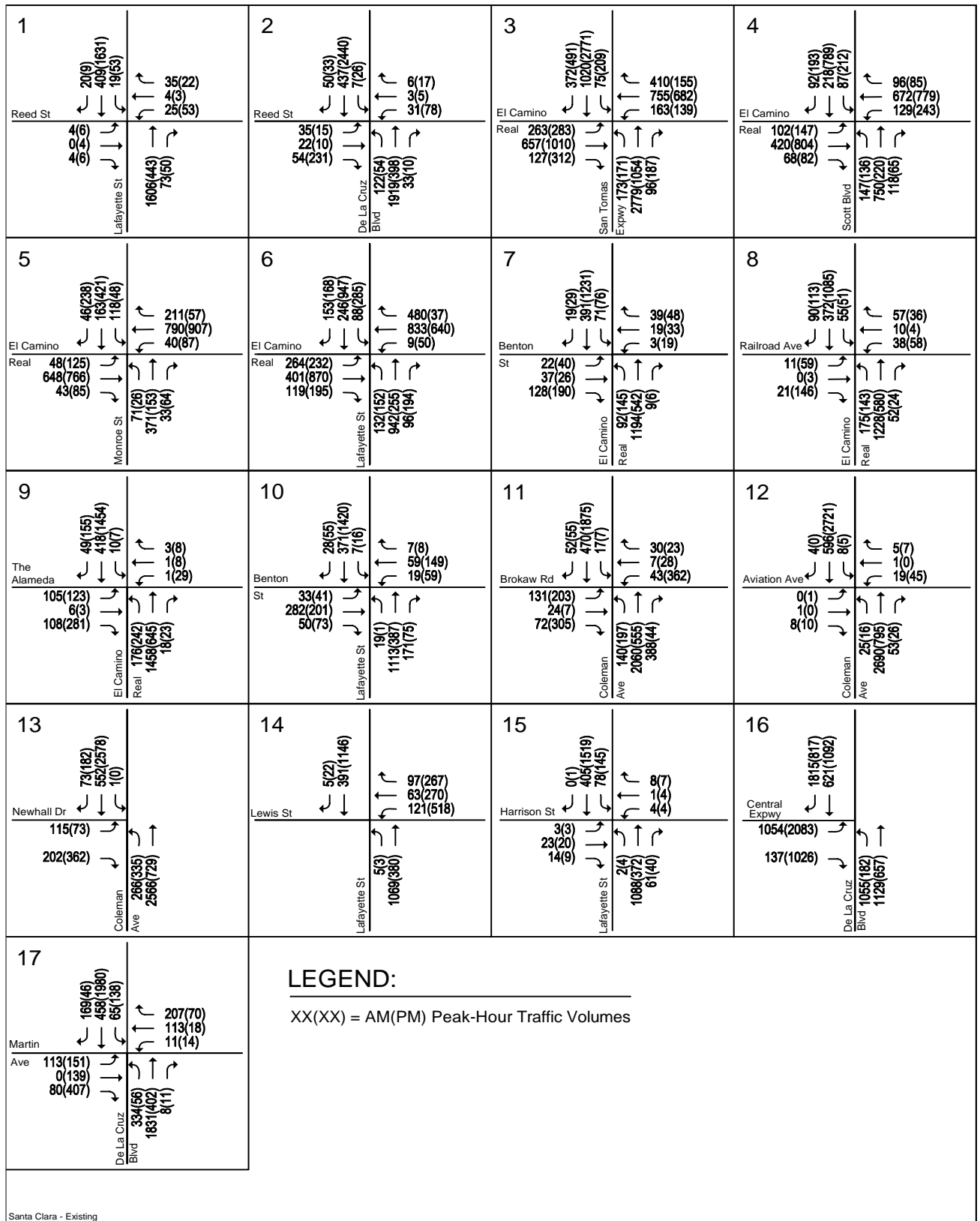
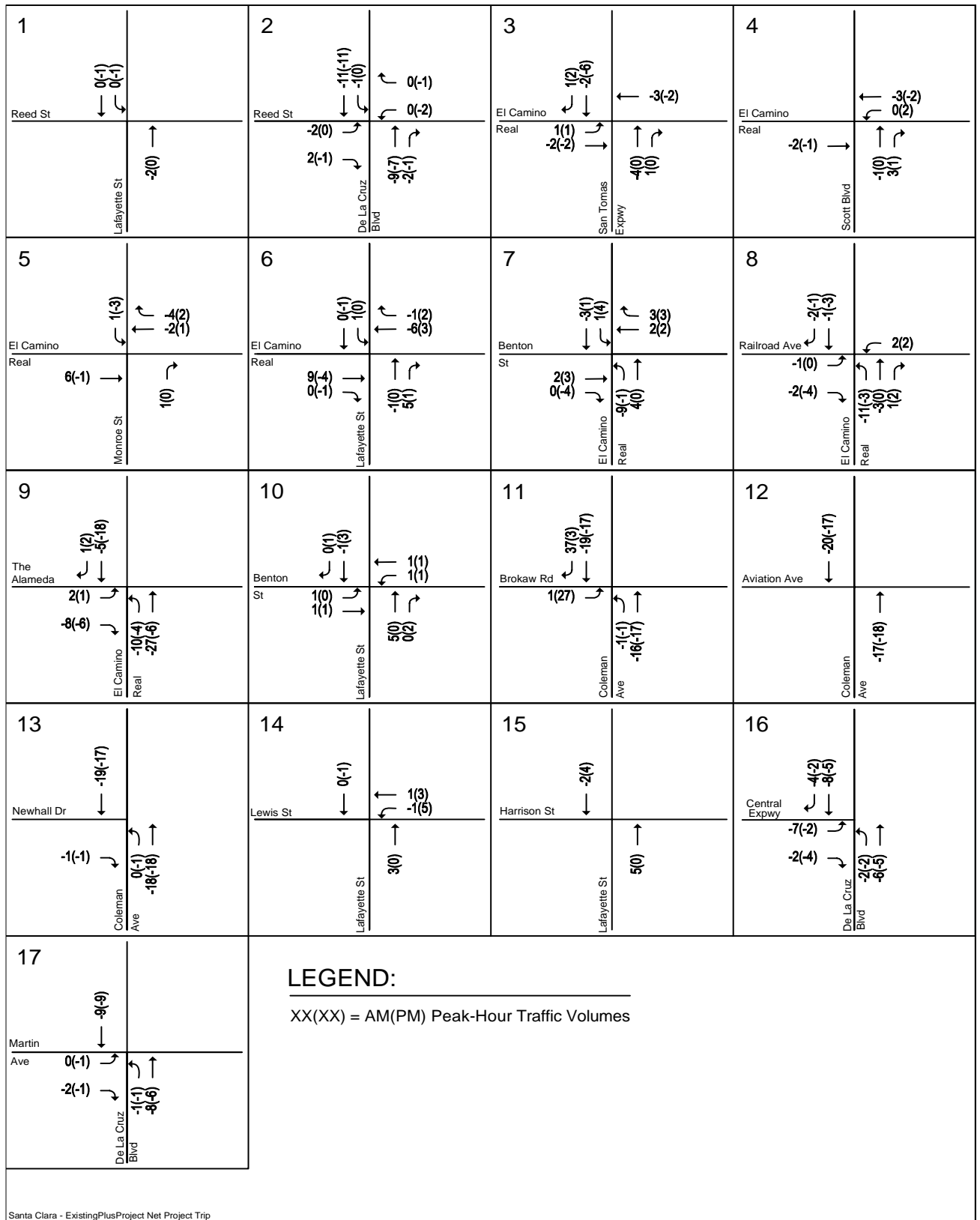
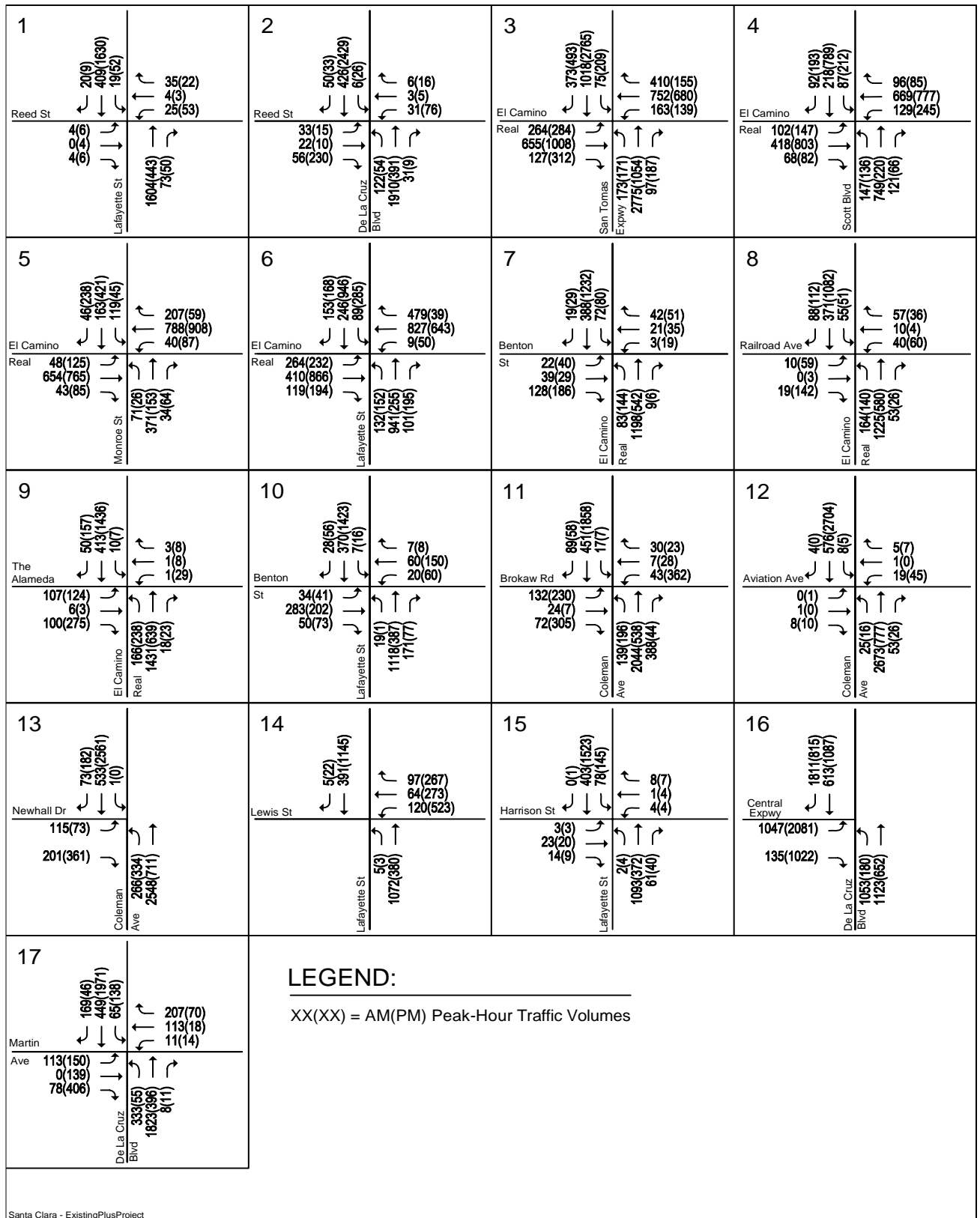

Figure A-7
 Santa Clara Station Existing 2015 Conditions



Santa Clara - ExistingPlusProject Net Project Trip

Figure A-8
 Santa Clara Station Net Project Trips for Existing Plus Phase II Project Conditions



Santa Clara - ExistingPlusProject

Figure A-9
Santa Clara Station Existing Plus Phase II Project Conditions

**Table A-5
Alum Rock Station Existing Plus Phase II Project Freeway Levels of Service**

Freeway Segment	Direction	Peak Hour	Existing Plus Project												Net Project Trips			
			Mixed-Flow Lane						HOV Lane						Mixed-Flow Lane		HOV Lane	
			Avg. Speed	# of Lanes	Capacity	Volume	Density	LOS	Avg. Speed	# of Lanes	Capacity	Volume	Density	LOS	Volume	% of Capacity	Volume	% of Capacity
US 101 Tully to Story	NB	AM	25.0	3.0	6,900	5,419	72	F	15.0	1.0	1,650	1,425	95	F	19	0.28%	-5	-0.30%
		PM	66.0	3.0	6,900	4,959	25	C	70.0	1.0	1,650	910	13	B	9	0.13%	0	0.00%
US 101 Story to I-280	NB	AM	22.0	3.0	6,900	5,277	80	F	19.0	1.0	1,650	1,637	86	F	57	0.83%	-3	-0.18%
		PM	67.0	3.0	6,900	3,018	15	B	70.0	1.0	1,650	350	5	A	18	0.26%	0	0.00%
US 101 I-280 to Santa Clara	NB	AM	13.0	3.0	6,900	4,086	105	F	13.0	1.0	1,650	1,324	102	F	66	0.96%	-6	-0.36%
		PM	66.0	3.0	6,900	4,575	23	C	70.0	1.0	1,650	700	10	A	15	0.22%	0	0.00%
US 101 Santa Clara to McKee	NB	AM	11.0	3.0	6,900	3,697	112	F	16.0	1.0	1,650	1,465	92	F	-3	-0.04%	-15	-0.91%
		PM	66.0	3.0	6,900	3,958	20	C	70.0	1.0	1,650	1,047	15	B	-2	-0.03%	-3	-0.18%
I-280 10th to McLaughlin	EB	AM	66.0	4.0	9,200	4,978	19	C	---	---	---	---	---	---	-42	-0.46%	---	---
		PM	54.0	4.0	9,200	8,804	41	D	---	---	---	---	---	---	-56	-0.61%	---	---
I-280 McLaughlin to US 101	EB	AM	66.0	4.0	9,200	5,758	22	C	---	---	---	---	---	---	-52	-0.57%	---	---
		PM	54.0	4.0	9,200	8,809	41	D	---	---	---	---	---	---	-51	-0.55%	---	---
I-680 US 101 to King	NB	AM	33.0	4.0	9,200	7,866	60	F	---	---	---	---	---	---	-54	-0.59%	---	---
		PM	66.0	4.0	9,200	7,030	27	D	---	---	---	---	---	---	-50	-0.54%	---	---
I-680 King to Capitol	NB	AM	20.0	4.0	9,200	6,450	81	F	---	---	---	---	---	---	-110	-1.20%	---	---
		PM	47.0	4.0	9,200	8,592	46	D	---	---	---	---	---	---	-58	-0.63%	---	---
I-680 Capitol to Alum Rock	NB	AM	18.0	4.0	9,200	6,133	85	F	---	---	---	---	---	---	-137	-1.49%	---	---
		PM	65.0	4.0	9,200	7,726	30	D	---	---	---	---	---	---	-74	-0.80%	---	---
I-680 Alum Rock to McKee	NB	AM	27.0	4.0	9,200	7,190	67	F	---	---	---	---	---	---	-160	-1.74%	---	---
		PM	66.0	4.0	9,200	5,730	22	C	---	---	---	---	---	---	-80	-0.87%	---	---
I-680 McKee to Alum Rock	SB	AM	63.0	4.0	9,200	8,477	34	D	---	---	---	---	---	---	-93	-1.01%	---	---
		PM	47.0	4.0	9,200	8,492	45	D	---	---	---	---	---	---	-158	-1.72%	---	---
I-680 Alum Rock to Capitol	SB	AM	23.0	4.0	9,200	7,016	76	F	---	---	---	---	---	---	-74	-0.80%	---	---
		PM	65.0	4.0	9,200	7,431	29	D	---	---	---	---	---	---	-109	-1.18%	---	---
I-680 Capitol to King	SB	AM	21.0	4.0	9,200	7,415	89	F	---	---	---	---	---	---	-75	-0.82%	---	---
		PM	66.0	4.0	9,200	7,680	30	D	---	---	---	---	---	---	-110	-1.20%	---	---
I-680 King to US 101	SB	AM	12.0	4.0	9,200	5,077	106	F	---	---	---	---	---	---	-63	-0.68%	---	---
		PM	66.0	4.0	9,200	5,500	21	C	---	---	---	---	---	---	-50	-0.54%	---	---
I-280 US 101 to McLaughlin	WB	AM	14.0	4.0	9,200	5,597	100	F	---	---	---	---	---	---	-63	-0.68%	---	---
		PM	66.0	4.0	9,200	6,290	24	C	---	---	---	---	---	---	-50	-0.54%	---	---
I-280 McLaughlin to 10th	WB	AM	19.0	4.0	9,200	6,315	83	F	---	---	---	---	---	---	-75	-0.82%	---	---
		PM	65.0	4.0	9,200	7,530	29	D	---	---	---	---	---	---	-10	-0.11%	---	---
US 101 McKee to Santa Clara	SB	AM	67.0	3.0	6,900	2,808	14	B	67.0	1.0	1,650	807	12	B	8	0.12%	-3	-0.18%
		PM	62.0	3.0	6,900	6,557	35	D	70.0	1.0	1,650	1,393	20	C	47	0.68%	-7	-0.42%
US 101 Santa Clara to I-280	SB	AM	67.0	3.0	6,900	3,608	18	B	67.0	1.0	1,650	267	4	A	8	0.12%	-3	-0.18%
		PM	63.0	3.0	6,900	6,539	35	D	70.0	1.0	1,650	1,964	28	D	109	1.58%	4	0.24%
US 101 I-280 to Story	SB	AM	67.0	3.0	6,900	3,213	16	B	67.0	1.0	1,650	467	7	A	13	0.19%	-3	-0.18%
		PM	54.0	3.0	6,900	6,706	41	D	70.0	1.0	1,650	1,477	21	C	56	0.81%	7	0.42%
US 101 Story to Tully	SB	AM	66.0	3.0	6,900	3,958	20	C	67.0	1.0	1,650	467	7	A	-2	-0.03%	-3	-0.18%
		PM	45.0	3.0	6,900	6,497	48	E	70.0	1.0	1,650	1,824	26	C	17	0.25%	4	0.24%

Source: Santa Clara Valley Transportation Authority Congestion Management Program Monitoring Study, 2014.
Bold indicates unacceptable LOS.

**Table A-6
Diridon Station Existing Plus Phase II Project Freeway Levels of Service**

Freeway Segment	Direction	Peak Hour	Existing Plus Phase II Project											Net Project Trips				
			Mixed-Flow Lane						HOV Lane					Mixed-Flow Lane		HOV Lane		
			Avg. Speed	# of Lanes	Capacity	Volume	Density	LOS	Avg. Speed	# of Lanes	Capacity	Volume	Density	LOS	Volume	% of Capacity	Volume	% of Capacity
SR 87 Curtner to Almaden Expressway	NB	AM	13.0	2.0	4,400	2,657	102	F	22.0	1.0	1,650	1,719	78	F	-3	-0.07%	-1	-0.06%
		PM	65.0	2.0	4,400	3,902	30	D	70.0	1.0	1,650	1,190	17	B	2	0.05%	0	0.00%
SR 87 Almaden Expressway to Alma	NB	AM	29.0	2.0	4,400	3,767	65	F	43.0	1.0	1,650	2,109	49	E	-3	-0.07%	-1	-0.06%
		PM	41.0	2.0	4,400	4,193	51	E	70.0	1.0	1,650	1,540	22	C	3	0.07%	0	0.00%
SR 87 Alma to I-280	NB	AM	33.0	2.0	4,400	3,957	60	F	61.0	1.0	1,650	2,198	36	D	-3	-0.07%	-2	-0.12%
		PM	66.0	2.0	4,400	3,443	26	C	70.0	1.0	1,650	420	6	A	3	0.07%	0	0.00%
SR 87 I-280 to Julian	NB	AM	16.0	2.0	4,400	2,976	93	F	30.0	1.0	1,650	1,913	64	F	-4	-0.09%	-7	-0.42%
		PM	67.0	2.0	4,400	2,397	18	B	70.0	1.0	1,650	628	9	A	-3	-0.07%	-2	-0.12%
SR 87 Julian to Coleman	NB	AM	14.0	2.0	4,400	2,786	100	F	32.0	1.0	1,650	1,942	61	F	-14	-0.32%	-18	-1.09%
		PM	67.0	2.0	4,400	2,097	16	B	70.0	1.0	1,650	466	7	A	-33	-0.75%	-24	-1.45%
I-280 I-880 to Meridian	EB	AM	66.0	3.0	6,900	5,135	26	C	67.0	1.0	1,650	669	18	B	-15	-0.22%	-1	-0.06%
		PM	17.0	3.0	6,900	4,579	90	F	20.0	1.0	1,650	1,739	30	F	-11	-0.16%	-1	-0.06%
I-280 Meridian to Bird	EB	AM	61.0	4.0	9,200	8,785	36	D	---	---	---	---	---	---	-5	-0.05%	---	---
		PM	21.0	4.0	9,200	6,795	81	F	---	---	---	---	---	---	-15	-0.16%	---	---
I-280 Bird to SR 87	EB	AM	66.0	4.0	9,200	5,275	20	C	---	---	---	---	---	---	-5	-0.05%	---	---
		PM	25.0	4.0	9,200	7,188	72	F	---	---	---	---	---	---	-12	-0.13%	---	---
I-280 SR 87 to 10th	EB	AM	67.0	4.0	9,200	4,520	17	B	---	---	---	---	---	---	-10	-0.11%	---	---
		PM	27.0	4.0	9,200	7,439	69	F	---	---	---	---	---	---	-21	-0.23%	---	---
I-280 10th to SR 87	WB	AM	21.0	4.0	9,200	6,669	79	F	---	---	---	---	---	---	-51	-0.55%	---	---
		PM	65.0	4.0	9,200	7,782	30	D	---	---	---	---	---	---	-18	-0.20%	---	---
I-280 SR 87 to Bird	WB	AM	20.0	4.0	9,200	6,621	83	F	---	---	---	---	---	---	-19	-0.21%	---	---
		PM	62.0	4.0	9,200	8,670	35	D	---	---	---	---	---	---	-10	-0.11%	---	---
I-280 Bird to Meridian	WB	AM	18.0	4.0	9,200	6,391	89	F	---	---	---	---	---	---	-19	-0.21%	---	---
		PM	58.0	4.0	9,200	8,820	38	D	---	---	---	---	---	---	0	0.00%	---	---
I-280 Meridian to I-880	WB	AM	14.0	3.0	6,900	4,748	100	F	26.0	1.0	1,650	1,816	70	F	-12	-0.17%	-4	-0.24%
		PM	66.0	3.0	6,900	4,710	21	C	70.0	1.0	1,650	1,331	19	C	-10	-0.14%	1	0.06%
SR 87 Coleman to Julian	SB	AM	66.0	2.0	4,400	3,514	27	D	67.0	1.0	1,650	654	10	A	-26	-0.59%	-16	-0.97%
		PM	32.0	2.0	4,400	3,901	61	F	50.0	1.0	1,650	2,189	44	D	-9	-0.20%	-11	-0.67%
SR 87 Julian to I-280	SB	AM	67.0	2.0	4,400	1,863	14	B	67.0	1.0	1,650	403	6	A	-7	-0.16%	-7	-0.42%
		PM	36.0	2.0	4,400	4,035	56	E	70.0	1.0	1,650	2,022	29	D	-5	-0.11%	-8	-0.48%
SR 87 I-280 to Alma	SB	AM	67.0	2.0	4,400	1,877	14	B	67.0	1.0	1,650	207	3	A	7	0.16%	-3	-0.18%
		PM	15.0	2.0	4,400	3,899	95	F	60.0	1.0	1,650	1,194	41	D	-1	-0.02%	4	0.24%
SR 87 Alma to Almaden Expressway	SB	AM	66.0	2.0	4,400	2,915	22	C	67.0	1.0	1,650	606	9	A	5	0.11%	-4	-0.24%
		PM	27.0	2.0	4,400	3,037	69	F	60.0	1.0	1,650	844	38	D	-3	-0.07%	4	0.24%
SR 87 Almaden Expressway to Curtner	SB	AM	66.0	2.0	4,400	2,643	20	C	67.0	1.0	1,650	407	6	A	3	0.07%	-3	-0.18%
		PM	36.0	2.0	4,400	4,040	56	E	70.0	1.0	1,650	1,965	28	D	0	0.00%	5	0.30%

Source: Santa Clara Valley Transportation Authority Congestion Management Program Monitoring Study, 2014.
Bold indicates unacceptable LOS.

**Table A-7
Santa Clara Station Existing Plus Phase II Project Freeway Levels of Service**

Freeway Segment	Direction	Peak Hour	Existing Plus Phase II Project												Net Project Trips			
			Mixed-Flow Lane							HOV Lane					Mixed-Flow Lane		HOV Lane	
			Avg. Speed	# of Lanes	Capacity	Volume	Density	LOS	Avg. Speed	# of Lanes	Capacity	Volume	Density	LOS	Volume	Capacity	% of	Volume
US 101 I-880 to Old Bayshore	NB	AM	14.0	3.0	6,900	4,193	100	F	19.0	1.0	1,650	1,591	84	F	-7	-0.10%	-9	-0.55%
		PM	67.0	3.0	6,900	3,598	18	B	70.0	1.0	1,650	417	6	A	-2	-0.03%	-3	-0.18%
US 101 Old Bayshore to First	NB	AM	12.0	3.0	6,900	3,921	109	F	13.0	1.0	1,650	1,351	104	F	-9	-0.13%	-9	-0.55%
		PM	66.0	3.0	6,900	3,954	20	C	70.0	1.0	1,650	557	8	A	-6	-0.09%	-3	-0.18%
US 101 First to SR 87	NB	AM	19.0	3.0	6,900	4,837	85	F	19.0	1.0	1,650	1,591	84	F	-13	-0.19%	-9	-0.55%
		PM	67.0	3.0	6,900	3,392	17	B	70.0	1.0	1,650	627	9	A	-8	-0.12%	-3	-0.18%
US 101 SR 87 to De La Cruz	NB	AM	12.0	3.0	6,900	3,842	107	F	14.0	1.0	1,650	1,392	99	F	-18	-0.26%	-8	-0.48%
		PM	66.0	3.0	6,900	4,147	21	C	70.0	1.0	1,650	417	6	A	-13	-0.19%	-3	-0.18%
US 101 De La Cruz to Montague	NB	AM	26.0	3.0	6,900	5,448	70	F	39.0	1.0	1,650	2,054	53	E	-12	-0.17%	-16	-0.97%
		PM	65.0	3.0	6,900	6,042	31	D	70.0	1.0	1,650	971	14	B	-8	-0.12%	-9	-0.55%
US 101 Montague to Great America	NB	AM	21.0	3.0	6,900	5,099	81	F	41.0	1.0	1,650	2,086	51	E	-11	-0.16%	-14	-0.85%
		PM	58.0	3.0	6,900	6,618	38	D	70.0	1.0	1,650	1,811	26	C	-2	-0.03%	-9	-0.55%
I-880 I-280 to Stevens Creek	NB	AM	15.0	3.0	6,900	4,364	97	F	---	---	---	---	---	---	-6	-0.09%	---	---
		PM	66.0	3.0	6,900	4,152	21	C	---	---	---	---	---	---	-8	-0.12%	---	---
I-880 Stevens Creek to Bascom	NB	AM	20.0	3.0	6,900	4,907	82	F	---	---	---	---	---	---	-13	-0.19%	---	---
		PM	16.0	3.0	6,900	4,408	92	F	---	---	---	---	---	---	-12	-0.17%	---	---
I-880 Bascom to The Alameda	NB	AM	27.0	3.0	6,900	5,571	69	F	---	---	---	---	---	---	-19	-0.28%	---	---
		PM	13.0	3.0	6,900	4,045	104	F	---	---	---	---	---	---	-15	-0.22%	---	---
I-880 The Alameda to Coleman	NB	AM	31.0	3.0	6,900	5,816	63	F	---	---	---	---	---	---	-44	-0.64%	---	---
		PM	15.0	3.0	6,900	4,287	95	F	---	---	---	---	---	---	-33	-0.48%	---	---
I-880 Coleman to SR 87	NB	AM	22.0	3.0	6,900	5,105	77	F	---	---	---	---	---	---	-45	-0.65%	---	---
		PM	24.0	3.0	6,900	5,289	73	F	---	---	---	---	---	---	-41	-0.59%	---	---
I-880 SR 87 to First	NB	AM	48.0	3.0	6,900	6,435	45	D	---	---	---	---	---	---	-45	-0.65%	---	---
		PM	22.0	3.0	6,900	5,179	78	F	---	---	---	---	---	---	-41	-0.59%	---	---
I-880 First to US 101	NB	AM	36.0	3.0	6,900	6,106	57	E	---	---	---	---	---	---	-54	-0.78%	---	---
		PM	51.0	3.0	6,900	6,519	43	D	---	---	---	---	---	---	-61	-0.88%	---	---

Source: Santa Clara Valley Transportation Authority Congestion Management Program Monitoring Study, 2014.
Bold indicates unacceptable LOS.

Table A-7 (Continued)
Santa Clara Station Existing Plus Phase II Project Freeway Levels of Service

Freeway Segment	Direction	Peak Hour	Existing Plus Phase II Project												Net Project Trips			
			Mixed-Flow Lane						HOV Lane						Mixed-Flow Lane		HOV Lane	
			Avg. Speed	# of Lanes	Capacity	Volume	Density	LOS	Avg. Speed	# of Lanes	Capacity	Volume	Density	LOS	Volume	Capacity	% of	Volume
I-880 US 101 to First	SB	AM	16.0	3.0	6,900	4,405	92	F	---	---	---	---	---	---	-65	-0.94%	---	---
		PM	14.0	3.0	6,900	4,171	99	F	---	---	---	---	---	---	-79	-1.14%	---	---
I-880 First to SR 87	SB	AM	25.0	3.0	6,900	5,439	73	F	---	---	---	---	---	---	-41	-0.59%	---	---
		PM	14.0	3.0	6,900	4,096	98	F	---	---	---	---	---	---	-64	-0.93%	---	---
I-880 SR 87 to Coleman	SB	AM	65.0	3.0	6,900	5,809	30	D	---	---	---	---	---	---	-41	-0.59%	---	---
		PM	23.0	3.0	6,900	5,186	75	F	---	---	---	---	---	---	-64	-0.93%	---	---
I-880 Coleman to The Alameda	SB	AM	66.0	3.0	6,900	5,261	27	D	---	---	---	---	---	---	-49	-0.71%	---	---
		PM	23.0	3.0	6,900	5,219	76	F	---	---	---	---	---	---	-31	-0.45%	---	---
I-880 The Alameda to Bascom	SB	AM	66.0	3.0	6,900	4,927	25	C	---	---	---	---	---	---	-23	-0.33%	---	---
		PM	25.0	3.0	6,900	5,459	73	F	---	---	---	---	---	---	-21	-0.30%	---	---
I-880 Bascom to Stevens Creek	SB	AM	50.0	3.0	6,900	6,583	44	D	---	---	---	---	---	---	-17	-0.25%	---	---
		PM	30.0	3.0	6,900	5,745	64	F	---	---	---	---	---	---	-15	-0.22%	---	---
I-880 Stevens Creek to I-280	SB	AM	66.0	3.0	6,900	3,946	20	C	---	---	---	---	---	---	-14	-0.20%	---	---
		PM	65.0	3.0	6,900	5,841	30	D	---	---	---	---	---	---	-9	-0.13%	---	---
US 101 Great America to Montague	SB	AM	66.0	3.0	6,900	4,941	25	C	67.0	1.0	1,650	1,063	16	B	-9	-0.13%	-17	-1.03%
		PM	14.0	3.0	6,900	4,153	99	F	20.0	1.0	1,650	1,813	91	F	-7	-0.10%	-7	-0.42%
US 101 Montague to De La Cruz	SB	AM	66.0	3.0	6,900	5,295	27	D	67.0	1.0	1,650	923	14	B	-15	-0.22%	-17	-1.03%
		PM	13.0	3.0	6,900	4,052	104	F	40.0	1.0	1,650	2,511	63	F	-8	-0.12%	-9	-0.55%
US 101 De La Cruz to SR 87	SB	AM	62.0	3.0	6,900	6,483	35	D	67.0	1.0	1,650	599	9	A	-27	-0.39%	-11	-0.67%
		PM	18.0	3.0	6,900	4,689	87	F	50.0	1.0	1,650	2,392	48	E	-11	-0.16%	-8	-0.48%
US 101 SR 87 to First	SB	AM	67.0	3.0	6,900	2,589	13	B	67.0	1.0	1,650	399	6	A	-11	-0.16%	-11	-0.67%
		PM	16.0	3.0	6,900	4,511	94	F	30.0	1.0	1,650	2,334	78	F	-9	-0.13%	-6	-0.36%
US 101 First to Old Bayshore	SB	AM	67.0	3.0	6,900	3,392	17	B	67.0	1.0	1,650	399	6	A	-8	-0.12%	-11	-0.67%
		PM	6.0	3.0	6,900	2,643	147	F	20.0	1.0	1,650	1,815	91	F	-7	-0.10%	-5	-0.30%
US 101 Old Bayshore to I-880	SB	AM	67.0	3.0	6,900	2,389	12	B	67.0	1.0	1,650	529	8	A	-11	-0.16%	-11	-0.67%
		PM	8.0	3.0	6,900	3,021	126	F	30.0	1.0	1,650	2,154	72	F	-9	-0.13%	-6	-0.36%

Source: Santa Clara Valley Transportation Authority Congestion Management Program Monitoring Study, 2014.
 Bold indicates unacceptable LOS.

Attachments: **Existing + Phase II Project Level of Service Calculations**

Level of Service Calculations

Alum Rock Station – Existing Plus Project

BART Phase II Extension Project

Level Of Service Computation Report
 2000 HCM Operations (Future Volume Alternative)
 AM - Existing Plus Project Conditions

Intersection #3016: 101/ALUM ROCK

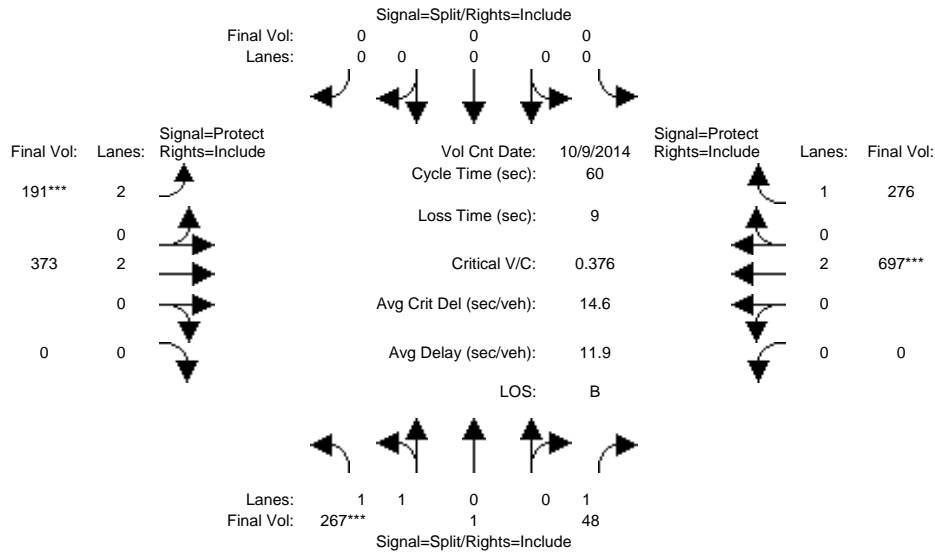

Approach:	North Bound			South Bound			East Bound			West Bound		
	L	T	R	L	T	R	L	T	R	L	T	R
Min. Green:	10	10	10	0	0	0	7	10	0	0	10	10
Y+R:	4.0	4.0	4.0	4.0	4.0	4.0	4.0	4.0	4.0	4.0	4.0	4.0

Volume Module:	>>	Count	Date:	9 Oct 2014	<<												
Base Vol:	267	1	48	0	0	0	191	373	0	0	697	276					
Growth Adj:	1.00	1.00	1.00	1.00	1.00	1.00	1.00	1.00	1.00	1.00	1.00	1.00	1.00	1.00	1.00		
Initial Bse:	267	1	48	0	0	0	191	373	0	0	697	276					
Added Vol:	0	0	0	0	0	0	0	0	0	0	0	0					
PasserByVol:	0	0	0	0	0	0	0	0	0	0	0	0					
Initial Fut:	267	1	48	0	0	0	191	373	0	0	697	276					
User Adj:	1.00	1.00	1.00	1.00	1.00	1.00	1.00	1.00	1.00	1.00	1.00	1.00	1.00	1.00	1.00		
PHF Adj:	1.00	1.00	1.00	1.00	1.00	1.00	1.00	1.00	1.00	1.00	1.00	1.00	1.00	1.00	1.00		
PHF Volume:	267	1	48	0	0	0	191	373	0	0	697	276					
Reduct Vol:	0	0	0	0	0	0	0	0	0	0	0	0					
Reduced Vol:	267	1	48	0	0	0	191	373	0	0	697	276					
PCE Adj:	1.00	1.00	1.00	1.00	1.00	1.00	1.00	1.00	1.00	1.00	1.00	1.00	1.00	1.00	1.00		
MLF Adj:	1.00	1.00	1.00	1.00	1.00	1.00	1.00	1.00	1.00	1.00	1.00	1.00	1.00	1.00	1.00		
Final Volume:	267	1	48	0	0	0	191	373	0	0	697	276					

Saturation Flow Module:																
Sat/Lane:	1900	1900	1900	1900	1900	1900	1900	1900	1900	1900	1900	1900				
Adjustment:	0.93	0.95	0.92	0.92	1.00	0.92	0.83	1.00	0.92	0.92	1.00	0.92				
Lanes:	1.99	0.01	1.00	0.00	0.00	0.00	2.00	2.00	0.00	0.00	2.00	1.00				
Final Sat.:	3537	13	1750	0	0	0	3150	3800	0	0	3800	1750				

Capacity Analysis Module:																
Vol/Sat:	0.08	0.08	0.03	0.00	0.00	0.00	0.06	0.10	0.00	0.00	0.18	0.16				
Crit Moves:	****						****			****						
Green Time:	12.0	12.0	12.0	0.0	0.0	0.0	9.7	39.0	0.0	0.0	29.3	29.3				
Volume/Cap:	0.38	0.38	0.14	0.00	0.00	0.00	0.38	0.15	0.00	0.00	0.38	0.32				
Delay/Veh:	21.1	21.1	19.9	0.0	0.0	0.0	22.9	4.1	0.0	0.0	9.8	9.6				
User DelAdj:	1.00	1.00	1.00	1.00	1.00	1.00	1.00	1.00	1.00	1.00	1.00	1.00				
AdjDel/Veh:	21.1	21.1	19.9	0.0	0.0	0.0	22.9	4.1	0.0	0.0	9.8	9.6				
LOS by Move:	C	C	B	A	A	A	C	A	A	A	A	A				
HCM2k95thQ:	5	5	2	0	0	0	4	3	0	0	8	7				

Note: Queue reported is the number of cars per lane.

BART Phase II Extension Project

Level Of Service Computation Report
 2000 HCM Operations (Future Volume Alternative)
 PM - Existing Plus Project Conditions

Intersection #3016: 101/ALUM ROCK

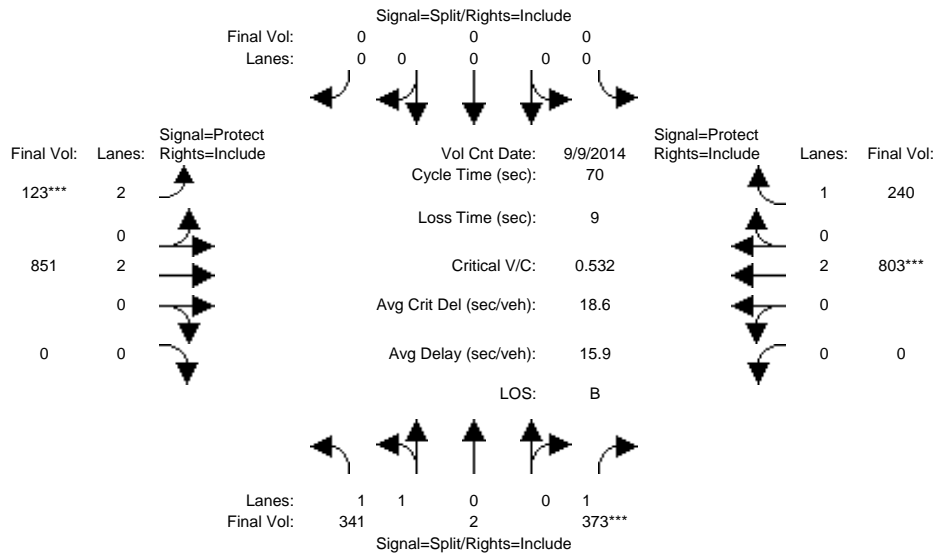

Approach:	North Bound			South Bound			East Bound			West Bound		
Movement:	L	T	R	L	T	R	L	T	R	L	T	R
Min. Green:	10	10	10	0	0	0	7	10	0	0	10	10
Y+R:	4.0	4.0	4.0	4.0	4.0	4.0	4.0	4.0	4.0	4.0	4.0	4.0
Volume Module: >> Count Date: 9 Sep 2014 <<												
Base Vol:	341	2	373	0	0	0	123	851	0	0	803	240
Growth Adj:	1.00	1.00	1.00	1.00	1.00	1.00	1.00	1.00	1.00	1.00	1.00	1.00
Initial Bse:	341	2	373	0	0	0	123	851	0	0	803	240
Added Vol:	0	0	0	0	0	0	0	0	0	0	0	0
PasserByVol:	0	0	0	0	0	0	0	0	0	0	0	0
Initial Fut:	341	2	373	0	0	0	123	851	0	0	803	240
User Adj:	1.00	1.00	1.00	1.00	1.00	1.00	1.00	1.00	1.00	1.00	1.00	1.00
PHF Adj:	1.00	1.00	1.00	1.00	1.00	1.00	1.00	1.00	1.00	1.00	1.00	1.00
PHF Volume:	341	2	373	0	0	0	123	851	0	0	803	240
Reduct Vol:	0	0	0	0	0	0	0	0	0	0	0	0
Reduced Vol:	341	2	373	0	0	0	123	851	0	0	803	240
PCE Adj:	1.00	1.00	1.00	1.00	1.00	1.00	1.00	1.00	1.00	1.00	1.00	1.00
MLF Adj:	1.00	1.00	1.00	1.00	1.00	1.00	1.00	1.00	1.00	1.00	1.00	1.00
FinalVolume:	341	2	373	0	0	0	123	851	0	0	803	240
Saturation Flow Module:												
Sat/Lane:	1900	1900	1900	1900	1900	1900	1900	1900	1900	1900	1900	1900
Adjustment:	0.93	0.95	0.92	0.92	1.00	0.92	0.83	1.00	0.92	0.92	1.00	0.92
Lanes:	1.99	0.01	1.00	0.00	0.00	0.00	2.00	2.00	0.00	0.00	2.00	1.00
Final Sat.:	3529	21	1750	0	0	0	3150	3800	0	0	3800	1750
Capacity Analysis Module:												
Vol/Sat:	0.10	0.10	0.21	0.00	0.00	0.00	0.04	0.22	0.00	0.00	0.21	0.14
Crit Moves:			****				****				****	
Green Time:	27.1	27.1	27.1	0.0	0.0	0.0	7.0	33.9	0.0	0.0	26.9	26.9
Volume/Cap:	0.25	0.25	0.55	0.00	0.00	0.00	0.39	0.46	0.00	0.00	0.55	0.36
Delay/Veh:	14.6	14.6	17.7	0.0	0.0	0.0	30.3	12.2	0.0	0.0	17.3	15.7
User DelAdj:	1.00	1.00	1.00	1.00	1.00	1.00	1.00	1.00	1.00	1.00	1.00	1.00
AdjDel/Veh:	14.6	14.6	17.7	0.0	0.0	0.0	30.3	12.2	0.0	0.0	17.3	15.7
LOS by Move:	B	B	B	A	A	A	C	B	A	A	B	B
HCM2k95thQ:	6	6	14	0	0	0	3	11	0	0	13	8

Note: Queue reported is the number of cars per lane.

BART Phase II Extension Project

Level Of Service Computation Report
 2000 HCM Operations (Future Volume Alternative)
 AM - Existing Plus Project Conditions

Intersection #3023: 101/SANTA CLARA

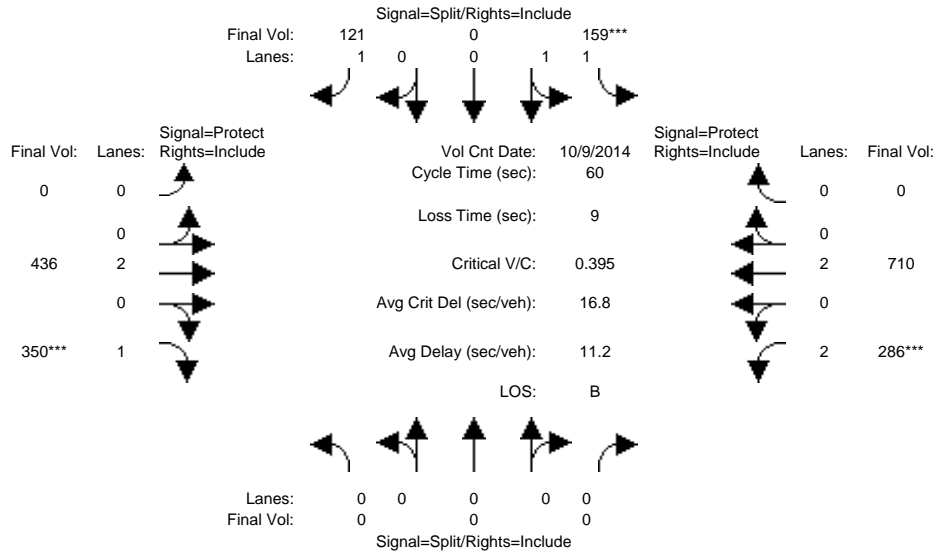

Approach:	North Bound			South Bound			East Bound			West Bound		
	L	T	R	L	T	R	L	T	R	L	T	R
Min. Green:	0	0	0	10	10	10	0	10	10	7	10	0
Y+R:	4.0	4.0	4.0	4.0	4.0	4.0	4.0	4.0	4.0	4.0	4.0	4.0
Volume Module: >> Count Date: 9 Oct 2014 <<												
Base Vol:	0	0	0	159	0	121	0	436	350	286	710	0
Growth Adj:	1.00	1.00	1.00	1.00	1.00	1.00	1.00	1.00	1.00	1.00	1.00	1.00
Initial Bse:	0	0	0	159	0	121	0	436	350	286	710	0
Added Vol:	0	0	0	0	0	0	0	0	0	0	0	0
PasserByVol:	0	0	0	0	0	0	0	0	0	0	0	0
Initial Fut:	0	0	0	159	0	121	0	436	350	286	710	0
User Adj:	1.00	1.00	1.00	1.00	1.00	1.00	1.00	1.00	1.00	1.00	1.00	1.00
PHF Adj:	1.00	1.00	1.00	1.00	1.00	1.00	1.00	1.00	1.00	1.00	1.00	1.00
PHF Volume:	0	0	0	159	0	121	0	436	350	286	710	0
Reduct Vol:	0	0	0	0	0	0	0	0	0	0	0	0
Reduced Vol:	0	0	0	159	0	121	0	436	350	286	710	0
PCE Adj:	1.00	1.00	1.00	1.00	1.00	1.00	1.00	1.00	1.00	1.00	1.00	1.00
MLF Adj:	1.00	1.00	1.00	1.00	1.00	1.00	1.00	1.00	1.00	1.00	1.00	1.00
FinalVolume:	0	0	0	159	0	121	0	436	350	286	710	0
Saturation Flow Module:												
Sat/Lane:	1900	1900	1900	1900	1900	1900	1900	1900	1900	1900	1900	1900
Adjustment:	0.92	1.00	0.92	0.93	1.00	0.92	0.92	1.00	0.92	0.83	1.00	0.92
Lanes:	0.00	0.00	0.00	2.00	0.00	1.00	0.00	2.00	1.00	2.00	2.00	0.00
Final Sat.:	0	0	0	3550	0	1750	0	3800	1750	3150	3800	0
Capacity Analysis Module:												
Vol/Sat:	0.00	0.00	0.00	0.04	0.00	0.07	0.00	0.11	0.20	0.09	0.19	0.00
Crit Moves:				****				****			****	
Green Time:	0.0	0.0	0.0	10.5	0.0	10.5	0.0	27.8	27.8	12.6	40.5	0.0
Volume/Cap:	0.00	0.00	0.00	0.26	0.00	0.39	0.00	0.25	0.43	0.43	0.28	0.00
Delay/Veh:	0.0	0.0	0.0	21.6	0.0	22.8	0.0	9.8	11.1	21.0	4.0	0.0
User DelAdj:	1.00	1.00	1.00	1.00	1.00	1.00	1.00	1.00	1.00	1.00	1.00	1.00
AdjDel/Veh:	0.0	0.0	0.0	21.6	0.0	22.8	0.0	9.8	11.1	21.0	4.0	0.0
LOS by Move:	A	A	A	C	A	C	A	A	B	C	A	A
HCM2k95thQ:	0	0	0	3	0	5	0	5	9	5	5	0

Note: Queue reported is the number of cars per lane.

BART Phase II Extension Project

Level Of Service Computation Report
 2000 HCM Operations (Future Volume Alternative)
 PM - Existing Plus Project Conditions

Intersection #3023: 101/SANTA CLARA

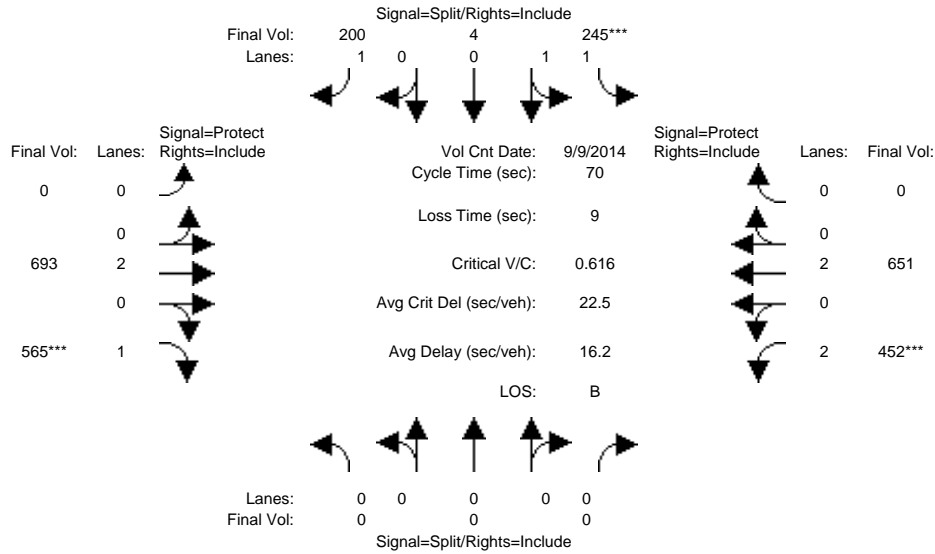

Approach:	North Bound			South Bound			East Bound			West Bound		
	L	T	R	L	T	R	L	T	R	L	T	R
Min. Green:	0	0	0	10	10	10	0	10	10	7	10	0
Y+R:	4.0	4.0	4.0	4.0	4.0	4.0	4.0	4.0	4.0	4.0	4.0	4.0
Volume Module: >> Count Date: 9 Sep 2014 <<												
Base Vol:	0	0	0	245	4	200	0	693	565	452	651	0
Growth Adj:	1.00	1.00	1.00	1.00	1.00	1.00	1.00	1.00	1.00	1.00	1.00	1.00
Initial Bse:	0	0	0	245	4	200	0	693	565	452	651	0
Added Vol:	0	0	0	0	0	0	0	0	0	0	0	0
PasserByVol:	0	0	0	0	0	0	0	0	0	0	0	0
Initial Fut:	0	0	0	245	4	200	0	693	565	452	651	0
User Adj:	1.00	1.00	1.00	1.00	1.00	1.00	1.00	1.00	1.00	1.00	1.00	1.00
PHF Adj:	1.00	1.00	1.00	1.00	1.00	1.00	1.00	1.00	1.00	1.00	1.00	1.00
PHF Volume:	0	0	0	245	4	200	0	693	565	452	651	0
Reduct Vol:	0	0	0	0	0	0	0	0	0	0	0	0
Reduced Vol:	0	0	0	245	4	200	0	693	565	452	651	0
PCE Adj:	1.00	1.00	1.00	1.00	1.00	1.00	1.00	1.00	1.00	1.00	1.00	1.00
MLF Adj:	1.00	1.00	1.00	1.00	1.00	1.00	1.00	1.00	1.00	1.00	1.00	1.00
FinalVolume:	0	0	0	245	4	200	0	693	565	452	651	0
Saturation Flow Module:												
Sat/Lane:	1900	1900	1900	1900	1900	1900	1900	1900	1900	1900	1900	1900
Adjustment:	0.92	1.00	0.92	0.93	0.95	0.92	0.92	1.00	0.92	0.83	1.00	0.92
Lanes:	0.00	0.00	0.00	1.97	0.03	1.00	0.00	2.00	1.00	2.00	2.00	0.00
Final Sat.:	0	0	0	3493	57	1750	0	3800	1750	3150	3800	0
Capacity Analysis Module:												
Vol/Sat:	0.00	0.00	0.00	0.07	0.07	0.11	0.00	0.18	0.32	0.14	0.17	0.00
Crit Moves:				****				****			****	
Green Time:	0.0	0.0	0.0	13.0	13.0	13.0	0.0	33.2	33.2	14.8	48.0	0.0
Volume/Cap:	0.00	0.00	0.00	0.38	0.38	0.62	0.00	0.38	0.68	0.68	0.25	0.00
Delay/Veh:	0.0	0.0	0.0	25.3	25.3	29.7	0.0	11.9	16.6	28.3	4.2	0.0
User DelAdj:	1.00	1.00	1.00	1.00	1.00	1.00	1.00	1.00	1.00	1.00	1.00	1.00
AdjDel/Veh:	0.0	0.0	0.0	25.3	25.3	29.7	0.0	11.9	16.6	28.3	4.2	0.0
LOS by Move:	A	A	A	C	C	C	A	B	B	C	A	A
HCM2k95thQ:	0	0	0	6	6	10	0	9	19	11	5	0

Note: Queue reported is the number of cars per lane.

BART Phase II Extension Project

Level Of Service Computation Report
 2000 HCM Operations (Future Volume Alternative)
 AM - Existing Plus Project Conditions

Intersection #3036: 280/MCLAUGHLIN

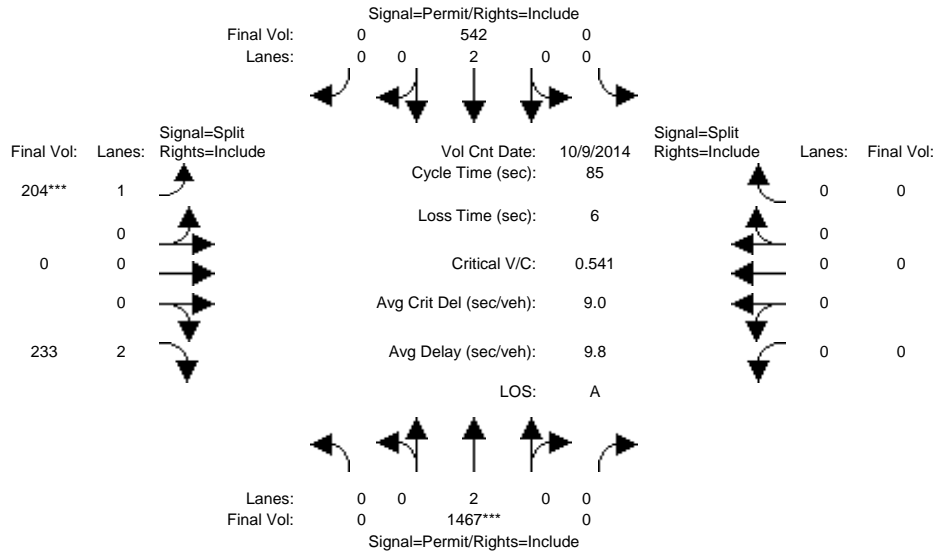

Approach:	North Bound			South Bound			East Bound			West Bound		
	L	T	R	L	T	R	L	T	R	L	T	R
Min. Green:	0	10	0	0	10	0	10	0	10	0	0	0
Y+R:	4.0	4.0	4.0	4.0	4.0	4.0	4.0	4.0	4.0	4.0	4.0	4.0
Volume Module: >> Count Date: 9 Oct 2014 <<												
Base Vol:	0	1467	0	0	542	0	204	0	233	0	0	0
Growth Adj:	1.00	1.00	1.00	1.00	1.00	1.00	1.00	1.00	1.00	1.00	1.00	1.00
Initial Bse:	0	1467	0	0	542	0	204	0	233	0	0	0
Added Vol:	0	0	0	0	0	0	0	0	0	0	0	0
PasserByVol:	0	0	0	0	0	0	0	0	0	0	0	0
Initial Fut:	0	1467	0	0	542	0	204	0	233	0	0	0
User Adj:	1.00	1.00	1.00	1.00	1.00	1.00	1.00	1.00	1.00	1.00	1.00	1.00
PHF Adj:	1.00	1.00	1.00	1.00	1.00	1.00	1.00	1.00	1.00	1.00	1.00	1.00
PHF Volume:	0	1467	0	0	542	0	204	0	233	0	0	0
Reduct Vol:	0	0	0	0	0	0	0	0	0	0	0	0
Reduced Vol:	0	1467	0	0	542	0	204	0	233	0	0	0
PCE Adj:	1.00	1.00	1.00	1.00	1.00	1.00	1.00	1.00	1.00	1.00	1.00	1.00
MLF Adj:	1.00	1.00	1.00	1.00	1.00	1.00	1.00	1.00	1.00	1.00	1.00	1.00
Final Volume:	0	1467	0	0	542	0	204	0	233	0	0	0
Saturation Flow Module:												
Sat/Lane:	1900	1900	1900	1900	1900	1900	1900	1900	1900	1900	1900	1900
Adjustment:	0.92	1.00	0.92	0.92	1.00	0.92	0.92	1.00	0.83	0.92	1.00	0.92
Lanes:	0.00	2.00	0.00	0.00	2.00	0.00	1.00	0.00	2.00	0.00	0.00	0.00
Final Sat.:	0	3800	0	0	3800	0	1750	0	3150	0	0	0
Capacity Analysis Module:												
Vol/Sat:	0.00	0.39	0.00	0.00	0.14	0.00	0.12	0.00	0.07	0.00	0.00	0.00
Crit Moves:	****			****			****			****		
Green Time:	0.0	60.7	0.0	0.0	60.7	0.0	18.3	0.0	18.3	0.0	0.0	0.0
Volume/Cap:	0.00	0.54	0.00	0.00	0.20	0.00	0.54	0.00	0.34	0.00	0.00	0.00
Delay/Veh:	0.0	5.9	0.0	0.0	4.1	0.0	31.2	0.0	28.5	0.0	0.0	0.0
User DelAdj:	1.00	1.00	1.00	1.00	1.00	1.00	1.00	1.00	1.00	1.00	1.00	1.00
AdjDel/Veh:	0.0	5.9	0.0	0.0	4.1	0.0	31.2	0.0	28.5	0.0	0.0	0.0
LOS by Move:	A	A	A	A	A	A	C	A	C	A	A	A
HCM2k95thQ:	0	17	0	0	5	0	11	0	7	0	0	0

Note: Queue reported is the number of cars per lane.

BART Phase II Extension Project

Level Of Service Computation Report
 2000 HCM Operations (Future Volume Alternative)
 PM - Existing Plus Project Conditions

Intersection #3036: 280/MCLAUGHLIN

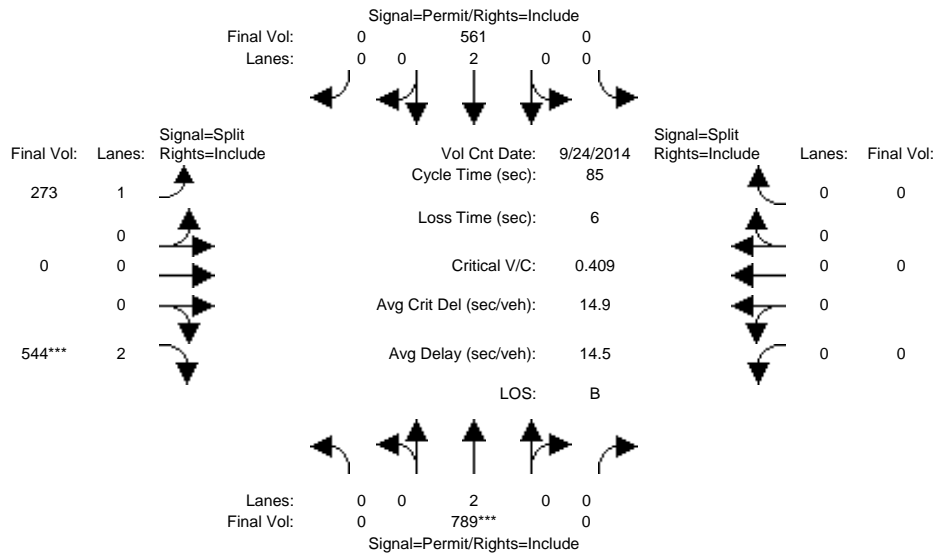

Approach:	North Bound			South Bound			East Bound			West Bound		
	L	T	R	L	T	R	L	T	R	L	T	R
Min. Green:	0	10	0	0	10	0	10	0	10	0	0	0
Y+R:	4.0	4.0	4.0	4.0	4.0	4.0	4.0	4.0	4.0	4.0	4.0	4.0
Volume Module: >> Count Date: 24 Sep 2014 <<												
Base Vol:	0	789	0	0	561	0	273	0	544	0	0	0
Growth Adj:	1.00	1.00	1.00	1.00	1.00	1.00	1.00	1.00	1.00	1.00	1.00	1.00
Initial Bse:	0	789	0	0	561	0	273	0	544	0	0	0
Added Vol:	0	0	0	0	0	0	0	0	0	0	0	0
PasserByVol:	0	0	0	0	0	0	0	0	0	0	0	0
Initial Fut:	0	789	0	0	561	0	273	0	544	0	0	0
User Adj:	1.00	1.00	1.00	1.00	1.00	1.00	1.00	1.00	1.00	1.00	1.00	1.00
PHF Adj:	1.00	1.00	1.00	1.00	1.00	1.00	1.00	1.00	1.00	1.00	1.00	1.00
PHF Volume:	0	789	0	0	561	0	273	0	544	0	0	0
Reduct Vol:	0	0	0	0	0	0	0	0	0	0	0	0
Reduced Vol:	0	789	0	0	561	0	273	0	544	0	0	0
PCE Adj:	1.00	1.00	1.00	1.00	1.00	1.00	1.00	1.00	1.00	1.00	1.00	1.00
MLF Adj:	1.00	1.00	1.00	1.00	1.00	1.00	1.00	1.00	1.00	1.00	1.00	1.00
Final Volume:	0	789	0	0	561	0	273	0	544	0	0	0
Saturation Flow Module:												
Sat/Lane:	1900	1900	1900	1900	1900	1900	1900	1900	1900	1900	1900	1900
Adjustment:	0.92	1.00	0.92	0.92	1.00	0.92	0.92	1.00	0.83	0.92	1.00	0.92
Lanes:	0.00	2.00	0.00	0.00	2.00	0.00	1.00	0.00	2.00	0.00	0.00	0.00
Final Sat.:	0	3800	0	0	3800	0	1750	0	3150	0	0	0
Capacity Analysis Module:												
Vol/Sat:	0.00	0.21	0.00	0.00	0.15	0.00	0.16	0.00	0.17	0.00	0.00	0.00
Crit Moves:	****						****					
Green Time:	0.0	43.1	0.0	0.0	43.1	0.0	35.9	0.0	35.9	0.0	0.0	0.0
Volume/Cap:	0.00	0.41	0.00	0.00	0.29	0.00	0.37	0.00	0.41	0.00	0.00	0.00
Delay/Veh:	0.0	13.2	0.0	0.0	12.2	0.0	17.1	0.0	17.4	0.0	0.0	0.0
User DelAdj:	1.00	1.00	1.00	1.00	1.00	1.00	1.00	1.00	1.00	1.00	1.00	1.00
AdjDel/Veh:	0.0	13.2	0.0	0.0	12.2	0.0	17.1	0.0	17.4	0.0	0.0	0.0
LOS by Move:	A	B	A	A	B	A	B	A	B	A	A	A
HCM2k95thQ:	0	12	0	0	8	0	10	0	12	0	0	0

Note: Queue reported is the number of cars per lane.

BART Phase II Extension Project

Level Of Service Computation Report
 2000 HCM Operations (Future Volume Alternative)
 AM - Existing Plus Project Conditions

Intersection #3210: 101/JULIAN

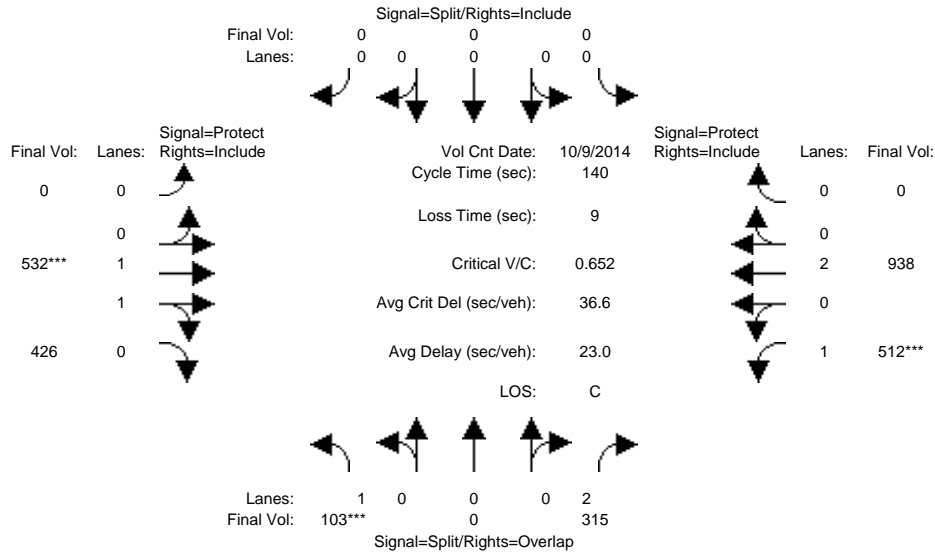

Approach:	North Bound			South Bound			East Bound			West Bound		
	L	T	R	L	T	R	L	T	R	L	T	R
Min. Green:	10	0	10	0	0	0	0	10	10	7	10	0
Y+R:	4.0	4.0	4.0	4.0	4.0	4.0	4.0	4.0	4.0	4.0	4.0	4.0
Volume Module: >> Count Date: 9 Oct 2014 <<												
Base Vol:	103	0	315	0	0	0	0	532	426	512	938	0
Growth Adj:	1.00	1.00	1.00	1.00	1.00	1.00	1.00	1.00	1.00	1.00	1.00	1.00
Initial Bse:	103	0	315	0	0	0	0	532	426	512	938	0
Added Vol:	0	0	0	0	0	0	0	0	0	0	0	0
PasserByVol:	0	0	0	0	0	0	0	0	0	0	0	0
Initial Fut:	103	0	315	0	0	0	0	532	426	512	938	0
User Adj:	1.00	1.00	1.00	1.00	1.00	1.00	1.00	1.00	1.00	1.00	1.00	1.00
PHF Adj:	1.00	1.00	1.00	1.00	1.00	1.00	1.00	1.00	1.00	1.00	1.00	1.00
PHF Volume:	103	0	315	0	0	0	0	532	426	512	938	0
Reduct Vol:	0	0	0	0	0	0	0	0	0	0	0	0
Reduced Vol:	103	0	315	0	0	0	0	532	426	512	938	0
PCE Adj:	1.00	1.00	1.00	1.00	1.00	1.00	1.00	1.00	1.00	1.00	1.00	1.00
MLF Adj:	1.00	1.00	1.00	1.00	1.00	1.00	1.00	1.00	1.00	1.00	1.00	1.00
FinalVolume:	103	0	315	0	0	0	0	532	426	512	938	0
Saturation Flow Module:												
Sat/Lane:	1900	1900	1900	1900	1900	1900	1900	1900	1900	1900	1900	1900
Adjustment:	0.92	1.00	0.83	0.92	1.00	0.92	0.92	0.99	0.95	0.92	1.00	0.92
Lanes:	1.00	0.00	2.00	0.00	0.00	0.00	0.00	1.09	0.91	1.00	2.00	0.00
Final Sat.:	1750	0	3150	0	0	0	0	2053	1644	1750	3800	0
Capacity Analysis Module:												
Vol/Sat:	0.06	0.00	0.10	0.00	0.00	0.00	0.00	0.26	0.26	0.29	0.25	0.00
Crit Moves:	****							****		****		
Green Time:	12.6	0.0	75.4	0.0	0.0	0.0	0.0	55.6	55.6	62.8	118	0.0
Volume/Cap:	0.65	0.00	0.19	0.00	0.00	0.00	0.00	0.65	0.65	0.65	0.29	0.00
Delay/Veh:	70.9	0.0	16.6	0.0	0.0	0.0	0.0	35.4	35.4	32.1	2.3	0.0
User DelAdj:	1.00	1.00	1.00	1.00	1.00	1.00	1.00	1.00	1.00	1.00	1.00	1.00
AdjDel/Veh:	70.9	0.0	16.6	0.0	0.0	0.0	0.0	35.4	35.4	32.1	2.3	0.0
LOS by Move:	E	A	B	A	A	A	A	D	D	C	A	A
HCM2k95thQ:	11	0	8	0	0	0	0	29	29	32	8	0

Note: Queue reported is the number of cars per lane.

BART Phase II Extension Project

Level Of Service Computation Report
2000 HCM Operations (Future Volume Alternative)
PM - Existing Plus Project Conditions

Intersection #3210: 101/JULIAN

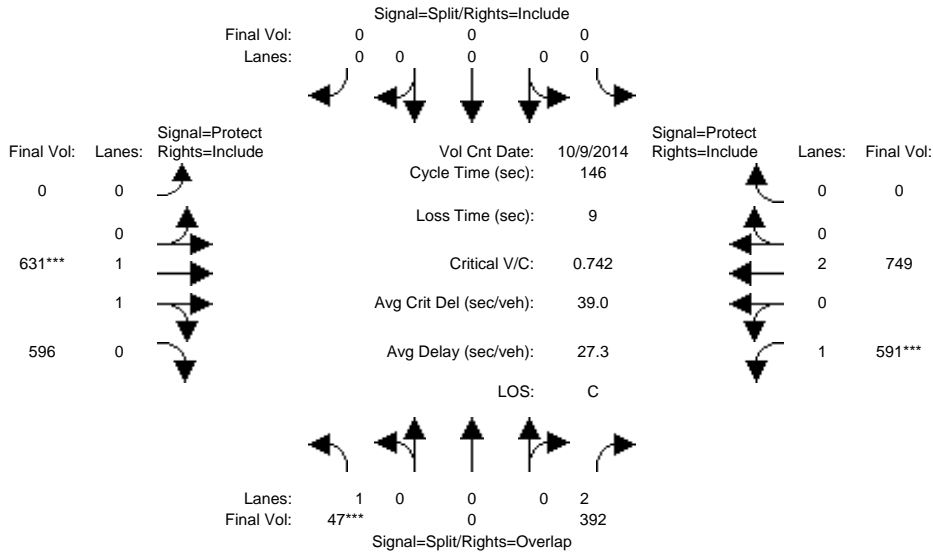

Approach:	North Bound			South Bound			East Bound			West Bound		
	L	T	R	L	T	R	L	T	R	L	T	R
Min. Green:	10	0	10	0	0	0	0	10	10	7	10	0
Y+R:	4.0	4.0	4.0	4.0	4.0	4.0	4.0	4.0	4.0	4.0	4.0	4.0

Volume Module:	>>	Count	Date:	9 Oct 2014	<<							
Base Vol:	47	0	392	0	0	0	0	631	596	591	749	0
Growth Adj:	1.00	1.00	1.00	1.00	1.00	1.00	1.00	1.00	1.00	1.00	1.00	1.00
Initial Bse:	47	0	392	0	0	0	0	631	596	591	749	0
Added Vol:	0	0	0	0	0	0	0	0	0	0	0	0
PasserByVol:	0	0	0	0	0	0	0	0	0	0	0	0
Initial Fut:	47	0	392	0	0	0	0	631	596	591	749	0
User Adj:	1.00	1.00	1.00	1.00	1.00	1.00	1.00	1.00	1.00	1.00	1.00	1.00
PHF Adj:	1.00	1.00	1.00	1.00	1.00	1.00	1.00	1.00	1.00	1.00	1.00	1.00
PHF Volume:	47	0	392	0	0	0	0	631	596	591	749	0
Reduct Vol:	0	0	0	0	0	0	0	0	0	0	0	0
Reduced Vol:	47	0	392	0	0	0	0	631	596	591	749	0
PCE Adj:	1.00	1.00	1.00	1.00	1.00	1.00	1.00	1.00	1.00	1.00	1.00	1.00
MLF Adj:	1.00	1.00	1.00	1.00	1.00	1.00	1.00	1.00	1.00	1.00	1.00	1.00
FinalVolume:	47	0	392	0	0	0	0	631	596	591	749	0

Saturation Flow Module:												
Sat/Lane:	1900	1900	1900	1900	1900	1900	1900	1900	1900	1900	1900	1900
Adjustment:	0.92	1.00	0.83	0.92	1.00	0.92	0.92	1.00	0.95	0.92	1.00	0.92
Lanes:	1.00	0.00	2.00	0.00	0.00	0.00	0.00	1.00	1.00	1.00	2.00	0.00
Final Sat.:	1750	0	3150	0	0	0	0	1901	1796	1750	3800	0

Capacity Analysis Module:												
Vol/Sat:	0.03	0.00	0.12	0.00	0.00	0.00	0.00	0.33	0.33	0.34	0.20	0.00
Crit Moves:	****							****		****		
Green Time:	10.0	0.0	74.1	0.0	0.0	0.0	0.0	62.9	62.9	64.1	127	0.0
Volume/Cap:	0.39	0.00	0.25	0.00	0.00	0.00	0.00	0.77	0.77	0.77	0.23	0.00
Delay/Veh:	67.2	0.0	20.3	0.0	0.0	0.0	0.0	37.7	37.7	39.5	1.6	0.0
User DelAdj:	1.00	1.00	1.00	1.00	1.00	1.00	1.00	1.00	1.00	1.00	1.00	1.00
AdjDel/Veh:	67.2	0.0	20.3	0.0	0.0	0.0	0.0	37.7	37.7	39.5	1.6	0.0
LOS by Move:	E	A	C	A	A	A	A	D	D	D	A	A
HCM2k95thQ:	5	0	11	0	0	0	0	40	40	41	6	0

Note: Queue reported is the number of cars per lane.

BART Phase II Extension Project

Level Of Service Computation Report
 2000 HCM Operations (Future Volume Alternative)
 AM - Existing Plus Project Conditions

Intersection #3211: 101/McKee(E)

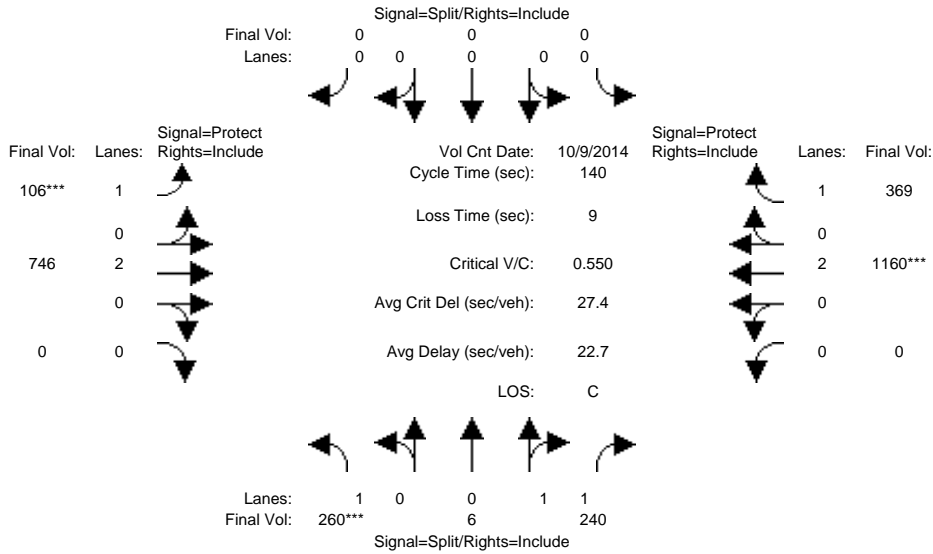

Approach:	North Bound			South Bound			East Bound			West Bound			
Movement:	L	T	R	L	T	R	L	T	R	L	T	R	
Min. Green:	10	10	10	0	0	0	7	10	0	0	10	10	
Y+R:	4.0	4.0	4.0	4.0	4.0	4.0	4.0	4.0	4.0	4.0	4.0	4.0	
Volume Module: >> Count Date: 9 Oct 2014 <<													
Base Vol:	260	6	240	0	0	0	106	746	0	0	1160	369	
Growth Adj:	1.00	1.00	1.00	1.00	1.00	1.00	1.00	1.00	1.00	1.00	1.00	1.00	
Initial Bse:	260	6	240	0	0	0	106	746	0	0	1160	369	
Added Vol:	0	0	0	0	0	0	0	0	0	0	0	0	
PasserByVol:	0	0	0	0	0	0	0	0	0	0	0	0	
Initial Fut:	260	6	240	0	0	0	106	746	0	0	1160	369	
User Adj:	1.00	1.00	1.00	1.00	1.00	1.00	1.00	1.00	1.00	1.00	1.00	1.00	
PHF Adj:	1.00	1.00	1.00	1.00	1.00	1.00	1.00	1.00	1.00	1.00	1.00	1.00	
PHF Volume:	260	6	240	0	0	0	106	746	0	0	1160	369	
Reduct Vol:	0	0	0	0	0	0	0	0	0	0	0	0	
Reduced Vol:	260	6	240	0	0	0	106	746	0	0	1160	369	
PCE Adj:	1.00	1.00	1.00	1.00	1.00	1.00	1.00	1.00	1.00	1.00	1.00	1.00	
MLF Adj:	1.00	1.00	1.00	1.00	1.00	1.00	1.00	1.00	1.00	1.00	1.00	1.00	
FinalVolume:	260	6	240	0	0	0	106	746	0	0	1160	369	
Saturation Flow Module:													
Sat/Lane:	1900	1900	1900	1900	1900	1900	1900	1900	1900	1900	1900	1900	
Adjustment:	0.92	0.95	0.95	0.92	1.00	0.92	0.92	1.00	0.92	0.92	1.00	0.92	
Lanes:	1.00	0.05	1.95	0.00	0.00	0.00	1.00	2.00	0.00	0.00	2.00	1.00	
Final Sat.:	1750	88	3512	0	0	0	1750	3800	0	0	3800	1750	
Capacity Analysis Module:													
Vol/Sat:	0.15	0.07	0.07	0.00	0.00	0.00	0.06	0.20	0.00	0.00	0.31	0.21	
Crit Moves:	****							****					
Green Time:	37.8	37.8	37.8	0.0	0.0	0.0	15.4	93.2	0.0	0.0	77.7	77.7	
Volume/Cap:	0.55	0.25	0.25	0.00	0.00	0.00	0.55	0.30	0.00	0.00	0.55	0.38	
Delay/Veh:	45.2	40.1	40.1	0.0	0.0	0.0	62.4	9.8	0.0	0.0	20.2	17.8	
User DelAdj:	1.00	1.00	1.00	1.00	1.00	1.00	1.00	1.00	1.00	1.00	1.00	1.00	
AdjDel/Veh:	45.2	40.1	40.1	0.0	0.0	0.0	62.4	9.8	0.0	0.0	20.2	17.8	
LOS by Move:	D	D	D	A	A	A	E	A	A	A	C	B	
HCM2k95thQ:	19	8	8	0	0	0	10	12	0	0	27	17	

Note: Queue reported is the number of cars per lane.

BART Phase II Extension Project

Level Of Service Computation Report
 2000 HCM Operations (Future Volume Alternative)
 PM - Existing Plus Project Conditions

Intersection #3211: 101/McKee(E)

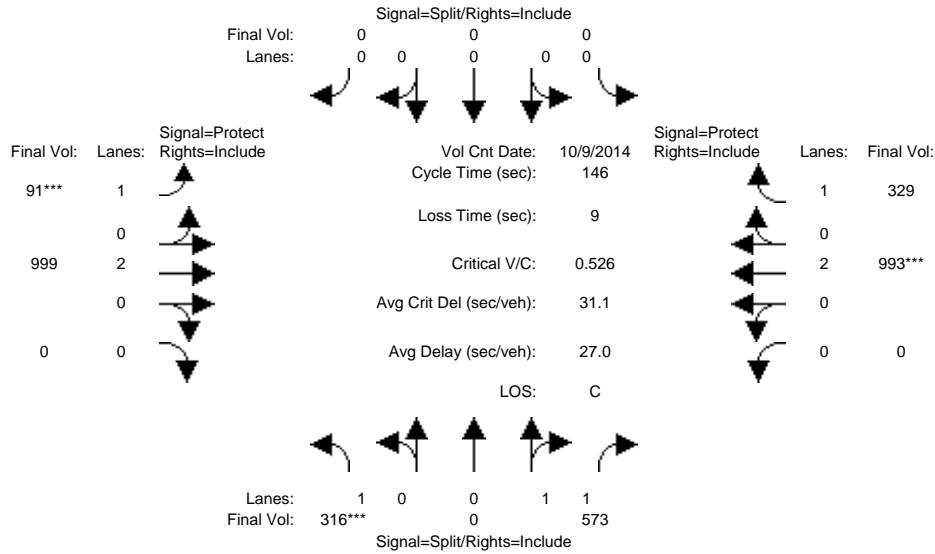

Approach:	North Bound			South Bound			East Bound			West Bound		
	L	T	R	L	T	R	L	T	R	L	T	R
Min. Green:	10	10	10	0	0	0	7	10	0	0	10	10
Y+R:	4.0	4.0	4.0	4.0	4.0	4.0	4.0	4.0	4.0	4.0	4.0	4.0

Volume Module: >> Count Date: 9 Oct 2014 <<

Base Vol:	316	0	573	0	0	0	91	999	0	0	993	329
Growth Adj:	1.00	1.00	1.00	1.00	1.00	1.00	1.00	1.00	1.00	1.00	1.00	1.00
Initial Bse:	316	0	573	0	0	0	91	999	0	0	993	329
Added Vol:	0	0	0	0	0	0	0	0	0	0	0	0
PasserByVol:	0	0	0	0	0	0	0	0	0	0	0	0
Initial Fut:	316	0	573	0	0	0	91	999	0	0	993	329
User Adj:	1.00	1.00	1.00	1.00	1.00	1.00	1.00	1.00	1.00	1.00	1.00	1.00
PHF Adj:	1.00	1.00	1.00	1.00	1.00	1.00	1.00	1.00	1.00	1.00	1.00	1.00
PHF Volume:	316	0	573	0	0	0	91	999	0	0	993	329
Reduct Vol:	0	0	0	0	0	0	0	0	0	0	0	0
Reduced Vol:	316	0	573	0	0	0	91	999	0	0	993	329
PCE Adj:	1.00	1.00	1.00	1.00	1.00	1.00	1.00	1.00	1.00	1.00	1.00	1.00
MLF Adj:	1.00	1.00	1.00	1.00	1.00	1.00	1.00	1.00	1.00	1.00	1.00	1.00
FinalVolume:	316	0	573	0	0	0	91	999	0	0	993	329

Saturation Flow Module:

Sat/Lane:	1900	1900	1900	1900	1900	1900	1900	1900	1900	1900	1900	1900
Adjustment:	0.92	1.00	0.95	0.92	1.00	0.92	0.92	1.00	0.92	0.92	1.00	0.92
Lanes:	1.00	0.00	2.00	0.00	0.00	0.00	1.00	2.00	0.00	0.00	2.00	1.00
Final Sat.:	1750	0	3600	0	0	0	1750	3800	0	0	3800	1750

Capacity Analysis Module:

Vol/Sat:	0.18	0.00	0.16	0.00	0.00	0.00	0.05	0.26	0.00	0.00	0.26	0.19
Crit Moves:	****						****				****	
Green Time:	50.1	0.0	50.1	0.0	0.0	0.0	14.4	86.9	0.0	0.0	72.5	72.5
Volume/Cap:	0.53	0.00	0.46	0.00	0.00	0.00	0.53	0.44	0.00	0.00	0.53	0.38
Delay/Veh:	39.3	0.0	37.7	0.0	0.0	0.0	65.5	16.4	0.0	0.0	25.3	23.1
User DelAdj:	1.00	1.00	1.00	1.00	1.00	1.00	1.00	1.00	1.00	1.00	1.00	1.00
AdjDel/Veh:	39.3	0.0	37.7	0.0	0.0	0.0	65.5	16.4	0.0	0.0	25.3	23.1
LOS by Move:	D	A	D	A	A	A	E	B	A	A	C	C
HCM2k95thQ:	22	0	19	0	0	0	9	22	0	0	26	18

Note: Queue reported is the number of cars per lane.

BART Phase II Extension Project

Level Of Service Computation Report
 2000 HCM Operations (Future Volume Alternative)
 AM - Existing Plus Project Conditions

Intersection #3612: JULIAN/21ST

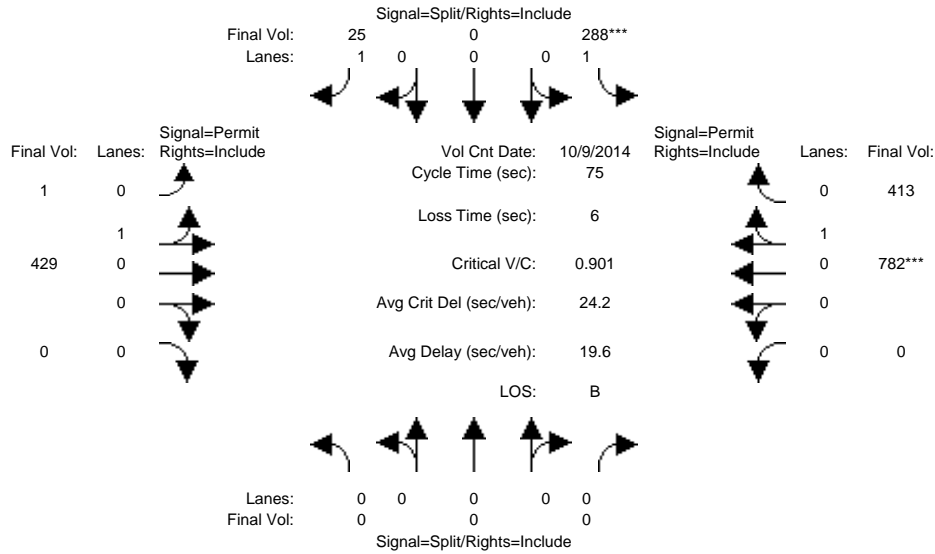

Approach:	North Bound			South Bound			East Bound			West Bound		
	L	T	R	L	T	R	L	T	R	L	T	R
Min. Green:	0	0	0	10	0	10	10	10	0	0	10	10
Y+R:	4.0	4.0	4.0	4.0	4.0	4.0	4.0	4.0	4.0	4.0	4.0	4.0

Volume Module:	>> Count Date: 9 Oct 2014 <<											
Base Vol:	0	0	0	288	0	25	1	429	0	0	782	413
Growth Adj:	1.00	1.00	1.00	1.00	1.00	1.00	1.00	1.00	1.00	1.00	1.00	1.00
Initial Bse:	0	0	0	288	0	25	1	429	0	0	782	413
Added Vol:	0	0	0	0	0	0	0	0	0	0	0	0
PasserByVol:	0	0	0	0	0	0	0	0	0	0	0	0
Initial Fut:	0	0	0	288	0	25	1	429	0	0	782	413
User Adj:	1.00	1.00	1.00	1.00	1.00	1.00	1.00	1.00	1.00	1.00	1.00	1.00
PHF Adj:	1.00	1.00	1.00	1.00	1.00	1.00	1.00	1.00	1.00	1.00	1.00	1.00
PHF Volume:	0	0	0	288	0	25	1	429	0	0	782	413
Reduct Vol:	0	0	0	0	0	0	0	0	0	0	0	0
Reduced Vol:	0	0	0	288	0	25	1	429	0	0	782	413
PCE Adj:	1.00	1.00	1.00	1.00	1.00	1.00	1.00	1.00	1.00	1.00	1.00	1.00
MLF Adj:	1.00	1.00	1.00	1.00	1.00	1.00	1.00	1.00	1.00	1.00	1.00	1.00
FinalVolume:	0	0	0	288	0	25	1	429	0	0	782	413

Saturation Flow Module:												
Sat/Lane:	1900	1900	1900	1900	1900	1900	1900	1900	1900	1900	1900	1900
Adjustment:	0.92	1.00	0.92	0.92	1.00	0.92	0.95	0.95	0.92	0.92	0.95	0.95
Lanes:	0.00	0.00	0.00	1.00	0.00	1.00	0.01	0.99	0.00	0.00	0.65	0.35
Final Sat.:	0	0	0	1750	0	1750	4	1796	0	0	1178	622

Capacity Analysis Module:													
Vol/Sat:	0.00	0.00	0.00	0.16	0.00	0.01	0.24	0.24	0.00	0.00	0.66	0.66	
Crit Moves:				****							****		
Green Time:	0.0	0.0	0.0	13.7	0.0	13.7	55.3	55.3	0.0	0.0	55.3	55.3	
Volume/Cap:	0.00	0.00	0.00	0.90	0.00	0.08	0.32	0.32	0.00	0.00	0.90	0.90	
Delay/Veh:	0.0	0.0	0.0	56.8	0.0	25.5	3.5	3.5	0.0	0.0	16.4	16.4	
User DelAdj:	1.00	1.00	1.00	1.00	1.00	1.00	1.00	1.00	1.00	1.00	1.00	1.00	
AdjDel/Veh:	0.0	0.0	0.0	56.8	0.0	25.5	3.5	3.5	0.0	0.0	16.4	16.4	
LOS by Move:	A	A	A	E	A	C	A	A	A	A	B	B	
HCM2k95thQ:	0	0	0	20	0	1	7	7	0	0	42	42	

Note: Queue reported is the number of cars per lane.

BART Phase II Extension Project

Level Of Service Computation Report
 2000 HCM Operations (Future Volume Alternative)
 PM - Existing Plus Project Conditions

Intersection #3612: JULIAN/21ST

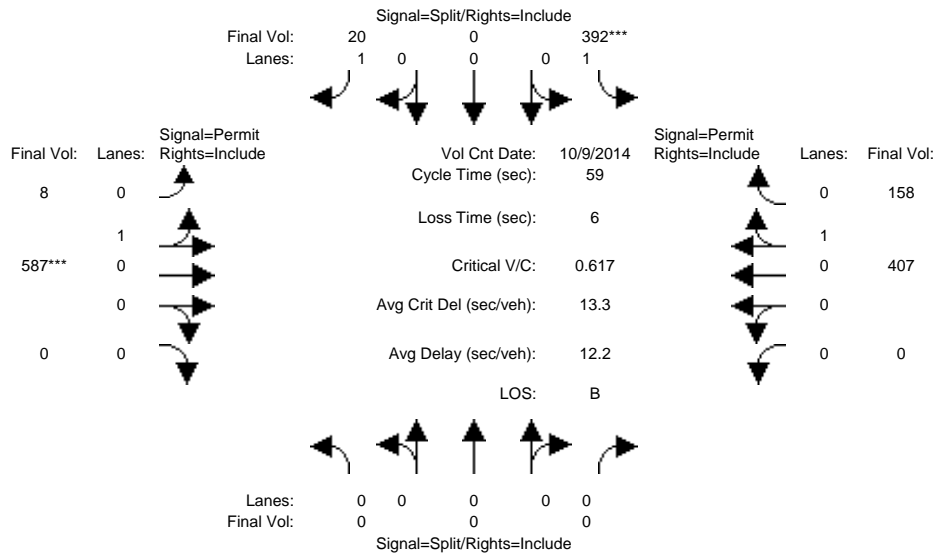

Approach:	North Bound			South Bound			East Bound			West Bound		
	L	T	R	L	T	R	L	T	R	L	T	R
Min. Green:	0	0	0	10	0	10	10	10	0	0	10	10
Y+R:	4.0	4.0	4.0	4.0	4.0	4.0	4.0	4.0	4.0	4.0	4.0	4.0

Volume Module:	Count Date: 9 Oct 2014 <<											
Base Vol:	0	0	0	392	0	20	8	587	0	0	407	158
Growth Adj:	1.00	1.00	1.00	1.00	1.00	1.00	1.00	1.00	1.00	1.00	1.00	1.00
Initial Bse:	0	0	0	392	0	20	8	587	0	0	407	158
Added Vol:	0	0	0	0	0	0	0	0	0	0	0	0
PasserByVol:	0	0	0	0	0	0	0	0	0	0	0	0
Initial Fut:	0	0	0	392	0	20	8	587	0	0	407	158
User Adj:	1.00	1.00	1.00	1.00	1.00	1.00	1.00	1.00	1.00	1.00	1.00	1.00
PHF Adj:	1.00	1.00	1.00	1.00	1.00	1.00	1.00	1.00	1.00	1.00	1.00	1.00
PHF Volume:	0	0	0	392	0	20	8	587	0	0	407	158
Reduct Vol:	0	0	0	0	0	0	0	0	0	0	0	0
Reduced Vol:	0	0	0	392	0	20	8	587	0	0	407	158
PCE Adj:	1.00	1.00	1.00	1.00	1.00	1.00	1.00	1.00	1.00	1.00	1.00	1.00
MLF Adj:	1.00	1.00	1.00	1.00	1.00	1.00	1.00	1.00	1.00	1.00	1.00	1.00
FinalVolume:	0	0	0	392	0	20	8	587	0	0	407	158

Saturation Flow Module:	Sat/Lane: 1900 1900 1900 1900 1900 1900 1900 1900 1900 1900 1900 1900											
Adjustment:	0.92	1.00	0.92	0.92	1.00	0.92	0.95	0.95	0.92	0.92	0.95	0.95
Lanes:	0.00	0.00	0.00	1.00	0.00	1.00	0.01	0.99	0.00	0.00	0.72	0.28
Final Sat.:	0	0	0	1750	0	1750	24	1776	0	0	1297	503

Capacity Analysis Module:	Vol/Sat: 0.00 0.00 0.00 0.22 0.00 0.01 0.33 0.33 0.00 0.00 0.31 0.31												
Crit Moves:				****							****		
Green Time:	0.0	0.0	0.0	21.4	0.0	21.4	31.6	31.6	0.0	0.0	31.6	31.6	
Volume/Cap:	0.00	0.00	0.00	0.62	0.00	0.03	0.62	0.62	0.00	0.00	0.59	0.59	
Delay/Veh:	0.0	0.0	0.0	17.3	0.0	12.1	10.7	10.7	0.0	0.0	10.2	10.2	
User DelAdj:	1.00	1.00	1.00	1.00	1.00	1.00	1.00	1.00	1.00	1.00	1.00	1.00	
AdjDel/Veh:	0.0	0.0	0.0	17.3	0.0	12.1	10.7	10.7	0.0	0.0	10.2	10.2	
LOS by Move:	A	A	A	B	A	B	B	B	A	A	B	B	
HCM2k95thQ:	0	0	0	14	0	1	15	15	0	0	14	14	

Note: Queue reported is the number of cars per lane.

BART Phase II Extension Project

Level Of Service Computation Report
 2000 HCM Operations (Future Volume Alternative)
 AM - Existing Plus Project Conditions

Intersection #3613: JULIAN/24TH

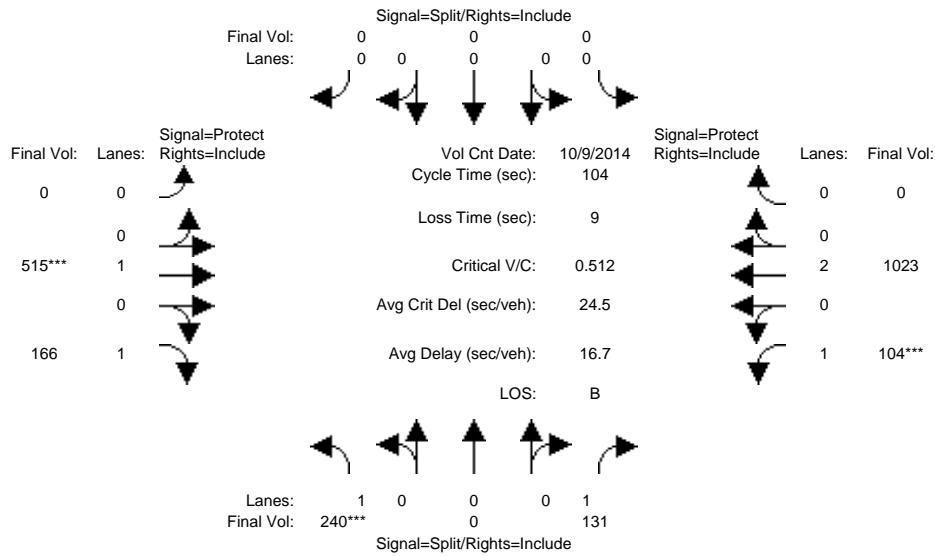

Approach:	North Bound			South Bound			East Bound			West Bound		
	L	T	R	L	T	R	L	T	R	L	T	R
Min. Green:	10	0	10	0	0	0	0	10	10	7	10	0
Y+R:	4.0	4.0	4.0	4.0	4.0	4.0	4.0	4.0	4.0	4.0	4.0	4.0

Volume Module:	>> Count Date: 9 Oct 2014 <<											
Base Vol:	240	0	131	0	0	0	0	515	166	104	1023	0
Growth Adj:	1.00	1.00	1.00	1.00	1.00	1.00	1.00	1.00	1.00	1.00	1.00	1.00
Initial Bse:	240	0	131	0	0	0	0	515	166	104	1023	0
Added Vol:	0	0	0	0	0	0	0	0	0	0	0	0
PasserByVol:	0	0	0	0	0	0	0	0	0	0	0	0
Initial Fut:	240	0	131	0	0	0	0	515	166	104	1023	0
User Adj:	1.00	1.00	1.00	1.00	1.00	1.00	1.00	1.00	1.00	1.00	1.00	1.00
PHF Adj:	1.00	1.00	1.00	1.00	1.00	1.00	1.00	1.00	1.00	1.00	1.00	1.00
PHF Volume:	240	0	131	0	0	0	0	515	166	104	1023	0
Reduct Vol:	0	0	0	0	0	0	0	0	0	0	0	0
Reduced Vol:	240	0	131	0	0	0	0	515	166	104	1023	0
PCE Adj:	1.00	1.00	1.00	1.00	1.00	1.00	1.00	1.00	1.00	1.00	1.00	1.00
MLF Adj:	1.00	1.00	1.00	1.00	1.00	1.00	1.00	1.00	1.00	1.00	1.00	1.00
FinalVolume:	240	0	131	0	0	0	0	515	166	104	1023	0

Saturation Flow Module:												
Sat/Lane:	1900	1900	1900	1900	1900	1900	1900	1900	1900	1900	1900	1900
Adjustment:	0.92	1.00	0.92	0.92	1.00	0.92	0.92	1.00	0.92	0.92	1.00	0.92
Lanes:	1.00	0.00	1.00	0.00	0.00	0.00	0.00	1.00	1.00	1.00	2.00	0.00
Final Sat.:	1750	0	1750	0	0	0	0	1900	1750	1750	3800	0

Capacity Analysis Module:												
Vol/Sat:	0.14	0.00	0.07	0.00	0.00	0.00	0.00	0.27	0.09	0.06	0.27	0.00
Crit Moves:	****							****		****		
Green Time:	27.9	0.0	27.9	0.0	0.0	0.0	0.0	55.1	55.1	12.1	67.1	0.0
Volume/Cap:	0.51	0.00	0.28	0.00	0.00	0.00	0.00	0.51	0.18	0.51	0.42	0.00
Delay/Veh:	33.3	0.0	30.5	0.0	0.0	0.0	0.0	16.2	12.8	45.4	9.1	0.0
User DelAdj:	1.00	1.00	1.00	1.00	1.00	1.00	1.00	1.00	1.00	1.00	1.00	1.00
AdjDel/Veh:	33.3	0.0	30.5	0.0	0.0	0.0	0.0	16.2	12.8	45.4	9.1	0.0
LOS by Move:	C	A	C	A	A	A	A	B	B	D	A	A
HCM2k95thQ:	14	0	7	0	0	0	0	19	6	8	15	0

Note: Queue reported is the number of cars per lane.

BART Phase II Extension Project

Level Of Service Computation Report
 2000 HCM Operations (Future Volume Alternative)
 PM - Existing Plus Project Conditions

Intersection #3613: JULIAN/24TH

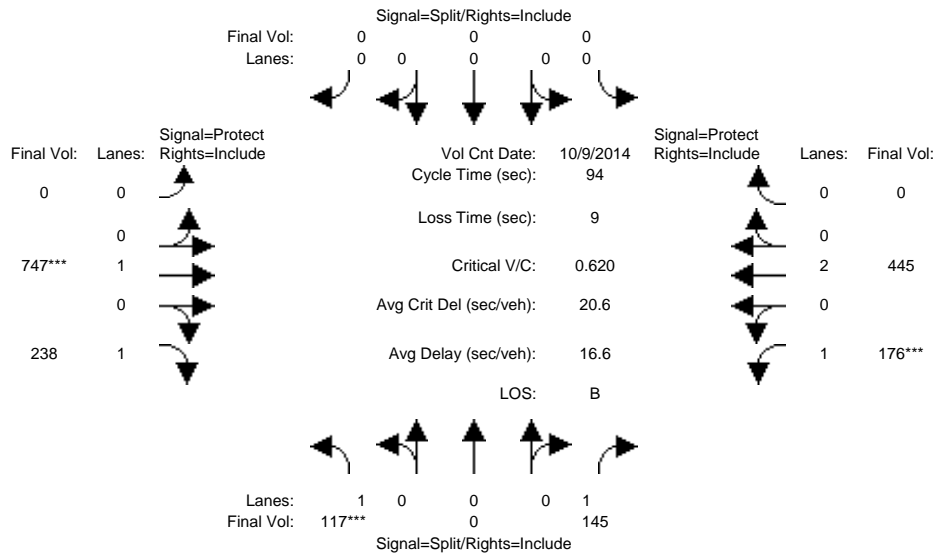

Approach:	North Bound			South Bound			East Bound			West Bound		
	L	T	R	L	T	R	L	T	R	L	T	R
Min. Green:	10	0	10	0	0	0	0	10	10	7	10	0
Y+R:	4.0	4.0	4.0	4.0	4.0	4.0	4.0	4.0	4.0	4.0	4.0	4.0
Volume Module: >> Count Date: 9 Oct 2014 <<												
Base Vol:	117	0	145	0	0	0	0	747	238	176	445	0
Growth Adj:	1.00	1.00	1.00	1.00	1.00	1.00	1.00	1.00	1.00	1.00	1.00	1.00
Initial Bse:	117	0	145	0	0	0	0	747	238	176	445	0
Added Vol:	0	0	0	0	0	0	0	0	0	0	0	0
PasserByVol:	0	0	0	0	0	0	0	0	0	0	0	0
Initial Fut:	117	0	145	0	0	0	0	747	238	176	445	0
User Adj:	1.00	1.00	1.00	1.00	1.00	1.00	1.00	1.00	1.00	1.00	1.00	1.00
PHF Adj:	1.00	1.00	1.00	1.00	1.00	1.00	1.00	1.00	1.00	1.00	1.00	1.00
PHF Volume:	117	0	145	0	0	0	0	747	238	176	445	0
Reduct Vol:	0	0	0	0	0	0	0	0	0	0	0	0
Reduced Vol:	117	0	145	0	0	0	0	747	238	176	445	0
PCE Adj:	1.00	1.00	1.00	1.00	1.00	1.00	1.00	1.00	1.00	1.00	1.00	1.00
MLF Adj:	1.00	1.00	1.00	1.00	1.00	1.00	1.00	1.00	1.00	1.00	1.00	1.00
FinalVolume:	117	0	145	0	0	0	0	747	238	176	445	0
Saturation Flow Module:												
Sat/Lane:	1900	1900	1900	1900	1900	1900	1900	1900	1900	1900	1900	1900
Adjustment:	0.92	1.00	0.92	0.92	1.00	0.92	0.92	1.00	0.92	0.92	1.00	0.92
Lanes:	1.00	0.00	1.00	0.00	0.00	0.00	0.00	1.00	1.00	1.00	2.00	0.00
Final Sat.:	1750	0	1750	0	0	0	0	1900	1750	1750	3800	0
Capacity Analysis Module:												
Vol/Sat:	0.07	0.00	0.08	0.00	0.00	0.00	0.00	0.39	0.14	0.10	0.12	0.00
Crit Moves:	****							****		****		
Green Time:	12.2	0.0	12.2	0.0	0.0	0.0	0.0	58.0	58.0	14.8	72.8	0.0
Volume/Cap:	0.51	0.00	0.64	0.00	0.00	0.00	0.00	0.64	0.22	0.64	0.15	0.00
Delay/Veh:	40.1	0.0	44.7	0.0	0.0	0.0	0.0	12.6	8.1	42.0	2.7	0.0
User DelAdj:	1.00	1.00	1.00	1.00	1.00	1.00	1.00	1.00	1.00	1.00	1.00	1.00
AdjDel/Veh:	40.1	0.0	44.7	0.0	0.0	0.0	0.0	12.6	8.1	42.0	2.7	0.0
LOS by Move:	D	A	D	A	A	A	A	B	A	D	A	A
HCM2k95thQ:	8	0	11	0	0	0	0	24	6	12	3	0

Note: Queue reported is the number of cars per lane.

BART Phase II Extension Project

Level Of Service Computation Report
 2000 HCM Operations (Future Volume Alternative)
 AM - Existing Plus Project Conditions

Intersection #3625: KING/McKEE

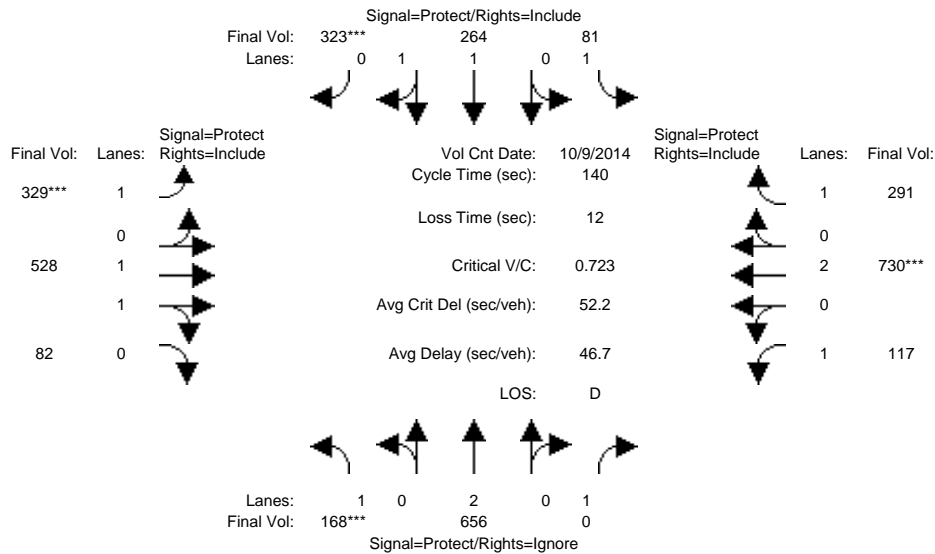

Approach:	North Bound			South Bound			East Bound			West Bound		
	L	T	R	L	T	R	L	T	R	L	T	R
Min. Green:	7	10	10	7	10	10	7	10	10	7	10	10
Y+R:	4.0	4.0	4.0	4.0	4.0	4.0	4.0	4.0	4.0	4.0	4.0	4.0
Volume Module: >> Count Date: 9 Oct 2014 <<												
Base Vol:	168	656	161	81	264	323	329	528	82	117	730	291
Growth Adj:	1.00	1.00	1.00	1.00	1.00	1.00	1.00	1.00	1.00	1.00	1.00	1.00
Initial Bse:	168	656	161	81	264	323	329	528	82	117	730	291
Added Vol:	0	0	0	0	0	0	0	0	0	0	0	0
PasserByVol:	0	0	0	0	0	0	0	0	0	0	0	0
Initial Fut:	168	656	161	81	264	323	329	528	82	117	730	291
User Adj:	1.00	1.00	0.00	1.00	1.00	1.00	1.00	1.00	1.00	1.00	1.00	1.00
PHF Adj:	1.00	1.00	0.00	1.00	1.00	1.00	1.00	1.00	1.00	1.00	1.00	1.00
PHF Volume:	168	656	0	81	264	323	329	528	82	117	730	291
Reduct Vol:	0	0	0	0	0	0	0	0	0	0	0	0
Reduced Vol:	168	656	0	81	264	323	329	528	82	117	730	291
PCE Adj:	1.00	1.00	0.00	1.00	1.00	1.00	1.00	1.00	1.00	1.00	1.00	1.00
MLF Adj:	1.00	1.00	0.00	1.00	1.00	1.00	1.00	1.00	1.00	1.00	1.00	1.00
FinalVolume:	168	656	0	81	264	323	329	528	82	117	730	291
Saturation Flow Module:												
Sat/Lane:	1900	1900	1900	1900	1900	1900	1900	1900	1900	1900	1900	1900
Adjustment:	0.92	1.00	0.92	0.92	1.00	0.92	0.92	0.98	0.95	0.92	1.00	0.92
Lanes:	1.00	2.00	1.00	1.00	1.00	1.00	1.00	1.72	0.28	1.00	2.00	1.00
Final Sat.:	1750	3800	1750	1750	1900	1750	1750	3202	497	1750	3800	1750
Capacity Analysis Module:												
Vol/Sat:	0.10	0.17	0.00	0.05	0.14	0.18	0.19	0.16	0.16	0.07	0.19	0.17
Crit Moves:	****					****	****				****	
Green Time:	18.6	42.2	0.0	12.2	35.8	35.8	36.4	52.4	52.4	21.2	37.2	37.2
Volume/Cap:	0.72	0.57	0.00	0.53	0.54	0.72	0.72	0.44	0.44	0.44	0.72	0.63
Delay/Veh:	68.9	42.0	0.0	64.7	45.6	50.8	52.8	33.0	33.0	55.1	49.3	47.9
User DelAdj:	1.00	1.00	1.00	1.00	1.00	1.00	1.00	1.00	1.00	1.00	1.00	1.00
AdjDel/Veh:	68.9	42.0	0.0	64.7	45.6	50.8	52.8	33.0	33.0	55.1	49.3	47.9
LOS by Move:	E	D	A	E	D	D	D	C	C	E	D	D
HCM2k95thQ:	15	21	0	7	18	25	25	18	18	9	25	21

Note: Queue reported is the number of cars per lane.

BART Phase II Extension Project

Level Of Service Computation Report
 2000 HCM Operations (Future Volume Alternative)
 PM - Existing Plus Project Conditions

Intersection #3625: KING/McKEE

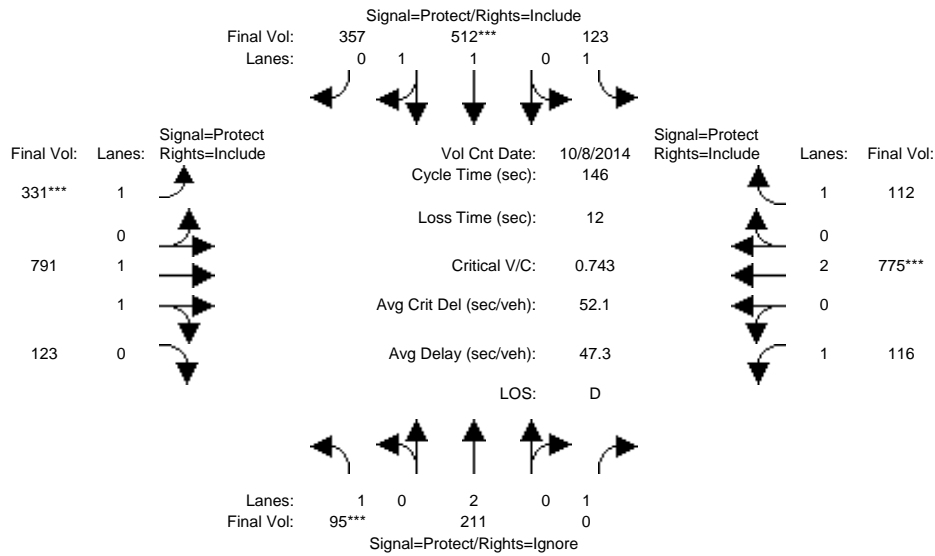

Approach:	North Bound			South Bound			East Bound			West Bound		
	L	T	R	L	T	R	L	T	R	L	T	R
Min. Green:	7	10	10	7	10	10	7	10	10	7	10	10
Y+R:	4.0	4.0	4.0	4.0	4.0	4.0	4.0	4.0	4.0	4.0	4.0	4.0
Volume Module: >> Count Date: 8 Oct 2014 <<												
Base Vol:	95	211	98	123	512	357	331	791	123	116	775	112
Growth Adj:	1.00	1.00	1.00	1.00	1.00	1.00	1.00	1.00	1.00	1.00	1.00	1.00
Initial Bse:	95	211	98	123	512	357	331	791	123	116	775	112
Added Vol:	0	0	0	0	0	0	0	0	0	0	0	0
PasserByVol:	0	0	0	0	0	0	0	0	0	0	0	0
Initial Fut:	95	211	98	123	512	357	331	791	123	116	775	112
User Adj:	1.00	1.00	0.00	1.00	1.00	1.00	1.00	1.00	1.00	1.00	1.00	1.00
PHF Adj:	1.00	1.00	0.00	1.00	1.00	1.00	1.00	1.00	1.00	1.00	1.00	1.00
PHF Volume:	95	211	0	123	512	357	331	791	123	116	775	112
Reduct Vol:	0	0	0	0	0	0	0	0	0	0	0	0
Reduced Vol:	95	211	0	123	512	357	331	791	123	116	775	112
PCE Adj:	1.00	1.00	0.00	1.00	1.00	1.00	1.00	1.00	1.00	1.00	1.00	1.00
MLF Adj:	1.00	1.00	0.00	1.00	1.00	1.00	1.00	1.00	1.00	1.00	1.00	1.00
FinalVolume:	95	211	0	123	512	357	331	791	123	116	775	112
Saturation Flow Module:												
Sat/Lane:	1900	1900	1900	1900	1900	1900	1900	1900	1900	1900	1900	1900
Adjustment:	0.92	1.00	0.92	0.92	0.99	0.95	0.92	0.98	0.95	0.92	1.00	0.92
Lanes:	1.00	2.00	1.00	1.00	1.16	0.84	1.00	1.72	0.28	1.00	2.00	1.00
Final Sat.:	1750	3800	1750	1750	2179	1519	1750	3202	498	1750	3800	1750
Capacity Analysis Module:												
Vol/Sat:	0.05	0.06	0.00	0.07	0.23	0.23	0.19	0.25	0.25	0.07	0.20	0.06
Crit Moves:	****			****			****			****		
Green Time:	10.7	28.0	0.0	28.8	46.1	46.1	37.1	60.9	60.9	16.3	40.1	40.1
Volume/Cap:	0.74	0.29	0.00	0.36	0.74	0.74	0.74	0.59	0.59	0.59	0.74	0.23
Delay/Veh:	87.1	50.7	0.0	51.3	47.3	47.3	56.7	33.6	33.6	66.5	51.2	41.3
User DelAdj:	1.00	1.00	1.00	1.00	1.00	1.00	1.00	1.00	1.00	1.00	1.00	1.00
AdjDel/Veh:	87.1	50.7	0.0	51.3	47.3	47.3	56.7	33.6	33.6	66.5	51.2	41.3
LOS by Move:	F	D	A	D	D	D	E	C	C	E	D	D
HCM2k95thQ:	9	8	0	10	31	31	26	28	28	10	28	8

Note: Queue reported is the number of cars per lane.

BART Phase II Extension Project

Level Of Service Computation Report
2000 HCM Operations (Future Volume Alternative)
AM - Existing Plus Project Conditions

Intersection #3683: McLAUGHLIN/STORY

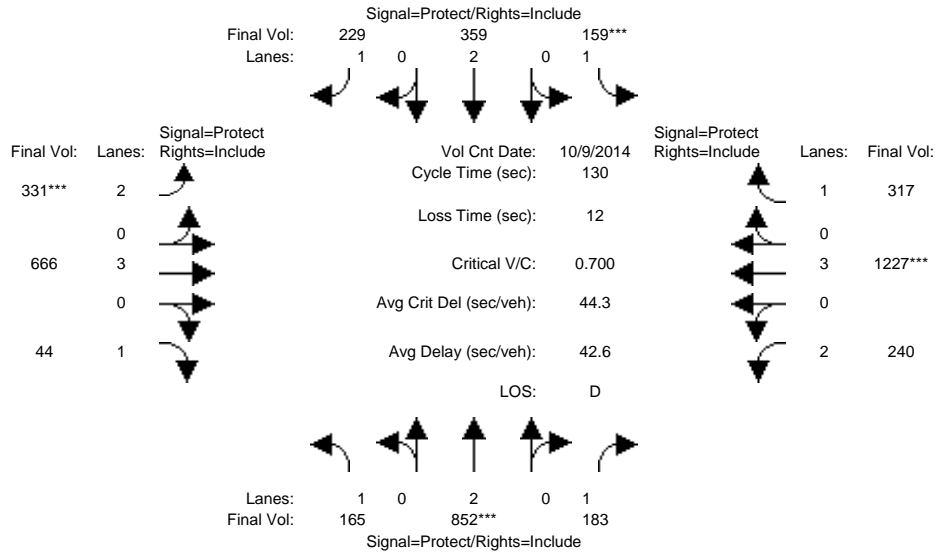

Approach:	North Bound			South Bound			East Bound			West Bound		
	L	T	R	L	T	R	L	T	R	L	T	R
Min. Green:	7	10	10	7	10	10	7	10	10	7	10	10
Y+R:	4.0	4.0	4.0	4.0	4.0	4.0	4.0	4.0	4.0	4.0	4.0	4.0
Volume Module: >> Count Date: 9 Oct 2014 <<												
Base Vol:	165	852	183	159	359	229	331	666	44	240	1227	317
Growth Adj:	1.00	1.00	1.00	1.00	1.00	1.00	1.00	1.00	1.00	1.00	1.00	1.00
Initial Bse:	165	852	183	159	359	229	331	666	44	240	1227	317
Added Vol:	0	0	0	0	0	0	0	0	0	0	0	0
PasserByVol:	0	0	0	0	0	0	0	0	0	0	0	0
Initial Fut:	165	852	183	159	359	229	331	666	44	240	1227	317
User Adj:	1.00	1.00	1.00	1.00	1.00	1.00	1.00	1.00	1.00	1.00	1.00	1.00
PHF Adj:	1.00	1.00	1.00	1.00	1.00	1.00	1.00	1.00	1.00	1.00	1.00	1.00
PHF Volume:	165	852	183	159	359	229	331	666	44	240	1227	317
Reduct Vol:	0	0	0	0	0	0	0	0	0	0	0	0
Reduced Vol:	165	852	183	159	359	229	331	666	44	240	1227	317
PCE Adj:	1.00	1.00	1.00	1.00	1.00	1.00	1.00	1.00	1.00	1.00	1.00	1.00
MLF Adj:	1.00	1.00	1.00	1.00	1.00	1.00	1.00	1.00	1.00	1.00	1.00	1.00
Final Volume:	165	852	183	159	359	229	331	666	44	240	1227	317
Saturation Flow Module:												
Sat/Lane:	1900	1900	1900	1900	1900	1900	1900	1900	1900	1900	1900	1900
Adjustment:	0.92	1.00	0.92	0.92	1.00	0.92	0.83	1.00	0.92	0.83	1.00	0.92
Lanes:	1.00	2.00	1.00	1.00	2.00	1.00	2.00	3.00	1.00	2.00	3.00	1.00
Final Sat.:	1750	3800	1750	1750	3800	1750	3150	5700	1750	3150	5700	1750
Capacity Analysis Module:												
Vol/Sat:	0.09	0.22	0.10	0.09	0.09	0.13	0.11	0.12	0.03	0.08	0.22	0.18
Crit Moves:	****	****	****	****	****	****	****	****	****	****	****	****
Green Time:	24.5	41.6	41.6	16.9	34.0	34.0	19.5	36.0	36.0	23.5	40.0	40.0
Volume/Cap:	0.50	0.70	0.33	0.70	0.36	0.50	0.70	0.42	0.09	0.42	0.70	0.59
Delay/Veh:	48.5	40.5	33.9	63.5	39.4	41.6	57.1	38.7	34.9	47.7	41.0	39.8
User DelAdj:	1.00	1.00	1.00	1.00	1.00	1.00	1.00	1.00	1.00	1.00	1.00	1.00
AdjDel/Veh:	48.5	40.5	33.9	63.5	39.4	41.6	57.1	38.7	34.9	47.7	41.0	39.8
LOS by Move:	D	D	C	E	D	D	E	D	C	D	D	D
HCM2k95thQ:	13	27	11	13	11	15	16	14	3	10	25	21

Note: Queue reported is the number of cars per lane.

BART Phase II Extension Project

Level Of Service Computation Report
2000 HCM Operations (Future Volume Alternative)
PM - Existing Plus Project Conditions

Intersection #3683: McLAUGHLIN/STORY

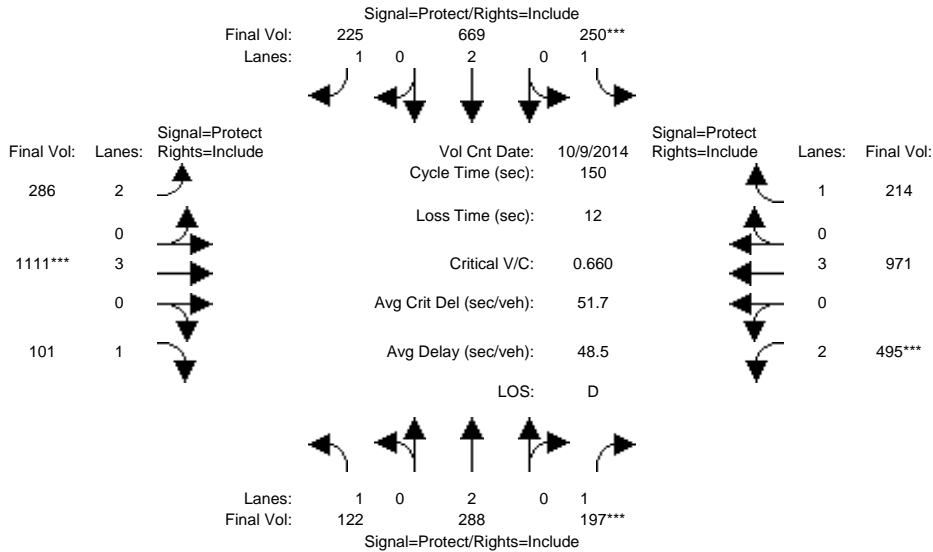

Approach:	North Bound			South Bound			East Bound			West Bound		
	L	T	R	L	T	R	L	T	R	L	T	R
Min. Green:	7	10	10	7	10	10	7	10	10	7	10	10
Y+R:	4.0	4.0	4.0	4.0	4.0	4.0	4.0	4.0	4.0	4.0	4.0	4.0
Volume Module: >> Count Date: 9 Oct 2014 <<												
Base Vol:	122	288	197	250	669	225	286	1111	101	495	971	214
Growth Adj:	1.00	1.00	1.00	1.00	1.00	1.00	1.00	1.00	1.00	1.00	1.00	1.00
Initial Bse:	122	288	197	250	669	225	286	1111	101	495	971	214
Added Vol:	0	0	0	0	0	0	0	0	0	0	0	0
PasserByVol:	0	0	0	0	0	0	0	0	0	0	0	0
Initial Fut:	122	288	197	250	669	225	286	1111	101	495	971	214
User Adj:	1.00	1.00	1.00	1.00	1.00	1.00	1.00	1.00	1.00	1.00	1.00	1.00
PHF Adj:	1.00	1.00	1.00	1.00	1.00	1.00	1.00	1.00	1.00	1.00	1.00	1.00
PHF Volume:	122	288	197	250	669	225	286	1111	101	495	971	214
Reduct Vol:	0	0	0	0	0	0	0	0	0	0	0	0
Reduced Vol:	122	288	197	250	669	225	286	1111	101	495	971	214
PCE Adj:	1.00	1.00	1.00	1.00	1.00	1.00	1.00	1.00	1.00	1.00	1.00	1.00
MLF Adj:	1.00	1.00	1.00	1.00	1.00	1.00	1.00	1.00	1.00	1.00	1.00	1.00
FinalVolume:	122	288	197	250	669	225	286	1111	101	495	971	214
Saturation Flow Module:												
Sat/Lane:	1900	1900	1900	1900	1900	1900	1900	1900	1900	1900	1900	1900
Adjustment:	0.92	1.00	0.92	0.92	1.00	0.92	0.83	1.00	0.92	0.83	1.00	0.92
Lanes:	1.00	2.00	1.00	1.00	2.00	1.00	2.00	3.00	1.00	2.00	3.00	1.00
Final Sat.:	1750	3800	1750	1750	3800	1750	3150	5700	1750	3150	5700	1750
Capacity Analysis Module:												
Vol/Sat:	0.07	0.08	0.11	0.14	0.18	0.13	0.09	0.19	0.06	0.16	0.17	0.12
Crit Moves:			****	****				****		****		
Green Time:	16.5	25.6	25.6	32.5	41.6	41.6	27.8	44.3	44.3	35.7	52.2	52.2
Volume/Cap:	0.64	0.44	0.66	0.66	0.64	0.46	0.49	0.66	0.20	0.66	0.49	0.35
Delay/Veh:	70.7	56.3	63.6	58.0	48.9	45.7	55.4	47.3	39.7	53.9	38.6	36.7
User DelAdj:	1.00	1.00	1.00	1.00	1.00	1.00	1.00	1.00	1.00	1.00	1.00	1.00
AdjDel/Veh:	70.7	56.3	63.6	58.0	48.9	45.7	55.4	47.3	39.7	53.9	38.6	36.7
LOS by Move:	E	E	E	E	D	D	E	D	D	D	D	D
HCM2k95thQ:	13	12	19	21	24	17	14	27	7	22	21	14

Note: Queue reported is the number of cars per lane.

BART Phase II Extension Project

Level Of Service Computation Report
2000 HCM Operations (Future Volume Alternative)
AM - Existing Plus Project Conditions

Intersection #3762: SAN ANTONIO/24TH

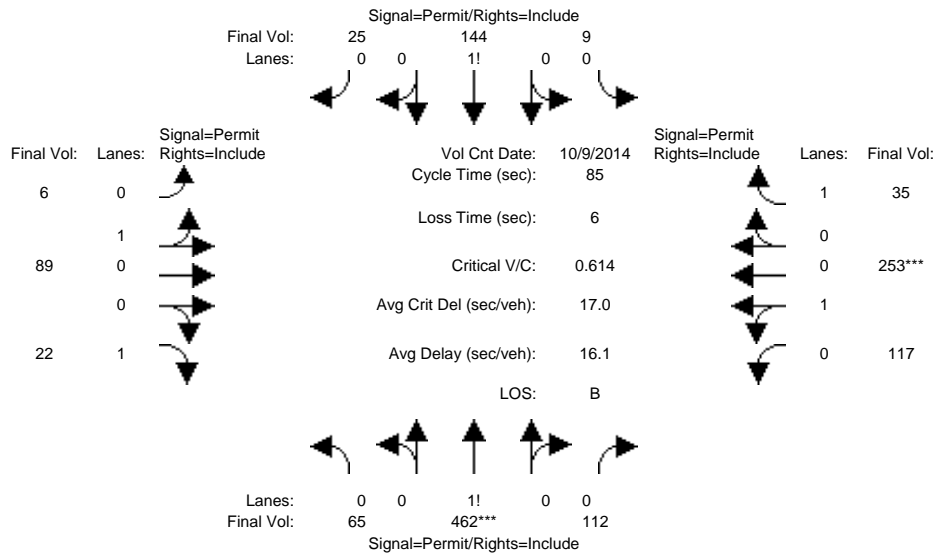

Approach:	North Bound			South Bound			East Bound			West Bound		
	L	T	R	L	T	R	L	T	R	L	T	R
Min. Green:	10	10	10	10	10	10	10	10	10	10	10	10
Y+R:	4.0	4.0	4.0	4.0	4.0	4.0	4.0	4.0	4.0	4.0	4.0	4.0

Volume Module:	>>	Count	Date:	9 Oct 2014	<<							
Base Vol:	65	462	112	9	144	25	6	89	22	117	253	35
Growth Adj:	1.00	1.00	1.00	1.00	1.00	1.00	1.00	1.00	1.00	1.00	1.00	1.00
Initial Bse:	65	462	112	9	144	25	6	89	22	117	253	35
Added Vol:	0	0	0	0	0	0	0	0	0	0	0	0
PasserByVol:	0	0	0	0	0	0	0	0	0	0	0	0
Initial Fut:	65	462	112	9	144	25	6	89	22	117	253	35
User Adj:	1.00	1.00	1.00	1.00	1.00	1.00	1.00	1.00	1.00	1.00	1.00	1.00
PHF Adj:	1.00	1.00	1.00	1.00	1.00	1.00	1.00	1.00	1.00	1.00	1.00	1.00
PHF Volume:	65	462	112	9	144	25	6	89	22	117	253	35
Reduct Vol:	0	0	0	0	0	0	0	0	0	0	0	0
Reduced Vol:	65	462	112	9	144	25	6	89	22	117	253	35
PCE Adj:	1.00	1.00	1.00	1.00	1.00	1.00	1.00	1.00	1.00	1.00	1.00	1.00
MLF Adj:	1.00	1.00	1.00	1.00	1.00	1.00	1.00	1.00	1.00	1.00	1.00	1.00
FinalVolume:	65	462	112	9	144	25	6	89	22	117	253	35

Saturation Flow Module:	Sat/Lane:	1900	1900	1900	1900	1900	1900	1900	1900	1900	1900	1900
Adjustment:	0.92	0.92	0.92	0.92	0.92	0.92	0.95	0.95	0.92	0.95	0.95	0.92
Lanes:	0.10	0.72	0.18	0.05	0.81	0.14	0.06	0.94	1.00	0.32	0.68	1.00
Final Sat.:	178	1265	307	88	1416	246	114	1686	1750	569	1231	1750

Capacity Analysis Module:	Vol/Sat:	0.37	0.37	0.37	0.10	0.10	0.10	0.05	0.05	0.01	0.21	0.21	0.02
Crit Moves:	****	****	****	****	****	****	****	****	****	****	****	****	****
Green Time:	50.5	50.5	50.5	50.5	50.5	50.5	28.5	28.5	28.5	28.5	28.5	28.5	28.5
Volume/Cap:	0.61	0.61	0.61	0.17	0.17	0.17	0.16	0.16	0.04	0.61	0.61	0.06	
Delay/Veh:	12.1	12.1	12.1	7.9	7.9	7.9	20.0	20.0	19.1	25.6	25.6	19.2	
User DelAdj:	1.00	1.00	1.00	1.00	1.00	1.00	1.00	1.00	1.00	1.00	1.00	1.00	
AdjDel/Veh:	12.1	12.1	12.1	7.9	7.9	7.9	20.0	20.0	19.1	25.6	25.6	19.2	
LOS by Move:	B	B	B	A	A	A	B	B	B	C	C	B	
HCM2k95thQ:	21	21	21	5	5	5	4	4	1	16	16	1	

Note: Queue reported is the number of cars per lane.

BART Phase II Extension Project

Level Of Service Computation Report
2000 HCM Operations (Future Volume Alternative)
PM - Existing Plus Project Conditions

Intersection #3762: SAN ANTONIO/24TH

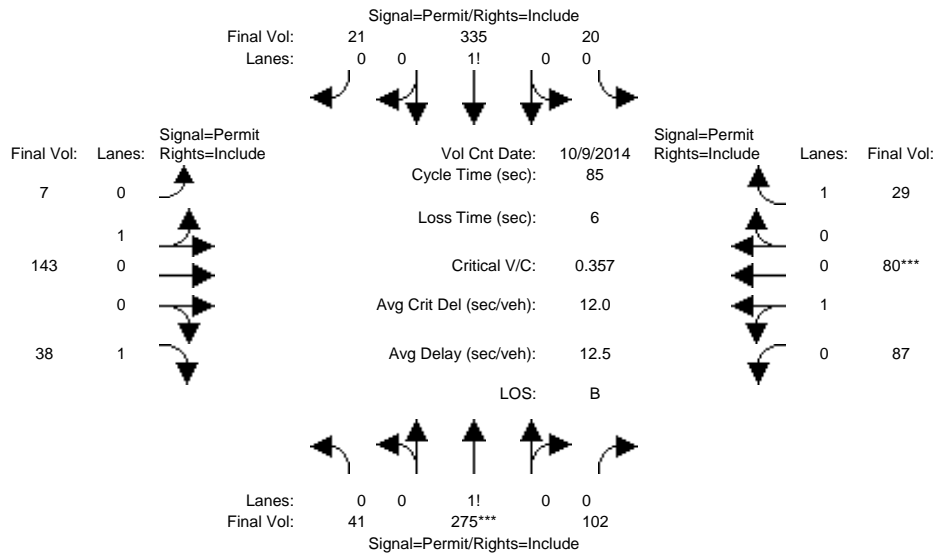

Approach:	North Bound			South Bound			East Bound			West Bound		
	L	T	R	L	T	R	L	T	R	L	T	R
Min. Green:	10	10	10	10	10	10	10	10	10	10	10	10
Y+R:	4.0	4.0	4.0	4.0	4.0	4.0	4.0	4.0	4.0	4.0	4.0	4.0
Volume Module: >> Count Date: 9 Oct 2014 <<												
Base Vol:	41	275	102	20	335	21	7	143	38	87	80	29
Growth Adj:	1.00	1.00	1.00	1.00	1.00	1.00	1.00	1.00	1.00	1.00	1.00	1.00
Initial Bse:	41	275	102	20	335	21	7	143	38	87	80	29
Added Vol:	0	0	0	0	0	0	0	0	0	0	0	0
PasserByVol:	0	0	0	0	0	0	0	0	0	0	0	0
Initial Fut:	41	275	102	20	335	21	7	143	38	87	80	29
User Adj:	1.00	1.00	1.00	1.00	1.00	1.00	1.00	1.00	1.00	1.00	1.00	1.00
PHF Adj:	1.00	1.00	1.00	1.00	1.00	1.00	1.00	1.00	1.00	1.00	1.00	1.00
PHF Volume:	41	275	102	20	335	21	7	143	38	87	80	29
Reduct Vol:	0	0	0	0	0	0	0	0	0	0	0	0
Reduced Vol:	41	275	102	20	335	21	7	143	38	87	80	29
PCE Adj:	1.00	1.00	1.00	1.00	1.00	1.00	1.00	1.00	1.00	1.00	1.00	1.00
MLF Adj:	1.00	1.00	1.00	1.00	1.00	1.00	1.00	1.00	1.00	1.00	1.00	1.00
FinalVolume:	41	275	102	20	335	21	7	143	38	87	80	29
Saturation Flow Module:												
Sat/Lane:	1900	1900	1900	1900	1900	1900	1900	1900	1900	1900	1900	1900
Adjustment:	0.92	0.92	0.92	0.92	0.92	0.92	0.95	0.95	0.92	0.95	0.95	0.92
Lanes:	0.10	0.66	0.24	0.05	0.89	0.06	0.05	0.95	1.00	0.52	0.48	1.00
Final Sat.:	172	1151	427	93	1559	98	84	1716	1750	938	862	1750
Capacity Analysis Module:												
Vol/Sat:	0.24	0.24	0.24	0.21	0.21	0.21	0.08	0.08	0.02	0.09	0.09	0.02
Crit Moves:	****									****		
Green Time:	56.9	56.9	56.9	56.9	56.9	56.9	22.1	22.1	22.1	22.1	22.1	22.1
Volume/Cap:	0.36	0.36	0.36	0.32	0.32	0.32	0.32	0.32	0.08	0.36	0.36	0.06
Delay/Veh:	6.3	6.3	6.3	6.1	6.1	6.1	25.8	25.8	23.9	26.1	26.1	23.7
User DelAdj:	1.00	1.00	1.00	1.00	1.00	1.00	1.00	1.00	1.00	1.00	1.00	1.00
AdjDel/Veh:	6.3	6.3	6.3	6.1	6.1	6.1	25.8	25.8	23.9	26.1	26.1	23.7
LOS by Move:	A	A	A	A	A	A	C	C	C	C	C	C
HCM2k95thQ:	10	10	10	9	9	9	7	7	2	7	7	1

Note: Queue reported is the number of cars per lane.

BART Phase II Extension Project

Level Of Service Computation Report
2000 HCM Operations (Future Volume Alternative)
AM - Existing Plus Project Conditions

Intersection #3783: SANTA CLARA/17TH

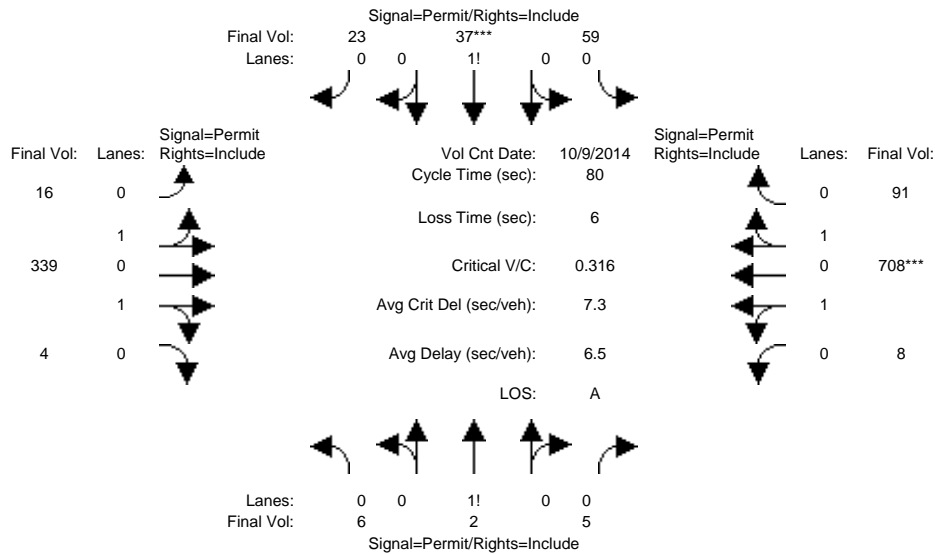

Approach:	North Bound			South Bound			East Bound			West Bound		
	L	T	R	L	T	R	L	T	R	L	T	R
Min. Green:	10	10	10	10	10	10	10	10	10	10	10	10
Y+R:	4.0	4.0	4.0	4.0	4.0	4.0	4.0	4.0	4.0	4.0	4.0	4.0
Volume Module: >> Count Date: 9 Oct 2014 <<												
Base Vol:	6	2	5	59	37	23	16	339	4	8	708	91
Growth Adj:	1.00	1.00	1.00	1.00	1.00	1.00	1.00	1.00	1.00	1.00	1.00	1.00
Initial Bse:	6	2	5	59	37	23	16	339	4	8	708	91
Added Vol:	0	0	0	0	0	0	0	0	0	0	0	0
PasserByVol:	0	0	0	0	0	0	0	0	0	0	0	0
Initial Fut:	6	2	5	59	37	23	16	339	4	8	708	91
User Adj:	1.00	1.00	1.00	1.00	1.00	1.00	1.00	1.00	1.00	1.00	1.00	1.00
PHF Adj:	1.00	1.00	1.00	1.00	1.00	1.00	1.00	1.00	1.00	1.00	1.00	1.00
PHF Volume:	6	2	5	59	37	23	16	339	4	8	708	91
Reduct Vol:	0	0	0	0	0	0	0	0	0	0	0	0
Reduced Vol:	6	2	5	59	37	23	16	339	4	8	708	91
PCE Adj:	1.00	1.00	1.00	1.00	1.00	1.00	1.00	1.00	1.00	1.00	1.00	1.00
MLF Adj:	1.00	1.00	1.00	1.00	1.00	1.00	1.00	1.00	1.00	1.00	1.00	1.00
Final Volume:	6	2	5	59	37	23	16	339	4	8	708	91
Saturation Flow Module:												
Sat/Lane:	1900	1900	1900	1900	1900	1900	1900	1900	1900	1900	1900	1900
Adjustment:	0.92	0.92	0.92	0.92	0.92	0.92	0.95	0.95	0.95	0.95	0.95	0.95
Lanes:	0.47	0.15	0.38	0.50	0.31	0.19	0.09	1.89	0.02	0.02	1.75	0.23
Final Sat.:	808	269	673	868	544	338	160	3399	40	36	3158	406
Capacity Analysis Module:												
Vol/Sat:	0.01	0.01	0.01	0.07	0.07	0.07	0.10	0.10	0.10	0.22	0.22	0.22
Crit Moves:				****						****		
Green Time:	17.2	17.2	17.2	17.2	17.2	17.2	56.8	56.8	56.8	56.8	56.8	56.8
Volume/Cap:	0.03	0.03	0.03	0.32	0.32	0.32	0.14	0.14	0.14	0.32	0.32	0.32
Delay/Veh:	24.9	24.9	24.9	26.9	26.9	26.9	3.8	3.8	3.8	4.4	4.4	4.4
User DelAdj:	1.00	1.00	1.00	1.00	1.00	1.00	1.00	1.00	1.00	1.00	1.00	1.00
AdjDel/Veh:	24.9	24.9	24.9	26.9	26.9	26.9	3.8	3.8	3.8	4.4	4.4	4.4
LOS by Move:	C	C	C	C	C	C	A	A	A	A	A	A
HCM2k95thQ:	1	1	1	6	6	6	3	3	3	8	8	8

Note: Queue reported is the number of cars per lane.

BART Phase II Extension Project

Level Of Service Computation Report
 2000 HCM Operations (Future Volume Alternative)
 PM - Existing Plus Project Conditions

Intersection #3783: SANTA CLARA/17TH

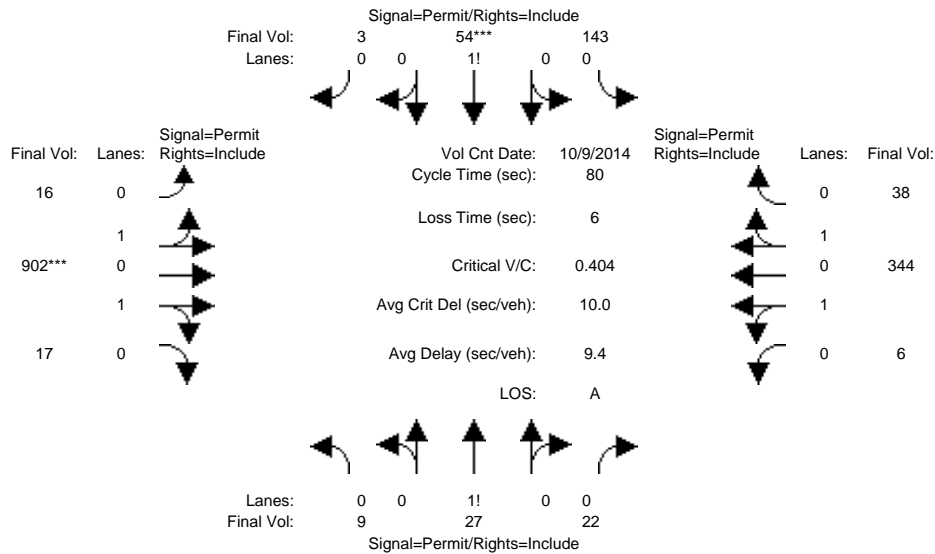

Approach:	North Bound			South Bound			East Bound			West Bound		
	L	T	R	L	T	R	L	T	R	L	T	R
Min. Green:	10	10	10	10	10	10	10	10	10	10	10	10
Y+R:	4.0	4.0	4.0	4.0	4.0	4.0	4.0	4.0	4.0	4.0	4.0	4.0

Volume Module:	>> Count Date: 9 Oct 2014 <<											
Base Vol:	9	27	22	143	54	3	16	902	17	6	344	38
Growth Adj:	1.00	1.00	1.00	1.00	1.00	1.00	1.00	1.00	1.00	1.00	1.00	1.00
Initial Bse:	9	27	22	143	54	3	16	902	17	6	344	38
Added Vol:	0	0	0	0	0	0	0	0	0	0	0	0
PasserByVol:	0	0	0	0	0	0	0	0	0	0	0	0
Initial Fut:	9	27	22	143	54	3	16	902	17	6	344	38
User Adj:	1.00	1.00	1.00	1.00	1.00	1.00	1.00	1.00	1.00	1.00	1.00	1.00
PHF Adj:	1.00	1.00	1.00	1.00	1.00	1.00	1.00	1.00	1.00	1.00	1.00	1.00
PHF Volume:	9	27	22	143	54	3	16	902	17	6	344	38
Reduct Vol:	0	0	0	0	0	0	0	0	0	0	0	0
Reduced Vol:	9	27	22	143	54	3	16	902	17	6	344	38
PCE Adj:	1.00	1.00	1.00	1.00	1.00	1.00	1.00	1.00	1.00	1.00	1.00	1.00
MLF Adj:	1.00	1.00	1.00	1.00	1.00	1.00	1.00	1.00	1.00	1.00	1.00	1.00
FinalVolume:	9	27	22	143	54	3	16	902	17	6	344	38

Saturation Flow Module:												
Sat/Lane:	1900	1900	1900	1900	1900	1900	1900	1900	1900	1900	1900	1900
Adjustment:	0.92	0.92	0.92	0.92	0.92	0.92	0.95	0.95	0.95	0.95	0.95	0.95
Lanes:	0.15	0.47	0.38	0.72	0.27	0.01	0.03	1.93	0.04	0.03	1.77	0.20
Final Sat.:	272	815	664	1251	473	26	62	3473	65	56	3192	353

Capacity Analysis Module:												
Vol/Sat:	0.03	0.03	0.03	0.11	0.11	0.11	0.26	0.26	0.26	0.11	0.11	0.11
Crit Moves:				****	****	****	****	****	****	****	****	****
Green Time:	22.6	22.6	22.6	22.6	22.6	22.6	51.4	51.4	51.4	51.4	51.4	51.4
Volume/Cap:	0.12	0.12	0.12	0.40	0.40	0.40	0.40	0.40	0.40	0.17	0.17	0.17
Delay/Veh:	21.4	21.4	21.4	23.8	23.8	23.8	7.0	7.0	7.0	5.8	5.8	5.8
User DelAdj:	1.00	1.00	1.00	1.00	1.00	1.00	1.00	1.00	1.00	1.00	1.00	1.00
AdjDel/Veh:	21.4	21.4	21.4	23.8	23.8	23.8	7.0	7.0	7.0	5.8	5.8	5.8
LOS by Move:	C	C	C	C	C	C	A	A	A	A	A	A
HCM2k95thQ:	2	2	2	9	9	9	12	12	12	4	4	4

Note: Queue reported is the number of cars per lane.

BART Phase II Extension Project

Level Of Service Computation Report
 2000 HCM Operations (Future Volume Alternative)
 AM - Existing Plus Project Conditions

Intersection #3788: SANTA CLARA/28TH

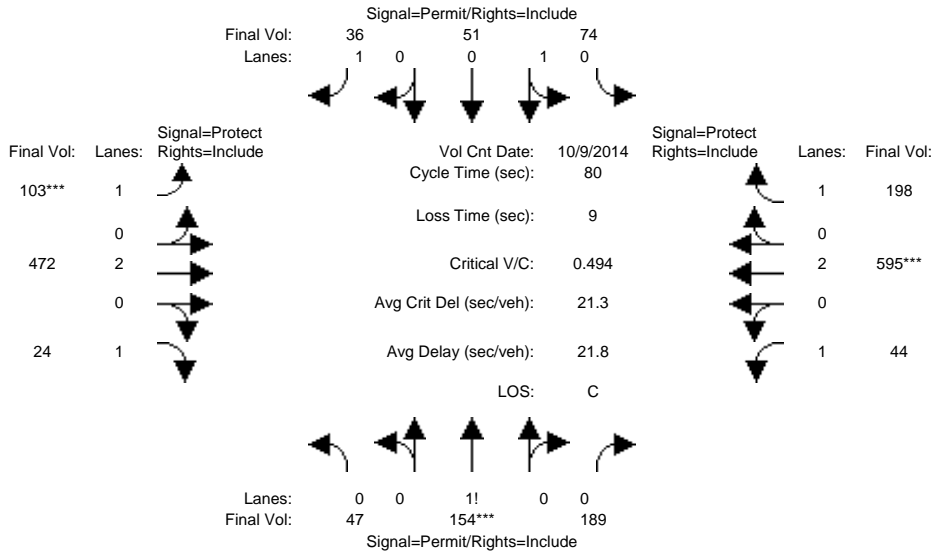

Approach:	North Bound			South Bound			East Bound			West Bound		
	L	T	R	L	T	R	L	T	R	L	T	R
Min. Green:	10	10	10	10	10	10	7	10	10	7	10	10
Y+R:	4.0	4.0	4.0	4.0	4.0	4.0	4.0	4.0	4.0	4.0	4.0	4.0
Volume Module: >> Count Date: 9 Oct 2014 <<												
Base Vol:	47	154	189	74	51	36	103	472	24	44	595	198
Growth Adj:	1.00	1.00	1.00	1.00	1.00	1.00	1.00	1.00	1.00	1.00	1.00	1.00
Initial Bse:	47	154	189	74	51	36	103	472	24	44	595	198
Added Vol:	0	0	0	0	0	0	0	0	0	0	0	0
PasserByVol:	0	0	0	0	0	0	0	0	0	0	0	0
Initial Fut:	47	154	189	74	51	36	103	472	24	44	595	198
User Adj:	1.00	1.00	1.00	1.00	1.00	1.00	1.00	1.00	1.00	1.00	1.00	1.00
PHF Adj:	1.00	1.00	1.00	1.00	1.00	1.00	1.00	1.00	1.00	1.00	1.00	1.00
PHF Volume:	47	154	189	74	51	36	103	472	24	44	595	198
Reduct Vol:	0	0	0	0	0	0	0	0	0	0	0	0
Reduced Vol:	47	154	189	74	51	36	103	472	24	44	595	198
PCE Adj:	1.00	1.00	1.00	1.00	1.00	1.00	1.00	1.00	1.00	1.00	1.00	1.00
MLF Adj:	1.00	1.00	1.00	1.00	1.00	1.00	1.00	1.00	1.00	1.00	1.00	1.00
FinalVolume:	47	154	189	74	51	36	103	472	24	44	595	198
Saturation Flow Module:												
Sat/Lane:	1900	1900	1900	1900	1900	1900	1900	1900	1900	1900	1900	1900
Adjustment:	0.92	0.92	0.92	0.95	0.95	0.92	0.92	1.00	0.92	0.92	1.00	0.92
Lanes:	0.12	0.39	0.49	0.59	0.41	1.00	1.00	2.00	1.00	1.00	2.00	1.00
Final Sat.:	211	691	848	1066	734	1750	1750	3800	1750	1750	3800	1750
Capacity Analysis Module:												
Vol/Sat:	0.22	0.22	0.22	0.07	0.07	0.02	0.06	0.12	0.01	0.03	0.16	0.11
Crit Moves:	****						****			****		
Green Time:	36.1	36.1	36.1	36.1	36.1	36.1	9.5	20.5	20.5	14.4	25.4	25.4
Volume/Cap:	0.49	0.49	0.49	0.15	0.15	0.05	0.49	0.48	0.05	0.14	0.49	0.36
Delay/Veh:	16.0	16.0	16.0	13.0	13.0	12.3	34.8	25.6	22.5	27.8	22.4	21.4
User DelAdj:	1.00	1.00	1.00	1.00	1.00	1.00	1.00	1.00	1.00	1.00	1.00	1.00
AdjDel/Veh:	16.0	16.0	16.0	13.0	13.0	12.3	34.8	25.6	22.5	27.8	22.4	21.4
LOS by Move:	B	B	B	B	B	B	C	C	C	C	C	C
HCM2k95thQ:	14	14	14	4	4	1	5	9	1	2	11	8

Note: Queue reported is the number of cars per lane.

BART Phase II Extension Project

Level Of Service Computation Report
 2000 HCM Operations (Future Volume Alternative)
 PM - Existing Plus Project Conditions

Intersection #3788: SANTA CLARA/28TH

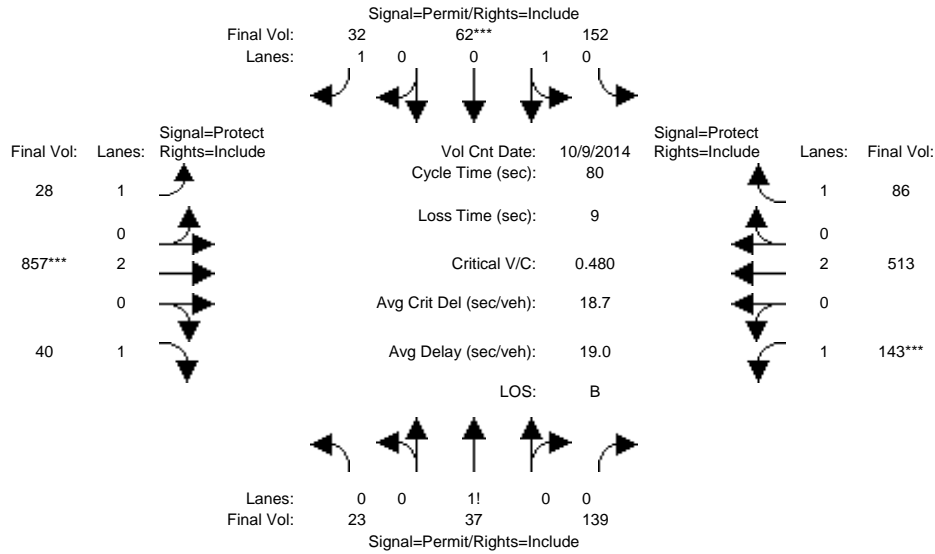

Approach:	North Bound			South Bound			East Bound			West Bound		
	L	T	R	L	T	R	L	T	R	L	T	R
Min. Green:	10	10	10	10	10	10	7	10	10	7	10	10
Y+R:	4.0	4.0	4.0	4.0	4.0	4.0	4.0	4.0	4.0	4.0	4.0	4.0
Volume Module: >> Count Date: 9 Oct 2014 <<												
Base Vol:	23	37	139	152	62	32	28	857	40	143	513	86
Growth Adj:	1.00	1.00	1.00	1.00	1.00	1.00	1.00	1.00	1.00	1.00	1.00	1.00
Initial Bse:	23	37	139	152	62	32	28	857	40	143	513	86
Added Vol:	0	0	0	0	0	0	0	0	0	0	0	0
PasserByVol:	0	0	0	0	0	0	0	0	0	0	0	0
Initial Fut:	23	37	139	152	62	32	28	857	40	143	513	86
User Adj:	1.00	1.00	1.00	1.00	1.00	1.00	1.00	1.00	1.00	1.00	1.00	1.00
PHF Adj:	1.00	1.00	1.00	1.00	1.00	1.00	1.00	1.00	1.00	1.00	1.00	1.00
PHF Volume:	23	37	139	152	62	32	28	857	40	143	513	86
Reduct Vol:	0	0	0	0	0	0	0	0	0	0	0	0
Reduced Vol:	23	37	139	152	62	32	28	857	40	143	513	86
PCE Adj:	1.00	1.00	1.00	1.00	1.00	1.00	1.00	1.00	1.00	1.00	1.00	1.00
MLF Adj:	1.00	1.00	1.00	1.00	1.00	1.00	1.00	1.00	1.00	1.00	1.00	1.00
FinalVolume:	23	37	139	152	62	32	28	857	40	143	513	86
Saturation Flow Module:												
Sat/Lane:	1900	1900	1900	1900	1900	1900	1900	1900	1900	1900	1900	1900
Adjustment:	0.92	0.92	0.92	0.95	0.95	0.92	0.92	1.00	0.92	0.92	1.00	0.92
Lanes:	0.11	0.19	0.70	0.71	0.29	1.00	1.00	2.00	1.00	1.00	2.00	1.00
Final Sat.:	202	325	1222	1279	521	1750	1750	3800	1750	1750	3800	1750
Capacity Analysis Module:												
Vol/Sat:	0.11	0.11	0.11	0.12	0.12	0.02	0.02	0.23	0.02	0.08	0.14	0.05
Crit Moves:				****			****			****		
Green Time:	19.8	19.8	19.8	19.8	19.8	19.8	20.1	37.6	37.6	13.6	31.1	31.1
Volume/Cap:	0.46	0.46	0.46	0.48	0.48	0.07	0.06	0.48	0.05	0.48	0.35	0.13
Delay/Veh:	26.3	26.3	26.3	26.5	26.5	23.1	22.8	14.7	11.5	31.2	17.4	15.8
User DelAdj:	1.00	1.00	1.00	1.00	1.00	1.00	1.00	1.00	1.00	1.00	1.00	1.00
AdjDel/Veh:	26.3	26.3	26.3	26.5	26.5	23.1	22.8	14.7	11.5	31.2	17.4	15.8
LOS by Move:	C	C	C	C	C	C	C	B	B	C	B	B
HCM2k95thQ:	9	9	9	10	10	1	1	13	1	7	8	3

Note: Queue reported is the number of cars per lane.

BART Phase II Extension Project

Level Of Service Computation Report
 2000 HCM Operations (Future Volume Alternative)
 AM - Existing Plus Project Conditions

Intersection #3789: SANTA CLARA/21ST

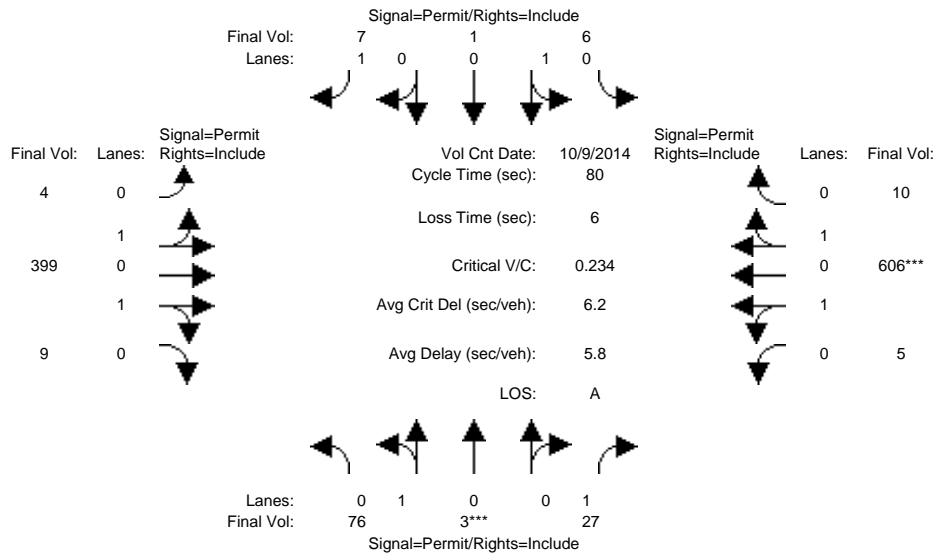

Approach:	North Bound			South Bound			East Bound			West Bound		
	L	T	R	L	T	R	L	T	R	L	T	R
Min. Green:	10	10	10	10	10	10	10	10	10	10	10	10
Y+R:	4.0	4.0	4.0	4.0	4.0	4.0	4.0	4.0	4.0	4.0	4.0	4.0
Volume Module: >> Count Date: 9 Oct 2014 <<												
Base Vol:	76	3	27	6	1	7	4	399	9	5	606	10
Growth Adj:	1.00	1.00	1.00	1.00	1.00	1.00	1.00	1.00	1.00	1.00	1.00	1.00
Initial Bse:	76	3	27	6	1	7	4	399	9	5	606	10
Added Vol:	0	0	0	0	0	0	0	0	0	0	0	0
PasserByVol:	0	0	0	0	0	0	0	0	0	0	0	0
Initial Fut:	76	3	27	6	1	7	4	399	9	5	606	10
User Adj:	1.00	1.00	1.00	1.00	1.00	1.00	1.00	1.00	1.00	1.00	1.00	1.00
PHF Adj:	1.00	1.00	1.00	1.00	1.00	1.00	1.00	1.00	1.00	1.00	1.00	1.00
PHF Volume:	76	3	27	6	1	7	4	399	9	5	606	10
Reduct Vol:	0	0	0	0	0	0	0	0	0	0	0	0
Reduced Vol:	76	3	27	6	1	7	4	399	9	5	606	10
PCE Adj:	1.00	1.00	1.00	1.00	1.00	1.00	1.00	1.00	1.00	1.00	1.00	1.00
MLF Adj:	1.00	1.00	1.00	1.00	1.00	1.00	1.00	1.00	1.00	1.00	1.00	1.00
FinalVolume:	76	3	27	6	1	7	4	399	9	5	606	10
Saturation Flow Module:												
Sat/Lane:	1900	1900	1900	1900	1900	1900	1900	1900	1900	1900	1900	1900
Adjustment:	0.95	0.95	0.92	0.95	0.95	0.92	0.95	0.95	0.95	0.95	0.95	0.95
Lanes:	0.96	0.04	1.00	0.86	0.14	1.00	0.02	1.94	0.04	0.02	1.95	0.03
Final Sat.:	1732	68	1750	1543	257	1750	35	3486	79	29	3513	58
Capacity Analysis Module:												
Vol/Sat:	0.04	0.04	0.02	0.00	0.00	0.00	0.11	0.11	0.11	0.17	0.17	0.17
Crit Moves:	****											
Green Time:	15.0	15.0	15.0	15.0	15.0	15.0	59.0	59.0	59.0	59.0	59.0	59.0
Volume/Cap:	0.23	0.23	0.08	0.02	0.02	0.02	0.16	0.16	0.16	0.23	0.23	0.23
Delay/Veh:	28.0	28.0	26.9	26.5	26.5	26.5	3.1	3.1	3.1	3.4	3.4	3.4
User DelAdj:	1.00	1.00	1.00	1.00	1.00	1.00	1.00	1.00	1.00	1.00	1.00	1.00
AdjDel/Veh:	28.0	28.0	26.9	26.5	26.5	26.5	3.1	3.1	3.1	3.4	3.4	3.4
LOS by Move:	C	C	C	C	C	C	A	A	A	A	A	A
HCM2k95thQ:	4	4	1	0	0	0	3	3	3	5	5	5

Note: Queue reported is the number of cars per lane.

BART Phase II Extension Project

Level Of Service Computation Report
 2000 HCM Operations (Future Volume Alternative)
 PM - Existing Plus Project Conditions

Intersection #3789: SANTA CLARA/21ST

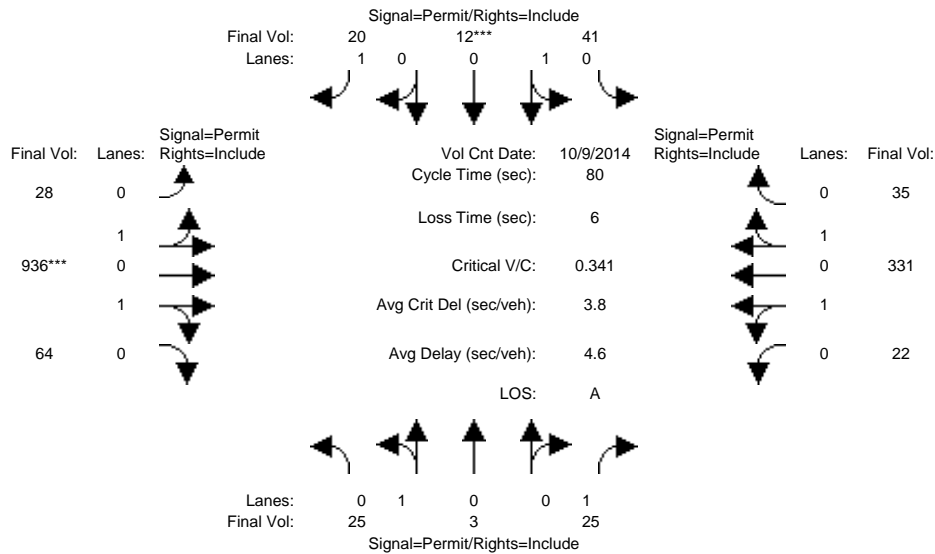

Approach:	North Bound			South Bound			East Bound			West Bound		
Movement:	L	T	R	L	T	R	L	T	R	L	T	R
Min. Green:	10	10	10	10	10	10	10	10	10	10	10	10
Y+R:	4.0	4.0	4.0	4.0	4.0	4.0	4.0	4.0	4.0	4.0	4.0	4.0

Volume Module:	>> Count Date: 9 Oct 2014 <<											
Base Vol:	25	3	25	41	12	20	28	936	64	22	331	35
Growth Adj:	1.00	1.00	1.00	1.00	1.00	1.00	1.00	1.00	1.00	1.00	1.00	1.00
Initial Bse:	25	3	25	41	12	20	28	936	64	22	331	35
Added Vol:	0	0	0	0	0	0	0	0	0	0	0	0
PasserByVol:	0	0	0	0	0	0	0	0	0	0	0	0
Initial Fut:	25	3	25	41	12	20	28	936	64	22	331	35
User Adj:	1.00	1.00	1.00	1.00	1.00	1.00	1.00	1.00	1.00	1.00	1.00	1.00
PHF Adj:	1.00	1.00	1.00	1.00	1.00	1.00	1.00	1.00	1.00	1.00	1.00	1.00
PHF Volume:	25	3	25	41	12	20	28	936	64	22	331	35
Reduct Vol:	0	0	0	0	0	0	0	0	0	0	0	0
Reduced Vol:	25	3	25	41	12	20	28	936	64	22	331	35
PCE Adj:	1.00	1.00	1.00	1.00	1.00	1.00	1.00	1.00	1.00	1.00	1.00	1.00
MLF Adj:	1.00	1.00	1.00	1.00	1.00	1.00	1.00	1.00	1.00	1.00	1.00	1.00
Final Volume:	25	3	25	41	12	20	28	936	64	22	331	35

Saturation Flow Module:												
Sat/Lane:	1900	1900	1900	1900	1900	1900	1900	1900	1900	1900	1900	1900
Adjustment:	0.95	0.95	0.92	0.95	0.95	0.92	0.95	0.95	0.95	0.95	0.95	0.95
Lanes:	0.89	0.11	1.00	0.77	0.23	1.00	0.05	1.83	0.12	0.11	1.71	0.18
Final Sat.:	1607	193	1750	1392	408	1750	98	3278	224	204	3071	325

Capacity Analysis Module:												
Vol/Sat:	0.02	0.02	0.01	0.03	0.03	0.01	0.29	0.29	0.29	0.11	0.11	0.11
Crit Moves:				****	****		****	****				
Green Time:	10.0	10.0	10.0	10.0	10.0	10.0	64.0	64.0	64.0	64.0	64.0	64.0
Volume/Cap:	0.12	0.12	0.11	0.24	0.24	0.09	0.36	0.36	0.36	0.13	0.13	0.13
Delay/Veh:	31.4	31.4	31.3	32.1	32.1	31.2	2.3	2.3	2.3	1.8	1.8	1.8
User DelAdj:	1.00	1.00	1.00	1.00	1.00	1.00	1.00	1.00	1.00	1.00	1.00	1.00
AdjDel/Veh:	31.4	31.4	31.3	32.1	32.1	31.2	2.3	2.3	2.3	1.8	1.8	1.8
LOS by Move:	C	C	C	C	C	C	A	A	A	A	A	A
HCM2k95thQ:	2	2	1	3	3	1	8	8	8	2	2	2

Note: Queue reported is the number of cars per lane.

BART Phase II Extension Project

Level Of Service Computation Report
2000 HCM Operations (Future Volume Alternative)
AM - Existing Plus Project Conditions

Intersection #3790: SANTA CLARA/24TH

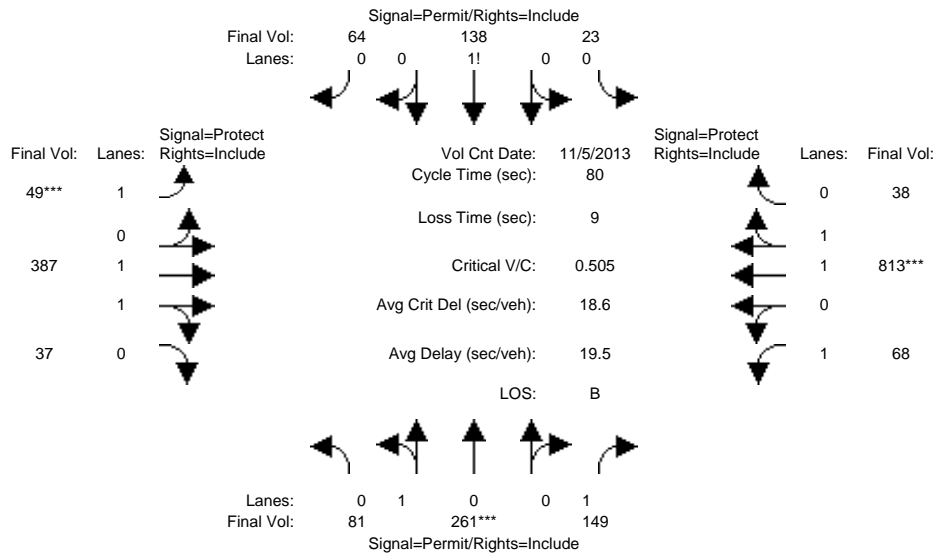

Approach:	North Bound			South Bound			East Bound			West Bound		
	L	T	R	L	T	R	L	T	R	L	T	R
Min. Green:	10	10	10	10	10	10	7	10	10	7	10	10
Y+R:	4.0	4.0	4.0	4.0	4.0	4.0	4.0	4.0	4.0	4.0	4.0	4.0
Volume Module: >> Count Date: 5 Nov 2013 <<												
Base Vol:	81	261	149	23	138	64	49	387	37	68	813	38
Growth Adj:	1.00	1.00	1.00	1.00	1.00	1.00	1.00	1.00	1.00	1.00	1.00	1.00
Initial Bse:	81	261	149	23	138	64	49	387	37	68	813	38
Added Vol:	0	0	0	0	0	0	0	0	0	0	0	0
PasserByVol:	0	0	0	0	0	0	0	0	0	0	0	0
Initial Fut:	81	261	149	23	138	64	49	387	37	68	813	38
User Adj:	1.00	1.00	1.00	1.00	1.00	1.00	1.00	1.00	1.00	1.00	1.00	1.00
PHF Adj:	1.00	1.00	1.00	1.00	1.00	1.00	1.00	1.00	1.00	1.00	1.00	1.00
PHF Volume:	81	261	149	23	138	64	49	387	37	68	813	38
Reduct Vol:	0	0	0	0	0	0	0	0	0	0	0	0
Reduced Vol:	81	261	149	23	138	64	49	387	37	68	813	38
PCE Adj:	1.00	1.00	1.00	1.00	1.00	1.00	1.00	1.00	1.00	1.00	1.00	1.00
MLF Adj:	1.00	1.00	1.00	1.00	1.00	1.00	1.00	1.00	1.00	1.00	1.00	1.00
Final Volume:	81	261	149	23	138	64	49	387	37	68	813	38
Saturation Flow Module:												
Sat/Lane:	1900	1900	1900	1900	1900	1900	1900	1900	1900	1900	1900	1900
Adjustment:	0.95	0.95	0.92	0.92	0.92	0.92	0.92	0.98	0.95	0.92	0.97	0.95
Lanes:	0.24	0.76	1.00	0.10	0.62	0.28	1.00	1.82	0.18	1.00	1.91	0.09
Final Sat.:	426	1374	1750	179	1073	498	1750	3377	323	1750	3535	165
Capacity Analysis Module:												
Vol/Sat:	0.19	0.19	0.09	0.13	0.13	0.13	0.03	0.11	0.11	0.04	0.23	0.23
Crit Moves:	****						****			****		
Green Time:	29.0	29.0	29.0	29.0	29.0	29.0	7.0	24.7	24.7	17.3	35.0	35.0
Volume/Cap:	0.53	0.53	0.24	0.36	0.36	0.36	0.32	0.37	0.37	0.18	0.53	0.53
Delay/Veh:	20.9	20.9	18.0	19.0	19.0	19.0	35.5	21.8	21.8	25.8	16.7	16.7
User DelAdj:	1.00	1.00	1.00	1.00	1.00	1.00	1.00	1.00	1.00	1.00	1.00	1.00
AdjDel/Veh:	20.9	20.9	18.0	19.0	19.0	19.0	35.5	21.8	21.8	25.8	16.7	16.7
LOS by Move:	C	C	B	B	B	B	D	C	C	C	B	B
HCM2k95thQ:	13	13	5	9	9	9	2	8	8	3	15	15

Note: Queue reported is the number of cars per lane.

BART Phase II Extension Project

Level Of Service Computation Report
2000 HCM Operations (Future Volume Alternative)
PM - Existing Plus Project Conditions

Intersection #3790: SANTA CLARA/24TH

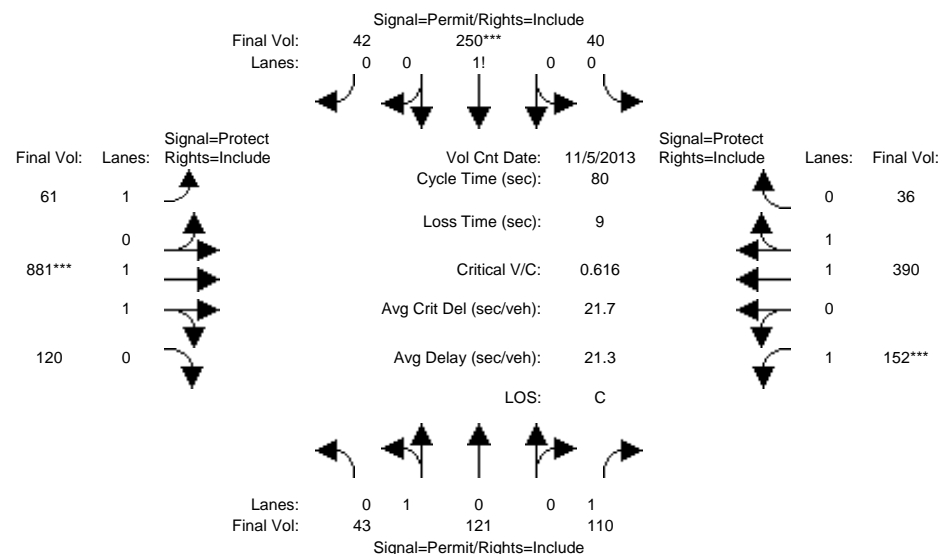

Approach:	North Bound			South Bound			East Bound			West Bound		
Movement:	L	T	R	L	T	R	L	T	R	L	T	R
Min. Green:	10	10	10	10	10	10	7	10	10	7	10	10
Y+R:	4.0	4.0	4.0	4.0	4.0	4.0	4.0	4.0	4.0	4.0	4.0	4.0
Volume Module: >> Count Date: 5 Nov 2013 <<												
Base Vol:	43	121	110	40	250	42	61	881	120	152	390	36
Growth Adj:	1.00	1.00	1.00	1.00	1.00	1.00	1.00	1.00	1.00	1.00	1.00	1.00
Initial Bse:	43	121	110	40	250	42	61	881	120	152	390	36
Added Vol:	0	0	0	0	0	0	0	0	0	0	0	0
PasserByVol:	0	0	0	0	0	0	0	0	0	0	0	0
Initial Fut:	43	121	110	40	250	42	61	881	120	152	390	36
User Adj:	1.00	1.00	1.00	1.00	1.00	1.00	1.00	1.00	1.00	1.00	1.00	1.00
PHF Adj:	1.00	1.00	1.00	1.00	1.00	1.00	1.00	1.00	1.00	1.00	1.00	1.00
PHF Volume:	43	121	110	40	250	42	61	881	120	152	390	36
Reduct Vol:	0	0	0	0	0	0	0	0	0	0	0	0
Reduced Vol:	43	121	110	40	250	42	61	881	120	152	390	36
PCE Adj:	1.00	1.00	1.00	1.00	1.00	1.00	1.00	1.00	1.00	1.00	1.00	1.00
MLF Adj:	1.00	1.00	1.00	1.00	1.00	1.00	1.00	1.00	1.00	1.00	1.00	1.00
FinalVolume:	43	121	110	40	250	42	61	881	120	152	390	36
Saturation Flow Module:												
Sat/Lane:	1900	1900	1900	1900	1900	1900	1900	1900	1900	1900	1900	1900
Adjustment:	0.95	0.95	0.92	0.92	0.92	0.92	0.92	0.98	0.95	0.92	0.98	0.95
Lanes:	0.26	0.74	1.00	0.12	0.75	0.13	1.00	1.75	0.25	1.00	1.83	0.17
Final Sat.:	472	1328	1750	211	1318	221	1750	3256	444	1750	3387	313
Capacity Analysis Module:												
Vol/Sat:	0.09	0.09	0.06	0.19	0.19	0.19	0.03	0.27	0.27	0.09	0.12	0.12
Crit Moves:				****			****			****		
Green Time:	24.6	24.6	24.6	24.6	24.6	24.6	19.1	35.1	35.1	11.3	27.3	27.3
Volume/Cap:	0.30	0.30	0.20	0.62	0.62	0.62	0.15	0.62	0.62	0.62	0.34	0.34
Delay/Veh:	21.4	21.4	20.6	25.8	25.8	25.8	24.2	18.0	18.0	37.0	19.8	19.8
User DelAdj:	1.00	1.00	1.00	1.00	1.00	1.00	1.00	1.00	1.00	1.00	1.00	1.00
AdjDel/Veh:	21.4	21.4	20.6	25.8	25.8	25.8	24.2	18.0	18.0	37.0	19.8	19.8
LOS by Move:	C	C	C	C	C	C	C	B	B	D	B	B
HCM2k95thQ:	6	6	4	16	16	16	3	18	18	8	8	8

Note: Queue reported is the number of cars per lane.

BART Phase II Extension Project

Level Of Service Computation Report
2000 HCM Operations (Future Volume Alternative)
AM - Existing Plus Project Conditions

Intersection #3832: 24TH/WILLIAM

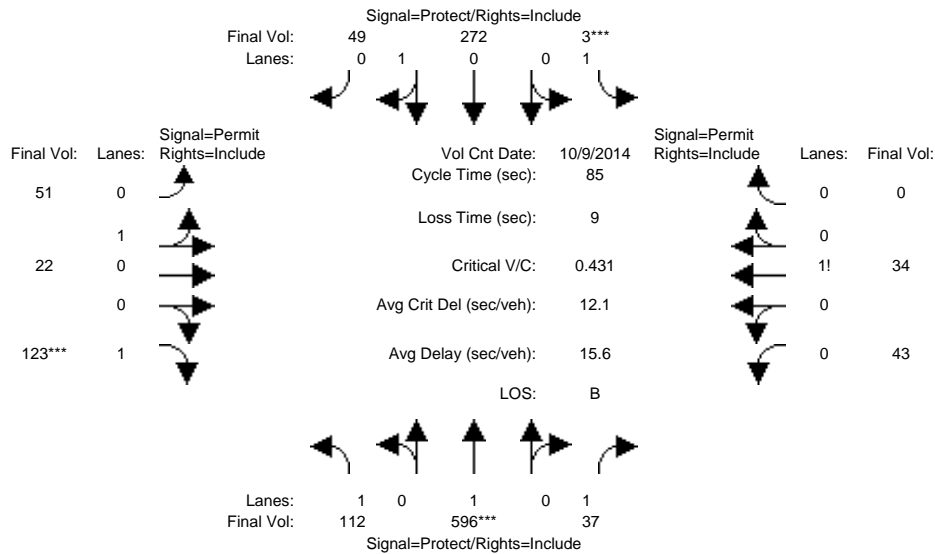

Approach:	North Bound			South Bound			East Bound			West Bound		
	L	T	R	L	T	R	L	T	R	L	T	R
Min. Green:	7	10	10	7	10	10	10	10	10	10	10	10
Y+R:	4.0	4.0	4.0	4.0	4.0	4.0	4.0	4.0	4.0	4.0	4.0	4.0
Volume Module: >> Count Date: 9 Oct 2014 <<												
Base Vol:	112	596	37	3	272	49	51	22	123	43	34	0
Growth Adj:	1.00	1.00	1.00	1.00	1.00	1.00	1.00	1.00	1.00	1.00	1.00	1.00
Initial Bse:	112	596	37	3	272	49	51	22	123	43	34	0
Added Vol:	0	0	0	0	0	0	0	0	0	0	0	0
PasserByVol:	0	0	0	0	0	0	0	0	0	0	0	0
Initial Fut:	112	596	37	3	272	49	51	22	123	43	34	0
User Adj:	1.00	1.00	1.00	1.00	1.00	1.00	1.00	1.00	1.00	1.00	1.00	1.00
PHF Adj:	1.00	1.00	1.00	1.00	1.00	1.00	1.00	1.00	1.00	1.00	1.00	1.00
PHF Volume:	112	596	37	3	272	49	51	22	123	43	34	0
Reduct Vol:	0	0	0	0	0	0	0	0	0	0	0	0
Reduced Vol:	112	596	37	3	272	49	51	22	123	43	34	0
PCE Adj:	1.00	1.00	1.00	1.00	1.00	1.00	1.00	1.00	1.00	1.00	1.00	1.00
MLF Adj:	1.00	1.00	1.00	1.00	1.00	1.00	1.00	1.00	1.00	1.00	1.00	1.00
Final Volume:	112	596	37	3	272	49	51	22	123	43	34	0
Saturation Flow Module:												
Sat/Lane:	1900	1900	1900	1900	1900	1900	1900	1900	1900	1900	1900	1900
Adjustment:	0.92	1.00	0.92	0.92	0.95	0.95	0.95	0.95	0.92	0.95	0.95	0.92
Lanes:	1.00	1.00	1.00	1.00	0.85	0.15	0.70	0.30	1.00	0.56	0.44	0.00
Final Sat.:	1750	1900	1750	1750	1525	275	1258	542	1750	1005	795	0
Capacity Analysis Module:												
Vol/Sat:	0.06	0.31	0.02	0.00	0.18	0.18	0.04	0.04	0.07	0.04	0.04	0.00
Crit Moves:	****			****			****			****		
Green Time:	20.0	56.4	56.4	7.0	43.4	43.4	12.6	12.6	12.6	12.6	12.6	0.0
Volume/Cap:	0.27	0.47	0.03	0.02	0.35	0.35	0.27	0.27	0.47	0.29	0.29	0.00
Delay/Veh:	26.9	7.3	4.9	35.9	12.7	12.7	32.7	32.7	34.5	32.8	32.8	0.0
User DelAdj:	1.00	1.00	1.00	1.00	1.00	1.00	1.00	1.00	1.00	1.00	1.00	1.00
AdjDel/Veh:	26.9	7.3	4.9	35.9	12.7	12.7	32.7	32.7	34.5	32.8	32.8	0.0
LOS by Move:	C	A	A	D	B	B	C	C	C	C	C	A
HCM2k95thQ:	5	14	1	0	10	10	4	4	7	4	4	0

Note: Queue reported is the number of cars per lane.

BART Phase II Extension Project

Level Of Service Computation Report
2000 HCM Operations (Future Volume Alternative)
PM - Existing Plus Project Conditions

Intersection #3832: 24TH/WILLIAM

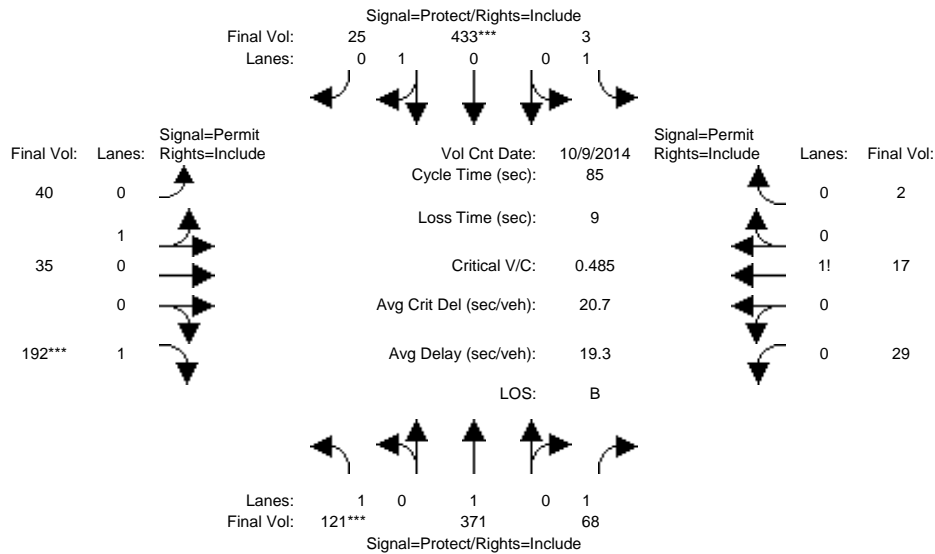

Approach:	North Bound			South Bound			East Bound			West Bound		
	L	T	R	L	T	R	L	T	R	L	T	R
Min. Green:	7	10	10	7	10	10	10	10	10	10	10	10
Y+R:	4.0	4.0	4.0	4.0	4.0	4.0	4.0	4.0	4.0	4.0	4.0	4.0
Volume Module: >> Count Date: 9 Oct 2014 <<												
Base Vol:	121	371	68	3	433	25	40	35	192	29	17	2
Growth Adj:	1.00	1.00	1.00	1.00	1.00	1.00	1.00	1.00	1.00	1.00	1.00	1.00
Initial Bse:	121	371	68	3	433	25	40	35	192	29	17	2
Added Vol:	0	0	0	0	0	0	0	0	0	0	0	0
PasserByVol:	0	0	0	0	0	0	0	0	0	0	0	0
Initial Fut:	121	371	68	3	433	25	40	35	192	29	17	2
User Adj:	1.00	1.00	1.00	1.00	1.00	1.00	1.00	1.00	1.00	1.00	1.00	1.00
PHF Adj:	1.00	1.00	1.00	1.00	1.00	1.00	1.00	1.00	1.00	1.00	1.00	1.00
PHF Volume:	121	371	68	3	433	25	40	35	192	29	17	2
Reduct Vol:	0	0	0	0	0	0	0	0	0	0	0	0
Reduced Vol:	121	371	68	3	433	25	40	35	192	29	17	2
PCE Adj:	1.00	1.00	1.00	1.00	1.00	1.00	1.00	1.00	1.00	1.00	1.00	1.00
MLF Adj:	1.00	1.00	1.00	1.00	1.00	1.00	1.00	1.00	1.00	1.00	1.00	1.00
FinalVolume:	121	371	68	3	433	25	40	35	192	29	17	2
Saturation Flow Module:												
Sat/Lane:	1900	1900	1900	1900	1900	1900	1900	1900	1900	1900	1900	1900
Adjustment:	0.92	1.00	0.92	0.92	0.95	0.95	0.95	0.95	0.92	0.92	0.92	0.92
Lanes:	1.00	1.00	1.00	1.00	0.95	0.05	0.53	0.47	1.00	0.61	0.35	0.04
Final Sat.:	1750	1900	1750	1750	1702	98	960	840	1750	1057	620	73
Capacity Analysis Module:												
Vol/Sat:	0.07	0.20	0.04	0.00	0.25	0.25	0.04	0.04	0.11	0.03	0.03	0.03
Crit Moves:	****				****				****			
Green Time:	12.1	39.9	39.9	16.8	44.6	44.6	19.2	19.2	19.2	19.2	19.2	19.2
Volume/Cap:	0.48	0.42	0.08	0.01	0.48	0.48	0.18	0.18	0.48	0.12	0.12	0.12
Delay/Veh:	35.0	15.2	12.5	27.4	13.3	13.3	26.8	26.8	29.5	26.3	26.3	26.3
User DelAdj:	1.00	1.00	1.00	1.00	1.00	1.00	1.00	1.00	1.00	1.00	1.00	1.00
AdjDel/Veh:	35.0	15.2	12.5	27.4	13.3	13.3	26.8	26.8	29.5	26.3	26.3	26.3
LOS by Move:	D	B	B	C	B	B	C	C	C	C	C	C
HCM2k95thQ:	6	12	2	0	15	15	4	4	10	2	2	2

Note: Queue reported is the number of cars per lane.

BART Phase II Extension Project

Level Of Service Computation Report
 2000 HCM Operations (Future Volume Alternative)
 AM - Existing Plus Project Conditions

Intersection #4005: JULIAN/28TH

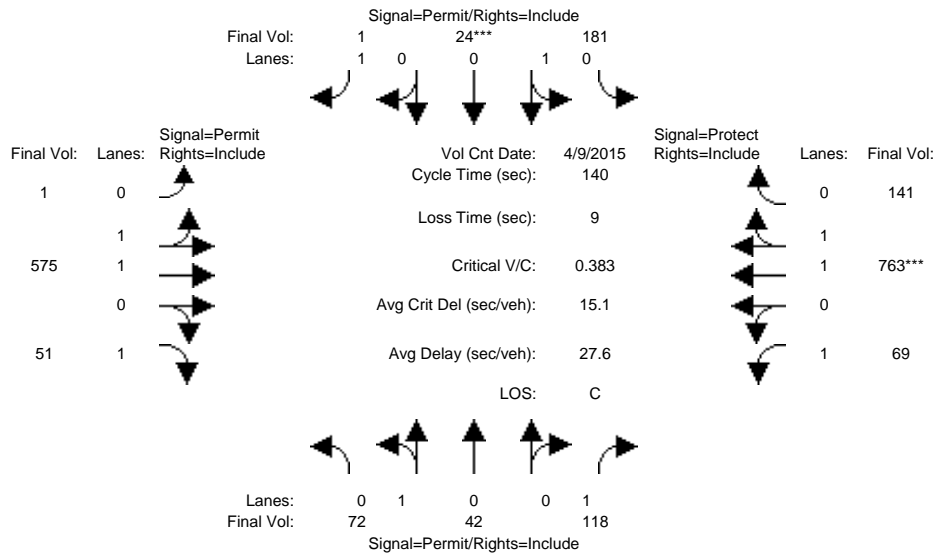

Approach:	North Bound			South Bound			East Bound			West Bound		
Movement:	L	T	R	L	T	R	L	T	R	L	T	R
Min. Green:	10	10	10	10	10	10	10	10	10	7	10	10
Y+R:	4.0	4.0	4.0	4.0	4.0	4.0	4.0	4.0	4.0	4.0	4.0	4.0
Volume Module: >> Count Date: 9 Apr 2015 <<												
Base Vol:	72	42	118	181	24	1	1	575	51	69	763	141
Growth Adj:	1.00	1.00	1.00	1.00	1.00	1.00	1.00	1.00	1.00	1.00	1.00	1.00
Initial Bse:	72	42	118	181	24	1	1	575	51	69	763	141
Added Vol:	0	0	0	0	0	0	0	0	0	0	0	0
PasserByVol:	0	0	0	0	0	0	0	0	0	0	0	0
Initial Fut:	72	42	118	181	24	1	1	575	51	69	763	141
User Adj:	1.00	1.00	1.00	1.00	1.00	1.00	1.00	1.00	1.00	1.00	1.00	1.00
PHF Adj:	1.00	1.00	1.00	1.00	1.00	1.00	1.00	1.00	1.00	1.00	1.00	1.00
PHF Volume:	72	42	118	181	24	1	1	575	51	69	763	141
Reduct Vol:	0	0	0	0	0	0	0	0	0	0	0	0
Reduced Vol:	72	42	118	181	24	1	1	575	51	69	763	141
PCE Adj:	1.00	1.00	1.00	1.00	1.00	1.00	1.00	1.00	1.00	1.00	1.00	1.00
MLF Adj:	1.00	1.00	1.00	1.00	1.00	1.00	1.00	1.00	1.00	1.00	1.00	1.00
FinalVolume:	72	42	118	181	24	1	1	575	51	69	763	141
Saturation Flow Module:												
Sat/Lane:	1900	1900	1900	1900	1900	1900	1900	1900	1900	1900	1900	1900
Adjustment:	0.95	0.95	0.92	0.95	0.95	0.92	0.95	0.97	0.92	0.92	0.98	0.95
Lanes:	0.63	0.37	1.00	0.88	0.12	1.00	0.01	1.99	1.00	1.00	1.68	0.32
Final Sat.:	1137	663	1750	1589	211	1750	6	3694	1750	1750	3122	577
Capacity Analysis Module:												
Vol/Sat:	0.06	0.06	0.07	0.11	0.11	0.00	0.16	0.16	0.03	0.04	0.24	0.24
Crit Moves:				****						****		
Green Time:	29.0	29.0	29.0	29.0	29.0	29.0	39.7	39.7	39.7	62.3	102	102.0
Volume/Cap:	0.31	0.31	0.33	0.55	0.55	0.00	0.55	0.55	0.10	0.09	0.34	0.34
Delay/Veh:	47.4	47.4	47.7	51.4	51.4	44.0	43.2	43.2	37.1	22.5	6.9	6.9
User DelAdj:	1.00	1.00	1.00	1.00	1.00	1.00	1.00	1.00	1.00	1.00	1.00	1.00
AdjDel/Veh:	47.4	47.4	47.7	51.4	51.4	44.0	43.2	43.2	37.1	22.5	6.9	6.9
LOS by Move:	D	D	D	D	D	D	D	D	D	C	A	A
HCM2k95thQ:	8	8	9	16	16	0	19	19	3	4	13	13

Note: Queue reported is the number of cars per lane.

BART Phase II Extension Project

Level Of Service Computation Report
 2000 HCM Operations (Future Volume Alternative)
 PM - Existing Plus Project Conditions

Intersection #4005: JULIAN/28TH

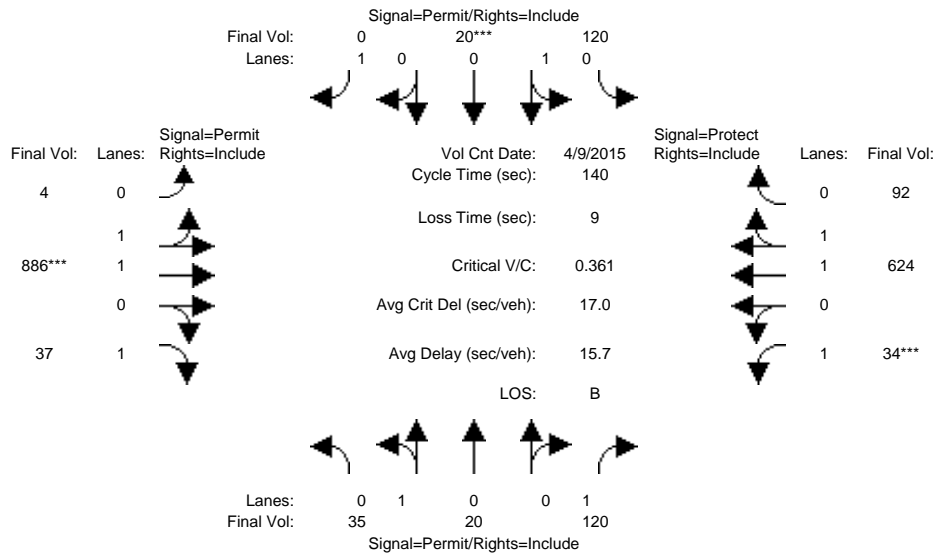

Approach:	North Bound			South Bound			East Bound			West Bound		
Movement:	L	T	R	L	T	R	L	T	R	L	T	R
Min. Green:	10	10	10	10	10	10	10	10	10	7	10	10
Y+R:	4.0	4.0	4.0	4.0	4.0	4.0	4.0	4.0	4.0	4.0	4.0	4.0
Volume Module: >> Count Date: 9 Apr 2015 <<												
Base Vol:	35	20	120	120	20	0	4	886	37	34	624	92
Growth Adj:	1.00	1.00	1.00	1.00	1.00	1.00	1.00	1.00	1.00	1.00	1.00	1.00
Initial Bse:	35	20	120	120	20	0	4	886	37	34	624	92
Added Vol:	0	0	0	0	0	0	0	0	0	0	0	0
PasserByVol:	0	0	0	0	0	0	0	0	0	0	0	0
Initial Fut:	35	20	120	120	20	0	4	886	37	34	624	92
User Adj:	1.00	1.00	1.00	1.00	1.00	1.00	1.00	1.00	1.00	1.00	1.00	1.00
PHF Adj:	1.00	1.00	1.00	1.00	1.00	1.00	1.00	1.00	1.00	1.00	1.00	1.00
PHF Volume:	35	20	120	120	20	0	4	886	37	34	624	92
Reduct Vol:	0	0	0	0	0	0	0	0	0	0	0	0
Reduced Vol:	35	20	120	120	20	0	4	886	37	34	624	92
PCE Adj:	1.00	1.00	1.00	1.00	1.00	1.00	1.00	1.00	1.00	1.00	1.00	1.00
MLF Adj:	1.00	1.00	1.00	1.00	1.00	1.00	1.00	1.00	1.00	1.00	1.00	1.00
FinalVolume:	35	20	120	120	20	0	4	886	37	34	624	92
Saturation Flow Module:												
Sat/Lane:	1900	1900	1900	1900	1900	1900	1900	1900	1900	1900	1900	1900
Adjustment:	0.95	0.95	0.92	0.95	0.95	0.92	0.95	0.97	0.92	0.92	0.98	0.95
Lanes:	0.64	0.36	1.00	0.86	0.14	1.00	0.01	1.99	1.00	1.00	1.74	0.26
Final Sat.:	1145	655	1750	1543	257	1750	17	3683	1750	1750	3224	475
Capacity Analysis Module:												
Vol/Sat:	0.03	0.03	0.07	0.08	0.08	0.00	0.24	0.24	0.02	0.02	0.19	0.19
Crit Moves:				****			****			****		
Green Time:	30.2	30.2	30.2	30.2	30.2	0.0	93.3	93.3	93.3	7.5	101	100.8
Volume/Cap:	0.14	0.14	0.32	0.36	0.36	0.00	0.36	0.36	0.03	0.36	0.27	0.27
Delay/Veh:	44.6	44.6	46.7	47.3	47.3	0.0	10.3	10.3	8.0	66.3	6.8	6.8
User DelAdj:	1.00	1.00	1.00	1.00	1.00	1.00	1.00	1.00	1.00	1.00	1.00	1.00
AdjDel/Veh:	44.6	44.6	46.7	47.3	47.3	0.0	10.3	10.3	8.0	66.3	6.8	6.8
LOS by Move:	D	D	D	D	D	A	B	B	A	E	A	A
HCM2k95thQ:	4	4	9	11	11	0	16	16	1	3	10	10

Note: Queue reported is the number of cars per lane.

BART Phase II Extension Project

Level Of Service Computation Report
2000 HCM Operations (Future Volume Alternative)
AM - Existing Plus Project Conditions

Intersection #4022: SANTA CLARA/26TH

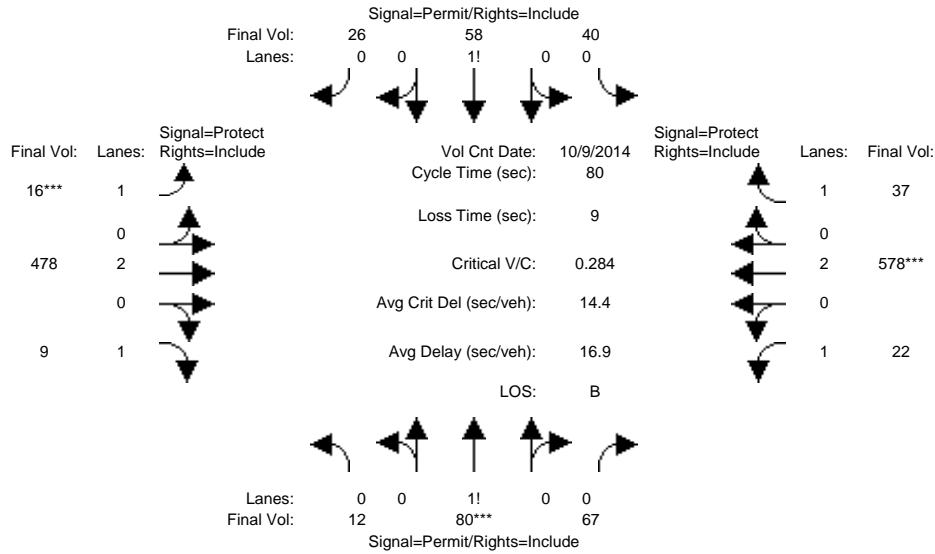

Approach:	North Bound			South Bound			East Bound			West Bound		
	L	T	R	L	T	R	L	T	R	L	T	R
Min. Green:	10	10	10	10	10	10	7	10	10	7	10	10
Y+R:	4.0	4.0	4.0	4.0	4.0	4.0	4.0	4.0	4.0	4.0	4.0	4.0
Volume Module: >> Count Date: 9 Oct 2014 <<												
Base Vol:	12	80	67	40	58	26	16	478	9	22	578	37
Growth Adj:	1.00	1.00	1.00	1.00	1.00	1.00	1.00	1.00	1.00	1.00	1.00	1.00
Initial Bse:	12	80	67	40	58	26	16	478	9	22	578	37
Added Vol:	0	0	0	0	0	0	0	0	0	0	0	0
PasserByVol:	0	0	0	0	0	0	0	0	0	0	0	0
Initial Fut:	12	80	67	40	58	26	16	478	9	22	578	37
User Adj:	1.00	1.00	1.00	1.00	1.00	1.00	1.00	1.00	1.00	1.00	1.00	1.00
PHF Adj:	1.00	1.00	1.00	1.00	1.00	1.00	1.00	1.00	1.00	1.00	1.00	1.00
PHF Volume:	12	80	67	40	58	26	16	478	9	22	578	37
Reduct Vol:	0	0	0	0	0	0	0	0	0	0	0	0
Reduced Vol:	12	80	67	40	58	26	16	478	9	22	578	37
PCE Adj:	1.00	1.00	1.00	1.00	1.00	1.00	1.00	1.00	1.00	1.00	1.00	1.00
MLF Adj:	1.00	1.00	1.00	1.00	1.00	1.00	1.00	1.00	1.00	1.00	1.00	1.00
FinalVolume:	12	80	67	40	58	26	16	478	9	22	578	37
Saturation Flow Module:												
Sat/Lane:	1900	1900	1900	1900	1900	1900	1900	1900	1900	1900	1900	1900
Adjustment:	0.92	0.92	0.92	0.92	0.92	0.92	0.92	1.00	0.92	0.92	1.00	0.92
Lanes:	0.08	0.50	0.42	0.32	0.47	0.21	1.00	2.00	1.00	1.00	2.00	1.00
Final Sat.:	132	881	737	565	819	367	1750	3800	1750	1750	3800	1750
Capacity Analysis Module:												
Vol/Sat:	0.09	0.09	0.09	0.07	0.07	0.07	0.01	0.13	0.01	0.01	0.15	0.02
Crit Moves:	****						****			****		
Green Time:	23.9	23.9	23.9	23.9	23.9	23.9	7.0	27.8	27.8	19.3	40.1	40.1
Volume/Cap:	0.30	0.30	0.30	0.24	0.24	0.24	0.10	0.36	0.01	0.05	0.30	0.04
Delay/Veh:	21.9	21.9	21.9	21.4	21.4	21.4	33.9	19.7	17.2	23.4	11.8	10.2
User DelAdj:	1.00	1.00	1.00	1.00	1.00	1.00	1.00	1.00	1.00	1.00	1.00	1.00
AdjDel/Veh:	21.9	21.9	21.9	21.4	21.4	21.4	33.9	19.7	17.2	23.4	11.8	10.2
LOS by Move:	C	C	C	C	C	C	C	B	B	C	B	B
HCM2k95thQ:	7	7	7	5	5	5	1	8	0	1	8	1

Note: Queue reported is the number of cars per lane.

BART Phase II Extension Project

Level Of Service Computation Report
 2000 HCM Operations (Future Volume Alternative)
 PM - Existing Plus Project Conditions

Intersection #4022: SANTA CLARA/26TH

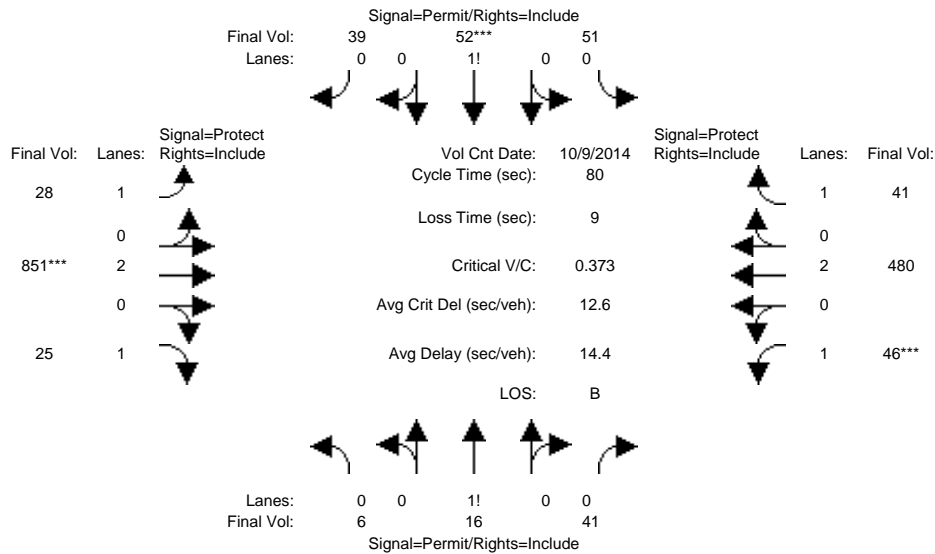

Approach:	North Bound			South Bound			East Bound			West Bound		
Movement:	L	T	R	L	T	R	L	T	R	L	T	R
Min. Green:	10	10	10	10	10	10	7	10	10	7	10	10
Y+R:	4.0	4.0	4.0	4.0	4.0	4.0	4.0	4.0	4.0	4.0	4.0	4.0
Volume Module: >> Count Date: 9 Oct 2014 <<												
Base Vol:	6	16	41	51	52	39	28	851	25	46	480	41
Growth Adj:	1.00	1.00	1.00	1.00	1.00	1.00	1.00	1.00	1.00	1.00	1.00	1.00
Initial Bse:	6	16	41	51	52	39	28	851	25	46	480	41
Added Vol:	0	0	0	0	0	0	0	0	0	0	0	0
PasserByVol:	0	0	0	0	0	0	0	0	0	0	0	0
Initial Fut:	6	16	41	51	52	39	28	851	25	46	480	41
User Adj:	1.00	1.00	1.00	1.00	1.00	1.00	1.00	1.00	1.00	1.00	1.00	1.00
PHF Adj:	1.00	1.00	1.00	1.00	1.00	1.00	1.00	1.00	1.00	1.00	1.00	1.00
PHF Volume:	6	16	41	51	52	39	28	851	25	46	480	41
Reduct Vol:	0	0	0	0	0	0	0	0	0	0	0	0
Reduced Vol:	6	16	41	51	52	39	28	851	25	46	480	41
PCE Adj:	1.00	1.00	1.00	1.00	1.00	1.00	1.00	1.00	1.00	1.00	1.00	1.00
MLF Adj:	1.00	1.00	1.00	1.00	1.00	1.00	1.00	1.00	1.00	1.00	1.00	1.00
FinalVolume:	6	16	41	51	52	39	28	851	25	46	480	41
Saturation Flow Module:												
Sat/Lane:	1900	1900	1900	1900	1900	1900	1900	1900	1900	1900	1900	1900
Adjustment:	0.92	0.92	0.92	0.92	0.92	0.92	0.92	1.00	0.92	0.92	1.00	0.92
Lanes:	0.10	0.25	0.65	0.36	0.37	0.27	1.00	2.00	1.00	1.00	2.00	1.00
Final Sat.:	167	444	1139	629	641	481	1750	3800	1750	1750	3800	1750
Capacity Analysis Module:												
Vol/Sat:	0.04	0.04	0.04	0.08	0.08	0.08	0.02	0.22	0.01	0.03	0.13	0.02
Crit Moves:				****			****			****		
Green Time:	17.0	17.0	17.0	17.0	17.0	17.0	22.1	47.0	47.0	7.0	31.9	31.9
Volume/Cap:	0.17	0.17	0.17	0.38	0.38	0.38	0.06	0.38	0.02	0.30	0.32	0.06
Delay/Veh:	25.9	25.9	25.9	27.6	27.6	27.6	21.4	8.9	6.9	35.3	16.7	14.8
User DelAdj:	1.00	1.00	1.00	1.00	1.00	1.00	1.00	1.00	1.00	1.00	1.00	1.00
AdjDel/Veh:	25.9	25.9	25.9	27.6	27.6	27.6	21.4	8.9	6.9	35.3	16.7	14.8
LOS by Move:	C	C	C	C	C	C	C	A	A	D	B	B
HCM2k95thQ:	3	3	3	7	7	7	1	11	1	2	8	1

Note: Queue reported is the number of cars per lane.

Level of Service Calculations

Diridon Station – Existing Plus Project

BART Phase II Extension Project

Level Of Service Computation Report
 2000 HCM Operations (Future Volume Alternative)
 AM - Existing Plus Project Conditions

Intersection #3013: 87/JULIAN (E) *

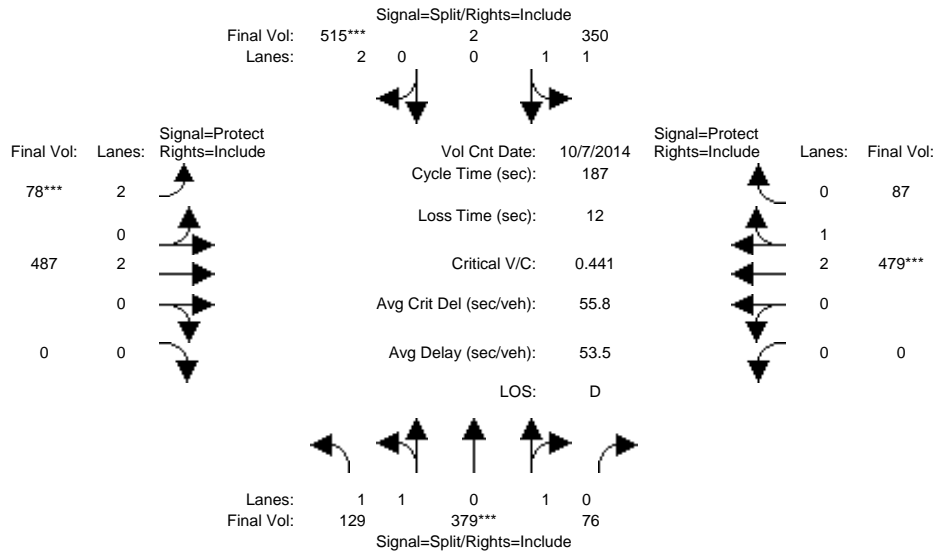

Approach:	North Bound			South Bound			East Bound			West Bound		
	L	T	R	L	T	R	L	T	R	L	T	R
Min. Green:	10	10	10	10	10	10	7	10	0	0	10	10
Y+R:	4.0	4.0	4.0	4.0	4.0	4.0	4.0	4.0	4.0	4.0	4.0	4.0

Volume Module:	>> Count Date: 7 Oct 2014 <<											
Base Vol:	129	379	76	350	2	515	78	487	0	0	479	87
Growth Adj:	1.00	1.00	1.00	1.00	1.00	1.00	1.00	1.00	1.00	1.00	1.00	1.00
Initial Bse:	129	379	76	350	2	515	78	487	0	0	479	87
Added Vol:	0	0	0	0	0	0	0	0	0	0	0	0
PasserByVol:	0	0	0	0	0	0	0	0	0	0	0	0
Initial Fut:	129	379	76	350	2	515	78	487	0	0	479	87
User Adj:	1.00	1.00	1.00	1.00	1.00	1.00	1.00	1.00	1.00	1.00	1.00	1.00
PHF Adj:	1.00	1.00	1.00	1.00	1.00	1.00	1.00	1.00	1.00	1.00	1.00	1.00
PHF Volume:	129	379	76	350	2	515	78	487	0	0	479	87
Reduct Vol:	0	0	0	0	0	0	0	0	0	0	0	0
Reduced Vol:	129	379	76	350	2	515	78	487	0	0	479	87
PCE Adj:	1.00	1.00	1.00	1.00	1.00	1.00	1.00	1.00	1.00	1.00	1.00	1.00
MLF Adj:	1.00	1.00	1.00	1.00	1.00	1.00	1.00	1.00	1.00	1.00	1.00	1.00
Final Volume:	129	379	76	350	2	515	78	487	0	0	479	87

Saturation Flow Module:												
Sat/Lane:	1900	1900	1900	1900	1900	1900	1900	1900	1900	1900	1900	1900
Adjustment:	0.92	0.98	0.95	0.93	0.95	0.83	0.83	1.00	0.92	0.92	0.99	0.95
Lanes:	1.00	1.66	0.34	1.99	0.01	2.00	2.00	2.00	0.00	0.00	2.52	0.48
Final Sat.:	1750	3082	618	3530	20	3150	3150	3800	0	0	4738	861

Capacity Analysis Module:												
Vol/Sat:	0.07	0.12	0.12	0.10	0.10	0.16	0.02	0.13	0.00	0.00	0.10	0.10
Crit Moves:	****			****			****			****		
Green Time:	52.2	52.2	52.2	69.4	69.4	69.4	10.5	53.4	0.0	0.0	42.9	42.9
Volume/Cap:	0.26	0.44	0.44	0.27	0.27	0.44	0.44	0.45	0.00	0.00	0.44	0.44
Delay/Veh:	52.5	55.6	55.6	41.2	41.2	44.5	87.2	55.0	0.0	0.0	62.0	62.0
User DelAdj:	1.00	1.00	1.00	1.00	1.00	1.00	1.00	1.00	1.00	1.00	1.00	1.00
AdjDel/Veh:	52.5	55.6	55.6	41.2	41.2	44.5	87.2	55.0	0.0	0.0	62.0	62.0
LOS by Move:	D	E	E	D	D	D	F	E	A	A	E	E
HCM2k95thQ:	11	19	19	14	14	23	5	20	0	0	17	17

Note: Queue reported is the number of cars per lane.

BART Phase II Extension Project

Level Of Service Computation Report
 2000 HCM Operations (Future Volume Alternative)
 PM - Existing Plus Project Conditions

Intersection #3013: 87/JULIAN (E) *

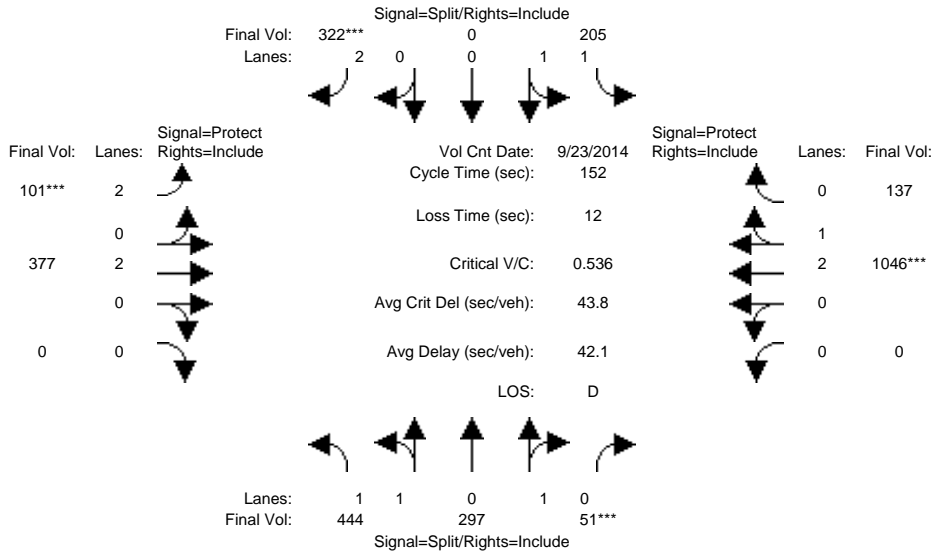

Approach:	North Bound			South Bound			East Bound			West Bound		
Movement:	L	T	R	L	T	R	L	T	R	L	T	R
Min. Green:	10	10	10	10	10	10	7	10	0	0	10	10
Y+R:	4.0	4.0	4.0	4.0	4.0	4.0	4.0	4.0	4.0	4.0	4.0	4.0
Volume Module: >> Count Date: 23 Sep 2014 <<												
Base Vol:	444	297	51	205	0	322	101	377	0	0	1046	137
Growth Adj:	1.00	1.00	1.00	1.00	1.00	1.00	1.00	1.00	1.00	1.00	1.00	1.00
Initial Bse:	444	297	51	205	0	322	101	377	0	0	1046	137
Added Vol:	0	0	0	0	0	0	0	0	0	0	0	0
PasserByVol:	0	0	0	0	0	0	0	0	0	0	0	0
Initial Fut:	444	297	51	205	0	322	101	377	0	0	1046	137
User Adj:	1.00	1.00	1.00	1.00	1.00	1.00	1.00	1.00	1.00	1.00	1.00	1.00
PHF Adj:	1.00	1.00	1.00	1.00	1.00	1.00	1.00	1.00	1.00	1.00	1.00	1.00
PHF Volume:	444	297	51	205	0	322	101	377	0	0	1046	137
Reduct Vol:	0	0	0	0	0	0	0	0	0	0	0	0
Reduced Vol:	444	297	51	205	0	322	101	377	0	0	1046	137
PCE Adj:	1.00	1.00	1.00	1.00	1.00	1.00	1.00	1.00	1.00	1.00	1.00	1.00
MLF Adj:	1.00	1.00	1.00	1.00	1.00	1.00	1.00	1.00	1.00	1.00	1.00	1.00
Final Volume:	444	297	51	205	0	322	101	377	0	0	1046	137
Saturation Flow Module:												
Sat/Lane:	1900	1900	1900	1900	1900	1900	1900	1900	1900	1900	1900	1900
Adjustment:	0.93	0.95	0.95	0.93	1.00	0.83	0.83	1.00	0.92	0.92	0.99	0.95
Lanes:	1.70	1.11	0.19	2.00	0.00	2.00	2.00	2.00	0.00	0.00	2.64	0.36
Final Sat.:	2999	2006	344	3550	0	3150	3150	3800	0	0	4951	648
Capacity Analysis Module:												
Vol/Sat:	0.15	0.15	0.15	0.06	0.00	0.10	0.03	0.10	0.00	0.00	0.21	0.21
Crit Moves:			****			****	****				****	
Green Time:	42.0	42.0	42.0	29.0	0.0	29.0	9.1	69.0	0.0	0.0	59.9	59.9
Volume/Cap:	0.54	0.54	0.54	0.30	0.00	0.54	0.54	0.22	0.00	0.00	0.54	0.54
Delay/Veh:	47.1	47.1	47.1	53.1	0.0	56.4	72.4	25.2	0.0	0.0	35.6	35.6
User DelAdj:	1.00	1.00	1.00	1.00	1.00	1.00	1.00	1.00	1.00	1.00	1.00	1.00
AdjDel/Veh:	47.1	47.1	47.1	53.1	0.0	56.4	72.4	25.2	0.0	0.0	35.6	35.6
LOS by Move:	D	D	D	D	A	E	E	C	A	A	D	D
HCM2k95thQ:	20	20	20	9	0	16	6	10	0	0	25	25

Note: Queue reported is the number of cars per lane.

BART Phase II Extension Project

Level Of Service Computation Report
 2000 HCM Operations (Future Volume Alternative)
 AM - Existing Plus Project Conditions

Intersection #3014: 87/JULIAN (W)

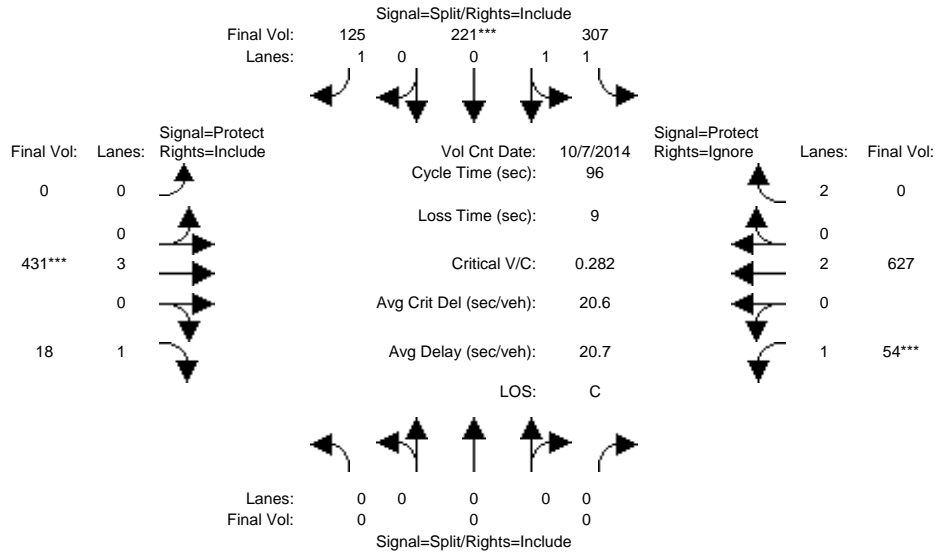

Approach:	North Bound			South Bound			East Bound			West Bound		
	L	T	R	L	T	R	L	T	R	L	T	R
Min. Green:	0	0	0	10	10	10	0	10	10	7	10	10
Y+R:	4.0	4.0	4.0	4.0	4.0	4.0	4.0	4.0	4.0	4.0	4.0	4.0

Volume Module:	>>	Count	Date:	7 Oct 2014	<<							
Base Vol:	0	0	0	307	221	125	0	431	18	54	627	0
Growth Adj:	1.00	1.00	1.00	1.00	1.00	1.00	1.00	1.00	1.00	1.00	1.00	1.00
Initial Bse:	0	0	0	307	221	125	0	431	18	54	627	0
Added Vol:	0	0	0	0	0	0	0	0	0	0	0	0
PasserByVol:	0	0	0	0	0	0	0	0	0	0	0	0
Initial Fut:	0	0	0	307	221	125	0	431	18	54	627	0
User Adj:	1.00	1.00	1.00	1.00	1.00	1.00	1.00	1.00	1.00	1.00	1.00	0.00
PHF Adj:	1.00	1.00	1.00	1.00	1.00	1.00	1.00	1.00	1.00	1.00	1.00	0.00
PHF Volume:	0	0	0	307	221	125	0	431	18	54	627	0
Reduct Vol:	0	0	0	0	0	0	0	0	0	0	0	0
Reduced Vol:	0	0	0	307	221	125	0	431	18	54	627	0
PCE Adj:	1.00	1.00	1.00	1.00	1.00	1.00	1.00	1.00	1.00	1.00	1.00	0.00
MLF Adj:	1.00	1.00	1.00	1.00	1.00	1.00	1.00	1.00	1.00	1.00	1.00	0.00
FinalVolume:	0	0	0	307	221	125	0	431	18	54	627	0

Saturation Flow Module:												
Sat/Lane:	1900	1900	1900	1900	1900	1900	1900	1900	1900	1900	1900	1900
Adjustment:	0.92	1.00	0.92	0.92	0.95	0.92	0.92	1.00	0.92	0.92	1.00	0.83
Lanes:	0.00	0.00	0.00	1.17	0.83	1.00	0.00	3.00	1.00	1.00	2.00	2.00
Final Sat.:	0	0	0	2064	1486	1750	0	5700	1750	1750	3800	3150

Capacity Analysis Module:												
Vol/Sat:	0.00	0.00	0.00	0.15	0.15	0.07	0.00	0.08	0.01	0.03	0.17	0.00
Crit Moves:				****	****	****		****	****	****	****	****
Green Time:	0.0	0.0	0.0	50.7	50.7	50.7	0.0	25.8	25.8	10.5	36.3	0.0
Volume/Cap:	0.00	0.00	0.00	0.28	0.28	0.14	0.00	0.28	0.04	0.28	0.44	0.00
Delay/Veh:	0.0	0.0	0.0	12.6	12.6	11.6	0.0	27.9	26.0	40.1	22.4	0.0
User DelAdj:	1.00	1.00	1.00	1.00	1.00	1.00	1.00	1.00	1.00	1.00	1.00	1.00
AdjDel/Veh:	0.0	0.0	0.0	12.6	12.6	11.6	0.0	27.9	26.0	40.1	22.4	0.0
LOS by Move:	A	A	A	B	B	B	A	C	C	D	C	A
HCM2k95thQ:	0	0	0	9	9	4	0	6	1	3	13	0

Note: Queue reported is the number of cars per lane.

BART Phase II Extension Project

Level Of Service Computation Report
2000 HCM Operations (Future Volume Alternative)
PM - Existing Plus Project Conditions

Intersection #3014: 87/JULIAN (W)

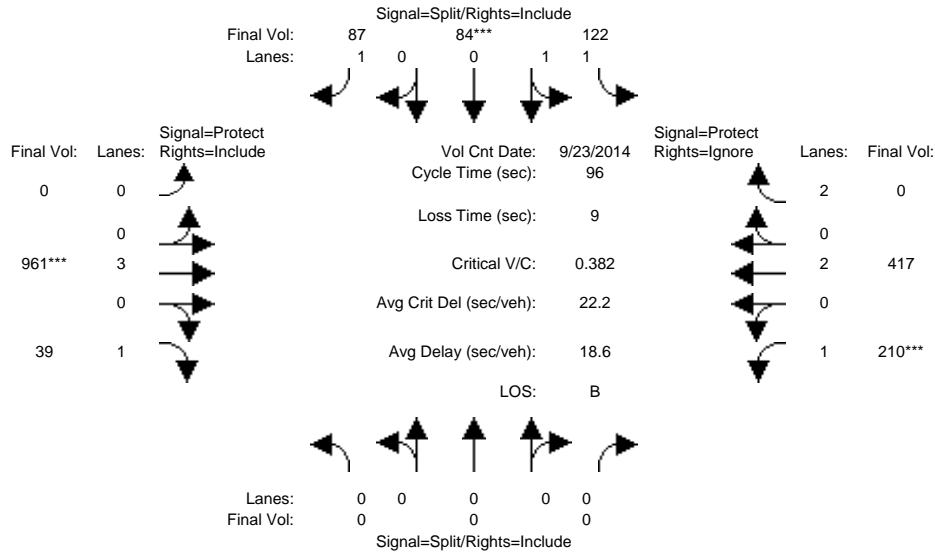

Approach:	North Bound			South Bound			East Bound			West Bound		
	L	T	R	L	T	R	L	T	R	L	T	R
Min. Green:	0	0	0	10	10	10	0	10	10	7	10	10
Y+R:	4.0	4.0	4.0	4.0	4.0	4.0	4.0	4.0	4.0	4.0	4.0	4.0
Volume Module: >> Count Date: 23 Sep 2014 <<												
Base Vol:	0	0	0	122	84	87	0	961	39	210	417	0
Growth Adj:	1.00	1.00	1.00	1.00	1.00	1.00	1.00	1.00	1.00	1.00	1.00	1.00
Initial Bse:	0	0	0	122	84	87	0	961	39	210	417	0
Added Vol:	0	0	0	0	0	0	0	0	0	0	0	0
PasserByVol:	0	0	0	0	0	0	0	0	0	0	0	0
Initial Fut:	0	0	0	122	84	87	0	961	39	210	417	0
User Adj:	1.00	1.00	1.00	1.00	1.00	1.00	1.00	1.00	1.00	1.00	1.00	0.00
PHF Adj:	1.00	1.00	1.00	1.00	1.00	1.00	1.00	1.00	1.00	1.00	1.00	0.00
PHF Volume:	0	0	0	122	84	87	0	961	39	210	417	0
Reduct Vol:	0	0	0	0	0	0	0	0	0	0	0	0
Reduced Vol:	0	0	0	122	84	87	0	961	39	210	417	0
PCE Adj:	1.00	1.00	1.00	1.00	1.00	1.00	1.00	1.00	1.00	1.00	1.00	0.00
MLF Adj:	1.00	1.00	1.00	1.00	1.00	1.00	1.00	1.00	1.00	1.00	1.00	0.00
FinalVolume:	0	0	0	122	84	87	0	961	39	210	417	0
Saturation Flow Module:												
Sat/Lane:	1900	1900	1900	1900	1900	1900	1900	1900	1900	1900	1900	1900
Adjustment:	0.92	1.00	0.92	0.93	0.95	0.92	0.92	1.00	0.92	0.92	1.00	0.83
Lanes:	0.00	0.00	0.00	1.20	0.80	1.00	0.00	3.00	1.00	1.00	2.00	2.00
Final Sat.:	0	0	0	2102	1447	1750	0	5700	1750	1750	3800	3150
Capacity Analysis Module:												
Vol/Sat:	0.00	0.00	0.00	0.06	0.06	0.05	0.00	0.17	0.02	0.12	0.11	0.00
Crit Moves:				****			****			****		
Green Time:	0.0	0.0	0.0	14.6	14.6	14.6	0.0	42.3	42.3	30.1	72.4	0.0
Volume/Cap:	0.00	0.00	0.00	0.38	0.38	0.33	0.00	0.38	0.05	0.38	0.15	0.00
Delay/Veh:	0.0	0.0	0.0	37.1	37.1	37.1	0.0	18.2	15.4	26.1	3.3	0.0
User DelAdj:	1.00	1.00	1.00	1.00	1.00	1.00	1.00	1.00	1.00	1.00	1.00	1.00
AdjDel/Veh:	0.0	0.0	0.0	37.1	37.1	37.1	0.0	18.2	15.4	26.1	3.3	0.0
LOS by Move:	A	A	A	D	D	D	A	B	B	C	A	A
HCM2k95thQ:	0	0	0	7	7	5	0	12	1	10	3	0

Note: Queue reported is the number of cars per lane.

BART Phase II Extension Project

Level Of Service Computation Report
 2000 HCM Operations (Future Volume Alternative)
 AM - Existing Plus Project Conditions

Intersection #3015: 87/SANTA CLARA

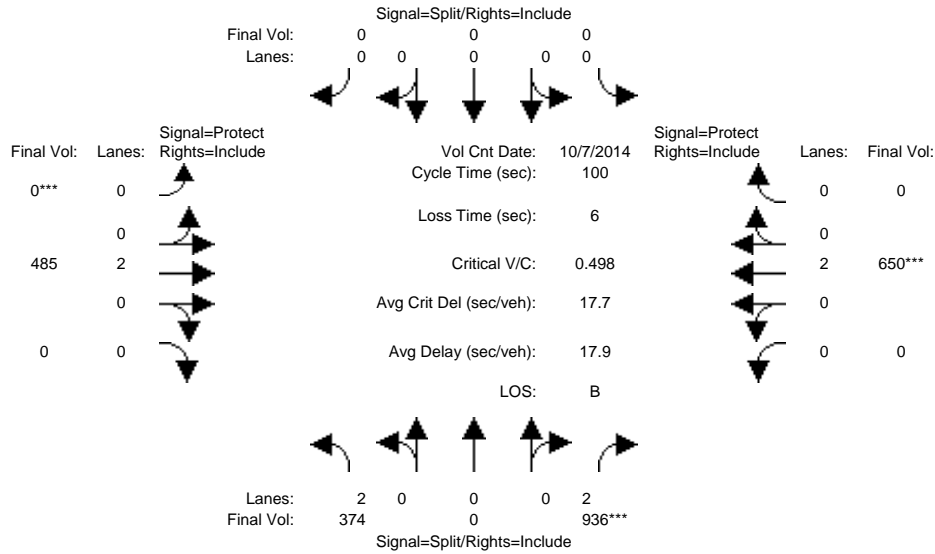

Approach:	North Bound			South Bound			East Bound			West Bound		
	L	T	R	L	T	R	L	T	R	L	T	R
Min. Green:	10	0	10	0	0	0	0	10	0	0	10	0
Y+R:	4.0	4.0	4.0	4.0	4.0	4.0	4.0	4.0	4.0	4.0	4.0	4.0
Volume Module: >> Count Date: 7 Oct 2014 <<												
Base Vol:	374	0	936	0	0	0	0	485	0	0	650	0
Growth Adj:	1.00	1.00	1.00	1.00	1.00	1.00	1.00	1.00	1.00	1.00	1.00	1.00
Initial Bse:	374	0	936	0	0	0	0	485	0	0	650	0
Added Vol:	0	0	0	0	0	0	0	0	0	0	0	0
PasserByVol:	0	0	0	0	0	0	0	0	0	0	0	0
Initial Fut:	374	0	936	0	0	0	0	485	0	0	650	0
User Adj:	1.00	1.00	1.00	1.00	1.00	1.00	1.00	1.00	1.00	1.00	1.00	1.00
PHF Adj:	1.00	1.00	1.00	1.00	1.00	1.00	1.00	1.00	1.00	1.00	1.00	1.00
PHF Volume:	374	0	936	0	0	0	0	485	0	0	650	0
Reduct Vol:	0	0	0	0	0	0	0	0	0	0	0	0
Reduced Vol:	374	0	936	0	0	0	0	485	0	0	650	0
PCE Adj:	1.00	1.00	1.00	1.00	1.00	1.00	1.00	1.00	1.00	1.00	1.00	1.00
MLF Adj:	1.00	1.00	1.00	1.00	1.00	1.00	1.00	1.00	1.00	1.00	1.00	1.00
FinalVolume:	374	0	936	0	0	0	0	485	0	0	650	0
Saturation Flow Module:												
Sat/Lane:	1900	1900	1900	1900	1900	1900	1900	1900	1900	1900	1900	1900
Adjustment:	0.83	1.00	0.83	0.92	1.00	0.92	0.92	1.00	0.92	0.92	1.00	0.92
Lanes:	2.00	0.00	2.00	0.00	0.00	0.00	0.00	2.00	0.00	0.00	2.00	0.00
Final Sat.:	3150	0	3150	0	0	0	0	3800	0	0	3800	0
Capacity Analysis Module:												
Vol/Sat:	0.12	0.00	0.30	0.00	0.00	0.00	0.00	0.13	0.00	0.00	0.17	0.00
Crit Moves:	****			****			****			****		
Green Time:	59.7	0.0	59.7	0.0	0.0	0.0	0.0	34.3	0.0	0.0	34.3	0.0
Volume/Cap:	0.20	0.00	0.50	0.00	0.00	0.00	0.00	0.37	0.00	0.00	0.50	0.00
Delay/Veh:	9.3	0.0	11.8	0.0	0.0	0.0	0.0	24.9	0.0	0.0	26.3	0.0
User DelAdj:	1.00	1.00	1.00	1.00	1.00	1.00	1.00	1.00	1.00	1.00	1.00	1.00
AdjDel/Veh:	9.3	0.0	11.8	0.0	0.0	0.0	0.0	24.9	0.0	0.0	26.3	0.0
LOS by Move:	A	A	B	A	A	A	A	C	A	A	C	A
HCM2k95thQ:	6	0	18	0	0	0	0	11	0	0	15	0

Note: Queue reported is the number of cars per lane.

BART Phase II Extension Project

Level Of Service Computation Report
 2000 HCM Operations (Future Volume Alternative)
 PM - Existing Plus Project Conditions

Intersection #3015: 87/SANTA CLARA

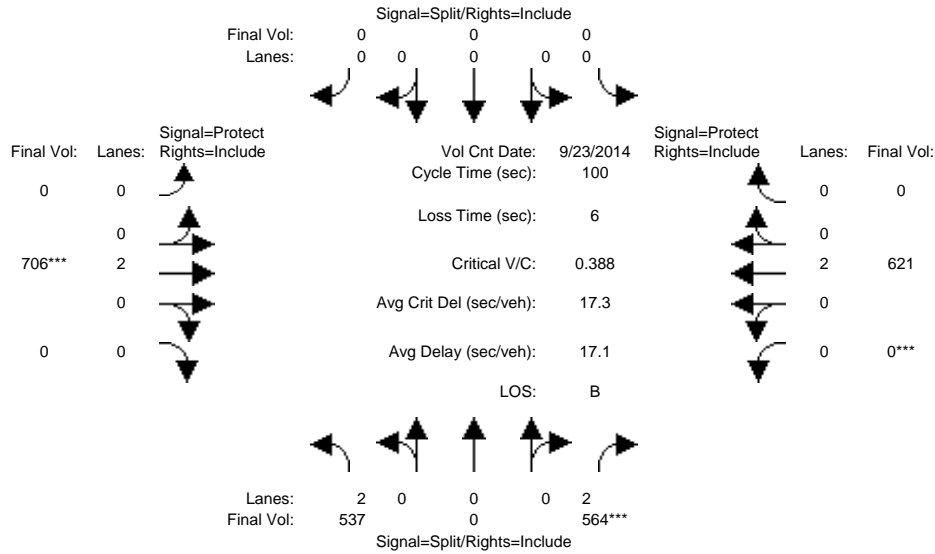

Approach:	North Bound			South Bound			East Bound			West Bound		
	L	T	R	L	T	R	L	T	R	L	T	R
Min. Green:	10	0	10	0	0	0	0	10	0	0	10	0
Y+R:	4.0	4.0	4.0	4.0	4.0	4.0	4.0	4.0	4.0	4.0	4.0	4.0
Volume Module: >> Count Date: 23 Sep 2014 <<												
Base Vol:	537	0	564	0	0	0	0	706	0	0	621	0
Growth Adj:	1.00	1.00	1.00	1.00	1.00	1.00	1.00	1.00	1.00	1.00	1.00	1.00
Initial Bse:	537	0	564	0	0	0	0	706	0	0	621	0
Added Vol:	0	0	0	0	0	0	0	0	0	0	0	0
PasserByVol:	0	0	0	0	0	0	0	0	0	0	0	0
Initial Fut:	537	0	564	0	0	0	0	706	0	0	621	0
User Adj:	1.00	1.00	1.00	1.00	1.00	1.00	1.00	1.00	1.00	1.00	1.00	1.00
PHF Adj:	1.00	1.00	1.00	1.00	1.00	1.00	1.00	1.00	1.00	1.00	1.00	1.00
PHF Volume:	537	0	564	0	0	0	0	706	0	0	621	0
Reduct Vol:	0	0	0	0	0	0	0	0	0	0	0	0
Reduced Vol:	537	0	564	0	0	0	0	706	0	0	621	0
PCE Adj:	1.00	1.00	1.00	1.00	1.00	1.00	1.00	1.00	1.00	1.00	1.00	1.00
MLF Adj:	1.00	1.00	1.00	1.00	1.00	1.00	1.00	1.00	1.00	1.00	1.00	1.00
FinalVolume:	537	0	564	0	0	0	0	706	0	0	621	0
Saturation Flow Module:												
Sat/Lane:	1900	1900	1900	1900	1900	1900	1900	1900	1900	1900	1900	1900
Adjustment:	0.83	1.00	0.83	0.92	1.00	0.92	0.92	1.00	0.92	0.92	1.00	0.92
Lanes:	2.00	0.00	2.00	0.00	0.00	0.00	0.00	2.00	0.00	0.00	2.00	0.00
Final Sat.:	3150	0	3150	0	0	0	0	3800	0	0	3800	0
Capacity Analysis Module:												
Vol/Sat:	0.17	0.00	0.18	0.00	0.00	0.00	0.00	0.19	0.00	0.00	0.16	0.00
Crit Moves:			****					****			****	
Green Time:	46.1	0.0	46.1	0.0	0.0	0.0	0.0	47.9	0.0	0.0	47.9	0.0
Volume/Cap:	0.37	0.00	0.39	0.00	0.00	0.00	0.00	0.39	0.00	0.00	0.34	0.00
Delay/Veh:	17.7	0.0	17.8	0.0	0.0	0.0	0.0	16.8	0.0	0.0	16.4	0.0
User DelAdj:	1.00	1.00	1.00	1.00	1.00	1.00	1.00	1.00	1.00	1.00	1.00	1.00
AdjDel/Veh:	17.7	0.0	17.8	0.0	0.0	0.0	0.0	16.8	0.0	0.0	16.4	0.0
LOS by Move:	B	A	B	A	A	A	A	B	A	A	B	A
HCM2k95thQ:	12	0	13	0	0	0	0	13	0	0	11	0

Note: Queue reported is the number of cars per lane.

BART Phase II Extension Project

Level Of Service Computation Report
 2000 HCM Operations (Future Volume Alternative)
 AM - Existing Plus Project Conditions

Intersection #3032: 280/BIRD (N)

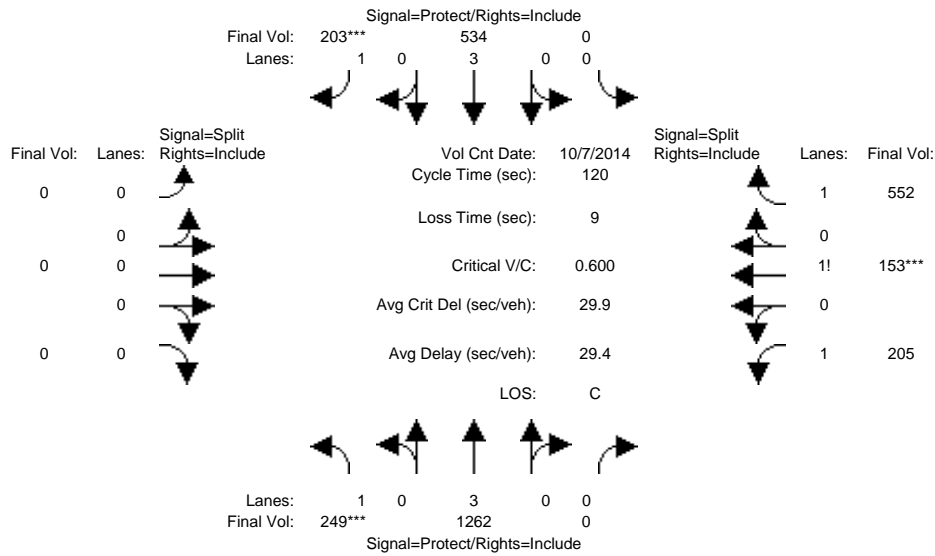

Approach:	North Bound			South Bound			East Bound			West Bound		
Movement:	L	T	R	L	T	R	L	T	R	L	T	R
Min. Green:	7	10	0	0	10	10	0	0	0	10	10	10
Y+R:	4.0	4.0	4.0	4.0	4.0	4.0	4.0	4.0	4.0	4.0	4.0	4.0
Volume Module: >> Count Date: 7 Oct 2014 <<												
Base Vol:	249	1262	0	0	534	203	0	0	0	205	153	552
Growth Adj:	1.00	1.00	1.00	1.00	1.00	1.00	1.00	1.00	1.00	1.00	1.00	1.00
Initial Bse:	249	1262	0	0	534	203	0	0	0	205	153	552
Added Vol:	0	0	0	0	0	0	0	0	0	0	0	0
PasserByVol:	0	0	0	0	0	0	0	0	0	0	0	0
Initial Fut:	249	1262	0	0	534	203	0	0	0	205	153	552
User Adj:	1.00	1.00	1.00	1.00	1.00	1.00	1.00	1.00	1.00	1.00	1.00	1.00
PHF Adj:	1.00	1.00	1.00	1.00	1.00	1.00	1.00	1.00	1.00	1.00	1.00	1.00
PHF Volume:	249	1262	0	0	534	203	0	0	0	205	153	552
Reduct Vol:	0	0	0	0	0	0	0	0	0	0	0	0
Reduced Vol:	249	1262	0	0	534	203	0	0	0	205	153	552
PCE Adj:	1.00	1.00	1.00	1.00	1.00	1.00	1.00	1.00	1.00	1.00	1.00	1.00
MLF Adj:	1.00	1.00	1.00	1.00	1.00	1.00	1.00	1.00	1.00	1.00	1.00	1.00
FinalVolume:	249	1262	0	0	534	203	0	0	0	205	153	552
Saturation Flow Module:												
Sat/Lane:	1900	1900	1900	1900	1900	1900	1900	1900	1900	1900	1900	1900
Adjustment:	0.92	1.00	0.92	0.92	1.00	0.92	0.92	1.00	0.92	0.92	0.95	0.95
Lanes:	1.00	3.00	0.00	0.00	3.00	1.00	0.00	0.00	0.00	1.20	0.28	1.52
Final Sat.:	1750	5700	0	0	5700	1750	0	0	0	2095	515	2730
Capacity Analysis Module:												
Vol/Sat:	0.14	0.22	0.00	0.00	0.09	0.12	0.00	0.00	0.00	0.10	0.30	0.20
Crit Moves:	****					****					****	
Green Time:	28.4	51.6	0.0	0.0	23.2	23.2	0.0	0.0	0.0	59.4	59.4	59.4
Volume/Cap:	0.60	0.51	0.00	0.00	0.48	0.60	0.00	0.00	0.00	0.20	0.60	0.41
Delay/Veh:	43.2	25.2	0.0	0.0	43.4	47.2	0.0	0.0	0.0	17.0	22.5	19.3
User DelAdj:	1.00	1.00	1.00	1.00	1.00	1.00	1.00	1.00	1.00	1.00	1.00	1.00
AdjDel/Veh:	43.2	25.2	0.0	0.0	43.4	47.2	0.0	0.0	0.0	17.0	22.5	19.3
LOS by Move:	D	C	A	A	D	D	A	A	A	B	C	B
HCM2k95thQ:	17	21	0	0	11	14	0	0	0	7	26	16

Note: Queue reported is the number of cars per lane.

BART Phase II Extension Project

Level Of Service Computation Report
 2000 HCM Operations (Future Volume Alternative)
 PM - Existing Plus Project Conditions

Intersection #3032: 280/BIRD (N)

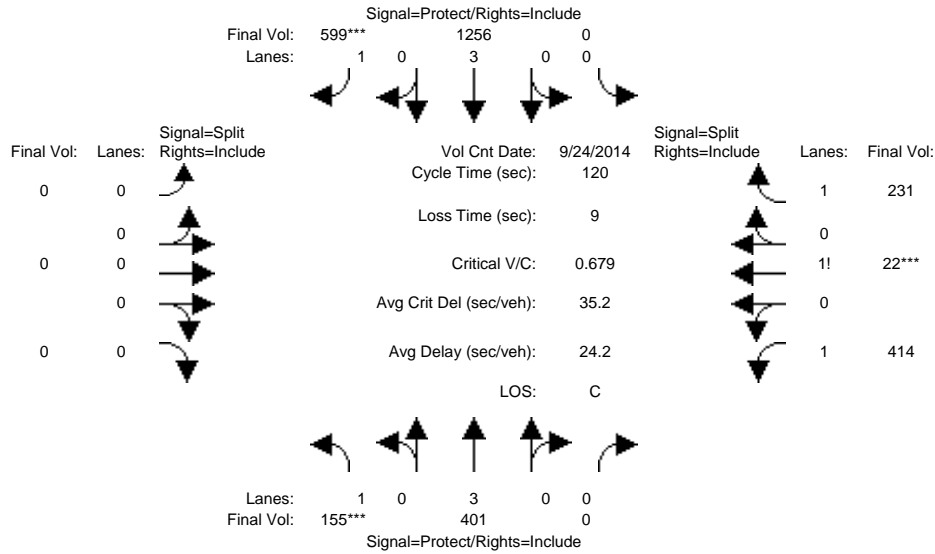

Approach:	North Bound			South Bound			East Bound			West Bound		
	L	T	R	L	T	R	L	T	R	L	T	R
Min. Green:	7	10	0	0	10	10	0	0	0	10	10	10
Y+R:	4.0	4.0	4.0	4.0	4.0	4.0	4.0	4.0	4.0	4.0	4.0	4.0
Volume Module: >> Count Date: 24 Sep 2014 <<												
Base Vol:	155	401	0	0	1256	599	0	0	0	414	22	231
Growth Adj:	1.00	1.00	1.00	1.00	1.00	1.00	1.00	1.00	1.00	1.00	1.00	1.00
Initial Bse:	155	401	0	0	1256	599	0	0	0	414	22	231
Added Vol:	0	0	0	0	0	0	0	0	0	0	0	0
PasserByVol:	0	0	0	0	0	0	0	0	0	0	0	0
Initial Fut:	155	401	0	0	1256	599	0	0	0	414	22	231
User Adj:	1.00	1.00	1.00	1.00	1.00	1.00	1.00	1.00	1.00	1.00	1.00	1.00
PHF Adj:	1.00	1.00	1.00	1.00	1.00	1.00	1.00	1.00	1.00	1.00	1.00	1.00
PHF Volume:	155	401	0	0	1256	599	0	0	0	414	22	231
Reduct Vol:	0	0	0	0	0	0	0	0	0	0	0	0
Reduced Vol:	155	401	0	0	1256	599	0	0	0	414	22	231
PCE Adj:	1.00	1.00	1.00	1.00	1.00	1.00	1.00	1.00	1.00	1.00	1.00	1.00
MLF Adj:	1.00	1.00	1.00	1.00	1.00	1.00	1.00	1.00	1.00	1.00	1.00	1.00
FinalVolume:	155	401	0	0	1256	599	0	0	0	414	22	231
Saturation Flow Module:												
Sat/Lane:	1900	1900	1900	1900	1900	1900	1900	1900	1900	1900	1900	1900
Adjustment:	0.92	1.00	0.92	0.92	1.00	0.92	0.92	1.00	0.92	0.92	0.92	0.92
Lanes:	1.00	3.00	0.00	0.00	3.00	1.00	0.00	0.00	0.00	1.60	0.06	1.34
Final Sat.:	1750	5700	0	0	5700	1750	0	0	0	2802	112	2337
Capacity Analysis Module:												
Vol/Sat:	0.09	0.07	0.00	0.00	0.22	0.34	0.00	0.00	0.00	0.15	0.20	0.10
Crit Moves:	****				****					****		
Green Time:	15.7	76.2	0.0	0.0	60.5	60.5	0.0	0.0	0.0	34.8	34.8	34.8
Volume/Cap:	0.68	0.11	0.00	0.00	0.44	0.68	0.00	0.00	0.00	0.51	0.68	0.34
Delay/Veh:	57.7	8.6	0.0	0.0	19.0	24.6	0.0	0.0	0.0	35.8	39.6	33.7
User DelAdj:	1.00	1.00	1.00	1.00	1.00	1.00	1.00	1.00	1.00	1.00	1.00	1.00
AdjDel/Veh:	57.7	8.6	0.0	0.0	19.0	24.6	0.0	0.0	0.0	35.8	39.6	33.7
LOS by Move:	E	A	A	A	B	C	A	A	A	D	D	C
HCM2k95thQ:	14	4	0	0	17	30	0	0	0	16	23	11

Note: Queue reported is the number of cars per lane.

BART Phase II Extension Project

Level Of Service Computation Report
 2000 HCM Operations (Future Volume Alternative)
 AM - Existing Plus Project Conditions

Intersection #3033: 280/BIRD (S)

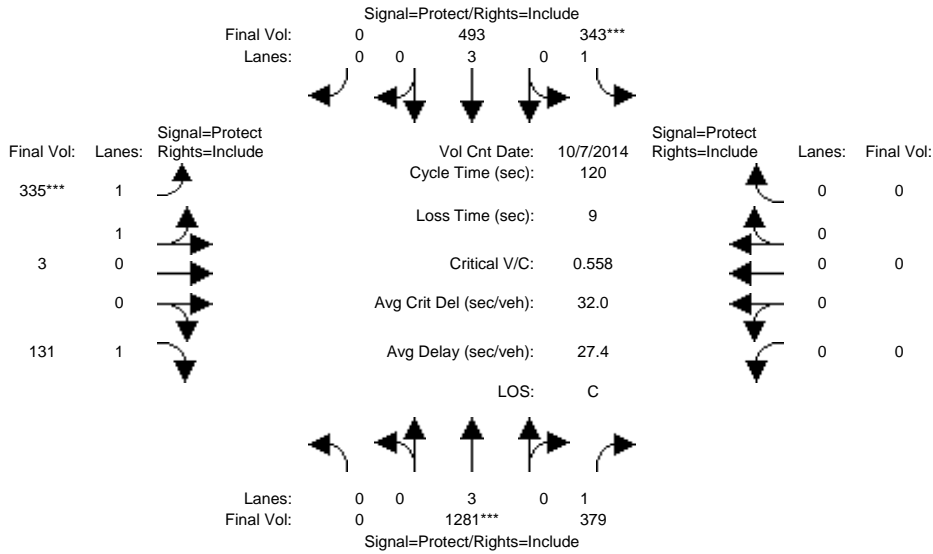

Approach:	North Bound			South Bound			East Bound			West Bound		
	L	T	R	L	T	R	L	T	R	L	T	R
Min. Green:	0	10	10	7	10	0	10	10	10	0	0	0
Y+R:	4.0	4.0	4.0	4.0	4.0	4.0	4.0	4.0	4.0	4.0	4.0	4.0
Volume Module: >> Count Date: 7 Oct 2014 <<												
Base Vol:	0	1281	379	343	493	0	335	3	131	0	0	0
Growth Adj:	1.00	1.00	1.00	1.00	1.00	1.00	1.00	1.00	1.00	1.00	1.00	1.00
Initial Bse:	0	1281	379	343	493	0	335	3	131	0	0	0
Added Vol:	0	0	0	0	0	0	0	0	0	0	0	0
PasserByVol:	0	0	0	0	0	0	0	0	0	0	0	0
Initial Fut:	0	1281	379	343	493	0	335	3	131	0	0	0
User Adj:	1.00	1.00	1.00	1.00	1.00	1.00	1.00	1.00	1.00	1.00	1.00	1.00
PHF Adj:	1.00	1.00	1.00	1.00	1.00	1.00	1.00	1.00	1.00	1.00	1.00	1.00
PHF Volume:	0	1281	379	343	493	0	335	3	131	0	0	0
Reduct Vol:	0	0	0	0	0	0	0	0	0	0	0	0
Reduced Vol:	0	1281	379	343	493	0	335	3	131	0	0	0
PCE Adj:	1.00	1.00	1.00	1.00	1.00	1.00	1.00	1.00	1.00	1.00	1.00	1.00
MLF Adj:	1.00	1.00	1.00	1.00	1.00	1.00	1.00	1.00	1.00	1.00	1.00	1.00
FinalVolume:	0	1281	379	343	493	0	335	3	131	0	0	0
Saturation Flow Module:												
Sat/Lane:	1900	1900	1900	1900	1900	1900	1900	1900	1900	1900	1900	1900
Adjustment:	0.92	1.00	0.92	0.92	1.00	0.92	0.93	0.95	0.92	0.92	1.00	0.92
Lanes:	0.00	3.00	1.00	1.00	3.00	0.00	1.98	0.02	1.00	0.00	0.00	0.00
Final Sat.:	0	5700	1750	1750	5700	0	3518	32	1750	0	0	0
Capacity Analysis Module:												
Vol/Sat:	0.00	0.22	0.22	0.20	0.09	0.00	0.10	0.10	0.07	0.00	0.00	0.00
Crit Moves:	****			****			****					
Green Time:	0.0	48.3	48.3	42.2	90.5	0.0	20.5	20.5	20.5	0.0	0.0	0.0
Volume/Cap:	0.00	0.56	0.54	0.56	0.11	0.00	0.56	0.56	0.44	0.00	0.00	0.00
Delay/Veh:	0.0	27.9	28.1	32.5	4.0	0.0	46.8	46.8	45.6	0.0	0.0	0.0
User DelAdj:	1.00	1.00	1.00	1.00	1.00	1.00	1.00	1.00	1.00	1.00	1.00	1.00
AdjDel/Veh:	0.0	27.9	28.1	32.5	4.0	0.0	46.8	46.8	45.6	0.0	0.0	0.0
LOS by Move:	A	C	C	C	A	A	D	D	D	A	A	A
HCM2k95thQ:	0	21	20	20	3	0	13	13	10	0	0	0

Note: Queue reported is the number of cars per lane.

BART Phase II Extension Project

Level Of Service Computation Report
 2000 HCM Operations (Future Volume Alternative)
 PM - Existing Plus Project Conditions

Intersection #3033: 280/BIRD (S)

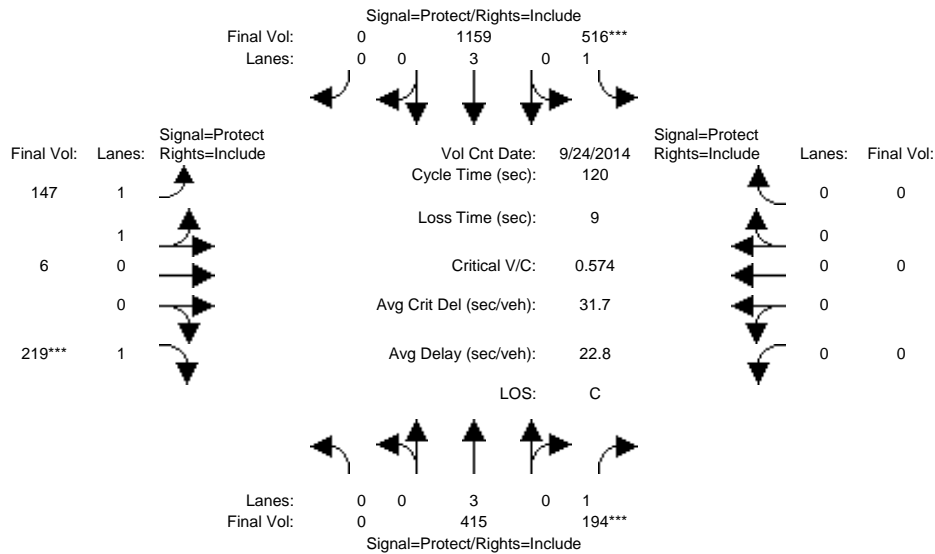

Approach:	North Bound			South Bound			East Bound			West Bound		
	L	T	R	L	T	R	L	T	R	L	T	R
Min. Green:	0	10	10	7	10	0	10	10	10	0	0	0
Y+R:	4.0	4.0	4.0	4.0	4.0	4.0	4.0	4.0	4.0	4.0	4.0	4.0

Volume Module:	>>	Count	Date:	24 Sep 2014	<<												
Base Vol:	0	415	194	516	1159	0	147	6	219	0	0	0					
Growth Adj:	1.00	1.00	1.00	1.00	1.00	1.00	1.00	1.00	1.00	1.00	1.00	1.00					
Initial Bse:	0	415	194	516	1159	0	147	6	219	0	0	0					
Added Vol:	0	0	0	0	0	0	0	0	0	0	0	0					
PasserByVol:	0	0	0	0	0	0	0	0	0	0	0	0					
Initial Fut:	0	415	194	516	1159	0	147	6	219	0	0	0					
User Adj:	1.00	1.00	1.00	1.00	1.00	1.00	1.00	1.00	1.00	1.00	1.00	1.00					
PHF Adj:	1.00	1.00	1.00	1.00	1.00	1.00	1.00	1.00	1.00	1.00	1.00	1.00					
PHF Volume:	0	415	194	516	1159	0	147	6	219	0	0	0					
Reduct Vol:	0	0	0	0	0	0	0	0	0	0	0	0					
Reduced Vol:	0	415	194	516	1159	0	147	6	219	0	0	0					
PCE Adj:	1.00	1.00	1.00	1.00	1.00	1.00	1.00	1.00	1.00	1.00	1.00	1.00					
MLF Adj:	1.00	1.00	1.00	1.00	1.00	1.00	1.00	1.00	1.00	1.00	1.00	1.00					
FinalVolume:	0	415	194	516	1159	0	147	6	219	0	0	0					

Saturation Flow Module:												
Sat/Lane:	1900	1900	1900	1900	1900	1900	1900	1900	1900	1900	1900	1900
Adjustment:	0.92	1.00	0.92	0.92	1.00	0.92	0.93	0.95	0.92	0.92	1.00	0.92
Lanes:	0.00	3.00	1.00	1.00	3.00	0.00	1.92	0.08	1.00	0.00	0.00	0.00
Final Sat.:	0	5700	1750	1750	5700	0	3411	139	1750	0	0	0

Capacity Analysis Module:												
Vol/Sat:	0.00	0.07	0.11	0.29	0.20	0.00	0.04	0.04	0.13	0.00	0.00	0.00
Crit Moves:			****	****					****			
Green Time:	0.0	23.2	23.2	61.7	84.8	0.0	26.2	26.2	26.2	0.0	0.0	0.0
Volume/Cap:	0.00	0.38	0.57	0.57	0.29	0.00	0.20	0.20	0.57	0.00	0.00	0.00
Delay/Veh:	0.0	42.3	46.3	21.0	6.5	0.0	38.5	38.5	44.1	0.0	0.0	0.0
User DelAdj:	1.00	1.00	1.00	1.00	1.00	1.00	1.00	1.00	1.00	1.00	1.00	1.00
AdjDel/Veh:	0.0	42.3	46.3	21.0	6.5	0.0	38.5	38.5	44.1	0.0	0.0	0.0
LOS by Move:	A	D	D	C	A	A	D	D	D	A	A	A
HCM2k95thQ:	0	8	13	25	10	0	5	5	16	0	0	0

Note: Queue reported is the number of cars per lane.

BART Phase II Extension Project

Level Of Service Computation Report
2000 HCM Operations (Future Volume Alternative)
AM - Existing Plus Project Conditions

Intersection #3058: ALAMEDA/NAGLEE

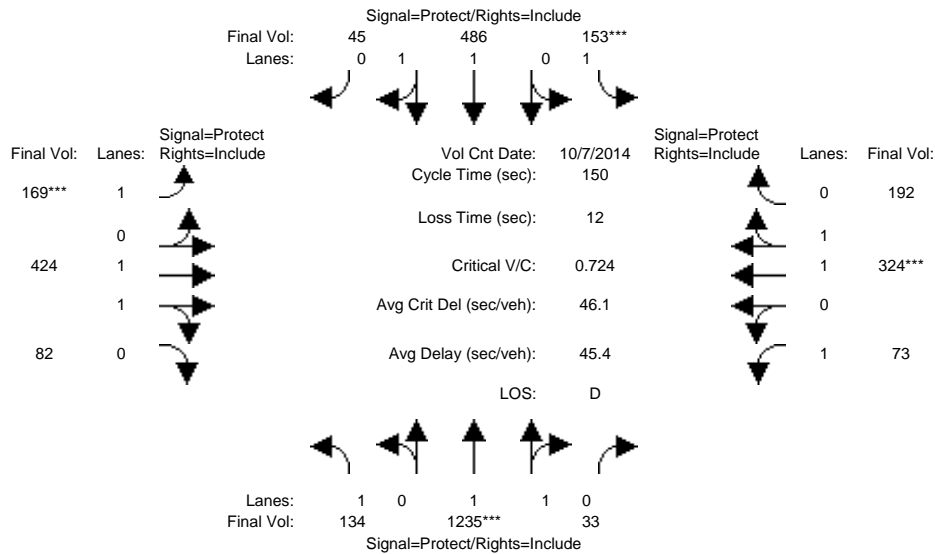

Approach:	North Bound			South Bound			East Bound			West Bound		
	L	T	R	L	T	R	L	T	R	L	T	R
Min. Green:	7	10	10	7	10	10	7	10	10	7	10	10
Y+R:	4.0	4.0	4.0	4.0	4.0	4.0	4.0	4.0	4.0	4.0	4.0	4.0
Volume Module: >> Count Date: 7 Oct 2014 <<												
Base Vol:	134	1235	33	153	486	45	169	424	82	73	324	192
Growth Adj:	1.00	1.00	1.00	1.00	1.00	1.00	1.00	1.00	1.00	1.00	1.00	1.00
Initial Bse:	134	1235	33	153	486	45	169	424	82	73	324	192
Added Vol:	0	0	0	0	0	0	0	0	0	0	0	0
PasserByVol:	0	0	0	0	0	0	0	0	0	0	0	0
Initial Fut:	134	1235	33	153	486	45	169	424	82	73	324	192
User Adj:	1.00	1.00	1.00	1.00	1.00	1.00	1.00	1.00	1.00	1.00	1.00	1.00
PHF Adj:	1.00	1.00	1.00	1.00	1.00	1.00	1.00	1.00	1.00	1.00	1.00	1.00
PHF Volume:	134	1235	33	153	486	45	169	424	82	73	324	192
Reduct Vol:	0	0	0	0	0	0	0	0	0	0	0	0
Reduced Vol:	134	1235	33	153	486	45	169	424	82	73	324	192
PCE Adj:	1.00	1.00	1.00	1.00	1.00	1.00	1.00	1.00	1.00	1.00	1.00	1.00
MLF Adj:	1.00	1.00	1.00	1.00	1.00	1.00	1.00	1.00	1.00	1.00	1.00	1.00
Final Volume:	134	1235	33	153	486	45	169	424	82	73	324	192
Saturation Flow Module:												
Sat/Lane:	1900	1900	1900	1900	1900	1900	1900	1900	1900	1900	1900	1900
Adjustment:	0.92	0.97	0.95	0.92	0.98	0.95	0.92	0.98	0.95	0.92	0.99	0.95
Lanes:	1.00	1.95	0.05	1.00	1.83	0.17	1.00	1.67	0.33	1.00	1.24	0.76
Final Sat.:	1750	3604	96	1750	3386	314	1750	3100	600	1750	2322	1376
Capacity Analysis Module:												
Vol/Sat:	0.08	0.34	0.34	0.09	0.14	0.14	0.10	0.14	0.14	0.04	0.14	0.14
Crit Moves:	****	****	****	****	****	****	****	****	****	****	****	****
Green Time:	31.0	71.0	71.0	18.1	58.1	58.1	20.0	36.5	36.5	12.4	28.9	28.9
Volume/Cap:	0.37	0.72	0.72	0.72	0.37	0.37	0.72	0.56	0.56	0.50	0.72	0.72
Delay/Veh:	51.8	33.2	33.2	75.3	33.0	33.0	73.0	50.6	50.6	68.6	60.5	60.5
User DelAdj:	1.00	1.00	1.00	1.00	1.00	1.00	1.00	1.00	1.00	1.00	1.00	1.00
AdjDel/Veh:	51.8	33.2	33.2	75.3	33.0	33.0	73.0	50.6	50.6	68.6	60.5	60.5
LOS by Move:	D	C	C	E	C	C	E	D	D	E	E	E
HCM2k95thQ:	11	40	40	14	16	16	18	20	20	7	21	21

Note: Queue reported is the number of cars per lane.

BART Phase II Extension Project

Level Of Service Computation Report
 2000 HCM Operations (Future Volume Alternative)
 PM - Existing Plus Project Conditions

Intersection #3058: ALAMEDA/NAGLEE

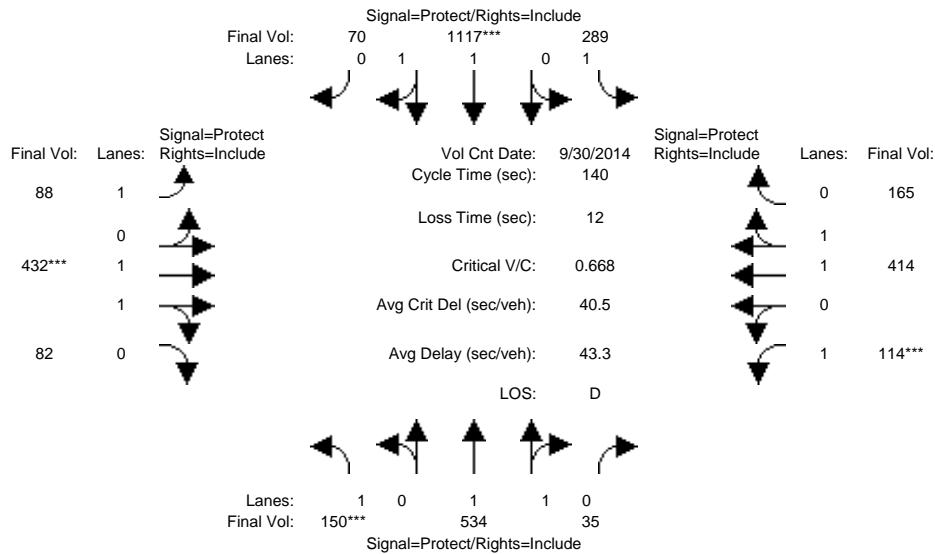

Approach:	North Bound			South Bound			East Bound			West Bound		
	L	T	R	L	T	R	L	T	R	L	T	R
Min. Green:	7	10	10	7	10	10	7	10	10	7	10	10
Y+R:	4.0	4.0	4.0	4.0	4.0	4.0	4.0	4.0	4.0	4.0	4.0	4.0
Volume Module: >> Count Date: 30 Sep 2014 <<												
Base Vol:	150	534	35	289	1117	70	88	432	82	114	414	165
Growth Adj:	1.00	1.00	1.00	1.00	1.00	1.00	1.00	1.00	1.00	1.00	1.00	1.00
Initial Bse:	150	534	35	289	1117	70	88	432	82	114	414	165
Added Vol:	0	0	0	0	0	0	0	0	0	0	0	0
PasserByVol:	0	0	0	0	0	0	0	0	0	0	0	0
Initial Fut:	150	534	35	289	1117	70	88	432	82	114	414	165
User Adj:	1.00	1.00	1.00	1.00	1.00	1.00	1.00	1.00	1.00	1.00	1.00	1.00
PHF Adj:	1.00	1.00	1.00	1.00	1.00	1.00	1.00	1.00	1.00	1.00	1.00	1.00
PHF Volume:	150	534	35	289	1117	70	88	432	82	114	414	165
Reduct Vol:	0	0	0	0	0	0	0	0	0	0	0	0
Reduced Vol:	150	534	35	289	1117	70	88	432	82	114	414	165
PCE Adj:	1.00	1.00	1.00	1.00	1.00	1.00	1.00	1.00	1.00	1.00	1.00	1.00
MLF Adj:	1.00	1.00	1.00	1.00	1.00	1.00	1.00	1.00	1.00	1.00	1.00	1.00
FinalVolume:	150	534	35	289	1117	70	88	432	82	114	414	165
Saturation Flow Module:												
Sat/Lane:	1900	1900	1900	1900	1900	1900	1900	1900	1900	1900	1900	1900
Adjustment:	0.92	0.98	0.95	0.92	0.98	0.95	0.92	0.98	0.95	0.92	0.98	0.95
Lanes:	1.00	1.87	0.13	1.00	1.88	0.12	1.00	1.67	0.33	1.00	1.41	0.59
Final Sat.:	1750	3472	228	1750	3482	218	1750	3109	590	1750	2645	1054
Capacity Analysis Module:												
Vol/Sat:	0.09	0.15	0.15	0.17	0.32	0.32	0.05	0.14	0.14	0.07	0.16	0.16
Crit Moves:	****			****			****			****		
Green Time:	18.0	41.1	41.1	44.1	67.3	67.3	10.4	29.1	29.1	13.7	32.4	32.4
Volume/Cap:	0.67	0.52	0.52	0.52	0.67	0.67	0.68	0.67	0.67	0.67	0.68	0.68
Delay/Veh:	65.7	41.8	41.8	40.2	28.8	28.8	76.5	53.3	53.3	70.7	51.2	51.2
User DelAdj:	1.00	1.00	1.00	1.00	1.00	1.00	1.00	1.00	1.00	1.00	1.00	1.00
AdjDel/Veh:	65.7	41.8	41.8	40.2	28.8	28.8	76.5	53.3	53.3	70.7	51.2	51.2
LOS by Move:	E	D	D	D	C	C	E	D	D	E	D	D
HCM2k95thQ:	15	19	19	20	34	34	10	20	20	10	21	21

Note: Queue reported is the number of cars per lane.

BART Phase II Extension Project

Level Of Service Computation Report
2000 HCM Operations (Future Volume Alternative)
AM - Existing Plus Project Conditions

Intersection #3059: ALAMEDA/RACE *

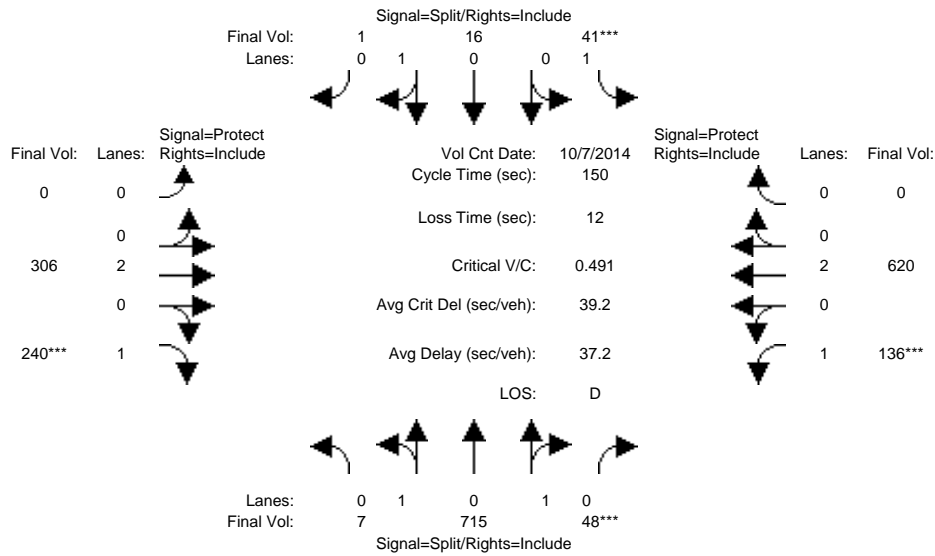

Approach:	North Bound			South Bound			East Bound			West Bound		
	L	T	R	L	T	R	L	T	R	L	T	R
Min. Green:	10	10	10	10	10	10	0	10	10	7	10	0
Y+R:	4.0	4.0	4.0	4.0	4.0	4.0	4.0	4.0	4.0	4.0	4.0	4.0
Volume Module: >> Count Date: 7 Oct 2014 <<												
Base Vol:	7	715	48	41	16	1	0	306	240	136	620	0
Growth Adj:	1.00	1.00	1.00	1.00	1.00	1.00	1.00	1.00	1.00	1.00	1.00	1.00
Initial Bse:	7	715	48	41	16	1	0	306	240	136	620	0
Added Vol:	0	0	0	0	0	0	0	0	0	0	0	0
PasserByVol:	0	0	0	0	0	0	0	0	0	0	0	0
Initial Fut:	7	715	48	41	16	1	0	306	240	136	620	0
User Adj:	1.00	1.00	1.00	1.00	1.00	1.00	1.00	1.00	1.00	1.00	1.00	1.00
PHF Adj:	1.00	1.00	1.00	1.00	1.00	1.00	1.00	1.00	1.00	1.00	1.00	1.00
PHF Volume:	7	715	48	41	16	1	0	306	240	136	620	0
Reduct Vol:	0	0	0	0	0	0	0	0	0	0	0	0
Reduced Vol:	7	715	48	41	16	1	0	306	240	136	620	0
PCE Adj:	1.00	1.00	1.00	1.00	1.00	1.00	1.00	1.00	1.00	1.00	1.00	1.00
MLF Adj:	1.00	1.00	1.00	1.00	1.00	1.00	1.00	1.00	1.00	1.00	1.00	1.00
Final Volume:	7	715	48	41	16	1	0	306	240	136	620	0
Saturation Flow Module:												
Sat/Lane:	1900	1900	1900	1900	1900	1900	1900	1900	1900	1900	1900	1900
Adjustment:	0.95	0.95	0.95	0.92	0.95	0.95	0.92	1.00	0.92	0.92	1.00	0.92
Lanes:	0.02	1.86	0.12	1.00	0.94	0.06	0.00	2.00	1.00	1.00	2.00	0.00
Final Sat.:	33	3343	224	1750	1694	106	0	3800	1750	1750	3800	0
Capacity Analysis Module:												
Vol/Sat:	0.21	0.21	0.21	0.02	0.01	0.01	0.00	0.08	0.14	0.08	0.16	0.00
Crit Moves:	****			****			****			****		
Green Time:	63.9	63.9	63.9	10.0	10.0	10.0	0.0	40.9	40.9	23.2	64.1	0.0
Volume/Cap:	0.50	0.50	0.50	0.35	0.14	0.14	0.00	0.30	0.50	0.50	0.38	0.00
Delay/Veh:	31.7	31.7	31.7	68.7	66.5	66.5	0.0	43.3	46.8	59.6	29.5	0.0
User DelAdj:	1.00	1.00	1.00	1.00	1.00	1.00	1.00	1.00	1.00	1.00	1.00	1.00
AdjDel/Veh:	31.7	31.7	31.7	68.7	66.5	66.5	0.0	43.3	46.8	59.6	29.5	0.0
LOS by Move:	C	C	C	E	E	E	A	D	D	E	C	A
HCM2k95thQ:	24	24	24	5	2	2	0	10	18	12	17	0

Note: Queue reported is the number of cars per lane.

BART Phase II Extension Project

Level Of Service Computation Report
 2000 HCM Operations (Future Volume Alternative)
 PM - Existing Plus Project Conditions

Intersection #3059: ALAMEDA/RACE *

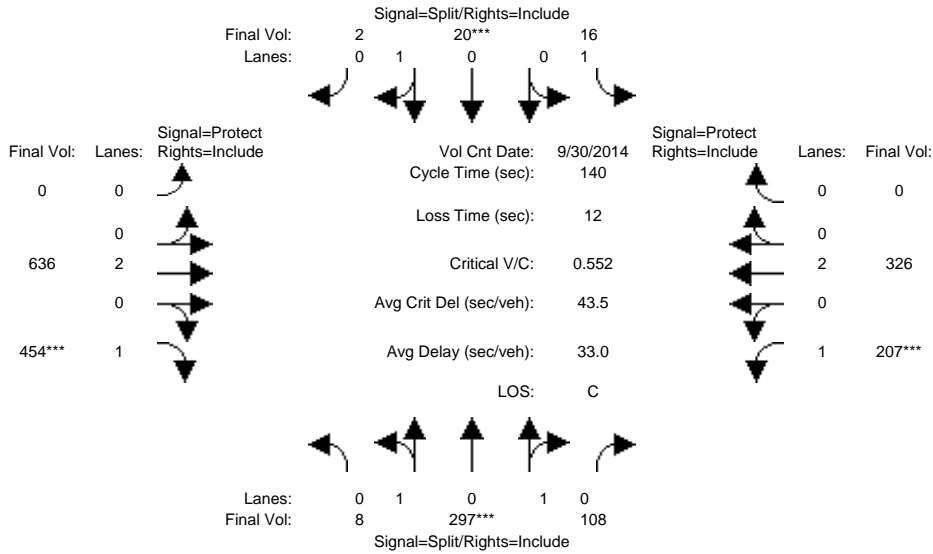

Approach:	North Bound			South Bound			East Bound			West Bound		
	L	T	R	L	T	R	L	T	R	L	T	R
Min. Green:	10	10	10	10	10	10	0	10	10	7	10	0
Y+R:	4.0	4.0	4.0	4.0	4.0	4.0	4.0	4.0	4.0	4.0	4.0	4.0
Volume Module: >> Count Date: 30 Sep 2014 <<												
Base Vol:	8	297	108	16	20	2	0	636	454	207	326	0
Growth Adj:	1.00	1.00	1.00	1.00	1.00	1.00	1.00	1.00	1.00	1.00	1.00	1.00
Initial Bse:	8	297	108	16	20	2	0	636	454	207	326	0
Added Vol:	0	0	0	0	0	0	0	0	0	0	0	0
PasserByVol:	0	0	0	0	0	0	0	0	0	0	0	0
Initial Fut:	8	297	108	16	20	2	0	636	454	207	326	0
User Adj:	1.00	1.00	1.00	1.00	1.00	1.00	1.00	1.00	1.00	1.00	1.00	1.00
PHF Adj:	1.00	1.00	1.00	1.00	1.00	1.00	1.00	1.00	1.00	1.00	1.00	1.00
PHF Volume:	8	297	108	16	20	2	0	636	454	207	326	0
Reduct Vol:	0	0	0	0	0	0	0	0	0	0	0	0
Reduced Vol:	8	297	108	16	20	2	0	636	454	207	326	0
PCE Adj:	1.00	1.00	1.00	1.00	1.00	1.00	1.00	1.00	1.00	1.00	1.00	1.00
MLF Adj:	1.00	1.00	1.00	1.00	1.00	1.00	1.00	1.00	1.00	1.00	1.00	1.00
Final Volume:	8	297	108	16	20	2	0	636	454	207	326	0
Saturation Flow Module:												
Sat/Lane:	1900	1900	1900	1900	1900	1900	1900	1900	1900	1900	1900	1900
Adjustment:	0.95	0.95	0.95	0.92	0.95	0.95	0.92	1.00	0.92	0.92	1.00	0.92
Lanes:	0.04	1.44	0.52	1.00	0.91	0.09	0.00	2.00	1.00	1.00	2.00	0.00
Final Sat.:	70	2589	941	1750	1636	164	0	3800	1750	1750	3800	0
Capacity Analysis Module:												
Vol/Sat:	0.11	0.11	0.11	0.01	0.01	0.01	0.00	0.17	0.26	0.12	0.09	0.00
Crit Moves:	****			****			****			****		
Green Time:	27.5	27.5	27.5	10.0	10.0	10.0	0.0	62.2	62.2	28.3	90.5	0.0
Volume/Cap:	0.58	0.58	0.58	0.13	0.17	0.17	0.00	0.38	0.58	0.58	0.13	0.00
Delay/Veh:	52.3	52.3	52.3	61.4	61.7	61.7	0.0	26.1	30.4	53.0	9.6	0.0
User DelAdj:	1.00	1.00	1.00	1.00	1.00	1.00	1.00	1.00	1.00	1.00	1.00	1.00
AdjDel/Veh:	52.3	52.3	52.3	61.4	61.7	61.7	0.0	26.1	30.4	53.0	9.6	0.0
LOS by Move:	D	D	D	E	E	E	A	C	C	D	A	A
HCM2k95thQ:	16	16	16	2	2	2	0	16	27	16	5	0

Note: Queue reported is the number of cars per lane.

BART Phase II Extension Project

Level Of Service Computation Report
 2000 HCM Operations (Future Volume Alternative)
 AM - Existing Plus Project Conditions

Intersection #3066: AUTUMN/SANTA CLARA

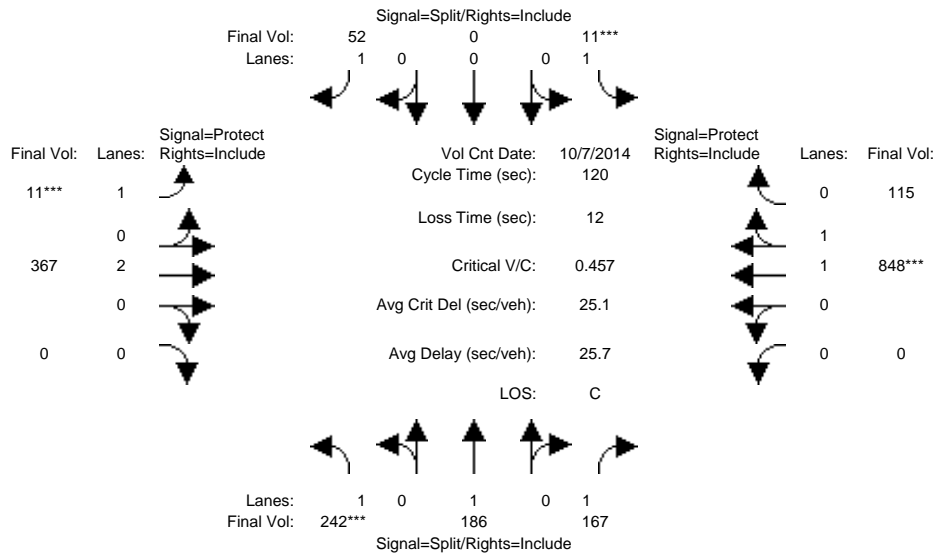

Approach:	North Bound			South Bound			East Bound			West Bound		
	L	T	R	L	T	R	L	T	R	L	T	R
Min. Green:	10	10	10	10	0	10	7	10	0	0	10	10
Y+R:	4.0	4.0	4.0	4.0	4.0	4.0	4.0	4.0	4.0	4.0	4.0	4.0

Volume Module: >> Count Date: 7 Oct 2014 <<

Base Vol:	242	186	167	11	0	52	11	367	0	0	848	115
Growth Adj:	1.00	1.00	1.00	1.00	1.00	1.00	1.00	1.00	1.00	1.00	1.00	1.00
Initial Bse:	242	186	167	11	0	52	11	367	0	0	848	115
Added Vol:	0	0	0	0	0	0	0	0	0	0	0	0
PasserByVol:	0	0	0	0	0	0	0	0	0	0	0	0
Initial Fut:	242	186	167	11	0	52	11	367	0	0	848	115
User Adj:	1.00	1.00	1.00	1.00	1.00	1.00	1.00	1.00	1.00	1.00	1.00	1.00
PHF Adj:	1.00	1.00	1.00	1.00	1.00	1.00	1.00	1.00	1.00	1.00	1.00	1.00
PHF Volume:	242	186	167	11	0	52	11	367	0	0	848	115
Reduct Vol:	0	0	0	0	0	0	0	0	0	0	0	0
Reduced Vol:	242	186	167	11	0	52	11	367	0	0	848	115
PCE Adj:	1.00	1.00	1.00	1.00	1.00	1.00	1.00	1.00	1.00	1.00	1.00	1.00
MLF Adj:	1.00	1.00	1.00	1.00	1.00	1.00	1.00	1.00	1.00	1.00	1.00	1.00
FinalVolume:	242	186	167	11	0	52	11	367	0	0	848	115

Saturation Flow Module:

Sat/Lane:	1900	1900	1900	1900	1900	1900	1900	1900	1900	1900	1900	1900
Adjustment:	0.92	1.00	0.92	0.92	1.00	0.92	0.92	1.00	0.92	0.92	0.98	0.95
Lanes:	1.00	1.00	1.00	1.00	0.00	1.00	1.00	2.00	0.00	0.00	1.75	0.25
Final Sat.:	1750	1900	1750	1750	0	1750	1750	3800	0	0	3258	442

Capacity Analysis Module:

Vol/Sat:	0.14	0.10	0.10	0.01	0.00	0.03	0.01	0.10	0.00	0.00	0.26	0.26
Crit Moves:	****			****			****				****	
Green Time:	31.6	31.6	31.6	10.0	0.0	10.0	7.0	66.4	0.0	0.0	59.4	59.4
Volume/Cap:	0.53	0.37	0.36	0.08	0.00	0.36	0.11	0.17	0.00	0.00	0.53	0.53
Delay/Veh:	38.9	36.6	36.5	51.0	0.0	53.5	54.0	13.3	0.0	0.0	21.0	21.0
User DelAdj:	1.00	1.00	1.00	1.00	1.00	1.00	1.00	1.00	1.00	1.00	1.00	1.00
AdjDel/Veh:	38.9	36.6	36.5	51.0	0.0	53.5	54.0	13.3	0.0	0.0	21.0	21.0
LOS by Move:	D	D	D	D	A	D	D	B	A	A	C	C
HCM2k95thQ:	15	10	10	1	0	4	1	6	0	0	22	22

Note: Queue reported is the number of cars per lane.

BART Phase II Extension Project

Level Of Service Computation Report
 2000 HCM Operations (Future Volume Alternative)
 PM - Existing Plus Project Conditions

Intersection #3066: AUTUMN/SANTA CLARA

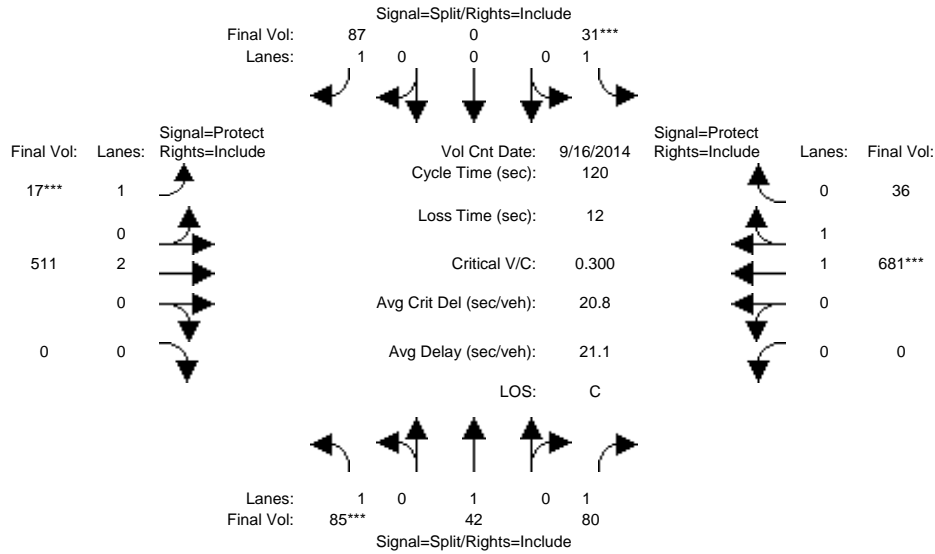

Approach:	North Bound			South Bound			East Bound			West Bound		
	L	T	R	L	T	R	L	T	R	L	T	R
Min. Green:	10	10	10	10	0	10	7	10	0	0	10	10
Y+R:	4.0	4.0	4.0	4.0	4.0	4.0	4.0	4.0	4.0	4.0	4.0	4.0

Volume Module:	>> Count Date: 16 Sep 2014 <<											
Base Vol:	85	42	80	31	0	87	17	511	0	0	681	36
Growth Adj:	1.00	1.00	1.00	1.00	1.00	1.00	1.00	1.00	1.00	1.00	1.00	1.00
Initial Bse:	85	42	80	31	0	87	17	511	0	0	681	36
Added Vol:	0	0	0	0	0	0	0	0	0	0	0	0
PasserByVol:	0	0	0	0	0	0	0	0	0	0	0	0
Initial Fut:	85	42	80	31	0	87	17	511	0	0	681	36
User Adj:	1.00	1.00	1.00	1.00	1.00	1.00	1.00	1.00	1.00	1.00	1.00	1.00
PHF Adj:	1.00	1.00	1.00	1.00	1.00	1.00	1.00	1.00	1.00	1.00	1.00	1.00
PHF Volume:	85	42	80	31	0	87	17	511	0	0	681	36
Reduct Vol:	0	0	0	0	0	0	0	0	0	0	0	0
Reduced Vol:	85	42	80	31	0	87	17	511	0	0	681	36
PCE Adj:	1.00	1.00	1.00	1.00	1.00	1.00	1.00	1.00	1.00	1.00	1.00	1.00
MLF Adj:	1.00	1.00	1.00	1.00	1.00	1.00	1.00	1.00	1.00	1.00	1.00	1.00
FinalVolume:	85	42	80	31	0	87	17	511	0	0	681	36

Saturation Flow Module:												
Sat/Lane:	1900	1900	1900	1900	1900	1900	1900	1900	1900	1900	1900	1900
Adjustment:	0.92	1.00	0.92	0.92	1.00	0.92	0.92	1.00	0.92	0.92	0.98	0.95
Lanes:	1.00	1.00	1.00	1.00	0.00	1.00	1.00	2.00	0.00	0.00	1.90	0.10
Final Sat.:	1750	1900	1750	1750	0	1750	1750	3800	0	0	3514	186

Capacity Analysis Module:												
Vol/Sat:	0.05	0.02	0.05	0.02	0.00	0.05	0.01	0.13	0.00	0.00	0.19	0.19
Crit Moves:	****			****			****				****	
Green Time:	16.3	16.3	16.3	19.9	0.0	19.9	7.0	71.8	0.0	0.0	64.8	64.8
Volume/Cap:	0.36	0.16	0.34	0.11	0.00	0.30	0.17	0.22	0.00	0.00	0.36	0.36
Delay/Veh:	48.1	46.2	47.8	42.7	0.0	44.5	54.5	11.2	0.0	0.0	15.8	15.8
User DelAdj:	1.00	1.00	1.00	1.00	1.00	1.00	1.00	1.00	1.00	1.00	1.00	1.00
AdjDel/Veh:	48.1	46.2	47.8	42.7	0.0	44.5	54.5	11.2	0.0	0.0	15.8	15.8
LOS by Move:	D	D	D	D	A	D	D	B	A	A	B	B
HCM2k95thQ:	6	3	6	2	0	6	1	8	0	0	14	14

Note: Queue reported is the number of cars per lane.

BART Phase II Extension Project

Level Of Service Computation Report
2000 HCM Operations (Future Volume Alternative)
AM - Existing Plus Project Conditions

Intersection #3077: BIRD/SAN CARLOS

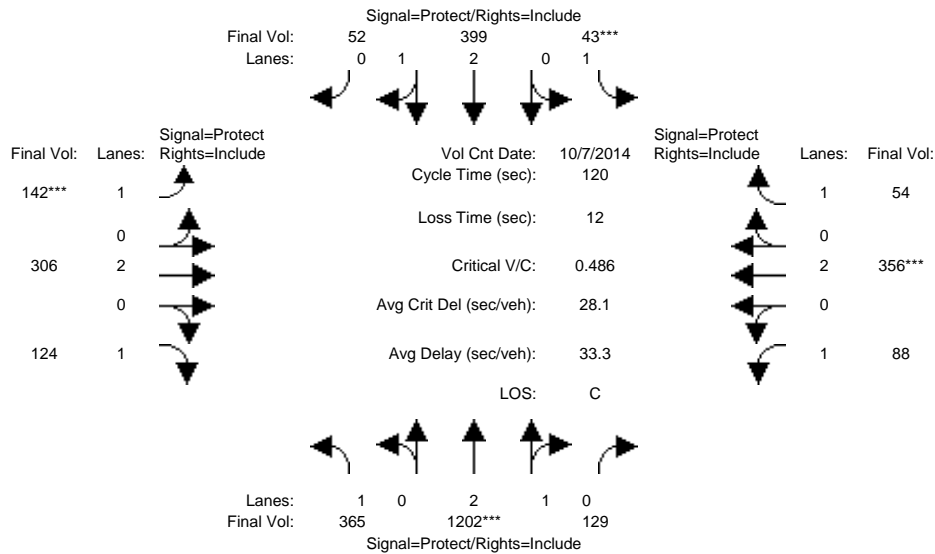

Approach:	North Bound			South Bound			East Bound			West Bound		
Movement:	L	T	R	L	T	R	L	T	R	L	T	R
Min. Green:	7	10	10	7	10	10	7	10	10	7	10	10
Y+R:	4.0	4.0	4.0	4.0	4.0	4.0	4.0	4.0	4.0	4.0	4.0	4.0
Volume Module: >> Count Date: 7 Oct 2014 <<												
Base Vol:	365	1202	129	43	399	52	142	306	124	88	356	54
Growth Adj:	1.00	1.00	1.00	1.00	1.00	1.00	1.00	1.00	1.00	1.00	1.00	1.00
Initial Bse:	365	1202	129	43	399	52	142	306	124	88	356	54
Added Vol:	0	0	0	0	0	0	0	0	0	0	0	0
PasserByVol:	0	0	0	0	0	0	0	0	0	0	0	0
Initial Fut:	365	1202	129	43	399	52	142	306	124	88	356	54
User Adj:	1.00	1.00	1.00	1.00	1.00	1.00	1.00	1.00	1.00	1.00	1.00	1.00
PHF Adj:	1.00	1.00	1.00	1.00	1.00	1.00	1.00	1.00	1.00	1.00	1.00	1.00
PHF Volume:	365	1202	129	43	399	52	142	306	124	88	356	54
Reduct Vol:	0	0	0	0	0	0	0	0	0	0	0	0
Reduced Vol:	365	1202	129	43	399	52	142	306	124	88	356	54
PCE Adj:	1.00	1.00	1.00	1.00	1.00	1.00	1.00	1.00	1.00	1.00	1.00	1.00
MLF Adj:	1.00	1.00	1.00	1.00	1.00	1.00	1.00	1.00	1.00	1.00	1.00	1.00
FinalVolume:	365	1202	129	43	399	52	142	306	124	88	356	54
Saturation Flow Module:												
Sat/Lane:	1900	1900	1900	1900	1900	1900	1900	1900	1900	1900	1900	1900
Adjustment:	0.92	0.99	0.95	0.92	0.99	0.95	0.92	1.00	0.92	0.92	1.00	0.92
Lanes:	1.00	2.70	0.30	1.00	2.64	0.36	1.00	2.00	1.00	1.00	2.00	1.00
Final Sat.:	1750	5057	543	1750	4953	646	1750	3800	1750	1750	3800	1750
Capacity Analysis Module:												
Vol/Sat:	0.21	0.24	0.24	0.02	0.08	0.08	0.08	0.08	0.07	0.05	0.09	0.03
Crit Moves:	****			****			****			****		
Green Time:	46.6	58.2	58.2	7.0	18.6	18.6	19.9	25.2	25.2	17.6	22.9	22.9
Volume/Cap:	0.54	0.49	0.49	0.42	0.52	0.52	0.49	0.38	0.34	0.34	0.49	0.16
Delay/Veh:	29.2	21.0	21.0	57.3	47.1	47.1	46.8	41.1	40.9	46.8	43.8	40.7
User DelAdj:	1.00	1.00	1.00	1.00	1.00	1.00	1.00	1.00	1.00	1.00	1.00	1.00
AdjDel/Veh:	29.2	21.0	21.0	57.3	47.1	47.1	46.8	41.1	40.9	46.8	43.8	40.7
LOS by Move:	C	C	C	E	D	D	D	D	D	D	D	D
HCM2k95thQ:	20	20	20	3	10	10	10	9	8	6	11	4

Note: Queue reported is the number of cars per lane.

BART Phase II Extension Project

Level Of Service Computation Report
 2000 HCM Operations (Future Volume Alternative)
 PM - Existing Plus Project Conditions

Intersection #3077: BIRD/SAN CARLOS

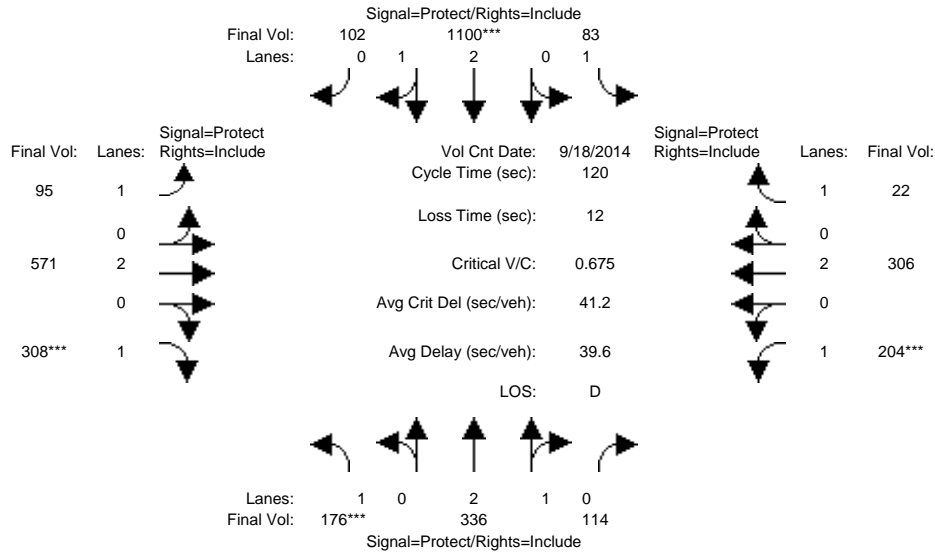

Approach:	North Bound			South Bound			East Bound			West Bound		
Movement:	L	T	R	L	T	R	L	T	R	L	T	R
Min. Green:	7	10	10	7	10	10	7	10	10	7	10	10
Y+R:	4.0	4.0	4.0	4.0	4.0	4.0	4.0	4.0	4.0	4.0	4.0	4.0
Volume Module: >> Count Date: 18 Sep 2014 <<												
Base Vol:	176	336	114	83	1100	102	95	571	308	204	306	22
Growth Adj:	1.00	1.00	1.00	1.00	1.00	1.00	1.00	1.00	1.00	1.00	1.00	1.00
Initial Bse:	176	336	114	83	1100	102	95	571	308	204	306	22
Added Vol:	0	0	0	0	0	0	0	0	0	0	0	0
PasserByVol:	0	0	0	0	0	0	0	0	0	0	0	0
Initial Fut:	176	336	114	83	1100	102	95	571	308	204	306	22
User Adj:	1.00	1.00	1.00	1.00	1.00	1.00	1.00	1.00	1.00	1.00	1.00	1.00
PHF Adj:	1.00	1.00	1.00	1.00	1.00	1.00	1.00	1.00	1.00	1.00	1.00	1.00
PHF Volume:	176	336	114	83	1100	102	95	571	308	204	306	22
Reduct Vol:	0	0	0	0	0	0	0	0	0	0	0	0
Reduced Vol:	176	336	114	83	1100	102	95	571	308	204	306	22
PCE Adj:	1.00	1.00	1.00	1.00	1.00	1.00	1.00	1.00	1.00	1.00	1.00	1.00
MLF Adj:	1.00	1.00	1.00	1.00	1.00	1.00	1.00	1.00	1.00	1.00	1.00	1.00
Final Volume:	176	336	114	83	1100	102	95	571	308	204	306	22
Saturation Flow Module:												
Sat/Lane:	1900	1900	1900	1900	1900	1900	1900	1900	1900	1900	1900	1900
Adjustment:	0.92	0.99	0.95	0.92	0.99	0.95	0.92	1.00	0.92	0.92	1.00	0.92
Lanes:	1.00	2.21	0.79	1.00	2.74	0.26	1.00	2.00	1.00	1.00	2.00	1.00
Final Sat.:	1750	4179	1418	1750	5124	475	1750	3800	1750	1750	3800	1750
Capacity Analysis Module:												
Vol/Sat:	0.10	0.08	0.08	0.05	0.21	0.21	0.05	0.15	0.18	0.12	0.08	0.01
Crit Moves:	****			****			****			****		
Green Time:	17.9	32.9	32.9	23.1	38.1	38.1	21.4	31.3	31.3	20.7	30.6	30.6
Volume/Cap:	0.68	0.29	0.29	0.25	0.68	0.68	0.30	0.58	0.68	0.68	0.32	0.05
Delay/Veh:	55.2	34.4	34.4	41.5	36.6	36.6	43.4	39.4	43.8	52.5	36.4	33.8
User DelAdj:	1.00	1.00	1.00	1.00	1.00	1.00	1.00	1.00	1.00	1.00	1.00	1.00
AdjDel/Veh:	55.2	34.4	34.4	41.5	36.6	36.6	43.4	39.4	43.8	52.5	36.4	33.8
LOS by Move:	E	C	C	D	D	D	D	D	D	D	D	C
HCM2k95thQ:	13	8	8	5	23	23	6	17	20	15	9	1

Note: Queue reported is the number of cars per lane.

BART Phase II Extension Project

Level Of Service Computation Report
 2000 HCM Operations (Future Volume Alternative)
 AM - Existing Plus Project Conditions

Intersection #3112: MONTGOMERY/SANTA CLARA

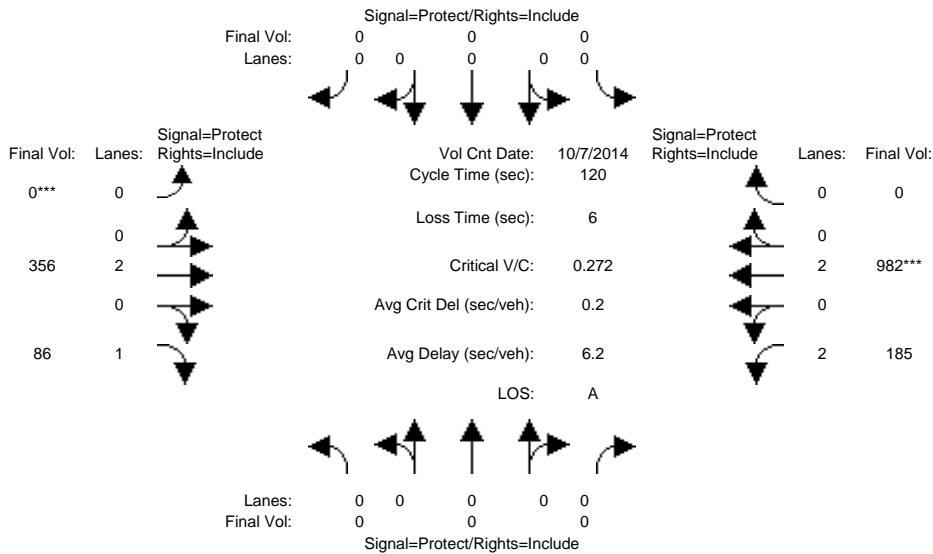

Approach:	North Bound			South Bound			East Bound			West Bound			
	L	T	R	L	T	R	L	T	R	L	T	R	
Min. Green:	0	0	0	0	0	0	0	10	10	7	10	0	
Y+R:	4.0	4.0	4.0	4.0	4.0	4.0	4.0	4.0	4.0	4.0	4.0	4.0	
Volume Module: >> Count Date: 7 Oct 2014 <<													
Base Vol:	0	0	0	0	0	0	0	356	86	185	982	0	
Growth Adj:	1.00	1.00	1.00	1.00	1.00	1.00	1.00	1.00	1.00	1.00	1.00	1.00	
Initial Bse:	0	0	0	0	0	0	0	356	86	185	982	0	
Added Vol:	0	0	0	0	0	0	0	0	0	0	0	0	
PasserByVol:	0	0	0	0	0	0	0	0	0	0	0	0	
Initial Fut:	0	0	0	0	0	0	0	356	86	185	982	0	
User Adj:	1.00	1.00	1.00	1.00	1.00	1.00	1.00	1.00	1.00	1.00	1.00	1.00	
PHF Adj:	1.00	1.00	1.00	1.00	1.00	1.00	1.00	1.00	1.00	1.00	1.00	1.00	
PHF Volume:	0	0	0	0	0	0	0	356	86	185	982	0	
Reduct Vol:	0	0	0	0	0	0	0	0	0	0	0	0	
Reduced Vol:	0	0	0	0	0	0	0	356	86	185	982	0	
PCE Adj:	1.00	1.00	1.00	1.00	1.00	1.00	1.00	1.00	1.00	1.00	1.00	1.00	
MLF Adj:	1.00	1.00	1.00	1.00	1.00	1.00	1.00	1.00	1.00	1.00	1.00	1.00	
FinalVolume:	0	0	0	0	0	0	0	356	86	185	982	0	
Saturation Flow Module:													
Sat/Lane:	1900	1900	1900	1900	1900	1900	1900	1900	1900	1900	1900	1900	
Adjustment:	0.92	1.00	0.92	0.92	1.00	0.92	0.92	1.00	0.92	0.83	1.00	0.92	
Lanes:	0.00	0.00	0.00	0.00	0.00	0.00	0.00	2.00	1.00	2.00	2.00	0.00	
Final Sat.:	0	0	0	0	0	0	0	3800	1750	3150	3800	0	
Capacity Analysis Module:													
Vol/Sat:	0.00	0.00	0.00	0.00	0.00	0.00	0.00	0.09	0.05	0.06	0.26	0.00	
Crit Moves:							****	****					
Green Time:	0.0	0.0	0.0	0.0	0.0	0.0	0.0	70.1	70.1	43.9	114	0.0	
Volume/Cap:	0.00	0.00	0.00	0.00	0.00	0.00	0.00	0.16	0.08	0.16	0.27	0.00	
Delay/Veh:	0.0	0.0	0.0	0.0	0.0	0.0	0.0	11.5	11.0	25.7	0.2	0.0	
User DelAdj:	1.00	1.00	1.00	1.00	1.00	1.00	1.00	1.00	1.00	1.00	1.00	1.00	
AdjDel/Veh:	0.0	0.0	0.0	0.0	0.0	0.0	0.0	11.5	11.0	25.7	0.2	0.0	
LOS by Move:	A	A	A	A	A	A	A	B	B	C	A	A	
HCM2k95thQ:	0	0	0	0	0	0	0	6	3	5	3	0	

Note: Queue reported is the number of cars per lane.

BART Phase II Extension Project

Level Of Service Computation Report
 2000 HCM Operations (Future Volume Alternative)
 PM - Existing Plus Project Conditions

Intersection #3112: MONTGOMERY/SANTA CLARA

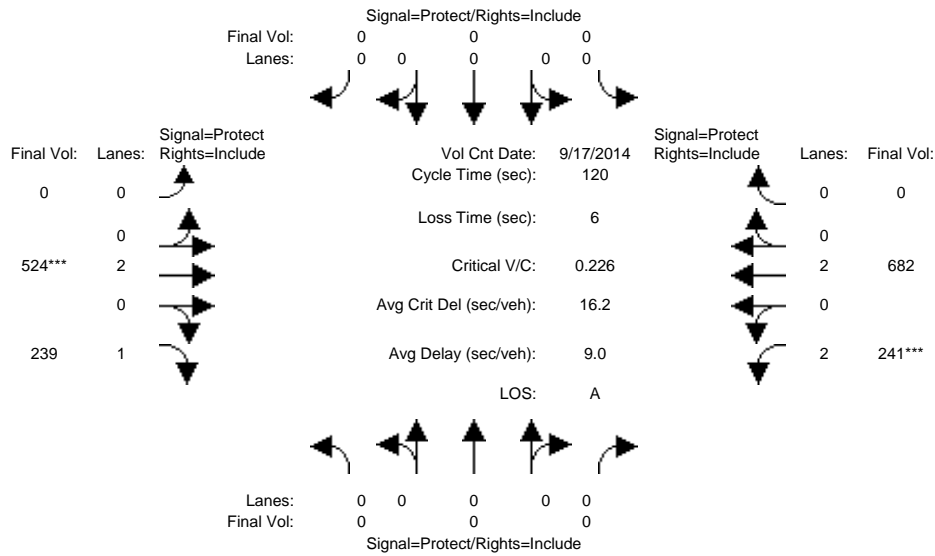

Approach:	North Bound			South Bound			East Bound			West Bound		
	L	T	R	L	T	R	L	T	R	L	T	R
Min. Green:	0	0	0	0	0	0	0	10	10	7	10	0
Y+R:	4.0	4.0	4.0	4.0	4.0	4.0	4.0	4.0	4.0	4.0	4.0	4.0
Volume Module: >> Count Date: 17 Sep 2014 <<												
Base Vol:	0	0	0	0	0	0	0	524	239	241	682	0
Growth Adj:	1.00	1.00	1.00	1.00	1.00	1.00	1.00	1.00	1.00	1.00	1.00	1.00
Initial Bse:	0	0	0	0	0	0	0	524	239	241	682	0
Added Vol:	0	0	0	0	0	0	0	0	0	0	0	0
PasserByVol:	0	0	0	0	0	0	0	0	0	0	0	0
Initial Fut:	0	0	0	0	0	0	0	524	239	241	682	0
User Adj:	1.00	1.00	1.00	1.00	1.00	1.00	1.00	1.00	1.00	1.00	1.00	1.00
PHF Adj:	1.00	1.00	1.00	1.00	1.00	1.00	1.00	1.00	1.00	1.00	1.00	1.00
PHF Volume:	0	0	0	0	0	0	0	524	239	241	682	0
Reduct Vol:	0	0	0	0	0	0	0	0	0	0	0	0
Reduced Vol:	0	0	0	0	0	0	0	524	239	241	682	0
PCE Adj:	1.00	1.00	1.00	1.00	1.00	1.00	1.00	1.00	1.00	1.00	1.00	1.00
MLF Adj:	1.00	1.00	1.00	1.00	1.00	1.00	1.00	1.00	1.00	1.00	1.00	1.00
FinalVolume:	0	0	0	0	0	0	0	524	239	241	682	0
Saturation Flow Module:												
Sat/Lane:	1900	1900	1900	1900	1900	1900	1900	1900	1900	1900	1900	1900
Adjustment:	0.92	1.00	0.92	0.92	1.00	0.92	0.92	1.00	0.92	0.83	1.00	0.92
Lanes:	0.00	0.00	0.00	0.00	0.00	0.00	0.00	2.00	1.00	2.00	2.00	0.00
Final Sat.:	0	0	0	0	0	0	0	3800	1750	3150	3800	0
Capacity Analysis Module:												
Vol/Sat:	0.00	0.00	0.00	0.00	0.00	0.00	0.00	0.14	0.14	0.08	0.18	0.00
Crit Moves:	****											
Green Time:	0.0	0.0	0.0	0.0	0.0	0.0	0.0	73.3	73.3	40.7	114	0.0
Volume/Cap:	0.00	0.00	0.00	0.00	0.00	0.00	0.00	0.23	0.22	0.23	0.19	0.00
Delay/Veh:	0.0	0.0	0.0	0.0	0.0	0.0	0.0	10.6	10.6	28.5	0.2	0.0
User DelAdj:	1.00	1.00	1.00	1.00	1.00	1.00	1.00	1.00	1.00	1.00	1.00	1.00
AdjDel/Veh:	0.0	0.0	0.0	0.0	0.0	0.0	0.0	10.6	10.6	28.5	0.2	0.0
LOS by Move:	A	A	A	A	A	A	A	B	B	C	A	A
HCM2k95thQ:	0	0	0	0	0	0	0	8	8	7	2	0

Note: Queue reported is the number of cars per lane.

BART Phase II Extension Project

Level Of Service Computation Report
 2000 HCM Operations (Future Volume Alternative)
 AM - Existing Plus Project Conditions

Intersection #3227: ALAMEDA/JULIAN

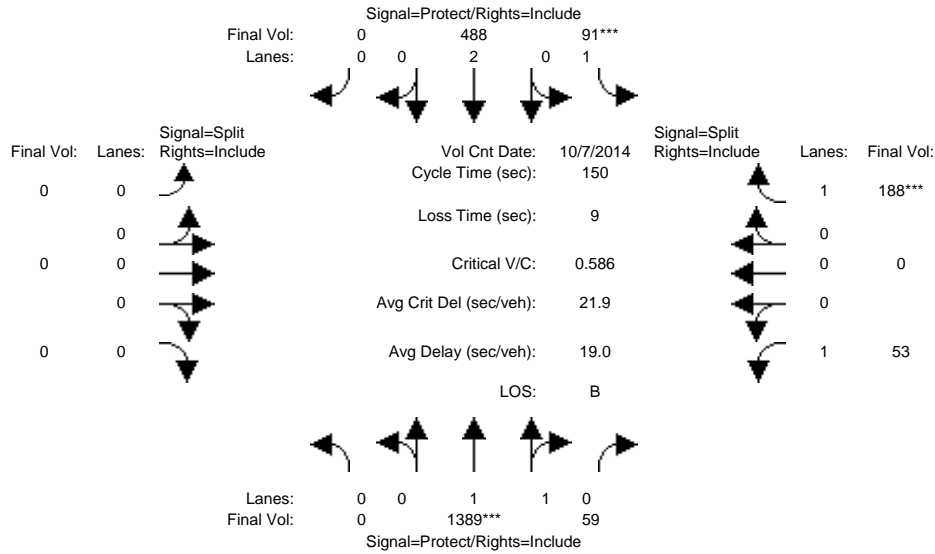

Approach:	North Bound			South Bound			East Bound			West Bound		
	L	T	R	L	T	R	L	T	R	L	T	R
Min. Green:	0	10	10	7	10	0	0	0	0	10	0	10
Y+R:	4.0	4.0	4.0	4.0	4.0	4.0	4.0	4.0	4.0	4.0	4.0	4.0
Volume Module: >> Count Date: 7 Oct 2014 <<												
Base Vol:	0	1389	59	91	488	0	0	0	0	53	0	188
Growth Adj:	1.00	1.00	1.00	1.00	1.00	1.00	1.00	1.00	1.00	1.00	1.00	1.00
Initial Bse:	0	1389	59	91	488	0	0	0	0	53	0	188
Added Vol:	0	0	0	0	0	0	0	0	0	0	0	0
PasserByVol:	0	0	0	0	0	0	0	0	0	0	0	0
Initial Fut:	0	1389	59	91	488	0	0	0	0	53	0	188
User Adj:	1.00	1.00	1.00	1.00	1.00	1.00	1.00	1.00	1.00	1.00	1.00	1.00
PHF Adj:	1.00	1.00	1.00	1.00	1.00	1.00	1.00	1.00	1.00	1.00	1.00	1.00
PHF Volume:	0	1389	59	91	488	0	0	0	0	53	0	188
Reduct Vol:	0	0	0	0	0	0	0	0	0	0	0	0
Reduced Vol:	0	1389	59	91	488	0	0	0	0	53	0	188
PCE Adj:	1.00	1.00	1.00	1.00	1.00	1.00	1.00	1.00	1.00	1.00	1.00	1.00
MLF Adj:	1.00	1.00	1.00	1.00	1.00	1.00	1.00	1.00	1.00	1.00	1.00	1.00
FinalVolume:	0	1389	59	91	488	0	0	0	0	53	0	188
Saturation Flow Module:												
Sat/Lane:	1900	1900	1900	1900	1900	1900	1900	1900	1900	1900	1900	1900
Adjustment:	0.92	0.97	0.95	0.92	1.00	0.92	0.92	1.00	0.92	0.92	1.00	0.92
Lanes:	0.00	1.92	0.08	1.00	2.00	0.00	0.00	0.00	0.00	1.00	0.00	1.00
Final Sat.:	0	3549	151	1750	3800	0	0	0	0	1750	0	1750
Capacity Analysis Module:												
Vol/Sat:	0.00	0.39	0.39	0.05	0.13	0.00	0.00	0.00	0.00	0.03	0.00	0.11
Crit Moves:	****			****						****		
Green Time:	0.0	100	100.2	13.3	113	0.0	0.0	0.0	0.0	27.5	0.0	27.5
Volume/Cap:	0.00	0.59	0.59	0.59	0.17	0.00	0.00	0.00	0.00	0.17	0.00	0.59
Delay/Veh:	0.0	14.0	14.0	71.4	5.1	0.0	0.0	0.0	0.0	51.8	0.0	58.8
User DelAdj:	1.00	1.00	1.00	1.00	1.00	1.00	1.00	1.00	1.00	1.00	1.00	1.00
AdjDel/Veh:	0.0	14.0	14.0	71.4	5.1	0.0	0.0	0.0	0.0	51.8	0.0	58.8
LOS by Move:	A	B	B	E	A	A	A	A	A	D	A	E
HCM2k95thQ:	0	31	31	9	6	0	0	0	0	4	0	16

Note: Queue reported is the number of cars per lane.

BART Phase II Extension Project

Level Of Service Computation Report
 2000 HCM Operations (Future Volume Alternative)
 PM - Existing Plus Project Conditions

Intersection #3227: ALAMEDA/JULIAN

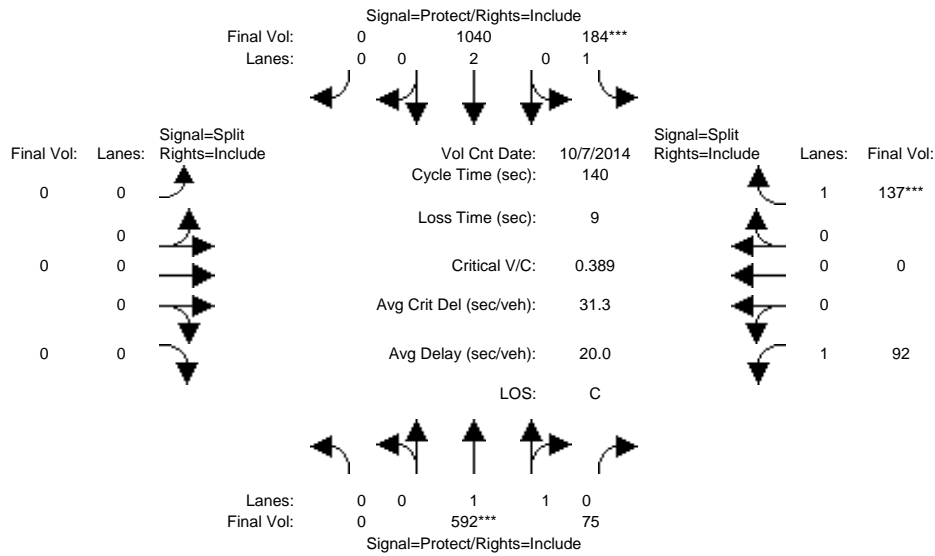

Approach:	North Bound			South Bound			East Bound			West Bound		
	L	T	R	L	T	R	L	T	R	L	T	R
Min. Green:	0	10	10	7	10	0	0	0	0	10	0	10
Y+R:	4.0	4.0	4.0	4.0	4.0	4.0	4.0	4.0	4.0	4.0	4.0	4.0

Volume Module:	>> Count Date: 7 Oct 2014 <<											
Base Vol:	0	592	75	184	1040	0	0	0	0	92	0	137
Growth Adj:	1.00	1.00	1.00	1.00	1.00	1.00	1.00	1.00	1.00	1.00	1.00	1.00
Initial Bse:	0	592	75	184	1040	0	0	0	0	92	0	137
Added Vol:	0	0	0	0	0	0	0	0	0	0	0	0
PasserByVol:	0	0	0	0	0	0	0	0	0	0	0	0
Initial Fut:	0	592	75	184	1040	0	0	0	0	92	0	137
User Adj:	1.00	1.00	1.00	1.00	1.00	1.00	1.00	1.00	1.00	1.00	1.00	1.00
PHF Adj:	1.00	1.00	1.00	1.00	1.00	1.00	1.00	1.00	1.00	1.00	1.00	1.00
PHF Volume:	0	592	75	184	1040	0	0	0	0	92	0	137
Reduct Vol:	0	0	0	0	0	0	0	0	0	0	0	0
Reduced Vol:	0	592	75	184	1040	0	0	0	0	92	0	137
PCE Adj:	1.00	1.00	1.00	1.00	1.00	1.00	1.00	1.00	1.00	1.00	1.00	1.00
MLF Adj:	1.00	1.00	1.00	1.00	1.00	1.00	1.00	1.00	1.00	1.00	1.00	1.00
FinalVolume:	0	592	75	184	1040	0	0	0	0	92	0	137

Saturation Flow Module:												
Sat/Lane:	1900	1900	1900	1900	1900	1900	1900	1900	1900	1900	1900	1900
Adjustment:	0.92	0.98	0.95	0.92	1.00	0.92	0.92	1.00	0.92	0.92	1.00	0.92
Lanes:	0.00	1.77	0.23	1.00	2.00	0.00	0.00	0.00	0.00	1.00	0.00	1.00
Final Sat.:	0	3284	416	1750	3800	0	0	0	0	1750	0	1750

Capacity Analysis Module:												
Vol/Sat:	0.00	0.18	0.18	0.11	0.27	0.00	0.00	0.00	0.00	0.05	0.00	0.08
Crit Moves:	****			****						****		
Green Time:	0.0	64.9	64.9	37.9	103	0.0	0.0	0.0	0.0	28.2	0.0	28.2
Volume/Cap:	0.00	0.39	0.39	0.39	0.37	0.00	0.00	0.00	0.00	0.26	0.00	0.39
Delay/Veh:	0.0	24.7	24.7	42.2	6.9	0.0	0.0	0.0	0.0	47.5	0.0	49.1
User DelAdj:	1.00	1.00	1.00	1.00	1.00	1.00	1.00	1.00	1.00	1.00	1.00	1.00
AdjDel/Veh:	0.0	24.7	24.7	42.2	6.9	0.0	0.0	0.0	0.0	47.5	0.0	49.1
LOS by Move:	A	C	C	D	A	A	A	A	A	D	A	D
HCM2k95thQ:	0	17	17	13	15	0	0	0	0	7	0	10

Note: Queue reported is the number of cars per lane.

BART Phase II Extension Project

Level Of Service Computation Report
2000 HCM Operations (Future Volume Alternative)
AM - Existing Plus Project Conditions

Intersection #3230: ALAMEDA/STOCKTON

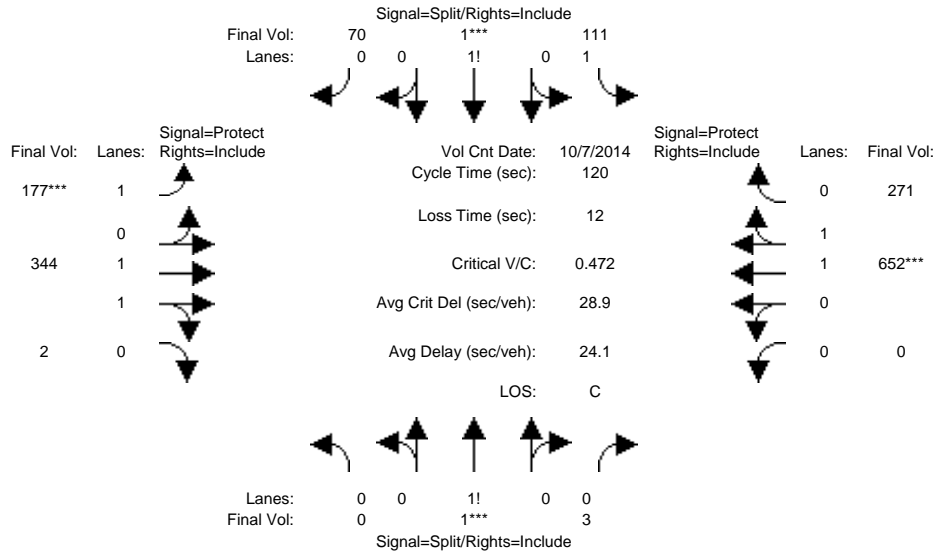

Approach:	North Bound			South Bound			East Bound			West Bound		
	L	T	R	L	T	R	L	T	R	L	T	R
Min. Green:	10	10	10	10	10	10	7	10	10	0	10	10
Y+R:	4.0	4.0	4.0	4.0	4.0	4.0	4.0	4.0	4.0	4.0	4.0	4.0
Volume Module: >> Count Date: 7 Oct 2014 <<												
Base Vol:	0	1	3	111	1	70	177	344	2	0	652	271
Growth Adj:	1.00	1.00	1.00	1.00	1.00	1.00	1.00	1.00	1.00	1.00	1.00	1.00
Initial Bse:	0	1	3	111	1	70	177	344	2	0	652	271
Added Vol:	0	0	0	0	0	0	0	0	0	0	0	0
PasserByVol:	0	0	0	0	0	0	0	0	0	0	0	0
Initial Fut:	0	1	3	111	1	70	177	344	2	0	652	271
User Adj:	1.00	1.00	1.00	1.00	1.00	1.00	1.00	1.00	1.00	1.00	1.00	1.00
PHF Adj:	1.00	1.00	1.00	1.00	1.00	1.00	1.00	1.00	1.00	1.00	1.00	1.00
PHF Volume:	0	1	3	111	1	70	177	344	2	0	652	271
Reduct Vol:	0	0	0	0	0	0	0	0	0	0	0	0
Reduced Vol:	0	1	3	111	1	70	177	344	2	0	652	271
PCE Adj:	1.00	1.00	1.00	1.00	1.00	1.00	1.00	1.00	1.00	1.00	1.00	1.00
MLF Adj:	1.00	1.00	1.00	1.00	1.00	1.00	1.00	1.00	1.00	1.00	1.00	1.00
FinalVolume:	0	1	3	111	1	70	177	344	2	0	652	271
Saturation Flow Module:												
Sat/Lane:	1900	1900	1900	1900	1900	1900	1900	1900	1900	1900	1900	1900
Adjustment:	0.92	0.95	0.95	0.92	0.92	0.92	0.92	0.97	0.95	0.92	0.98	0.95
Lanes:	0.00	0.25	0.75	1.44	0.01	0.55	1.00	1.99	0.01	0.00	1.40	0.60
Final Sat.:	0	450	1350	2518	14	968	1750	3679	21	0	2613	1086
Capacity Analysis Module:												
Vol/Sat:	0.00	0.00	0.00	0.04	0.07	0.07	0.10	0.09	0.09	0.00	0.25	0.25
Crit Moves:	****			****			****			****		
Green Time:	0.0	10.0	10.0	16.7	16.7	16.7	23.4	81.3	81.3	0.0	57.8	57.8
Volume/Cap:	0.00	0.03	0.03	0.32	0.52	0.52	0.52	0.14	0.14	0.00	0.52	0.52
Delay/Veh:	0.0	50.6	50.6	46.8	49.2	49.2	44.6	6.9	6.9	0.0	21.7	21.7
User DelAdj:	1.00	1.00	1.00	1.00	1.00	1.00	1.00	1.00	1.00	1.00	1.00	1.00
AdjDel/Veh:	0.0	50.6	50.6	46.8	49.2	49.2	44.6	6.9	6.9	0.0	21.7	21.7
LOS by Move:	A	D	D	D	D	D	D	A	A	A	C	C
HCM2k95thQ:	0	0	0	5	9	9	12	5	5	0	21	21

Note: Queue reported is the number of cars per lane.

BART Phase II Extension Project

Level Of Service Computation Report
 2000 HCM Operations (Future Volume Alternative)
 PM - Existing Plus Project Conditions

Intersection #3230: ALAMEDA/STOCKTON

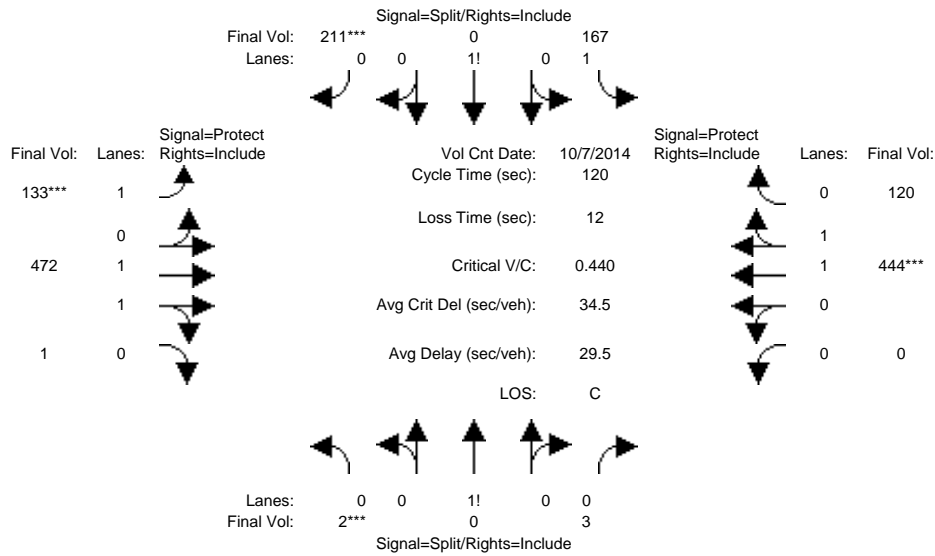

Approach:	North Bound			South Bound			East Bound			West Bound		
	L	T	R	L	T	R	L	T	R	L	T	R
Min. Green:	10	10	10	10	10	10	7	10	10	0	10	10
Y+R:	4.0	4.0	4.0	4.0	4.0	4.0	4.0	4.0	4.0	4.0	4.0	4.0

Volume Module:	>> Count Date: 7 Oct 2014 <<											
Base Vol:	2	0	3	167	0	211	133	472	1	0	444	120
Growth Adj:	1.00	1.00	1.00	1.00	1.00	1.00	1.00	1.00	1.00	1.00	1.00	1.00
Initial Bse:	2	0	3	167	0	211	133	472	1	0	444	120
Added Vol:	0	0	0	0	0	0	0	0	0	0	0	0
PasserByVol:	0	0	0	0	0	0	0	0	0	0	0	0
Initial Fut:	2	0	3	167	0	211	133	472	1	0	444	120
User Adj:	1.00	1.00	1.00	1.00	1.00	1.00	1.00	1.00	1.00	1.00	1.00	1.00
PHF Adj:	1.00	1.00	1.00	1.00	1.00	1.00	1.00	1.00	1.00	1.00	1.00	1.00
PHF Volume:	2	0	3	167	0	211	133	472	1	0	444	120
Reduct Vol:	0	0	0	0	0	0	0	0	0	0	0	0
Reduced Vol:	2	0	3	167	0	211	133	472	1	0	444	120
PCE Adj:	1.00	1.00	1.00	1.00	1.00	1.00	1.00	1.00	1.00	1.00	1.00	1.00
MLF Adj:	1.00	1.00	1.00	1.00	1.00	1.00	1.00	1.00	1.00	1.00	1.00	1.00
Final Volume:	2	0	3	167	0	211	133	472	1	0	444	120

Saturation Flow Module:												
Sat/Lane:	1900	1900	1900	1900	1900	1900	1900	1900	1900	1900	1900	1900
Adjustment:	0.92	0.92	0.92	0.92	1.00	0.95	0.92	0.97	0.95	0.92	0.98	0.95
Lanes:	0.40	0.00	0.60	1.29	0.00	0.71	1.00	1.99	0.01	0.00	1.56	0.44
Final Sat.:	700	0	1050	2256	0	1279	1750	3692	8	0	2912	787

Capacity Analysis Module:												
Vol/Sat:	0.00	0.00	0.00	0.07	0.00	0.16	0.08	0.13	0.13	0.00	0.15	0.15
Crit Moves:	****					****	****			****		
Green Time:	10.0	0.0	10.0	41.1	0.0	41.1	18.9	56.9	56.9	0.0	38.0	38.0
Volume/Cap:	0.03	0.00	0.03	0.22	0.00	0.48	0.48	0.27	0.27	0.00	0.48	0.48
Delay/Veh:	50.7	0.0	50.7	28.1	0.0	31.5	47.4	19.1	19.1	0.0	33.4	33.4
User DelAdj:	1.00	1.00	1.00	1.00	1.00	1.00	1.00	1.00	1.00	1.00	1.00	1.00
AdjDel/Veh:	50.7	0.0	50.7	28.1	0.0	31.5	47.4	19.1	19.1	0.0	33.4	33.4
LOS by Move:	D	A	D	C	A	C	D	B	B	A	C	C
HCM2k95thQ:	0	0	0	7	0	16	9	10	10	0	16	16

Note: Queue reported is the number of cars per lane.

BART Phase II Extension Project

Level Of Service Computation Report
 2000 HCM Operations (Future Volume Alternative)
 AM - Existing Plus Project Conditions

Intersection #3263: AUTUMN/JULIAN

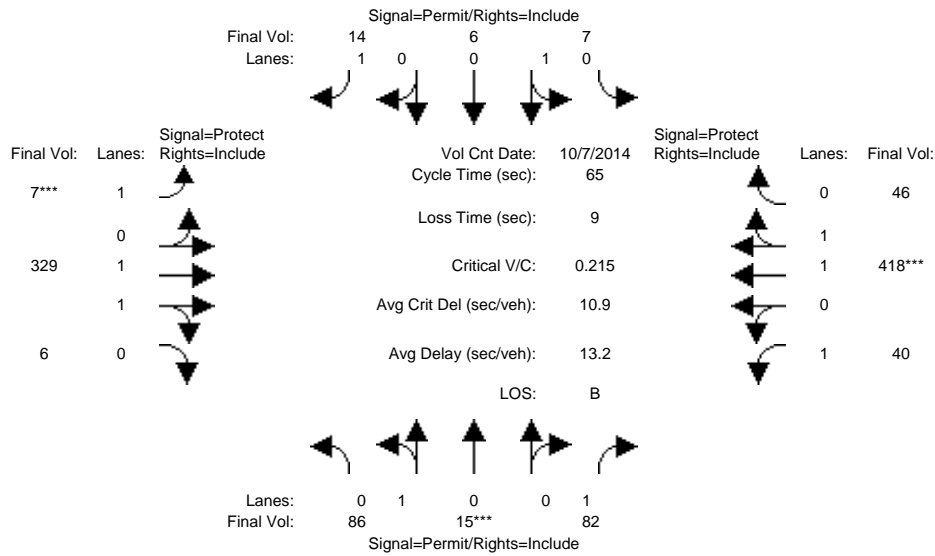

Approach:	North Bound			South Bound			East Bound			West Bound		
	L	T	R	L	T	R	L	T	R	L	T	R
Min. Green:	10	10	10	10	10	10	7	10	10	7	10	10
Y+R:	4.0	4.0	4.0	4.0	4.0	4.0	4.0	4.0	4.0	4.0	4.0	4.0
Volume Module: >> Count Date: 7 Oct 2014 <<												
Base Vol:	86	15	82	7	6	14	7	329	6	40	418	46
Growth Adj:	1.00	1.00	1.00	1.00	1.00	1.00	1.00	1.00	1.00	1.00	1.00	1.00
Initial Bse:	86	15	82	7	6	14	7	329	6	40	418	46
Added Vol:	0	0	0	0	0	0	0	0	0	0	0	0
PasserByVol:	0	0	0	0	0	0	0	0	0	0	0	0
Initial Fut:	86	15	82	7	6	14	7	329	6	40	418	46
User Adj:	1.00	1.00	1.00	1.00	1.00	1.00	1.00	1.00	1.00	1.00	1.00	1.00
PHF Adj:	1.00	1.00	1.00	1.00	1.00	1.00	1.00	1.00	1.00	1.00	1.00	1.00
PHF Volume:	86	15	82	7	6	14	7	329	6	40	418	46
Reduct Vol:	0	0	0	0	0	0	0	0	0	0	0	0
Reduced Vol:	86	15	82	7	6	14	7	329	6	40	418	46
PCE Adj:	1.00	1.00	1.00	1.00	1.00	1.00	1.00	1.00	1.00	1.00	1.00	1.00
MLF Adj:	1.00	1.00	1.00	1.00	1.00	1.00	1.00	1.00	1.00	1.00	1.00	1.00
FinalVolume:	86	15	82	7	6	14	7	329	6	40	418	46
Saturation Flow Module:												
Sat/Lane:	1900	1900	1900	1900	1900	1900	1900	1900	1900	1900	1900	1900
Adjustment:	0.95	0.95	0.92	0.95	0.95	0.92	0.92	0.97	0.95	0.92	0.98	0.95
Lanes:	0.85	0.15	1.00	0.54	0.46	1.00	1.00	1.96	0.04	1.00	1.80	0.20
Final Sat.:	1533	267	1750	969	831	1750	1750	3634	66	1750	3333	367
Capacity Analysis Module:												
Vol/Sat:	0.06	0.06	0.05	0.01	0.01	0.01	0.00	0.09	0.09	0.02	0.13	0.13
Crit Moves:	****						****			****		
Green Time:	15.1	15.1	15.1	15.1	15.1	15.1	7.0	24.0	24.0	16.8	33.9	33.9
Volume/Cap:	0.24	0.24	0.20	0.03	0.03	0.03	0.04	0.24	0.24	0.09	0.24	0.24
Delay/Veh:	20.6	20.6	20.3	19.3	19.3	19.3	26.1	14.3	14.3	18.4	8.6	8.6
User DelAdj:	1.00	1.00	1.00	1.00	1.00	1.00	1.00	1.00	1.00	1.00	1.00	1.00
AdjDel/Veh:	20.6	20.6	20.3	19.3	19.3	19.3	26.1	14.3	14.3	18.4	8.6	8.6
LOS by Move:	C	C	C	B	B	B	C	B	B	B	A	A
HCM2k95thQ:	3	3	3	0	0	1	0	5	5	1	5	5

Note: Queue reported is the number of cars per lane.

BART Phase II Extension Project

Level Of Service Computation Report
2000 HCM Operations (Future Volume Alternative)
PM - Existing Plus Project Conditions

Intersection #3263: AUTUMN/JULIAN

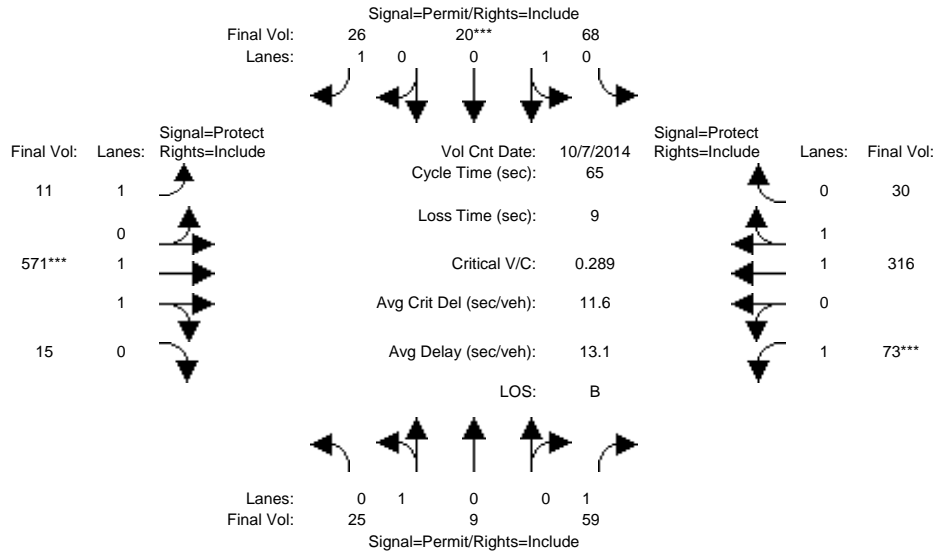

Approach:	North Bound			South Bound			East Bound			West Bound		
	L	T	R	L	T	R	L	T	R	L	T	R
Min. Green:	10	10	10	10	10	10	7	10	10	7	10	10
Y+R:	4.0	4.0	4.0	4.0	4.0	4.0	4.0	4.0	4.0	4.0	4.0	4.0
Volume Module: >> Count Date: 7 Oct 2014 <<												
Base Vol:	25	9	59	68	20	26	11	571	15	73	316	30
Growth Adj:	1.00	1.00	1.00	1.00	1.00	1.00	1.00	1.00	1.00	1.00	1.00	1.00
Initial Bse:	25	9	59	68	20	26	11	571	15	73	316	30
Added Vol:	0	0	0	0	0	0	0	0	0	0	0	0
PasserByVol:	0	0	0	0	0	0	0	0	0	0	0	0
Initial Fut:	25	9	59	68	20	26	11	571	15	73	316	30
User Adj:	1.00	1.00	1.00	1.00	1.00	1.00	1.00	1.00	1.00	1.00	1.00	1.00
PHF Adj:	1.00	1.00	1.00	1.00	1.00	1.00	1.00	1.00	1.00	1.00	1.00	1.00
PHF Volume:	25	9	59	68	20	26	11	571	15	73	316	30
Reduct Vol:	0	0	0	0	0	0	0	0	0	0	0	0
Reduced Vol:	25	9	59	68	20	26	11	571	15	73	316	30
PCE Adj:	1.00	1.00	1.00	1.00	1.00	1.00	1.00	1.00	1.00	1.00	1.00	1.00
MLF Adj:	1.00	1.00	1.00	1.00	1.00	1.00	1.00	1.00	1.00	1.00	1.00	1.00
FinalVolume:	25	9	59	68	20	26	11	571	15	73	316	30
Saturation Flow Module:												
Sat/Lane:	1900	1900	1900	1900	1900	1900	1900	1900	1900	1900	1900	1900
Adjustment:	0.95	0.95	0.92	0.95	0.95	0.92	0.92	0.97	0.95	0.92	0.98	0.95
Lanes:	0.74	0.26	1.00	0.77	0.23	1.00	1.00	1.95	0.05	1.00	1.82	0.18
Final Sat.:	1324	476	1750	1391	409	1750	1750	3605	95	1750	3379	321
Capacity Analysis Module:												
Vol/Sat:	0.02	0.02	0.03	0.05	0.05	0.01	0.01	0.16	0.16	0.04	0.09	0.09
Crit Moves:				****			****			****		
Green Time:	11.0	11.0	11.0	11.0	11.0	11.0	18.5	35.6	35.6	9.4	26.5	26.5
Volume/Cap:	0.11	0.11	0.20	0.29	0.29	0.09	0.02	0.29	0.29	0.29	0.23	0.23
Delay/Veh:	23.0	23.0	23.5	24.1	24.1	22.9	16.7	8.0	8.0	25.5	12.7	12.7
User DelAdj:	1.00	1.00	1.00	1.00	1.00	1.00	1.00	1.00	1.00	1.00	1.00	1.00
AdjDel/Veh:	23.0	23.0	23.5	24.1	24.1	22.9	16.7	8.0	8.0	25.5	12.7	12.7
LOS by Move:	C	C	C	C	C	C	B	A	A	C	B	B
HCM2k95thQ:	1	1	2	4	4	1	0	6	6	3	5	5

Note: Queue reported is the number of cars per lane.

BART Phase II Extension Project

Level Of Service Computation Report
2000 HCM Operations (Future Volume Alternative)
AM - Existing Plus Project Conditions

Intersection #3264: AUTUMN/SAN FERNANDO

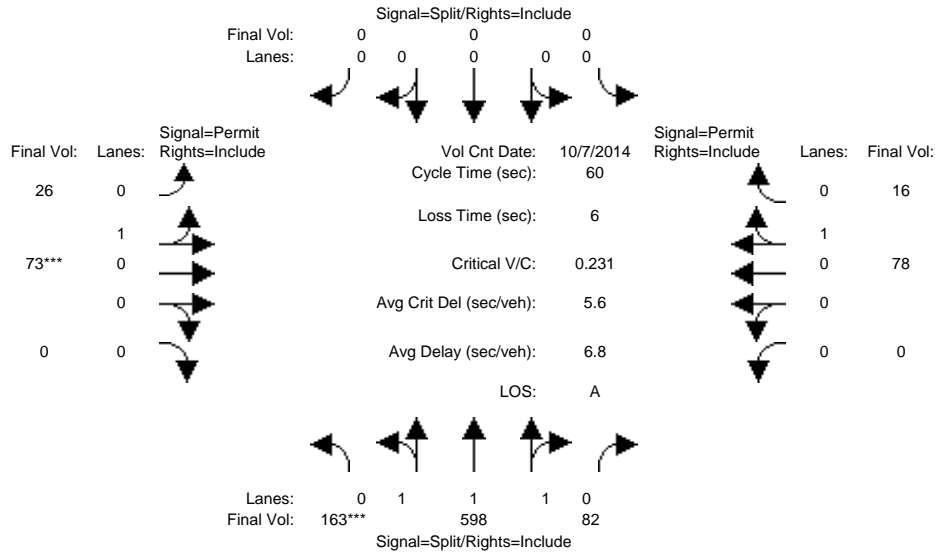

Approach:	North Bound			South Bound			East Bound			West Bound		
	L	T	R	L	T	R	L	T	R	L	T	R
Min. Green:	10	10	10	0	0	0	10	10	0	0	10	10
Y+R:	4.0	4.0	4.0	4.0	4.0	4.0	4.0	4.0	4.0	4.0	4.0	4.0

Volume Module:	>> Count Date: 7 Oct 2014 <<											
Base Vol:	163	598	82	0	0	0	26	73	0	0	78	16
Growth Adj:	1.00	1.00	1.00	1.00	1.00	1.00	1.00	1.00	1.00	1.00	1.00	1.00
Initial Bse:	163	598	82	0	0	0	26	73	0	0	78	16
Added Vol:	0	0	0	0	0	0	0	0	0	0	0	0
PasserByVol:	0	0	0	0	0	0	0	0	0	0	0	0
Initial Fut:	163	598	82	0	0	0	26	73	0	0	78	16
User Adj:	1.00	1.00	1.00	1.00	1.00	1.00	1.00	1.00	1.00	1.00	1.00	1.00
PHF Adj:	1.00	1.00	1.00	1.00	1.00	1.00	1.00	1.00	1.00	1.00	1.00	1.00
PHF Volume:	163	598	82	0	0	0	26	73	0	0	78	16
Reduct Vol:	0	0	0	0	0	0	0	0	0	0	0	0
Reduced Vol:	163	598	82	0	0	0	26	73	0	0	78	16
PCE Adj:	1.00	1.00	1.00	1.00	1.00	1.00	1.00	1.00	1.00	1.00	1.00	1.00
MLF Adj:	1.00	1.00	1.00	1.00	1.00	1.00	1.00	1.00	1.00	1.00	1.00	1.00
FinalVolume:	163	598	82	0	0	0	26	73	0	0	78	16

Saturation Flow Module:												
Sat/Lane:	1900	1900	1900	1900	1900	1900	1900	1900	1900	1900	1900	1900
Adjustment:	0.95	0.97	0.95	0.92	1.00	0.92	0.95	0.95	0.92	0.92	0.95	0.95
Lanes:	0.59	2.11	0.30	0.00	0.00	0.00	0.26	0.74	0.00	0.00	0.83	0.17
Final Sat.:	1063	3901	535	0	0	0	473	1327	0	0	1494	306

Capacity Analysis Module:												
Vol/Sat:	0.15	0.15	0.15	0.00	0.00	0.00	0.06	0.06	0.00	0.00	0.05	0.05
Crit Moves:	****						****					
Green Time:	39.7	39.7	39.7	0.0	0.0	0.0	14.3	14.3	0.0	0.0	14.3	14.3
Volume/Cap:	0.23	0.23	0.23	0.00	0.00	0.00	0.23	0.23	0.00	0.00	0.22	0.22
Delay/Veh:	4.1	4.1	4.1	0.0	0.0	0.0	18.7	18.7	0.0	0.0	18.7	18.7
User DelAdj:	1.00	1.00	1.00	1.00	1.00	1.00	1.00	1.00	1.00	1.00	1.00	1.00
AdjDel/Veh:	4.1	4.1	4.1	0.0	0.0	0.0	18.7	18.7	0.0	0.0	18.7	18.7
LOS by Move:	A	A	A	A	A	A	B	B	A	A	B	B
HCM2k95thQ:	4	4	4	0	0	0	3	3	0	0	3	3

Note: Queue reported is the number of cars per lane.

BART Phase II Extension Project

Level Of Service Computation Report
 2000 HCM Operations (Future Volume Alternative)
 PM - Existing Plus Project Conditions

Intersection #3264: AUTUMN/SAN FERNANDO

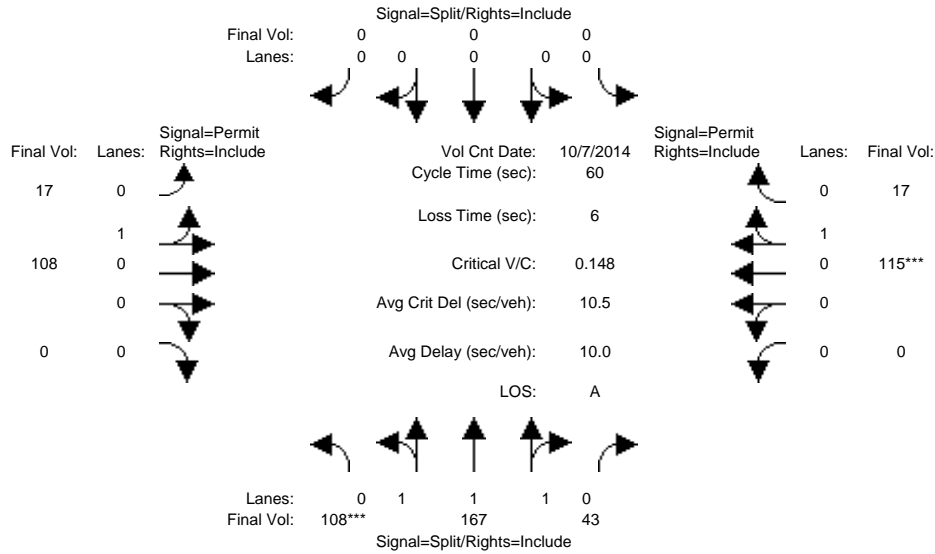

Approach:	North Bound			South Bound			East Bound			West Bound		
	L	T	R	L	T	R	L	T	R	L	T	R
Min. Green:	10	10	10	0	0	0	10	10	0	0	10	10
Y+R:	4.0	4.0	4.0	4.0	4.0	4.0	4.0	4.0	4.0	4.0	4.0	4.0
Volume Module: >> Count Date: 7 Oct 2014 <<												
Base Vol:	108	167	43	0	0	0	17	108	0	0	115	17
Growth Adj:	1.00	1.00	1.00	1.00	1.00	1.00	1.00	1.00	1.00	1.00	1.00	1.00
Initial Bse:	108	167	43	0	0	0	17	108	0	0	115	17
Added Vol:	0	0	0	0	0	0	0	0	0	0	0	0
PasserByVol:	0	0	0	0	0	0	0	0	0	0	0	0
Initial Fut:	108	167	43	0	0	0	17	108	0	0	115	17
User Adj:	1.00	1.00	1.00	1.00	1.00	1.00	1.00	1.00	1.00	1.00	1.00	1.00
PHF Adj:	1.00	1.00	1.00	1.00	1.00	1.00	1.00	1.00	1.00	1.00	1.00	1.00
PHF Volume:	108	167	43	0	0	0	17	108	0	0	115	17
Reduct Vol:	0	0	0	0	0	0	0	0	0	0	0	0
Reduced Vol:	108	167	43	0	0	0	17	108	0	0	115	17
PCE Adj:	1.00	1.00	1.00	1.00	1.00	1.00	1.00	1.00	1.00	1.00	1.00	1.00
MLF Adj:	1.00	1.00	1.00	1.00	1.00	1.00	1.00	1.00	1.00	1.00	1.00	1.00
FinalVolume:	108	167	43	0	0	0	17	108	0	0	115	17
Saturation Flow Module:												
Sat/Lane:	1900	1900	1900	1900	1900	1900	1900	1900	1900	1900	1900	1900
Adjustment:	0.95	0.98	0.95	0.92	1.00	0.92	0.95	0.95	0.92	0.92	0.95	0.95
Lanes:	1.00	1.58	0.42	0.00	0.00	0.00	0.14	0.86	0.00	0.00	0.87	0.13
Final Sat.:	1800	2943	758	0	0	0	245	1555	0	0	1568	232
Capacity Analysis Module:												
Vol/Sat:	0.06	0.06	0.06	0.00	0.00	0.00	0.07	0.07	0.00	0.00	0.07	0.07
Crit Moves:	****									****		
Green Time:	24.3	24.3	24.3	0.0	0.0	0.0	29.7	29.7	0.0	0.0	29.7	29.7
Volume/Cap:	0.15	0.14	0.14	0.00	0.00	0.00	0.14	0.14	0.00	0.00	0.15	0.15
Delay/Veh:	11.3	11.3	11.3	0.0	0.0	0.0	8.3	8.3	0.0	0.0	8.3	8.3
User DelAdj:	1.00	1.00	1.00	1.00	1.00	1.00	1.00	1.00	1.00	1.00	1.00	1.00
AdjDel/Veh:	11.3	11.3	11.3	0.0	0.0	0.0	8.3	8.3	0.0	0.0	8.3	8.3
LOS by Move:	B	B	B	A	A	A	A	A	A	A	A	A
HCM2k95thQ:	3	2	2	0	0	0	3	3	0	0	3	3

Note: Queue reported is the number of cars per lane.

BART Phase II Extension Project

Level Of Service Computation Report
2000 HCM Operations (Future Volume Alternative)
AM - Existing Plus Project Conditions

Intersection #3266: AUZERAIS/BIRD

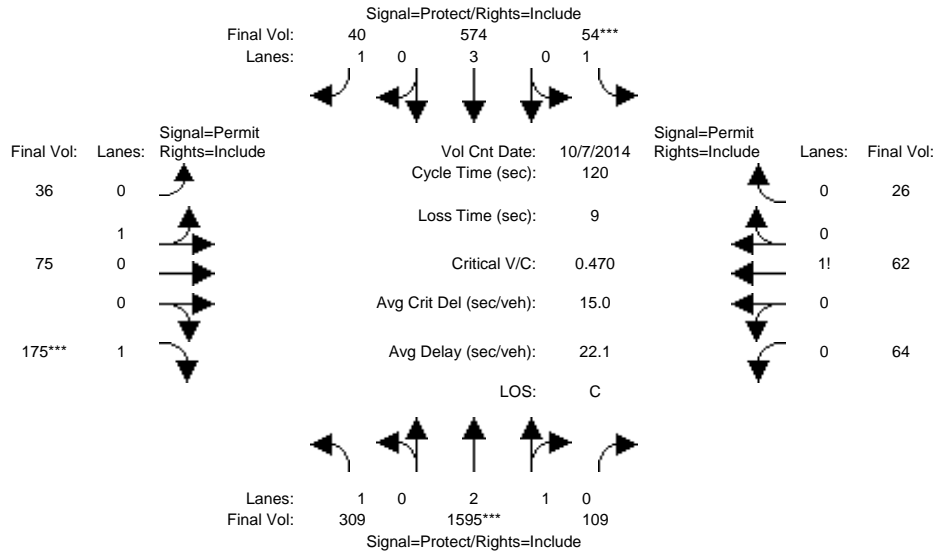

Approach:	North Bound			South Bound			East Bound			West Bound		
	L	T	R	L	T	R	L	T	R	L	T	R
Min. Green:	7	10	10	7	10	10	10	10	10	10	10	10
Y+R:	4.0	4.0	4.0	4.0	4.0	4.0	4.0	4.0	4.0	4.0	4.0	4.0
Volume Module: >> Count Date: 7 Oct 2014 <<												
Base Vol:	309	1595	109	54	574	40	36	75	175	64	62	26
Growth Adj:	1.00	1.00	1.00	1.00	1.00	1.00	1.00	1.00	1.00	1.00	1.00	1.00
Initial Bse:	309	1595	109	54	574	40	36	75	175	64	62	26
Added Vol:	0	0	0	0	0	0	0	0	0	0	0	0
PasserByVol:	0	0	0	0	0	0	0	0	0	0	0	0
Initial Fut:	309	1595	109	54	574	40	36	75	175	64	62	26
User Adj:	1.00	1.00	1.00	1.00	1.00	1.00	1.00	1.00	1.00	1.00	1.00	1.00
PHF Adj:	1.00	1.00	1.00	1.00	1.00	1.00	1.00	1.00	1.00	1.00	1.00	1.00
PHF Volume:	309	1595	109	54	574	40	36	75	175	64	62	26
Reduct Vol:	0	0	0	0	0	0	0	0	0	0	0	0
Reduced Vol:	309	1595	109	54	574	40	36	75	175	64	62	26
PCE Adj:	1.00	1.00	1.00	1.00	1.00	1.00	1.00	1.00	1.00	1.00	1.00	1.00
MLF Adj:	1.00	1.00	1.00	1.00	1.00	1.00	1.00	1.00	1.00	1.00	1.00	1.00
Final Volume:	309	1595	109	54	574	40	36	75	175	64	62	26
Saturation Flow Module:												
Sat/Lane:	1900	1900	1900	1900	1900	1900	1900	1900	1900	1900	1900	1900
Adjustment:	0.92	0.98	0.95	0.92	1.00	0.92	0.95	0.95	0.92	0.92	0.92	0.92
Lanes:	1.00	2.80	0.20	1.00	3.00	1.00	0.32	0.68	1.00	0.42	0.41	0.17
Final Sat.:	1750	5241	358	1750	5700	1750	584	1216	1750	737	714	299
Capacity Analysis Module:												
Vol/Sat:	0.18	0.30	0.30	0.03	0.10	0.02	0.06	0.06	0.10	0.09	0.09	0.09
Crit Moves:	****			****			****			****		
Green Time:	54.4	77.6	77.6	7.9	31.0	31.0	25.5	25.5	25.5	25.5	25.5	25.5
Volume/Cap:	0.39	0.47	0.47	0.47	0.39	0.09	0.29	0.29	0.47	0.41	0.41	0.41
Delay/Veh:	22.1	10.9	10.9	57.1	36.8	33.8	40.1	40.1	42.3	41.5	41.5	41.5
User DelAdj:	1.00	1.00	1.00	1.00	1.00	1.00	1.00	1.00	1.00	1.00	1.00	1.00
AdjDel/Veh:	22.1	10.9	10.9	57.1	36.8	33.8	40.1	40.1	42.3	41.5	41.5	41.5
LOS by Move:	C	B	B	E	D	C	D	D	D	D	D	D
HCM2k95thQ:	15	19	19	4	11	2	7	7	12	10	10	10

Note: Queue reported is the number of cars per lane.

BART Phase II Extension Project

Level Of Service Computation Report
 2000 HCM Operations (Future Volume Alternative)
 PM - Existing Plus Project Conditions

Intersection #3266: AUZERAIS/BIRD

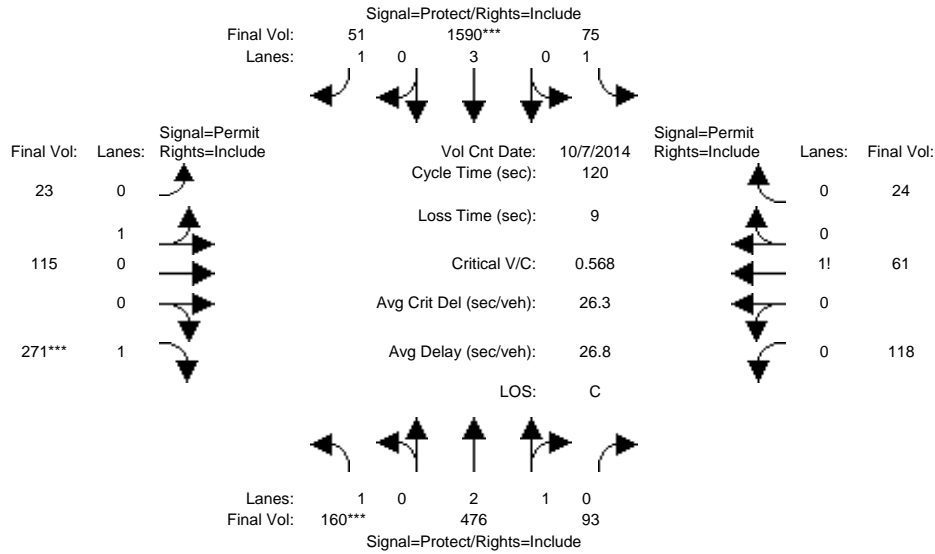

Approach:	North Bound			South Bound			East Bound			West Bound		
Movement:	L	T	R	L	T	R	L	T	R	L	T	R
Min. Green:	7	10	10	7	10	10	10	10	10	10	10	10
Y+R:	4.0	4.0	4.0	4.0	4.0	4.0	4.0	4.0	4.0	4.0	4.0	4.0
Volume Module: >> Count Date: 7 Oct 2014 <<												
Base Vol:	160	476	93	75	1590	51	23	115	271	118	61	24
Growth Adj:	1.00	1.00	1.00	1.00	1.00	1.00	1.00	1.00	1.00	1.00	1.00	1.00
Initial Bse:	160	476	93	75	1590	51	23	115	271	118	61	24
Added Vol:	0	0	0	0	0	0	0	0	0	0	0	0
PasserByVol:	0	0	0	0	0	0	0	0	0	0	0	0
Initial Fut:	160	476	93	75	1590	51	23	115	271	118	61	24
User Adj:	1.00	1.00	1.00	1.00	1.00	1.00	1.00	1.00	1.00	1.00	1.00	1.00
PHF Adj:	1.00	1.00	1.00	1.00	1.00	1.00	1.00	1.00	1.00	1.00	1.00	1.00
PHF Volume:	160	476	93	75	1590	51	23	115	271	118	61	24
Reduct Vol:	0	0	0	0	0	0	0	0	0	0	0	0
Reduced Vol:	160	476	93	75	1590	51	23	115	271	118	61	24
PCE Adj:	1.00	1.00	1.00	1.00	1.00	1.00	1.00	1.00	1.00	1.00	1.00	1.00
MLF Adj:	1.00	1.00	1.00	1.00	1.00	1.00	1.00	1.00	1.00	1.00	1.00	1.00
FinalVolume:	160	476	93	75	1590	51	23	115	271	118	61	24
Saturation Flow Module:												
Sat/Lane:	1900	1900	1900	1900	1900	1900	1900	1900	1900	1900	1900	1900
Adjustment:	0.92	0.99	0.95	0.92	1.00	0.92	0.95	0.95	0.92	0.92	0.92	0.92
Lanes:	1.00	2.49	0.51	1.00	3.00	1.00	0.17	0.83	1.00	0.58	0.30	0.12
Final Sat.:	1750	4684	915	1750	5700	1750	300	1500	1750	1017	526	207
Capacity Analysis Module:												
Vol/Sat:	0.09	0.10	0.10	0.04	0.28	0.03	0.08	0.08	0.15	0.12	0.12	0.12
Crit Moves:	****				****				****			
Green Time:	19.3	49.7	49.7	28.5	59.0	59.0	32.7	32.7	32.7	32.7	32.7	32.7
Volume/Cap:	0.57	0.25	0.25	0.18	0.57	0.06	0.28	0.28	0.57	0.43	0.43	0.43
Delay/Veh:	49.2	23.0	23.0	36.6	21.8	16.0	34.7	34.7	39.2	36.5	36.5	36.5
User DelAdj:	1.00	1.00	1.00	1.00	1.00	1.00	1.00	1.00	1.00	1.00	1.00	1.00
AdjDel/Veh:	49.2	23.0	23.0	36.6	21.8	16.0	34.7	34.7	39.2	36.5	36.5	36.5
LOS by Move:	D	C	C	D	C	B	C	C	D	D	D	D
HCM2k95thQ:	11	9	9	5	24	2	8	8	17	12	12	12

Note: Queue reported is the number of cars per lane.

BART Phase II Extension Project

Level Of Service Computation Report
 2000 HCM Operations (Future Volume Alternative)
 AM - Existing Plus Project Conditions

Intersection #3363: CAHILL/SANTA CLARA

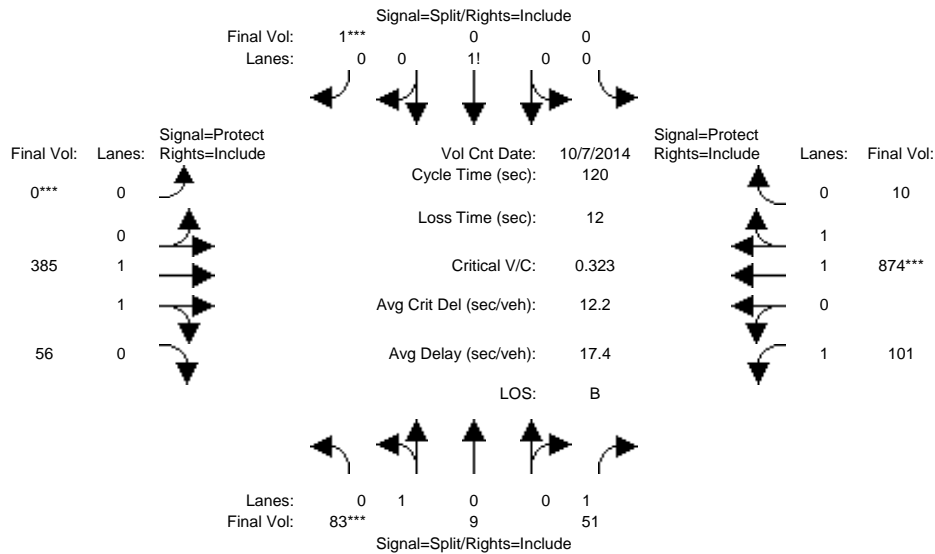

Approach:	North Bound			South Bound			East Bound			West Bound		
Movement:	L	T	R	L	T	R	L	T	R	L	T	R
Min. Green:	10	10	10	10	10	10	7	10	10	7	10	10
Y+R:	4.0	4.0	4.0	4.0	4.0	4.0	4.0	4.0	4.0	4.0	4.0	4.0
Volume Module: >> Count Date: 7 Oct 2014 <<												
Base Vol:	83	9	51	0	0	1	0	385	56	101	874	10
Growth Adj:	1.00	1.00	1.00	1.00	1.00	1.00	1.00	1.00	1.00	1.00	1.00	1.00
Initial Bse:	83	9	51	0	0	1	0	385	56	101	874	10
Added Vol:	0	0	0	0	0	0	0	0	0	0	0	0
PasserByVol:	0	0	0	0	0	0	0	0	0	0	0	0
Initial Fut:	83	9	51	0	0	1	0	385	56	101	874	10
User Adj:	1.00	1.00	1.00	1.00	1.00	1.00	1.00	1.00	1.00	1.00	1.00	1.00
PHF Adj:	1.00	1.00	1.00	1.00	1.00	1.00	1.00	1.00	1.00	1.00	1.00	1.00
PHF Volume:	83	9	51	0	0	1	0	385	56	101	874	10
Reduct Vol:	0	0	0	0	0	0	0	0	0	0	0	0
Reduced Vol:	83	9	51	0	0	1	0	385	56	101	874	10
PCE Adj:	1.00	1.00	1.00	1.00	1.00	1.00	1.00	1.00	1.00	1.00	1.00	1.00
MLF Adj:	1.00	1.00	1.00	1.00	1.00	1.00	1.00	1.00	1.00	1.00	1.00	1.00
FinalVolume:	83	9	51	0	0	1	0	385	56	101	874	10
Saturation Flow Module:												
Sat/Lane:	1900	1900	1900	1900	1900	1900	1900	1900	1900	1900	1900	1900
Adjustment:	0.95	0.95	0.92	0.92	1.00	0.92	0.92	0.98	0.95	0.92	0.97	0.95
Lanes:	0.90	0.10	1.00	0.00	0.00	1.00	0.00	1.74	0.26	1.00	1.98	0.02
Final Sat.:	1624	176	1750	0	0	1750	0	3230	470	1750	3658	42
Capacity Analysis Module:												
Vol/Sat:	0.05	0.05	0.03	0.00	0.00	0.00	0.00	0.12	0.12	0.06	0.24	0.24
Crit Moves:	****					****	****				****	
Green Time:	17.3	17.3	17.3	0.0	0.0	10.0	0.0	54.2	54.2	26.5	80.7	80.7
Volume/Cap:	0.36	0.36	0.20	0.00	0.00	0.01	0.00	0.26	0.26	0.26	0.36	0.36
Delay/Veh:	47.2	47.2	45.7	0.0	0.0	50.5	0.0	20.6	20.6	39.0	8.5	8.5
User DelAdj:	1.00	1.00	1.00	1.00	1.00	1.00	1.00	1.00	1.00	1.00	1.00	1.00
AdjDel/Veh:	47.2	47.2	45.7	0.0	0.0	50.5	0.0	20.6	20.6	39.0	8.5	8.5
LOS by Move:	D	D	D	A	A	D	A	C	C	D	A	A
HCM2k95thQ:	7	7	4	0	0	0	0	10	10	6	13	13

Note: Queue reported is the number of cars per lane.

BART Phase II Extension Project

Level Of Service Computation Report
 2000 HCM Operations (Future Volume Alternative)
 PM - Existing Plus Project Conditions

Intersection #3363: CAHILL/SANTA CLARA

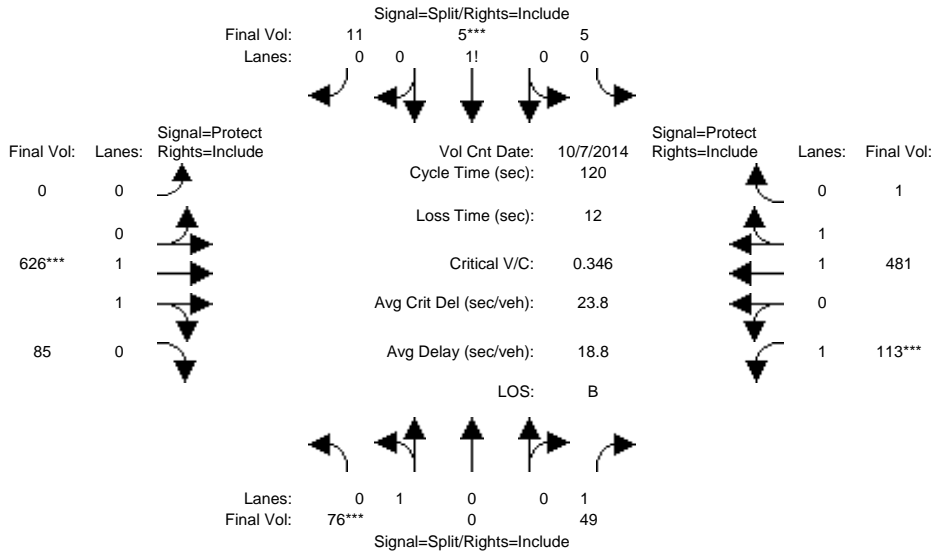

Approach:	North Bound			South Bound			East Bound			West Bound		
	L	T	R	L	T	R	L	T	R	L	T	R
Min. Green:	10	10	10	10	10	10	7	10	10	7	10	10
Y+R:	4.0	4.0	4.0	4.0	4.0	4.0	4.0	4.0	4.0	4.0	4.0	4.0
Volume Module: >> Count Date: 7 Oct 2014 <<												
Base Vol:	76	0	49	5	5	11	0	626	85	113	481	1
Growth Adj:	1.00	1.00	1.00	1.00	1.00	1.00	1.00	1.00	1.00	1.00	1.00	1.00
Initial Bse:	76	0	49	5	5	11	0	626	85	113	481	1
Added Vol:	0	0	0	0	0	0	0	0	0	0	0	0
PasserByVol:	0	0	0	0	0	0	0	0	0	0	0	0
Initial Fut:	76	0	49	5	5	11	0	626	85	113	481	1
User Adj:	1.00	1.00	1.00	1.00	1.00	1.00	1.00	1.00	1.00	1.00	1.00	1.00
PHF Adj:	1.00	1.00	1.00	1.00	1.00	1.00	1.00	1.00	1.00	1.00	1.00	1.00
PHF Volume:	76	0	49	5	5	11	0	626	85	113	481	1
Reduct Vol:	0	0	0	0	0	0	0	0	0	0	0	0
Reduced Vol:	76	0	49	5	5	11	0	626	85	113	481	1
PCE Adj:	1.00	1.00	1.00	1.00	1.00	1.00	1.00	1.00	1.00	1.00	1.00	1.00
MLF Adj:	1.00	1.00	1.00	1.00	1.00	1.00	1.00	1.00	1.00	1.00	1.00	1.00
FinalVolume:	76	0	49	5	5	11	0	626	85	113	481	1
Saturation Flow Module:												
Sat/Lane:	1900	1900	1900	1900	1900	1900	1900	1900	1900	1900	1900	1900
Adjustment:	0.95	0.95	0.92	0.92	0.92	0.92	0.92	0.98	0.95	0.92	0.97	0.95
Lanes:	1.00	0.00	1.00	0.24	0.24	0.52	0.00	1.75	0.25	1.00	1.99	0.01
Final Sat.:	1800	0	1750	417	417	917	0	3257	442	1750	3692	8
Capacity Analysis Module:												
Vol/Sat:	0.04	0.00	0.03	0.01	0.01	0.01	0.00	0.19	0.19	0.06	0.13	0.13
Crit Moves:	****			****			****			****		
Green Time:	13.8	0.0	13.8	10.0	10.0	10.0	0.0	63.0	63.0	21.2	84.2	84.2
Volume/Cap:	0.37	0.00	0.24	0.14	0.14	0.14	0.00	0.37	0.37	0.37	0.19	0.19
Delay/Veh:	50.1	0.0	48.9	51.5	51.5	51.5	0.0	16.9	16.9	44.2	6.2	6.2
User DelAdj:	1.00	1.00	1.00	1.00	1.00	1.00	1.00	1.00	1.00	1.00	1.00	1.00
AdjDel/Veh:	50.1	0.0	48.9	51.5	51.5	51.5	0.0	16.9	16.9	44.2	6.2	6.2
LOS by Move:	D	A	D	D	D	D	A	B	B	D	A	A
HCM2k95thQ:	6	0	4	2	2	2	0	14	14	8	6	6

Note: Queue reported is the number of cars per lane.

BART Phase II Extension Project

Level Of Service Computation Report
2000 HCM Operations (Future Volume Alternative)
AM - Existing Plus Project Conditions

Intersection #3445: DELMAS/PARK *

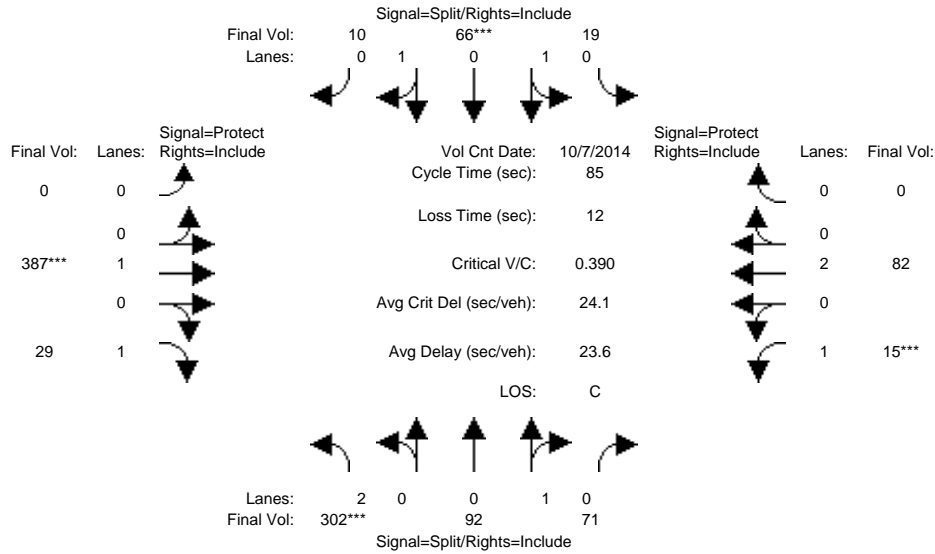

Approach:	North Bound			South Bound			East Bound			West Bound		
	L	T	R	L	T	R	L	T	R	L	T	R
Min. Green:	10	10	10	10	10	10	0	10	10	7	10	0
Y+R:	4.0	4.0	4.0	4.0	4.0	4.0	4.0	4.0	4.0	4.0	4.0	4.0

Volume Module: >> Count Date: 7 Oct 2014 <<

Base Vol:	302	92	71	19	66	10	0	387	29	15	82	0
Growth Adj:	1.00	1.00	1.00	1.00	1.00	1.00	1.00	1.00	1.00	1.00	1.00	1.00
Initial Bse:	302	92	71	19	66	10	0	387	29	15	82	0
Added Vol:	0	0	0	0	0	0	0	0	0	0	0	0
PasserByVol:	0	0	0	0	0	0	0	0	0	0	0	0
Initial Fut:	302	92	71	19	66	10	0	387	29	15	82	0
User Adj:	1.00	1.00	1.00	1.00	1.00	1.00	1.00	1.00	1.00	1.00	1.00	1.00
PHF Adj:	1.00	1.00	1.00	1.00	1.00	1.00	1.00	1.00	1.00	1.00	1.00	1.00
PHF Volume:	302	92	71	19	66	10	0	387	29	15	82	0
Reduct Vol:	0	0	0	0	0	0	0	0	0	0	0	0
Reduced Vol:	302	92	71	19	66	10	0	387	29	15	82	0
PCE Adj:	1.00	1.00	1.00	1.00	1.00	1.00	1.00	1.00	1.00	1.00	1.00	1.00
MLF Adj:	1.00	1.00	1.00	1.00	1.00	1.00	1.00	1.00	1.00	1.00	1.00	1.00
FinalVolume:	302	92	71	19	66	10	0	387	29	15	82	0

Saturation Flow Module:

Sat/Lane:	1900	1900	1900	1900	1900	1900	1900	1900	1900	1900	1900	1900
Adjustment:	0.83	0.95	0.95	0.95	0.95	0.95	0.92	1.00	0.92	0.92	1.00	0.92
Lanes:	2.00	0.56	0.44	0.40	1.39	0.21	0.00	1.00	1.00	1.00	2.00	0.00
Final Sat.:	3150	1016	784	720	2501	379	0	1900	1750	1750	3800	0

Capacity Analysis Module:

Vol/Sat:	0.10	0.09	0.09	0.03	0.03	0.03	0.00	0.20	0.02	0.01	0.02	0.00
Crit Moves:	****			****			****			****		
Green Time:	17.9	17.9	17.9	10.0	10.0	10.0	0.0	38.1	38.1	7.0	45.1	0.0
Volume/Cap:	0.45	0.43	0.43	0.22	0.22	0.22	0.00	0.45	0.04	0.10	0.04	0.00
Delay/Veh:	29.8	29.9	29.9	34.3	34.3	34.3	0.0	16.7	13.2	36.4	9.6	0.0
User DelAdj:	1.00	1.00	1.00	1.00	1.00	1.00	1.00	1.00	1.00	1.00	1.00	1.00
AdjDel/Veh:	29.8	29.9	29.9	34.3	34.3	34.3	0.0	16.7	13.2	36.4	9.6	0.0
LOS by Move:	C	C	C	C	C	C	A	B	B	D	A	A
HCM2k95thQ:	9	8	8	2	2	2	0	13	1	1	1	0

Note: Queue reported is the number of cars per lane.

BART Phase II Extension Project

Level Of Service Computation Report
 2000 HCM Operations (Future Volume Alternative)
 PM - Existing Plus Project Conditions

Intersection #3445: DELMAS/PARK *

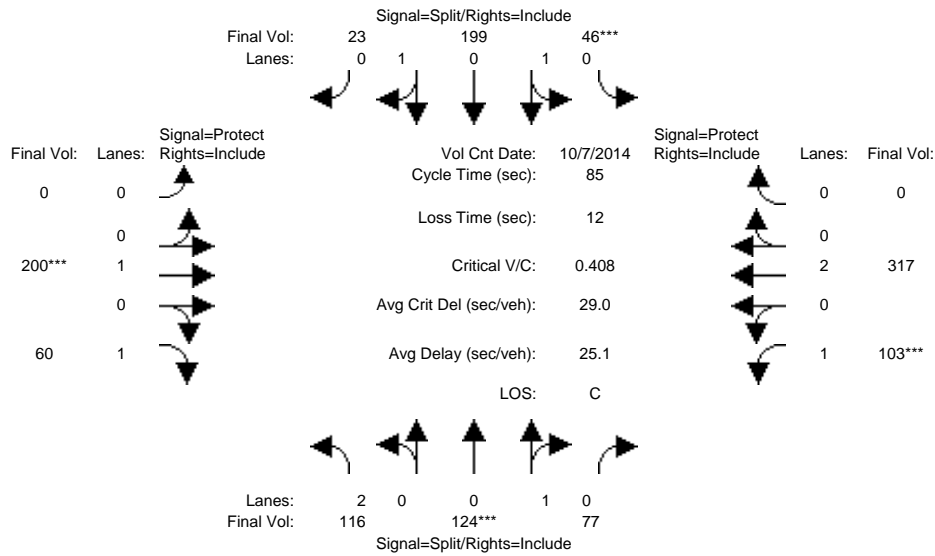

Approach:	North Bound			South Bound			East Bound			West Bound		
	L	T	R	L	T	R	L	T	R	L	T	R
Min. Green:	10	10	10	10	10	10	0	10	10	7	10	0
Y+R:	4.0	4.0	4.0	4.0	4.0	4.0	4.0	4.0	4.0	4.0	4.0	4.0
Volume Module: >> Count Date: 7 Oct 2014 <<												
Base Vol:	116	124	77	46	199	23	0	200	60	103	317	0
Growth Adj:	1.00	1.00	1.00	1.00	1.00	1.00	1.00	1.00	1.00	1.00	1.00	1.00
Initial Bse:	116	124	77	46	199	23	0	200	60	103	317	0
Added Vol:	0	0	0	0	0	0	0	0	0	0	0	0
PasserByVol:	0	0	0	0	0	0	0	0	0	0	0	0
Initial Fut:	116	124	77	46	199	23	0	200	60	103	317	0
User Adj:	1.00	1.00	1.00	1.00	1.00	1.00	1.00	1.00	1.00	1.00	1.00	1.00
PHF Adj:	1.00	1.00	1.00	1.00	1.00	1.00	1.00	1.00	1.00	1.00	1.00	1.00
PHF Volume:	116	124	77	46	199	23	0	200	60	103	317	0
Reduct Vol:	0	0	0	0	0	0	0	0	0	0	0	0
Reduced Vol:	116	124	77	46	199	23	0	200	60	103	317	0
PCE Adj:	1.00	1.00	1.00	1.00	1.00	1.00	1.00	1.00	1.00	1.00	1.00	1.00
MLF Adj:	1.00	1.00	1.00	1.00	1.00	1.00	1.00	1.00	1.00	1.00	1.00	1.00
FinalVolume:	116	124	77	46	199	23	0	200	60	103	317	0
Saturation Flow Module:												
Sat/Lane:	1900	1900	1900	1900	1900	1900	1900	1900	1900	1900	1900	1900
Adjustment:	0.83	0.95	0.95	0.95	0.95	0.95	0.92	1.00	0.92	0.92	1.00	0.92
Lanes:	2.00	0.62	0.38	0.34	1.49	0.17	0.00	1.00	1.00	1.00	2.00	0.00
Final Sat.:	3150	1110	690	618	2673	309	0	1900	1750	1750	3800	0
Capacity Analysis Module:												
Vol/Sat:	0.04	0.11	0.11	0.07	0.07	0.07	0.00	0.11	0.03	0.06	0.08	0.00
Crit Moves:	****			****			****			****		
Green Time:	23.3	23.3	23.3	15.5	15.5	15.5	0.0	21.9	21.9	12.3	34.2	0.0
Volume/Cap:	0.13	0.41	0.41	0.41	0.41	0.41	0.00	0.41	0.13	0.41	0.21	0.00
Delay/Veh:	23.3	25.8	25.8	31.1	31.1	31.1	0.0	26.7	24.4	34.1	16.6	0.0
User DelAdj:	1.00	1.00	1.00	1.00	1.00	1.00	1.00	1.00	1.00	1.00	1.00	1.00
AdjDel/Veh:	23.3	25.8	25.8	31.1	31.1	31.1	0.0	26.7	24.4	34.1	16.6	0.0
LOS by Move:	C	C	C	C	C	C	A	C	C	C	B	A
HCM2k95thQ:	3	9	9	6	6	6	0	8	3	5	5	0

Note: Queue reported is the number of cars per lane.

BART Phase II Extension Project

Level Of Service Computation Report
 2000 HCM Operations (Future Volume Alternative)
 AM - Existing Plus Project Conditions

Intersection #3552: FRUITDALE/MERIDIAN

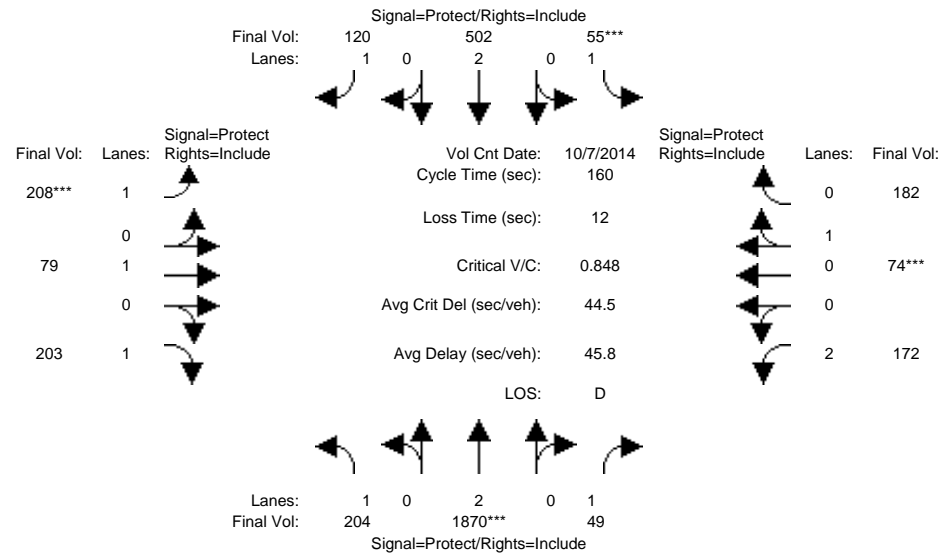

Approach:	North Bound			South Bound			East Bound			West Bound		
	L	T	R	L	T	R	L	T	R	L	T	R
Min. Green:	7	10	10	7	10	10	7	10	10	7	10	10
Y+R:	4.0	4.0	4.0	4.0	4.0	4.0	4.0	4.0	4.0	4.0	4.0	4.0

Volume Module:	>>	Count	Date:	7 Oct 2014	<<							
Base Vol:	204	1870	49	55	502	120	208	79	203	172	74	182
Growth Adj:	1.00	1.00	1.00	1.00	1.00	1.00	1.00	1.00	1.00	1.00	1.00	1.00
Initial Bse:	204	1870	49	55	502	120	208	79	203	172	74	182
Added Vol:	0	0	0	0	0	0	0	0	0	0	0	0
PasserByVol:	0	0	0	0	0	0	0	0	0	0	0	0
Initial Fut:	204	1870	49	55	502	120	208	79	203	172	74	182
User Adj:	1.00	1.00	1.00	1.00	1.00	1.00	1.00	1.00	1.00	1.00	1.00	1.00
PHF Adj:	1.00	1.00	1.00	1.00	1.00	1.00	1.00	1.00	1.00	1.00	1.00	1.00
PHF Volume:	204	1870	49	55	502	120	208	79	203	172	74	182
Reduct Vol:	0	0	0	0	0	0	0	0	0	0	0	0
Reduced Vol:	204	1870	49	55	502	120	208	79	203	172	74	182
PCE Adj:	1.00	1.00	1.00	1.00	1.00	1.00	1.00	1.00	1.00	1.00	1.00	1.00
MLF Adj:	1.00	1.00	1.00	1.00	1.00	1.00	1.00	1.00	1.00	1.00	1.00	1.00
Final Volume:	204	1870	49	55	502	120	208	79	203	172	74	182

Saturation Flow Module:												
Sat/Lane:	1900	1900	1900	1900	1900	1900	1900	1900	1900	1900	1900	1900
Adjustment:	0.92	1.00	0.92	0.92	1.00	0.92	0.92	1.00	0.92	0.83	0.95	0.95
Lanes:	1.00	2.00	1.00	1.00	2.00	1.00	1.00	1.00	1.00	2.00	0.29	0.71
Final Sat.:	1750	3800	1750	1750	3800	1750	1750	1900	1750	3150	520	1280

Capacity Analysis Module:												
Vol/Sat:	0.12	0.49	0.03	0.03	0.13	0.07	0.12	0.04	0.12	0.05	0.14	0.14
Crit Moves:	****	****	****	****	****	****	****	****	****	****	****	****
Green Time:	46.5	92.1	92.1	7.0	52.7	52.7	22.3	33.2	33.2	15.6	26.6	26.6
Volume/Cap:	0.40	0.85	0.05	0.72	0.40	0.21	0.85	0.20	0.56	0.56	0.85	0.85
Delay/Veh:	46.1	31.9	14.8	103.3	41.7	38.8	91.6	52.6	58.8	71.2	85.4	85.4
User DelAdj:	1.00	1.00	1.00	1.00	1.00	1.00	1.00	1.00	1.00	1.00	1.00	1.00
AdjDel/Veh:	46.1	31.9	14.8	103.3	41.7	38.8	91.6	52.6	58.8	71.2	85.4	85.4
LOS by Move:	D	C	B	F	D	D	F	D	E	E	F	F
HCM2k95thQ:	16	62	2	6	17	9	21	6	17	11	27	27

Note: Queue reported is the number of cars per lane.

BART Phase II Extension Project

Level Of Service Computation Report
2000 HCM Operations (Future Volume Alternative)
PM - Existing Plus Project Conditions

Intersection #3552: FRUITDALE/MERIDIAN

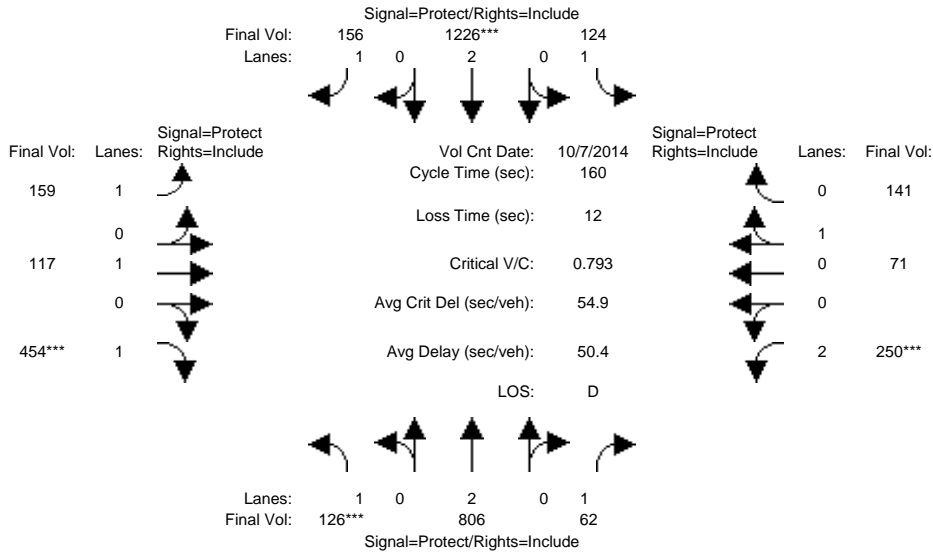

Approach:	North Bound			South Bound			East Bound			West Bound		
Movement:	L	T	R	L	T	R	L	T	R	L	T	R
Min. Green:	7	10	10	7	10	10	7	10	10	7	10	10
Y+R:	4.0	4.0	4.0	4.0	4.0	4.0	4.0	4.0	4.0	4.0	4.0	4.0
Volume Module: >> Count Date: 7 Oct 2014 <<												
Base Vol:	126	806	62	124	1226	156	159	117	454	250	71	141
Growth Adj:	1.00	1.00	1.00	1.00	1.00	1.00	1.00	1.00	1.00	1.00	1.00	1.00
Initial Bse:	126	806	62	124	1226	156	159	117	454	250	71	141
Added Vol:	0	0	0	0	0	0	0	0	0	0	0	0
PasserByVol:	0	0	0	0	0	0	0	0	0	0	0	0
Initial Fut:	126	806	62	124	1226	156	159	117	454	250	71	141
User Adj:	1.00	1.00	1.00	1.00	1.00	1.00	1.00	1.00	1.00	1.00	1.00	1.00
PHF Adj:	1.00	1.00	1.00	1.00	1.00	1.00	1.00	1.00	1.00	1.00	1.00	1.00
PHF Volume:	126	806	62	124	1226	156	159	117	454	250	71	141
Reduct Vol:	0	0	0	0	0	0	0	0	0	0	0	0
Reduced Vol:	126	806	62	124	1226	156	159	117	454	250	71	141
PCE Adj:	1.00	1.00	1.00	1.00	1.00	1.00	1.00	1.00	1.00	1.00	1.00	1.00
MLF Adj:	1.00	1.00	1.00	1.00	1.00	1.00	1.00	1.00	1.00	1.00	1.00	1.00
Final Volume:	126	806	62	124	1226	156	159	117	454	250	71	141
Saturation Flow Module:												
Sat/Lane:	1900	1900	1900	1900	1900	1900	1900	1900	1900	1900	1900	1900
Adjustment:	0.92	1.00	0.92	0.92	1.00	0.92	0.92	1.00	0.92	0.83	0.95	0.95
Lanes:	1.00	2.00	1.00	1.00	2.00	1.00	1.00	1.00	1.00	2.00	0.33	0.67
Final Sat.:	1750	3800	1750	1750	3800	1750	1750	1900	1750	3150	603	1197
Capacity Analysis Module:												
Vol/Sat:	0.07	0.21	0.04	0.07	0.32	0.09	0.09	0.06	0.26	0.08	0.12	0.12
Crit Moves:	****			****			****		****	****		
Green Time:	14.5	59.7	59.7	19.9	65.1	65.1	29.8	52.4	52.4	16.0	38.6	38.6
Volume/Cap:	0.79	0.57	0.09	0.57	0.79	0.22	0.49	0.19	0.79	0.79	0.49	0.49
Delay/Veh:	94.5	40.5	32.7	69.5	44.4	31.1	59.4	38.7	56.4	83.2	53.1	53.1
User DelAdj:	1.00	1.00	1.00	1.00	1.00	1.00	1.00	1.00	1.00	1.00	1.00	1.00
AdjDel/Veh:	94.5	40.5	32.7	69.5	44.4	31.1	59.4	38.7	56.4	83.2	53.1	53.1
LOS by Move:	F	D	C	E	D	C	E	D	E	F	D	D
HCM2k95thQ:	16	27	4	12	44	10	14	8	37	17	18	18

Note: Queue reported is the number of cars per lane.

BART Phase II Extension Project

Level Of Service Computation Report
 2000 HCM Operations (Future Volume Alternative)
 AM - Existing Plus Project Conditions

Intersection #3553: FRUITDALE/SOUTHWEST

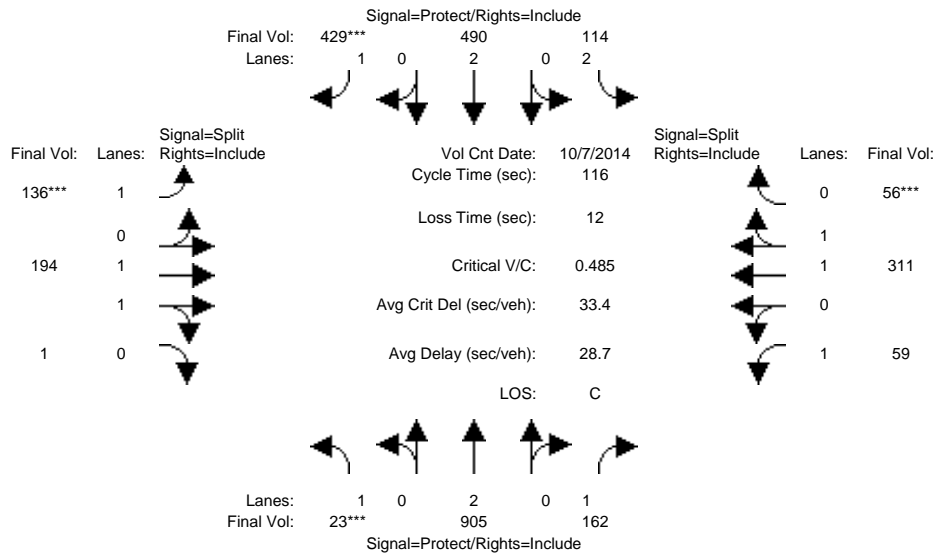

Approach:	North Bound			South Bound			East Bound			West Bound		
Movement:	L	T	R	L	T	R	L	T	R	L	T	R
Min. Green:	7	10	10	7	10	10	10	10	10	10	10	10
Y+R:	4.0	4.0	4.0	4.0	4.0	4.0	4.0	4.0	4.0	4.0	4.0	4.0
Volume Module: >> Count Date: 7 Oct 2014 <<												
Base Vol:	23	905	162	114	490	429	136	194	1	59	311	56
Growth Adj:	1.00	1.00	1.00	1.00	1.00	1.00	1.00	1.00	1.00	1.00	1.00	1.00
Initial Bse:	23	905	162	114	490	429	136	194	1	59	311	56
Added Vol:	0	0	0	0	0	0	0	0	0	0	0	0
PasserByVol:	0	0	0	0	0	0	0	0	0	0	0	0
Initial Fut:	23	905	162	114	490	429	136	194	1	59	311	56
User Adj:	1.00	1.00	1.00	1.00	1.00	1.00	1.00	1.00	1.00	1.00	1.00	1.00
PHF Adj:	1.00	1.00	1.00	1.00	1.00	1.00	1.00	1.00	1.00	1.00	1.00	1.00
PHF Volume:	23	905	162	114	490	429	136	194	1	59	311	56
Reduct Vol:	0	0	0	0	0	0	0	0	0	0	0	0
Reduced Vol:	23	905	162	114	490	429	136	194	1	59	311	56
PCE Adj:	1.00	1.00	1.00	1.00	1.00	1.00	1.00	1.00	1.00	1.00	1.00	1.00
MLF Adj:	1.00	1.00	1.00	1.00	1.00	1.00	1.00	1.00	1.00	1.00	1.00	1.00
FinalVolume:	23	905	162	114	490	429	136	194	1	59	311	56
Saturation Flow Module:												
Sat/Lane:	1900	1900	1900	1900	1900	1900	1900	1900	1900	1900	1900	1900
Adjustment:	0.92	1.00	0.92	0.83	1.00	0.92	0.92	0.97	0.95	0.92	0.98	0.95
Lanes:	1.00	2.00	1.00	2.00	2.00	1.00	1.00	1.99	0.01	1.00	1.69	0.31
Final Sat.:	1750	3800	1750	3150	3800	1750	1750	3681	19	1750	3135	565
Capacity Analysis Module:												
Vol/Sat:	0.01	0.24	0.09	0.04	0.13	0.25	0.08	0.05	0.05	0.03	0.10	0.10
Crit Moves:	****					****	****					****
Green Time:	7.0	50.5	50.5	12.8	56.3	56.3	17.9	17.9	17.9	22.8	22.8	22.8
Volume/Cap:	0.22	0.55	0.21	0.33	0.27	0.50	0.50	0.34	0.34	0.17	0.50	0.50
Delay/Veh:	52.9	24.6	20.5	48.2	17.7	20.8	46.6	44.2	44.2	39.0	42.1	42.1
User DelAdj:	1.00	1.00	1.00	1.00	1.00	1.00	1.00	1.00	1.00	1.00	1.00	1.00
AdjDel/Veh:	52.9	24.6	20.5	48.2	17.7	20.8	46.6	44.2	44.2	39.0	42.1	42.1
LOS by Move:	D	C	C	D	B	C	D	D	D	D	D	D
HCM2k95thQ:	2	22	8	5	10	20	9	6	6	4	11	11

Note: Queue reported is the number of cars per lane.

BART Phase II Extension Project

Level Of Service Computation Report
 2000 HCM Operations (Future Volume Alternative)
 PM - Existing Plus Project Conditions

Intersection #3553: FRUITDALE/SOUTHWEST

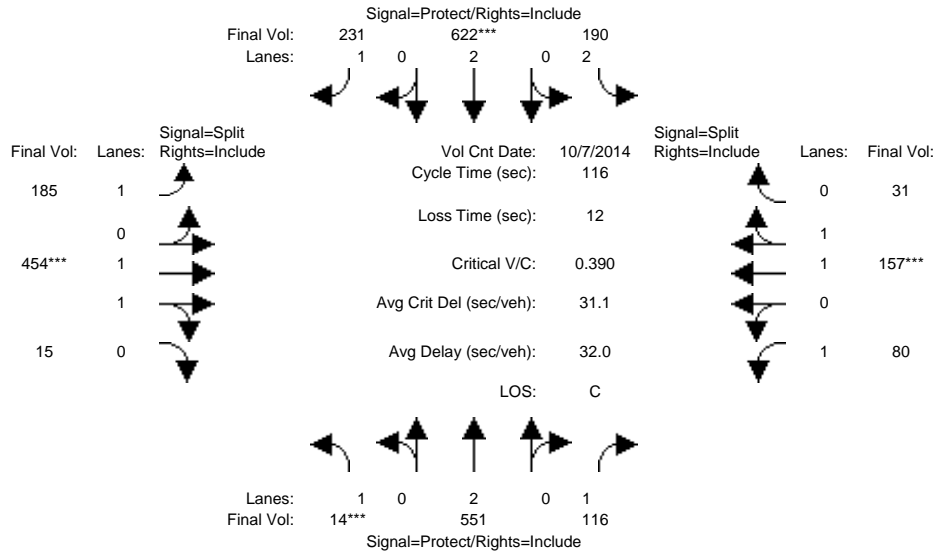

Approach:	North Bound			South Bound			East Bound			West Bound		
	L	T	R	L	T	R	L	T	R	L	T	R
Min. Green:	7	10	10	7	10	10	10	10	10	10	10	10
Y+R:	4.0	4.0	4.0	4.0	4.0	4.0	4.0	4.0	4.0	4.0	4.0	4.0

Volume Module:	>> Count Date: 7 Oct 2014 <<											
Base Vol:	14	551	116	190	622	231	185	454	15	80	157	31
Growth Adj:	1.00	1.00	1.00	1.00	1.00	1.00	1.00	1.00	1.00	1.00	1.00	1.00
Initial Bse:	14	551	116	190	622	231	185	454	15	80	157	31
Added Vol:	0	0	0	0	0	0	0	0	0	0	0	0
PasserByVol:	0	0	0	0	0	0	0	0	0	0	0	0
Initial Fut:	14	551	116	190	622	231	185	454	15	80	157	31
User Adj:	1.00	1.00	1.00	1.00	1.00	1.00	1.00	1.00	1.00	1.00	1.00	1.00
PHF Adj:	1.00	1.00	1.00	1.00	1.00	1.00	1.00	1.00	1.00	1.00	1.00	1.00
PHF Volume:	14	551	116	190	622	231	185	454	15	80	157	31
Reduct Vol:	0	0	0	0	0	0	0	0	0	0	0	0
Reduced Vol:	14	551	116	190	622	231	185	454	15	80	157	31
PCE Adj:	1.00	1.00	1.00	1.00	1.00	1.00	1.00	1.00	1.00	1.00	1.00	1.00
MLF Adj:	1.00	1.00	1.00	1.00	1.00	1.00	1.00	1.00	1.00	1.00	1.00	1.00
FinalVolume:	14	551	116	190	622	231	185	454	15	80	157	31

Saturation Flow Module:												
Sat/Lane:	1900	1900	1900	1900	1900	1900	1900	1900	1900	1900	1900	1900
Adjustment:	0.92	1.00	0.92	0.83	1.00	0.92	0.92	0.97	0.95	0.92	0.98	0.95
Lanes:	1.00	2.00	1.00	2.00	2.00	1.00	1.00	1.93	0.07	1.00	1.66	0.34
Final Sat.:	1750	3800	1750	3150	3800	1750	1750	3582	118	1750	3089	610

Capacity Analysis Module:												
Vol/Sat:	0.01	0.15	0.07	0.06	0.16	0.13	0.11	0.13	0.13	0.05	0.05	0.05
Crit Moves:	****				****			****			****	
Green Time:	7.0	37.8	37.8	15.7	46.5	46.5	36.0	36.0	36.0	14.4	14.4	14.4
Volume/Cap:	0.13	0.45	0.20	0.44	0.41	0.33	0.34	0.41	0.41	0.37	0.41	0.41
Delay/Veh:	52.2	31.1	28.4	46.9	25.1	24.2	31.2	31.8	31.8	47.6	47.4	47.4
User DelAdj:	1.00	1.00	1.00	1.00	1.00	1.00	1.00	1.00	1.00	1.00	1.00	1.00
AdjDel/Veh:	52.2	31.1	28.4	46.9	25.1	24.2	31.2	31.8	31.8	47.6	47.4	47.4
LOS by Move:	D	C	C	D	C	C	C	C	C	D	D	D
HCM2k95thQ:	1	15	6	8	15	12	10	13	13	6	6	6

Note: Queue reported is the number of cars per lane.

BART Phase II Extension Project

Level Of Service Computation Report
2000 HCM Operations (Future Volume Alternative)
AM - Existing Plus Project Conditions

Intersection #3606: JULIAN/MONTGOMERY

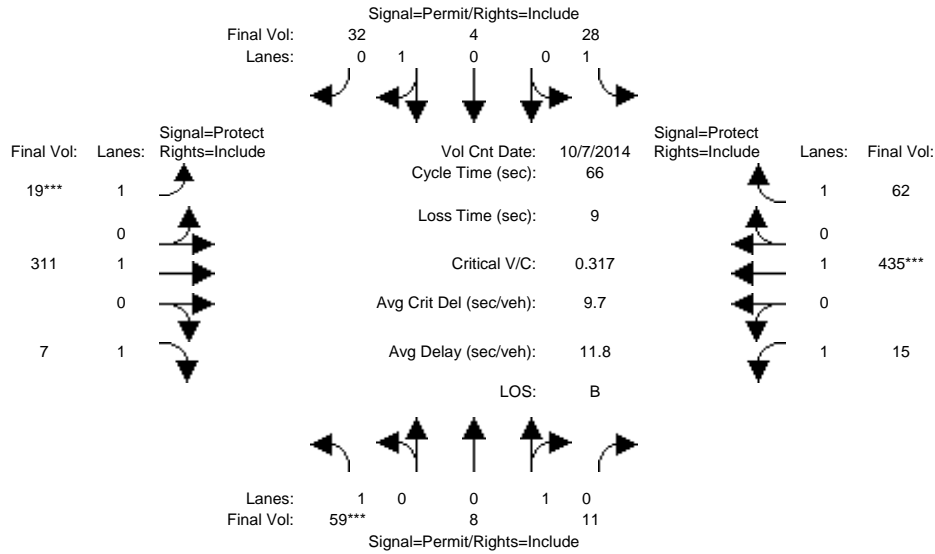

Approach:	North Bound			South Bound			East Bound			West Bound				
	L	T	R	L	T	R	L	T	R	L	T	R		
Min. Green:	10	10	10	10	10	10	7	10	10	7	10	10		
Y+R:	4.0	4.0	4.0	4.0	4.0	4.0	4.0	4.0	4.0	4.0	4.0	4.0		
Volume Module: >> Count Date: 7 Oct 2014 <<														
Base Vol:	59	8	11	28	4	32	19	311	7	15	435	62		
Growth Adj:	1.00	1.00	1.00	1.00	1.00	1.00	1.00	1.00	1.00	1.00	1.00	1.00		
Initial Bse:	59	8	11	28	4	32	19	311	7	15	435	62		
Added Vol:	0	0	0	0	0	0	0	0	0	0	0	0		
PasserByVol:	0	0	0	0	0	0	0	0	0	0	0	0		
Initial Fut:	59	8	11	28	4	32	19	311	7	15	435	62		
User Adj:	1.00	1.00	1.00	1.00	1.00	1.00	1.00	1.00	1.00	1.00	1.00	1.00		
PHF Adj:	1.00	1.00	1.00	1.00	1.00	1.00	1.00	1.00	1.00	1.00	1.00	1.00		
PHF Volume:	59	8	11	28	4	32	19	311	7	15	435	62		
Reduct Vol:	0	0	0	0	0	0	0	0	0	0	0	0		
Reduced Vol:	59	8	11	28	4	32	19	311	7	15	435	62		
PCE Adj:	1.00	1.00	1.00	1.00	1.00	1.00	1.00	1.00	1.00	1.00	1.00	1.00		
MLF Adj:	1.00	1.00	1.00	1.00	1.00	1.00	1.00	1.00	1.00	1.00	1.00	1.00		
FinalVolume:	59	8	11	28	4	32	19	311	7	15	435	62		
Saturation Flow Module:														
Sat/Lane:	1900	1900	1900	1900	1900	1900	1900	1900	1900	1900	1900	1900		
Adjustment:	0.92	0.95	0.95	0.92	0.95	0.95	0.92	1.00	0.92	0.92	1.00	0.92		
Lanes:	1.00	0.42	0.58	1.00	0.11	0.89	1.00	1.00	1.00	1.00	1.00	1.00		
Final Sat.:	1750	758	1042	1750	200	1600	1750	1900	1750	1750	1900	1750		
Capacity Analysis Module:														
Vol/Sat:	0.03	0.01	0.01	0.02	0.02	0.02	0.01	0.16	0.00	0.01	0.23	0.04		
Crit Moves:	****							****						
Green Time:	10.0	10.0	10.0	10.0	10.0	10.0	7.0	28.5	28.5	18.5	40.0	40.0		
Volume/Cap:	0.22	0.07	0.07	0.11	0.13	0.13	0.10	0.38	0.01	0.03	0.38	0.06		
Delay/Veh:	25.0	24.1	24.1	24.3	24.5	24.5	26.9	13.0	10.7	17.3	6.9	5.3		
User DelAdj:	1.00	1.00	1.00	1.00	1.00	1.00	1.00	1.00	1.00	1.00	1.00	1.00		
AdjDel/Veh:	25.0	24.1	24.1	24.3	24.5	24.5	26.9	13.0	10.7	17.3	6.9	5.3		
LOS by Move:	C	C	C	C	C	C	C	B	B	B	A	A		
HCM2k95thQ:	3	1	1	1	2	2	1	8	0	0	9	1		

Note: Queue reported is the number of cars per lane.

BART Phase II Extension Project

Level Of Service Computation Report
2000 HCM Operations (Future Volume Alternative)
PM - Existing Plus Project Conditions

Intersection #3606: JULIAN/MONTGOMERY

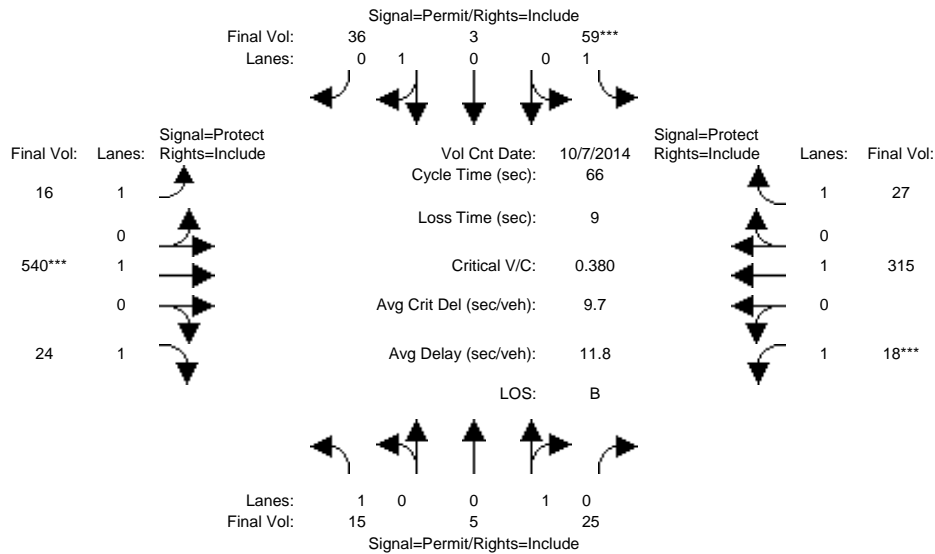

Approach:	North Bound			South Bound			East Bound			West Bound		
	L	T	R	L	T	R	L	T	R	L	T	R
Min. Green:	10	10	10	10	10	10	7	10	10	7	10	10
Y+R:	4.0	4.0	4.0	4.0	4.0	4.0	4.0	4.0	4.0	4.0	4.0	4.0

Volume Module:	>>	Count	Date:	7 Oct 2014	<<							
Base Vol:	15	5	25	59	3	36	16	540	24	18	315	27
Growth Adj:	1.00	1.00	1.00	1.00	1.00	1.00	1.00	1.00	1.00	1.00	1.00	1.00
Initial Bse:	15	5	25	59	3	36	16	540	24	18	315	27
Added Vol:	0	0	0	0	0	0	0	0	0	0	0	0
PasserByVol:	0	0	0	0	0	0	0	0	0	0	0	0
Initial Fut:	15	5	25	59	3	36	16	540	24	18	315	27
User Adj:	1.00	1.00	1.00	1.00	1.00	1.00	1.00	1.00	1.00	1.00	1.00	1.00
PHF Adj:	1.00	1.00	1.00	1.00	1.00	1.00	1.00	1.00	1.00	1.00	1.00	1.00
PHF Volume:	15	5	25	59	3	36	16	540	24	18	315	27
Reduct Vol:	0	0	0	0	0	0	0	0	0	0	0	0
Reduced Vol:	15	5	25	59	3	36	16	540	24	18	315	27
PCE Adj:	1.00	1.00	1.00	1.00	1.00	1.00	1.00	1.00	1.00	1.00	1.00	1.00
MLF Adj:	1.00	1.00	1.00	1.00	1.00	1.00	1.00	1.00	1.00	1.00	1.00	1.00
FinalVolume:	15	5	25	59	3	36	16	540	24	18	315	27

Saturation Flow Module:	Sat/Lane:	1900	1900	1900	1900	1900	1900	1900	1900	1900	1900	1900
Adjustment:	0.92	0.95	0.95	0.92	0.95	0.95	0.92	1.00	0.92	0.92	1.00	0.92
Lanes:	1.00	0.17	0.83	1.00	0.08	0.92	1.00	1.00	1.00	1.00	1.00	1.00
Final Sat.:	1750	300	1500	1750	138	1662	1750	1900	1750	1750	1900	1750

Capacity Analysis Module:	Vol/Sat:	0.01	0.02	0.02	0.03	0.02	0.02	0.01	0.28	0.01	0.01	0.17	0.02
Crit Moves:				****					****			****	
Green Time:	10.0	10.0	10.0	10.0	10.0	10.0	10.0	18.3	40.0	40.0	7.0	28.7	28.7
Volume/Cap:	0.06	0.11	0.11	0.22	0.14	0.14	0.14	0.03	0.47	0.02	0.10	0.38	0.04
Delay/Veh:	24.1	24.3	24.3	25.0	24.5	24.5	24.5	17.4	7.5	5.2	26.9	13.0	10.7
User DelAdj:	1.00	1.00	1.00	1.00	1.00	1.00	1.00	1.00	1.00	1.00	1.00	1.00	1.00
AdjDel/Veh:	24.1	24.3	24.3	25.0	24.5	24.5	24.5	17.4	7.5	5.2	26.9	13.0	10.7
LOS by Move:	C	C	C	C	C	C	C	B	A	A	C	B	B
HCM2k95thQ:	1	1	1	3	2	2	2	1	11	0	1	8	1

Note: Queue reported is the number of cars per lane.

BART Phase II Extension Project

Level Of Service Computation Report
2000 HCM Operations (Future Volume Alternative)
AM - Existing Plus Project Conditions

Intersection #3608: JULIAN/STOCKTON

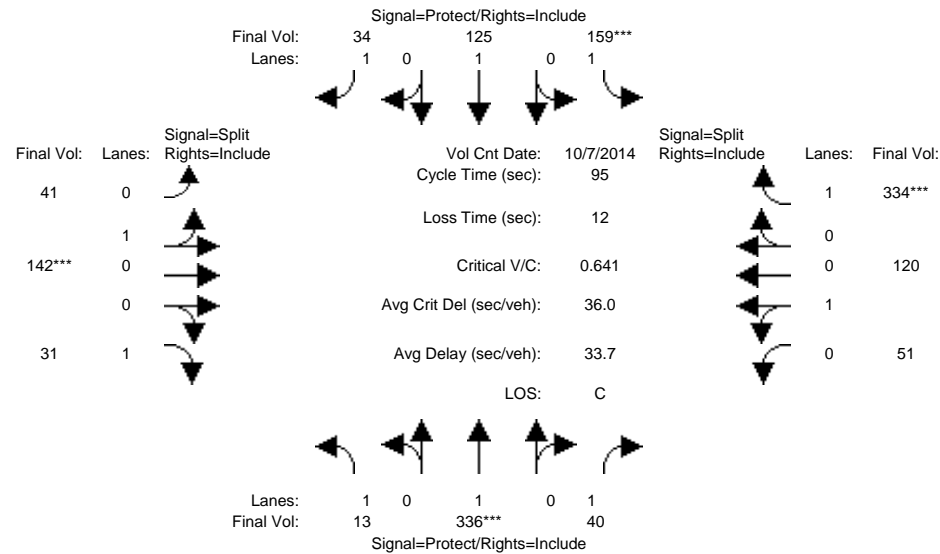

Approach:	North Bound			South Bound			East Bound			West Bound		
Movement:	L	T	R	L	T	R	L	T	R	L	T	R
Min. Green:	7	10	10	7	10	10	10	10	10	10	10	10
Y+R:	4.0	4.0	4.0	4.0	4.0	4.0	4.0	4.0	4.0	4.0	4.0	4.0
Volume Module: >> Count Date: 7 Oct 2014 <<												
Base Vol:	13	336	40	159	125	34	41	142	31	51	120	334
Growth Adj:	1.00	1.00	1.00	1.00	1.00	1.00	1.00	1.00	1.00	1.00	1.00	1.00
Initial Bse:	13	336	40	159	125	34	41	142	31	51	120	334
Added Vol:	0	0	0	0	0	0	0	0	0	0	0	0
PasserByVol:	0	0	0	0	0	0	0	0	0	0	0	0
Initial Fut:	13	336	40	159	125	34	41	142	31	51	120	334
User Adj:	1.00	1.00	1.00	1.00	1.00	1.00	1.00	1.00	1.00	1.00	1.00	1.00
PHF Adj:	1.00	1.00	1.00	1.00	1.00	1.00	1.00	1.00	1.00	1.00	1.00	1.00
PHF Volume:	13	336	40	159	125	34	41	142	31	51	120	334
Reduct Vol:	0	0	0	0	0	0	0	0	0	0	0	0
Reduced Vol:	13	336	40	159	125	34	41	142	31	51	120	334
PCE Adj:	1.00	1.00	1.00	1.00	1.00	1.00	1.00	1.00	1.00	1.00	1.00	1.00
MLF Adj:	1.00	1.00	1.00	1.00	1.00	1.00	1.00	1.00	1.00	1.00	1.00	1.00
FinalVolume:	13	336	40	159	125	34	41	142	31	51	120	334
Saturation Flow Module:												
Sat/Lane:	1900	1900	1900	1900	1900	1900	1900	1900	1900	1900	1900	1900
Adjustment:	0.92	1.00	0.92	0.92	1.00	0.92	0.95	0.95	0.92	0.95	0.95	0.92
Lanes:	1.00	1.00	1.00	1.00	1.00	1.00	0.22	0.78	1.00	0.30	0.70	1.00
Final Sat.:	1750	1900	1750	1750	1900	1750	403	1397	1750	537	1263	1750
Capacity Analysis Module:												
Vol/Sat:	0.01	0.18	0.02	0.09	0.07	0.02	0.10	0.10	0.02	0.10	0.10	0.19
Crit Moves:	****			****			****			****		
Green Time:	16.3	26.2	26.2	13.5	23.3	23.3	15.1	15.1	15.1	28.3	28.3	28.3
Volume/Cap:	0.04	0.64	0.08	0.64	0.27	0.08	0.64	0.64	0.11	0.32	0.32	0.64
Delay/Veh:	32.9	33.0	25.6	44.1	29.2	27.6	42.3	42.3	34.4	26.2	26.2	31.7
User DelAdj:	1.00	1.00	1.00	1.00	1.00	1.00	1.00	1.00	1.00	1.00	1.00	1.00
AdjDel/Veh:	32.9	33.0	25.6	44.1	29.2	27.6	42.3	42.3	34.4	26.2	26.2	31.7
LOS by Move:	C	C	C	D	C	C	D	D	C	C	C	C
HCM2k95thQ:	1	16	2	10	6	2	10	10	2	8	8	17

Note: Queue reported is the number of cars per lane.

BART Phase II Extension Project

Level Of Service Computation Report
 2000 HCM Operations (Future Volume Alternative)
 PM - Existing Plus Project Conditions

Intersection #3608: JULIAN/STOCKTON

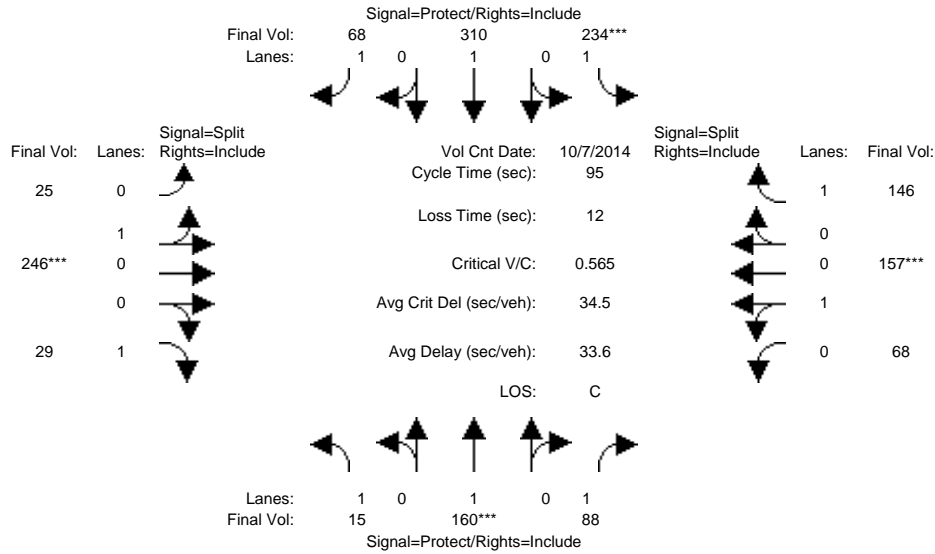

Approach:	North Bound			South Bound			East Bound			West Bound		
Movement:	L	T	R	L	T	R	L	T	R	L	T	R
Min. Green:	7	10	10	7	10	10	10	10	10	10	10	10
Y+R:	4.0	4.0	4.0	4.0	4.0	4.0	4.0	4.0	4.0	4.0	4.0	4.0
Volume Module: >> Count Date: 7 Oct 2014 <<												
Base Vol:	15	160	88	234	310	68	25	246	29	68	157	146
Growth Adj:	1.00	1.00	1.00	1.00	1.00	1.00	1.00	1.00	1.00	1.00	1.00	1.00
Initial Bse:	15	160	88	234	310	68	25	246	29	68	157	146
Added Vol:	0	0	0	0	0	0	0	0	0	0	0	0
PasserByVol:	0	0	0	0	0	0	0	0	0	0	0	0
Initial Fut:	15	160	88	234	310	68	25	246	29	68	157	146
User Adj:	1.00	1.00	1.00	1.00	1.00	1.00	1.00	1.00	1.00	1.00	1.00	1.00
PHF Adj:	1.00	1.00	1.00	1.00	1.00	1.00	1.00	1.00	1.00	1.00	1.00	1.00
PHF Volume:	15	160	88	234	310	68	25	246	29	68	157	146
Reduct Vol:	0	0	0	0	0	0	0	0	0	0	0	0
Reduced Vol:	15	160	88	234	310	68	25	246	29	68	157	146
PCE Adj:	1.00	1.00	1.00	1.00	1.00	1.00	1.00	1.00	1.00	1.00	1.00	1.00
MLF Adj:	1.00	1.00	1.00	1.00	1.00	1.00	1.00	1.00	1.00	1.00	1.00	1.00
FinalVolume:	15	160	88	234	310	68	25	246	29	68	157	146
Saturation Flow Module:												
Sat/Lane:	1900	1900	1900	1900	1900	1900	1900	1900	1900	1900	1900	1900
Adjustment:	0.92	1.00	0.92	0.92	1.00	0.92	0.95	0.95	0.92	0.95	0.95	0.92
Lanes:	1.00	1.00	1.00	1.00	1.00	1.00	0.09	0.91	1.00	0.30	0.70	1.00
Final Sat.:	1750	1900	1750	1750	1900	1750	166	1634	1750	544	1256	1750
Capacity Analysis Module:												
Vol/Sat:	0.01	0.08	0.05	0.13	0.16	0.04	0.15	0.15	0.02	0.13	0.13	0.08
Crit Moves:	****			****			****			****		
Green Time:	11.4	14.2	14.2	22.5	25.3	25.3	25.3	25.3	25.3	21.0	21.0	21.0
Volume/Cap:	0.07	0.56	0.34	0.56	0.61	0.15	0.56	0.56	0.06	0.56	0.56	0.38
Delay/Veh:	37.2	40.2	37.0	33.8	32.8	26.8	31.6	31.6	26.0	34.8	34.8	32.0
User DelAdj:	1.00	1.00	1.00	1.00	1.00	1.00	1.00	1.00	1.00	1.00	1.00	1.00
AdjDel/Veh:	37.2	40.2	37.0	33.8	32.8	26.8	31.6	31.6	26.0	34.8	34.8	32.0
LOS by Move:	D	D	D	C	C	C	C	C	C	C	C	C
HCM2k95thQ:	1	9	5	12	15	3	14	14	1	12	12	8

Note: Queue reported is the number of cars per lane.

BART Phase II Extension Project

Level Of Service Computation Report
 2000 HCM Operations (Future Volume Alternative)
 AM - Existing Plus Project Conditions

Intersection #3651: LINCOLN/PARKMOOR

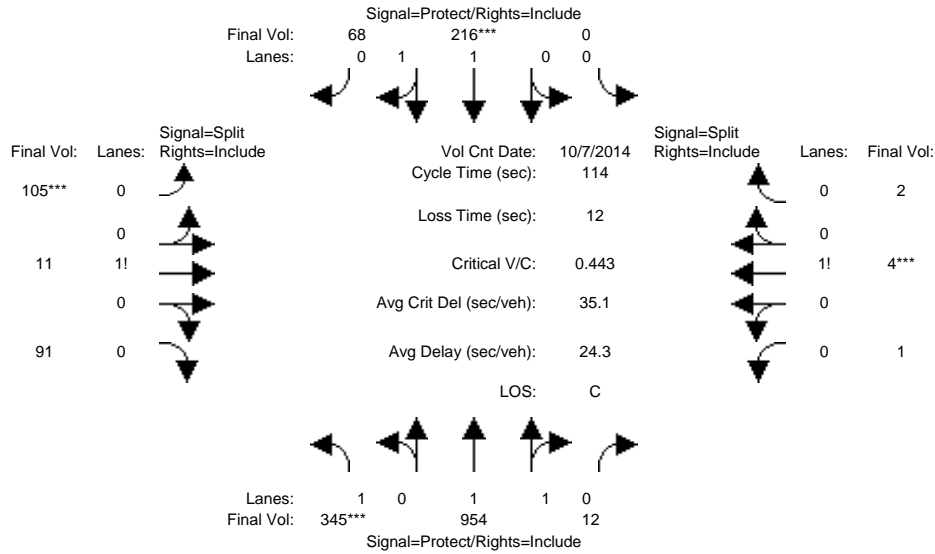

Approach:	North Bound			South Bound			East Bound			West Bound		
	L	T	R	L	T	R	L	T	R	L	T	R
Min. Green:	7	10	10	0	10	10	10	10	10	10	10	10
Y+R:	4.0	4.0	4.0	4.0	4.0	4.0	4.0	4.0	4.0	4.0	4.0	4.0
Volume Module: >> Count Date: 7 Oct 2014 <<												
Base Vol:	345	954	12	0	216	68	105	11	91	1	4	2
Growth Adj:	1.00	1.00	1.00	1.00	1.00	1.00	1.00	1.00	1.00	1.00	1.00	1.00
Initial Bse:	345	954	12	0	216	68	105	11	91	1	4	2
Added Vol:	0	0	0	0	0	0	0	0	0	0	0	0
PasserByVol:	0	0	0	0	0	0	0	0	0	0	0	0
Initial Fut:	345	954	12	0	216	68	105	11	91	1	4	2
User Adj:	1.00	1.00	1.00	1.00	1.00	1.00	1.00	1.00	1.00	1.00	1.00	1.00
PHF Adj:	1.00	1.00	1.00	1.00	1.00	1.00	1.00	1.00	1.00	1.00	1.00	1.00
PHF Volume:	345	954	12	0	216	68	105	11	91	1	4	2
Reduct Vol:	0	0	0	0	0	0	0	0	0	0	0	0
Reduced Vol:	345	954	12	0	216	68	105	11	91	1	4	2
PCE Adj:	1.00	1.00	1.00	1.00	1.00	1.00	1.00	1.00	1.00	1.00	1.00	1.00
MLF Adj:	1.00	1.00	1.00	1.00	1.00	1.00	1.00	1.00	1.00	1.00	1.00	1.00
FinalVolume:	345	954	12	0	216	68	105	11	91	1	4	2
Saturation Flow Module:												
Sat/Lane:	1900	1900	1900	1900	1900	1900	1900	1900	1900	1900	1900	1900
Adjustment:	0.92	0.97	0.95	0.92	0.98	0.95	0.92	0.92	0.92	0.92	0.92	0.92
Lanes:	1.00	1.97	0.03	0.00	1.51	0.49	0.51	0.05	0.44	0.14	0.57	0.29
Final Sat.:	1750	3654	46	0	2813	886	888	93	769	250	1000	500
Capacity Analysis Module:												
Vol/Sat:	0.20	0.26	0.26	0.00	0.08	0.08	0.12	0.12	0.12	0.00	0.00	0.00
Crit Moves:	****				****		****				****	
Green Time:	46.2	64.3	64.3	0.0	18.0	18.0	27.7	27.7	27.7	10.0	10.0	10.0
Volume/Cap:	0.49	0.46	0.46	0.00	0.49	0.49	0.49	0.49	0.49	0.05	0.05	0.05
Delay/Veh:	25.6	14.9	14.9	0.0	44.4	44.4	37.9	37.9	37.9	47.8	47.8	47.8
User DelAdj:	1.00	1.00	1.00	1.00	1.00	1.00	1.00	1.00	1.00	1.00	1.00	1.00
AdjDel/Veh:	25.6	14.9	14.9	0.0	44.4	44.4	37.9	37.9	37.9	47.8	47.8	47.8
LOS by Move:	C	B	B	A	D	D	D	D	D	D	D	D
HCM2k95thQ:	17	18	18	0	9	9	13	13	13	1	1	1

Note: Queue reported is the number of cars per lane.

BART Phase II Extension Project

Level Of Service Computation Report
 2000 HCM Operations (Future Volume Alternative)
 PM - Existing Plus Project Conditions

Intersection #3651: LINCOLN/PARKMOOR

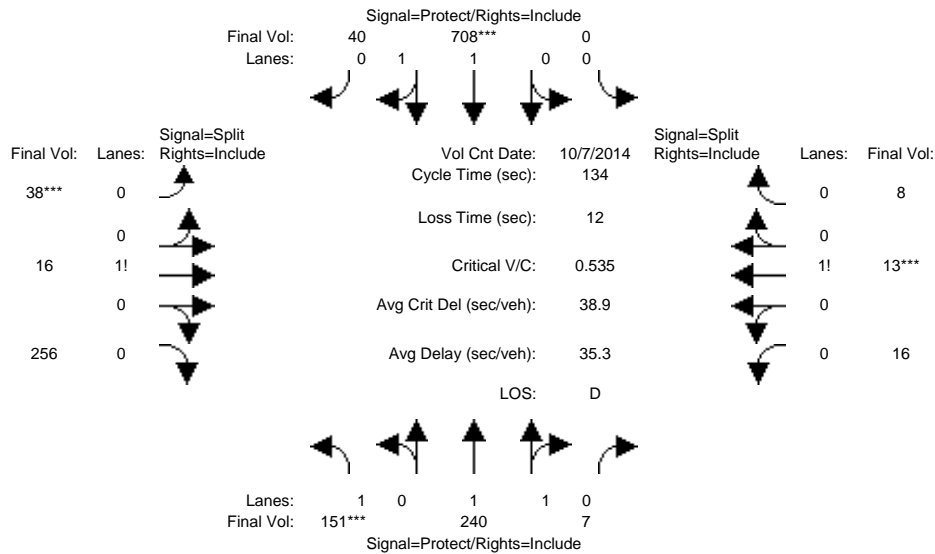

Approach:	North Bound			South Bound			East Bound			West Bound		
	L	T	R	L	T	R	L	T	R	L	T	R
Min. Green:	7	10	10	0	10	10	10	10	10	10	10	10
Y+R:	4.0	4.0	4.0	4.0	4.0	4.0	4.0	4.0	4.0	4.0	4.0	4.0
Volume Module: >> Count Date: 7 Oct 2014 <<												
Base Vol:	151	240	7	0	708	40	38	16	256	16	13	8
Growth Adj:	1.00	1.00	1.00	1.00	1.00	1.00	1.00	1.00	1.00	1.00	1.00	1.00
Initial Bse:	151	240	7	0	708	40	38	16	256	16	13	8
Added Vol:	0	0	0	0	0	0	0	0	0	0	0	0
PasserByVol:	0	0	0	0	0	0	0	0	0	0	0	0
Initial Fut:	151	240	7	0	708	40	38	16	256	16	13	8
User Adj:	1.00	1.00	1.00	1.00	1.00	1.00	1.00	1.00	1.00	1.00	1.00	1.00
PHF Adj:	1.00	1.00	1.00	1.00	1.00	1.00	1.00	1.00	1.00	1.00	1.00	1.00
PHF Volume:	151	240	7	0	708	40	38	16	256	16	13	8
Reduct Vol:	0	0	0	0	0	0	0	0	0	0	0	0
Reduced Vol:	151	240	7	0	708	40	38	16	256	16	13	8
PCE Adj:	1.00	1.00	1.00	1.00	1.00	1.00	1.00	1.00	1.00	1.00	1.00	1.00
MLF Adj:	1.00	1.00	1.00	1.00	1.00	1.00	1.00	1.00	1.00	1.00	1.00	1.00
FinalVolume:	151	240	7	0	708	40	38	16	256	16	13	8
Saturation Flow Module:												
Sat/Lane:	1900	1900	1900	1900	1900	1900	1900	1900	1900	1900	1900	1900
Adjustment:	0.92	0.97	0.95	0.92	0.98	0.95	0.92	0.92	0.92	0.92	0.92	0.92
Lanes:	1.00	1.94	0.06	0.00	1.89	0.11	0.12	0.05	0.83	0.43	0.35	0.22
Final Sat.:	1750	3595	105	0	3502	198	215	90	1445	757	615	378
Capacity Analysis Module:												
Vol/Sat:	0.09	0.07	0.07	0.00	0.20	0.20	0.18	0.18	0.18	0.02	0.02	0.02
Crit Moves:	****			****			****			****		
Green Time:	20.8	69.4	69.4	0.0	48.6	48.6	42.6	42.6	42.6	10.0	10.0	10.0
Volume/Cap:	0.56	0.13	0.13	0.00	0.56	0.56	0.56	0.56	0.56	0.28	0.28	0.28
Delay/Veh:	54.9	16.7	16.7	0.0	34.6	34.6	39.1	39.1	39.1	59.8	59.8	59.8
User DelAdj:	1.00	1.00	1.00	1.00	1.00	1.00	1.00	1.00	1.00	1.00	1.00	1.00
AdjDel/Veh:	54.9	16.7	16.7	0.0	34.6	34.6	39.1	39.1	39.1	59.8	59.8	59.8
LOS by Move:	D	B	B	A	C	C	D	D	D	E	E	E
HCM2k95thQ:	12	5	5	0	22	22	20	20	20	4	4	4

Note: Queue reported is the number of cars per lane.

BART Phase II Extension Project

Level Of Service Computation Report
 2000 HCM Operations (Future Volume Alternative)
 AM - Existing Plus Project Conditions

Intersection #3653: LINCOLN/SAN CARLOS

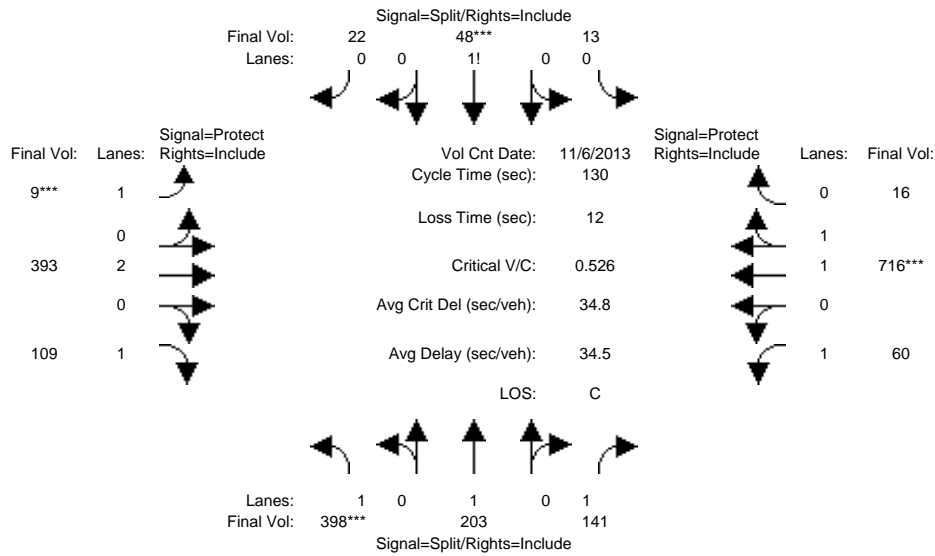

Approach:	North Bound			South Bound			East Bound			West Bound		
Movement:	L	T	R	L	T	R	L	T	R	L	T	R
Min. Green:	10	10	10	10	10	10	7	10	10	7	10	10
Y+R:	4.0	4.0	4.0	4.0	4.0	4.0	4.0	4.0	4.0	4.0	4.0	4.0

Volume Module:	>> Count Date: 6 Nov 2013 <<											
Base Vol:	398	203	141	13	48	22	9	393	109	60	716	16
Growth Adj:	1.00	1.00	1.00	1.00	1.00	1.00	1.00	1.00	1.00	1.00	1.00	1.00
Initial Bse:	398	203	141	13	48	22	9	393	109	60	716	16
Added Vol:	0	0	0	0	0	0	0	0	0	0	0	0
PasserByVol:	0	0	0	0	0	0	0	0	0	0	0	0
Initial Fut:	398	203	141	13	48	22	9	393	109	60	716	16
User Adj:	1.00	1.00	1.00	1.00	1.00	1.00	1.00	1.00	1.00	1.00	1.00	1.00
PHF Adj:	1.00	1.00	1.00	1.00	1.00	1.00	1.00	1.00	1.00	1.00	1.00	1.00
PHF Volume:	398	203	141	13	48	22	9	393	109	60	716	16
Reduct Vol:	0	0	0	0	0	0	0	0	0	0	0	0
Reduced Vol:	398	203	141	13	48	22	9	393	109	60	716	16
PCE Adj:	1.00	1.00	1.00	1.00	1.00	1.00	1.00	1.00	1.00	1.00	1.00	1.00
MLF Adj:	1.00	1.00	1.00	1.00	1.00	1.00	1.00	1.00	1.00	1.00	1.00	1.00
FinalVolume:	398	203	141	13	48	22	9	393	109	60	716	16

Saturation Flow Module:												
Sat/Lane:	1900	1900	1900	1900	1900	1900	1900	1900	1900	1900	1900	1900
Adjustment:	0.92	1.00	0.92	0.92	0.92	0.92	0.92	1.00	0.92	0.92	0.97	0.95
Lanes:	1.00	1.00	1.00	0.16	0.58	0.26	1.00	2.00	1.00	1.00	1.96	0.04
Final Sat.:	1750	1900	1750	274	1012	464	1750	3800	1750	1750	3619	81

Capacity Analysis Module:												
Vol/Sat:	0.23	0.11	0.08	0.05	0.05	0.05	0.01	0.10	0.06	0.03	0.20	0.20
Crit Moves:	****			****			****			****		
Green Time:	53.4	53.4	53.4	11.1	11.1	11.1	7.0	35.2	35.2	18.3	46.5	46.5
Volume/Cap:	0.55	0.26	0.20	0.55	0.55	0.55	0.10	0.38	0.23	0.24	0.55	0.55
Delay/Veh:	30.2	25.4	24.7	61.5	61.5	61.5	58.9	38.8	37.1	50.2	34.0	34.0
User DelAdj:	1.00	1.00	1.00	1.00	1.00	1.00	1.00	1.00	1.00	1.00	1.00	1.00
AdjDel/Veh:	30.2	25.4	24.7	61.5	61.5	61.5	58.9	38.8	37.1	50.2	34.0	34.0
LOS by Move:	C	C	C	E	E	E	E	D	D	D	C	C
HCM2k95thQ:	23	10	7	8	8	8	1	12	7	5	21	21

Note: Queue reported is the number of cars per lane.

BART Phase II Extension Project

Level Of Service Computation Report
 2000 HCM Operations (Future Volume Alternative)
 PM - Existing Plus Project Conditions

Intersection #3653: LINCOLN/SAN CARLOS

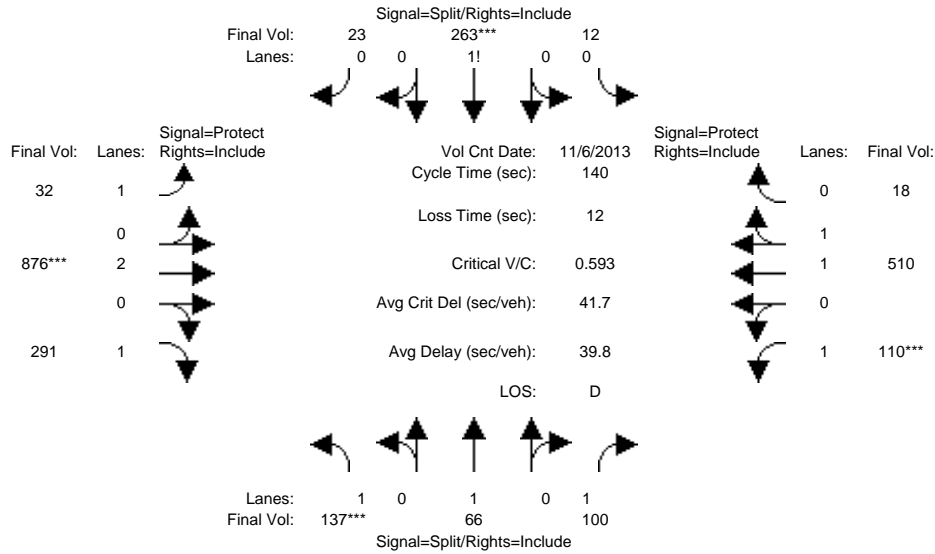

Approach:	North Bound			South Bound			East Bound			West Bound		
	L	T	R	L	T	R	L	T	R	L	T	R
Min. Green:	10	10	10	10	10	10	7	10	10	7	10	10
Y+R:	4.0	4.0	4.0	4.0	4.0	4.0	4.0	4.0	4.0	4.0	4.0	4.0

Volume Module:	>> Count Date: 6 Nov 2013 <<											
Base Vol:	137	66	100	12	263	23	32	876	291	110	510	18
Growth Adj:	1.00	1.00	1.00	1.00	1.00	1.00	1.00	1.00	1.00	1.00	1.00	1.00
Initial Bse:	137	66	100	12	263	23	32	876	291	110	510	18
Added Vol:	0	0	0	0	0	0	0	0	0	0	0	0
PasserByVol:	0	0	0	0	0	0	0	0	0	0	0	0
Initial Fut:	137	66	100	12	263	23	32	876	291	110	510	18
User Adj:	1.00	1.00	1.00	1.00	1.00	1.00	1.00	1.00	1.00	1.00	1.00	1.00
PHF Adj:	1.00	1.00	1.00	1.00	1.00	1.00	1.00	1.00	1.00	1.00	1.00	1.00
PHF Volume:	137	66	100	12	263	23	32	876	291	110	510	18
Reduct Vol:	0	0	0	0	0	0	0	0	0	0	0	0
Reduced Vol:	137	66	100	12	263	23	32	876	291	110	510	18
PCE Adj:	1.00	1.00	1.00	1.00	1.00	1.00	1.00	1.00	1.00	1.00	1.00	1.00
MLF Adj:	1.00	1.00	1.00	1.00	1.00	1.00	1.00	1.00	1.00	1.00	1.00	1.00
FinalVolume:	137	66	100	12	263	23	32	876	291	110	510	18

Saturation Flow Module:												
Sat/Lane:	1900	1900	1900	1900	1900	1900	1900	1900	1900	1900	1900	1900
Adjustment:	0.92	1.00	0.92	0.92	0.92	0.92	0.92	1.00	0.92	0.92	0.97	0.95
Lanes:	1.00	1.00	1.00	0.04	0.88	0.08	1.00	2.00	1.00	1.00	1.93	0.07
Final Sat.:	1750	1900	1750	70	1544	135	1750	3800	1750	1750	3574	126

Capacity Analysis Module:												
Vol/Sat:	0.08	0.03	0.06	0.17	0.17	0.17	0.02	0.23	0.17	0.06	0.14	0.14
Crit Moves:	****			****			****			****		
Green Time:	18.5	18.5	18.5	40.2	40.2	40.2	18.0	54.4	54.4	14.8	51.3	51.3
Volume/Cap:	0.59	0.26	0.43	0.59	0.59	0.59	0.14	0.59	0.43	0.59	0.39	0.39
Delay/Veh:	61.3	55.2	57.2	44.8	44.8	44.8	54.5	34.6	31.8	64.8	33.0	33.0
User DelAdj:	1.00	1.00	1.00	1.00	1.00	1.00	1.00	1.00	1.00	1.00	1.00	1.00
AdjDel/Veh:	61.3	55.2	57.2	44.8	44.8	44.8	54.5	34.6	31.8	64.8	33.0	33.0
LOS by Move:	E	E	E	D	D	D	D	C	C	E	C	C
HCM2k95thQ:	12	5	8	22	22	22	3	26	18	10	16	16

Note: Queue reported is the number of cars per lane.

BART Phase II Extension Project

Level Of Service Computation Report
2000 HCM Operations (Future Volume Alternative)
AM - Existing Plus Project Conditions

Intersection #3690: MERIDIAN/PARKMOOR

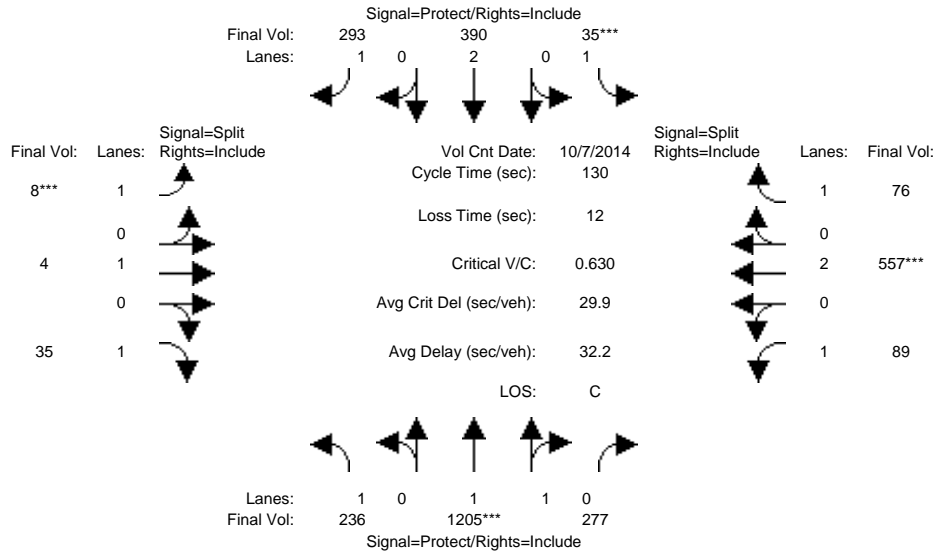

Approach:	North Bound			South Bound			East Bound			West Bound		
	L	T	R	L	T	R	L	T	R	L	T	R
Min. Green:	7	10	10	7	10	10	10	10	10	10	10	10
Y+R:	4.0	4.0	4.0	4.0	4.0	4.0	4.0	4.0	4.0	4.0	4.0	4.0
Volume Module: >> Count Date: 7 Oct 2014 <<												
Base Vol:	236	1205	277	35	390	293	8	4	35	89	557	76
Growth Adj:	1.00	1.00	1.00	1.00	1.00	1.00	1.00	1.00	1.00	1.00	1.00	1.00
Initial Bse:	236	1205	277	35	390	293	8	4	35	89	557	76
Added Vol:	0	0	0	0	0	0	0	0	0	0	0	0
PasserByVol:	0	0	0	0	0	0	0	0	0	0	0	0
Initial Fut:	236	1205	277	35	390	293	8	4	35	89	557	76
User Adj:	1.00	1.00	1.00	1.00	1.00	1.00	1.00	1.00	1.00	1.00	1.00	1.00
PHF Adj:	1.00	1.00	1.00	1.00	1.00	1.00	1.00	1.00	1.00	1.00	1.00	1.00
PHF Volume:	236	1205	277	35	390	293	8	4	35	89	557	76
Reduct Vol:	0	0	0	0	0	0	0	0	0	0	0	0
Reduced Vol:	236	1205	277	35	390	293	8	4	35	89	557	76
PCE Adj:	1.00	1.00	1.00	1.00	1.00	1.00	1.00	1.00	1.00	1.00	1.00	1.00
MLF Adj:	1.00	1.00	1.00	1.00	1.00	1.00	1.00	1.00	1.00	1.00	1.00	1.00
FinalVolume:	236	1205	277	35	390	293	8	4	35	89	557	76
Saturation Flow Module:												
Sat/Lane:	1900	1900	1900	1900	1900	1900	1900	1900	1900	1900	1900	1900
Adjustment:	0.92	0.98	0.95	0.92	1.00	0.92	0.92	1.00	0.92	0.92	1.00	0.92
Lanes:	1.00	1.62	0.38	1.00	2.00	1.00	1.00	1.00	1.00	1.00	2.00	1.00
Final Sat.:	1750	3008	691	1750	3800	1750	1750	1900	1750	1750	3800	1750
Capacity Analysis Module:												
Vol/Sat:	0.13	0.40	0.40	0.02	0.10	0.17	0.00	0.00	0.02	0.05	0.15	0.04
Crit Moves:	****			****			****			****		
Green Time:	36.1	73.9	73.9	7.0	44.8	44.8	10.0	10.0	10.0	27.1	27.1	27.1
Volume/Cap:	0.49	0.70	0.70	0.37	0.30	0.49	0.06	0.03	0.26	0.24	0.70	0.21
Delay/Veh:	40.0	21.3	21.3	61.8	31.2	34.1	55.8	55.6	57.5	43.3	50.7	42.9
User DelAdj:	1.00	1.00	1.00	1.00	1.00	1.00	1.00	1.00	1.00	1.00	1.00	1.00
AdjDel/Veh:	40.0	21.3	21.3	61.8	31.2	34.1	55.8	55.6	57.5	43.3	50.7	42.9
LOS by Move:	D	C	C	E	C	C	E	E	E	D	D	D
HCM2k95thQ:	16	37	37	3	11	18	1	0	3	6	19	5

Note: Queue reported is the number of cars per lane.

BART Phase II Extension Project

Level Of Service Computation Report
 2000 HCM Operations (Future Volume Alternative)
 PM - Existing Plus Project Conditions

Intersection #3690: MERIDIAN/PARKMOOR

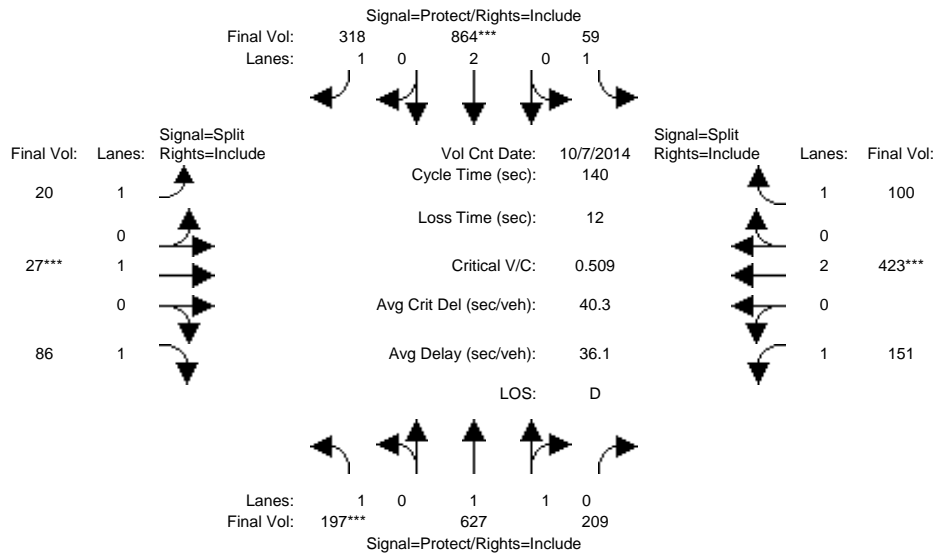

Approach:	North Bound			South Bound			East Bound			West Bound		
	L	T	R	L	T	R	L	T	R	L	T	R
Min. Green:	7	10	10	7	10	10	10	10	10	10	10	10
Y+R:	4.0	4.0	4.0	4.0	4.0	4.0	4.0	4.0	4.0	4.0	4.0	4.0

Volume Module:	>> Count Date: 7 Oct 2014 <<											
Base Vol:	197	627	209	59	864	318	20	27	86	151	423	100
Growth Adj:	1.00	1.00	1.00	1.00	1.00	1.00	1.00	1.00	1.00	1.00	1.00	1.00
Initial Bse:	197	627	209	59	864	318	20	27	86	151	423	100
Added Vol:	0	0	0	0	0	0	0	0	0	0	0	0
PasserByVol:	0	0	0	0	0	0	0	0	0	0	0	0
Initial Fut:	197	627	209	59	864	318	20	27	86	151	423	100
User Adj:	1.00	1.00	1.00	1.00	1.00	1.00	1.00	1.00	1.00	1.00	1.00	1.00
PHF Adj:	1.00	1.00	1.00	1.00	1.00	1.00	1.00	1.00	1.00	1.00	1.00	1.00
PHF Volume:	197	627	209	59	864	318	20	27	86	151	423	100
Reduct Vol:	0	0	0	0	0	0	0	0	0	0	0	0
Reduced Vol:	197	627	209	59	864	318	20	27	86	151	423	100
PCE Adj:	1.00	1.00	1.00	1.00	1.00	1.00	1.00	1.00	1.00	1.00	1.00	1.00
MLF Adj:	1.00	1.00	1.00	1.00	1.00	1.00	1.00	1.00	1.00	1.00	1.00	1.00
FinalVolume:	197	627	209	59	864	318	20	27	86	151	423	100

Saturation Flow Module:												
Sat/Lane:	1900	1900	1900	1900	1900	1900	1900	1900	1900	1900	1900	1900
Adjustment:	0.92	0.98	0.95	0.92	1.00	0.92	0.92	1.00	0.92	0.92	1.00	0.92
Lanes:	1.00	1.49	0.51	1.00	2.00	1.00	1.00	1.00	1.00	1.00	2.00	1.00
Final Sat.:	1750	2774	925	1750	3800	1750	1750	1900	1750	1750	3800	1750

Capacity Analysis Module:												
Vol/Sat:	0.11	0.23	0.23	0.03	0.23	0.18	0.01	0.01	0.05	0.09	0.11	0.06
Crit Moves:	****				****			****			****	
Green Time:	28.6	70.6	70.6	15.6	57.7	57.7	13.5	13.5	13.5	28.2	28.2	28.2
Volume/Cap:	0.55	0.45	0.45	0.30	0.55	0.44	0.12	0.15	0.51	0.43	0.55	0.28
Delay/Veh:	51.8	22.4	22.4	58.1	31.7	30.0	58.1	58.3	62.7	49.7	51.1	47.8
User DelAdj:	1.00	1.00	1.00	1.00	1.00	1.00	1.00	1.00	1.00	1.00	1.00	1.00
AdjDel/Veh:	51.8	22.4	22.4	58.1	31.7	30.0	58.1	58.3	62.7	49.7	51.1	47.8
LOS by Move:	D	C	C	E	C	C	E	E	E	D	D	D
HCM2k95thQ:	16	21	21	5	24	19	2	2	8	11	15	7

Note: Queue reported is the number of cars per lane.

BART Phase II Extension Project

Level Of Service Computation Report
 2000 HCM Operations (Future Volume Alternative)
 AM - Existing Plus Project Conditions

Intersection #3693: MERIDIAN/SAN CARLOS

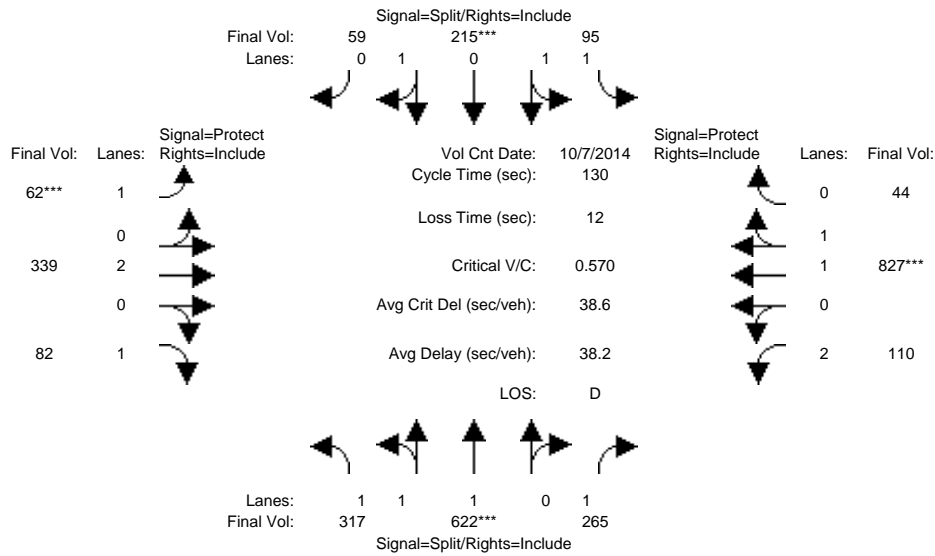

Approach:	North Bound			South Bound			East Bound			West Bound		
	L	T	R	L	T	R	L	T	R	L	T	R
Min. Green:	10	10	10	10	10	10	7	10	10	7	10	10
Y+R:	4.0	4.0	4.0	4.0	4.0	4.0	4.0	4.0	4.0	4.0	4.0	4.0

Volume Module:	>> Count Date: 7 Oct 2014 <<											
Base Vol:	317	622	265	95	215	59	62	339	82	110	827	44
Growth Adj:	1.00	1.00	1.00	1.00	1.00	1.00	1.00	1.00	1.00	1.00	1.00	1.00
Initial Bse:	317	622	265	95	215	59	62	339	82	110	827	44
Added Vol:	0	0	0	0	0	0	0	0	0	0	0	0
PasserByVol:	0	0	0	0	0	0	0	0	0	0	0	0
Initial Fut:	317	622	265	95	215	59	62	339	82	110	827	44
User Adj:	1.00	1.00	1.00	1.00	1.00	1.00	1.00	1.00	1.00	1.00	1.00	1.00
PHF Adj:	1.00	1.00	1.00	1.00	1.00	1.00	1.00	1.00	1.00	1.00	1.00	1.00
PHF Volume:	317	622	265	95	215	59	62	339	82	110	827	44
Reduct Vol:	0	0	0	0	0	0	0	0	0	0	0	0
Reduced Vol:	317	622	265	95	215	59	62	339	82	110	827	44
PCE Adj:	1.00	1.00	1.00	1.00	1.00	1.00	1.00	1.00	1.00	1.00	1.00	1.00
MLF Adj:	1.00	1.00	1.00	1.00	1.00	1.00	1.00	1.00	1.00	1.00	1.00	1.00
FinalVolume:	317	622	265	95	215	59	62	339	82	110	827	44

Saturation Flow Module:												
Sat/Lane:	1900	1900	1900	1900	1900	1900	1900	1900	1900	1900	1900	1900
Adjustment:	0.92	0.97	0.92	0.92	0.98	0.95	0.92	1.00	0.92	0.83	0.98	0.95
Lanes:	1.05	1.95	1.00	1.00	1.56	0.44	1.00	2.00	1.00	2.00	1.90	0.10
Final Sat.:	1839	3608	1750	1750	2903	797	1750	3800	1750	3150	3513	187

Capacity Analysis Module:												
Vol/Sat:	0.17	0.17	0.15	0.05	0.07	0.07	0.04	0.09	0.05	0.03	0.24	0.24
Crit Moves:	****	****	****	****	****	****	****	****	****	****	****	****
Green Time:	39.3	39.3	39.3	16.9	16.9	16.9	8.1	38.5	38.5	23.3	53.7	53.7
Volume/Cap:	0.57	0.57	0.50	0.42	0.57	0.57	0.57	0.30	0.16	0.20	0.57	0.57
Delay/Veh:	38.7	38.7	38.0	52.3	54.4	54.4	66.3	35.5	33.9	45.6	29.8	29.8
User DelAdj:	1.00	1.00	1.00	1.00	1.00	1.00	1.00	1.00	1.00	1.00	1.00	1.00
AdjDel/Veh:	38.7	38.7	38.0	52.3	54.4	54.4	66.3	35.5	33.9	45.6	29.8	29.8
LOS by Move:	D	D	D	D	D	D	E	D	C	D	C	C
HCM2k95thQ:	20	20	17	7	10	10	5	10	5	4	24	24

Note: Queue reported is the number of cars per lane.

BART Phase II Extension Project

Level Of Service Computation Report
 2000 HCM Operations (Future Volume Alternative)
 PM - Existing Plus Project Conditions

Intersection #3693: MERIDIAN/SAN CARLOS

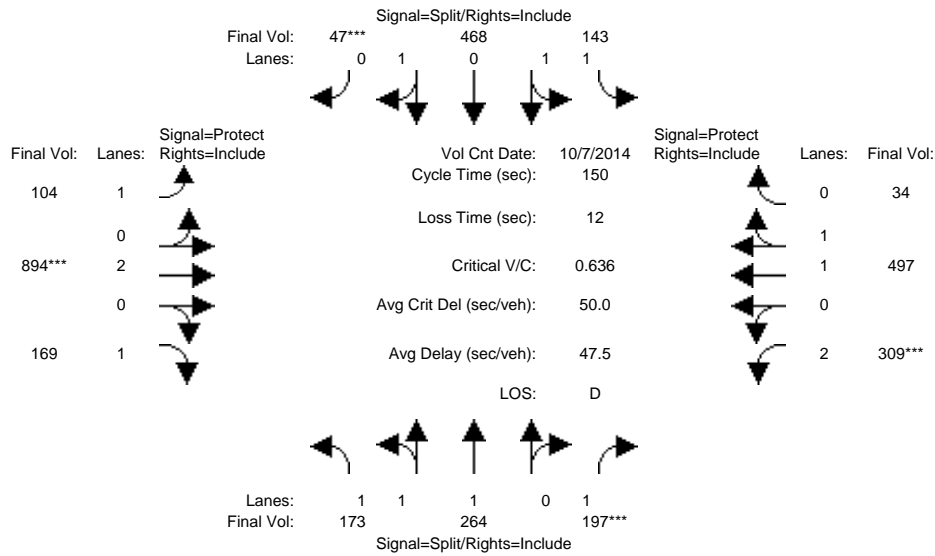

Approach:	North Bound			South Bound			East Bound			West Bound		
	L	T	R	L	T	R	L	T	R	L	T	R
Min. Green:	10	10	10	10	10	10	7	10	10	7	10	10
Y+R:	4.0	4.0	4.0	4.0	4.0	4.0	4.0	4.0	4.0	4.0	4.0	4.0
Volume Module: >> Count Date: 7 Oct 2014 <<												
Base Vol:	173	264	197	143	468	47	104	894	169	309	497	34
Growth Adj:	1.00	1.00	1.00	1.00	1.00	1.00	1.00	1.00	1.00	1.00	1.00	1.00
Initial Bse:	173	264	197	143	468	47	104	894	169	309	497	34
Added Vol:	0	0	0	0	0	0	0	0	0	0	0	0
PasserByVol:	0	0	0	0	0	0	0	0	0	0	0	0
Initial Fut:	173	264	197	143	468	47	104	894	169	309	497	34
User Adj:	1.00	1.00	1.00	1.00	1.00	1.00	1.00	1.00	1.00	1.00	1.00	1.00
PHF Adj:	1.00	1.00	1.00	1.00	1.00	1.00	1.00	1.00	1.00	1.00	1.00	1.00
PHF Volume:	173	264	197	143	468	47	104	894	169	309	497	34
Reduct Vol:	0	0	0	0	0	0	0	0	0	0	0	0
Reduced Vol:	173	264	197	143	468	47	104	894	169	309	497	34
PCE Adj:	1.00	1.00	1.00	1.00	1.00	1.00	1.00	1.00	1.00	1.00	1.00	1.00
MLF Adj:	1.00	1.00	1.00	1.00	1.00	1.00	1.00	1.00	1.00	1.00	1.00	1.00
FinalVolume:	173	264	197	143	468	47	104	894	169	309	497	34
Saturation Flow Module:												
Sat/Lane:	1900	1900	1900	1900	1900	1900	1900	1900	1900	1900	1900	1900
Adjustment:	0.93	0.98	0.92	0.92	0.98	0.95	0.92	1.00	0.92	0.83	0.98	0.95
Lanes:	1.23	1.77	1.00	1.00	1.81	0.19	1.00	2.00	1.00	2.00	1.87	0.13
Final Sat.:	2156	3290	1750	1750	3362	338	1750	3800	1750	3150	3463	237
Capacity Analysis Module:												
Vol/Sat:	0.08	0.08	0.11	0.08	0.14	0.14	0.06	0.24	0.10	0.10	0.14	0.14
Crit Moves:			****			****		****			****	
Green Time:	26.5	26.5	26.5	32.8	32.8	32.8	23.0	55.5	55.5	23.1	55.6	55.6
Volume/Cap:	0.45	0.45	0.64	0.37	0.64	0.64	0.39	0.64	0.26	0.64	0.39	0.39
Delay/Veh:	55.6	55.6	61.6	50.0	54.5	54.5	58.1	39.9	33.2	62.3	34.9	34.9
User DelAdj:	1.00	1.00	1.00	1.00	1.00	1.00	1.00	1.00	1.00	1.00	1.00	1.00
AdjDel/Veh:	55.6	55.6	61.6	50.0	54.5	54.5	58.1	39.9	33.2	62.3	34.9	34.9
LOS by Move:	E	E	E	D	D	D	E	D	C	E	C	C
HCM2k95thQ:	12	12	17	11	20	20	9	29	11	15	16	16

Note: Queue reported is the number of cars per lane.

BART Phase II Extension Project

Level Of Service Computation Report
2000 HCM Operations (Future Volume Alternative)
AM - Existing Plus Project Conditions

Intersection #3709: MONTGOMERY/PARK

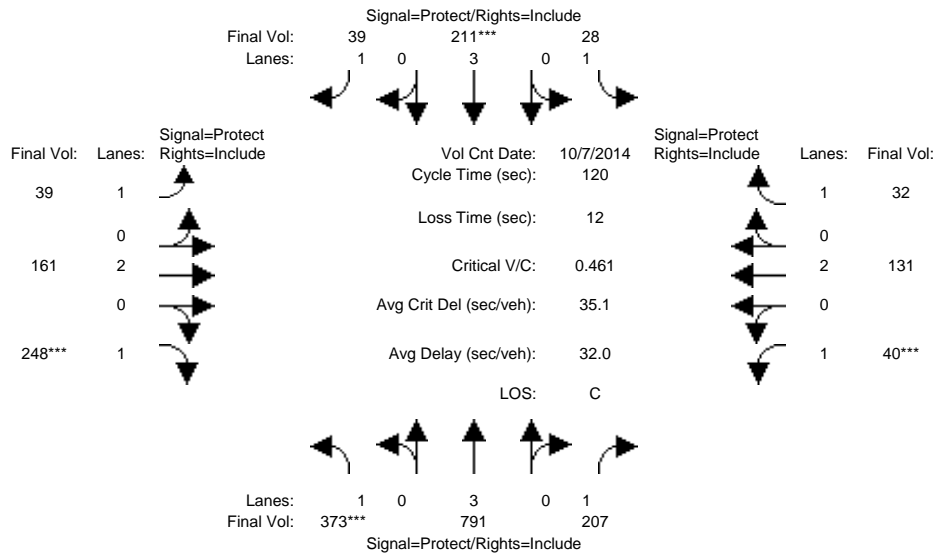

Approach:	North Bound			South Bound			East Bound			West Bound		
Movement:	L	T	R	L	T	R	L	T	R	L	T	R
Min. Green:	7	10	10	7	10	10	7	10	10	7	10	10
Y+R:	4.0	4.0	4.0	4.0	4.0	4.0	4.0	4.0	4.0	4.0	4.0	4.0
Volume Module: >> Count Date: 7 Oct 2014 <<												
Base Vol:	373	791	207	28	211	39	39	161	248	40	131	32
Growth Adj:	1.00	1.00	1.00	1.00	1.00	1.00	1.00	1.00	1.00	1.00	1.00	1.00
Initial Bse:	373	791	207	28	211	39	39	161	248	40	131	32
Added Vol:	0	0	0	0	0	0	0	0	0	0	0	0
PasserByVol:	0	0	0	0	0	0	0	0	0	0	0	0
Initial Fut:	373	791	207	28	211	39	39	161	248	40	131	32
User Adj:	1.00	1.00	1.00	1.00	1.00	1.00	1.00	1.00	1.00	1.00	1.00	1.00
PHF Adj:	1.00	1.00	1.00	1.00	1.00	1.00	1.00	1.00	1.00	1.00	1.00	1.00
PHF Volume:	373	791	207	28	211	39	39	161	248	40	131	32
Reduct Vol:	0	0	0	0	0	0	0	0	0	0	0	0
Reduced Vol:	373	791	207	28	211	39	39	161	248	40	131	32
PCE Adj:	1.00	1.00	1.00	1.00	1.00	1.00	1.00	1.00	1.00	1.00	1.00	1.00
MLF Adj:	1.00	1.00	1.00	1.00	1.00	1.00	1.00	1.00	1.00	1.00	1.00	1.00
FinalVolume:	373	791	207	28	211	39	39	161	248	40	131	32
Saturation Flow Module:												
Sat/Lane:	1900	1900	1900	1900	1900	1900	1900	1900	1900	1900	1900	1900
Adjustment:	0.92	1.00	0.92	0.92	1.00	0.92	0.92	1.00	0.92	0.92	1.00	0.92
Lanes:	1.00	3.00	1.00	1.00	3.00	1.00	1.00	2.00	1.00	1.00	2.00	1.00
Final Sat.:	1750	5700	1750	1750	5700	1750	1750	3800	1750	1750	3800	1750
Capacity Analysis Module:												
Vol/Sat:	0.21	0.14	0.12	0.02	0.04	0.02	0.02	0.04	0.14	0.02	0.03	0.02
Crit Moves:	****				****				****	****		
Green Time:	54.7	45.5	45.5	19.1	10.0	10.0	17.8	36.3	36.3	7.0	25.5	25.5
Volume/Cap:	0.47	0.37	0.31	0.10	0.44	0.27	0.15	0.14	0.47	0.39	0.16	0.09
Delay/Veh:	23.0	26.9	26.5	43.2	53.0	52.6	44.7	30.5	34.6	56.9	38.6	38.0
User DelAdj:	1.00	1.00	1.00	1.00	1.00	1.00	1.00	1.00	1.00	1.00	1.00	1.00
AdjDel/Veh:	23.0	26.9	26.5	43.2	53.0	52.6	44.7	30.5	34.6	56.9	38.6	38.0
LOS by Move:	C	C	C	D	D	D	D	C	C	E	D	D
HCM2k95thQ:	18	13	11	2	6	3	3	4	15	3	4	2

Note: Queue reported is the number of cars per lane.

BART Phase II Extension Project

Level Of Service Computation Report
 2000 HCM Operations (Future Volume Alternative)
 PM - Existing Plus Project Conditions

Intersection #3709: MONTGOMERY/PARK

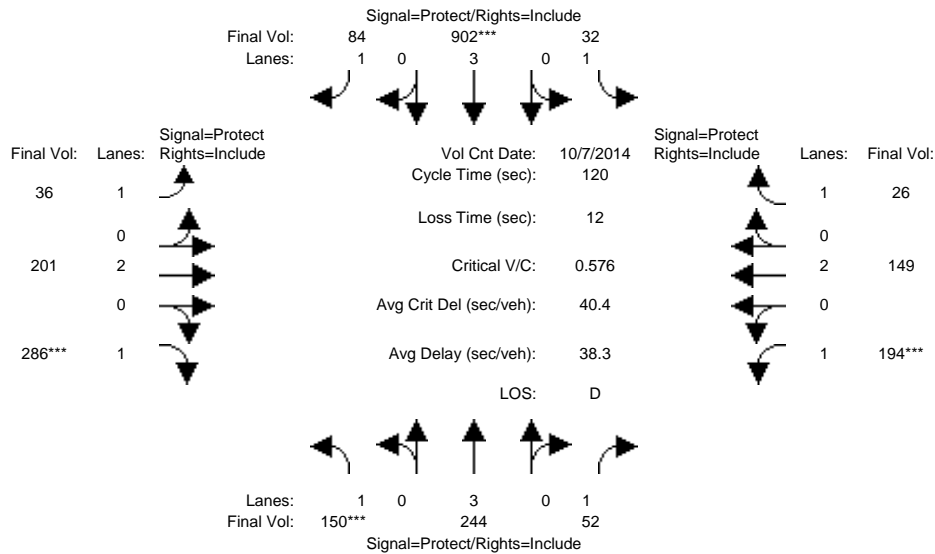

Approach:	North Bound			South Bound			East Bound			West Bound		
Movement:	L	T	R	L	T	R	L	T	R	L	T	R
Min. Green:	7	10	10	7	10	10	7	10	10	7	10	10
Y+R:	4.0	4.0	4.0	4.0	4.0	4.0	4.0	4.0	4.0	4.0	4.0	4.0
Volume Module: >> Count Date: 7 Oct 2014 <<												
Base Vol:	150	244	52	32	902	84	36	201	286	194	149	26
Growth Adj:	1.00	1.00	1.00	1.00	1.00	1.00	1.00	1.00	1.00	1.00	1.00	1.00
Initial Bse:	150	244	52	32	902	84	36	201	286	194	149	26
Added Vol:	0	0	0	0	0	0	0	0	0	0	0	0
PasserByVol:	0	0	0	0	0	0	0	0	0	0	0	0
Initial Fut:	150	244	52	32	902	84	36	201	286	194	149	26
User Adj:	1.00	1.00	1.00	1.00	1.00	1.00	1.00	1.00	1.00	1.00	1.00	1.00
PHF Adj:	1.00	1.00	1.00	1.00	1.00	1.00	1.00	1.00	1.00	1.00	1.00	1.00
PHF Volume:	150	244	52	32	902	84	36	201	286	194	149	26
Reduct Vol:	0	0	0	0	0	0	0	0	0	0	0	0
Reduced Vol:	150	244	52	32	902	84	36	201	286	194	149	26
PCE Adj:	1.00	1.00	1.00	1.00	1.00	1.00	1.00	1.00	1.00	1.00	1.00	1.00
MLF Adj:	1.00	1.00	1.00	1.00	1.00	1.00	1.00	1.00	1.00	1.00	1.00	1.00
FinalVolume:	150	244	52	32	902	84	36	201	286	194	149	26
Saturation Flow Module:												
Sat/Lane:	1900	1900	1900	1900	1900	1900	1900	1900	1900	1900	1900	1900
Adjustment:	0.92	1.00	0.92	0.92	1.00	0.92	0.92	1.00	0.92	0.92	1.00	0.92
Lanes:	1.00	3.00	1.00	1.00	3.00	1.00	1.00	2.00	1.00	1.00	2.00	1.00
Final Sat.:	1750	5700	1750	1750	5700	1750	1750	3800	1750	1750	3800	1750
Capacity Analysis Module:												
Vol/Sat:	0.09	0.04	0.03	0.02	0.16	0.05	0.02	0.05	0.16	0.11	0.04	0.01
Crit Moves:	****				****				****	****		
Green Time:	17.9	29.9	29.9	20.9	33.0	33.0	23.5	34.1	34.1	23.1	33.6	33.6
Volume/Cap:	0.58	0.17	0.12	0.10	0.58	0.17	0.10	0.19	0.58	0.58	0.14	0.05
Delay/Veh:	50.7	35.4	35.0	41.8	38.0	33.3	39.7	32.6	38.5	46.4	32.4	31.6
User DelAdj:	1.00	1.00	1.00	1.00	1.00	1.00	1.00	1.00	1.00	1.00	1.00	1.00
AdjDel/Veh:	50.7	35.4	35.0	41.8	38.0	33.3	39.7	32.6	38.5	46.4	32.4	31.6
LOS by Move:	D	D	C	D	D	C	D	C	D	D	C	C
HCM2k95thQ:	11	5	3	2	18	5	2	5	18	13	4	1

Note: Queue reported is the number of cars per lane.

BART Phase II Extension Project

Level Of Service Computation Report
 2000 HCM Operations (Future Volume Alternative)
 AM - Existing Plus Project Conditions

Intersection #3710: MONTGOMERY/SAN FERNANDO

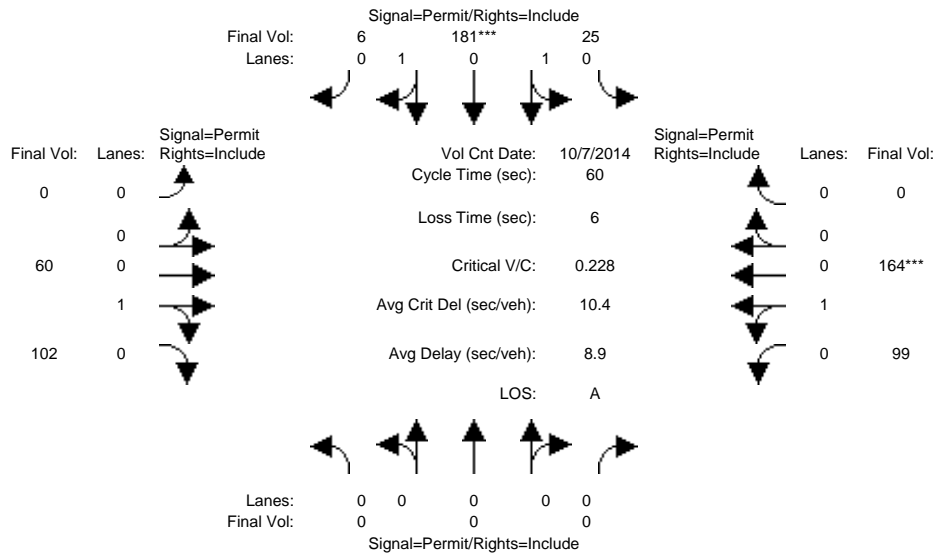

Approach:	North Bound			South Bound			East Bound			West Bound		
	L	T	R	L	T	R	L	T	R	L	T	R
Min. Green:	0	0	0	10	10	10	0	10	10	10	10	0
Y+R:	4.0	4.0	4.0	4.0	4.0	4.0	4.0	4.0	4.0	4.0	4.0	4.0
Volume Module: >> Count Date: 7 Oct 2014 <<												
Base Vol:	0	0	0	25	181	6	0	60	102	99	164	0
Growth Adj:	1.00	1.00	1.00	1.00	1.00	1.00	1.00	1.00	1.00	1.00	1.00	1.00
Initial Bse:	0	0	0	25	181	6	0	60	102	99	164	0
Added Vol:	0	0	0	0	0	0	0	0	0	0	0	0
PasserByVol:	0	0	0	0	0	0	0	0	0	0	0	0
Initial Fut:	0	0	0	25	181	6	0	60	102	99	164	0
User Adj:	1.00	1.00	1.00	1.00	1.00	1.00	1.00	1.00	1.00	1.00	1.00	1.00
PHF Adj:	1.00	1.00	1.00	1.00	1.00	1.00	1.00	1.00	1.00	1.00	1.00	1.00
PHF Volume:	0	0	0	25	181	6	0	60	102	99	164	0
Reduct Vol:	0	0	0	0	0	0	0	0	0	0	0	0
Reduced Vol:	0	0	0	25	181	6	0	60	102	99	164	0
PCE Adj:	1.00	1.00	1.00	1.00	1.00	1.00	1.00	1.00	1.00	1.00	1.00	1.00
MLF Adj:	1.00	1.00	1.00	1.00	1.00	1.00	1.00	1.00	1.00	1.00	1.00	1.00
FinalVolume:	0	0	0	25	181	6	0	60	102	99	164	0
Saturation Flow Module:												
Sat/Lane:	1900	1900	1900	1900	1900	1900	1900	1900	1900	1900	1900	1900
Adjustment:	0.92	1.00	0.92	0.95	0.95	0.95	0.92	0.95	0.95	0.95	0.95	0.92
Lanes:	0.00	0.00	0.00	0.23	1.71	0.06	0.00	0.37	0.63	0.38	0.62	0.00
Final Sat.:	0	0	0	425	3074	102	0	667	1133	678	1122	0
Capacity Analysis Module:												
Vol/Sat:	0.00	0.00	0.00	0.06	0.06	0.06	0.00	0.09	0.09	0.15	0.15	0.00
Crit Moves:	****											
Green Time:	0.0	0.0	0.0	15.5	15.5	15.5	0.0	38.5	38.5	38.5	38.5	0.0
Volume/Cap:	0.00	0.00	0.00	0.23	0.23	0.23	0.00	0.14	0.14	0.23	0.23	0.00
Delay/Veh:	0.0	0.0	0.0	17.7	17.7	17.7	0.0	4.3	4.3	4.6	4.6	0.0
User DelAdj:	1.00	1.00	1.00	1.00	1.00	1.00	1.00	1.00	1.00	1.00	1.00	1.00
AdjDel/Veh:	0.0	0.0	0.0	17.7	17.7	17.7	0.0	4.3	4.3	4.6	4.6	0.0
LOS by Move:	A	A	A	B	B	B	A	A	A	A	A	A
HCM2k95thQ:	0	0	0	3	3	3	0	3	3	4	4	0

Note: Queue reported is the number of cars per lane.

BART Phase II Extension Project

Level Of Service Computation Report
 2000 HCM Operations (Future Volume Alternative)
 PM - Existing Plus Project Conditions

Intersection #3710: MONTGOMERY/SAN FERNANDO

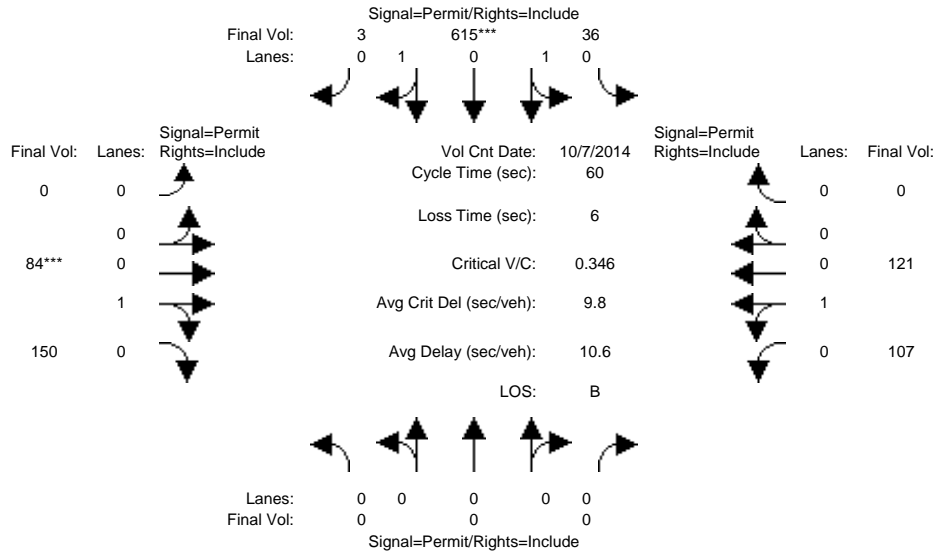

Approach:	North Bound			South Bound			East Bound			West Bound		
	L	T	R	L	T	R	L	T	R	L	T	R
Min. Green:	0	0	0	10	10	10	0	10	10	10	10	0
Y+R:	4.0	4.0	4.0	4.0	4.0	4.0	4.0	4.0	4.0	4.0	4.0	4.0
Volume Module: >> Count Date: 7 Oct 2014 <<												
Base Vol:	0	0	0	36	615	3	0	84	150	107	121	0
Growth Adj:	1.00	1.00	1.00	1.00	1.00	1.00	1.00	1.00	1.00	1.00	1.00	1.00
Initial Bse:	0	0	0	36	615	3	0	84	150	107	121	0
Added Vol:	0	0	0	0	0	0	0	0	0	0	0	0
PasserByVol:	0	0	0	0	0	0	0	0	0	0	0	0
Initial Fut:	0	0	0	36	615	3	0	84	150	107	121	0
User Adj:	1.00	1.00	1.00	1.00	1.00	1.00	1.00	1.00	1.00	1.00	1.00	1.00
PHF Adj:	1.00	1.00	1.00	1.00	1.00	1.00	1.00	1.00	1.00	1.00	1.00	1.00
PHF Volume:	0	0	0	36	615	3	0	84	150	107	121	0
Reduct Vol:	0	0	0	0	0	0	0	0	0	0	0	0
Reduced Vol:	0	0	0	36	615	3	0	84	150	107	121	0
PCE Adj:	1.00	1.00	1.00	1.00	1.00	1.00	1.00	1.00	1.00	1.00	1.00	1.00
MLF Adj:	1.00	1.00	1.00	1.00	1.00	1.00	1.00	1.00	1.00	1.00	1.00	1.00
FinalVolume:	0	0	0	36	615	3	0	84	150	107	121	0
Saturation Flow Module:												
Sat/Lane:	1900	1900	1900	1900	1900	1900	1900	1900	1900	1900	1900	1900
Adjustment:	0.92	1.00	0.92	0.95	0.95	0.95	0.92	0.95	0.95	0.95	0.95	0.92
Lanes:	0.00	0.00	0.00	0.11	1.88	0.01	0.00	0.36	0.64	0.47	0.53	0.00
Final Sat.:	0	0	0	198	3385	17	0	646	1154	845	955	0
Capacity Analysis Module:												
Vol/Sat:	0.00	0.00	0.00	0.18	0.18	0.18	0.00	0.13	0.13	0.13	0.13	0.00
Crit Moves:				****			****					
Green Time:	0.0	0.0	0.0	31.5	31.5	31.5	0.0	22.5	22.5	22.5	22.5	0.0
Volume/Cap:	0.00	0.00	0.00	0.35	0.35	0.35	0.00	0.35	0.35	0.34	0.34	0.00
Delay/Veh:	0.0	0.0	0.0	8.4	8.4	8.4	0.0	13.8	13.8	13.7	13.7	0.0
User DelAdj:	1.00	1.00	1.00	1.00	1.00	1.00	1.00	1.00	1.00	1.00	1.00	1.00
AdjDel/Veh:	0.0	0.0	0.0	8.4	8.4	8.4	0.0	13.8	13.8	13.7	13.7	0.0
LOS by Move:	A	A	A	A	A	A	A	B	B	B	B	A
HCM2k95thQ:	0	0	0	7	7	7	0	7	7	6	6	0

Note: Queue reported is the number of cars per lane.

BART Phase II Extension Project

Level Of Service Computation Report
 2000 HCM Operations (Future Volume Alternative)
 AM - Existing Plus Project Conditions

Intersection #3748: RACE/SAN CARLOS

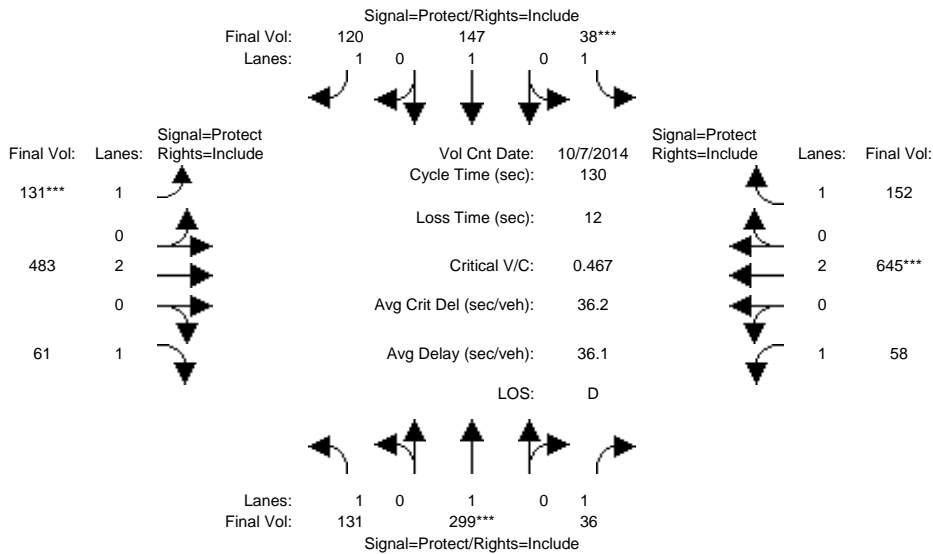

Approach:	North Bound			South Bound			East Bound			West Bound		
Movement:	L	T	R	L	T	R	L	T	R	L	T	R
Min. Green:	7	10	10	7	10	10	7	10	10	7	10	10
Y+R:	4.0	4.0	4.0	4.0	4.0	4.0	4.0	4.0	4.0	4.0	4.0	4.0
Volume Module: >> Count Date: 7 Oct 2014 <<												
Base Vol:	131	299	36	38	147	120	131	483	61	58	645	152
Growth Adj:	1.00	1.00	1.00	1.00	1.00	1.00	1.00	1.00	1.00	1.00	1.00	1.00
Initial Bse:	131	299	36	38	147	120	131	483	61	58	645	152
Added Vol:	0	0	0	0	0	0	0	0	0	0	0	0
PasserByVol:	0	0	0	0	0	0	0	0	0	0	0	0
Initial Fut:	131	299	36	38	147	120	131	483	61	58	645	152
User Adj:	1.00	1.00	1.00	1.00	1.00	1.00	1.00	1.00	1.00	1.00	1.00	1.00
PHF Adj:	1.00	1.00	1.00	1.00	1.00	1.00	1.00	1.00	1.00	1.00	1.00	1.00
PHF Volume:	131	299	36	38	147	120	131	483	61	58	645	152
Reduct Vol:	0	0	0	0	0	0	0	0	0	0	0	0
Reduced Vol:	131	299	36	38	147	120	131	483	61	58	645	152
PCE Adj:	1.00	1.00	1.00	1.00	1.00	1.00	1.00	1.00	1.00	1.00	1.00	1.00
MLF Adj:	1.00	1.00	1.00	1.00	1.00	1.00	1.00	1.00	1.00	1.00	1.00	1.00
Final Volume:	131	299	36	38	147	120	131	483	61	58	645	152
Saturation Flow Module:												
Sat/Lane:	1900	1900	1900	1900	1900	1900	1900	1900	1900	1900	1900	1900
Adjustment:	0.92	1.00	0.92	0.92	1.00	0.92	0.92	1.00	0.92	0.92	1.00	0.92
Lanes:	1.00	1.00	1.00	1.00	1.00	1.00	1.00	2.00	1.00	1.00	2.00	1.00
Final Sat.:	1750	1900	1750	1750	1900	1750	1750	3800	1750	1750	3800	1750
Capacity Analysis Module:												
Vol/Sat:	0.07	0.16	0.02	0.02	0.08	0.07	0.07	0.13	0.03	0.03	0.17	0.09
Crit Moves:	****			****			****			****		
Green Time:	24.8	43.5	43.5	7.0	25.6	25.6	20.7	47.4	47.4	20.1	46.9	46.9
Volume/Cap:	0.39	0.47	0.06	0.40	0.39	0.35	0.47	0.35	0.10	0.21	0.47	0.24
Delay/Veh:	46.8	34.7	29.5	62.3	46.1	45.6	51.0	30.2	27.2	48.4	32.3	29.3
User DelAdj:	1.00	1.00	1.00	1.00	1.00	1.00	1.00	1.00	1.00	1.00	1.00	1.00
AdjDel/Veh:	46.8	34.7	29.5	62.3	46.1	45.6	51.0	30.2	27.2	48.4	32.3	29.3
LOS by Move:	D	C	C	E	D	D	D	C	C	D	C	C
HCM2k95thQ:	9	17	2	3	10	8	10	13	3	4	18	9

Note: Queue reported is the number of cars per lane.

BART Phase II Extension Project

Level Of Service Computation Report
 2000 HCM Operations (Future Volume Alternative)
 PM - Existing Plus Project Conditions

Intersection #3748: RACE/SAN CARLOS

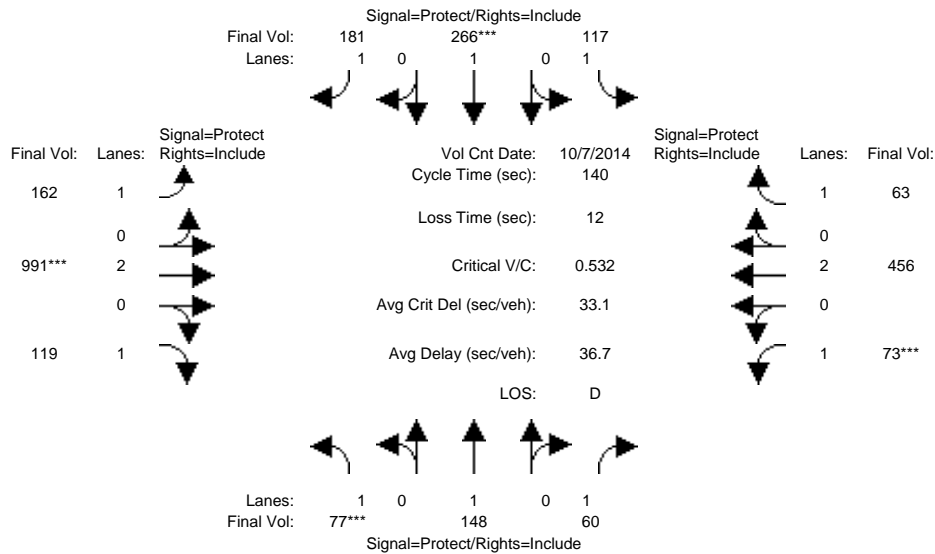

Approach:	North Bound			South Bound			East Bound			West Bound		
	L	T	R	L	T	R	L	T	R	L	T	R
Min. Green:	7	10	10	7	10	10	7	10	10	7	10	10
Y+R:	4.0	4.0	4.0	4.0	4.0	4.0	4.0	4.0	4.0	4.0	4.0	4.0
Volume Module: >> Count Date: 7 Oct 2014 <<												
Base Vol:	77	148	60	117	266	181	162	991	119	73	456	63
Growth Adj:	1.00	1.00	1.00	1.00	1.00	1.00	1.00	1.00	1.00	1.00	1.00	1.00
Initial Bse:	77	148	60	117	266	181	162	991	119	73	456	63
Added Vol:	0	0	0	0	0	0	0	0	0	0	0	0
PasserByVol:	0	0	0	0	0	0	0	0	0	0	0	0
Initial Fut:	77	148	60	117	266	181	162	991	119	73	456	63
User Adj:	1.00	1.00	1.00	1.00	1.00	1.00	1.00	1.00	1.00	1.00	1.00	1.00
PHF Adj:	1.00	1.00	1.00	1.00	1.00	1.00	1.00	1.00	1.00	1.00	1.00	1.00
PHF Volume:	77	148	60	117	266	181	162	991	119	73	456	63
Reduct Vol:	0	0	0	0	0	0	0	0	0	0	0	0
Reduced Vol:	77	148	60	117	266	181	162	991	119	73	456	63
PCE Adj:	1.00	1.00	1.00	1.00	1.00	1.00	1.00	1.00	1.00	1.00	1.00	1.00
MLF Adj:	1.00	1.00	1.00	1.00	1.00	1.00	1.00	1.00	1.00	1.00	1.00	1.00
FinalVolume:	77	148	60	117	266	181	162	991	119	73	456	63
Saturation Flow Module:												
Sat/Lane:	1900	1900	1900	1900	1900	1900	1900	1900	1900	1900	1900	1900
Adjustment:	0.92	1.00	0.92	0.92	1.00	0.92	0.92	1.00	0.92	0.92	1.00	0.92
Lanes:	1.00	1.00	1.00	1.00	1.00	1.00	1.00	2.00	1.00	1.00	2.00	1.00
Final Sat.:	1750	1900	1750	1750	1900	1750	1750	3800	1750	1750	3800	1750
Capacity Analysis Module:												
Vol/Sat:	0.04	0.08	0.03	0.07	0.14	0.10	0.09	0.26	0.07	0.04	0.12	0.04
Crit Moves:	****			****			****			****		
Green Time:	11.6	26.1	26.1	22.4	36.8	36.8	34.7	68.6	68.6	11.0	44.9	44.9
Volume/Cap:	0.53	0.42	0.18	0.42	0.53	0.39	0.37	0.53	0.14	0.53	0.37	0.11
Delay/Veh:	65.4	51.1	48.3	54.0	45.3	43.0	44.2	24.9	19.6	66.0	36.9	33.6
User DelAdj:	1.00	1.00	1.00	1.00	1.00	1.00	1.00	1.00	1.00	1.00	1.00	1.00
AdjDel/Veh:	65.4	51.1	48.3	54.0	45.3	43.0	44.2	24.9	19.6	66.0	36.9	33.6
LOS by Move:	E	D	D	D	D	D	D	C	B	E	D	C
HCM2k95thQ:	7	11	5	9	18	13	12	25	6	7	14	4

Note: Queue reported is the number of cars per lane.

BART Phase II Extension Project

Level Of Service Computation Report
 2000 HCM Operations (Future Volume Alternative)
 AM - Existing Plus Project Conditions

Intersection #3985: DELMAS/SAN FERNANDO

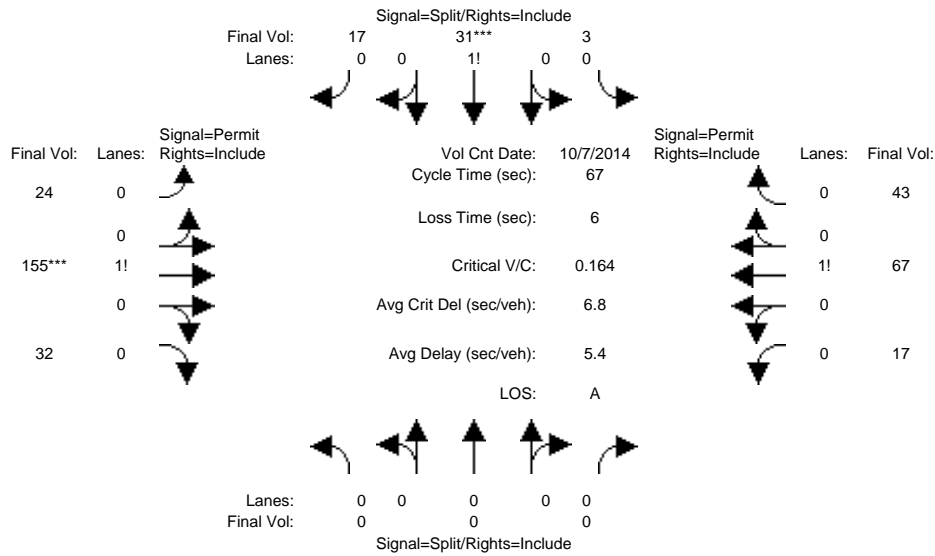

Approach:	North Bound			South Bound			East Bound			West Bound		
	L	T	R	L	T	R	L	T	R	L	T	R
Min. Green:	0	0	0	10	10	10	10	10	10	10	10	10
Y+R:	4.0	4.0	4.0	4.0	4.0	4.0	4.0	4.0	4.0	4.0	4.0	4.0
Volume Module: >> Count Date: 7 Oct 2014 <<												
Base Vol:	0	0	0	3	31	17	24	155	32	17	67	43
Growth Adj:	1.00	1.00	1.00	1.00	1.00	1.00	1.00	1.00	1.00	1.00	1.00	1.00
Initial Bse:	0	0	0	3	31	17	24	155	32	17	67	43
Added Vol:	0	0	0	0	0	0	0	0	0	0	0	0
PasserByVol:	0	0	0	0	0	0	0	0	0	0	0	0
Initial Fut:	0	0	0	3	31	17	24	155	32	17	67	43
User Adj:	1.00	1.00	1.00	1.00	1.00	1.00	1.00	1.00	1.00	1.00	1.00	1.00
PHF Adj:	1.00	1.00	1.00	1.00	1.00	1.00	1.00	1.00	1.00	1.00	1.00	1.00
PHF Volume:	0	0	0	3	31	17	24	155	32	17	67	43
Reduct Vol:	0	0	0	0	0	0	0	0	0	0	0	0
Reduced Vol:	0	0	0	3	31	17	24	155	32	17	67	43
PCE Adj:	1.00	1.00	1.00	1.00	1.00	1.00	1.00	1.00	1.00	1.00	1.00	1.00
MLF Adj:	1.00	1.00	1.00	1.00	1.00	1.00	1.00	1.00	1.00	1.00	1.00	1.00
FinalVolume:	0	0	0	3	31	17	24	155	32	17	67	43
Saturation Flow Module:												
Sat/Lane:	1900	1900	1900	1900	1900	1900	1900	1900	1900	1900	1900	1900
Adjustment:	0.92	1.00	0.92	0.92	0.92	0.92	0.92	0.92	0.92	0.92	0.92	0.92
Lanes:	0.00	0.00	0.00	0.06	0.61	0.33	0.11	0.74	0.15	0.13	0.53	0.34
Final Sat.:	0	0	0	103	1064	583	199	1286	265	234	923	593
Capacity Analysis Module:												
Vol/Sat:	0.00	0.00	0.00	0.03	0.03	0.03	0.12	0.12	0.12	0.07	0.07	0.07
Crit Moves:				****			****					
Green Time:	0.0	0.0	0.0	11.9	11.9	11.9	49.1	49.1	49.1	49.1	49.1	49.1
Volume/Cap:	0.00	0.00	0.00	0.16	0.16	0.16	0.16	0.16	0.16	0.10	0.10	0.10
Delay/Veh:	0.0	0.0	0.0	23.6	23.6	23.6	2.8	2.8	2.8	2.6	2.6	2.6
User DelAdj:	1.00	1.00	1.00	1.00	1.00	1.00	1.00	1.00	1.00	1.00	1.00	1.00
AdjDel/Veh:	0.0	0.0	0.0	23.6	23.6	23.6	2.8	2.8	2.8	2.6	2.6	2.6
LOS by Move:	A	A	A	C	C	C	A	A	A	A	A	A
HCM2k95thQ:	0	0	0	2	2	2	3	3	3	2	2	2

Note: Queue reported is the number of cars per lane.

BART Phase II Extension Project

Level Of Service Computation Report
 2000 HCM Operations (Future Volume Alternative)
 PM - Existing Plus Project Conditions

Intersection #3985: DELMAS/SAN FERNANDO

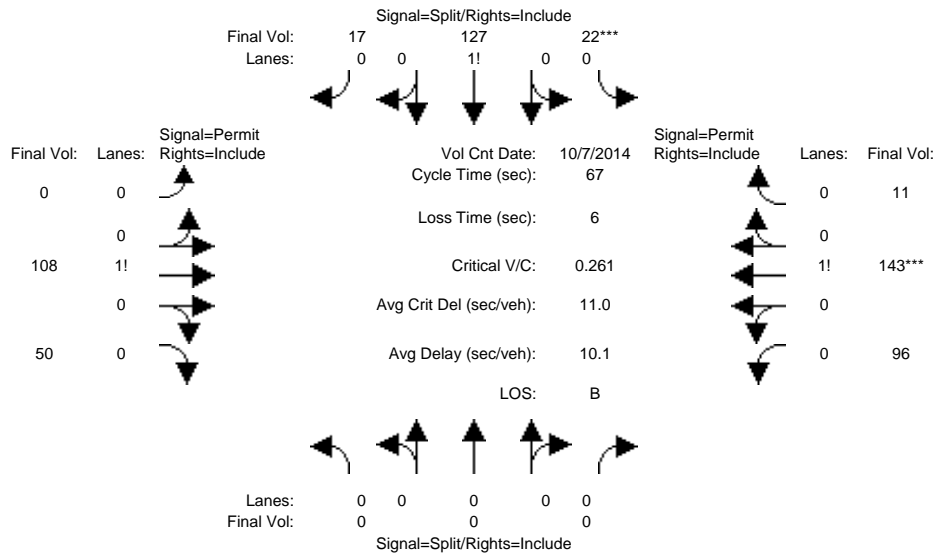

Approach:	North Bound			South Bound			East Bound			West Bound		
	L	T	R	L	T	R	L	T	R	L	T	R
Min. Green:	0	0	0	10	10	10	10	10	10	10	10	10
Y+R:	4.0	4.0	4.0	4.0	4.0	4.0	4.0	4.0	4.0	4.0	4.0	4.0
Volume Module: >> Count Date: 7 Oct 2014 <<												
Base Vol:	0	0	0	22	127	17	0	108	50	96	143	11
Growth Adj:	1.00	1.00	1.00	1.00	1.00	1.00	1.00	1.00	1.00	1.00	1.00	1.00
Initial Bse:	0	0	0	22	127	17	0	108	50	96	143	11
Added Vol:	0	0	0	0	0	0	0	0	0	0	0	0
PasserByVol:	0	0	0	0	0	0	0	0	0	0	0	0
Initial Fut:	0	0	0	22	127	17	0	108	50	96	143	11
User Adj:	1.00	1.00	1.00	1.00	1.00	1.00	1.00	1.00	1.00	1.00	1.00	1.00
PHF Adj:	1.00	1.00	1.00	1.00	1.00	1.00	1.00	1.00	1.00	1.00	1.00	1.00
PHF Volume:	0	0	0	22	127	17	0	108	50	96	143	11
Reduct Vol:	0	0	0	0	0	0	0	0	0	0	0	0
Reduced Vol:	0	0	0	22	127	17	0	108	50	96	143	11
PCE Adj:	1.00	1.00	1.00	1.00	1.00	1.00	1.00	1.00	1.00	1.00	1.00	1.00
MLF Adj:	1.00	1.00	1.00	1.00	1.00	1.00	1.00	1.00	1.00	1.00	1.00	1.00
FinalVolume:	0	0	0	22	127	17	0	108	50	96	143	11
Saturation Flow Module:												
Sat/Lane:	1900	1900	1900	1900	1900	1900	1900	1900	1900	1900	1900	1900
Adjustment:	0.92	1.00	0.92	0.92	0.92	0.92	0.92	0.95	0.95	0.92	0.92	0.92
Lanes:	0.00	0.00	0.00	0.13	0.77	0.10	0.00	0.68	0.32	0.38	0.58	0.04
Final Sat.:	0	0	0	232	1339	179	0	1230	570	672	1001	77
Capacity Analysis Module:												
Vol/Sat:	0.00	0.00	0.00	0.09	0.09	0.09	0.00	0.09	0.09	0.14	0.14	0.14
Crit Moves:	****											
Green Time:	0.0	0.0	0.0	24.3	24.3	24.3	0.0	36.7	36.7	36.7	36.7	36.7
Volume/Cap:	0.00	0.00	0.00	0.26	0.26	0.26	0.00	0.16	0.16	0.26	0.26	0.26
Delay/Veh:	0.0	0.0	0.0	15.2	15.2	15.2	0.0	7.6	7.6	8.2	8.2	8.2
User DelAdj:	1.00	1.00	1.00	1.00	1.00	1.00	1.00	1.00	1.00	1.00	1.00	1.00
AdjDel/Veh:	0.0	0.0	0.0	15.2	15.2	15.2	0.0	7.6	7.6	8.2	8.2	8.2
LOS by Move:	A	A	A	B	B	B	A	A	A	A	A	A
HCM2k95thQ:	0	0	0	5	5	5	0	3	3	6	6	6

Note: Queue reported is the number of cars per lane.

Level of Service Calculations

Santa Clara Station – Existing Plus Project

BART Phase II Extension Project

Level Of Service Computation Report
 2000 HCM Operations (Future Volume Alternative)
 AM - Existing Plus Project Conditions

Intersection #6: DE LA CRUZ/MARTIN

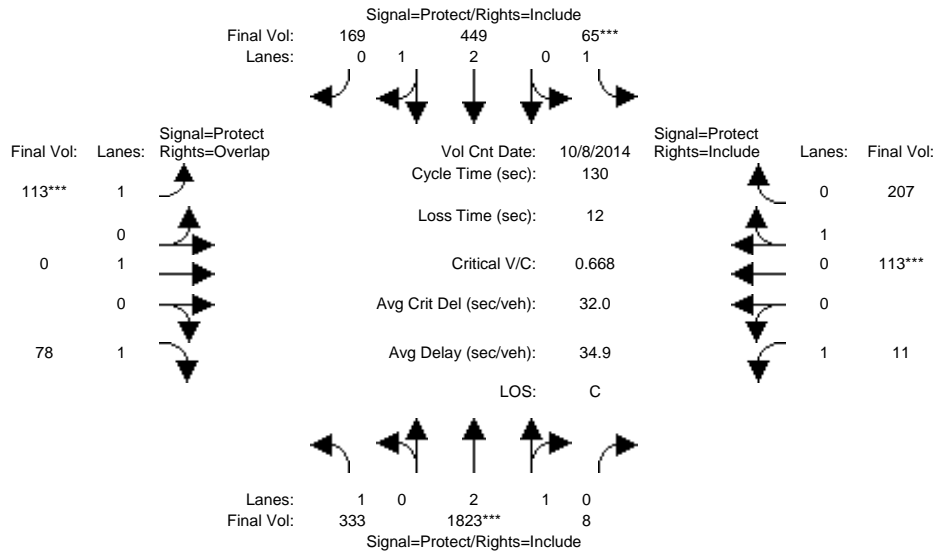

Approach:	North Bound			South Bound			East Bound			West Bound		
	L	T	R	L	T	R	L	T	R	L	T	R
Min. Green:	7	10	10	7	10	10	7	10	10	7	10	10
Y+R:	4.0	4.0	4.0	4.0	4.0	4.0	4.0	4.0	4.0	4.0	4.0	4.0

Volume Module:	>>	Count	Date:	8 Oct 2014	<<							
Base Vol:	333	1823	8	65	449	169	113	0	78	11	113	207
Growth Adj:	1.00	1.00	1.00	1.00	1.00	1.00	1.00	1.00	1.00	1.00	1.00	1.00
Initial Bse:	333	1823	8	65	449	169	113	0	78	11	113	207
Added Vol:	0	0	0	0	0	0	0	0	0	0	0	0
PasserByVol:	0	0	0	0	0	0	0	0	0	0	0	0
Initial Fut:	333	1823	8	65	449	169	113	0	78	11	113	207
User Adj:	1.00	1.00	1.00	1.00	1.00	1.00	1.00	1.00	1.00	1.00	1.00	1.00
PHF Adj:	1.00	1.00	1.00	1.00	1.00	1.00	1.00	1.00	1.00	1.00	1.00	1.00
PHF Volume:	333	1823	8	65	449	169	113	0	78	11	113	207
Reduct Vol:	0	0	0	0	0	0	0	0	0	0	0	0
Reduced Vol:	333	1823	8	65	449	169	113	0	78	11	113	207
PCE Adj:	1.00	1.00	1.00	1.00	1.00	1.00	1.00	1.00	1.00	1.00	1.00	1.00
MLF Adj:	1.00	1.00	1.00	1.00	1.00	1.00	1.00	1.00	1.00	1.00	1.00	1.00
Final Volume:	333	1823	8	65	449	169	113	0	78	11	113	207

Saturation Flow Module:	Sat/Lane:	1900	1900	1900	1900	1900	1900	1900	1900	1900	1900	1900
Adjustment:	0.92	0.98	0.95	0.92	1.00	0.95	0.92	1.00	0.92	0.92	0.95	0.95
Lanes:	1.00	2.99	0.01	1.00	2.15	0.85	1.00	1.00	1.00	1.00	0.35	0.65
Final Sat.:	1750	5575	24	1750	4067	1531	1750	1900	1750	1750	636	1164

Capacity Analysis Module:	Vol/Sat:	0.19	0.33	0.33	0.04	0.11	0.11	0.06	0.00	0.04	0.01	0.18	0.18
Crit Moves:	****	****	****	****	****	****	****	****	****	****	****	****	****
Green Time:	44.8	63.6	63.6	7.2	26.0	26.0	12.6	0.0	57.4	47.2	34.6	34.6	
Volume/Cap:	0.55	0.67	0.67	0.67	0.55	0.55	0.67	0.00	0.10	0.02	0.67	0.67	
Delay/Veh:	35.6	25.8	25.8	76.6	47.3	47.3	66.5	0.0	21.3	26.6	46.2	46.2	
User DelAdj:	1.00	1.00	1.00	1.00	1.00	1.00	1.00	1.00	1.00	1.00	1.00	1.00	
AdjDel/Veh:	35.6	25.8	25.8	76.6	47.3	47.3	66.5	0.0	21.3	26.6	46.2	46.2	
LOS by Move:	D	C	C	E	D	D	E	A	C	C	D	D	
HCM2k95thQ:	21	32	32	6	14	14	10	0	4	1	23	23	

Note: Queue reported is the number of cars per lane.

BART Phase II Extension Project

Level Of Service Computation Report
 2000 HCM Operations (Future Volume Alternative)
 PM - Existing Plus Project Conditions

Intersection #6: DE LA CRUZ/MARTIN

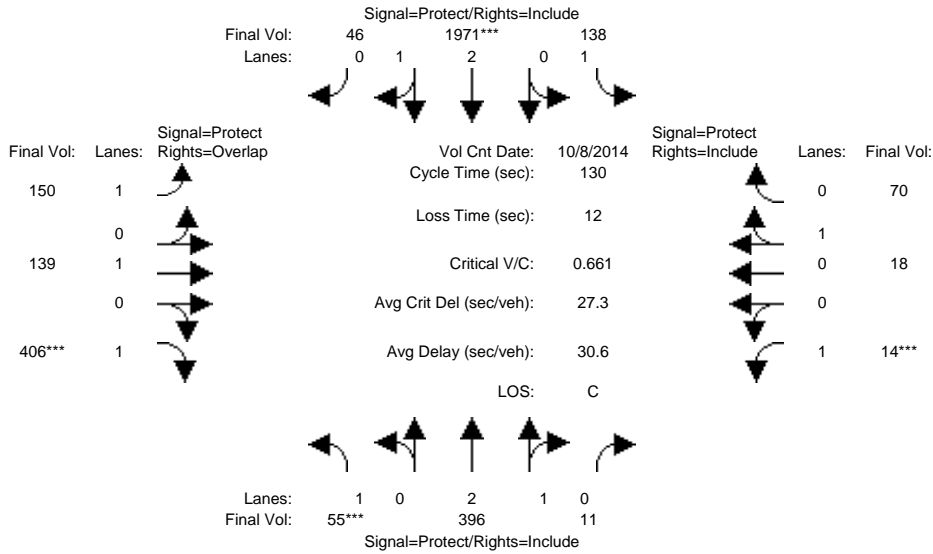

Approach:	North Bound			South Bound			East Bound			West Bound		
Movement:	L	T	R	L	T	R	L	T	R	L	T	R
Min. Green:	7	10	10	7	10	10	7	10	10	7	10	10
Y+R:	4.0	4.0	4.0	4.0	4.0	4.0	4.0	4.0	4.0	4.0	4.0	4.0
Volume Module: >> Count Date: 8 Oct 2014 <<												
Base Vol:	55	396	11	138	1971	46	150	139	406	14	18	70
Growth Adj:	1.00	1.00	1.00	1.00	1.00	1.00	1.00	1.00	1.00	1.00	1.00	1.00
Initial Bse:	55	396	11	138	1971	46	150	139	406	14	18	70
Added Vol:	0	0	0	0	0	0	0	0	0	0	0	0
PasserByVol:	0	0	0	0	0	0	0	0	0	0	0	0
Initial Fut:	55	396	11	138	1971	46	150	139	406	14	18	70
User Adj:	1.00	1.00	1.00	1.00	1.00	1.00	1.00	1.00	1.00	1.00	1.00	1.00
PHF Adj:	1.00	1.00	1.00	1.00	1.00	1.00	1.00	1.00	1.00	1.00	1.00	1.00
PHF Volume:	55	396	11	138	1971	46	150	139	406	14	18	70
Reduct Vol:	0	0	0	0	0	0	0	0	0	0	0	0
Reduced Vol:	55	396	11	138	1971	46	150	139	406	14	18	70
PCE Adj:	1.00	1.00	1.00	1.00	1.00	1.00	1.00	1.00	1.00	1.00	1.00	1.00
MLF Adj:	1.00	1.00	1.00	1.00	1.00	1.00	1.00	1.00	1.00	1.00	1.00	1.00
FinalVolume:	55	396	11	138	1971	46	150	139	406	14	18	70
Saturation Flow Module:												
Sat/Lane:	1900	1900	1900	1900	1900	1900	1900	1900	1900	1900	1900	1900
Adjustment:	0.92	0.98	0.95	0.92	0.98	0.95	0.92	1.00	0.92	0.92	0.95	0.95
Lanes:	1.00	2.92	0.08	1.00	2.93	0.07	1.00	1.00	1.00	1.00	0.20	0.80
Final Sat.:	1750	5448	151	1750	5472	128	1750	1900	1750	1750	368	1432
Capacity Analysis Module:												
Vol/Sat:	0.03	0.07	0.07	0.08	0.36	0.36	0.09	0.07	0.23	0.01	0.05	0.05
Crit Moves:	****			****			****		****	****		
Green Time:	7.0	37.8	37.8	38.8	69.6	69.6	21.8	34.4	41.4	7.0	19.6	19.6
Volume/Cap:	0.58	0.25	0.25	0.26	0.67	0.67	0.51	0.28	0.73	0.15	0.32	0.32
Delay/Veh:	69.1	35.3	35.3	35.0	22.6	22.6	50.7	38.2	44.1	59.4	50.0	50.0
User DelAdj:	1.00	1.00	1.00	1.00	1.00	1.00	1.00	1.00	1.00	1.00	1.00	1.00
AdjDel/Veh:	69.1	35.3	35.3	35.0	22.6	22.6	50.7	38.2	44.1	59.4	50.0	50.0
LOS by Move:	E	D	D	D	C	C	D	D	D	E	D	D
HCM2k95thQ:	5	8	8	9	33	33	11	8	27	1	7	7

Note: Queue reported is the number of cars per lane.

BART Phase II Extension Project

Level Of Service Computation Report
2000 HCM Operations (Future Volume Alternative)
AM - Existing Plus Project Conditions

Intersection #7: LAFAYETTE/REED

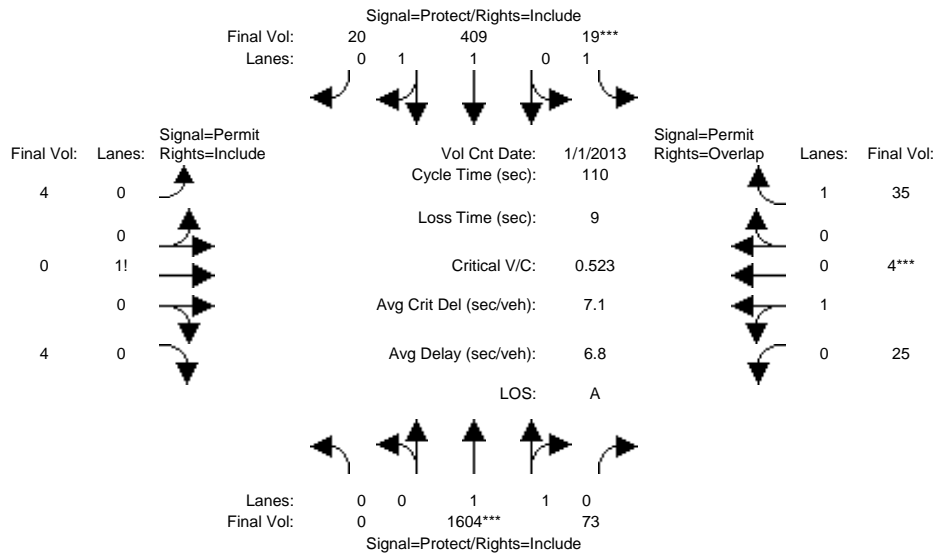

Approach:	North Bound			South Bound			East Bound			West Bound		
	L	T	R	L	T	R	L	T	R	L	T	R
Min. Green:	7	10	10	7	10	10	10	10	10	10	10	10
Y+R:	4.0	4.0	4.0	4.0	4.0	4.0	4.0	4.0	4.0	4.0	4.0	4.0

Volume Module:	>>	Count	Date:	1 Jan 2013	<<							
Base Vol:	0	1604	73	19	409	20	4	0	4	25	4	35
Growth Adj:	1.00	1.00	1.00	1.00	1.00	1.00	1.00	1.00	1.00	1.00	1.00	1.00
Initial Bse:	0	1604	73	19	409	20	4	0	4	25	4	35
Added Vol:	0	0	0	0	0	0	0	0	0	0	0	0
PasserByVol:	0	0	0	0	0	0	0	0	0	0	0	0
Initial Fut:	0	1604	73	19	409	20	4	0	4	25	4	35
User Adj:	1.00	1.00	1.00	1.00	1.00	1.00	1.00	1.00	1.00	1.00	1.00	1.00
PHF Adj:	1.00	1.00	1.00	1.00	1.00	1.00	1.00	1.00	1.00	1.00	1.00	1.00
PHF Volume:	0	1604	73	19	409	20	4	0	4	25	4	35
Reduct Vol:	0	0	0	0	0	0	0	0	0	0	0	0
Reduced Vol:	0	1604	73	19	409	20	4	0	4	25	4	35
PCE Adj:	1.00	1.00	1.00	1.00	1.00	1.00	1.00	1.00	1.00	1.00	1.00	1.00
MLF Adj:	1.00	1.00	1.00	1.00	1.00	1.00	1.00	1.00	1.00	1.00	1.00	1.00
FinalVolume:	0	1604	73	19	409	20	4	0	4	25	4	35

Saturation Flow Module:	Sat/Lane:	1900	1900	1900	1900	1900	1900	1900	1900	1900	1900	1900
Adjustment:	0.92	0.97	0.95	0.92	0.97	0.95	0.92	0.92	0.92	0.95	0.95	0.92
Lanes:	0.00	1.91	0.09	1.00	1.90	0.10	0.50	0.00	0.50	0.86	0.14	1.00
Final Sat.:	0	3539	161	1750	3527	172	875	0	875	1552	248	1750

Capacity Analysis Module:	Vol/Sat:	0.00	0.45	0.45	0.01	0.12	0.12	0.00	0.00	0.00	0.02	0.02	0.02
Crit Moves:	****	****	****	****	****	****	****	****	****	****	****	****	****
Green Time:	0.0	84.0	84.0	7.0	91.0	91.0	10.0	0.0	10.0	10.0	10.0	10.0	17.0
Volume/Cap:	0.00	0.59	0.59	0.17	0.14	0.14	0.05	0.00	0.05	0.18	0.18	0.13	0.13
Delay/Veh:	0.0	6.0	6.0	49.5	1.9	1.9	45.8	0.0	45.8	46.7	46.7	40.3	40.3
User DelAdj:	1.00	1.00	1.00	1.00	1.00	1.00	1.00	1.00	1.00	1.00	1.00	1.00	1.00
AdjDel/Veh:	0.0	6.0	6.0	49.5	1.9	1.9	45.8	0.0	45.8	46.7	46.7	40.3	40.3
LOS by Move:	A	A	A	D	A	A	D	A	D	D	D	D	D
HCM2k95thQ:	0	23	23	1	3	3	1	0	1	2	2	2	2

Note: Queue reported is the number of cars per lane.

BART Phase II Extension Project

Level Of Service Computation Report
 2000 HCM Operations (Future Volume Alternative)
 PM - Existing Plus Project Conditions

Intersection #7: LAFAYETTE/REED

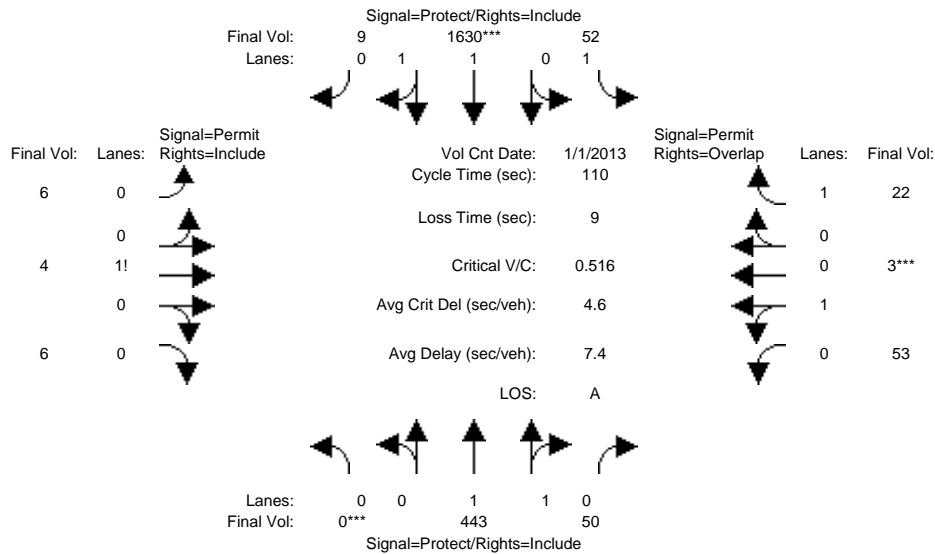

Approach:	North Bound			South Bound			East Bound			West Bound		
	L	T	R	L	T	R	L	T	R	L	T	R
Min. Green:	7	10	10	7	10	10	10	10	10	10	10	10
Y+R:	4.0	4.0	4.0	4.0	4.0	4.0	4.0	4.0	4.0	4.0	4.0	4.0

Volume Module:	>> Count Date: 1 Jan 2013 <<											
Base Vol:	0	443	50	52	1630	9	6	4	6	53	3	22
Growth Adj:	1.00	1.00	1.00	1.00	1.00	1.00	1.00	1.00	1.00	1.00	1.00	1.00
Initial Bse:	0	443	50	52	1630	9	6	4	6	53	3	22
Added Vol:	0	0	0	0	0	0	0	0	0	0	0	0
PasserByVol:	0	0	0	0	0	0	0	0	0	0	0	0
Initial Fut:	0	443	50	52	1630	9	6	4	6	53	3	22
User Adj:	1.00	1.00	1.00	1.00	1.00	1.00	1.00	1.00	1.00	1.00	1.00	1.00
PHF Adj:	1.00	1.00	1.00	1.00	1.00	1.00	1.00	1.00	1.00	1.00	1.00	1.00
PHF Volume:	0	443	50	52	1630	9	6	4	6	53	3	22
Reduct Vol:	0	0	0	0	0	0	0	0	0	0	0	0
Reduced Vol:	0	443	50	52	1630	9	6	4	6	53	3	22
PCE Adj:	1.00	1.00	1.00	1.00	1.00	1.00	1.00	1.00	1.00	1.00	1.00	1.00
MLF Adj:	1.00	1.00	1.00	1.00	1.00	1.00	1.00	1.00	1.00	1.00	1.00	1.00
FinalVolume:	0	443	50	52	1630	9	6	4	6	53	3	22

Saturation Flow Module:												
Sat/Lane:	1900	1900	1900	1900	1900	1900	1900	1900	1900	1900	1900	1900
Adjustment:	0.92	0.98	0.95	0.92	0.97	0.95	0.92	0.92	0.92	0.95	0.95	0.92
Lanes:	0.00	1.79	0.21	1.00	1.99	0.01	0.37	0.25	0.38	0.95	0.05	1.00
Final Sat.:	0	3324	375	1750	3680	20	656	438	656	1704	96	1750

Capacity Analysis Module:												
Vol/Sat:	0.00	0.13	0.13	0.03	0.44	0.44	0.01	0.01	0.01	0.03	0.03	0.01
Crit Moves:	****				****						****	
Green Time:	0.0	61.6	61.6	29.4	91.0	91.0	10.0	10.0	10.0	10.0	10.0	39.4
Volume/Cap:	0.00	0.24	0.24	0.11	0.54	0.54	0.10	0.10	0.10	0.34	0.34	0.04
Delay/Veh:	0.0	12.4	12.4	30.5	3.1	3.1	46.2	46.2	46.2	48.2	48.2	23.0
User DelAdj:	1.00	1.00	1.00	1.00	1.00	1.00	1.00	1.00	1.00	1.00	1.00	1.00
AdjDel/Veh:	0.0	12.4	12.4	30.5	3.1	3.1	46.2	46.2	46.2	48.2	48.2	23.0
LOS by Move:	A	B	B	C	A	A	D	D	D	D	D	C
HCM2k95thQ:	0	8	8	3	17	17	1	1	1	4	4	1

Note: Queue reported is the number of cars per lane.

BART Phase II Extension Project

Level Of Service Computation Report
 2000 HCM Operations (Future Volume Alternative)
 AM - Existing Plus Project Conditions

Intersection #9: Coleman/Brokaw

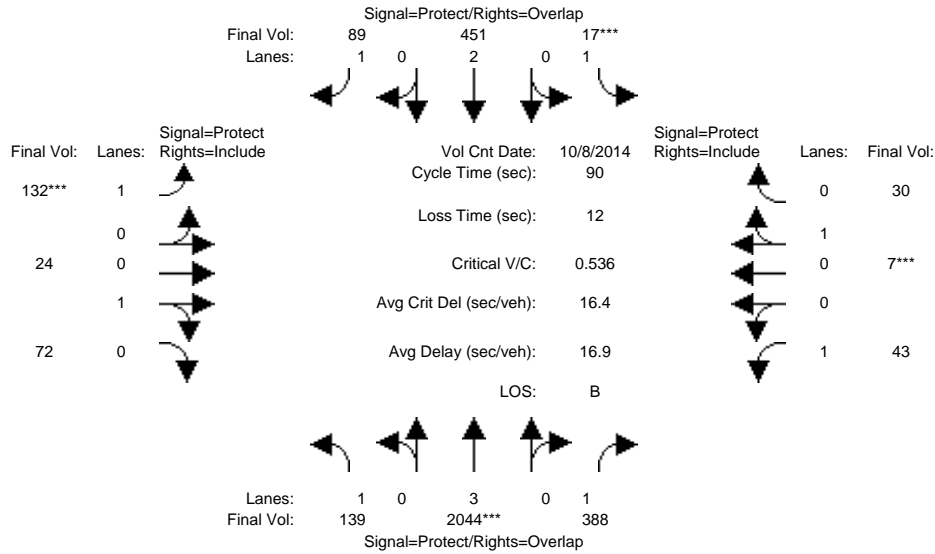

Approach:	North Bound			South Bound			East Bound			West Bound		
	L	T	R	L	T	R	L	T	R	L	T	R
Min. Green:	7	10	10	7	10	10	7	10	10	7	10	10
Y+R:	4.0	4.0	4.0	4.0	4.0	4.0	4.0	4.0	4.0	4.0	4.0	4.0
Volume Module: >> Count Date: 8 Oct 2014 <<												
Base Vol:	139	2044	388	17	451	89	132	24	72	43	7	30
Growth Adj:	1.00	1.00	1.00	1.00	1.00	1.00	1.00	1.00	1.00	1.00	1.00	1.00
Initial Bse:	139	2044	388	17	451	89	132	24	72	43	7	30
Added Vol:	0	0	0	0	0	0	0	0	0	0	0	0
PasserByVol:	0	0	0	0	0	0	0	0	0	0	0	0
Initial Fut:	139	2044	388	17	451	89	132	24	72	43	7	30
User Adj:	1.00	1.00	1.00	1.00	1.00	1.00	1.00	1.00	1.00	1.00	1.00	1.00
PHF Adj:	1.00	1.00	1.00	1.00	1.00	1.00	1.00	1.00	1.00	1.00	1.00	1.00
PHF Volume:	139	2044	388	17	451	89	132	24	72	43	7	30
Reduct Vol:	0	0	0	0	0	0	0	0	0	0	0	0
Reduced Vol:	139	2044	388	17	451	89	132	24	72	43	7	30
PCE Adj:	1.00	1.00	1.00	1.00	1.00	1.00	1.00	1.00	1.00	1.00	1.00	1.00
MLF Adj:	1.00	1.00	1.00	1.00	1.00	1.00	1.00	1.00	1.00	1.00	1.00	1.00
FinalVolume:	139	2044	388	17	451	89	132	24	72	43	7	30
Saturation Flow Module:												
Sat/Lane:	1900	1900	1900	1900	1900	1900	1900	1900	1900	1900	1900	1900
Adjustment:	0.92	1.00	0.92	0.92	1.00	0.92	0.92	0.95	0.95	0.92	0.95	0.95
Lanes:	1.00	3.00	1.00	1.00	2.00	1.00	1.00	0.25	0.75	1.00	0.19	0.81
Final Sat.:	1750	5700	1750	1750	3800	1750	1750	450	1350	1750	341	1459
Capacity Analysis Module:												
Vol/Sat:	0.08	0.36	0.22	0.01	0.12	0.05	0.08	0.05	0.05	0.02	0.02	0.02
Crit Moves:	****			****			****			****		
Green Time:	23.0	50.4	58.9	7.0	34.4	45.0	10.6	12.1	12.1	8.5	10.0	10.0
Volume/Cap:	0.31	0.64	0.34	0.12	0.31	0.10	0.64	0.40	0.40	0.26	0.19	0.19
Delay/Veh:	27.5	14.0	7.1	39.1	19.6	11.9	44.5	36.7	36.7	38.7	36.8	36.8
User DelAdj:	1.00	1.00	1.00	1.00	1.00	1.00	1.00	1.00	1.00	1.00	1.00	1.00
AdjDel/Veh:	27.5	14.0	7.1	39.1	19.6	11.9	44.5	36.7	36.7	38.7	36.8	36.8
LOS by Move:	C	B	A	D	B	B	D	D	D	D	D	D
HCM2k95thQ:	6	22	9	1	8	3	10	6	6	2	2	2

Note: Queue reported is the number of cars per lane.

BART Phase II Extension Project

Level Of Service Computation Report
 2000 HCM Operations (Future Volume Alternative)
 PM - Existing Plus Project Conditions

Intersection #9: Coleman/Brokaw

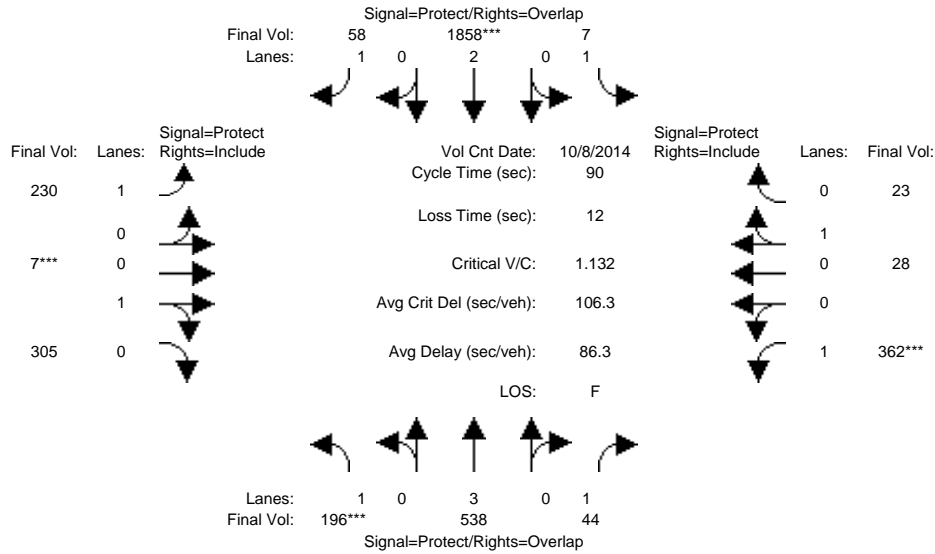

Approach:	North Bound			South Bound			East Bound			West Bound		
	L	T	R	L	T	R	L	T	R	L	T	R
Min. Green:	7	10	10	7	10	10	7	10	10	7	10	10
Y+R:	4.0	4.0	4.0	4.0	4.0	4.0	4.0	4.0	4.0	4.0	4.0	4.0
Volume Module: >> Count Date: 8 Oct 2014 <<												
Base Vol:	196	538	44	7	1858	58	230	7	305	362	28	23
Growth Adj:	1.00	1.00	1.00	1.00	1.00	1.00	1.00	1.00	1.00	1.00	1.00	1.00
Initial Bse:	196	538	44	7	1858	58	230	7	305	362	28	23
Added Vol:	0	0	0	0	0	0	0	0	0	0	0	0
PasserByVol:	0	0	0	0	0	0	0	0	0	0	0	0
Initial Fut:	196	538	44	7	1858	58	230	7	305	362	28	23
User Adj:	1.00	1.00	1.00	1.00	1.00	1.00	1.00	1.00	1.00	1.00	1.00	1.00
PHF Adj:	1.00	1.00	1.00	1.00	1.00	1.00	1.00	1.00	1.00	1.00	1.00	1.00
PHF Volume:	196	538	44	7	1858	58	230	7	305	362	28	23
Reduct Vol:	0	0	0	0	0	0	0	0	0	0	0	0
Reduced Vol:	196	538	44	7	1858	58	230	7	305	362	28	23
PCE Adj:	1.00	1.00	1.00	1.00	1.00	1.00	1.00	1.00	1.00	1.00	1.00	1.00
MLF Adj:	1.00	1.00	1.00	1.00	1.00	1.00	1.00	1.00	1.00	1.00	1.00	1.00
FinalVolume:	196	538	44	7	1858	58	230	7	305	362	28	23
Saturation Flow Module:												
Sat/Lane:	1900	1900	1900	1900	1900	1900	1900	1900	1900	1900	1900	1900
Adjustment:	0.92	1.00	0.92	0.92	1.00	0.92	0.92	0.95	0.95	0.92	0.95	0.95
Lanes:	1.00	3.00	1.00	1.00	2.00	1.00	1.00	0.02	0.98	1.00	0.55	0.45
Final Sat.:	1750	5700	1750	1750	3800	1750	1750	40	1760	1750	988	812
Capacity Analysis Module:												
Vol/Sat:	0.11	0.09	0.03	0.00	0.49	0.03	0.13	0.17	0.17	0.21	0.03	0.03
Crit Moves:	****				****			****		****		
Green Time:	8.9	28.1	44.5	19.7	38.9	55.2	16.4	13.8	13.8	16.4	13.8	13.8
Volume/Cap:	1.13	0.30	0.05	0.02	1.13	0.05	0.72	1.13	1.13	1.13	0.18	0.18
Delay/Veh:	148.9	23.6	11.8	27.6	93.3	7.0	42.6	133	132.7	127.7	33.5	33.5
User DelAdj:	1.00	1.00	1.00	1.00	1.00	1.00	1.00	1.00	1.00	1.00	1.00	1.00
AdjDel/Veh:	148.9	23.6	11.8	27.6	93.3	7.0	42.6	133	132.7	127.7	33.5	33.5
LOS by Move:	F	C	B	C	F	A	D	F	F	F	C	C
HCM2k95thQ:	18	7	1	0	64	1	15	30	30	31	3	3

Note: Queue reported is the number of cars per lane.

BART Phase II Extension Project

Level Of Service Computation Report
2000 HCM Operations (Future Volume Alternative)
AM - Existing Plus Project Conditions

Intersection #106: Benton/EI Camino Real

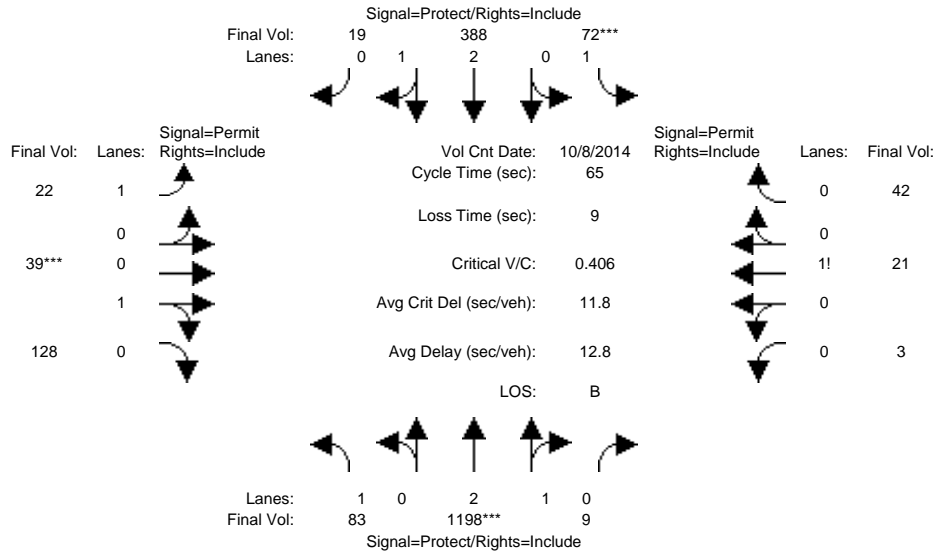

Approach:	North Bound			South Bound			East Bound			West Bound		
	L	T	R	L	T	R	L	T	R	L	T	R
Min. Green:	7	10	10	7	10	10	10	10	10	10	10	10
Y+R:	4.0	4.0	4.0	4.0	4.0	4.0	4.0	4.0	4.0	4.0	4.0	4.0

Volume Module:	>>	Count	Date:	8 Oct 2014	<<											
Base Vol:	83	1198	9	72	388	19	22	39	128	3	21	42				
Growth Adj:	1.00	1.00	1.00	1.00	1.00	1.00	1.00	1.00	1.00	1.00	1.00	1.00				
Initial Bse:	83	1198	9	72	388	19	22	39	128	3	21	42				
Added Vol:	0	0	0	0	0	0	0	0	0	0	0	0				
PasserByVol:	0	0	0	0	0	0	0	0	0	0	0	0				
Initial Fut:	83	1198	9	72	388	19	22	39	128	3	21	42				
User Adj:	1.00	1.00	1.00	1.00	1.00	1.00	1.00	1.00	1.00	1.00	1.00	1.00				
PHF Adj:	1.00	1.00	1.00	1.00	1.00	1.00	1.00	1.00	1.00	1.00	1.00	1.00				
PHF Volume:	83	1198	9	72	388	19	22	39	128	3	21	42				
Reduct Vol:	0	0	0	0	0	0	0	0	0	0	0	0				
Reduced Vol:	83	1198	9	72	388	19	22	39	128	3	21	42				
PCE Adj:	1.00	1.00	1.00	1.00	1.00	1.00	1.00	1.00	1.00	1.00	1.00	1.00				
MLF Adj:	1.00	1.00	1.00	1.00	1.00	1.00	1.00	1.00	1.00	1.00	1.00	1.00				
Final Volume:	83	1198	9	72	388	19	22	39	128	3	21	42				

Saturation Flow Module:												
Sat/Lane:	1900	1900	1900	1900	1900	1900	1900	1900	1900	1900	1900	1900
Adjustment:	0.92	0.98	0.95	0.92	0.98	0.95	0.92	0.95	0.95	0.92	0.92	0.92
Lanes:	1.00	2.98	0.02	1.00	2.85	0.15	1.00	0.23	0.77	0.04	0.32	0.64
Final Sat.:	1750	5558	42	1750	5338	261	1750	420	1380	80	557	1114

Capacity Analysis Module:												
Vol/Sat:	0.05	0.22	0.22	0.04	0.07	0.07	0.01	0.09	0.09	0.04	0.04	0.04
Crit Moves:	****			****			****					
Green Time:	17.0	34.3	34.3	7.0	24.3	24.3	14.7	14.7	14.7	14.7	14.7	14.7
Volume/Cap:	0.18	0.41	0.41	0.38	0.19	0.19	0.06	0.41	0.41	0.17	0.17	0.17
Delay/Veh:	18.8	9.4	9.4	28.3	13.8	13.8	19.7	22.1	22.1	20.4	20.4	20.4
User DelAdj:	1.00	1.00	1.00	1.00	1.00	1.00	1.00	1.00	1.00	1.00	1.00	1.00
AdjDel/Veh:	18.8	9.4	9.4	28.3	13.8	13.8	19.7	22.1	22.1	20.4	20.4	20.4
LOS by Move:	B	A	A	C	B	B	B	C	C	C	C	C
HCM2k95thQ:	3	9	9	3	4	4	1	6	6	3	3	3

Note: Queue reported is the number of cars per lane.

BART Phase II Extension Project

Level Of Service Computation Report
 2000 HCM Operations (Future Volume Alternative)
 PM - Existing Plus Project Conditions

Intersection #106: Benton/EI Camino Real

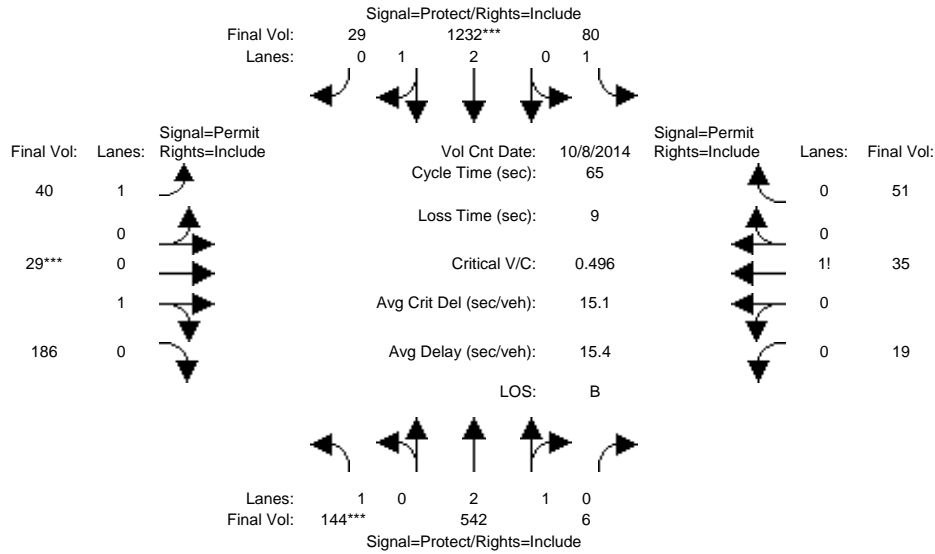

Approach:	North Bound			South Bound			East Bound			West Bound		
	L	T	R	L	T	R	L	T	R	L	T	R
Min. Green:	7	10	10	7	10	10	10	10	10	10	10	10
Y+R:	4.0	4.0	4.0	4.0	4.0	4.0	4.0	4.0	4.0	4.0	4.0	4.0

Volume Module:	>> Count Date: 8 Oct 2014 <<											
Base Vol:	144	542	6	80	1232	29	40	29	186	19	35	51
Growth Adj:	1.00	1.00	1.00	1.00	1.00	1.00	1.00	1.00	1.00	1.00	1.00	1.00
Initial Bse:	144	542	6	80	1232	29	40	29	186	19	35	51
Added Vol:	0	0	0	0	0	0	0	0	0	0	0	0
PasserByVol:	0	0	0	0	0	0	0	0	0	0	0	0
Initial Fut:	144	542	6	80	1232	29	40	29	186	19	35	51
User Adj:	1.00	1.00	1.00	1.00	1.00	1.00	1.00	1.00	1.00	1.00	1.00	1.00
PHF Adj:	1.00	1.00	1.00	1.00	1.00	1.00	1.00	1.00	1.00	1.00	1.00	1.00
PHF Volume:	144	542	6	80	1232	29	40	29	186	19	35	51
Reduct Vol:	0	0	0	0	0	0	0	0	0	0	0	0
Reduced Vol:	144	542	6	80	1232	29	40	29	186	19	35	51
PCE Adj:	1.00	1.00	1.00	1.00	1.00	1.00	1.00	1.00	1.00	1.00	1.00	1.00
MLF Adj:	1.00	1.00	1.00	1.00	1.00	1.00	1.00	1.00	1.00	1.00	1.00	1.00
FinalVolume:	144	542	6	80	1232	29	40	29	186	19	35	51

Saturation Flow Module:												
Sat/Lane:	1900	1900	1900	1900	1900	1900	1900	1900	1900	1900	1900	1900
Adjustment:	0.92	0.98	0.95	0.92	0.98	0.95	0.92	0.95	0.95	0.92	0.92	0.92
Lanes:	1.00	2.97	0.03	1.00	2.93	0.07	1.00	0.13	0.87	0.18	0.33	0.49
Final Sat.:	1750	5539	61	1750	5471	129	1750	243	1557	317	583	850

Capacity Analysis Module:												
Vol/Sat:	0.08	0.10	0.10	0.05	0.23	0.23	0.02	0.12	0.12	0.06	0.06	0.06
Crit Moves:	****			****			****					
Green Time:	10.8	23.7	23.7	16.6	29.5	29.5	15.7	15.7	15.7	15.7	15.7	15.7
Volume/Cap:	0.50	0.27	0.27	0.18	0.50	0.50	0.09	0.50	0.50	0.25	0.25	0.25
Delay/Veh:	26.0	14.6	14.6	19.1	12.6	12.6	19.3	22.2	22.2	20.2	20.2	20.2
User DelAdj:	1.00	1.00	1.00	1.00	1.00	1.00	1.00	1.00	1.00	1.00	1.00	1.00
AdjDel/Veh:	26.0	14.6	14.6	19.1	12.6	12.6	19.3	22.2	22.2	20.2	20.2	20.2
LOS by Move:	C	B	B	B	B	B	B	C	C	C	C	C
HCM2k95thQ:	6	5	5	3	11	11	1	8	8	4	4	4

Note: Queue reported is the number of cars per lane.

BART Phase II Extension Project

Level Of Service Computation Report
2000 HCM Operations (Future Volume Alternative)
AM - Existing Plus Project Conditions

Intersection #107: Benton/Lafayette

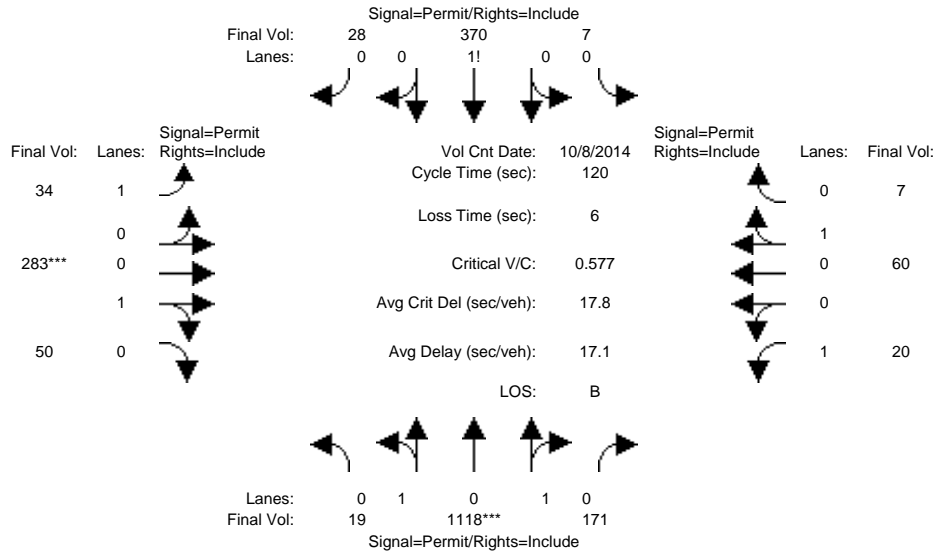

Approach:	North Bound			South Bound			East Bound			West Bound		
	L	T	R	L	T	R	L	T	R	L	T	R
Min. Green:	10	10	10	10	10	10	10	10	10	10	10	10
Y+R:	4.0	4.0	4.0	4.0	4.0	4.0	4.0	4.0	4.0	4.0	4.0	4.0
Volume Module: >> Count Date: 8 Oct 2014 <<												
Base Vol:	19	1118	171	7	370	28	34	283	50	20	60	7
Growth Adj:	1.00	1.00	1.00	1.00	1.00	1.00	1.00	1.00	1.00	1.00	1.00	1.00
Initial Bse:	19	1118	171	7	370	28	34	283	50	20	60	7
Added Vol:	0	0	0	0	0	0	0	0	0	0	0	0
PasserByVol:	0	0	0	0	0	0	0	0	0	0	0	0
Initial Fut:	19	1118	171	7	370	28	34	283	50	20	60	7
User Adj:	1.00	1.00	1.00	1.00	1.00	1.00	1.00	1.00	1.00	1.00	1.00	1.00
PHF Adj:	1.00	1.00	1.00	1.00	1.00	1.00	1.00	1.00	1.00	1.00	1.00	1.00
PHF Volume:	19	1118	171	7	370	28	34	283	50	20	60	7
Reduct Vol:	0	0	0	0	0	0	0	0	0	0	0	0
Reduced Vol:	19	1118	171	7	370	28	34	283	50	20	60	7
PCE Adj:	1.00	1.00	1.00	1.00	1.00	1.00	1.00	1.00	1.00	1.00	1.00	1.00
MLF Adj:	1.00	1.00	1.00	1.00	1.00	1.00	1.00	1.00	1.00	1.00	1.00	1.00
FinalVolume:	19	1118	171	7	370	28	34	283	50	20	60	7
Saturation Flow Module:												
Sat/Lane:	1900	1900	1900	1900	1900	1900	1900	1900	1900	1900	1900	1900
Adjustment:	0.95	0.95	0.95	0.92	0.92	0.92	0.92	0.95	0.95	0.92	0.95	0.95
Lanes:	0.03	1.71	0.26	0.02	0.91	0.07	1.00	0.85	0.15	1.00	0.90	0.10
Final Sat.:	52	3077	471	30	1599	121	1750	1530	270	1750	1612	188
Capacity Analysis Module:												
Vol/Sat:	0.36	0.36	0.36	0.23	0.23	0.23	0.02	0.19	0.19	0.01	0.04	0.04
Crit Moves:	****									****		
Green Time:	75.5	75.5	75.5	75.5	75.5	75.5	38.5	38.5	38.5	38.5	38.5	38.5
Volume/Cap:	0.58	0.58	0.58	0.37	0.37	0.37	0.06	0.58	0.58	0.04	0.12	0.12
Delay/Veh:	13.3	13.3	13.3	10.9	10.9	10.9	28.3	35.4	35.4	28.0	28.9	28.9
User DelAdj:	1.00	1.00	1.00	1.00	1.00	1.00	1.00	1.00	1.00	1.00	1.00	1.00
AdjDel/Veh:	13.3	13.3	13.3	10.9	10.9	10.9	28.3	35.4	35.4	28.0	28.9	28.9
LOS by Move:	B	B	B	B	B	B	C	D	D	C	C	C
HCM2k95thQ:	25	25	25	14	14	14	2	19	19	1	4	4

Note: Queue reported is the number of cars per lane.

BART Phase II Extension Project

Level Of Service Computation Report
2000 HCM Operations (Future Volume Alternative)
PM - Existing Plus Project Conditions

Intersection #107: Benton/Lafayette

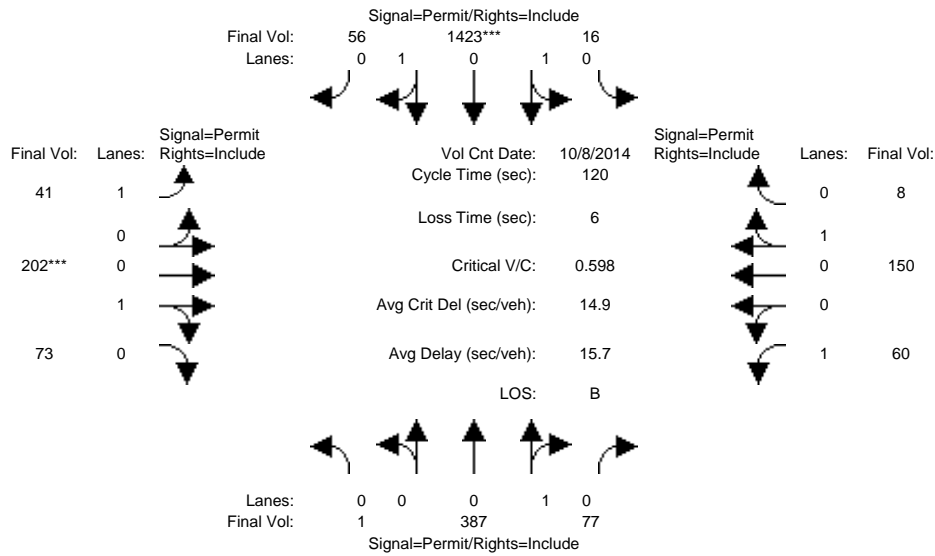

Approach:	North Bound			South Bound			East Bound			West Bound		
	L	T	R	L	T	R	L	T	R	L	T	R
Min. Green:	10	10	10	10	10	10	10	10	10	10	10	10
Y+R:	4.0	4.0	4.0	4.0	4.0	4.0	4.0	4.0	4.0	4.0	4.0	4.0
Volume Module: >> Count Date: 8 Oct 2014 <<												
Base Vol:	1	387	77	16	1423	56	41	202	73	60	150	8
Growth Adj:	1.00	1.00	1.00	1.00	1.00	1.00	1.00	1.00	1.00	1.00	1.00	1.00
Initial Bse:	1	387	77	16	1423	56	41	202	73	60	150	8
Added Vol:	0	0	0	0	0	0	0	0	0	0	0	0
PasserByVol:	0	0	0	0	0	0	0	0	0	0	0	0
Initial Fut:	1	387	77	16	1423	56	41	202	73	60	150	8
User Adj:	1.00	1.00	1.00	1.00	1.00	1.00	1.00	1.00	1.00	1.00	1.00	1.00
PHF Adj:	1.00	1.00	1.00	1.00	1.00	1.00	1.00	1.00	1.00	1.00	1.00	1.00
PHF Volume:	1	387	77	16	1423	56	41	202	73	60	150	8
Reduct Vol:	0	0	0	0	0	0	0	0	0	0	0	0
Reduced Vol:	1	387	77	16	1423	56	41	202	73	60	150	8
PCE Adj:	1.00	1.00	1.00	1.00	1.00	1.00	1.00	1.00	1.00	1.00	1.00	1.00
MLF Adj:	1.00	1.00	1.00	1.00	1.00	1.00	1.00	1.00	1.00	1.00	1.00	1.00
FinalVolume:	1	387	77	16	1423	56	41	202	73	60	150	8
Saturation Flow Module:												
Sat/Lane:	1900	1900	1900	1900	1900	1900	1900	1900	1900	1900	1900	1900
Adjustment:	0.92	0.92	0.92	0.95	0.95	0.95	0.92	0.95	0.95	0.92	0.95	0.95
Lanes:	0.01	0.83	0.16	0.02	1.91	0.07	1.00	0.73	0.27	1.00	0.95	0.05
Final Sat.:	4	1456	290	39	3427	135	1750	1322	478	1750	1709	91
Capacity Analysis Module:												
Vol/Sat:	0.27	0.27	0.27	0.42	0.42	0.42	0.02	0.15	0.15	0.03	0.09	0.09
Crit Moves:	****						****					
Green Time:	83.3	83.3	83.3	83.3	83.3	83.3	30.7	30.7	30.7	30.7	30.7	30.7
Volume/Cap:	0.38	0.38	0.38	0.60	0.60	0.60	0.09	0.60	0.60	0.13	0.34	0.34
Delay/Veh:	7.8	7.8	7.8	10.0	10.0	10.0	34.1	41.4	41.4	34.6	36.9	36.9
User DelAdj:	1.00	1.00	1.00	1.00	1.00	1.00	1.00	1.00	1.00	1.00	1.00	1.00
AdjDel/Veh:	7.8	7.8	7.8	10.0	10.0	10.0	34.1	41.4	41.4	34.6	36.9	36.9
LOS by Move:	A	A	A	A	A	A	C	D	D	C	D	D
HCM2k95thQ:	14	14	14	25	25	25	2	17	17	4	10	10

Note: Queue reported is the number of cars per lane.

BART Phase II Extension Project

Level Of Service Computation Report
2000 HCM Operations (Future Volume Alternative)
AM - Existing Plus Project Conditions

Intersection #175: Reed/De La Cruz

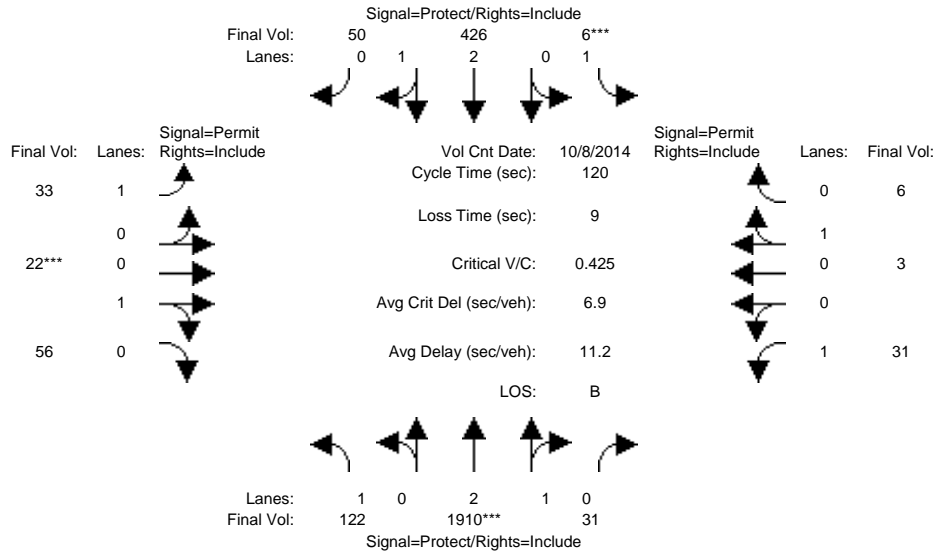

Approach:	North Bound			South Bound			East Bound			West Bound		
	L	T	R	L	T	R	L	T	R	L	T	R
Min. Green:	7	10	10	7	10	10	10	10	10	10	10	10
Y+R:	4.0	4.0	4.0	4.0	4.0	4.0	4.0	4.0	4.0	4.0	4.0	4.0
Volume Module: >> Count Date: 8 Oct 2014 <<												
Base Vol:	122	1910	31	6	426	50	33	22	56	31	3	6
Growth Adj:	1.00	1.00	1.00	1.00	1.00	1.00	1.00	1.00	1.00	1.00	1.00	1.00
Initial Bse:	122	1910	31	6	426	50	33	22	56	31	3	6
Added Vol:	0	0	0	0	0	0	0	0	0	0	0	0
PasserByVol:	0	0	0	0	0	0	0	0	0	0	0	0
Initial Fut:	122	1910	31	6	426	50	33	22	56	31	3	6
User Adj:	1.00	1.00	1.00	1.00	1.00	1.00	1.00	1.00	1.00	1.00	1.00	1.00
PHF Adj:	1.00	1.00	1.00	1.00	1.00	1.00	1.00	1.00	1.00	1.00	1.00	1.00
PHF Volume:	122	1910	31	6	426	50	33	22	56	31	3	6
Reduct Vol:	0	0	0	0	0	0	0	0	0	0	0	0
Reduced Vol:	122	1910	31	6	426	50	33	22	56	31	3	6
PCE Adj:	1.00	1.00	1.00	1.00	1.00	1.00	1.00	1.00	1.00	1.00	1.00	1.00
MLF Adj:	1.00	1.00	1.00	1.00	1.00	1.00	1.00	1.00	1.00	1.00	1.00	1.00
FinalVolume:	122	1910	31	6	426	50	33	22	56	31	3	6
Saturation Flow Module:												
Sat/Lane:	1900	1900	1900	1900	1900	1900	1900	1900	1900	1900	1900	1900
Adjustment:	0.92	0.98	0.95	0.92	0.99	0.95	0.92	0.95	0.95	0.92	0.95	0.95
Lanes:	1.00	2.95	0.05	1.00	2.67	0.33	1.00	0.28	0.72	1.00	0.33	0.67
Final Sat.:	1750	5510	89	1750	5011	588	1750	508	1292	1750	600	1200
Capacity Analysis Module:												
Vol/Sat:	0.07	0.35	0.35	0.00	0.09	0.09	0.02	0.04	0.04	0.02	0.01	0.01
Crit Moves:	****			****			****			****		
Green Time:	44.8	92.4	92.4	7.0	54.6	54.6	11.6	11.6	11.6	11.6	11.6	11.6
Volume/Cap:	0.19	0.45	0.45	0.06	0.19	0.19	0.20	0.45	0.45	0.18	0.05	0.05
Delay/Veh:	25.5	4.9	4.9	53.6	19.5	19.5	50.5	53.1	53.1	50.4	49.4	49.4
User DelAdj:	1.00	1.00	1.00	1.00	1.00	1.00	1.00	1.00	1.00	1.00	1.00	1.00
AdjDel/Veh:	25.5	4.9	4.9	53.6	19.5	19.5	50.5	53.1	53.1	50.4	49.4	49.4
LOS by Move:	C	A	A	D	B	B	D	D	D	D	D	D
HCM2k95thQ:	6	16	16	0	7	7	2	6	6	3	1	1

Note: Queue reported is the number of cars per lane.

BART Phase II Extension Project

Level Of Service Computation Report
 2000 HCM Operations (Future Volume Alternative)
 PM - Existing Plus Project Conditions

Intersection #175: Reed/De La Cruz

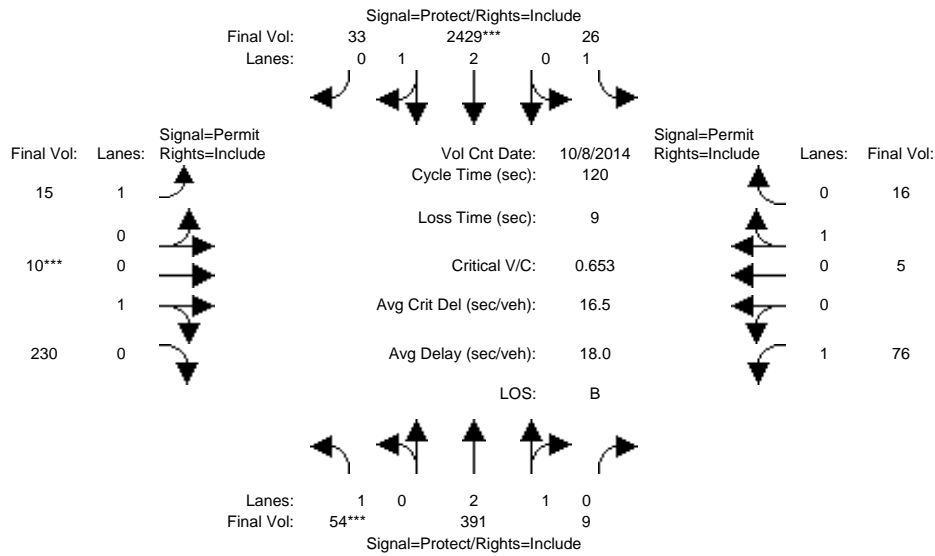

Approach:	North Bound			South Bound			East Bound			West Bound		
Movement:	L	T	R	L	T	R	L	T	R	L	T	R
Min. Green:	7	10	10	7	10	10	10	10	10	10	10	10
Y+R:	4.0	4.0	4.0	4.0	4.0	4.0	4.0	4.0	4.0	4.0	4.0	4.0
Volume Module: >> Count Date: 8 Oct 2014 <<												
Base Vol:	54	391	9	26	2429	33	15	10	230	76	5	16
Growth Adj:	1.00	1.00	1.00	1.00	1.00	1.00	1.00	1.00	1.00	1.00	1.00	1.00
Initial Bse:	54	391	9	26	2429	33	15	10	230	76	5	16
Added Vol:	0	0	0	0	0	0	0	0	0	0	0	0
PasserByVol:	0	0	0	0	0	0	0	0	0	0	0	0
Initial Fut:	54	391	9	26	2429	33	15	10	230	76	5	16
User Adj:	1.00	1.00	1.00	1.00	1.00	1.00	1.00	1.00	1.00	1.00	1.00	1.00
PHF Adj:	1.00	1.00	1.00	1.00	1.00	1.00	1.00	1.00	1.00	1.00	1.00	1.00
PHF Volume:	54	391	9	26	2429	33	15	10	230	76	5	16
Reduct Vol:	0	0	0	0	0	0	0	0	0	0	0	0
Reduced Vol:	54	391	9	26	2429	33	15	10	230	76	5	16
PCE Adj:	1.00	1.00	1.00	1.00	1.00	1.00	1.00	1.00	1.00	1.00	1.00	1.00
MLF Adj:	1.00	1.00	1.00	1.00	1.00	1.00	1.00	1.00	1.00	1.00	1.00	1.00
FinalVolume:	54	391	9	26	2429	33	15	10	230	76	5	16
Saturation Flow Module:												
Sat/Lane:	1900	1900	1900	1900	1900	1900	1900	1900	1900	1900	1900	1900
Adjustment:	0.92	0.98	0.95	0.92	0.98	0.95	0.92	0.95	0.95	0.92	0.95	0.95
Lanes:	1.00	2.93	0.07	1.00	2.96	0.04	1.00	0.04	0.96	1.00	0.24	0.76
Final Sat.:	1750	5474	126	1750	5525	75	1750	75	1725	1750	429	1371
Capacity Analysis Module:												
Vol/Sat:	0.03	0.07	0.07	0.01	0.44	0.44	0.01	0.13	0.13	0.04	0.01	0.01
Crit Moves:	****			****			****					
Green Time:	7.0	51.1	51.1	35.7	79.8	79.8	24.2	24.2	24.2	24.2	24.2	24.2
Volume/Cap:	0.53	0.17	0.17	0.05	0.66	0.66	0.04	0.66	0.66	0.22	0.06	0.06
Delay/Veh:	60.0	21.4	21.4	30.1	12.5	12.5	38.6	48.6	48.6	40.3	38.8	38.8
User DelAdj:	1.00	1.00	1.00	1.00	1.00	1.00	1.00	1.00	1.00	1.00	1.00	1.00
AdjDel/Veh:	60.0	21.4	21.4	30.1	12.5	12.5	38.6	48.6	48.6	40.3	38.8	38.8
LOS by Move:	E	C	C	C	B	B	D	D	D	D	D	D
HCM2k95thQ:	6	6	6	1	32	32	1	16	16	5	1	1

Note: Queue reported is the number of cars per lane.

BART Phase II Extension Project

Level Of Service Computation Report
 2000 HCM Unsignalized (Future Volume Alternative)
 AM - Existing Plus Project Conditions

Intersection #1008: Lafayette/Harrison

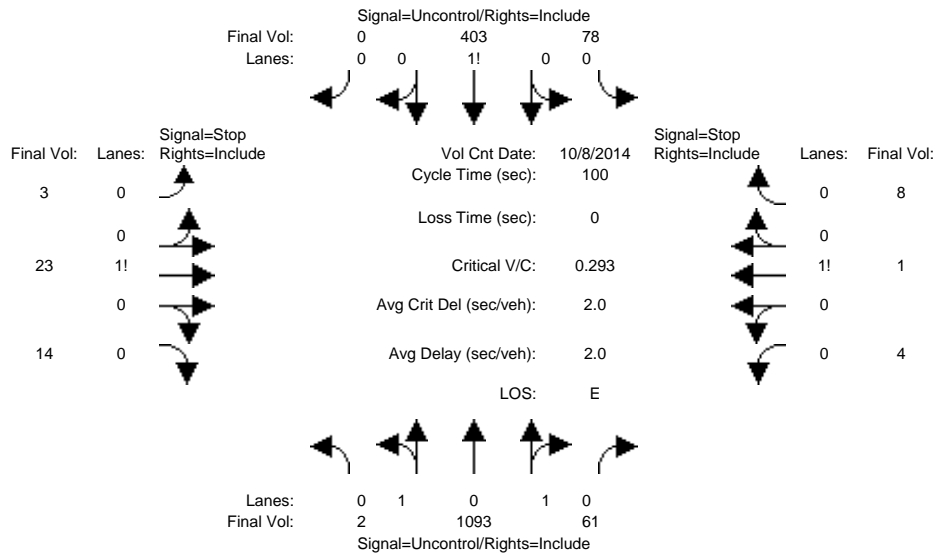

Approach:	North Bound			South Bound			East Bound			West Bound		
Movement:	L	T	R	L	T	R	L	T	R	L	T	R
Volume Module: >> Count Date: 8 Oct 2014 <<												
Base Vol:	2	1093	61	78	403	0	3	23	14	4	1	8
Growth Adj:	1.00	1.00	1.00	1.00	1.00	1.00	1.00	1.00	1.00	1.00	1.00	1.00
Initial Bse:	2	1093	61	78	403	0	3	23	14	4	1	8
Added Vol:	0	0	0	0	0	0	0	0	0	0	0	0
PasserByVol:	0	0	0	0	0	0	0	0	0	0	0	0
Initial Fut:	2	1093	61	78	403	0	3	23	14	4	1	8
User Adj:	1.00	1.00	1.00	1.00	1.00	1.00	1.00	1.00	1.00	1.00	1.00	1.00
PHF Adj:	1.00	1.00	1.00	1.00	1.00	1.00	1.00	1.00	1.00	1.00	1.00	1.00
PHF Volume:	2	1093	61	78	403	0	3	23	14	4	1	8
Reduct Vol:	0	0	0	0	0	0	0	0	0	0	0	0
FinalVolume:	2	1093	61	78	403	0	3	23	14	4	1	8
Critical Gap Module:												
Critical Gp:	4.1	xxxx	xxxxxx	4.1	xxxx	xxxxxx	7.1	6.5	6.2	7.1	6.5	6.2
FollowUpTim:	2.2	xxxx	xxxxxx	2.2	xxxx	xxxxxx	3.5	4.0	3.3	3.5	4.0	3.3
Capacity Module:												
Cnflct Vol:	403	xxxx	xxxxxx	1154	xxxx	xxxxxx	1110	1717	403	1705	1687	577
Potent Cap.:	1167	xxxx	xxxxxx	613	xxxx	xxxxxx	188	91	652	73	95	520
Move Cap.:	1167	xxxx	xxxxxx	613	xxxx	xxxxxx	165	79	652	50	82	520
Volume/Cap:	0.00	xxxx	xxxx	0.13	xxxx	xxxx	0.02	0.29	0.02	0.08	0.01	0.02
Level Of Service Module:												
2Way95thQ:	0.0	xxxx	xxxxxx	0.4	xxxx	xxxxxx	xxxx	xxxx	xxxxxx	xxxx	xxxx	xxxxxx
Control Del:	8.1	xxxx	xxxxxx	11.7	xxxx	xxxxxx	xxxxxx	xxxx	xxxxxx	xxxxxx	xxxx	xxxxxx
LOS by Move:	A	*	*	B	*	*	*	*	*	*	*	*
Movement:	LT - LTR - RT			LT - LTR - RT			LT - LTR - RT			LT - LTR - RT		
Shared Cap.:	xxxx	xxxx	xxxxxx	xxxx	xxxx	xxxxxx	xxxx	120	xxxxxx	xxxx	121	xxxxxx
SharedQueue:	0.0	xxxx	xxxxxx	0.4	xxxx	xxxxxx	xxxxxx	1.3	xxxxxx	xxxxxx	0.4	xxxxxx
Shrd ConDel:	8.1	xxxx	xxxxxx	11.7	xxxx	xxxxxx	xxxxxx	49.1	xxxxxx	xxxxxx	38.4	xxxxxx
Shared LOS:	A	*	*	B	*	*	*	E	*	*	E	*
ApproachDel:	xxxxxxx			xxxxxxx				49.1			38.4	
ApproachLOS:	*			*				E			E	

Note: Queue reported is the number of cars per lane.

BART Phase II Extension Project

Level Of Service Computation Report
 2000 HCM Unsignalized (Future Volume Alternative)
 PM - Existing Plus Project Conditions

Intersection #1008: Lafayette/Harrison

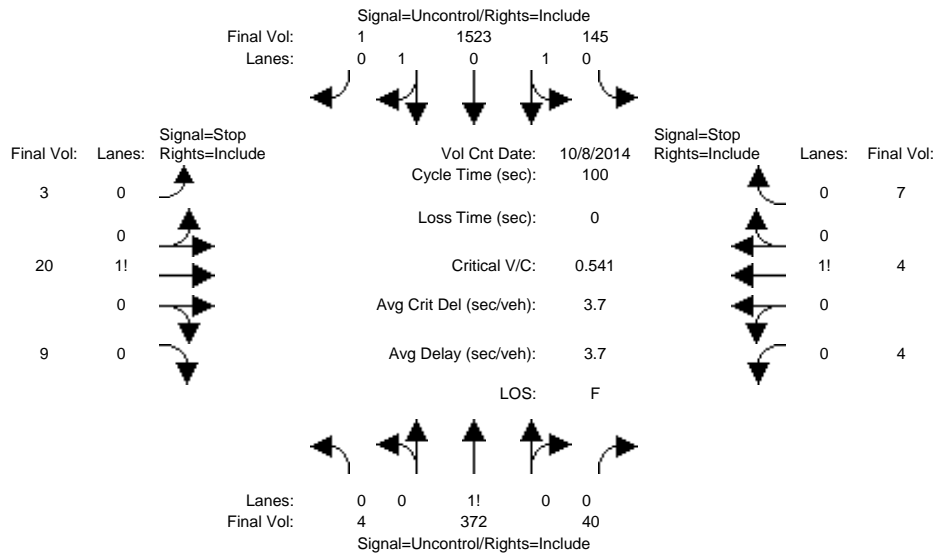

Approach:	North Bound			South Bound			East Bound			West Bound		
Movement:	L	T	R	L	T	R	L	T	R	L	T	R
Volume Module: >> Count Date: 8 Oct 2014 <<												
Base Vol:	4	372	40	145	1523	1	3	20	9	4	4	7
Growth Adj:	1.00	1.00	1.00	1.00	1.00	1.00	1.00	1.00	1.00	1.00	1.00	1.00
Initial Bse:	4	372	40	145	1523	1	3	20	9	4	4	7
Added Vol:	0	0	0	0	0	0	0	0	0	0	0	0
PasserByVol:	0	0	0	0	0	0	0	0	0	0	0	0
Initial Fut:	4	372	40	145	1523	1	3	20	9	4	4	7
User Adj:	1.00	1.00	1.00	1.00	1.00	1.00	1.00	1.00	1.00	1.00	1.00	1.00
PHF Adj:	1.00	1.00	1.00	1.00	1.00	1.00	1.00	1.00	1.00	1.00	1.00	1.00
PHF Volume:	4	372	40	145	1523	1	3	20	9	4	4	7
Reduct Vol:	0	0	0	0	0	0	0	0	0	0	0	0
FinalVolume:	4	372	40	145	1523	1	3	20	9	4	4	7
Critical Gap Module:												
Critical Gp:	4.1	xxxx	xxxxxx	4.1	xxxx	xxxxxx	7.1	6.5	6.2	7.1	6.5	6.2
FollowUpTim:	2.2	xxxx	xxxxxx	2.2	xxxx	xxxxxx	3.5	4.0	3.3	3.5	4.0	3.3
Capacity Module:												
Cnflct Vol:	1524	xxxx	xxxxxx	412	xxxx	xxxxxx	2219	2234	762	1462	2214	392
Potent Cap.:	443	xxxx	xxxxxx	1158	xxxx	xxxxxx	32	43	408	108	44	661
Move Cap.:	443	xxxx	xxxxxx	1158	xxxx	xxxxxx	26	37	408	54	38	661
Volume/Cap:	0.01	xxxx	xxxx	0.13	xxxx	xxxx	0.12	0.54	0.02	0.07	0.11	0.01
Level Of Service Module:												
2Way95thQ:	0.0	xxxx	xxxxxx	0.4	xxxx	xxxxxx	xxxx	xxxx	xxxxxx	xxxx	xxxx	xxxxxx
Control Del:	13.2	xxxx	xxxxxx	8.6	xxxx	xxxxxx	xxxxxx	xxxx	xxxxxx	xxxxxx	xxxx	xxxxxx
LOS by Move:	B	*	*	A	*	*	*	*	*	*	*	*
Movement:	LT	LTR	RT	LT	LTR	RT	LT	LTR	RT	LT	LTR	RT
Shared Cap.:	xxxx	xxxx	xxxxxx	xxxx	xxxx	xxxxxx	xxxx	47	xxxxxx	xxxx	79	xxxxxx
SharedQueue:	xxxxxx	xxxx	xxxxxx	0.4	xxxx	xxxxxx	xxxxxx	2.6	xxxxxx	xxxxxx	0.6	xxxxxx
Shrd ConDel:	xxxxxx	xxxx	xxxxxx	8.6	xxxx	xxxxxx	xxxxxx	179	xxxxxx	xxxxxx	60.7	xxxxxx
Shared LOS:	*	*	*	A	*	*	*	F	*	*	F	*
ApproachDel:	xxxxxx			xxxxxx			178.7			60.7		
ApproachLOS:	*			*			F			F		

Note: Queue reported is the number of cars per lane.

BART Phase II Extension Project

Level Of Service Computation Report
 2000 HCM Operations (Future Volume Alternative)
 AM - Existing Plus Project Conditions

Intersection #1012: El Camino Real/Railroad Ave

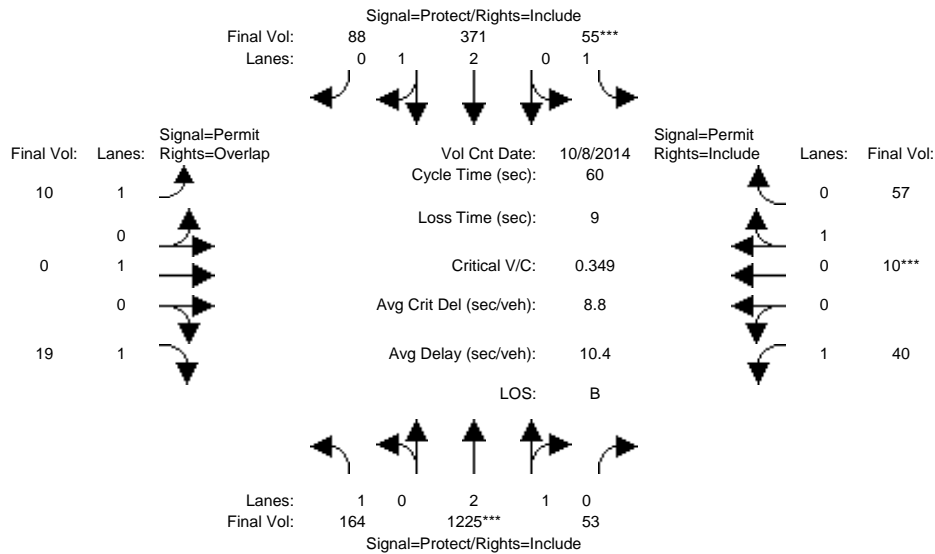

Approach:	North Bound			South Bound			East Bound			West Bound		
	L	T	R	L	T	R	L	T	R	L	T	R
Min. Green:	7	10	10	7	10	10	10	10	10	10	10	10
Y+R:	4.0	4.0	4.0	4.0	4.0	4.0	4.0	4.0	4.0	4.0	4.0	4.0

Volume Module:	>>	Count	Date:	8 Oct 2014	<<							
Base Vol:	164	1225	53	55	371	88	10	0	19	40	10	57
Growth Adj:	1.00	1.00	1.00	1.00	1.00	1.00	1.00	1.00	1.00	1.00	1.00	1.00
Initial Bse:	164	1225	53	55	371	88	10	0	19	40	10	57
Added Vol:	0	0	0	0	0	0	0	0	0	0	0	0
PasserByVol:	0	0	0	0	0	0	0	0	0	0	0	0
Initial Fut:	164	1225	53	55	371	88	10	0	19	40	10	57
User Adj:	1.00	1.00	1.00	1.00	1.00	1.00	1.00	1.00	1.00	1.00	1.00	1.00
PHF Adj:	1.00	1.00	1.00	1.00	1.00	1.00	1.00	1.00	1.00	1.00	1.00	1.00
PHF Volume:	164	1225	53	55	371	88	10	0	19	40	10	57
Reduct Vol:	0	0	0	0	0	0	0	0	0	0	0	0
Reduced Vol:	164	1225	53	55	371	88	10	0	19	40	10	57
PCE Adj:	1.00	1.00	1.00	1.00	1.00	1.00	1.00	1.00	1.00	1.00	1.00	1.00
MLF Adj:	1.00	1.00	1.00	1.00	1.00	1.00	1.00	1.00	1.00	1.00	1.00	1.00
FinalVolume:	164	1225	53	55	371	88	10	0	19	40	10	57

Saturation Flow Module:	Sat/Lane:	1900	1900	1900	1900	1900	1900	1900	1900	1900	1900	1900
Adjustment:	0.92	0.98	0.95	0.92	0.99	0.95	0.92	1.00	0.92	0.92	0.95	0.95
Lanes:	1.00	2.87	0.13	1.00	2.40	0.60	1.00	1.00	1.00	1.00	0.15	0.85
Final Sat.:	1750	5367	232	1750	4525	1073	1750	1900	1750	1750	269	1531

Capacity Analysis Module:	Vol/Sat:	0.09	0.23	0.23	0.03	0.08	0.08	0.01	0.00	0.01	0.02	0.04	0.04
Crit Moves:	****			****								****	
Green Time:	16.9	34.0	34.0	7.0	24.1	24.1	10.0	0.0	26.9	10.0	10.0	10.0	10.0
Volume/Cap:	0.33	0.40	0.40	0.27	0.20	0.20	0.03	0.00	0.02	0.14	0.22	0.22	0.22
Delay/Veh:	17.5	7.4	7.4	24.9	11.7	11.7	21.0	0.0	9.3	21.5	22.0	22.0	22.0
User DelAdj:	1.00	1.00	1.00	1.00	1.00	1.00	1.00	1.00	1.00	1.00	1.00	1.00	1.00
AdjDel/Veh:	17.5	7.4	7.4	24.9	11.7	11.7	21.0	0.0	9.3	21.5	22.0	22.0	22.0
LOS by Move:	B	A	A	C	B	B	C	A	A	C	C	C	C
HCM2k95thQ:	6	9	9	2	4	4	0	0	0	2	3	3	3

Note: Queue reported is the number of cars per lane.

BART Phase II Extension Project

Level Of Service Computation Report
 2000 HCM Operations (Future Volume Alternative)
 PM - Existing Plus Project Conditions

Intersection #1012: El Camino Real/Railroad Ave

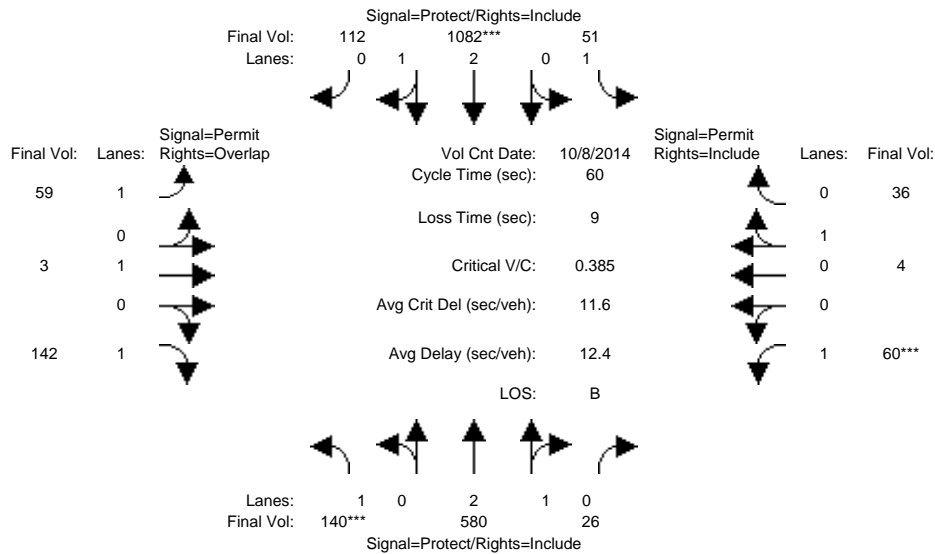

Approach:	North Bound			South Bound			East Bound			West Bound		
Movement:	L	T	R	L	T	R	L	T	R	L	T	R
Min. Green:	7	10	10	7	10	10	10	10	10	10	10	10
Y+R:	4.0	4.0	4.0	4.0	4.0	4.0	4.0	4.0	4.0	4.0	4.0	4.0
Volume Module: >> Count Date: 8 Oct 2014 <<												
Base Vol:	140	580	26	51	1082	112	59	3	142	60	4	36
Growth Adj:	1.00	1.00	1.00	1.00	1.00	1.00	1.00	1.00	1.00	1.00	1.00	1.00
Initial Bse:	140	580	26	51	1082	112	59	3	142	60	4	36
Added Vol:	0	0	0	0	0	0	0	0	0	0	0	0
PasserByVol:	0	0	0	0	0	0	0	0	0	0	0	0
Initial Fut:	140	580	26	51	1082	112	59	3	142	60	4	36
User Adj:	1.00	1.00	1.00	1.00	1.00	1.00	1.00	1.00	1.00	1.00	1.00	1.00
PHF Adj:	1.00	1.00	1.00	1.00	1.00	1.00	1.00	1.00	1.00	1.00	1.00	1.00
PHF Volume:	140	580	26	51	1082	112	59	3	142	60	4	36
Reduct Vol:	0	0	0	0	0	0	0	0	0	0	0	0
Reduced Vol:	140	580	26	51	1082	112	59	3	142	60	4	36
PCE Adj:	1.00	1.00	1.00	1.00	1.00	1.00	1.00	1.00	1.00	1.00	1.00	1.00
MLF Adj:	1.00	1.00	1.00	1.00	1.00	1.00	1.00	1.00	1.00	1.00	1.00	1.00
Final Volume:	140	580	26	51	1082	112	59	3	142	60	4	36
Saturation Flow Module:												
Sat/Lane:	1900	1900	1900	1900	1900	1900	1900	1900	1900	1900	1900	1900
Adjustment:	0.92	0.98	0.95	0.92	0.99	0.95	0.92	1.00	0.92	0.92	0.95	0.95
Lanes:	1.00	2.87	0.13	1.00	2.71	0.29	1.00	1.00	1.00	1.00	0.10	0.90
Final Sat.:	1750	5359	240	1750	5074	525	1750	1900	1750	1750	180	1620
Capacity Analysis Module:												
Vol/Sat:	0.08	0.11	0.11	0.03	0.21	0.21	0.03	0.00	0.08	0.03	0.02	0.02
Crit Moves:	****				****					****		
Green Time:	11.2	24.1	24.1	16.9	29.8	29.8	10.0	10.0	21.2	10.0	10.0	10.0
Volume/Cap:	0.43	0.27	0.27	0.10	0.43	0.43	0.20	0.01	0.23	0.21	0.13	0.13
Delay/Veh:	22.5	12.1	12.1	16.1	9.8	9.8	21.9	20.9	13.9	21.9	21.5	21.5
User DelAdj:	1.00	1.00	1.00	1.00	1.00	1.00	1.00	1.00	1.00	1.00	1.00	1.00
AdjDel/Veh:	22.5	12.1	12.1	16.1	9.8	9.8	21.9	20.9	13.9	21.9	21.5	21.5
LOS by Move:	C	B	B	B	A	A	C	C	B	C	C	C
HCM2k95thQ:	6	5	5	1	9	9	2	0	4	2	2	2

Note: Queue reported is the number of cars per lane.

BART Phase II Extension Project

Level Of Service Computation Report
 2000 HCM Operations (Future Volume Alternative)
 AM - Existing Plus Project Conditions

Intersection #1202: LAFAYETTE/EL CAMINO REAL

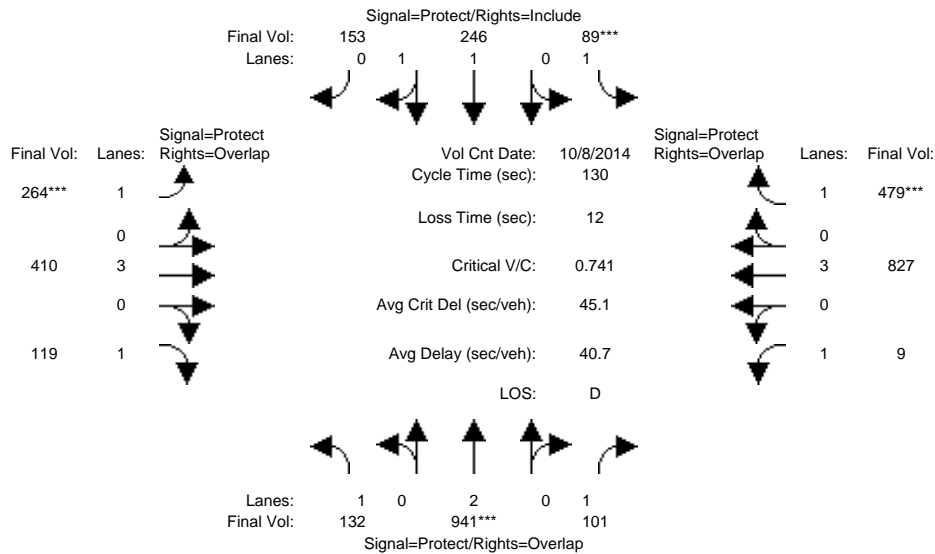

Approach:	North Bound			South Bound			East Bound			West Bound		
	L	T	R	L	T	R	L	T	R	L	T	R
Min. Green:	7	10	10	7	10	10	7	10	10	7	10	10
Y+R:	4.0	4.0	4.0	4.0	4.0	4.0	4.0	4.0	4.0	4.0	4.0	4.0
Volume Module: >> Count Date: 8 Oct 2014 <<												
Base Vol:	132	941	101	89	246	153	264	410	119	9	827	479
Growth Adj:	1.00	1.00	1.00	1.00	1.00	1.00	1.00	1.00	1.00	1.00	1.00	1.00
Initial Bse:	132	941	101	89	246	153	264	410	119	9	827	479
Added Vol:	0	0	0	0	0	0	0	0	0	0	0	0
PasserByVol:	0	0	0	0	0	0	0	0	0	0	0	0
Initial Fut:	132	941	101	89	246	153	264	410	119	9	827	479
User Adj:	1.00	1.00	1.00	1.00	1.00	1.00	1.00	1.00	1.00	1.00	1.00	1.00
PHF Adj:	1.00	1.00	1.00	1.00	1.00	1.00	1.00	1.00	1.00	1.00	1.00	1.00
PHF Volume:	132	941	101	89	246	153	264	410	119	9	827	479
Reduct Vol:	0	0	0	0	0	0	0	0	0	0	0	0
Reduced Vol:	132	941	101	89	246	153	264	410	119	9	827	479
PCE Adj:	1.00	1.00	1.00	1.00	1.00	1.00	1.00	1.00	1.00	1.00	1.00	1.00
MLF Adj:	1.00	1.00	1.00	1.00	1.00	1.00	1.00	1.00	1.00	1.00	1.00	1.00
FinalVolume:	132	941	101	89	246	153	264	410	119	9	827	479
Saturation Flow Module:												
Sat/Lane:	1900	1900	1900	1900	1900	1900	1900	1900	1900	1900	1900	1900
Adjustment:	0.92	1.00	0.92	0.92	0.99	0.95	0.92	1.00	0.92	0.92	1.00	0.92
Lanes:	1.00	2.00	1.00	1.00	1.21	0.79	1.00	3.00	1.00	1.00	3.00	1.00
Final Sat.:	1750	3800	1750	1750	2280	1418	1750	5700	1750	1750	5700	1750
Capacity Analysis Module:												
Vol/Sat:	0.08	0.25	0.06	0.05	0.11	0.11	0.15	0.07	0.07	0.01	0.15	0.27
Crit Moves:	****			****			****			****		
Green Time:	21.6	43.5	70.3	8.9	30.8	30.8	26.5	38.3	59.8	26.8	38.6	47.5
Volume/Cap:	0.45	0.74	0.11	0.74	0.45	0.45	0.74	0.24	0.15	0.02	0.49	0.75
Delay/Veh:	50.1	40.6	14.6	80.9	42.8	42.8	56.6	34.9	20.4	41.2	37.8	40.9
User DelAdj:	1.00	1.00	1.00	1.00	1.00	1.00	1.00	1.00	1.00	1.00	1.00	1.00
AdjDel/Veh:	50.1	40.6	14.6	80.9	42.8	42.8	56.6	34.9	20.4	41.2	37.8	40.9
LOS by Move:	D	D	B	F	D	D	E	C	C	D	D	D
HCM2k95thQ:	10	29	4	8	13	13	20	8	6	1	17	33

Note: Queue reported is the number of cars per lane.

BART Phase II Extension Project

Level Of Service Computation Report
 2000 HCM Operations (Future Volume Alternative)
 PM - Existing Plus Project Conditions

Intersection #1202: LAFAYETTE/EL CAMINO REAL

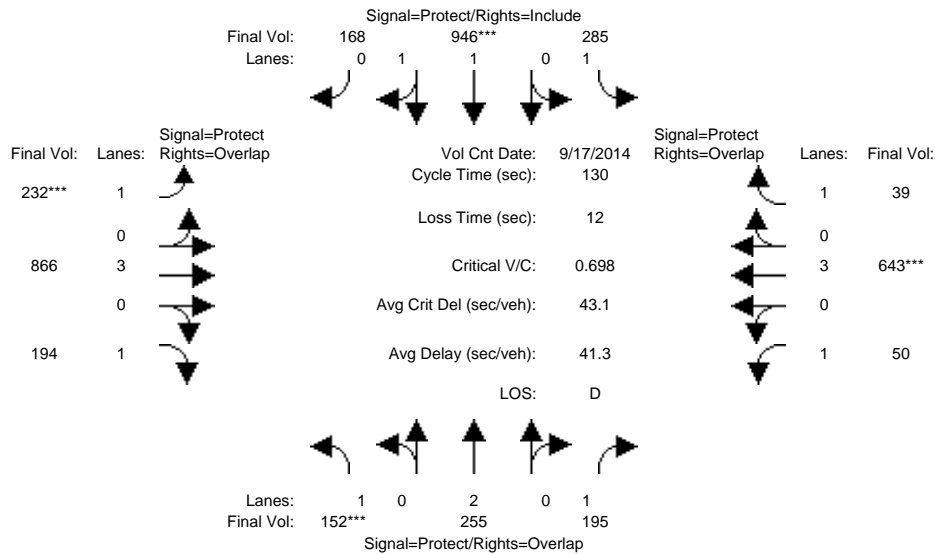

Approach:	North Bound			South Bound			East Bound			West Bound		
	L	T	R	L	T	R	L	T	R	L	T	R
Min. Green:	7	10	10	7	10	10	7	10	10	7	10	10
Y+R:	4.0	4.0	4.0	4.0	4.0	4.0	4.0	4.0	4.0	4.0	4.0	4.0
Volume Module: >> Count Date: 17 Sep 2014 <<												
Base Vol:	152	255	195	285	946	168	232	866	194	50	643	39
Growth Adj:	1.00	1.00	1.00	1.00	1.00	1.00	1.00	1.00	1.00	1.00	1.00	1.00
Initial Bse:	152	255	195	285	946	168	232	866	194	50	643	39
Added Vol:	0	0	0	0	0	0	0	0	0	0	0	0
PasserByVol:	0	0	0	0	0	0	0	0	0	0	0	0
Initial Fut:	152	255	195	285	946	168	232	866	194	50	643	39
User Adj:	1.00	1.00	1.00	1.00	1.00	1.00	1.00	1.00	1.00	1.00	1.00	1.00
PHF Adj:	1.00	1.00	1.00	1.00	1.00	1.00	1.00	1.00	1.00	1.00	1.00	1.00
PHF Volume:	152	255	195	285	946	168	232	866	194	50	643	39
Reduct Vol:	0	0	0	0	0	0	0	0	0	0	0	0
Reduced Vol:	152	255	195	285	946	168	232	866	194	50	643	39
PCE Adj:	1.00	1.00	1.00	1.00	1.00	1.00	1.00	1.00	1.00	1.00	1.00	1.00
MLF Adj:	1.00	1.00	1.00	1.00	1.00	1.00	1.00	1.00	1.00	1.00	1.00	1.00
Final Volume:	152	255	195	285	946	168	232	866	194	50	643	39
Saturation Flow Module:												
Sat/Lane:	1900	1900	1900	1900	1900	1900	1900	1900	1900	1900	1900	1900
Adjustment:	0.92	1.00	0.92	0.92	0.98	0.95	0.92	1.00	0.92	0.92	1.00	0.92
Lanes:	1.00	2.00	1.00	1.00	1.69	0.31	1.00	3.00	1.00	1.00	3.00	1.00
Final Sat.:	1750	3800	1750	1750	3142	558	1750	5700	1750	1750	5700	1750
Capacity Analysis Module:												
Vol/Sat:	0.09	0.07	0.11	0.16	0.30	0.30	0.13	0.15	0.11	0.03	0.11	0.02
Crit Moves:	****				****		****				****	
Green Time:	16.2	24.4	36.3	47.9	56.1	56.1	24.7	33.8	49.9	12.0	21.0	68.9
Volume/Cap:	0.70	0.36	0.40	0.44	0.70	0.70	0.70	0.59	0.29	0.31	0.70	0.04
Delay/Veh:	64.1	46.3	38.5	31.4	31.4	31.4	55.6	42.6	28.0	56.3	53.9	14.7
User DelAdj:	1.00	1.00	1.00	1.00	1.00	1.00	1.00	1.00	1.00	1.00	1.00	1.00
AdjDel/Veh:	64.1	46.3	38.5	31.4	31.4	31.4	55.6	42.6	28.0	56.3	53.9	14.7
LOS by Move:	E	D	D	C	C	C	E	D	C	E	D	B
HCM2k95thQ:	12	8	13	17	32	32	17	18	11	5	17	2

Note: Queue reported is the number of cars per lane.

BART Phase II Extension Project

Level Of Service Computation Report
2000 HCM Operations (Future Volume Alternative)
AM - Existing Plus Project Conditions

Intersection #1204: MONROE/EL CAMINO REAL

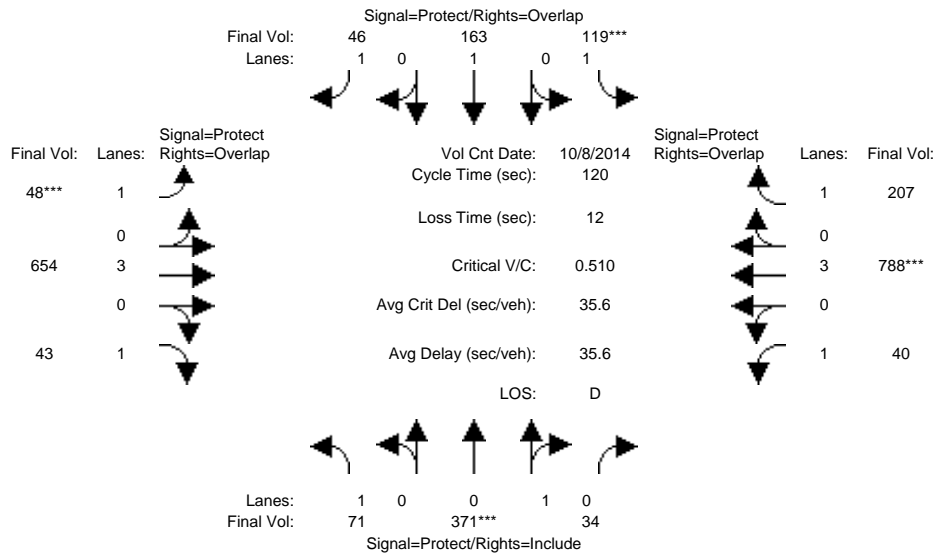

Approach:	North Bound			South Bound			East Bound			West Bound		
	L	T	R	L	T	R	L	T	R	L	T	R
Min. Green:	7	10	10	7	10	10	7	10	10	7	10	10
Y+R:	4.0	4.0	4.0	4.0	4.0	4.0	4.0	4.0	4.0	4.0	4.0	4.0
Volume Module: >> Count Date: 8 Oct 2014 <<												
Base Vol:	71	371	34	119	163	46	48	654	43	40	788	207
Growth Adj:	1.00	1.00	1.00	1.00	1.00	1.00	1.00	1.00	1.00	1.00	1.00	1.00
Initial Bse:	71	371	34	119	163	46	48	654	43	40	788	207
Added Vol:	0	0	0	0	0	0	0	0	0	0	0	0
PasserByVol:	0	0	0	0	0	0	0	0	0	0	0	0
Initial Fut:	71	371	34	119	163	46	48	654	43	40	788	207
User Adj:	1.00	1.00	1.00	1.00	1.00	1.00	1.00	1.00	1.00	1.00	1.00	1.00
PHF Adj:	1.00	1.00	1.00	1.00	1.00	1.00	1.00	1.00	1.00	1.00	1.00	1.00
PHF Volume:	71	371	34	119	163	46	48	654	43	40	788	207
Reduct Vol:	0	0	0	0	0	0	0	0	0	0	0	0
Reduced Vol:	71	371	34	119	163	46	48	654	43	40	788	207
PCE Adj:	1.00	1.00	1.00	1.00	1.00	1.00	1.00	1.00	1.00	1.00	1.00	1.00
MLF Adj:	1.00	1.00	1.00	1.00	1.00	1.00	1.00	1.00	1.00	1.00	1.00	1.00
FinalVolume:	71	371	34	119	163	46	48	654	43	40	788	207
Saturation Flow Module:												
Sat/Lane:	1900	1900	1900	1900	1900	1900	1900	1900	1900	1900	1900	1900
Adjustment:	0.92	0.95	0.95	0.92	1.00	0.92	0.92	1.00	0.92	0.92	1.00	0.92
Lanes:	1.00	0.92	0.08	1.00	1.00	1.00	1.00	3.00	1.00	1.00	3.00	1.00
Final Sat.:	1750	1649	151	1750	1900	1750	1750	5700	1750	1750	5700	1750
Capacity Analysis Module:												
Vol/Sat:	0.04	0.23	0.23	0.07	0.09	0.03	0.03	0.11	0.02	0.02	0.14	0.12
Crit Moves:	****	****	****	****	****	****	****	****	****	****	****	****
Green Time:	27.8	52.7	52.7	15.9	40.8	47.8	7.0	26.1	53.9	13.3	32.4	48.3
Volume/Cap:	0.18	0.51	0.51	0.51	0.25	0.07	0.47	0.53	0.05	0.21	0.51	0.29
Delay/Veh:	37.1	24.9	24.9	50.4	28.8	22.3	58.1	41.9	18.7	49.1	37.4	24.5
User DelAdj:	1.00	1.00	1.00	1.00	1.00	1.00	1.00	1.00	1.00	1.00	1.00	1.00
AdjDel/Veh:	37.1	24.9	24.9	50.4	28.8	22.3	58.1	41.9	18.7	49.1	37.4	24.5
LOS by Move:	D	C	C	D	C	C	E	D	B	D	D	C
HCM2k95thQ:	5	21	21	9	8	2	4	13	2	3	15	10

Note: Queue reported is the number of cars per lane.

BART Phase II Extension Project

Level Of Service Computation Report
 2000 HCM Operations (Future Volume Alternative)
 PM - Existing Plus Project Conditions

Intersection #1204: MONROE/EL CAMINO REAL

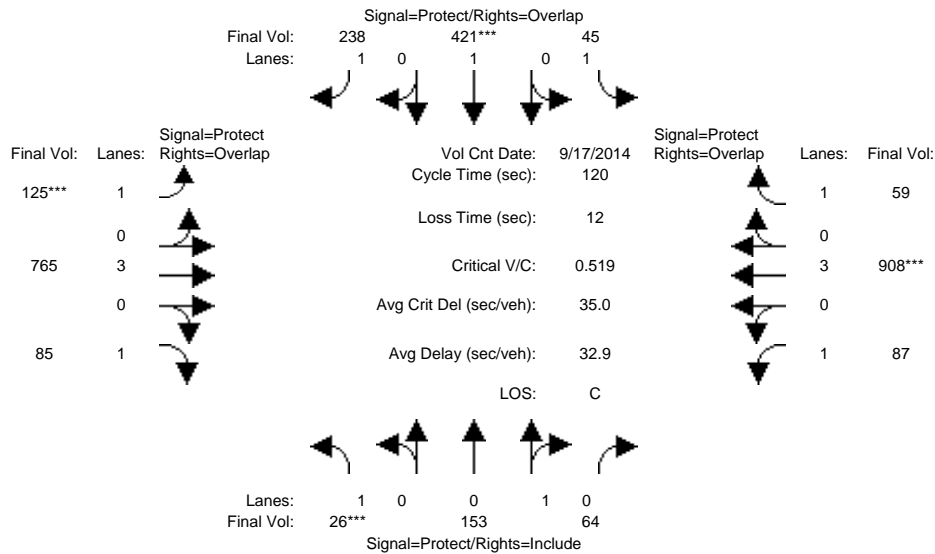

Approach:	North Bound			South Bound			East Bound			West Bound		
Movement:	L	T	R	L	T	R	L	T	R	L	T	R
Min. Green:	7	10	10	7	10	10	7	10	10	7	10	10
Y+R:	4.0	4.0	4.0	4.0	4.0	4.0	4.0	4.0	4.0	4.0	4.0	4.0
Volume Module: >> Count Date: 17 Sep 2014 <<												
Base Vol:	26	153	64	45	421	238	125	765	85	87	908	59
Growth Adj:	1.00	1.00	1.00	1.00	1.00	1.00	1.00	1.00	1.00	1.00	1.00	1.00
Initial Bse:	26	153	64	45	421	238	125	765	85	87	908	59
Added Vol:	0	0	0	0	0	0	0	0	0	0	0	0
PasserByVol:	0	0	0	0	0	0	0	0	0	0	0	0
Initial Fut:	26	153	64	45	421	238	125	765	85	87	908	59
User Adj:	1.00	1.00	1.00	1.00	1.00	1.00	1.00	1.00	1.00	1.00	1.00	1.00
PHF Adj:	1.00	1.00	1.00	1.00	1.00	1.00	1.00	1.00	1.00	1.00	1.00	1.00
PHF Volume:	26	153	64	45	421	238	125	765	85	87	908	59
Reduct Vol:	0	0	0	0	0	0	0	0	0	0	0	0
Reduced Vol:	26	153	64	45	421	238	125	765	85	87	908	59
PCE Adj:	1.00	1.00	1.00	1.00	1.00	1.00	1.00	1.00	1.00	1.00	1.00	1.00
MLF Adj:	1.00	1.00	1.00	1.00	1.00	1.00	1.00	1.00	1.00	1.00	1.00	1.00
FinalVolume:	26	153	64	45	421	238	125	765	85	87	908	59
Saturation Flow Module:												
Sat/Lane:	1900	1900	1900	1900	1900	1900	1900	1900	1900	1900	1900	1900
Adjustment:	0.92	0.95	0.95	0.92	1.00	0.92	0.92	1.00	0.92	0.92	1.00	0.92
Lanes:	1.00	0.71	0.29	1.00	1.00	1.00	1.00	3.00	1.00	1.00	3.00	1.00
Final Sat.:	1750	1269	531	1750	1900	1750	1750	5700	1750	1750	5700	1750
Capacity Analysis Module:												
Vol/Sat:	0.01	0.12	0.12	0.03	0.22	0.14	0.07	0.13	0.05	0.05	0.16	0.03
Crit Moves:	****			****			****			****		
Green Time:	7.0	38.1	38.1	18.4	49.5	65.4	16.0	35.9	42.9	15.6	35.6	54.0
Volume/Cap:	0.25	0.38	0.38	0.17	0.54	0.25	0.54	0.45	0.14	0.38	0.54	0.07
Delay/Veh:	55.3	32.2	32.2	44.4	27.4	14.5	51.1	34.2	26.1	48.9	35.7	18.8
User DelAdj:	1.00	1.00	1.00	1.00	1.00	1.00	1.00	1.00	1.00	1.00	1.00	1.00
AdjDel/Veh:	55.3	32.2	32.2	44.4	27.4	14.5	51.1	34.2	26.1	48.9	35.7	18.8
LOS by Move:	E	C	C	D	C	B	D	C	C	D	D	B
HCM2k95thQ:	3	13	13	3	21	9	9	14	4	6	17	3

Note: Queue reported is the number of cars per lane.

BART Phase II Extension Project

Level Of Service Computation Report
 2000 HCM Operations (Future Volume Alternative)
 AM - Existing Plus Project Conditions

Intersection #1205: SCOTT/EL CAMINO REAL

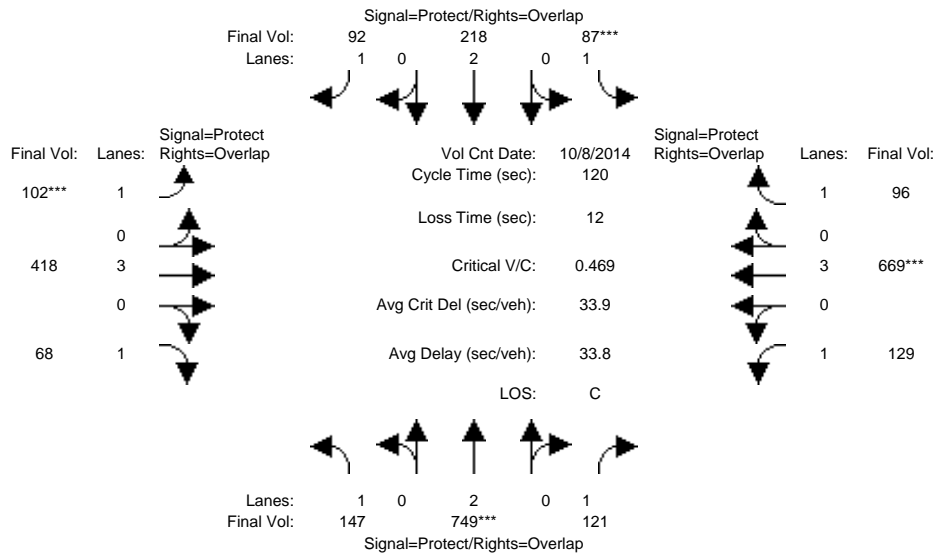

Approach:	North Bound			South Bound			East Bound			West Bound		
	L	T	R	L	T	R	L	T	R	L	T	R
Min. Green:	7	10	10	7	10	10	7	10	10	7	10	10
Y+R:	4.0	4.0	4.0	4.0	4.0	4.0	4.0	4.0	4.0	4.0	4.0	4.0

Volume Module:	Count Date: 8 Oct 2014 <<											
Base Vol:	147	749	121	87	218	92	102	418	68	129	669	96
Growth Adj:	1.00	1.00	1.00	1.00	1.00	1.00	1.00	1.00	1.00	1.00	1.00	1.00
Initial Bse:	147	749	121	87	218	92	102	418	68	129	669	96
Added Vol:	0	0	0	0	0	0	0	0	0	0	0	0
PasserByVol:	0	0	0	0	0	0	0	0	0	0	0	0
Initial Fut:	147	749	121	87	218	92	102	418	68	129	669	96
User Adj:	1.00	1.00	1.00	1.00	1.00	1.00	1.00	1.00	1.00	1.00	1.00	1.00
PHF Adj:	1.00	1.00	1.00	1.00	1.00	1.00	1.00	1.00	1.00	1.00	1.00	1.00
PHF Volume:	147	749	121	87	218	92	102	418	68	129	669	96
Reduct Vol:	0	0	0	0	0	0	0	0	0	0	0	0
Reduced Vol:	147	749	121	87	218	92	102	418	68	129	669	96
PCE Adj:	1.00	1.00	1.00	1.00	1.00	1.00	1.00	1.00	1.00	1.00	1.00	1.00
MLF Adj:	1.00	1.00	1.00	1.00	1.00	1.00	1.00	1.00	1.00	1.00	1.00	1.00
FinalVolume:	147	749	121	87	218	92	102	418	68	129	669	96

Saturation Flow Module:												
Sat/Lane:	1900	1900	1900	1900	1900	1900	1900	1900	1900	1900	1900	1900
Adjustment:	0.92	1.00	0.92	0.92	1.00	0.92	0.92	1.00	0.92	0.92	1.00	0.92
Lanes:	1.00	2.00	1.00	1.00	2.00	1.00	1.00	3.00	1.00	1.00	3.00	1.00
Final Sat.:	1750	3800	1750	1750	3800	1750	1750	5700	1750	1750	5700	1750

Capacity Analysis Module:												
Vol/Sat:	0.08	0.20	0.07	0.05	0.06	0.05	0.06	0.07	0.04	0.07	0.12	0.05
Crit Moves:	****	****	****	****	****	****	****	****	****	****	****	****
Green Time:	31.7	50.4	71.5	12.7	31.4	46.3	14.9	23.8	55.5	21.1	30.0	42.7
Volume/Cap:	0.32	0.47	0.12	0.47	0.22	0.14	0.47	0.37	0.08	0.42	0.47	0.15
Delay/Veh:	35.9	25.4	10.6	52.3	34.8	24.0	50.5	41.8	18.1	44.9	38.5	26.4
User DelAdj:	1.00	1.00	1.00	1.00	1.00	1.00	1.00	1.00	1.00	1.00	1.00	1.00
AdjDel/Veh:	35.9	25.4	10.6	52.3	34.8	24.0	50.5	41.8	18.1	44.9	38.5	26.4
LOS by Move:	D	C	B	D	C	C	D	D	B	D	D	C
HCM2k95thQ:	9	18	4	6	6	5	7	8	3	9	13	5

Note: Queue reported is the number of cars per lane.

BART Phase II Extension Project

Level Of Service Computation Report
 2000 HCM Operations (Future Volume Alternative)
 PM - Existing Plus Project Conditions

Intersection #1205: SCOTT/EL CAMINO REAL

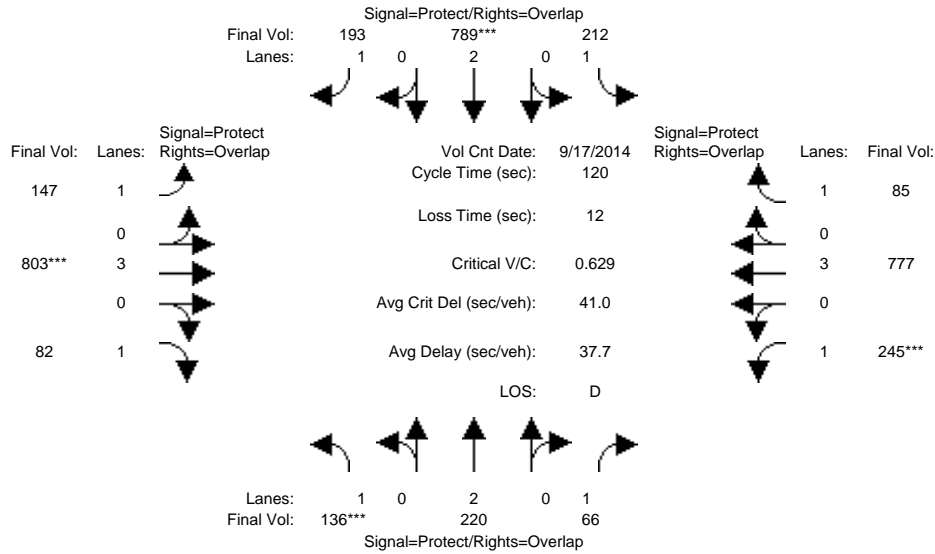

Approach:	North Bound			South Bound			East Bound			West Bound		
Movement:	L	T	R	L	T	R	L	T	R	L	T	R
Min. Green:	7	10	10	7	10	10	7	10	10	7	10	10
Y+R:	4.0	4.0	4.0	4.0	4.0	4.0	4.0	4.0	4.0	4.0	4.0	4.0
Volume Module: >> Count Date: 17 Sep 2014 <<												
Base Vol:	136	220	66	212	789	193	147	803	82	245	777	85
Growth Adj:	1.00	1.00	1.00	1.00	1.00	1.00	1.00	1.00	1.00	1.00	1.00	1.00
Initial Bse:	136	220	66	212	789	193	147	803	82	245	777	85
Added Vol:	0	0	0	0	0	0	0	0	0	0	0	0
PasserByVol:	0	0	0	0	0	0	0	0	0	0	0	0
Initial Fut:	136	220	66	212	789	193	147	803	82	245	777	85
User Adj:	1.00	1.00	1.00	1.00	1.00	1.00	1.00	1.00	1.00	1.00	1.00	1.00
PHF Adj:	1.00	1.00	1.00	1.00	1.00	1.00	1.00	1.00	1.00	1.00	1.00	1.00
PHF Volume:	136	220	66	212	789	193	147	803	82	245	777	85
Reduct Vol:	0	0	0	0	0	0	0	0	0	0	0	0
Reduced Vol:	136	220	66	212	789	193	147	803	82	245	777	85
PCE Adj:	1.00	1.00	1.00	1.00	1.00	1.00	1.00	1.00	1.00	1.00	1.00	1.00
MLF Adj:	1.00	1.00	1.00	1.00	1.00	1.00	1.00	1.00	1.00	1.00	1.00	1.00
FinalVolume:	136	220	66	212	789	193	147	803	82	245	777	85
Saturation Flow Module:												
Sat/Lane:	1900	1900	1900	1900	1900	1900	1900	1900	1900	1900	1900	1900
Adjustment:	0.92	1.00	0.92	0.92	1.00	0.92	0.92	1.00	0.92	0.92	1.00	0.92
Lanes:	1.00	2.00	1.00	1.00	2.00	1.00	1.00	3.00	1.00	1.00	3.00	1.00
Final Sat.:	1750	3800	1750	1750	3800	1750	1750	5700	1750	1750	5700	1750
Capacity Analysis Module:												
Vol/Sat:	0.08	0.06	0.04	0.12	0.21	0.11	0.08	0.14	0.05	0.14	0.14	0.05
Crit Moves:	****				****			****			****	
Green Time:	14.8	22.2	48.9	32.2	39.6	60.0	20.4	26.9	41.7	26.7	33.1	65.4
Volume/Cap:	0.63	0.31	0.09	0.45	0.63	0.22	0.49	0.63	0.13	0.63	0.49	0.09
Delay/Veh:	55.8	42.6	22.0	37.2	35.0	17.0	46.4	43.1	26.9	45.5	36.6	13.1
User DelAdj:	1.00	1.00	1.00	1.00	1.00	1.00	1.00	1.00	1.00	1.00	1.00	1.00
AdjDel/Veh:	55.8	42.6	22.0	37.2	35.0	17.0	46.4	43.1	26.9	45.5	36.6	13.1
LOS by Move:	E	D	C	D	D	B	D	D	C	D	D	B
HCM2k95thQ:	10	7	3	13	22	8	10	17	4	16	15	3

Note: Queue reported is the number of cars per lane.

BART Phase II Extension Project

Level Of Service Computation Report
 2000 HCM Operations (Future Volume Alternative)
 AM - Existing Plus Project Conditions

Intersection #1213: THE ALAMEDA/EL CAMINO REAL

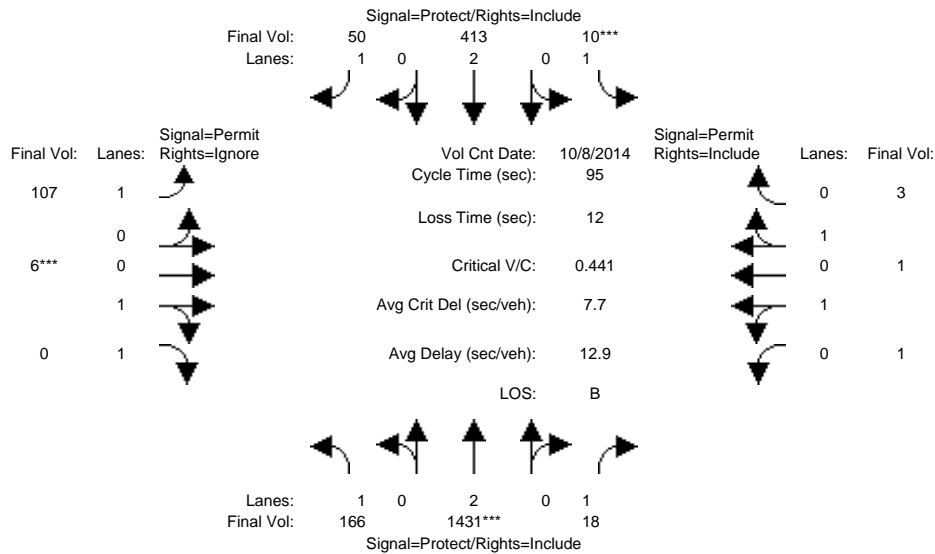

Approach:	North Bound			South Bound			East Bound			West Bound		
Movement:	L	T	R	L	T	R	L	T	R	L	T	R
Min. Green:	7	10	10	7	10	10	7	10	10	7	10	10
Y+R:	4.0	4.0	4.0	4.0	4.0	4.0	4.0	4.0	4.0	4.0	4.0	4.0
Volume Module: >> Count Date: 8 Oct 2014 <<												
Base Vol:	166	1431	18	10	413	50	107	6	100	1	1	3
Growth Adj:	1.00	1.00	1.00	1.00	1.00	1.00	1.00	1.00	1.00	1.00	1.00	1.00
Initial Bse:	166	1431	18	10	413	50	107	6	100	1	1	3
Added Vol:	0	0	0	0	0	0	0	0	0	0	0	0
PasserByVol:	0	0	0	0	0	0	0	0	0	0	0	0
Initial Fut:	166	1431	18	10	413	50	107	6	100	1	1	3
User Adj:	1.00	1.00	1.00	1.00	1.00	1.00	1.00	1.00	0.00	1.00	1.00	1.00
PHF Adj:	1.00	1.00	1.00	1.00	1.00	1.00	1.00	1.00	0.00	1.00	1.00	1.00
PHF Volume:	166	1431	18	10	413	50	107	6	0	1	1	3
Reduct Vol:	0	0	0	0	0	0	0	0	0	0	0	0
Reduced Vol:	166	1431	18	10	413	50	107	6	0	1	1	3
PCE Adj:	1.00	1.00	1.00	1.00	1.00	1.00	1.00	1.00	0.00	1.00	1.00	1.00
MLF Adj:	1.00	1.00	1.00	1.00	1.00	1.00	1.00	1.00	0.00	1.00	1.00	1.00
FinalVolume:	166	1431	18	10	413	50	107	6	0	1	1	3
Saturation Flow Module:												
Sat/Lane:	1900	1900	1900	1900	1900	1900	1900	1900	1900	1900	1900	1900
Adjustment:	0.92	1.00	0.92	0.92	1.00	0.92	0.92	0.95	0.92	0.95	0.95	0.95
Lanes:	1.00	2.00	1.00	1.00	2.00	1.00	1.00	1.00	1.00	0.50	0.50	1.00
Final Sat.:	1750	3800	1750	1750	3800	1750	1750	1800	1750	900	900	1800
Capacity Analysis Module:												
Vol/Sat:	0.09	0.38	0.01	0.01	0.11	0.03	0.06	0.00	0.00	0.00	0.00	0.00
Crit Moves:	****			****			****					
Green Time:	34.0	66.0	66.0	7.0	39.0	39.0	10.0	10.0	0.0	10.0	10.0	10.0
Volume/Cap:	0.26	0.54	0.01	0.08	0.26	0.07	0.58	0.03	0.00	0.01	0.01	0.02
Delay/Veh:	21.8	7.3	4.5	41.3	18.6	17.0	45.1	38.2	0.0	38.1	38.1	38.1
User DelAdj:	1.00	1.00	1.00	1.00	1.00	1.00	1.00	1.00	1.00	1.00	1.00	1.00
AdjDel/Veh:	21.8	7.3	4.5	41.3	18.6	17.0	45.1	38.2	0.0	38.1	38.1	38.1
LOS by Move:	C	A	A	D	B	B	D	D	A	D	D	D
HCM2k95thQ:	7	18	0	1	8	2	8	0	0	0	0	0

Note: Queue reported is the number of cars per lane.

BART Phase II Extension Project

Level Of Service Computation Report
 2000 HCM Operations (Future Volume Alternative)
 PM - Existing Plus Project Conditions

Intersection #1213: THE ALAMEDA/EL CAMINO REAL

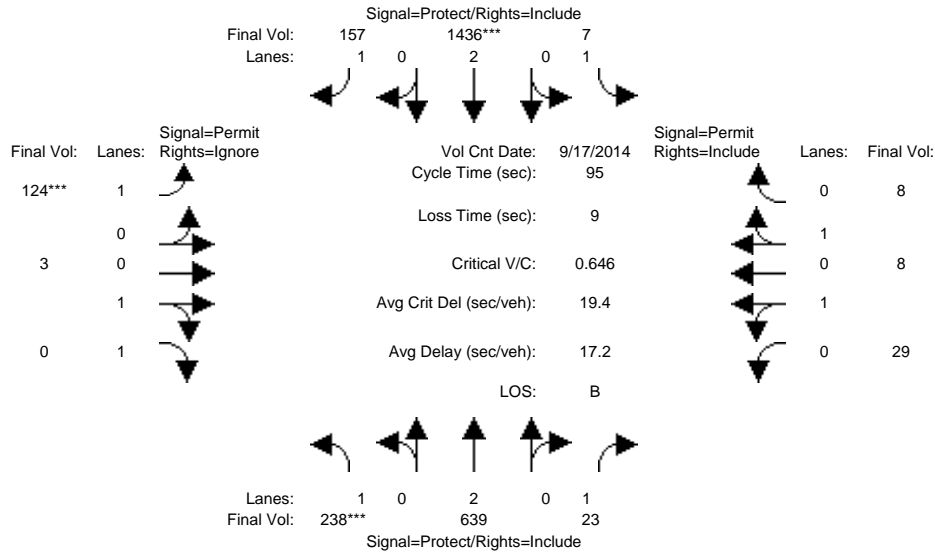

Approach:	North Bound			South Bound			East Bound			West Bound		
Movement:	L	T	R	L	T	R	L	T	R	L	T	R
Min. Green:	7	10	10	7	10	10	10	10	10	10	10	10
Y+R:	4.0	4.0	4.0	4.0	4.0	4.0	4.0	4.0	4.0	4.0	4.0	4.0
Volume Module: >> Count Date: 17 Sep 2014 <<												
Base Vol:	238	639	23	7	1436	157	124	3	275	29	8	8
Growth Adj:	1.00	1.00	1.00	1.00	1.00	1.00	1.00	1.00	1.00	1.00	1.00	1.00
Initial Bse:	238	639	23	7	1436	157	124	3	275	29	8	8
Added Vol:	0	0	0	0	0	0	0	0	0	0	0	0
PasserByVol:	0	0	0	0	0	0	0	0	0	0	0	0
Initial Fut:	238	639	23	7	1436	157	124	3	275	29	8	8
User Adj:	1.00	1.00	1.00	1.00	1.00	1.00	1.00	1.00	0.00	1.00	1.00	1.00
PHF Adj:	1.00	1.00	1.00	1.00	1.00	1.00	1.00	1.00	0.00	1.00	1.00	1.00
PHF Volume:	238	639	23	7	1436	157	124	3	0	29	8	8
Reduct Vol:	0	0	0	0	0	0	0	0	0	0	0	0
Reduced Vol:	238	639	23	7	1436	157	124	3	0	29	8	8
PCE Adj:	1.00	1.00	1.00	1.00	1.00	1.00	1.00	1.00	0.00	1.00	1.00	1.00
MLF Adj:	1.00	1.00	1.00	1.00	1.00	1.00	1.00	1.00	0.00	1.00	1.00	1.00
FinalVolume:	238	639	23	7	1436	157	124	3	0	29	8	8
Saturation Flow Module:												
Sat/Lane:	1900	1900	1900	1900	1900	1900	1900	1900	1900	1900	1900	1900
Adjustment:	0.92	1.00	0.92	0.92	1.00	0.92	0.92	0.95	0.92	0.95	0.95	0.95
Lanes:	1.00	2.00	1.00	1.00	2.00	1.00	1.00	1.00	1.00	1.00	0.50	0.50
Final Sat.:	1750	3800	1750	1750	3800	1750	1750	1800	1750	1800	900	900
Capacity Analysis Module:												
Vol/Sat:	0.14	0.17	0.01	0.00	0.38	0.09	0.07	0.00	0.00	0.02	0.01	0.01
Crit Moves:	****				****		****					
Green Time:	20.0	52.6	52.6	23.0	55.6	55.6	10.4	10.4	0.0	10.4	10.4	10.4
Volume/Cap:	0.65	0.30	0.02	0.02	0.65	0.15	0.65	0.02	0.00	0.15	0.08	0.08
Delay/Veh:	38.2	11.5	9.6	27.4	13.8	9.1	47.9	37.7	0.0	38.5	38.1	38.1
User DelAdj:	1.00	1.00	1.00	1.00	1.00	1.00	1.00	1.00	1.00	1.00	1.00	1.00
AdjDel/Veh:	38.2	11.5	9.6	27.4	13.8	9.1	47.9	37.7	0.0	38.5	38.1	38.1
LOS by Move:	D	B	A	C	B	A	D	D	A	D	D	D
HCM2k95thQ:	13	9	1	0	25	5	10	0	0	2	1	1

Note: Queue reported is the number of cars per lane.

BART Phase II Extension Project

Level Of Service Computation Report
2000 HCM Operations (Future Volume Alternative)
AM - Existing Plus Project Conditions

Intersection #3411: AVIATION/COLEMAN

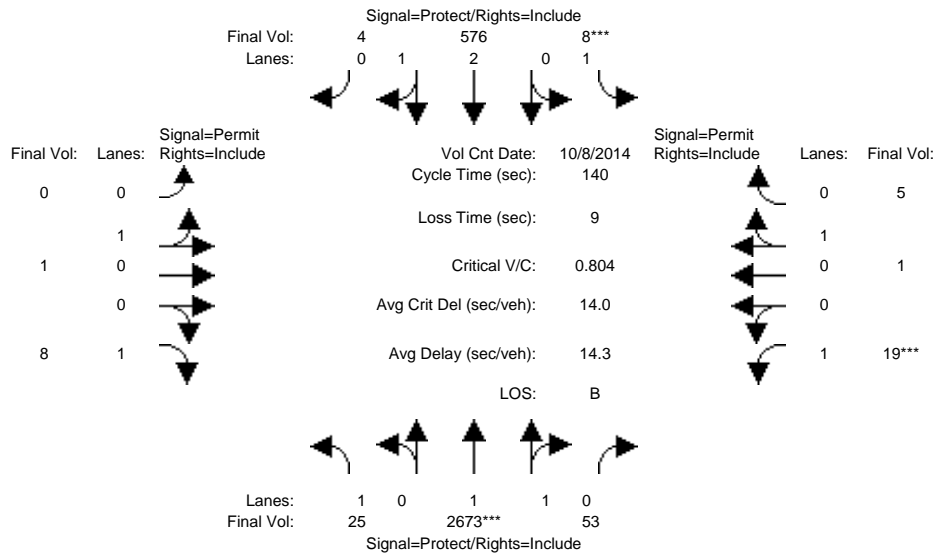

Approach:	North Bound			South Bound			East Bound			West Bound		
Movement:	L	T	R	L	T	R	L	T	R	L	T	R
Min. Green:	7	10	10	7	10	10	10	10	10	10	10	10
Y+R:	4.0	4.0	4.0	4.0	4.0	4.0	4.0	4.0	4.0	4.0	4.0	4.0
Volume Module: >> Count Date: 8 Oct 2014 <<												
Base Vol:	25	2673	53	8	576	4	0	1	8	19	1	5
Growth Adj:	1.00	1.00	1.00	1.00	1.00	1.00	1.00	1.00	1.00	1.00	1.00	1.00
Initial Bse:	25	2673	53	8	576	4	0	1	8	19	1	5
Added Vol:	0	0	0	0	0	0	0	0	0	0	0	0
PasserByVol:	0	0	0	0	0	0	0	0	0	0	0	0
Initial Fut:	25	2673	53	8	576	4	0	1	8	19	1	5
User Adj:	1.00	1.00	1.00	1.00	1.00	1.00	1.00	1.00	1.00	1.00	1.00	1.00
PHF Adj:	1.00	1.00	1.00	1.00	1.00	1.00	1.00	1.00	1.00	1.00	1.00	1.00
PHF Volume:	25	2673	53	8	576	4	0	1	8	19	1	5
Reduct Vol:	0	0	0	0	0	0	0	0	0	0	0	0
Reduced Vol:	25	2673	53	8	576	4	0	1	8	19	1	5
PCE Adj:	1.00	1.00	1.00	1.00	1.00	1.00	1.00	1.00	1.00	1.00	1.00	1.00
MLF Adj:	1.00	1.00	1.00	1.00	1.00	1.00	1.00	1.00	1.00	1.00	1.00	1.00
FinalVolume:	25	2673	53	8	576	4	0	1	8	19	1	5
Saturation Flow Module:												
Sat/Lane:	1900	1900	1900	1900	1900	1900	1900	1900	1900	1900	1900	1900
Adjustment:	0.92	0.97	0.95	0.92	0.98	0.95	0.95	0.95	0.92	0.92	0.95	0.95
Lanes:	1.00	1.96	0.04	1.00	2.98	0.02	0.00	1.00	1.00	1.00	0.17	0.83
Final Sat.:	1750	3628	72	1750	5561	39	0	1800	1750	1750	300	1500
Capacity Analysis Module:												
Vol/Sat:	0.01	0.74	0.74	0.00	0.10	0.10	0.00	0.00	0.00	0.01	0.00	0.00
Crit Moves:	****			****						****		
Green Time:	39.4	114	114.0	7.0	81.6	81.6	0.0	10.0	10.0	10.0	10.0	10.0
Volume/Cap:	0.05	0.90	0.90	0.09	0.18	0.18	0.00	0.01	0.06	0.15	0.05	0.05
Delay/Veh:	36.7	13.5	13.5	63.9	13.6	13.6	0.0	60.4	60.9	61.6	60.7	60.7
User DelAdj:	1.00	1.00	1.00	1.00	1.00	1.00	1.00	1.00	1.00	1.00	1.00	1.00
AdjDel/Veh:	36.7	13.5	13.5	63.9	13.6	13.6	0.0	60.4	60.9	61.6	60.7	60.7
LOS by Move:	D	B	B	E	B	B	A	E	E	E	E	E
HCM2k95thQ:	2	70	70	1	7	7	0	0	1	2	1	1

Note: Queue reported is the number of cars per lane.

BART Phase II Extension Project

Level Of Service Computation Report
2000 HCM Operations (Future Volume Alternative)
PM - Existing Plus Project Conditions

Intersection #3411: AVIATION/COLEMAN

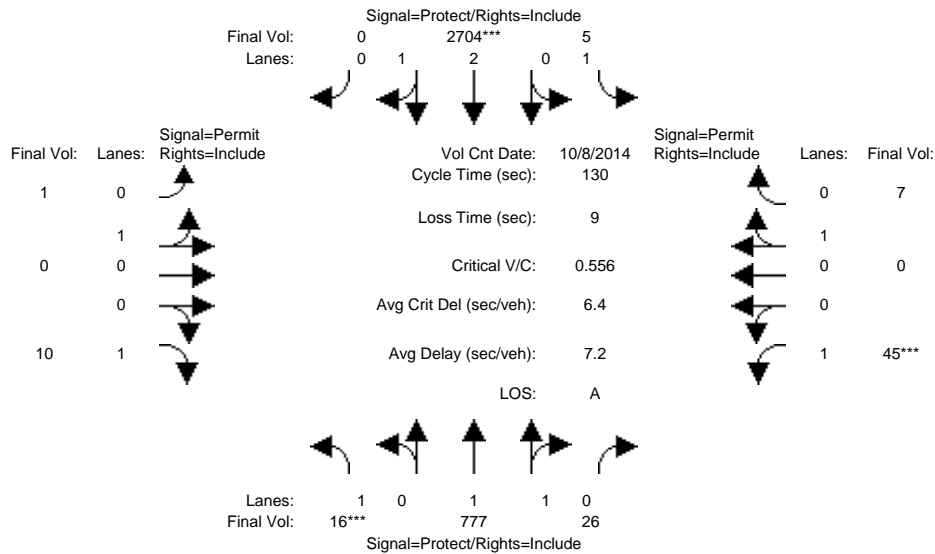

Approach:	North Bound			South Bound			East Bound			West Bound		
	L	T	R	L	T	R	L	T	R	L	T	R
Min. Green:	7	10	10	7	10	10	10	10	10	10	10	10
Y+R:	4.0	4.0	4.0	4.0	4.0	4.0	4.0	4.0	4.0	4.0	4.0	4.0

Volume Module:	>> Count Date: 8 Oct 2014 <<											
Base Vol:	16	777	26	5	2704	0	1	0	10	45	0	7
Growth Adj:	1.00	1.00	1.00	1.00	1.00	1.00	1.00	1.00	1.00	1.00	1.00	1.00
Initial Bse:	16	777	26	5	2704	0	1	0	10	45	0	7
Added Vol:	0	0	0	0	0	0	0	0	0	0	0	0
PasserByVol:	0	0	0	0	0	0	0	0	0	0	0	0
Initial Fut:	16	777	26	5	2704	0	1	0	10	45	0	7
User Adj:	1.00	1.00	1.00	1.00	1.00	1.00	1.00	1.00	1.00	1.00	1.00	1.00
PHF Adj:	1.00	1.00	1.00	1.00	1.00	1.00	1.00	1.00	1.00	1.00	1.00	1.00
PHF Volume:	16	777	26	5	2704	0	1	0	10	45	0	7
Reduct Vol:	0	0	0	0	0	0	0	0	0	0	0	0
Reduced Vol:	16	777	26	5	2704	0	1	0	10	45	0	7
PCE Adj:	1.00	1.00	1.00	1.00	1.00	1.00	1.00	1.00	1.00	1.00	1.00	1.00
MLF Adj:	1.00	1.00	1.00	1.00	1.00	1.00	1.00	1.00	1.00	1.00	1.00	1.00
FinalVolume:	16	777	26	5	2704	0	1	0	10	45	0	7

Saturation Flow Module:												
Sat/Lane:	1900	1900	1900	1900	1900	1900	1900	1900	1900	1900	1900	1900
Adjustment:	0.92	0.97	0.95	0.92	0.98	0.92	0.95	0.95	0.92	0.92	1.00	0.95
Lanes:	1.00	1.93	0.07	1.00	3.00	0.00	1.00	0.00	1.00	1.00	0.00	1.00
Final Sat.:	1750	3580	120	1750	5600	0	1800	0	1750	1750	0	1800

Capacity Analysis Module:												
Vol/Sat:	0.01	0.22	0.22	0.00	0.48	0.00	0.00	0.00	0.01	0.03	0.00	0.00
Crit Moves:	****				****					****		
Green Time:	7.0	88.9	88.9	22.1	104	0.0	10.0	0.0	10.0	10.0	0.0	10.0
Volume/Cap:	0.17	0.32	0.32	0.02	0.60	0.00	0.01	0.00	0.07	0.33	0.00	0.05
Delay/Veh:	59.6	8.4	8.4	45.0	5.3	0.0	55.4	0.0	55.9	58.3	0.0	55.8
User DelAdj:	1.00	1.00	1.00	1.00	1.00	1.00	1.00	1.00	1.00	1.00	1.00	1.00
AdjDel/Veh:	59.6	8.4	8.4	45.0	5.3	0.0	55.4	0.0	55.9	58.3	0.0	55.8
LOS by Move:	E	A	A	D	A	A	E	A	E	E	A	E
HCM2k95thQ:	1	12	12	0	23	0	0	0	1	4	0	1

Note: Queue reported is the number of cars per lane.

BART Phase II Extension Project

Level Of Service Computation Report
 2000 HCM Operations (Future Volume Alternative)
 AM - Existing Plus Project Conditions

Intersection #4047: COLEMAN/NEWHALL

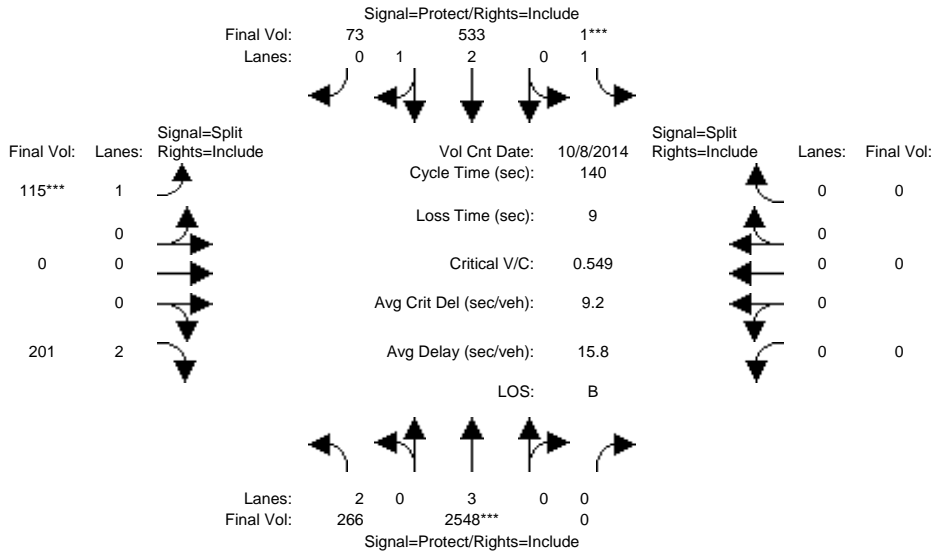

Approach:	North Bound			South Bound			East Bound			West Bound		
	L	T	R	L	T	R	L	T	R	L	T	R
Min. Green:	7	10	0	7	10	10	10	0	10	0	0	0
Y+R:	4.0	4.0	4.0	4.0	4.0	4.0	4.0	4.0	4.0	4.0	4.0	4.0
Volume Module: >> Count Date: 8 Oct 2014 <<												
Base Vol:	266	2548	0	1	533	73	115	0	201	0	0	0
Growth Adj:	1.00	1.00	1.00	1.00	1.00	1.00	1.00	1.00	1.00	1.00	1.00	1.00
Initial Bse:	266	2548	0	1	533	73	115	0	201	0	0	0
Added Vol:	0	0	0	0	0	0	0	0	0	0	0	0
PasserByVol:	0	0	0	0	0	0	0	0	0	0	0	0
Initial Fut:	266	2548	0	1	533	73	115	0	201	0	0	0
User Adj:	1.00	1.00	1.00	1.00	1.00	1.00	1.00	1.00	1.00	1.00	1.00	1.00
PHF Adj:	1.00	1.00	1.00	1.00	1.00	1.00	1.00	1.00	1.00	1.00	1.00	1.00
PHF Volume:	266	2548	0	1	533	73	115	0	201	0	0	0
Reduct Vol:	0	0	0	0	0	0	0	0	0	0	0	0
Reduced Vol:	266	2548	0	1	533	73	115	0	201	0	0	0
PCE Adj:	1.00	1.00	1.00	1.00	1.00	1.00	1.00	1.00	1.00	1.00	1.00	1.00
MLF Adj:	1.00	1.00	1.00	1.00	1.00	1.00	1.00	1.00	1.00	1.00	1.00	1.00
FinalVolume:	266	2548	0	1	533	73	115	0	201	0	0	0
Saturation Flow Module:												
Sat/Lane:	1900	1900	1900	1900	1900	1900	1900	1900	1900	1900	1900	1900
Adjustment:	0.83	1.00	0.92	0.92	0.99	0.95	0.92	1.00	0.83	0.92	1.00	0.92
Lanes:	2.00	3.00	0.00	1.00	2.63	0.37	1.00	0.00	2.00	0.00	0.00	0.00
Final Sat.:	3150	5700	0	1750	4925	674	1750	0	3150	0	0	0
Capacity Analysis Module:												
Vol/Sat:	0.08	0.45	0.00	0.00	0.11	0.11	0.07	0.00	0.06	0.00	0.00	0.00
Crit Moves:	****			****			****					
Green Time:	50.4	108	0.0	7.0	64.7	64.7	15.9	0.0	15.9	0.0	0.0	0.0
Volume/Cap:	0.23	0.58	0.00	0.01	0.23	0.23	0.58	0.00	0.56	0.00	0.00	0.00
Delay/Veh:	31.4	6.8	0.0	63.3	22.8	22.8	63.1	0.0	60.8	0.0	0.0	0.0
User DelAdj:	1.00	1.00	1.00	1.00	1.00	1.00	1.00	1.00	1.00	1.00	1.00	1.00
AdjDel/Veh:	31.4	6.8	0.0	63.3	22.8	22.8	63.1	0.0	60.8	0.0	0.0	0.0
LOS by Move:	C	A	A	E	C	C	E	A	E	A	A	A
HCM2k95thQ:	9	26	0	0	10	10	11	0	11	0	0	0

Note: Queue reported is the number of cars per lane.

BART Phase II Extension Project

Level Of Service Computation Report
 2000 HCM Operations (Future Volume Alternative)
 PM - Existing Plus Project Conditions

Intersection #4047: COLEMAN/NEWHALL

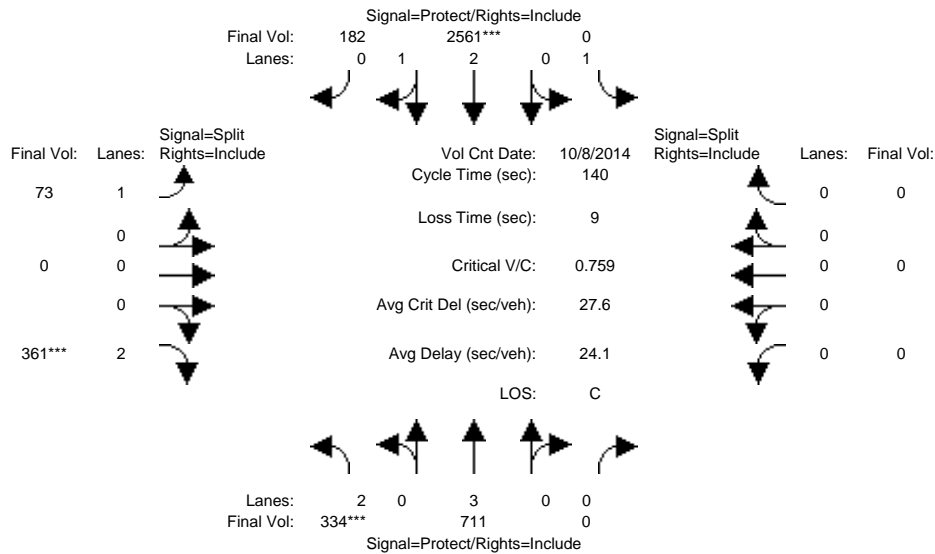

Approach:	North Bound			South Bound			East Bound			West Bound		
Movement:	L	T	R	L	T	R	L	T	R	L	T	R
Min. Green:	7	10	0	7	10	10	10	0	10	0	0	0
Y+R:	4.0	4.0	4.0	4.0	4.0	4.0	4.0	4.0	4.0	4.0	4.0	4.0
Volume Module: >> Count Date: 8 Oct 2014 <<												
Base Vol:	334	711	0	0	2561	182	73	0	361	0	0	0
Growth Adj:	1.00	1.00	1.00	1.00	1.00	1.00	1.00	1.00	1.00	1.00	1.00	1.00
Initial Bse:	334	711	0	0	2561	182	73	0	361	0	0	0
Added Vol:	0	0	0	0	0	0	0	0	0	0	0	0
PasserByVol:	0	0	0	0	0	0	0	0	0	0	0	0
Initial Fut:	334	711	0	0	2561	182	73	0	361	0	0	0
User Adj:	1.00	1.00	1.00	1.00	1.00	1.00	1.00	1.00	1.00	1.00	1.00	1.00
PHF Adj:	1.00	1.00	1.00	1.00	1.00	1.00	1.00	1.00	1.00	1.00	1.00	1.00
PHF Volume:	334	711	0	0	2561	182	73	0	361	0	0	0
Reduct Vol:	0	0	0	0	0	0	0	0	0	0	0	0
Reduced Vol:	334	711	0	0	2561	182	73	0	361	0	0	0
PCE Adj:	1.00	1.00	1.00	1.00	1.00	1.00	1.00	1.00	1.00	1.00	1.00	1.00
MLF Adj:	1.00	1.00	1.00	1.00	1.00	1.00	1.00	1.00	1.00	1.00	1.00	1.00
FinalVolume:	334	711	0	0	2561	182	73	0	361	0	0	0
Saturation Flow Module:												
Sat/Lane:	1900	1900	1900	1900	1900	1900	1900	1900	1900	1900	1900	1900
Adjustment:	0.83	1.00	0.92	0.92	0.98	0.95	0.92	1.00	0.83	0.92	1.00	0.92
Lanes:	2.00	3.00	0.00	1.00	2.79	0.21	1.00	0.00	2.00	0.00	0.00	0.00
Final Sat.:	3150	5700	0	1750	5228	372	1750	0	3150	0	0	0
Capacity Analysis Module:												
Vol/Sat:	0.11	0.12	0.00	0.00	0.49	0.49	0.04	0.00	0.11	0.00	0.00	0.00
Crit Moves:	****			****			****					
Green Time:	19.5	110	0.0	0.0	90.3	90.3	21.1	0.0	21.1	0.0	0.0	0.0
Volume/Cap:	0.76	0.16	0.00	0.00	0.76	0.76	0.28	0.00	0.76	0.00	0.00	0.00
Delay/Veh:	65.5	3.7	0.0	0.0	18.2	18.2	53.2	0.0	64.0	0.0	0.0	0.0
User DelAdj:	1.00	1.00	1.00	1.00	1.00	1.00	1.00	1.00	1.00	1.00	1.00	1.00
AdjDel/Veh:	65.5	3.7	0.0	0.0	18.2	18.2	53.2	0.0	64.0	0.0	0.0	0.0
LOS by Move:	E	A	A	A	B	B	D	A	E	A	A	A
HCM2k95thQ:	18	5	0	0	45	45	6	0	19	0	0	0

Note: Queue reported is the number of cars per lane.

BART Phase II Extension Project

Level Of Service Computation Report
 2000 HCM Operations (Future Volume Alternative)
 AM - Existing Plus Project Conditions

Intersection #5335: CENTRAL EXPWY/DE LA CRUZ BLVD

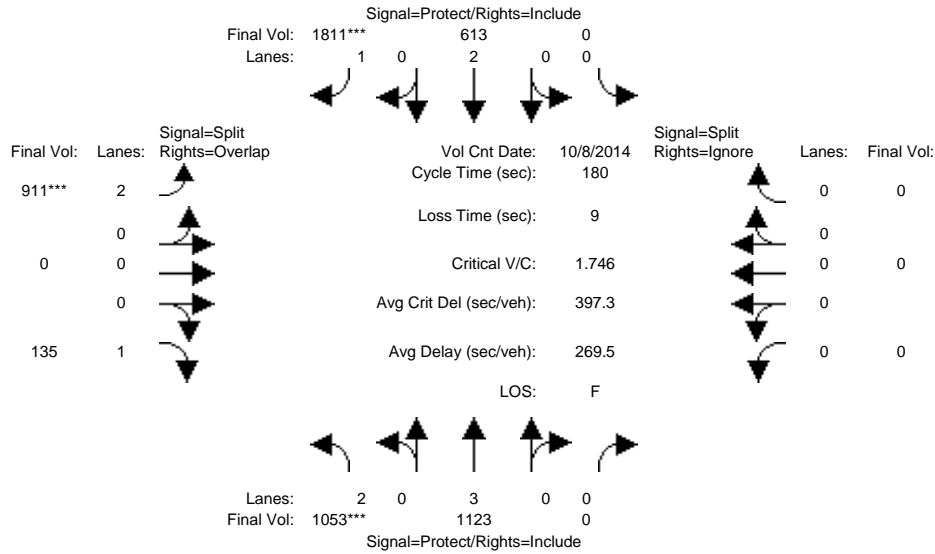

Approach:	North Bound			South Bound			East Bound			West Bound		
Movement:	L	T	R	L	T	R	L	T	R	L	T	R
Min. Green:	7	10	0	0	10	10	10	0	10	0	0	0
Y+R:	4.0	4.0	4.0	4.0	4.0	4.0	4.0	4.0	4.0	4.0	4.0	4.0
Volume Module: >> Count Date: 8 Oct 2014 <<												
Base Vol:	1053	1123	0	0	613	1811	1047	0	135	0	0	0
Growth Adj:	1.00	1.00	1.00	1.00	1.00	1.00	1.00	1.00	1.00	1.00	1.00	1.00
Initial Bse:	1053	1123	0	0	613	1811	1047	0	135	0	0	0
Added Vol:	0	0	0	0	0	0	0	0	0	0	0	0
PasserByVol:	0	0	0	0	0	0	0	0	0	0	0	0
Initial Fut:	1053	1123	0	0	613	1811	1047	0	135	0	0	0
User Adj:	1.00	1.00	1.00	1.00	1.00	1.00	0.87	1.00	1.00	1.00	1.00	0.00
PHF Adj:	1.00	1.00	1.00	1.00	1.00	1.00	1.00	1.00	1.00	1.00	1.00	0.00
PHF Volume:	1053	1123	0	0	613	1811	911	0	135	0	0	0
Reduct Vol:	0	0	0	0	0	0	0	0	0	0	0	0
Reduced Vol:	1053	1123	0	0	613	1811	911	0	135	0	0	0
PCE Adj:	1.00	1.00	1.00	1.00	1.00	1.00	1.00	1.00	1.00	1.00	1.00	0.00
MLF Adj:	1.00	1.00	1.00	1.00	1.00	1.00	1.00	1.00	1.00	1.00	1.00	0.00
FinalVolume:	1053	1123	0	0	613	1811	911	0	135	0	0	0
Saturation Flow Module:												
Sat/Lane:	1900	1900	1900	1900	1900	1900	1900	1900	1900	1900	1900	1900
Adjustment:	0.83	1.00	0.92	0.92	1.00	0.92	0.83	1.00	0.92	0.92	1.00	0.92
Lanes:	2.00	3.00	0.00	0.00	2.00	1.00	2.00	0.00	1.00	0.00	0.00	0.00
Final Sat.:	3150	5700	0	0	3800	1750	3150	0	1750	0	0	0
Capacity Analysis Module:												
Vol/Sat:	0.33	0.20	0.00	0.00	0.16	1.03	0.29	0.00	0.08	0.00	0.00	0.00
Crit Moves:	****					****	****					
Green Time:	34.5	141	0.0	0.0	107	106.7	29.8	0.0	64.3	0.0	0.0	0.0
Volume/Cap:	1.75	0.25	0.00	0.00	0.27	1.75	1.75	0.00	0.22	0.00	0.00	0.00
Delay/Veh:	415.1	5.2	0.0	0.0	17.9	376.2	418.5	0.0	37.9	0.0	0.0	0.0
User DelAdj:	1.00	1.00	1.00	1.00	1.00	1.00	1.00	1.00	1.00	1.00	1.00	1.00
AdjDel/Veh:	415.1	5.2	0.0	0.0	17.9	376.2	418.5	0.0	37.9	0.0	0.0	0.0
LOS by Move:	F	A	A	A	B	F	F	A	D	A	A	A
HCM2k95thQ:	101	11	0	0	15	309	88	0	9	0	0	0

Note: Queue reported is the number of cars per lane.

BART Phase II Extension Project

Level Of Service Computation Report
 2000 HCM Operations (Future Volume Alternative)
 PM - Existing Plus Project Conditions

Intersection #5335: CENTRAL EXPWY/DE LA CRUZ BLVD

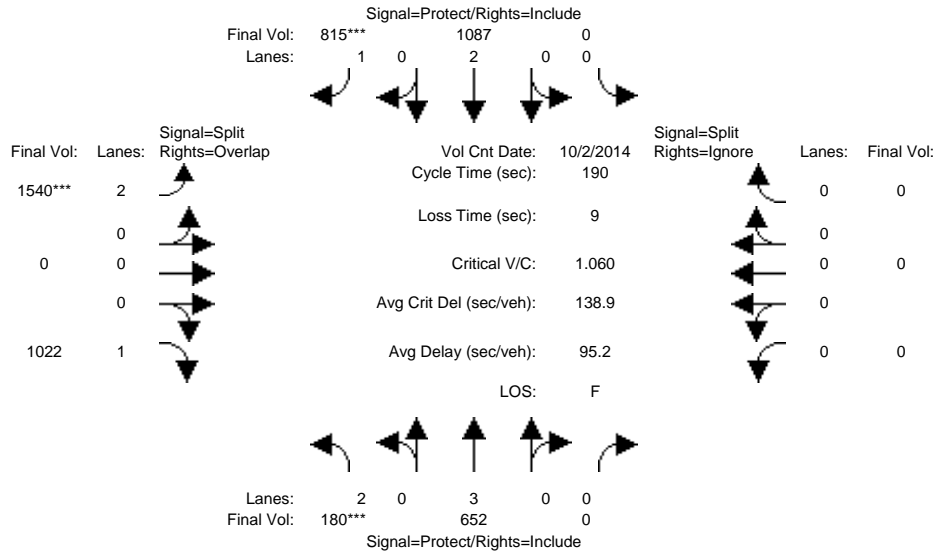

Approach:	North Bound			South Bound			East Bound			West Bound		
Movement:	L	T	R	L	T	R	L	T	R	L	T	R
Min. Green:	19	76	0	0	57	57	114	0	114	0	0	0
Y+R:	4.0	4.0	4.0	4.0	4.0	4.0	4.0	4.0	4.0	4.0	4.0	4.0
Volume Module: >> Count Date: 2 Oct 2014 <<												
Base Vol:	180	652	0	0	1087	815	2081	0	1022	0	0	0
Growth Adj:	1.00	1.00	1.00	1.00	1.00	1.00	1.00	1.00	1.00	1.00	1.00	1.00
Initial Bse:	180	652	0	0	1087	815	2081	0	1022	0	0	0
Added Vol:	0	0	0	0	0	0	0	0	0	0	0	0
PasserByVol:	0	0	0	0	0	0	0	0	0	0	0	0
Initial Fut:	180	652	0	0	1087	815	2081	0	1022	0	0	0
User Adj:	1.00	1.00	1.00	1.00	1.00	1.00	0.74	1.00	1.00	1.00	1.00	0.00
PHF Adj:	1.00	1.00	1.00	1.00	1.00	1.00	1.00	1.00	1.00	1.00	1.00	0.00
PHF Volume:	180	652	0	0	1087	815	1540	0	1022	0	0	0
Reduct Vol:	0	0	0	0	0	0	0	0	0	0	0	0
Reduced Vol:	180	652	0	0	1087	815	1540	0	1022	0	0	0
PCE Adj:	1.00	1.00	1.00	1.00	1.00	1.00	1.00	1.00	1.00	1.00	1.00	0.00
MLF Adj:	1.00	1.00	1.00	1.00	1.00	1.00	1.00	1.00	1.00	1.00	1.00	0.00
FinalVolume:	180	652	0	0	1087	815	1540	0	1022	0	0	0
Saturation Flow Module:												
Sat/Lane:	1900	1900	1900	1900	1900	1900	1900	1900	1900	1900	1900	1900
Adjustment:	0.83	1.00	0.92	0.92	1.00	0.92	0.83	1.00	0.92	0.92	1.00	0.92
Lanes:	2.00	3.00	0.00	0.00	2.00	1.00	2.00	0.00	1.00	0.00	0.00	0.00
Final Sat.:	3150	5700	0	0	3800	1750	3150	0	1750	0	0	0
Capacity Analysis Module:												
Vol/Sat:	0.06	0.11	0.00	0.00	0.29	0.47	0.49	0.00	0.58	0.00	0.00	0.00
Crit Moves:	****				****	****	****					
Green Time:	18.1	72.6	0.0	0.0	54.4	54.4	108.8	0.0	127.0	0.0	0.0	0.0
Volume/Cap:	0.60	0.30	0.00	0.00	1.00	1.63	0.85	0.00	0.87	0.00	0.00	0.00
Delay/Veh:	89.6	43.0	0.0	0.0	97.9	361.7	26.8	0.0	17.4	0.0	0.0	0.0
User DelAdj:	1.00	1.00	1.00	1.00	1.00	1.00	1.00	1.00	1.00	1.00	1.00	1.00
AdjDel/Veh:	89.6	43.0	0.0	0.0	97.9	361.7	26.8	0.0	17.4	0.0	0.0	0.0
LOS by Move:	F	D	A	A	F	F	C	A	B	A	A	A
HCM2k95thQ:	12	16	0	0	59	140	62	0	58	0	0	0

Note: Queue reported is the number of cars per lane.

BART Phase II Extension Project

Level Of Service Computation Report
 2000 HCM Operations (Future Volume Alternative)
 AM - Existing Plus Project Conditions

Intersection #5416: SAN TOMAS EXPWY/EL CAMINO REAL

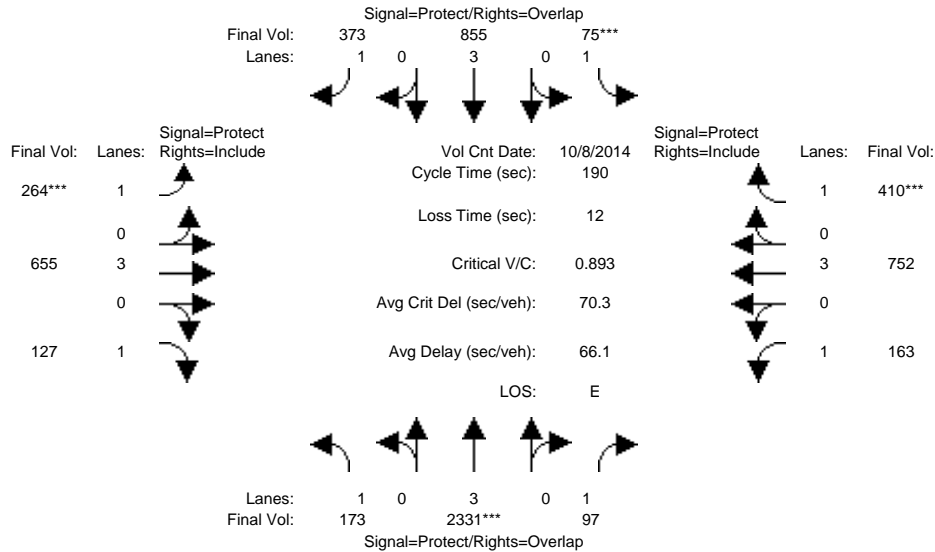

Approach:	North Bound			South Bound			East Bound			West Bound		
	L	T	R	L	T	R	L	T	R	L	T	R
Min. Green:	7	10	10	7	10	10	7	10	10	7	10	10
Y+R:	4.0	4.0	4.0	4.0	4.0	4.0	4.0	4.0	4.0	4.0	4.0	4.0
Volume Module: >> Count Date: 8 Oct 2014 <<												
Base Vol:	173	2775	97	75	1018	373	264	655	127	163	752	410
Growth Adj:	1.00	1.00	1.00	1.00	1.00	1.00	1.00	1.00	1.00	1.00	1.00	1.00
Initial Bse:	173	2775	97	75	1018	373	264	655	127	163	752	410
Added Vol:	0	0	0	0	0	0	0	0	0	0	0	0
PasserByVol:	0	0	0	0	0	0	0	0	0	0	0	0
Initial Fut:	173	2775	97	75	1018	373	264	655	127	163	752	410
User Adj:	1.00	0.84	1.00	1.00	0.84	1.00	1.00	1.00	1.00	1.00	1.00	1.00
PHF Adj:	1.00	1.00	1.00	1.00	1.00	1.00	1.00	1.00	1.00	1.00	1.00	1.00
PHF Volume:	173	2331	97	75	855	373	264	655	127	163	752	410
Reduct Vol:	0	0	0	0	0	0	0	0	0	0	0	0
Reduced Vol:	173	2331	97	75	855	373	264	655	127	163	752	410
PCE Adj:	1.00	1.00	1.00	1.00	1.00	1.00	1.00	1.00	1.00	1.00	1.00	1.00
MLF Adj:	1.00	1.00	1.00	1.00	1.00	1.00	1.00	1.00	1.00	1.00	1.00	1.00
FinalVolume:	173	2331	97	75	855	373	264	655	127	163	752	410
Saturation Flow Module:												
Sat/Lane:	1900	1900	1900	1900	1900	1900	1900	1900	1900	1900	1900	1900
Adjustment:	0.92	1.00	0.92	0.92	1.00	0.92	0.92	1.00	0.92	0.92	1.00	0.92
Lanes:	1.00	3.00	1.00	1.00	3.00	1.00	1.00	3.00	1.00	1.00	3.00	1.00
Final Sat.:	1750	5700	1750	1750	5700	1750	1750	5700	1750	1750	5700	1750
Capacity Analysis Module:												
Vol/Sat:	0.10	0.41	0.06	0.04	0.15	0.21	0.15	0.11	0.07	0.09	0.13	0.23
Crit Moves:	****			****			****			****		
Green Time:	38.2	87.0	123.6	9.1	57.9	90.0	32.1	45.2	45.2	36.7	49.8	49.8
Volume/Cap:	0.49	0.89	0.09	0.89	0.49	0.45	0.89	0.48	0.30	0.48	0.50	0.89
Delay/Veh:	68.9	60.7	18.5	156.9	70.0	53.9	104.3	62.6	59.9	69.3	59.8	86.9
User DelAdj:	1.00	1.00	1.00	1.00	1.00	1.00	1.00	1.00	1.00	1.00	1.00	1.00
AdjDel/Veh:	68.9	60.7	18.5	156.9	70.0	53.9	104.3	62.6	59.9	69.3	59.8	86.9
LOS by Move:	E	E	B	F	E	D	F	E	E	E	E	F
HCM2k95thQ:	18	69	7	11	26	34	33	20	12	17	22	43

Note: Queue reported is the number of cars per lane.

BART Phase II Extension Project

Level Of Service Computation Report
 2000 HCM Operations (Future Volume Alternative)
 PM - Existing Plus Project Conditions

Intersection #5416: SAN TOMAS EXPWY/EL CAMINO REAL

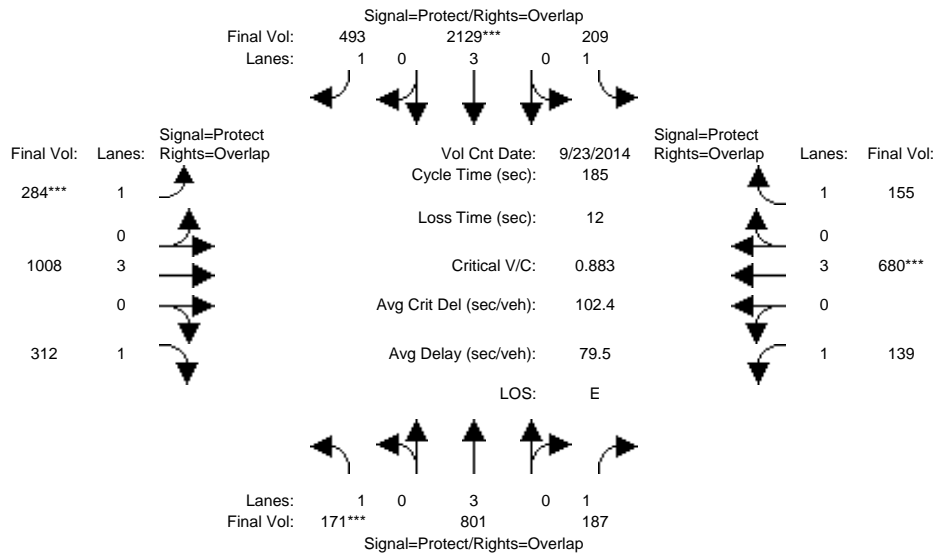

Approach:	North Bound			South Bound			East Bound			West Bound		
Movement:	L	T	R	L	T	R	L	T	R	L	T	R
Min. Green:	12	72	72	33	93	93	39	50	50	29	41	41
Y+R:	4.0	4.0	4.0	4.0	4.0	4.0	4.0	4.0	4.0	4.0	4.0	4.0
Volume Module: >> Count Date: 23 Sep 2014 <<												
Base Vol:	171	1054	187	209	2765	493	284	1008	312	139	680	155
Growth Adj:	1.00	1.00	1.00	1.00	1.00	1.00	1.00	1.00	1.00	1.00	1.00	1.00
Initial Bse:	171	1054	187	209	2765	493	284	1008	312	139	680	155
Added Vol:	0	0	0	0	0	0	0	0	0	0	0	0
PasserByVol:	0	0	0	0	0	0	0	0	0	0	0	0
Initial Fut:	171	1054	187	209	2765	493	284	1008	312	139	680	155
User Adj:	1.00	0.76	1.00	1.00	0.77	1.00	1.00	1.00	1.00	1.00	1.00	1.00
PHF Adj:	1.00	1.00	1.00	1.00	1.00	1.00	1.00	1.00	1.00	1.00	1.00	1.00
PHF Volume:	171	801	187	209	2129	493	284	1008	312	139	680	155
Reduct Vol:	0	0	0	0	0	0	0	0	0	0	0	0
Reduced Vol:	171	801	187	209	2129	493	284	1008	312	139	680	155
PCE Adj:	1.00	1.00	1.00	1.00	1.00	1.00	1.00	1.00	1.00	1.00	1.00	1.00
MLF Adj:	1.00	1.00	1.00	1.00	1.00	1.00	1.00	1.00	1.00	1.00	1.00	1.00
FinalVolume:	171	801	187	209	2129	493	284	1008	312	139	680	155
Saturation Flow Module:												
Sat/Lane:	1900	1900	1900	1900	1900	1900	1900	1900	1900	1900	1900	1900
Adjustment:	0.92	1.00	0.92	0.92	0.83	0.92	0.92	1.00	0.92	0.92	1.00	0.92
Lanes:	1.00	3.00	1.00	1.00	3.00	1.00	1.00	3.00	1.00	1.00	3.00	1.00
Final Sat.:	1750	5700	1750	1750	4731	1750	1750	5700	1750	1750	5700	1750
Capacity Analysis Module:												
Vol/Sat:	0.10	0.14	0.11	0.12	0.45	0.28	0.16	0.18	0.18	0.08	0.12	0.09
Crit Moves:	****				****		****				****	
Green Time:	11.3	67.6	95.2	31.0	87.3	124.0	36.6	47.5	58.8	27.6	38.5	69.5
Volume/Cap:	1.60	0.38	0.21	0.71	0.95	0.42	0.82	0.69	0.56	0.53	0.57	0.24
Delay/Veh:	403.6	51.3	32.8	95.9	89.9	35.4	89.9	67.5	57.1	79.6	70.8	42.3
User DelAdj:	1.00	1.00	1.00	1.00	1.00	1.00	1.00	1.00	1.00	1.00	1.00	1.00
AdjDel/Veh:	403.6	51.3	32.8	95.9	89.9	35.4	89.9	67.5	57.1	79.6	70.8	42.3
LOS by Move:	F	D	C	F	F	D	F	E	E	E	E	D
HCM2k95thQ:	33	23	15	24	71	43	33	32	29	15	22	13

Note: Queue reported is the number of cars per lane.

BART Phase II Extension Project

Level Of Service Computation Report
2000 HCM Operations (Future Volume Alternative)
AM - Existing Plus Project Conditions

Intersection #5444: Lafayette/Lewis

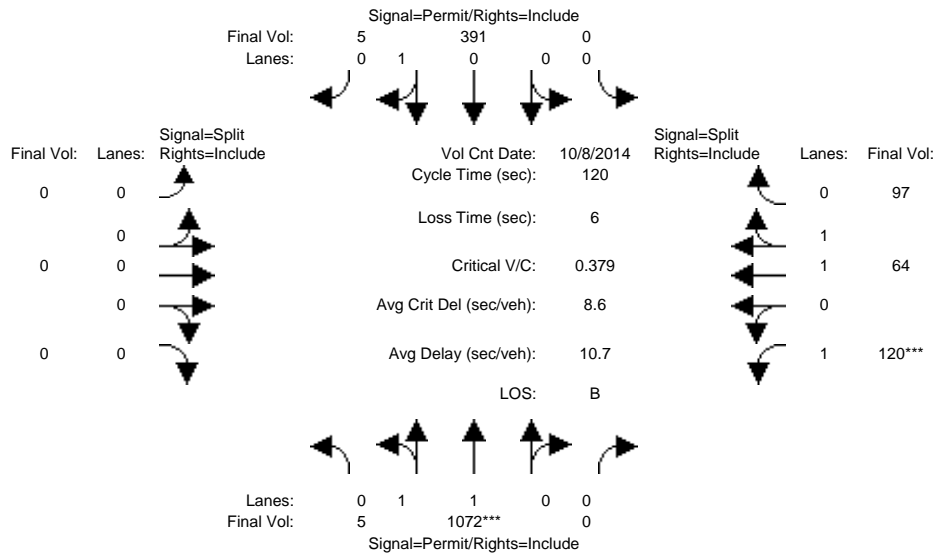

Approach:	North Bound			South Bound			East Bound			West Bound		
	L	T	R	L	T	R	L	T	R	L	T	R
Min. Green:	10	10	0	0	10	10	0	0	0	10	10	10
Y+R:	4.0	4.0	4.0	4.0	4.0	4.0	4.0	4.0	4.0	4.0	4.0	4.0

Volume Module:	>>	Count	Date:	8 Oct 2014	<<							
Base Vol:	5	1072	0	0	391	5	0	0	0	120	64	97
Growth Adj:	1.00	1.00	1.00	1.00	1.00	1.00	1.00	1.00	1.00	1.00	1.00	1.00
Initial Bse:	5	1072	0	0	391	5	0	0	0	120	64	97
Added Vol:	0	0	0	0	0	0	0	0	0	0	0	0
PasserByVol:	0	0	0	0	0	0	0	0	0	0	0	0
Initial Fut:	5	1072	0	0	391	5	0	0	0	120	64	97
User Adj:	1.00	1.00	1.00	1.00	1.00	1.00	1.00	1.00	1.00	1.00	1.00	1.00
PHF Adj:	1.00	1.00	1.00	1.00	1.00	1.00	1.00	1.00	1.00	1.00	1.00	1.00
PHF Volume:	5	1072	0	0	391	5	0	0	0	120	64	97
Reduct Vol:	0	0	0	0	0	0	0	0	0	0	0	0
Reduced Vol:	5	1072	0	0	391	5	0	0	0	120	64	97
PCE Adj:	1.00	1.00	1.00	1.00	1.00	1.00	1.00	1.00	1.00	1.00	1.00	1.00
MLF Adj:	1.00	1.00	1.00	1.00	1.00	1.00	1.00	1.00	1.00	1.00	1.00	1.00
FinalVolume:	5	1072	0	0	391	5	0	0	0	120	64	97

Saturation Flow Module:	North Bound			South Bound			East Bound			West Bound		
Sat/Lane:	1900	1900	1900	1900	1900	1900	1900	1900	1900	1900	1900	1900
Adjustment:	0.95	0.97	0.92	0.92	0.95	0.95	0.92	1.00	0.92	0.92	1.00	0.92
Lanes:	0.01	1.99	0.00	0.00	0.99	0.01	0.00	0.00	0.00	1.00	1.00	1.00
Final Sat.:	17	3683	0	0	1777	23	0	0	0	1750	1900	1750

Capacity Analysis Module:	North Bound			South Bound			East Bound			West Bound		
Vol/Sat:	0.29	0.29	0.00	0.00	0.22	0.22	0.00	0.00	0.00	0.07	0.03	0.06
Crit Moves:	****						****					
Green Time:	92.3	92.3	0.0	0.0	92.3	92.3	0.0	0.0	0.0	21.7	21.7	21.7
Volume/Cap:	0.38	0.38	0.00	0.00	0.29	0.29	0.00	0.00	0.00	0.38	0.19	0.31
Delay/Veh:	4.6	4.6	0.0	0.0	4.2	4.2	0.0	0.0	0.0	44.0	41.7	42.9
User DelAdj:	1.00	1.00	1.00	1.00	1.00	1.00	1.00	1.00	1.00	1.00	1.00	1.00
AdjDel/Veh:	4.6	4.6	0.0	0.0	4.2	4.2	0.0	0.0	0.0	44.0	41.7	42.9
LOS by Move:	A	A	A	A	A	A	A	A	A	D	D	D
HCM2k95thQ:	12	12	0	0	9	9	0	0	0	9	4	7

Note: Queue reported is the number of cars per lane.

BART Phase II Extension Project

Level Of Service Computation Report
 2000 HCM Operations (Future Volume Alternative)
 PM - Existing Plus Project Conditions

Intersection #5444: Lafayette/Lewis

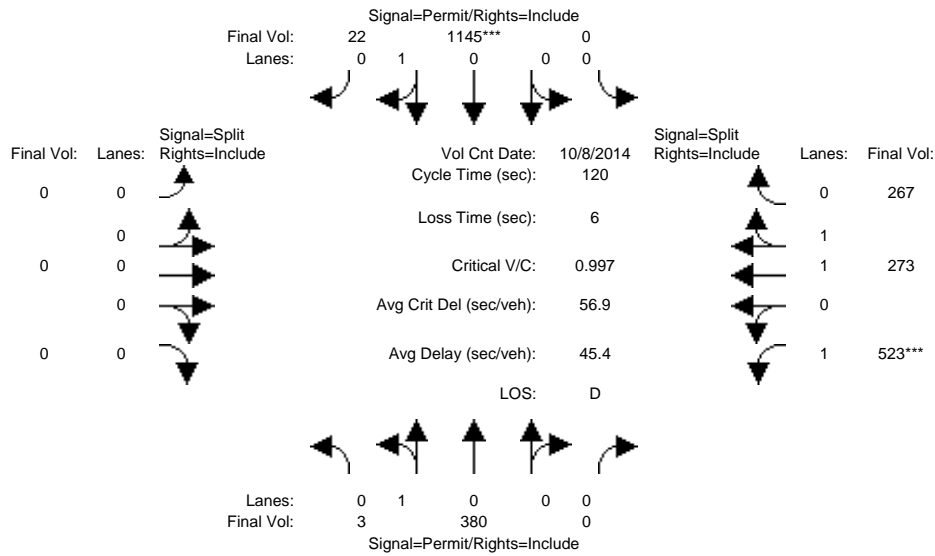

Approach:	North Bound			South Bound			East Bound			West Bound		
	L	T	R	L	T	R	L	T	R	L	T	R
Min. Green:	10	10	0	0	10	10	0	0	0	10	10	10
Y+R:	4.0	4.0	4.0	4.0	4.0	4.0	4.0	4.0	4.0	4.0	4.0	4.0

Volume Module:	>>	Count	Date:	8 Oct 2014	<<							
Base Vol:	3	380	0	0	1145	22	0	0	0	523	273	267
Growth Adj:	1.00	1.00	1.00	1.00	1.00	1.00	1.00	1.00	1.00	1.00	1.00	1.00
Initial Bse:	3	380	0	0	1145	22	0	0	0	523	273	267
Added Vol:	0	0	0	0	0	0	0	0	0	0	0	0
PasserByVol:	0	0	0	0	0	0	0	0	0	0	0	0
Initial Fut:	3	380	0	0	1145	22	0	0	0	523	273	267
User Adj:	1.00	1.00	1.00	1.00	1.00	1.00	1.00	1.00	1.00	1.00	1.00	1.00
PHF Adj:	1.00	1.00	1.00	1.00	1.00	1.00	1.00	1.00	1.00	1.00	1.00	1.00
PHF Volume:	3	380	0	0	1145	22	0	0	0	523	273	267
Reduct Vol:	0	0	0	0	0	0	0	0	0	0	0	0
Reduced Vol:	3	380	0	0	1145	22	0	0	0	523	273	267
PCE Adj:	1.00	1.00	1.00	1.00	1.00	1.00	1.00	1.00	1.00	1.00	1.00	1.00
MLF Adj:	1.00	1.00	1.00	1.00	1.00	1.00	1.00	1.00	1.00	1.00	1.00	1.00
FinalVolume:	3	380	0	0	1145	22	0	0	0	523	273	267

Saturation Flow Module:	Sat/Lane:	1900	1900	1900	1900	1900	1900	1900	1900	1900	1900	1900
Adjustment:	0.95	0.95	0.92	0.92	0.95	0.95	0.92	1.00	0.92	0.92	1.00	0.95
Lanes:	0.01	0.99	0.00	0.00	0.98	0.02	0.00	0.00	0.00	1.00	1.00	1.00
Final Sat.:	14	1786	0	0	1766	34	0	0	0	1750	1899	1800

Capacity Analysis Module:	Vol/Sat:	0.21	0.21	0.00	0.00	0.65	0.65	0.00	0.00	0.00	0.30	0.14	0.15
Crit Moves:					****						****		
Green Time:	78.0	78.0	0.0	0.0	78.0	78.0	0.0	0.0	0.0	36.0	36.0	36.0	
Volume/Cap:	0.33	0.33	0.00	0.00	1.00	1.00	0.00	0.00	0.00	1.00	0.48	0.49	
Delay/Veh:	9.5	9.5	0.0	0.0	46.4	46.4	0.0	0.0	0.0	80.4	34.7	34.9	
User DelAdj:	1.00	1.00	1.00	1.00	1.00	1.00	1.00	1.00	1.00	1.00	1.00	1.00	
AdjDel/Veh:	9.5	9.5	0.0	0.0	46.4	46.4	0.0	0.0	0.0	80.4	34.7	34.9	
LOS by Move:	A	A	A	A	D	D	A	A	A	F	C	C	
HCM2k95thQ:	12	12	0	0	77	77	0	0	0	44	16	16	

Note: Queue reported is the number of cars per lane.

Appendix C
Traffic Count Data

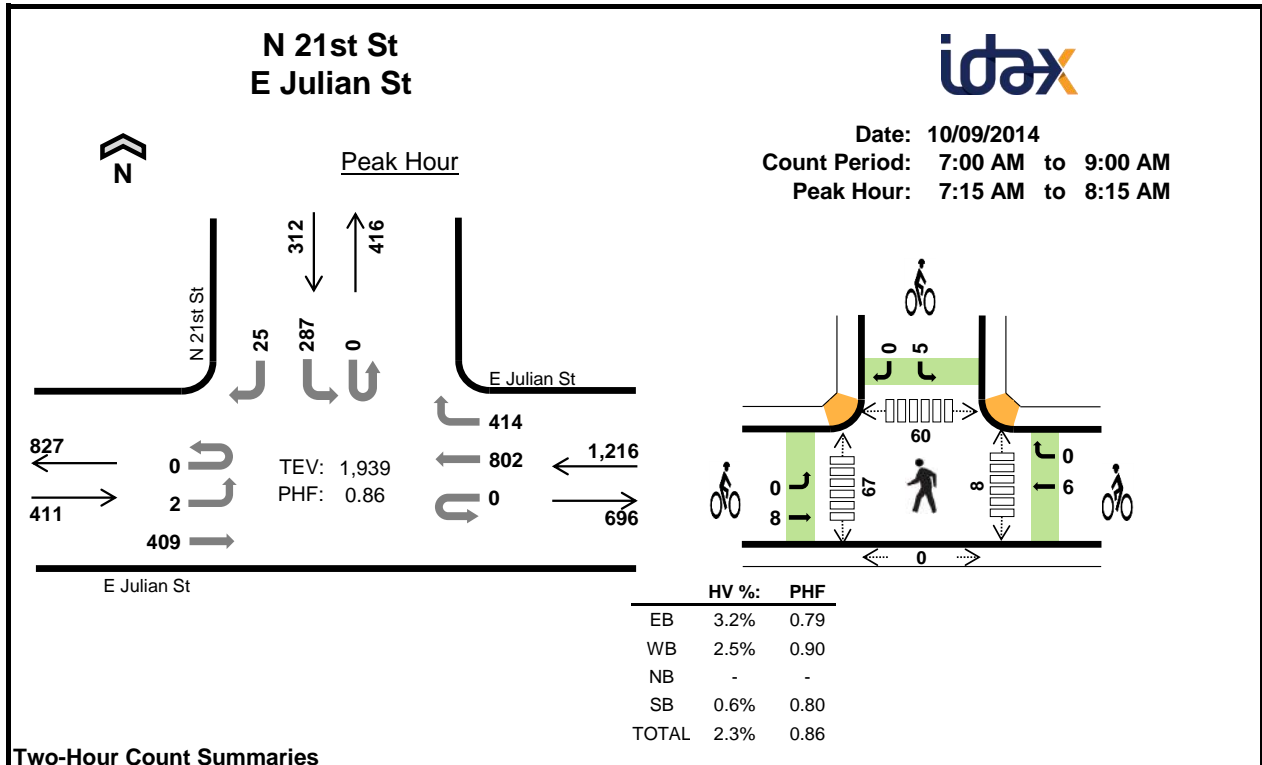

Two-Hour Count Summaries

Interval Start	E Julian St Eastbound				E Julian St Westbound				0 Northbound				N 21st St Southbound				15-min Total	Rolling One Hour	
	UT	LT	TH	RT	UT	LT	TH	RT	UT	LT	TH	RT	UT	LT	TH	RT			
7:00 AM	0	2	56	0	0	0	127	44	0	0	0	0	0	36	0	5	270	0	
7:15 AM	0	0	88	0	0	0	205	85	0	0	0	0	0	34	0	4	416	0	
7:30 AM	0	0	108	0	0	0	203	127	0	0	0	0	0	86	0	7	531	0	
7:45 AM	0	1	129	0	0	0	204	134	0	0	0	0	0	88	0	10	566	1,783	
8:00 AM	0	1	84	0	0	0	190	68	0	0	0	0	0	79	0	4	426	1,939	
8:15 AM	0	1	76	0	0	0	164	52	0	0	0	0	0	23	0	6	322	1,845	
8:30 AM	0	0	73	0	0	0	202	57	0	0	0	0	0	22	0	4	358	1,672	
8:45 AM	0	0	82	0	0	0	189	46	0	0	0	0	0	29	0	3	349	1,455	
Count Total	0	5	696	0	0	0	1484	613	0	0	0	0	0	397	0	43	3,238	0	
Peak Hour	All	0	2	409	0	0	0	802	414	0	0	0	0	0	287	0	25	1,939	0
	HV	0	0	13	0	0	0	24	6	0	0	0	0	0	1	0	1	45	0
	HV%	-	0%	3%	-	-	-	3%	1%	-	-	-	-	-	0%	-	4%	2%	0

Note: Two-hour count summary volumes include heavy vehicles but exclude bicycles in overall count.

Interval Start	Heavy Vehicle Totals					Bicycles					Pedestrians (Crossing Leg)				
	EB	WB	NB	SB	Total	EB	WB	NB	SB	Total	East	West	North	South	Total
7:00 AM	1	4	0	0	5	2	0	0	0	2	2	3	0	0	5
7:15 AM	4	7	0	0	11	1	2	0	1	4	1	14	4	0	19
7:30 AM	3	13	0	1	17	3	1	0	4	8	3	15	23	0	41
7:45 AM	2	5	0	1	8	2	0	0	0	2	1	34	26	0	61
8:00 AM	4	5	0	0	9	2	3	0	0	5	3	4	7	0	14
8:15 AM	2	6	0	1	9	0	1	0	0	1	1	1	2	0	4
8:30 AM	2	4	0	0	6	0	2	0	1	3	0	1	1	0	2
8:45 AM	2	3	0	0	5	1	4	0	0	5	1	1	3	0	5
Count Total	20	47	0	3	70	11	13	0	6	30	12	73	66	0	151
Peak Hr	13	30	0	2	45	8	6	0	5	19	8	67	60	0	135

Two-Hour Count Summaries - Heavy Vehicles														15-min Total	Rolling One Hour			
Interval Start	E Julian St				E Julian St				0				N 21st St					
	Eastbound				Westbound				Northbound				Southbound					
	UT	LT	TH	RT	UT	LT	TH	RT	UT	LT	TH	RT	UT	LT	TH	RT		
7:00 AM	0	0	1	0	0	0	3	1	0	0	0	0	0	0	0	0	5	0
7:15 AM	0	0	4	0	0	0	6	1	0	0	0	0	0	0	0	0	11	0
7:30 AM	0	0	3	0	0	0	11	2	0	0	0	0	0	1	0	0	17	0
7:45 AM	0	0	2	0	0	0	3	2	0	0	0	0	0	0	0	1	8	41
8:00 AM	0	0	4	0	0	0	4	1	0	0	0	0	0	0	0	0	9	45
8:15 AM	0	0	2	0	0	0	5	1	0	0	0	0	0	0	0	1	9	43
8:30 AM	0	0	2	0	0	0	2	2	0	0	0	0	0	0	0	0	6	32
8:45 AM	0	0	2	0	0	0	3	0	0	0	0	0	0	0	0	0	5	29
Count Total	0	0	20	0	0	0	37	10	0	0	0	0	0	1	0	2	70	0
Peak Hour	0	0	13	0	0	0	24	6	0	0	0	0	0	1	0	1	45	0

Two-Hour Count Summaries - Bikes														15-min Total	Rolling One Hour
Interval Start	E Julian St			E Julian St			0			N 21st St					
	Eastbound			Westbound			Northbound			Southbound					
	LT	TH	RT	LT	TH	RT	LT	TH	RT	LT	TH	RT			
7:00 AM	0	2	0	0	0	0	0	0	0	0	0	0	2	0	
7:15 AM	0	1	0	0	2	0	0	0	0	1	0	0	4	0	
7:30 AM	0	3	0	0	1	0	0	0	0	4	0	0	8	0	
7:45 AM	0	2	0	0	0	0	0	0	0	0	0	0	2	16	
8:00 AM	0	2	0	0	3	0	0	0	0	0	0	0	5	19	
8:15 AM	0	0	0	0	0	1	0	0	0	0	0	0	1	16	
8:30 AM	0	0	0	0	2	0	0	0	0	1	0	0	3	11	
8:45 AM	0	1	0	0	4	0	0	0	0	0	0	0	5	14	
Count Total	0	11	0	0	12	1	0	0	0	6	0	0	30	0	
Peak Hour	0	8	0	0	6	0	0	0	0	5	0	0	19	0	

Note: U-Turn volumes for bikes are included in Left-Turn, if any.

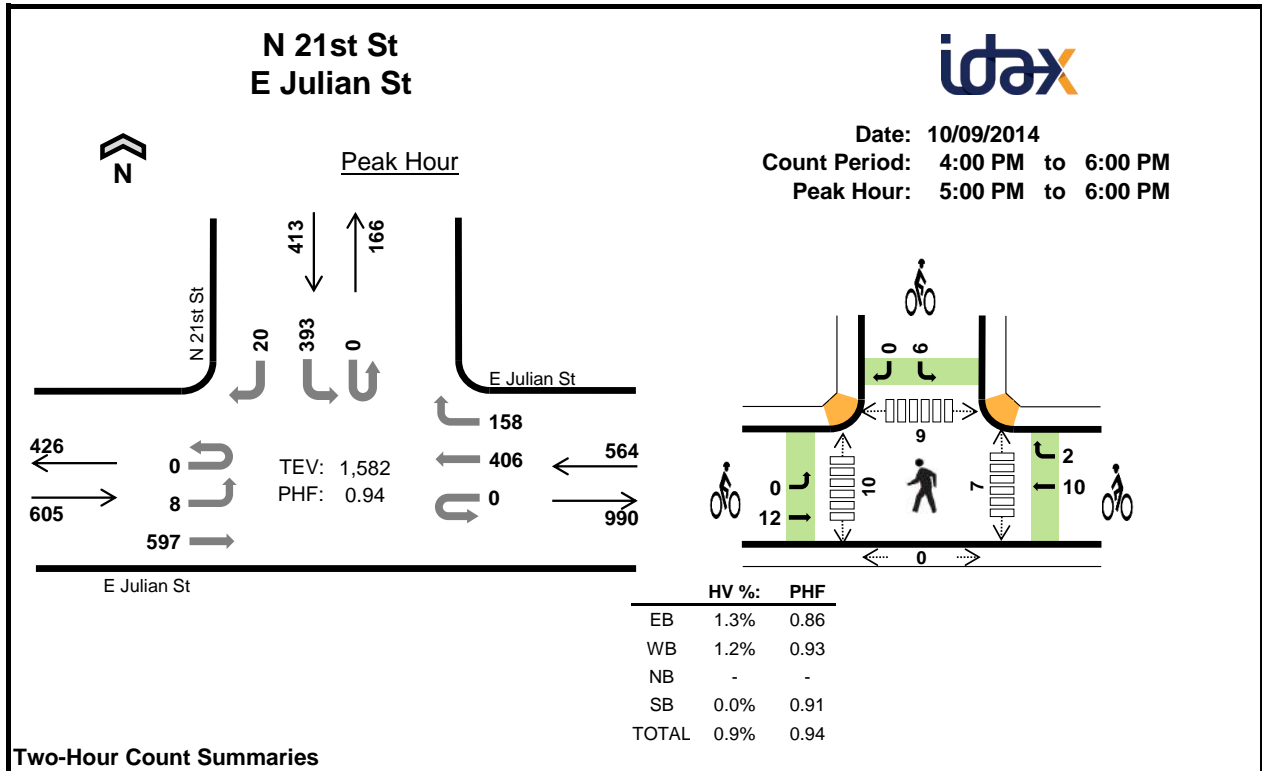

Two-Hour Count Summaries

Interval Start	E Julian St Eastbound				E Julian St Westbound				0 Northbound				N 21st St Southbound				15-min Total	Rolling One Hour
	UT	LT	TH	RT	UT	LT	TH	RT	UT	LT	TH	RT	UT	LT	TH	RT		
4:00 PM	0	3	129	0	0	0	107	31	0	0	0	0	0	67	0	2	339	0
4:15 PM	0	1	137	0	0	0	85	39	0	0	0	0	0	77	0	1	340	0
4:30 PM	0	4	138	0	0	0	99	42	0	0	0	0	0	84	0	6	373	0
4:45 PM	0	1	139	0	0	0	103	35	0	0	0	0	0	78	0	2	358	1,410
5:00 PM	0	4	148	0	0	0	97	42	0	0	0	0	0	92	0	4	387	1,458
5:15 PM	0	1	175	0	0	0	110	40	0	0	0	0	0	91	0	5	422	1,540
5:30 PM	0	2	135	0	0	0	97	26	0	0	0	0	0	104	0	3	367	1,534
5:45 PM	0	1	139	0	0	0	102	50	0	0	0	0	0	106	0	8	406	1,582
Count Total	0	17	1140	0	0	0	800	305	0	0	0	0	0	699	0	31	2,992	0
Peak Hour	All	0	8	597	0	0	406	158	0	0	0	0	0	393	0	20	1,582	0
	HV	0	0	8	0	0	0	7	0	0	0	0	0	0	0	0	15	0
	HV%	-	0%	1%	-	-	-	2%	0%	-	-	-	-	-	0%	-	0%	1%

Note: Two-hour count summary volumes include heavy vehicles but exclude bicycles in overall count.

Interval Start	Heavy Vehicle Totals					Bicycles					Pedestrians (Crossing Leg)				
	EB	WB	NB	SB	Total	EB	WB	NB	SB	Total	East	West	North	South	Total
4:00 PM	3	4	0	0	7	0	4	0	0	4	1	5	8	0	14
4:15 PM	3	0	0	0	3	2	0	0	1	3	3	0	4	0	7
4:30 PM	2	4	0	1	7	0	0	0	0	0	4	6	2	0	12
4:45 PM	1	2	0	0	3	0	0	0	0	0	0	6	0	0	6
5:00 PM	2	2	0	0	4	1	1	0	4	6	0	1	0	0	1
5:15 PM	2	2	0	0	4	5	6	0	0	11	0	2	1	0	3
5:30 PM	4	0	0	0	4	4	1	0	0	5	0	3	4	0	7
5:45 PM	0	3	0	0	3	2	4	0	2	8	7	4	4	0	15
Count Total	17	17	0	1	35	14	16	0	7	37	15	27	23	0	65
Peak Hr	8	7	0	0	15	12	12	0	6	30	7	10	9	0	26

Two-Hour Count Summaries - Heavy Vehicles																		
Interval Start	E Julian St				E Julian St				0				N 21st St				15-min Total	Rolling One Hour
	Eastbound				Westbound				Northbound				Southbound					
	UT	LT	TH	RT	UT	LT	TH	RT	UT	LT	TH	RT	UT	LT	TH	RT		
4:00 PM	0	0	3	0	0	0	3	1	0	0	0	0	0	0	0	0	7	0
4:15 PM	0	0	3	0	0	0	0	0	0	0	0	0	0	0	0	0	3	0
4:30 PM	0	0	2	0	0	0	4	0	0	0	0	0	0	0	1	7	0	
4:45 PM	0	0	1	0	0	0	2	0	0	0	0	0	0	0	0	3	20	
5:00 PM	0	0	2	0	0	0	2	0	0	0	0	0	0	0	0	4	17	
5:15 PM	0	0	2	0	0	0	2	0	0	0	0	0	0	0	0	4	18	
5:30 PM	0	0	4	0	0	0	0	0	0	0	0	0	0	0	0	4	15	
5:45 PM	0	0	0	0	0	0	3	0	0	0	0	0	0	0	0	3	15	
Count Total	0	0	17	0	0	0	16	1	0	0	0	0	0	0	1	35	0	
Peak Hour	0	0	8	0	0	0	7	0	0	0	0	0	0	0	0	15	0	
Two-Hour Count Summaries - Bikes																		
Interval Start	E Julian St			E Julian St			0			N 21st St			15-min Total	Rolling One Hour				
	Eastbound			Westbound			Northbound			Southbound								
	LT	TH	RT	LT	TH	RT	LT	TH	RT	LT	TH	RT						
4:00 PM	0	0	0	0	3	1	0	0	0	0	0	0	4	0				
4:15 PM	0	2	0	0	0	0	0	0	0	0	0	1	3	0				
4:30 PM	0	0	0	0	0	0	0	0	0	0	0	0	0	0				
4:45 PM	0	0	0	0	0	0	0	0	0	0	0	0	0	7				
5:00 PM	0	1	0	0	1	0	0	0	0	4	0	0	6	9				
5:15 PM	0	5	0	0	5	1	0	0	0	0	0	0	11	17				
5:30 PM	0	4	0	0	1	0	0	0	0	0	0	0	5	22				
5:45 PM	0	2	0	0	3	1	0	0	0	2	0	0	8	30				
Count Total	0	14	0	0	13	3	0	0	0	7	0	0	37	0				
Peak Hour	0	12	0	0	10	2	0	0	0	6	0	0	30	0				
<i>Note: U-Turn volumes for bikes are included in Left-Turn, if any.</i>																		

N 24th St E Julian St



Peak Hour

Date: 10/09/2014
Count Period: 7:00 AM to 9:00 AM
Peak Hour: 7:15 AM to 8:15 AM

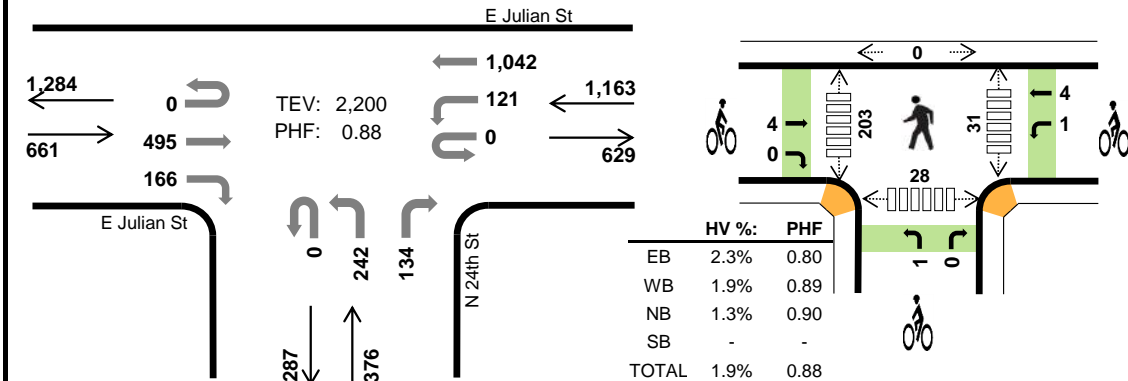

Two-Hour Count Summaries

Interval Start	E Julian St Eastbound				E Julian St Westbound				N 24th St Northbound				0 Southbound				15-min Total	Rolling One Hour	
	UT	LT	TH	RT	UT	LT	TH	RT	UT	LT	TH	RT	UT	LT	TH	RT			
7:00 AM	0	0	62	13	0	14	142	0	0	37	0	16	0	0	0	0	284	0	
7:15 AM	0	0	91	20	0	23	231	0	0	57	0	33	0	0	0	0	455	0	
7:30 AM	0	0	123	41	0	37	289	0	0	72	0	32	0	0	0	0	594	0	
7:45 AM	0	0	145	61	0	35	286	0	0	70	0	29	0	0	0	0	626	1,959	
8:00 AM	0	0	136	44	0	26	236	0	0	43	0	40	0	0	0	0	525	2,200	
8:15 AM	0	0	117	16	0	6	182	0	0	47	0	22	0	0	0	0	390	2,135	
8:30 AM	0	0	81	13	0	12	215	0	0	41	0	16	0	0	0	0	378	1,919	
8:45 AM	0	0	113	16	0	5	198	0	0	40	0	15	0	0	0	0	387	1,680	
Count Total	0	0	868	224	0	158	1779	0	0	407	0	203	0	0	0	0	3,639	0	
Peak Hour	All	0	0	495	166	0	121	1042	0	0	242	0	134	0	0	0	0	2,200	0
	HV	0	0	13	2	0	1	21	0	0	5	0	0	0	0	0	0	42	0
	HV%	-	-	3%	1%	-	1%	2%	-	-	2%	-	0%	-	-	-	-	2%	0

Note: Two-hour count summary volumes include heavy vehicles but exclude bicycles in overall count.

Interval Start	Heavy Vehicle Totals					Bicycles					Pedestrians (Crossing Leg)				
	EB	WB	NB	SB	Total	EB	WB	NB	SB	Total	East	West	North	South	Total
7:00 AM	1	3	3	0	7	1	0	0	0	1	1	5	0	0	6
7:15 AM	6	8	0	0	14	1	2	1	0	4	2	27	0	2	31
7:30 AM	5	7	4	0	16	0	1	0	0	1	9	54	0	11	74
7:45 AM	2	5	1	0	8	1	1	0	0	2	13	91	0	14	118
8:00 AM	2	2	0	0	4	2	1	0	0	3	7	31	0	1	39
8:15 AM	4	5	1	0	10	0	0	0	0	0	5	2	0	0	7
8:30 AM	2	3	2	0	7	0	3	0	0	3	1	2	0	1	4
8:45 AM	2	4	2	0	8	1	2	0	0	3	1	4	0	0	5
Count Total	24	37	13	0	74	6	10	1	0	17	39	216	0	29	284
Peak Hr	15	22	5	0	42	4	5	1	0	10	31	203	0	28	262

Two-Hour Count Summaries - Heavy Vehicles																		
Interval Start	E Julian St				E Julian St				N 24th St				O				15-min Total	Rolling One Hour
	Eastbound				Westbound				Northbound				Southbound					
	UT	LT	TH	RT	UT	LT	TH	RT	UT	LT	TH	RT	UT	LT	TH	RT		
7:00 AM	0	0	0	1	0	1	2	0	0	1	0	2	0	0	0	0	7	0
7:15 AM	0	0	5	1	0	1	7	0	0	0	0	0	0	0	0	0	14	0
7:30 AM	0	0	4	1	0	0	7	0	0	4	0	0	0	0	0	0	16	0
7:45 AM	0	0	2	0	0	0	5	0	0	1	0	0	0	0	0	0	8	45
8:00 AM	0	0	2	0	0	0	2	0	0	0	0	0	0	0	0	0	4	42
8:15 AM	0	0	4	0	0	0	5	0	0	0	0	1	0	0	0	0	10	38
8:30 AM	0	0	2	0	0	2	1	0	0	2	0	0	0	0	0	0	7	29
8:45 AM	0	0	1	1	0	0	4	0	0	2	0	0	0	0	0	0	8	29
Count Total	0	0	20	4	0	4	33	0	0	10	0	3	0	0	0	0	74	0
Peak Hour	0	0	13	2	0	1	21	0	0	5	0	0	0	0	0	0	42	0

Two-Hour Count Summaries - Bikes														
Interval Start	E Julian St			E Julian St			N 24th St			O			15-min Total	Rolling One Hour
	Eastbound			Westbound			Northbound			Southbound				
	LT	TH	RT	LT	TH	RT	LT	TH	RT	LT	TH	RT		
7:00 AM	0	1	0	0	0	0	0	0	0	0	0	0	1	0
7:15 AM	0	1	0	1	1	0	1	0	0	0	0	0	4	0
7:30 AM	0	0	0	0	1	0	0	0	0	0	0	0	1	0
7:45 AM	0	1	0	0	1	0	0	0	0	0	0	0	2	8
8:00 AM	0	2	0	0	1	0	0	0	0	0	0	0	3	10
8:15 AM	0	0	0	0	0	0	0	0	0	0	0	0	0	6
8:30 AM	0	0	0	0	3	0	0	0	0	0	0	0	3	8
8:45 AM	0	1	0	0	2	0	0	0	0	0	0	0	3	9
Count Total	0	6	0	1	9	0	1	0	0	0	0	0	17	0
Peak Hour	0	4	0	1	4	0	1	0	0	0	0	0	10	0

Note: U-Turn volumes for bikes are included in Left-Turn, if any.

N 24th St E Julian St



Peak Hour

Date: 10/09/2014
Count Period: 4:00 PM to 6:00 PM
Peak Hour: 5:00 PM to 6:00 PM

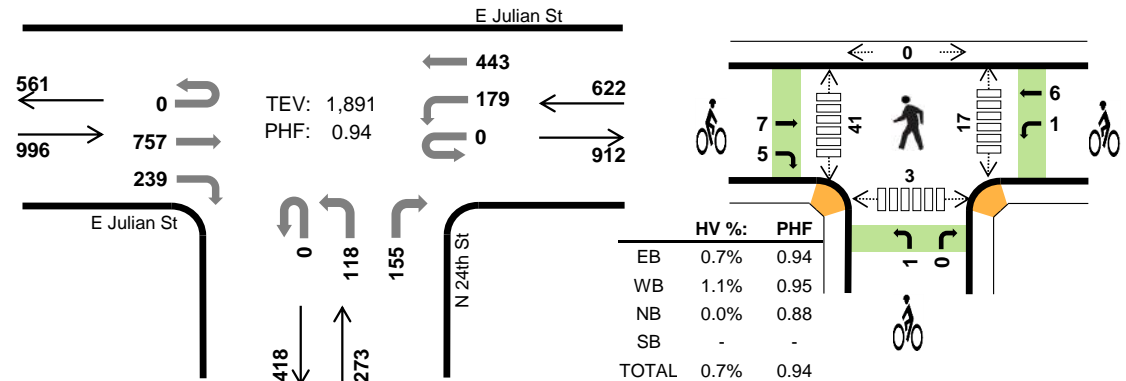

Two-Hour Count Summaries

Interval Start	E Julian St Eastbound				E Julian St Westbound				N 24th St Northbound				0 Southbound				15-min Total	Rolling One Hour	
	UT	LT	TH	RT	UT	LT	TH	RT	UT	LT	TH	RT	UT	LT	TH	RT			
4:00 PM	0	0	148	51	0	22	121	0	0	22	0	26	0	0	0	0	390	0	
4:15 PM	0	0	170	50	0	24	102	0	0	24	0	22	0	0	0	0	392	0	
4:30 PM	0	0	181	52	0	22	111	0	0	25	0	25	0	0	0	0	416	0	
4:45 PM	0	0	186	45	0	18	106	0	0	22	0	14	0	0	0	0	391	1,589	
5:00 PM	0	0	185	48	0	32	113	0	0	28	0	34	0	0	0	0	440	1,639	
5:15 PM	0	0	185	79	0	49	115	0	0	34	0	40	0	0	0	0	502	1,749	
5:30 PM	0	0	189	58	0	53	104	0	0	22	0	37	0	0	0	0	463	1,796	
5:45 PM	0	0	198	54	0	45	111	0	0	34	0	44	0	0	0	0	486	1,891	
Count Total	0	0	1442	437	0	265	883	0	0	211	0	242	0	0	0	0	3,480	0	
Peak Hour	All	0	0	757	239	0	179	443	0	0	118	0	155	0	0	0	0	1,891	0
	HV	0	0	6	1	0	1	6	0	0	0	0	0	0	0	0	0	14	0
	HV%	-	-	1%	0%	-	1%	1%	-	-	0%	-	0%	-	-	-	-	1%	0

Note: Two-hour count summary volumes include heavy vehicles but exclude bicycles in overall count.

Interval Start	Heavy Vehicle Totals					Bicycles					Pedestrians (Crossing Leg)				
	EB	WB	NB	SB	Total	EB	WB	NB	SB	Total	East	West	North	South	Total
4:00 PM	6	6	1	0	13	0	0	1	0	1	7	16	0	0	23
4:15 PM	4	0	1	0	5	3	1	0	0	4	7	7	0	1	15
4:30 PM	2	4	0	0	6	0	0	0	0	0	10	6	0	3	19
4:45 PM	1	2	0	0	3	0	0	0	0	0	10	4	0	2	16
5:00 PM	2	2	0	0	4	0	1	0	0	1	7	11	0	1	19
5:15 PM	2	2	0	0	4	1	3	1	0	5	6	11	0	1	18
5:30 PM	3	1	0	0	4	7	1	0	0	8	2	11	0	1	14
5:45 PM	0	2	0	0	2	4	2	0	0	6	2	8	0	0	10
Count Total	20	19	2	0	41	15	8	2	0	25	51	74	0	9	134
Peak Hr	7	7	0	0	14	12	7	1	0	20	17	41	0	3	61

Two-Hour Count Summaries - Heavy Vehicles																			
Interval Start	E Julian St				E Julian St				N 24th St				0				15-min Total	Rolling One Hour	
	Eastbound				Westbound				Northbound				Southbound						
	UT	LT	TH	RT	UT	LT	TH	RT	UT	LT	TH	RT	UT	LT	TH	RT			
4:00 PM	0	0	5	1	0	1	5	0	0	1	0	0	0	0	0	0	0	13	0
4:15 PM	0	0	2	2	0	0	0	0	0	1	0	0	0	0	0	0	0	5	0
4:30 PM	0	0	2	0	0	1	3	0	0	0	0	0	0	0	0	0	0	6	0
4:45 PM	0	0	1	0	0	0	2	0	0	0	0	0	0	0	0	0	0	3	27
5:00 PM	0	0	2	0	0	0	2	0	0	0	0	0	0	0	0	0	0	4	18
5:15 PM	0	0	2	0	0	0	2	0	0	0	0	0	0	0	0	0	0	4	17
5:30 PM	0	0	2	1	0	1	0	0	0	0	0	0	0	0	0	0	0	4	15
5:45 PM	0	0	0	0	0	0	2	0	0	0	0	0	0	0	0	0	0	2	14
Count Total	0	0	16	4	0	3	16	0	0	2	0	0	0	0	0	0	0	41	0
Peak Hour	0	0	6	1	0	1	6	0	0	0	0	0	0	0	0	0	0	14	0
Two-Hour Count Summaries - Bikes																			
Interval Start	E Julian St			E Julian St			N 24th St			0			15-min Total	Rolling One Hour					
	Eastbound			Westbound			Northbound			Southbound									
	LT	TH	RT	LT	TH	RT	LT	TH	RT	LT	TH	RT							
4:00 PM	0	0	0	0	0	0	0	0	0	0	0	0	0	0	1	0	0	0	
4:15 PM	0	3	0	1	0	0	0	0	0	0	0	0	0	0	0	0	0	4	0
4:30 PM	0	0	0	0	0	0	0	0	0	0	0	0	0	0	0	0	0	0	0
4:45 PM	0	0	0	0	0	0	0	0	0	0	0	0	0	0	0	0	0	0	5
5:00 PM	0	0	0	0	1	0	0	0	0	0	0	0	0	0	0	0	0	1	5
5:15 PM	0	1	0	0	3	0	0	1	0	0	0	0	0	0	0	0	0	5	6
5:30 PM	0	3	4	0	1	0	0	0	0	0	0	0	0	0	0	0	0	8	14
5:45 PM	0	3	1	1	1	0	0	0	0	0	0	0	0	0	0	0	0	6	20
Count Total	0	10	5	2	6	0	0	1	0	1	0	0	0	0	0	0	0	25	0
Peak Hour	0	7	5	1	6	0	0	1	0	0	0	0	0	0	0	0	0	20	0
<i>Note: U-Turn volumes for bikes are included in Left-Turn, if any.</i>																			

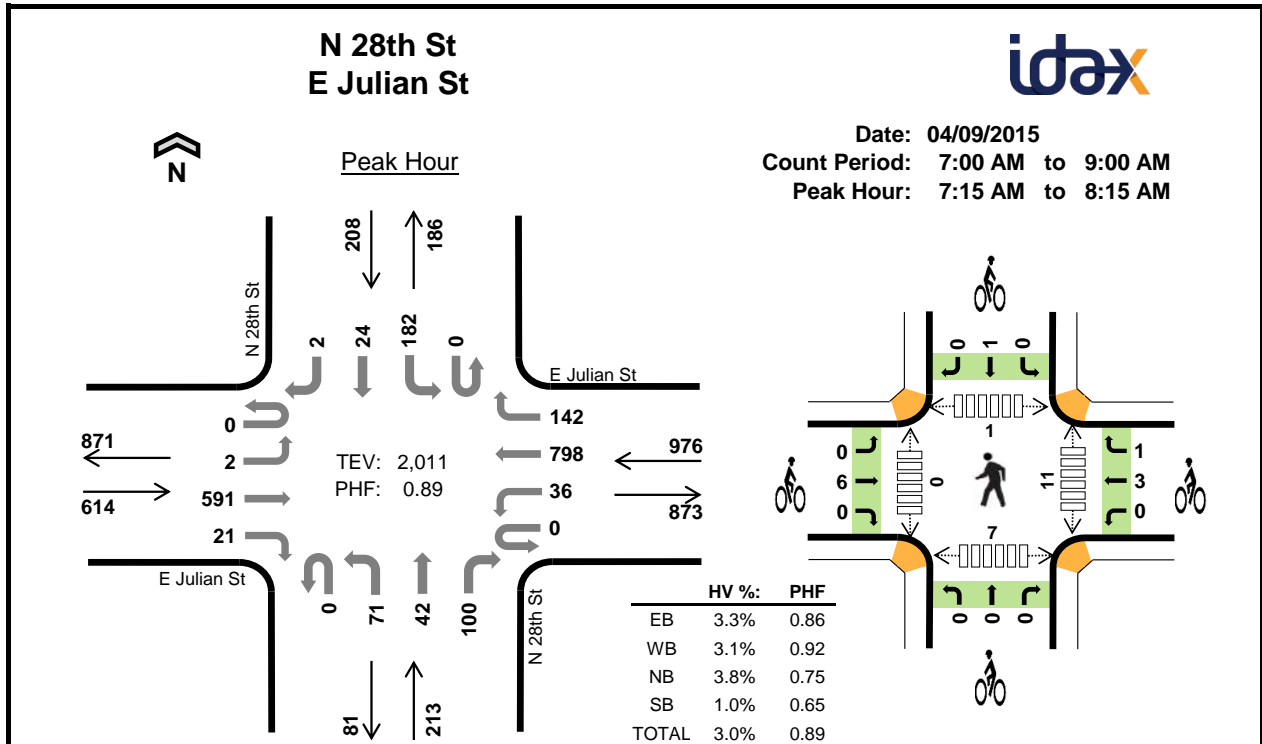

Two-Hour Count Summaries

Interval Start	E Julian St Eastbound				E Julian St Westbound				N 28th St Northbound				N 28th St Southbound				15-min Total	Rolling One Hour	
	UT	LT	TH	RT	UT	LT	TH	RT	UT	LT	TH	RT	UT	LT	TH	RT			
7:00 AM	0	0	113	2	0	7	150	20	0	4	5	13	0	18	2	0	334	0	
7:15 AM	0	1	109	4	0	5	187	31	0	15	8	16	0	30	5	0	411	0	
7:30 AM	0	1	161	5	0	4	207	53	0	17	9	40	0	59	5	1	562	0	
7:45 AM	0	0	147	7	0	19	198	31	0	26	21	24	0	69	11	0	553	1,860	
8:00 AM	0	0	174	5	0	8	206	27	0	13	4	20	0	24	3	1	485	2,011	
8:15 AM	0	0	119	6	1	4	185	11	0	5	1	9	0	24	3	0	368	1,968	
8:30 AM	0	1	124	2	0	6	144	17	0	7	1	6	0	17	1	0	326	1,732	
8:45 AM	0	1	106	2	0	11	158	11	0	5	2	11	0	22	2	0	331	1,510	
Count Total	0	4	1,053	33	1	64	1,435	201	0	92	51	139	0	263	32	2	3,370	0	
Peak Hour	All	0	2	591	21	0	36	798	142	0	71	42	100	0	182	24	2	2,011	0
	HV	0	0	17	3	0	5	20	5	0	0	0	8	0	1	0	1	60	0
	HV%	-	0%	3%	14%	-	14%	3%	4%	-	0%	0%	8%	-	1%	0%	50%	3%	0

Note: Two-hour count summary volumes include heavy vehicles but exclude bicycles in overall count.

Interval Start	Heavy Vehicle Totals					Bicycles					Pedestrians (Crossing Leg)				
	EB	WB	NB	SB	Total	EB	WB	NB	SB	Total	East	West	North	South	Total
7:00 AM	2	6	2	0	10	0	1	0	0	1	1	0	1	1	3
7:15 AM	6	6	1	1	14	1	1	0	1	3	3	0	0	2	5
7:30 AM	5	8	4	1	18	0	0	0	0	0	2	0	0	2	4
7:45 AM	5	8	0	0	13	3	3	0	0	6	5	0	0	3	8
8:00 AM	4	8	3	0	15	2	0	0	0	2	1	0	1	0	2
8:15 AM	5	6	0	0	11	0	1	0	0	1	0	0	0	2	2
8:30 AM	3	6	2	1	12	0	0	0	0	0	0	0	0	0	0
8:45 AM	3	8	0	1	12	0	0	0	0	0	1	0	0	0	1
Count Total	33	56	12	4	105	6	6	0	1	13	13	0	2	10	25
Peak Hour	20	30	8	2	60	6	4	0	1	11	11	0	1	7	19

Two-Hour Count Summaries - Heavy Vehicles																		
Interval Start	E Julian St				E Julian St				N 28th St				N 28th St				15-min Total	Rolling One Hour
	Eastbound				Westbound				Northbound				Southbound					
	UT	LT	TH	RT	UT	LT	TH	RT	UT	LT	TH	RT	UT	LT	TH	RT		
7:00 AM	0	0	2	0	0	0	5	1	0	0	1	1	0	0	0	0	10	0
7:15 AM	0	0	6	0	0	1	4	1	0	0	0	1	0	1	0	0	14	0
7:30 AM	0	0	5	0	0	0	8	0	0	0	0	4	0	0	0	1	18	0
7:45 AM	0	0	3	2	0	2	3	3	0	0	0	0	0	0	0	0	13	55
8:00 AM	0	0	3	1	0	2	5	1	0	0	0	3	0	0	0	0	15	60
8:15 AM	0	0	5	0	0	0	6	0	0	0	0	0	0	0	0	0	11	57
8:30 AM	0	1	2	0	0	1	4	1	0	0	0	2	0	1	0	0	12	51
8:45 AM	0	0	3	0	0	2	5	1	0	0	0	0	0	1	0	0	12	50
Count Total	0	1	29	3	0	8	40	8	0	0	1	11	0	3	0	1	105	0
Peak Hour	0	0	17	3	0	5	20	5	0	0	0	8	0	1	0	1	60	0

Two-Hour Count Summaries - Bikes														
Interval Start	E Julian St			E Julian St			N 28th St			N 28th St			15-min Total	Rolling One Hour
	Eastbound			Westbound			Northbound			Southbound				
	LT	TH	RT	LT	TH	RT	LT	TH	RT	LT	TH	RT		
7:00 AM	0	0	0	0	1	0	0	0	0	0	0	0	1	0
7:15 AM	0	1	0	0	1	0	0	0	0	0	0	0	3	0
7:30 AM	0	0	0	0	0	0	0	0	0	0	0	0	0	0
7:45 AM	0	3	0	0	2	1	0	0	0	0	0	0	6	10
8:00 AM	0	2	0	0	0	0	0	0	0	0	0	0	2	11
8:15 AM	0	0	0	0	0	1	0	0	0	0	0	0	1	9
8:30 AM	0	0	0	0	0	0	0	0	0	0	0	0	0	9
8:45 AM	0	0	0	0	0	0	0	0	0	0	0	0	0	3
Count Total	0	6	0	0	4	2	0	0	0	0	1	0	13	0
Peak Hour	0	6	0	0	3	1	0	0	0	0	1	0	11	0

Note: U-Turn volumes for bikes are included in Left-Turn, if any.

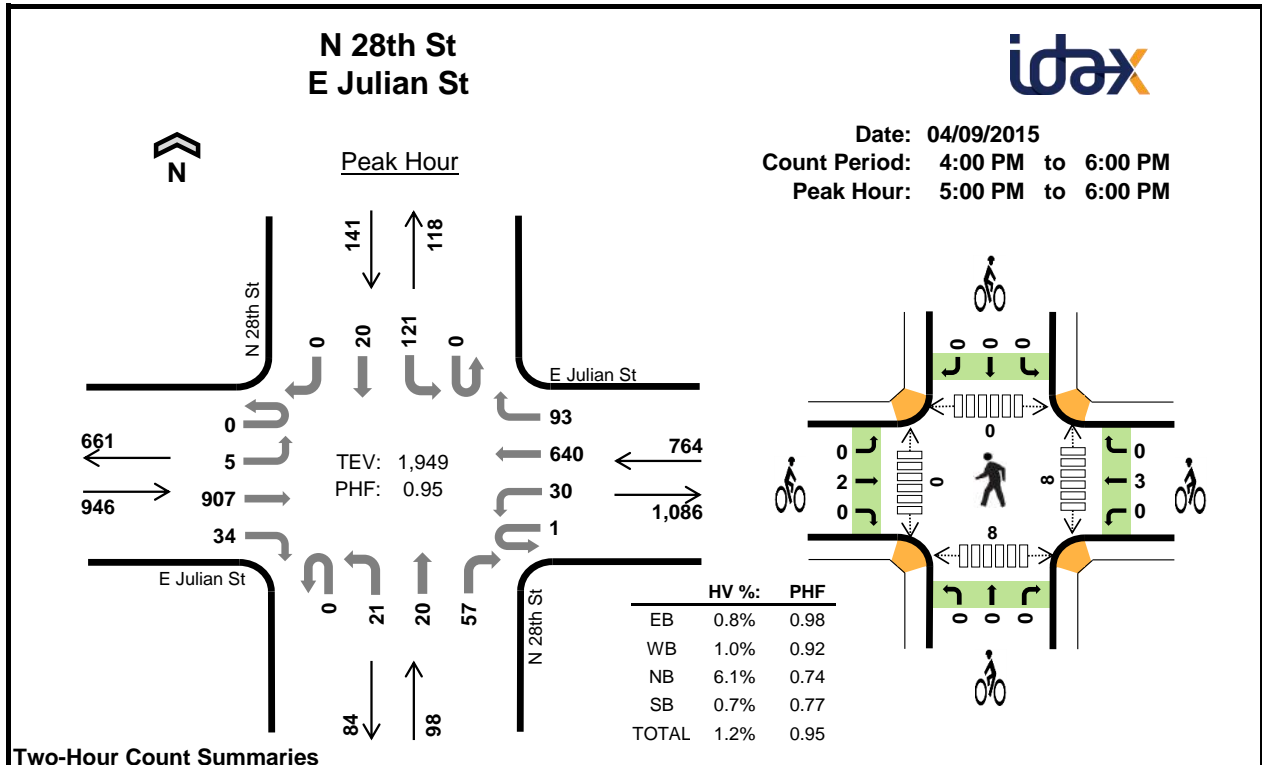

Two-Hour Count Summaries

Interval Start	E Julian St Eastbound				E Julian St Westbound				N 28th St Northbound				N 28th St Southbound				15-min Total	Rolling One Hour	
	UT	LT	TH	RT	UT	LT	TH	RT	UT	LT	TH	RT	UT	LT	TH	RT			
4:00 PM	0	2	195	12	0	9	146	20	0	2	0	12	0	21	3	2	424	0	
4:15 PM	0	2	205	6	2	3	145	22	0	3	4	23	0	21	5	1	442	0	
4:30 PM	0	3	198	5	0	3	148	21	0	3	2	14	0	28	2	0	427	0	
4:45 PM	0	2	201	6	2	10	159	22	0	3	1	15	0	27	6	0	454	1,747	
5:00 PM	0	0	221	11	0	8	169	31	0	4	5	15	0	22	2	0	488	1,811	
5:15 PM	0	2	219	10	0	6	162	21	0	4	2	8	0	26	8	0	468	1,837	
5:30 PM	0	2	233	6	0	8	168	24	0	7	7	19	0	33	4	0	511	1,921	
5:45 PM	0	1	234	7	1	8	141	17	0	6	6	15	0	40	6	0	482	1,949	
Count Total	0	14	1,706	63	5	55	1,238	178	0	32	27	121	0	218	36	3	3,696	0	
Peak Hour	All	0	5	907	34	1	30	640	93	0	21	20	57	0	121	20	0	1,949	0
	HV	0	0	7	1	0	2	6	0	0	0	2	4	0	0	1	0	23	0
	HV%	-	0%	1%	3%	0%	7%	1%	0%	-	0%	10%	7%	-	0%	5%	-	1%	0

Note: Two-hour count summary volumes include heavy vehicles but exclude bicycles in overall count.

Interval Start	Heavy Vehicle Totals					Bicycles					Pedestrians (Crossing Leg)				
	EB	WB	NB	SB	Total	EB	WB	NB	SB	Total	East	West	North	South	Total
4:00 PM	4	3	0	0	7	0	1	0	0	1	0	0	0	2	2
4:15 PM	1	3	0	0	4	0	1	0	0	1	0	0	0	1	1
4:30 PM	3	4	0	1	8	0	2	0	0	2	2	0	0	1	3
4:45 PM	1	3	0	0	4	0	2	0	1	3	1	0	0	1	2
5:00 PM	2	4	2	1	9	1	0	0	0	1	1	0	0	4	5
5:15 PM	2	2	2	0	6	1	1	0	0	2	3	0	0	1	4
5:30 PM	1	0	0	0	1	0	0	0	0	0	1	0	0	1	2
5:45 PM	3	2	2	0	7	0	2	0	0	2	3	0	0	2	5
Count Total	17	21	6	2	46	2	9	0	1	12	11	0	0	13	24
Peak Hour	8	8	6	1	23	2	3	0	0	5	8	0	0	8	16

Two-Hour Count Summaries - Heavy Vehicles																		
Interval Start	E Julian St				E Julian St				N 28th St				N 28th St				15-min Total	Rolling One Hour
	Eastbound				Westbound				Northbound				Southbound					
	UT	LT	TH	RT	UT	LT	TH	RT	UT	LT	TH	RT	UT	LT	TH	RT		
4:00 PM	0	0	4	0	0	1	1	1	0	0	0	0	0	0	0	0	7	0
4:15 PM	0	0	1	0	0	0	2	1	0	0	0	0	0	0	0	0	4	0
4:30 PM	0	0	3	0	0	0	4	0	0	0	0	0	0	1	0	0	8	0
4:45 PM	0	0	1	0	0	0	3	0	0	0	0	0	0	0	0	0	4	23
5:00 PM	0	0	2	0	0	1	3	0	0	0	1	1	0	0	1	0	9	25
5:15 PM	0	0	1	1	0	1	1	0	0	0	0	2	0	0	0	0	6	27
5:30 PM	0	0	1	0	0	0	0	0	0	0	0	0	0	0	0	0	1	20
5:45 PM	0	0	3	0	0	0	2	0	0	0	1	1	0	0	0	0	7	23
Count Total	0	0	16	1	0	3	16	2	0	0	2	4	0	1	1	0	46	0
Peak Hour	0	0	7	1	0	2	6	0	0	0	2	4	0	0	1	0	23	0
Two-Hour Count Summaries - Bikes																		
Interval Start	E Julian St			E Julian St			N 28th St			N 28th St			15-min Total	Rolling One Hour				
	Eastbound			Westbound			Northbound			Southbound								
	LT	TH	RT	LT	TH	RT	LT	TH	RT	LT	TH	RT						
4:00 PM	0	0	0	0	1	0	0	0	0	0	0	0	0	0	1	0		
4:15 PM	0	0	0	0	1	0	0	0	0	0	0	0	0	0	1	0		
4:30 PM	0	0	0	0	1	1	0	0	0	0	0	0	0	0	2	0		
4:45 PM	0	0	0	0	1	1	0	0	0	0	0	1	0	3	7			
5:00 PM	0	1	0	0	0	0	0	0	0	0	0	0	0	1	7			
5:15 PM	0	1	0	0	1	0	0	0	0	0	0	0	0	2	8			
5:30 PM	0	0	0	0	0	0	0	0	0	0	0	0	0	0	6			
5:45 PM	0	0	0	0	2	0	0	0	0	0	0	0	0	2	5			
Count Total	0	2	0	0	7	2	0	0	0	0	0	1	0	12	0			
Peak Hour	0	2	0	0	3	0	0	0	0	0	0	0	0	5	0			
<i>Note: U-Turn volumes for bikes are included in Left-Turn, if any.</i>																		

US 101 SB Ramps E Julian St



Peak Hour

Date: 10/09/2014
 Count Period: 7:00 AM to 9:00 AM
 Peak Hour: 7:15 AM to 8:15 AM

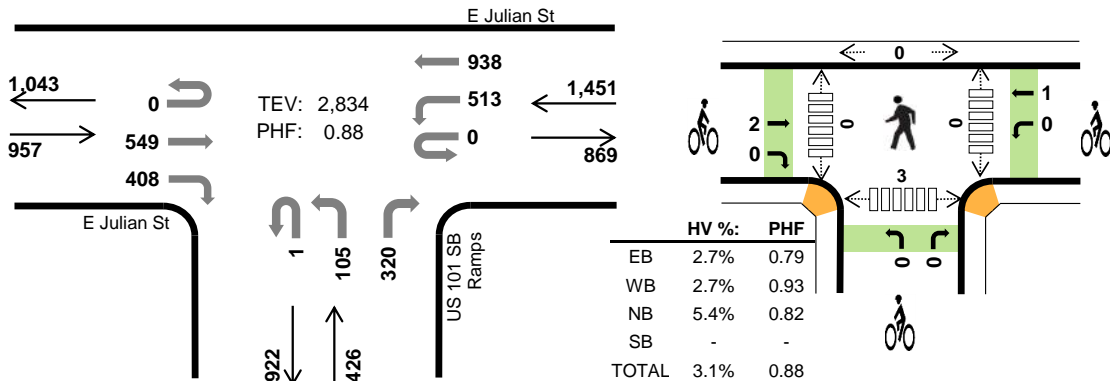

Two-Hour Count Summaries

Interval Start	E Julian St Eastbound				E Julian St Westbound				US 101 SB Ramps Northbound				0 Southbound				15-min Total	Rolling One Hour	
	UT	LT	TH	RT	UT	LT	TH	RT	UT	LT	TH	RT	UT	LT	TH	RT			
7:00 AM	0	0	77	81	0	86	147	0	0	21	0	65	0	0	0	0	477	0	
7:15 AM	0	0	106	91	0	107	217	0	0	24	0	65	0	0	0	0	610	0	
7:30 AM	0	0	132	101	0	134	255	0	1	36	0	83	0	0	0	0	742	0	
7:45 AM	0	0	181	122	0	125	251	0	0	28	0	102	0	0	0	0	809	2,638	
8:00 AM	0	0	130	94	0	147	215	0	0	17	0	70	0	0	0	0	673	2,834	
8:15 AM	0	0	90	57	0	108	170	0	0	13	0	73	0	0	0	0	511	2,735	
8:30 AM	0	0	78	56	0	100	225	0	1	14	0	53	0	0	0	0	527	2,520	
8:45 AM	0	0	86	61	0	108	204	0	0	8	0	63	0	0	0	0	530	2,241	
Count Total	0	0	880	663	0	915	1684	0	2	161	0	574	0	0	0	0	4,879	0	
Peak Hour	All	0	0	549	408	0	513	938	0	1	105	0	320	0	0	0	0	2,834	0
	HV	0	0	20	6	0	14	25	0	0	2	0	21	0	0	0	0	88	0
	HV%	-	-	4%	1%	-	3%	3%	-	0%	2%	-	7%	-	-	-	-	3%	0

Note: Two-hour count summary volumes include heavy vehicles but exclude bicycles in overall count.

Interval Start	Heavy Vehicle Totals					Bicycles					Pedestrians (Crossing Leg)				
	EB	WB	NB	SB	Total	EB	WB	NB	SB	Total	East	West	North	South	Total
7:00 AM	3	8	9	0	20	0	0	0	0	0	0	0	0	0	0
7:15 AM	6	17	7	0	30	0	0	0	0	0	0	0	0	0	2
7:30 AM	9	11	2	0	22	0	0	0	0	0	0	0	0	1	1
7:45 AM	5	6	11	0	22	1	0	0	0	1	0	0	0	0	0
8:00 AM	6	5	3	0	14	1	1	0	0	2	0	0	0	0	0
8:15 AM	6	12	4	0	22	1	0	0	0	1	0	0	0	0	0
8:30 AM	4	10	8	0	22	0	2	0	0	2	0	0	0	0	0
8:45 AM	8	15	4	0	27	1	0	0	0	1	0	0	0	0	0
Count Total	47	84	48	0	179	4	3	0	0	7	0	0	0	3	3
Peak Hr	26	39	23	0	88	2	1	0	0	3	0	0	0	3	3

Two-Hour Count Summaries - Heavy Vehicles																		
Interval Start	E Julian St				E Julian St				US 101 SB Ramps				0				15-min Total	Rolling One Hour
	Eastbound				Westbound				Northbound				Southbound					
	UT	LT	TH	RT	UT	LT	TH	RT	UT	LT	TH	RT	UT	LT	TH	RT		
7:00 AM	0	0	1	2	0	4	4	0	0	1	0	8	0	0	0	0	20	0
7:15 AM	0	0	6	0	0	6	11	0	0	1	0	6	0	0	0	0	30	0
7:30 AM	0	0	6	3	0	5	6	0	0	1	0	1	0	0	0	0	22	0
7:45 AM	0	0	4	1	0	1	5	0	0	0	0	11	0	0	0	0	22	94
8:00 AM	0	0	4	2	0	2	3	0	0	0	0	3	0	0	0	0	14	88
8:15 AM	0	0	2	4	0	8	4	0	0	1	0	3	0	0	0	0	22	80
8:30 AM	0	0	2	2	0	8	2	0	0	2	0	6	0	0	0	0	22	80
8:45 AM	0	0	4	4	0	8	7	0	0	2	0	2	0	0	0	0	27	85
Count Total	0	0	29	18	0	42	42	0	0	8	0	40	0	0	0	0	179	0
Peak Hour	0	0	20	6	0	14	25	0	0	2	0	21	0	0	0	0	88	0

Two-Hour Count Summaries - Bikes															
Interval Start	E Julian St			E Julian St			US 101 SB Ramps			0			15-min Total	Rolling One Hour	
	Eastbound			Westbound			Northbound			Southbound					
	LT	TH	RT	LT	TH	RT	LT	TH	RT	LT	TH	RT			
7:00 AM	0	0	0	0	0	0	0	0	0	0	0	0	0	0	0
7:15 AM	0	0	0	0	0	0	0	0	0	0	0	0	0	0	0
7:30 AM	0	0	0	0	0	0	0	0	0	0	0	0	0	0	0
7:45 AM	0	1	0	0	0	0	0	0	0	0	0	0	0	0	1
8:00 AM	0	1	0	0	1	0	0	0	0	0	0	0	0	0	2
8:15 AM	0	1	0	0	0	0	0	0	0	0	0	0	0	0	1
8:30 AM	0	0	0	0	2	0	0	0	0	0	0	0	0	0	2
8:45 AM	0	1	0	0	0	0	0	0	0	0	0	0	0	0	1
Count Total	0	4	0	0	3	0	0	0	0	0	0	0	0	0	7
Peak Hour	0	2	0	0	1	0	0	0	0	0	0	0	0	0	3

Note: U-Turn volumes for bikes are included in Left-Turn, if any.

US 101 SB Ramps E Julian St



Peak Hour

Date: 10/09/2014
 Count Period: 4:00 PM to 6:00 PM
 Peak Hour: 5:00 PM to 6:00 PM

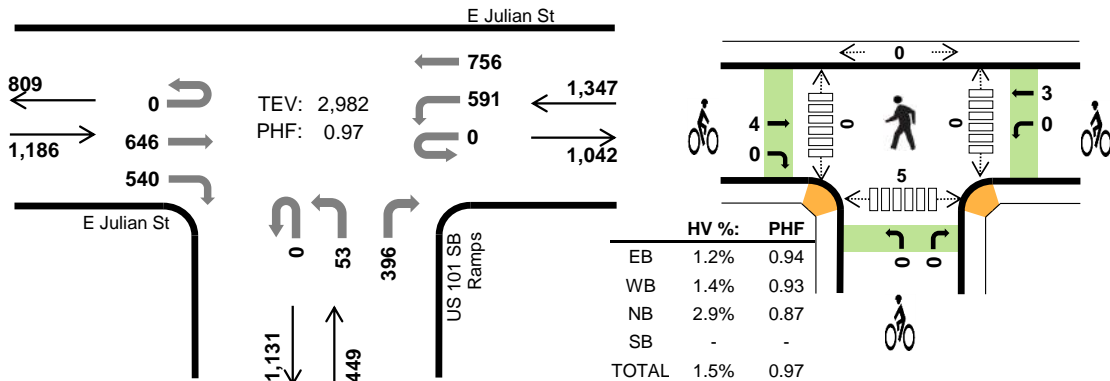

Two-Hour Count Summaries

Interval Start	E Julian St Eastbound				E Julian St Westbound				US 101 SB Ramps Northbound				0 Southbound				15-min Total	Rolling One Hour	
	UT	LT	TH	RT	UT	LT	TH	RT	UT	LT	TH	RT	UT	LT	TH	RT			
4:00 PM	0	0	56	89	1	122	150	0	0	26	0	82	0	0	0	0	526	0	
4:15 PM	0	0	125	108	0	154	161	0	0	21	0	84	0	0	0	0	653	0	
4:30 PM	0	0	155	98	0	158	181	0	0	21	0	94	0	0	0	0	707	0	
4:45 PM	0	0	127	113	1	153	150	0	0	14	0	91	0	0	0	0	649	2,535	
5:00 PM	0	0	172	142	0	143	185	0	0	13	0	102	0	0	0	0	757	2,766	
5:15 PM	0	0	160	138	0	160	181	0	0	15	0	114	0	0	0	0	768	2,881	
5:30 PM	0	0	155	130	0	158	205	0	0	10	0	94	0	0	0	0	752	2,926	
5:45 PM	0	0	159	130	0	130	185	0	0	15	0	86	0	0	0	0	705	2,982	
Count Total	0	0	1109	948	2	1178	1398	0	0	135	0	747	0	0	0	0	5,517	0	
Peak Hour	All	0	0	646	540	0	591	756	0	0	53	0	396	0	0	0	0	2,982	0
	HV	0	0	9	5	0	7	12	0	0	5	0	8	0	0	0	0	46	0
	HV%	-	-	1%	1%	-	1%	2%	-	-	9%	-	2%	-	-	-	-	2%	0

Note: Two-hour count summary volumes include heavy vehicles but exclude bicycles in overall count.

Interval Start	Heavy Vehicle Totals					Bicycles					Pedestrians (Crossing Leg)				
	EB	WB	NB	SB	Total	EB	WB	NB	SB	Total	East	West	North	South	Total
4:00 PM	3	10	2	0	15	1	2	0	0	3	0	0	0	1	1
4:15 PM	3	3	3	0	9	0	1	0	0	1	0	0	0	1	1
4:30 PM	3	9	0	0	12	0	0	0	0	0	0	0	0	2	2
4:45 PM	2	4	4	0	10	0	0	0	0	0	0	0	0	0	0
5:00 PM	5	4	3	0	12	2	0	0	0	2	0	0	0	0	0
5:15 PM	4	5	7	0	16	1	1	0	0	2	0	0	0	0	0
5:30 PM	4	3	2	0	9	1	2	0	0	3	0	0	0	5	5
5:45 PM	1	7	1	0	9	0	0	0	0	0	0	0	0	0	0
Count Total	25	45	22	0	92	5	6	0	0	11	0	0	0	9	9
Peak Hr	14	19	13	0	46	4	3	0	0	7	0	0	0	5	5

Two-Hour Count Summaries - Heavy Vehicles																		
Interval Start	E Julian St				E Julian St				US 101 SB Ramps				0				15-min Total	Rolling One Hour
	Eastbound				Westbound				Northbound				Southbound					
	UT	LT	TH	RT	UT	LT	TH	RT	UT	LT	TH	RT	UT	LT	TH	RT		
4:00 PM	0	0	2	1	0	5	5	0	0	0	0	2	0	0	0	0	15	0
4:15 PM	0	0	3	0	0	1	2	0	0	1	0	2	0	0	0	0	9	0
4:30 PM	0	0	3	0	0	3	6	0	0	0	0	0	0	0	0	0	12	0
4:45 PM	0	0	2	0	0	2	2	0	0	0	0	4	0	0	0	0	10	46
5:00 PM	0	0	4	1	0	2	2	0	0	1	0	2	0	0	0	0	12	43
5:15 PM	0	0	2	2	0	2	3	0	0	4	0	3	0	0	0	0	16	50
5:30 PM	0	0	3	1	0	2	1	0	0	0	0	2	0	0	0	0	9	47
5:45 PM	0	0	0	1	0	1	6	0	0	0	0	1	0	0	0	0	9	46
Count Total	0	0	19	6	0	18	27	0	0	6	0	16	0	0	0	0	92	0
Peak Hour	0	0	9	5	0	7	12	0	0	5	0	8	0	0	0	0	46	0
Two-Hour Count Summaries - Bikes																		
Interval Start	E Julian St			E Julian St			US 101 SB Ramps			0			15-min Total	Rolling One Hour				
	Eastbound			Westbound			Northbound			Southbound								
	LT	TH	RT	LT	TH	RT	LT	TH	RT	LT	TH	RT						
4:00 PM	0	1	0	0	2	0	0	0	0	0	0	0	0	3	0			
4:15 PM	0	0	0	0	1	0	0	0	0	0	0	0	0	1	0			
4:30 PM	0	0	0	0	0	0	0	0	0	0	0	0	0	0	0			
4:45 PM	0	0	0	0	0	0	0	0	0	0	0	0	0	0	4			
5:00 PM	0	2	0	0	0	0	0	0	0	0	0	0	0	2	3			
5:15 PM	0	1	0	0	1	0	0	0	0	0	0	0	0	2	4			
5:30 PM	0	1	0	0	2	0	0	0	0	0	0	0	0	3	7			
5:45 PM	0	0	0	0	0	0	0	0	0	0	0	0	0	0	7			
Count Total	0	5	0	0	6	0	0	0	0	0	0	0	0	11	0			
Peak Hour	0	4	0	0	3	0	0	0	0	0	0	0	0	7	0			
<i>Note: U-Turn volumes for bikes are included in Left-Turn, if any.</i>																		

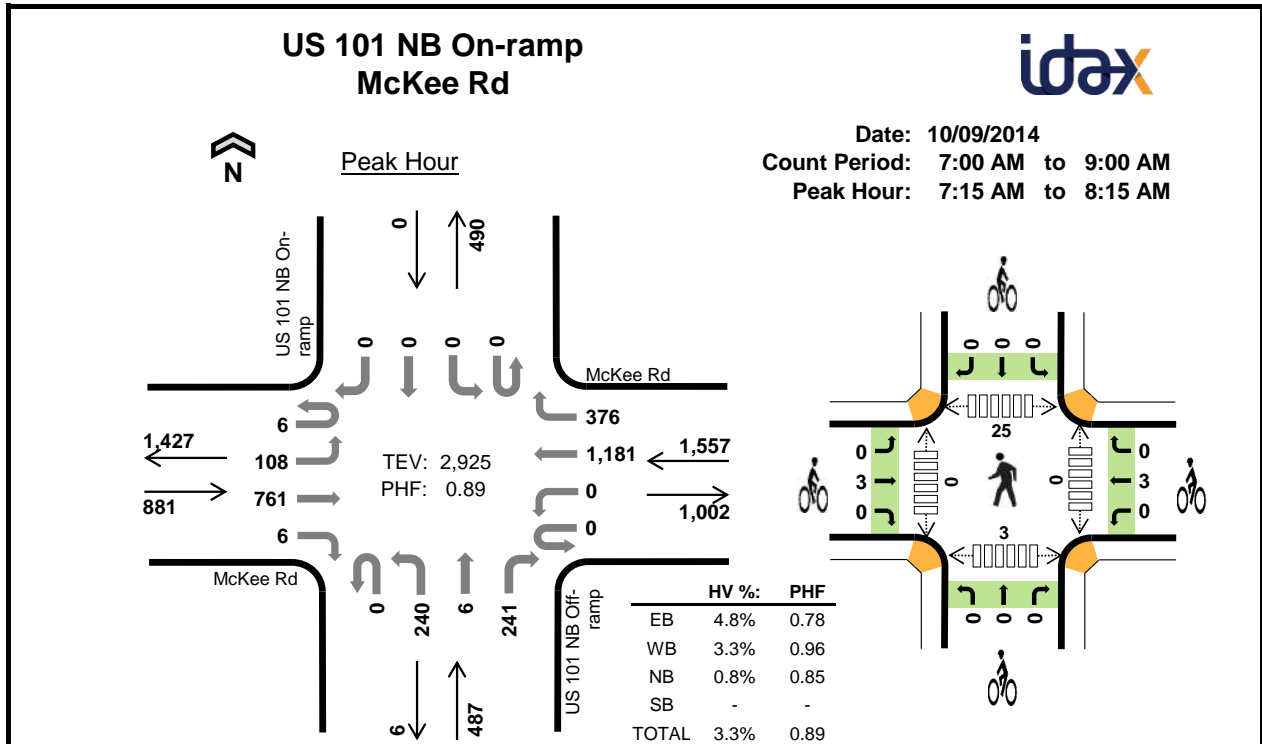

Two-Hour Count Summaries

Interval Start	McKee Rd Eastbound				McKee Rd Westbound				US 101 NB Off-ramp Northbound				US 101 NB On-ramp Southbound				15-min Total	Rolling One Hour	
	UT	LT	TH	RT	UT	LT	TH	RT	UT	LT	TH	RT	UT	LT	TH	RT			
7:00 AM	1	23	117	0	0	0	206	93	0	30	1	50	0	0	0	0	521	0	
7:15 AM	1	31	131	0	0	0	302	91	0	39	0	63	0	0	0	0	658	0	
7:30 AM	1	25	192	0	0	0	277	100	0	79	2	63	0	0	0	0	739	0	
7:45 AM	3	27	247	6	0	0	319	88	0	65	0	69	0	0	0	0	824	2,742	
8:00 AM	1	25	191	0	0	0	283	97	0	57	4	46	0	0	0	0	704	2,925	
8:15 AM	0	20	157	0	0	0	245	91	0	43	1	64	0	0	0	0	621	2,888	
8:30 AM	0	11	132	0	0	0	287	94	0	58	10	57	0	0	0	0	649	2,798	
8:45 AM	1	12	155	0	0	0	246	89	0	50	7	64	0	0	0	0	624	2,598	
Count Total	8	174	1322	6	0	0	2165	743	0	421	25	476	0	0	0	0	5,340	0	
Peak Hour	All	6	108	761	6	0	0	1181	376	0	240	6	241	0	0	0	0	2,925	0
	HV	0	5	37	0	0	0	34	17	0	1	0	3	0	0	0	0	97	0
	HV%	0%	5%	5%	0%	-	-	3%	5%	-	0%	0%	1%	-	-	-	-	3%	0

Note: Two-hour count summary volumes include heavy vehicles but exclude bicycles in overall count.

Interval Start	Heavy Vehicle Totals					Bicycles					Pedestrians (Crossing Leg)				
	EB	WB	NB	SB	Total	EB	WB	NB	SB	Total	East	West	North	South	Total
7:00 AM	12	10	6	0	28	0	1	0	0	1	0	0	5	0	5
7:15 AM	13	24	1	0	38	0	2	0	0	2	0	0	6	1	7
7:30 AM	7	9	1	0	17	0	0	0	0	0	0	0	13	2	15
7:45 AM	14	7	2	0	23	1	1	0	0	2	0	0	5	0	5
8:00 AM	8	11	0	0	19	2	0	0	0	2	0	0	1	0	1
8:15 AM	7	17	2	0	26	0	0	0	0	0	0	0	0	0	0
8:30 AM	9	10	5	0	24	0	1	0	0	1	0	0	2	0	2
8:45 AM	5	18	2	0	25	1	1	0	0	2	0	0	0	0	0
Count Total	75	106	19	0	200	4	6	0	0	10	0	0	32	3	35
Peak Hour	42	51	4	0	97	3	3	0	0	6	0	0	25	3	28

Two-Hour Count Summaries - Heavy Vehicles																		
Interval Start	McKee Rd				McKee Rd				US 101 NB Off-ramp				US 101 NB On-ramp				15-min Total	Rolling One Hour
	Eastbound				Westbound				Northbound				Southbound					
	UT	LT	TH	RT	UT	LT	TH	RT	UT	LT	TH	RT	UT	LT	TH	RT		
7:00 AM	0	2	10	0	0	0	7	3	0	1	0	5	0	0	0	0	28	0
7:15 AM	0	2	11	0	0	0	18	6	0	0	0	1	0	0	0	0	38	0
7:30 AM	0	2	5	0	0	0	7	2	0	0	0	1	0	0	0	0	17	0
7:45 AM	0	1	13	0	0	0	4	3	0	1	0	1	0	0	0	0	23	106
8:00 AM	0	0	8	0	0	0	5	6	0	0	0	0	0	0	0	0	19	97
8:15 AM	0	0	7	0	0	0	12	5	0	0	0	2	0	0	0	0	26	85
8:30 AM	0	0	9	0	0	0	9	1	0	1	0	4	0	0	0	0	24	92
8:45 AM	0	1	4	0	0	0	12	6	0	2	0	0	0	0	0	0	25	94
Count Total	0	8	67	0	0	0	74	32	0	5	0	14	0	0	0	0	200	0
Peak Hour	0	5	37	0	0	0	34	17	0	1	0	3	0	0	0	0	97	0

Two-Hour Count Summaries - Bikes														
Interval Start	McKee Rd			McKee Rd			US 101 NB Off-ramp			US 101 NB On-ramp			15-min Total	Rolling One Hour
	Eastbound			Westbound			Northbound			Southbound				
	LT	TH	RT	LT	TH	RT	LT	TH	RT	LT	TH	RT		
7:00 AM	0	0	0	0	1	0	0	0	0	0	0	0	1	0
7:15 AM	0	0	0	0	2	0	0	0	0	0	0	0	2	0
7:30 AM	0	0	0	0	0	0	0	0	0	0	0	0	0	0
7:45 AM	0	1	0	0	1	0	0	0	0	0	0	0	2	5
8:00 AM	0	2	0	0	0	0	0	0	0	0	0	0	2	6
8:15 AM	0	0	0	0	0	0	0	0	0	0	0	0	0	4
8:30 AM	0	0	0	0	1	0	0	0	0	0	0	0	1	5
8:45 AM	0	1	0	0	1	0	0	0	0	0	0	0	2	5
Count Total	0	4	0	0	6	0	0	0	0	0	0	0	10	0
Peak Hour	0	3	0	0	3	0	0	0	0	0	0	0	6	0

Note: U-Turn volumes for bikes are included in Left-Turn, if any.

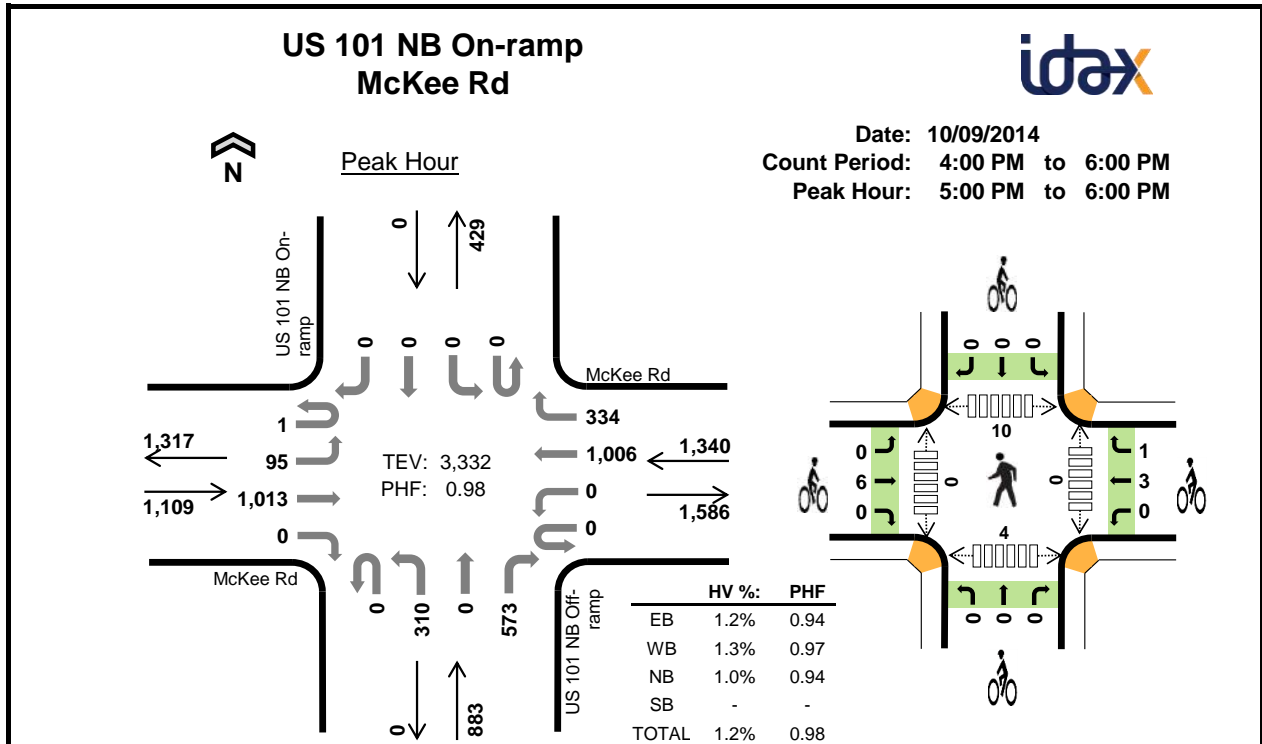

Two-Hour Count Summaries

Interval Start	McKee Rd Eastbound				McKee Rd Westbound				US 101 NB Off-ramp Northbound				US 101 NB On-ramp Southbound				15-min Total	Rolling One Hour	
	UT	LT	TH	RT	UT	LT	TH	RT	UT	LT	TH	RT	UT	LT	TH	RT			
4:00 PM	0	27	199	0	0	0	190	77	0	62	0	169	0	0	0	0	724	0	
4:15 PM	2	16	220	0	0	0	245	81	0	69	0	164	0	0	0	0	797	0	
4:30 PM	0	31	218	0	0	0	255	93	0	82	0	157	0	0	0	0	836	0	
4:45 PM	0	22	197	0	0	0	249	75	0	63	0	147	0	0	0	0	753	3,110	
5:00 PM	1	27	242	0	0	0	255	91	0	78	0	151	0	0	0	0	845	3,231	
5:15 PM	0	19	257	0	0	0	243	92	0	88	0	147	0	0	0	0	846	3,280	
5:30 PM	0	25	243	0	0	0	260	85	0	87	0	131	0	0	0	0	831	3,275	
5:45 PM	0	24	271	0	0	0	248	66	0	57	0	144	0	0	0	0	810	3,332	
Count Total	3	191	1847	0	0	0	1945	660	0	586	0	1210	0	0	0	0	6,442	0	
Peak Hour	All	1	95	1013	0	0	0	1006	334	0	310	0	573	0	0	0	0	3,332	0
	HV	0	2	11	0	0	0	12	6	0	3	0	6	0	0	0	0	40	0
	HV%	0%	2%	1%	-	-	-	1%	2%	-	1%	-	1%	-	-	-	-	1%	0

Note: Two-hour count summary volumes include heavy vehicles but exclude bicycles in overall count.

Interval Start	Heavy Vehicle Totals					Bicycles					Pedestrians (Crossing Leg)				
	EB	WB	NB	SB	Total	EB	WB	NB	SB	Total	East	West	North	South	Total
4:00 PM	7	11	4	0	22	1	0	0	0	1	0	0	4	2	6
4:15 PM	7	4	5	0	16	0	0	0	0	0	0	0	8	0	8
4:30 PM	3	8	8	0	19	0	0	0	0	0	0	0	2	0	2
4:45 PM	6	7	1	0	14	0	0	0	0	0	0	0	5	2	7
5:00 PM	7	6	1	0	14	2	2	0	0	4	0	0	1	0	1
5:15 PM	2	5	2	0	9	1	2	0	0	3	0	0	2	3	5
5:30 PM	2	4	2	0	8	1	0	0	0	1	0	0	1	1	2
5:45 PM	2	3	4	0	9	2	0	0	0	2	0	0	6	0	6
Count Total	36	48	27	0	111	7	4	0	0	11	0	0	29	8	37
Peak Hour	13	18	9	0	40	6	4	0	0	10	0	0	10	4	14

Two-Hour Count Summaries - Heavy Vehicles																		
Interval Start	McKee Rd				McKee Rd				US 101 NB Off-ramp				US 101 NB On-ramp				15-min Total	Rolling One Hour
	Eastbound				Westbound				Northbound				Southbound					
	UT	LT	TH	RT	UT	LT	TH	RT	UT	LT	TH	RT	UT	LT	TH	RT		
4:00 PM	0	2	5	0	0	0	8	3	0	0	0	4	0	0	0	0	22	0
4:15 PM	0	1	6	0	0	0	2	2	0	1	0	4	0	0	0	0	16	0
4:30 PM	0	0	3	0	0	0	7	1	0	3	0	5	0	0	0	0	19	0
4:45 PM	0	1	5	0	0	0	4	3	0	1	0	0	0	0	0	0	14	71
5:00 PM	0	0	7	0	0	0	3	3	0	0	0	1	0	0	0	0	14	63
5:15 PM	0	0	2	0	0	0	4	1	0	0	0	2	0	0	0	0	9	56
5:30 PM	0	0	2	0	0	0	2	2	0	1	0	1	0	0	0	0	8	45
5:45 PM	0	2	0	0	0	0	3	0	0	2	0	2	0	0	0	0	9	40
Count Total	0	6	30	0	0	0	33	15	0	8	0	19	0	0	0	0	111	0
Peak Hour	0	2	11	0	0	0	12	6	0	3	0	6	0	0	0	0	40	0
Two-Hour Count Summaries - Bikes																		
Interval Start	McKee Rd			McKee Rd			US 101 NB Off-ramp			US 101 NB On-ramp			15-min Total	Rolling One Hour				
	Eastbound			Westbound			Northbound			Southbound								
	LT	TH	RT	LT	TH	RT	LT	TH	RT	LT	TH	RT						
4:00 PM	0	1	0	0	0	0	0	0	0	0	0	0	0	0	1	0		
4:15 PM	0	0	0	0	0	0	0	0	0	0	0	0	0	0	0	0		
4:30 PM	0	0	0	0	0	0	0	0	0	0	0	0	0	0	0	0		
4:45 PM	0	0	0	0	0	0	0	0	0	0	0	0	0	0	0	1		
5:00 PM	0	2	0	0	2	0	0	0	0	0	0	0	0	0	4	4		
5:15 PM	0	1	0	0	1	1	0	0	0	0	0	0	0	0	3	7		
5:30 PM	0	1	0	0	0	0	0	0	0	0	0	0	0	0	1	8		
5:45 PM	0	2	0	0	0	0	0	0	0	0	0	0	0	0	2	10		
Count Total	0	7	0	0	3	1	0	0	0	0	0	0	0	0	11	0		
Peak Hour	0	6	0	0	3	1	0	0	0	0	0	0	0	0	10	0		
<i>Note: U-Turn volumes for bikes are included in Left-Turn, if any.</i>																		

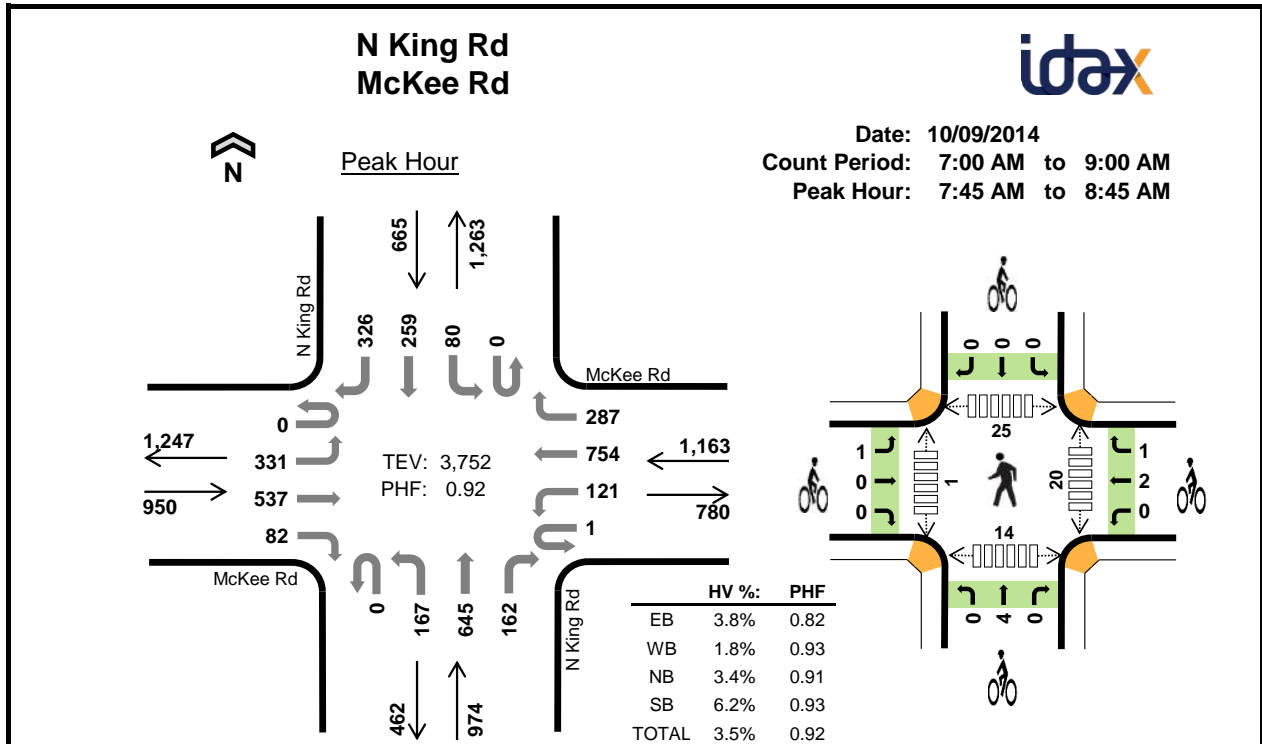

Two-Hour Count Summaries

Interval Start	McKee Rd Eastbound				McKee Rd Westbound				N King Rd Northbound				N King Rd Southbound				15-min Total	Rolling One Hour	
	UT	LT	TH	RT	UT	LT	TH	RT	UT	LT	TH	RT	UT	LT	TH	RT			
7:00 AM	0	79	66	9	2	13	162	39	0	34	98	14	0	6	32	61	615	0	
7:15 AM	0	79	90	7	0	14	170	59	0	32	154	17	0	6	38	75	741	0	
7:30 AM	0	85	105	16	0	23	145	66	0	45	208	26	0	12	68	84	883	0	
7:45 AM	0	82	183	25	1	34	177	73	0	44	185	38	0	21	82	76	1,021	3,260	
8:00 AM	0	84	136	17	0	26	169	76	0	36	162	38	0	18	74	86	922	3,567	
8:15 AM	0	91	123	17	0	34	185	74	0	37	135	41	0	23	60	86	906	3,732	
8:30 AM	0	74	95	23	0	27	223	64	0	50	163	45	0	18	43	78	903	3,752	
8:45 AM	0	95	123	8	0	36	213	47	0	42	131	27	0	8	37	62	829	3,560	
Count Total	0	669	921	122	3	207	1444	498	0	320	1236	246	0	112	434	608	6,820	0	
Peak Hour	All	0	331	537	82	1	121	754	287	0	167	645	162	0	80	259	326	3,752	0
	HV	0	16	14	6	0	1	15	5	0	9	23	1	0	4	13	24	131	0
	HV%	-	5%	3%	7%	0%	1%	2%	2%	-	5%	4%	1%	-	5%	5%	7%	3%	0

Note: Two-hour count summary volumes include heavy vehicles but exclude bicycles in overall count.

Interval Start	Heavy Vehicle Totals					Bicycles					Pedestrians (Crossing Leg)				
	EB	WB	NB	SB	Total	EB	WB	NB	SB	Total	East	West	North	South	Total
7:00 AM	16	5	4	11	36	0	0	0	0	0	4	1	2	8	15
7:15 AM	4	7	7	11	29	0	0	0	0	0	4	1	3	2	10
7:30 AM	10	3	3	9	25	0	0	1	0	1	3	0	3	2	8
7:45 AM	13	4	1	8	26	0	0	0	0	0	5	1	9	2	17
8:00 AM	5	8	7	8	28	1	0	0	0	1	5	0	3	3	11
8:15 AM	8	4	12	16	40	0	1	2	0	3	5	0	10	3	18
8:30 AM	10	5	13	9	37	0	2	2	0	4	5	0	3	6	14
8:45 AM	12	6	11	13	42	0	3	0	0	3	3	5	7	2	17
Count Total	78	42	58	85	263	1	6	5	0	12	34	8	40	28	110
Peak Hour	36	21	33	41	131	1	3	4	0	8	20	1	25	14	60

Two-Hour Count Summaries - Heavy Vehicles																		
Interval Start	McKee Rd				McKee Rd				N King Rd				N King Rd				15-min Total	Rolling One Hour
	Eastbound				Westbound				Northbound				Southbound					
	UT	LT	TH	RT	UT	LT	TH	RT	UT	LT	TH	RT	UT	LT	TH	RT		
7:00 AM	0	8	8	0	0	1	4	0	0	1	3	0	0	3	2	6	36	0
7:15 AM	0	0	4	0	0	1	6	0	0	3	4	0	0	0	2	9	29	0
7:30 AM	0	5	3	2	0	0	1	2	0	0	3	0	0	0	4	5	25	0
7:45 AM	0	7	3	3	0	1	1	2	0	1	0	0	0	1	1	6	26	116
8:00 AM	0	1	3	1	0	0	7	1	0	2	5	0	0	0	3	5	28	108
8:15 AM	0	4	4	0	0	0	3	1	0	3	8	1	0	2	5	9	40	119
8:30 AM	0	4	4	2	0	0	4	1	0	3	10	0	0	1	4	4	37	131
8:45 AM	0	5	7	0	0	0	5	1	0	3	5	3	0	1	5	7	42	147
Count Total	0	34	36	8	0	3	31	8	0	16	38	4	0	8	26	51	263	0
Peak Hour	0	16	14	6	0	1	15	5	0	9	23	1	0	4	13	24	131	0

Two-Hour Count Summaries - Bikes																
Interval Start	McKee Rd			McKee Rd			N King Rd			N King Rd			15-min Total	Rolling One Hour		
	Eastbound			Westbound			Northbound			Southbound						
	LT	TH	RT	LT	TH	RT	LT	TH	RT	LT	TH	RT				
7:00 AM	0	0	0	0	0	0	0	0	0	0	0	0	0	0		
7:15 AM	0	0	0	0	0	0	0	0	0	0	0	0	0	0		
7:30 AM	0	0	0	0	0	0	0	0	1	0	0	0	1	0		
7:45 AM	0	0	0	0	0	0	0	0	0	0	0	0	0	1		
8:00 AM	1	0	0	0	0	0	0	0	0	0	0	0	1	2		
8:15 AM	0	0	0	0	0	1	0	2	0	0	0	0	3	5		
8:30 AM	0	0	0	0	2	0	0	2	0	0	0	0	4	8		
8:45 AM	0	0	0	0	3	0	0	0	0	0	0	0	3	11		
Count Total	1	0	0	0	5	1	0	4	1	0	0	0	12	0		
Peak Hour	1	0	0	0	2	1	0	4	0	0	0	0	8	0		

Note: U-Turn volumes for bikes are included in Left-Turn, if any.

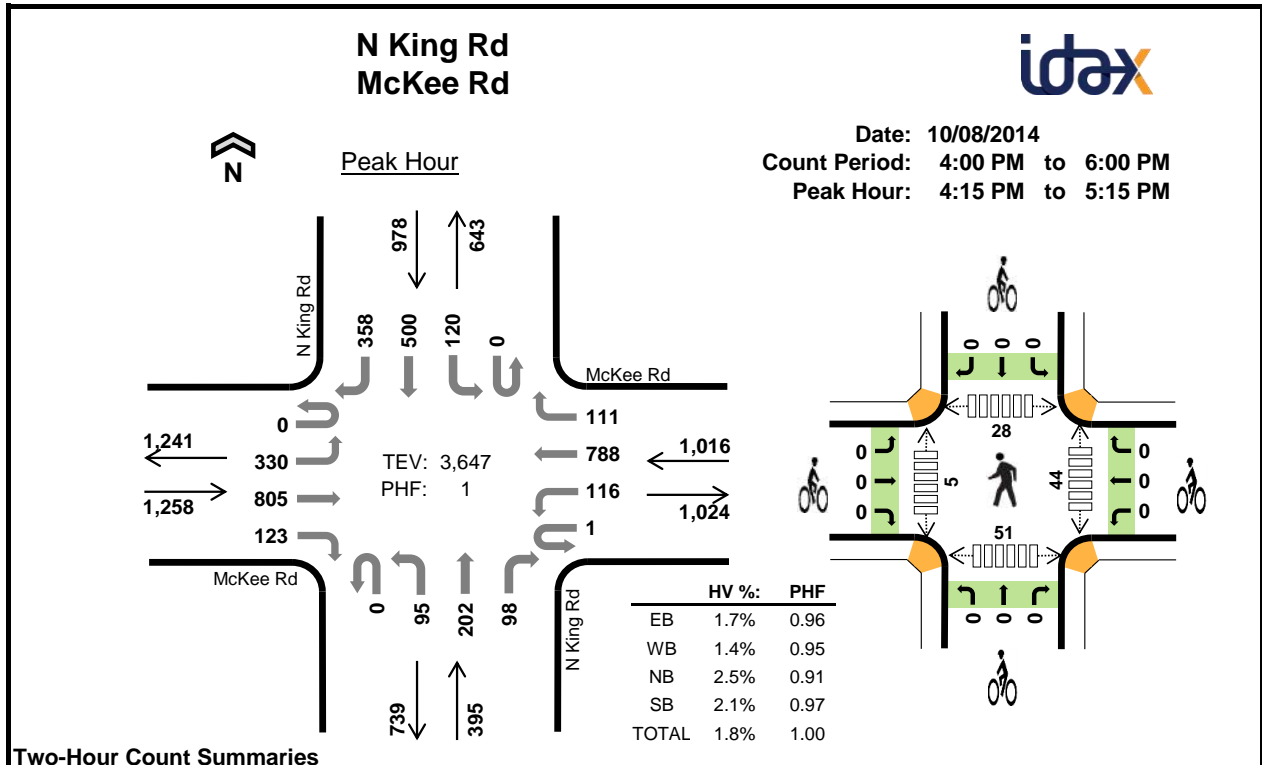

Two-Hour Count Summaries

Interval Start	McKee Rd Eastbound				McKee Rd Westbound				N King Rd Northbound				N King Rd Southbound				15-min Total	Rolling One Hour	
	UT	LT	TH	RT	UT	LT	TH	RT	UT	LT	TH	RT	UT	LT	TH	RT			
4:00 PM	0	76	166	34	0	37	170	29	0	9	44	37	0	32	154	80	868	0	
4:15 PM	0	92	182	34	1	33	190	26	0	27	50	32	0	26	128	95	916	0	
4:30 PM	0	94	203	28	0	25	188	32	0	21	56	17	0	26	127	99	916	0	
4:45 PM	0	81	212	33	0	24	199	31	0	23	47	27	0	32	130	70	909	3,609	
5:00 PM	0	63	208	28	0	34	211	22	0	24	49	22	0	36	115	94	906	3,647	
5:15 PM	1	73	184	27	0	32	211	34	0	23	45	25	0	40	131	74	900	3,631	
5:30 PM	0	75	189	24	0	28	191	37	0	23	51	23	0	35	120	104	900	3,615	
5:45 PM	0	61	163	33	0	39	212	19	0	21	46	34	0	32	142	90	892	3,598	
Count Total	1	615	1507	241	1	252	1572	230	0	171	388	217	0	259	1047	706	7,207	0	
Peak Hour	All	0	330	805	123	1	116	788	111	0	95	202	98	0	120	500	358	3,647	0
	HV	0	7	13	2	0	1	9	4	0	1	8	1	0	1	9	11	67	0
	HV%	-	2%	2%	2%	0%	1%	1%	4%	-	1%	4%	1%	-	1%	2%	3%	2%	0

Note: Two-hour count summary volumes include heavy vehicles but exclude bicycles in overall count.

Interval Start	Heavy Vehicle Totals					Bicycles					Pedestrians (Crossing Leg)				
	EB	WB	NB	SB	Total	EB	WB	NB	SB	Total	East	West	North	South	Total
4:00 PM	5	8	1	4	18	0	0	0	0	0	12	1	10	1	24
4:15 PM	7	3	6	7	23	0	0	0	0	0	16	0	8	6	30
4:30 PM	4	3	1	7	15	0	0	0	0	0	10	0	7	19	36
4:45 PM	4	3	1	3	11	0	0	0	0	0	12	0	5	25	42
5:00 PM	7	5	2	4	18	0	0	0	0	0	6	5	8	1	20
5:15 PM	8	3	2	6	19	0	0	0	0	0	4	2	6	4	16
5:30 PM	2	0	2	6	10	2	0	0	0	2	6	1	9	5	21
5:45 PM	4	2	0	2	8	1	0	0	1	2	5	1	13	2	21
Count Total	41	27	15	39	122	3	0	0	1	4	71	10	66	63	210
Peak Hour	22	14	10	21	67	0	0	0	0	0	44	5	28	51	128

Two-Hour Count Summaries - Heavy Vehicles																		
Interval Start	McKee Rd				McKee Rd				N King Rd				N King Rd				15-min Total	Rolling One Hour
	Eastbound				Westbound				Northbound				Southbound					
	UT	LT	TH	RT	UT	LT	TH	RT	UT	LT	TH	RT	UT	LT	TH	RT		
4:00 PM	0	2	3	0	0	0	6	2	0	1	0	0	0	1	2	1	18	0
4:15 PM	0	2	5	0	0	0	2	1	0	0	5	1	0	1	2	4	23	0
4:30 PM	0	1	3	0	0	0	2	1	0	0	1	0	0	0	4	3	15	0
4:45 PM	0	1	1	2	0	1	1	1	0	0	1	0	0	0	2	1	11	67
5:00 PM	0	3	4	0	0	0	4	1	0	1	1	0	0	0	1	3	18	67
5:15 PM	0	5	3	0	0	0	2	1	0	0	2	0	0	1	3	2	19	63
5:30 PM	0	1	1	0	0	0	0	0	0	0	2	0	0	0	2	4	10	58
5:45 PM	0	2	2	0	0	0	2	0	0	0	0	0	0	0	1	1	8	55
Count Total	0	17	22	2	0	1	19	7	0	2	12	1	0	3	17	19	122	0
Peak Hour	0	7	13	2	0	1	9	4	0	1	8	1	0	1	9	11	67	0

Two-Hour Count Summaries - Bikes																
Interval Start	McKee Rd			McKee Rd			N King Rd			N King Rd			15-min Total	Rolling One Hour		
	Eastbound			Westbound			Northbound			Southbound						
	LT	TH	RT	LT	TH	RT	LT	TH	RT	LT	TH	RT				
4:00 PM	0	0	0	0	0	0	0	0	0	0	0	0	0	0		
4:15 PM	0	0	0	0	0	0	0	0	0	0	0	0	0	0		
4:30 PM	0	0	0	0	0	0	0	0	0	0	0	0	0	0		
4:45 PM	0	0	0	0	0	0	0	0	0	0	0	0	0	0		
5:00 PM	0	0	0	0	0	0	0	0	0	0	0	0	0	0		
5:15 PM	0	0	0	0	0	0	0	0	0	0	0	0	0	0		
5:30 PM	0	2	0	0	0	0	0	0	0	0	0	0	2	2		
5:45 PM	0	1	0	0	0	0	0	0	0	1	0	0	2	4		
Count Total	0	3	0	0	0	0	0	0	0	1	0	0	4	0		
Peak Hour	0	0	0	0	0	0	0	0	0	0	0	0	0	0		

Note: U-Turn volumes for bikes are included in Left-Turn, if any.

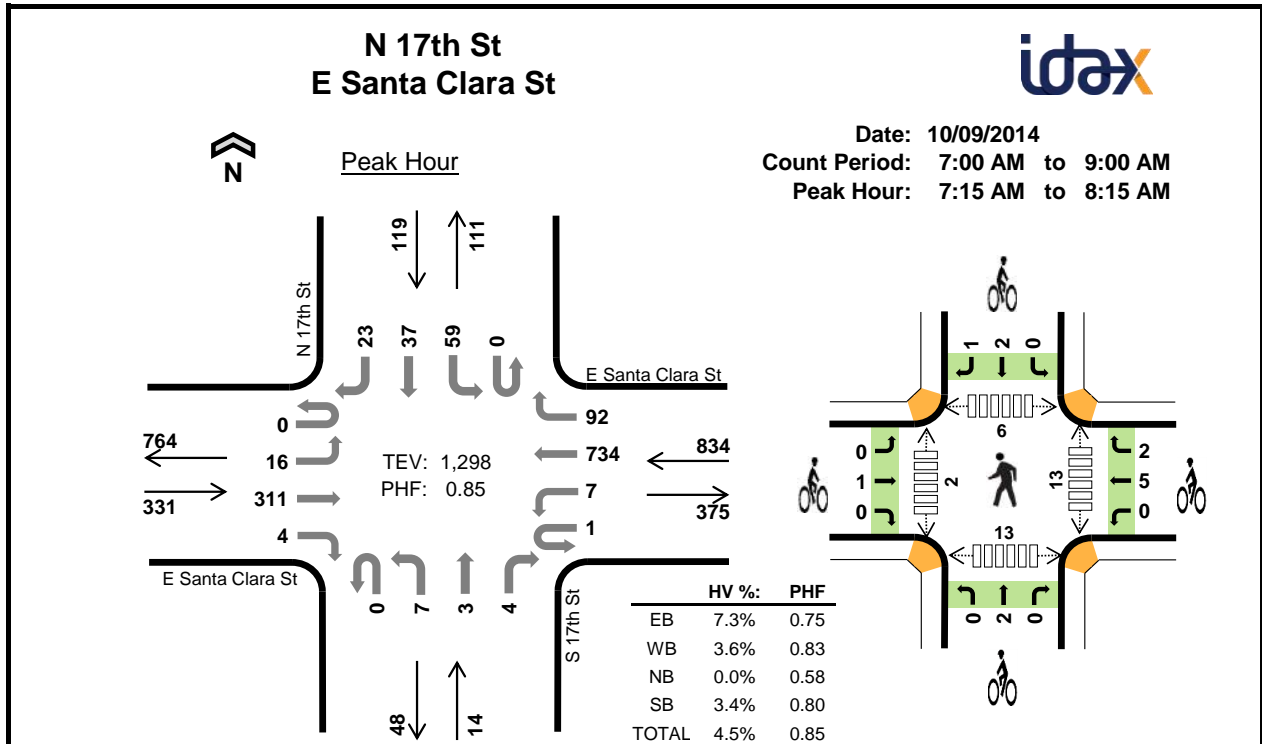

Two-Hour Count Summaries

Interval Start	E Santa Clara St Eastbound				E Santa Clara St Westbound				S 17th St Northbound				N 17th St Southbound				15-min Total	Rolling One Hour	
	UT	LT	TH	RT	UT	LT	TH	RT	UT	LT	TH	RT	UT	LT	TH	RT			
7:00 AM	0	1	54	2	0	0	98	9	0	0	1	0	0	3	2	1	171	0	
7:15 AM	0	2	51	1	0	0	168	18	0	1	1	0	0	9	7	5	263	0	
7:30 AM	0	2	73	0	0	1	200	25	0	1	0	1	0	14	8	5	330	0	
7:45 AM	0	8	83	0	1	5	210	34	0	2	1	1	0	19	10	8	382	1,146	
8:00 AM	0	4	104	3	0	1	156	15	0	3	1	2	0	17	12	5	323	1,298	
8:15 AM	0	0	71	5	0	3	130	15	0	2	4	3	0	14	4	4	255	1,290	
8:30 AM	0	4	71	3	0	8	160	18	0	2	2	5	0	6	7	4	290	1,250	
8:45 AM	0	5	86	2	0	0	201	13	0	3	1	7	0	13	4	1	336	1,204	
Count Total	0	26	593	16	1	18	1323	147	0	14	11	19	0	95	54	33	2,350	0	
Peak Hour	All	0	16	311	4	1	7	734	92	0	7	3	4	0	59	37	23	1,298	0
	HV	0	0	23	1	0	0	28	2	0	0	0	0	0	1	0	3	58	0
	HV%	-	0%	7%	25%	0%	0%	4%	2%	-	0%	0%	0%	-	2%	0%	13%	4%	0

Note: Two-hour count summary volumes include heavy vehicles but exclude bicycles in overall count.

Interval Start	Heavy Vehicle Totals					Bicycles					Pedestrians (Crossing Leg)				
	EB	WB	NB	SB	Total	EB	WB	NB	SB	Total	East	West	North	South	Total
7:00 AM	3	5	0	1	9	1	1	0	0	2	0	0	1	2	3
7:15 AM	4	8	0	1	13	0	3	1	1	5	5	0	0	2	7
7:30 AM	6	6	0	2	14	1	1	0	1	3	3	0	3	6	12
7:45 AM	5	7	0	1	13	0	2	1	0	3	4	2	3	3	12
8:00 AM	9	9	0	0	18	0	1	0	1	2	1	0	0	2	3
8:15 AM	8	3	0	2	13	0	1	1	1	3	2	0	0	4	6
8:30 AM	3	12	0	0	15	0	1	0	3	4	6	0	2	4	12
8:45 AM	8	9	2	0	19	0	2	3	2	7	7	0	2	10	19
Count Total	46	59	2	7	114	2	12	6	9	29	28	2	11	33	74
Peak Hour	24	30	0	4	58	1	7	2	3	13	13	2	6	13	34

Two-Hour Count Summaries - Heavy Vehicles																		
Interval Start	E Santa Clara St				E Santa Clara St				S 17th St				N 17th St				15-min Total	Rolling One Hour
	Eastbound				Westbound				Northbound				Southbound					
	UT	LT	TH	RT	UT	LT	TH	RT	UT	LT	TH	RT	UT	LT	TH	RT		
7:00 AM	0	0	3	0	0	0	4	1	0	0	0	0	0	1	0	0	9	0
7:15 AM	0	0	4	0	0	0	7	1	0	0	0	0	0	1	0	0	13	0
7:30 AM	0	0	6	0	0	0	6	0	0	0	0	0	0	0	0	2	14	0
7:45 AM	0	0	5	0	0	0	7	0	0	0	0	0	0	0	0	1	13	49
8:00 AM	0	0	8	1	0	0	8	1	0	0	0	0	0	0	0	0	18	58
8:15 AM	0	0	7	1	0	0	3	0	0	0	0	0	0	2	0	0	13	58
8:30 AM	0	0	3	0	0	1	8	3	0	0	0	0	0	0	0	0	15	59
8:45 AM	0	0	8	0	0	0	8	1	0	1	1	0	0	0	0	0	19	65
Count Total	0	0	44	2	0	1	51	7	0	1	1	0	0	4	0	3	114	0
Peak Hour	0	0	23	1	0	0	28	2	0	0	0	0	0	1	0	3	58	0

Two-Hour Count Summaries - Bikes														
Interval Start	E Santa Clara St			E Santa Clara St			S 17th St			N 17th St			15-min Total	Rolling One Hour
	Eastbound			Westbound			Northbound			Southbound				
	LT	TH	RT	LT	TH	RT	LT	TH	RT	LT	TH	RT		
7:00 AM	0	1	0	0	1	0	0	0	0	0	0	0	2	0
7:15 AM	0	0	0	0	1	2	0	1	0	0	0	1	5	0
7:30 AM	0	1	0	0	1	0	0	0	0	0	1	0	3	0
7:45 AM	0	0	0	0	2	0	0	1	0	0	0	0	3	13
8:00 AM	0	0	0	0	1	0	0	0	0	0	1	0	2	13
8:15 AM	0	0	0	0	1	0	0	1	0	0	1	0	3	11
8:30 AM	0	0	0	0	1	0	0	0	0	0	3	0	4	12
8:45 AM	0	0	0	0	2	0	0	3	0	0	1	1	7	16
Count Total	0	2	0	0	10	2	0	6	0	0	7	2	29	0
Peak Hour	0	1	0	0	5	2	0	2	0	0	2	1	13	0

Note: U-Turn volumes for bikes are included in Left-Turn, if any.

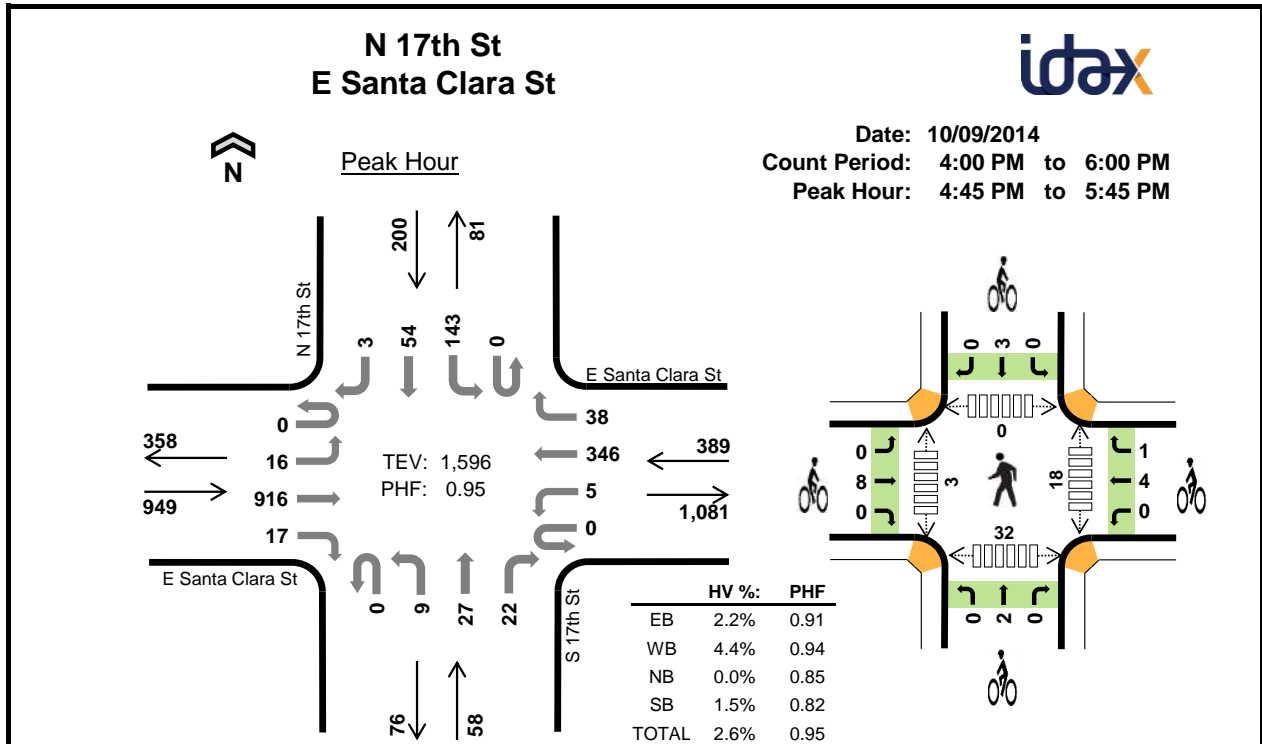

Two-Hour Count Summaries

Interval Start	E Santa Clara St Eastbound				E Santa Clara St Westbound				S 17th St Northbound				N 17th St Southbound				15-min Total	Rolling One Hour	
	UT	LT	TH	RT	UT	LT	TH	RT	UT	LT	TH	RT	UT	LT	TH	RT			
4:00 PM	0	6	184	7	0	7	83	7	0	2	7	5	0	24	9	1	342	0	
4:15 PM	0	2	201	4	0	2	68	5	0	4	7	3	0	19	15	0	330	0	
4:30 PM	0	5	207	5	0	8	58	5	0	2	6	7	0	29	7	1	340	0	
4:45 PM	0	3	195	4	0	1	89	10	0	4	5	6	0	38	22	1	378	1,390	
5:00 PM	0	3	252	5	0	0	80	12	0	1	7	6	0	41	15	0	422	1,470	
5:15 PM	0	4	237	4	0	1	93	10	0	2	9	6	0	32	11	1	410	1,550	
5:30 PM	0	6	232	4	0	3	84	6	0	2	6	4	0	32	6	1	386	1,596	
5:45 PM	0	7	195	6	0	2	81	7	0	0	3	11	0	42	13	0	367	1,585	
Count Total	0	36	1703	39	0	24	636	62	0	17	50	48	0	257	98	5	2,975	0	
Peak Hour	All	0	16	916	17	0	5	346	38	0	9	27	22	0	143	54	3	1,596	0
	HV	0	0	21	0	0	0	17	0	0	0	0	0	0	3	0	0	41	0
	HV%	-	0%	2%	0%	-	0%	5%	0%	-	0%	0%	0%	-	2%	0%	0%	3%	0

Note: Two-hour count summary volumes include heavy vehicles but exclude bicycles in overall count.

Interval Start	Heavy Vehicle Totals					Bicycles					Pedestrians (Crossing Leg)				
	EB	WB	NB	SB	Total	EB	WB	NB	SB	Total	East	West	North	South	Total
4:00 PM	5	3	0	1	9	2	1	1	3	7	6	0	0	9	15
4:15 PM	5	3	0	0	8	4	3	3	2	12	10	0	0	19	29
4:30 PM	3	5	0	1	9	0	2	2	1	5	4	0	0	14	18
4:45 PM	6	7	0	0	13	3	1	1	1	6	5	0	0	12	17
5:00 PM	8	3	0	1	12	1	2	1	0	4	5	1	0	5	11
5:15 PM	5	4	0	1	10	2	1	0	2	5	0	0	0	2	2
5:30 PM	2	3	0	1	6	2	1	0	0	3	8	2	0	13	23
5:45 PM	3	5	0	0	8	3	2	3	1	9	3	0	0	8	11
Count Total	37	33	0	5	75	17	13	11	10	51	41	3	0	82	126
Peak Hour	21	17	0	3	41	8	5	2	3	18	18	3	0	32	53

Two-Hour Count Summaries - Heavy Vehicles																		
Interval Start	E Santa Clara St				E Santa Clara St				S 17th St				N 17th St				15-min Total	Rolling One Hour
	Eastbound				Westbound				Northbound				Southbound					
	UT	LT	TH	RT	UT	LT	TH	RT	UT	LT	TH	RT	UT	LT	TH	RT		
4:00 PM	0	0	5	0	0	0	3	0	0	0	0	0	0	1	0	0	9	0
4:15 PM	0	0	5	0	0	0	3	0	0	0	0	0	0	0	0	0	8	0
4:30 PM	0	0	3	0	0	0	5	0	0	0	0	0	0	1	0	0	9	0
4:45 PM	0	0	6	0	0	0	7	0	0	0	0	0	0	0	0	0	13	39
5:00 PM	0	0	8	0	0	0	3	0	0	0	0	0	0	1	0	0	12	42
5:15 PM	0	0	5	0	0	0	4	0	0	0	0	0	0	1	0	0	10	44
5:30 PM	0	0	2	0	0	0	3	0	0	0	0	0	0	1	0	0	6	41
5:45 PM	0	0	3	0	0	0	5	0	0	0	0	0	0	0	0	0	8	36
Count Total	0	0	37	0	0	0	33	0	0	0	0	0	0	5	0	0	75	0
Peak Hour	0	0	21	0	0	0	17	0	0	0	0	0	0	3	0	0	41	0

Two-Hour Count Summaries - Bikes														
Interval Start	E Santa Clara St			E Santa Clara St			S 17th St			N 17th St			15-min Total	Rolling One Hour
	Eastbound			Westbound			Northbound			Southbound				
	LT	TH	RT	LT	TH	RT	LT	TH	RT	LT	TH	RT		
4:00 PM	0	2	0	0	1	0	0	0	1	2	0	1	7	0
4:15 PM	0	4	0	0	2	1	0	3	0	1	1	0	12	0
4:30 PM	0	0	0	0	1	1	0	1	1	0	1	0	5	0
4:45 PM	0	3	0	0	1	0	0	1	0	0	1	0	6	30
5:00 PM	0	1	0	0	1	1	0	1	0	0	0	0	4	27
5:15 PM	0	2	0	0	1	0	0	0	0	0	2	0	5	20
5:30 PM	0	2	0	0	1	0	0	0	0	0	0	0	3	18
5:45 PM	0	3	0	0	1	1	0	2	1	0	1	0	9	21
Count Total	0	17	0	0	9	4	0	8	3	3	6	1	51	0
Peak Hour	0	8	0	0	4	1	0	2	0	0	3	0	18	0

Note: U-Turn volumes for bikes are included in Left-Turn, if any.

INTERSECTION CAR/PED/BIKE TRAFFIC COUNT RESULTS SUMMARY

CLIENT: KIMLEY-HORN AND ASSOCIATES, INC
 PROJECT: SAN JOSE / SANTA CLARA
 DATE: TUESDAY NOVEMBER 5, 2013
 PERIOD: 7:00 AM TO 9:00 AM
 INTERSECTION: N/S 24TH STREET
 E/W E. SANTA CLARA STREET
 CITY: SAN JOSE

VEHICLE COUNTS

15 MIN COUNTS	1	2	3	4	5	6	7	8	9	10	11	12	TOTAL
PERIOD	SBRT	SBTH	SBLT	WBRT	WBTH	WBLT	NBRT	NBTH	NBLT	EBRT	EBTH	EBLT	TOTAL
700-715	7	19	1	10	158	14	37	82	23	8	64	10	433
715-730	9	32	2	9	186	13	35	72	17	7	73	9	464
730-745	25	24	4	16	212	15	35	75	24	10	76	22	538
745-800	27	41	10	13	222	15	28	53	20	6	92	14	541
800-815	15	40	5	4	181	18	27	64	15	14	100	14	497
815-830	11	36	4	6	207	19	27	73	27	8	86	1	505
830-845	8	25	2	4	189	9	35	67	44	8	77	3	471
845-900	10	21	1	6	223	11	28	60	34	8	88	8	498
HOUR TOTALS	1	2	3	4	5	6	7	8	9	10	11	12	TOTAL
PERIOD	SBRT	SBTH	SBLT	WBRT	WBTH	WBLT	NBRT	NBTH	NBLT	EBRT	EBTH	EBLT	TOTAL
700-800	68	116	17	48	778	57	135	282	84	31	305	55	1976
715-815	76	137	21	42	801	61	125	264	76	37	341	59	2040
730-830	78	141	23	39	822	67	117	265	86	38	354	51	2081
745-845	61	142	21	27	799	61	117	257	106	36	355	32	2014
800-900	44	122	12	20	800	57	117	264	120	38	351	26	1971

PEAK HOUR
730-830
PEAK HOUR FACTOR
0.96

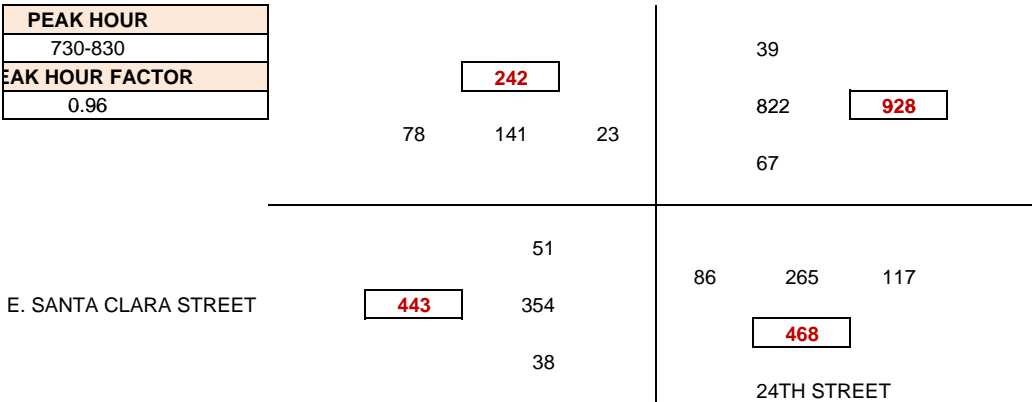

PEDESTRIAN COUNTS

15 MIN COUNTS	NORTH	EAST	SOUTH	WEST	TOTAL
PERIOD	LEG	LEG	LEG	LEG	
700-715	3	2	0	3	8
715-730	2	0	2	4	8
730-745	3	10	1	17	31
745-800	5	10	2	6	23
800-815	5	2	2	7	16
815-830	3	0	3	2	8
830-845	6	3	0	5	14
845-900	3	0	7	1	11
HOUR TOTALS	NORTH	EAST	SOUTH	WEST	TOTAL
PERIOD	LEG	LEG	LEG	LEG	
700-800	13	22	5	30	70
715-815	15	22	7	34	78
730-830	16	22	8	32	78
745-845	19	15	7	20	61
800-900	17	5	12	15	49

BICYCLE COUNTS

15 MIN COUNTS	NORTH	EAST	SOUTH	WEST	TOTAL
PERIOD	LEG	LEG	LEG	LEG	
700-715	0	0	1	1	2
715-730	1	2	0	1	4
730-745	1	0	1	0	2
745-800	1	0	6	1	8
800-815	0	0	0	0	0
815-830	0	2	2	0	4
830-845	0	0	2	0	2
845-900	5	0	0	1	6
HOUR TOTALS	NORTH	EAST	SOUTH	WEST	TOTAL
PERIOD	LEG	LEG	LEG	LEG	
700-800	3	2	8	3	16
715-815	3	2	7	2	14
730-830	2	2	9	1	14
745-845	1	2	10	1	14
800-900	5	2	4	1	12

INTERSECTION CAR/PED/BIKE TRAFFIC COUNT RESULTS SUMMARY

CLIENT: KIMLEY-HORN AND ASSOCIATES, INC
 PROJECT: SAN JOSE / SANTA CLARA
 DATE: TUESDAY NOVEMBER 5, 2013
 PERIOD: 4:00 PM TO 6:00 PM
 INTERSECTION: N/S 24TH STREET
 E/W E. SANTA CLARA STREET
 CITY: SAN JOSE

VEHICLE COUNTS													
15 MIN COUNTS	1	2	3	4	5	6	7	8	9	10	11	12	
PERIOD	SBRT	SBTH	SBLT	WBRT	WBTH	WBLT	NBRT	NBTH	NBLT	EBRT	EBTH	EBLT	TOTAL
400-415	11	67	13	6	109	40	21	42	7	25	157	12	510
415-430	9	61	9	8	94	38	20	31	16	31	163	14	494
430-445	18	75	9	10	121	59	23	38	8	32	206	14	613
445-500	4	65	4	6	88	23	26	24	17	31	212	8	508
500-515	8	55	18	10	86	30	21	22	12	27	221	28	538
515-530	12	59	9	10	94	28	32	39	7	33	244	18	585
530-545	14	66	6	7	97	47	29	37	15	30	200	9	557
545-600	10	46	10	8	119	39	27	21	15	39	201	14	549
HOUR TOTALS	1	2	3	4	5	6	7	8	9	10	11	12	
PERIOD	SBRT	SBTH	SBLT	WBRT	WBTH	WBLT	NBRT	NBTH	NBLT	EBRT	EBTH	EBLT	TOTAL
400-500	42	268	35	30	412	160	90	135	48	119	738	48	2125
415-515	39	256	40	34	389	150	90	115	53	121	802	64	2153
430-530	42	254	40	36	389	140	102	123	44	123	883	68	2244
445-545	38	245	37	33	365	128	108	122	51	121	877	63	2188
500-600	44	226	43	35	396	144	109	119	49	129	866	69	2229

PEAK HOUR							
430-530					36		
PEAK HOUR FACTOR					389		
0.92					140		
		42	254	40			
					68		
E. SANTA CLARA STREET	1074		883		44	123	102
					269		
					24TH STREET		

PEDESTRIAN COUNTS					
15 MIN COUNTS	NORTH LEG	EAST LEG	SOUTH LEG	WEST LEG	TOTAL
PERIOD					
400-415	3	5	7	6	21
415-430	4	1	10	11	26
430-445	2	2	16	11	31
445-500	3	1	7	7	18
500-515	4	0	6	5	15
515-530	3	2	7	13	25
530-545	1	2	4	5	12
545-600	4	4	10	7	25
HOUR TOTALS	NORTH LEG	EAST LEG	SOUTH LEG	WEST LEG	TOTAL
PERIOD					
400-500	12	9	40	35	96
415-515	13	4	39	34	90
430-530	12	5	36	36	89
445-545	11	5	24	30	70
500-600	12	8	27	30	77

BICYCLE COUNTS					
15 MIN COUNTS	NORTH LEG	EAST LEG	SOUTH LEG	WEST LEG	TOTAL
PERIOD					
400-415	2	0	1	1	4
415-430	2	2	2	1	7
430-445	5	1	4	0	10
445-500	4	3	1	0	8
500-515	4	2	6	6	18
515-530	7	1	5	4	17
530-545	6	0	2	3	11
545-600	4	0	3	1	8
HOUR TOTALS	NORTH LEG	EAST LEG	SOUTH LEG	WEST LEG	TOTAL
PERIOD					
400-500	13	6	8	2	29
415-515	15	8	13	7	43
430-530	20	7	16	10	53
445-545	21	6	14	13	54
500-600	21	3	16	14	54

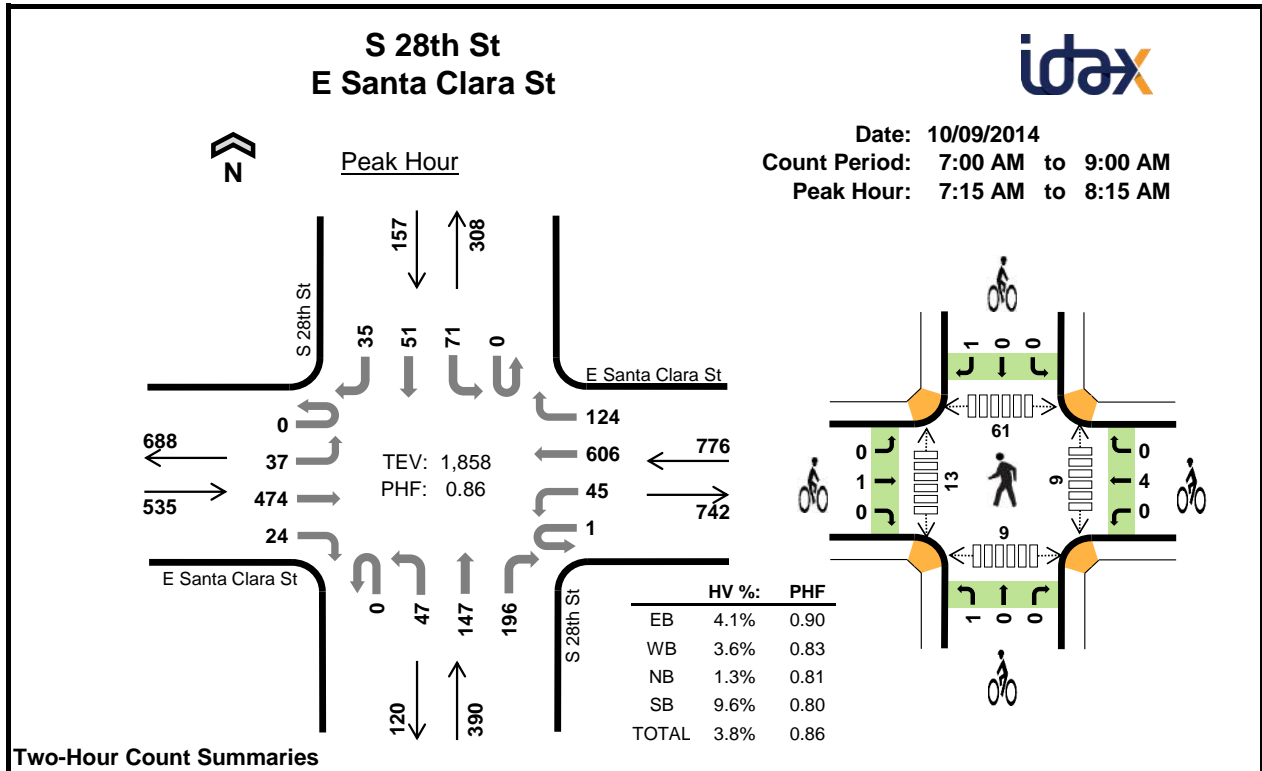

Two-Hour Count Summaries

Interval Start	E Santa Clara St Eastbound				E Santa Clara St Westbound				S 28th St Northbound				S 28th St Southbound				15-min Total	Rolling One Hour	
	UT	LT	TH	RT	UT	LT	TH	RT	UT	LT	TH	RT	UT	LT	TH	RT			
7:00 AM	0	7	99	4	0	9	100	18	0	14	18	49	0	10	3	5	336	0	
7:15 AM	0	9	101	5	0	13	143	30	0	14	22	54	0	15	5	8	419	0	
7:30 AM	0	14	107	3	1	14	156	35	0	8	53	60	0	18	10	14	493	0	
7:45 AM	0	9	132	8	0	14	177	43	0	14	48	47	0	19	22	8	541	1,789	
8:00 AM	0	5	134	8	0	4	130	16	0	11	24	35	0	19	14	5	405	1,858	
8:15 AM	0	3	110	3	0	9	155	17	0	6	7	47	0	6	7	2	372	1,811	
8:30 AM	0	5	108	2	0	6	159	12	0	11	13	43	0	6	5	4	374	1,692	
8:45 AM	0	6	119	1	0	6	191	9	0	10	12	31	0	1	7	5	398	1,549	
Count Total	0	58	910	34	1	75	1211	180	0	88	197	366	0	94	73	51	3,338	0	
Peak Hour	All	0	37	474	24	1	45	606	124	0	47	147	196	0	71	51	35	1,858	0
	HV	0	4	18	0	1	1	24	2	0	0	2	3	0	9	0	6	70	0
	HV%	-	11%	4%	0%	100%	2%	4%	2%	-	0%	1%	2%	-	13%	0%	17%	4%	0

Note: Two-hour count summary volumes include heavy vehicles but exclude bicycles in overall count.

Interval Start	Heavy Vehicle Totals					Bicycles					Pedestrians (Crossing Leg)				
	EB	WB	NB	SB	Total	EB	WB	NB	SB	Total	East	West	North	South	Total
7:00 AM	4	5	1	1	11	0	1	0	0	1	5	1	9	1	16
7:15 AM	6	8	1	3	18	0	1	0	0	1	6	5	15	5	31
7:30 AM	4	8	1	3	16	1	2	0	0	3	2	3	9	1	15
7:45 AM	6	5	2	5	18	0	1	1	1	3	1	2	10	2	15
8:00 AM	6	7	1	4	18	0	0	0	0	0	0	3	27	1	31
8:15 AM	11	7	2	1	21	0	1	0	0	1	4	3	5	2	14
8:30 AM	3	9	2	0	14	0	2	1	0	3	3	1	7	2	13
8:45 AM	11	10	1	2	24	0	1	0	0	1	5	5	27	4	41
Count Total	51	59	11	19	140	1	9	2	1	13	26	23	109	18	176
Peak Hour	22	28	5	15	70	1	4	1	1	7	9	13	61	9	92

Two-Hour Count Summaries - Heavy Vehicles																		
Interval Start	E Santa Clara St				E Santa Clara St				S 28th St				S 28th St				15-min Total	Rolling One Hour
	Eastbound				Westbound				Northbound				Southbound					
	UT	LT	TH	RT	UT	LT	TH	RT	UT	LT	TH	RT	UT	LT	TH	RT		
7:00 AM	0	0	4	0	0	0	5	0	0	0	0	1	0	0	0	1	11	0
7:15 AM	0	1	5	0	0	0	7	1	0	0	1	0	0	1	0	2	18	0
7:30 AM	0	1	3	0	1	0	7	0	0	0	0	1	0	3	0	0	16	0
7:45 AM	0	1	5	0	0	0	4	1	0	0	1	1	0	2	0	3	18	63
8:00 AM	0	1	5	0	0	1	6	0	0	0	0	1	0	3	0	1	18	70
8:15 AM	0	1	10	0	0	1	5	1	0	0	0	2	0	0	0	1	21	73
8:30 AM	0	0	3	0	0	0	8	1	0	0	0	2	0	0	0	0	14	71
8:45 AM	0	1	10	0	0	0	8	2	0	1	0	0	0	0	0	2	24	77
Count Total	0	6	45	0	1	2	50	6	0	1	2	8	0	9	0	10	140	0
Peak Hour	0	4	18	0	1	1	24	2	0	0	2	3	0	9	0	6	70	0

Two-Hour Count Summaries - Bikes																	
Interval Start	E Santa Clara St			E Santa Clara St			S 28th St			S 28th St			15-min Total	Rolling One Hour			
	Eastbound			Westbound			Northbound			Southbound							
	LT	TH	RT	LT	TH	RT	LT	TH	RT	LT	TH	RT					
7:00 AM	0	0	0	0	1	0	0	0	0	0	0	0	0	0	1	0	
7:15 AM	0	0	0	0	1	0	0	0	0	0	0	0	0	0	1	0	
7:30 AM	0	1	0	0	2	0	0	0	0	0	0	0	0	0	3	0	
7:45 AM	0	0	0	0	1	0	1	0	0	0	0	0	0	0	1	3	8
8:00 AM	0	0	0	0	0	0	0	0	0	0	0	0	0	0	0	7	7
8:15 AM	0	0	0	0	1	0	0	0	0	0	0	0	0	0	1	7	7
8:30 AM	0	0	0	0	2	0	0	1	0	0	0	0	0	0	3	7	7
8:45 AM	0	0	0	0	1	0	0	0	0	0	0	0	0	0	1	5	5
Count Total	0	1	0	0	9	0	1	1	0	0	0	1	0	0	13	0	0
Peak Hour	0	1	0	0	4	0	1	0	0	0	0	0	0	0	7	0	0

Note: U-Turn volumes for bikes are included in Left-Turn, if any.

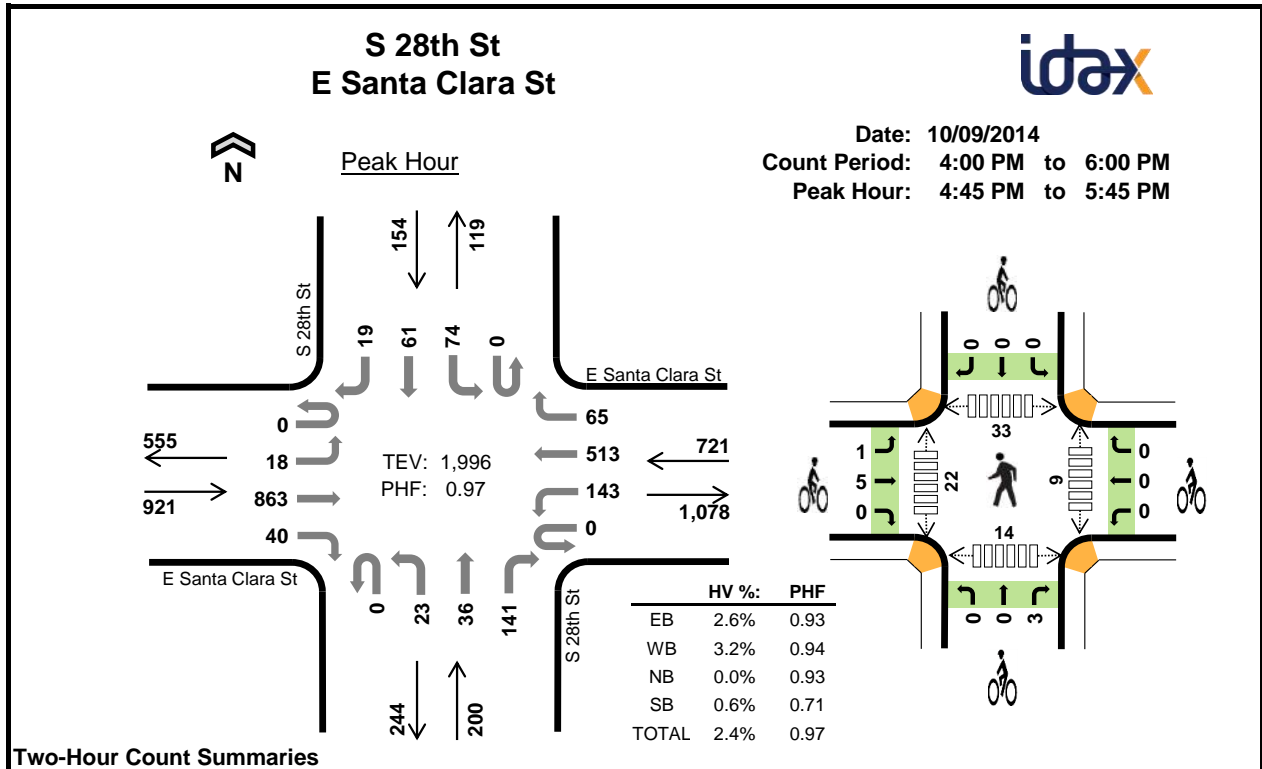

Two-Hour Count Summaries

Interval Start	E Santa Clara St Eastbound				E Santa Clara St Westbound				S 28th St Northbound				S 28th St Southbound				15-min Total	Rolling One Hour	
	UT	LT	TH	RT	UT	LT	TH	RT	UT	LT	TH	RT	UT	LT	TH	RT			
4:00 PM	0	2	193	8	0	36	130	21	0	4	10	28	0	16	20	4	472	0	
4:15 PM	0	5	196	16	0	25	131	25	0	4	13	35	0	26	15	11	502	0	
4:30 PM	0	3	189	8	0	37	105	19	0	4	8	31	0	20	9	7	440	0	
4:45 PM	0	2	217	7	0	36	140	15	0	5	7	32	0	29	20	5	515	1,929	
5:00 PM	0	11	197	7	0	40	112	20	0	5	11	35	0	16	17	7	478	1,935	
5:15 PM	0	0	234	13	0	33	132	14	0	4	10	40	0	16	11	2	509	1,942	
5:30 PM	0	5	215	13	0	34	129	16	0	9	8	34	0	13	13	5	494	1,996	
5:45 PM	0	2	200	11	0	31	124	9	0	13	9	36	0	15	13	12	475	1,956	
Count Total	0	30	1641	83	0	272	1003	139	0	48	76	271	0	151	118	53	3,885	0	
Peak Hour	All	0	18	863	40	0	143	513	65	0	23	36	141	0	74	61	19	1,996	0
	HV	0	1	23	0	0	1	20	2	0	0	0	0	0	1	0	0	48	0
	HV%	-	6%	3%	0%	-	1%	4%	3%	-	0%	0%	0%	-	1%	0%	0%	2%	0

Note: Two-hour count summary volumes include heavy vehicles but exclude bicycles in overall count.

Interval Start	Heavy Vehicle Totals					Bicycles					Pedestrians (Crossing Leg)				
	EB	WB	NB	SB	Total	EB	WB	NB	SB	Total	East	West	North	South	Total
4:00 PM	8	6	1	0	15	2	0	0	1	3	1	4	5	3	13
4:15 PM	7	5	1	1	14	0	0	0	0	0	3	7	9	3	22
4:30 PM	4	5	0	0	9	1	0	0	1	2	4	1	9	0	14
4:45 PM	7	8	0	1	16	3	0	2	0	5	0	16	18	6	40
5:00 PM	6	6	0	0	12	1	0	1	0	2	4	1	7	3	15
5:15 PM	6	3	0	0	9	2	0	0	0	2	2	3	5	3	13
5:30 PM	5	6	0	0	11	0	0	0	0	0	3	2	3	2	10
5:45 PM	6	2	2	1	11	0	1	1	0	2	0	2	6	1	9
Count Total	49	41	4	3	97	9	1	4	2	16	17	36	62	21	136
Peak Hour	24	23	0	1	48	6	0	3	0	9	9	22	33	14	78

Two-Hour Count Summaries - Heavy Vehicles																		
Interval Start	E Santa Clara St				E Santa Clara St				S 28th St				S 28th St				15-min Total	Rolling One Hour
	Eastbound				Westbound				Northbound				Southbound					
	UT	LT	TH	RT	UT	LT	TH	RT	UT	LT	TH	RT	UT	LT	TH	RT		
4:00 PM	0	0	8	0	0	0	5	1	0	0	1	0	0	0	0	0	15	0
4:15 PM	0	0	6	1	0	0	4	1	0	0	1	0	0	1	0	0	14	0
4:30 PM	0	0	3	1	0	1	4	0	0	0	0	0	0	0	0	0	9	0
4:45 PM	0	0	7	0	0	0	6	2	0	0	0	0	0	1	0	0	16	54
5:00 PM	0	1	5	0	0	1	5	0	0	0	0	0	0	0	0	0	12	51
5:15 PM	0	0	6	0	0	0	3	0	0	0	0	0	0	0	0	0	9	46
5:30 PM	0	0	5	0	0	0	6	0	0	0	0	0	0	0	0	0	11	48
5:45 PM	0	0	6	0	0	0	2	0	0	1	1	0	0	0	1	0	11	43
Count Total	0	1	46	2	0	2	35	4	0	1	3	0	0	2	1	0	97	0
Peak Hour	0	1	23	0	0	1	20	2	0	0	0	0	0	1	0	0	48	0

Two-Hour Count Summaries - Bikes														
Interval Start	E Santa Clara St			E Santa Clara St			S 28th St			S 28th St			15-min Total	Rolling One Hour
	Eastbound			Westbound			Northbound			Southbound				
	LT	TH	RT	LT	TH	RT	LT	TH	RT	LT	TH	RT		
4:00 PM	0	2	0	0	0	0	0	0	0	0	1	0	3	0
4:15 PM	0	0	0	0	0	0	0	0	0	0	0	0	0	0
4:30 PM	0	1	0	0	0	0	0	0	0	0	0	1	2	0
4:45 PM	1	2	0	0	0	0	0	0	2	0	0	0	5	10
5:00 PM	0	1	0	0	0	0	0	0	1	0	0	0	2	9
5:15 PM	0	2	0	0	0	0	0	0	0	0	0	0	2	11
5:30 PM	0	0	0	0	0	0	0	0	0	0	0	0	0	9
5:45 PM	0	0	0	0	1	0	0	1	0	0	0	0	2	6
Count Total	1	8	0	0	1	0	0	1	3	0	1	1	16	0
Peak Hour	1	5	0	0	0	0	0	0	3	0	0	0	9	0

Note: U-Turn volumes for bikes are included in Left-Turn, if any.

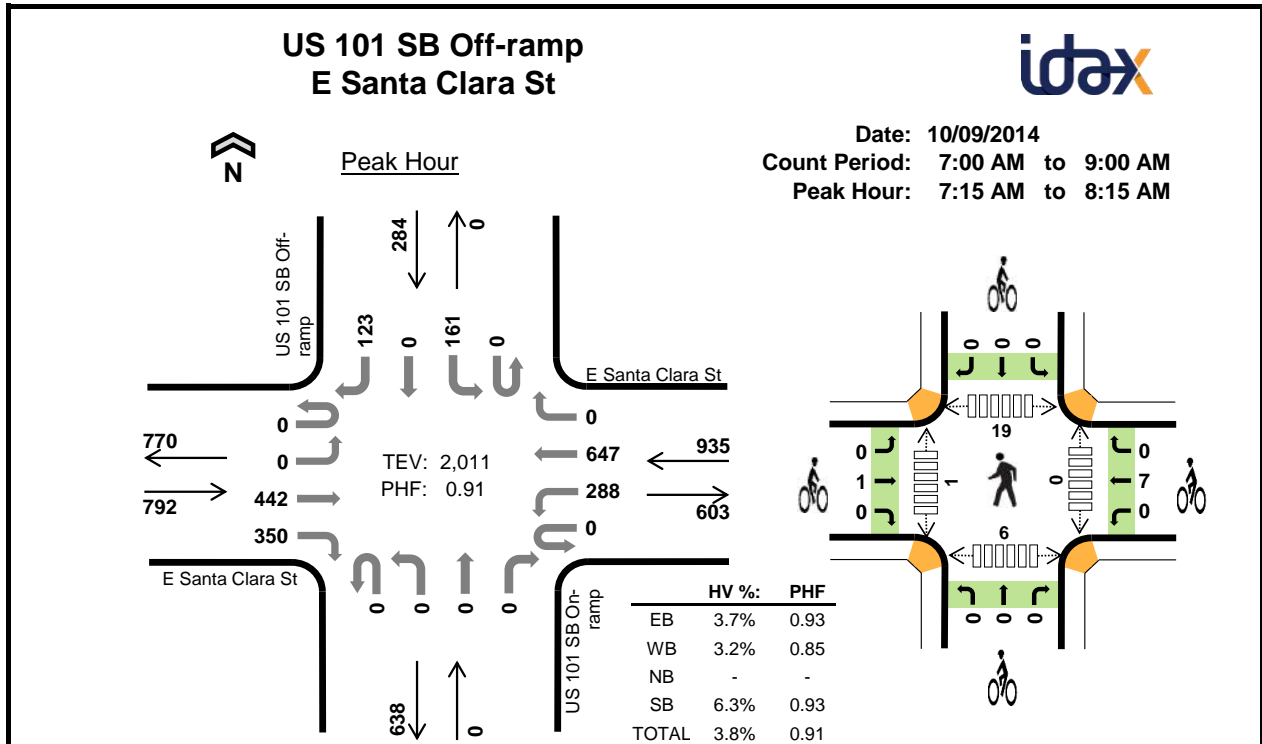

Two-Hour Count Summaries

Interval Start	E Santa Clara St Eastbound				E Santa Clara St Westbound				US 101 SB On-ramp Northbound				US 101 SB Off-ramp Southbound				15-min Total	Rolling One Hour	
	UT	LT	TH	RT	UT	LT	TH	RT	UT	LT	TH	RT	UT	LT	TH	RT			
7:00 AM	0	0	88	69	0	76	106	0	0	0	0	0	0	34	0	26	399	0	
7:15 AM	0	0	104	81	0	68	151	0	0	0	0	0	0	42	0	27	473	0	
7:30 AM	0	0	93	93	0	77	176	0	0	0	0	0	0	46	0	30	515	0	
7:45 AM	0	0	122	87	0	83	191	0	0	0	0	0	0	35	0	36	554	1,941	
8:00 AM	0	0	123	89	0	60	129	0	0	0	0	0	0	38	0	30	469	2,011	
8:15 AM	0	0	91	68	0	61	152	0	0	0	0	0	0	40	0	27	439	1,977	
8:30 AM	0	0	94	62	0	58	153	0	0	0	0	0	0	23	0	21	411	1,873	
8:45 AM	0	0	75	66	0	61	184	0	0	0	0	0	0	22	0	35	443	1,762	
Count Total	0	0	790	615	0	544	1242	0	0	0	0	0	0	280	0	232	3,703	0	
Peak Hour	All	0	0	442	350	0	288	647	0	0	0	0	0	0	161	0	123	2,011	0
	HV	0	0	25	4	0	9	21	0	0	0	0	0	0	12	0	6	77	0
	HV%	-	-	6%	1%	-	3%	3%	-	-	-	-	-	-	7%	-	5%	4%	0

Note: Two-hour count summary volumes include heavy vehicles but exclude bicycles in overall count.

Interval Start	Heavy Vehicle Totals					Bicycles					Pedestrians (Crossing Leg)				
	EB	WB	NB	SB	Total	EB	WB	NB	SB	Total	East	West	North	South	Total
7:00 AM	4	8	0	3	15	2	2	0	0	4	0	0	7	1	8
7:15 AM	5	7	0	3	15	0	2	0	0	2	0	0	10	0	10
7:30 AM	8	6	0	2	16	1	4	0	0	5	0	0	2	1	3
7:45 AM	7	7	0	6	20	0	1	0	0	1	0	0	1	4	5
8:00 AM	9	10	0	7	26	0	0	0	0	0	0	1	6	1	8
8:15 AM	10	5	0	6	21	0	2	0	0	2	0	1	4	3	8
8:30 AM	9	13	0	1	23	0	3	0	0	3	0	0	5	0	5
8:45 AM	9	9	0	1	19	0	1	0	1	2	0	1	2	3	6
Count Total	61	65	0	29	155	3	15	0	1	19	0	3	37	13	53
Peak Hour	29	30	0	18	77	1	7	0	0	8	0	1	19	6	26

Two-Hour Count Summaries - Heavy Vehicles																		
Interval Start	E Santa Clara St				E Santa Clara St				US 101 SB On-ramp				US 101 SB Off-ramp				15-min Total	Rolling One Hour
	Eastbound				Westbound				Northbound				Southbound					
	UT	LT	TH	RT	UT	LT	TH	RT	UT	LT	TH	RT	UT	LT	TH	RT		
7:00 AM	0	0	4	0	0	3	5	0	0	0	0	0	0	3	0	0	15	0
7:15 AM	0	0	5	0	0	2	5	0	0	0	0	0	0	0	0	3	15	0
7:30 AM	0	0	7	1	0	0	6	0	0	0	0	0	0	2	0	0	16	0
7:45 AM	0	0	6	1	0	3	4	0	0	0	0	0	0	4	0	2	20	66
8:00 AM	0	0	7	2	0	4	6	0	0	0	0	0	0	6	0	1	26	77
8:15 AM	0	0	8	2	0	0	5	0	0	0	0	0	0	6	0	0	21	83
8:30 AM	0	0	7	2	0	5	8	0	0	0	0	0	0	1	0	0	23	90
8:45 AM	0	0	7	2	0	2	7	0	0	0	0	0	0	0	0	1	19	89
Count Total	0	0	51	10	0	19	46	0	0	0	0	0	0	22	0	7	155	0
Peak Hour	0	0	25	4	0	9	21	0	0	0	0	0	0	12	0	6	77	0

Two-Hour Count Summaries - Bikes														
Interval Start	E Santa Clara St			E Santa Clara St			US 101 SB On-ramp			US 101 SB Off-ramp			15-min Total	Rolling One Hour
	Eastbound			Westbound			Northbound			Southbound				
	LT	TH	RT	LT	TH	RT	LT	TH	RT	LT	TH	RT		
7:00 AM	0	2	0	0	2	0	0	0	0	0	0	0	4	0
7:15 AM	0	0	0	0	2	0	0	0	0	0	0	0	2	0
7:30 AM	0	1	0	0	4	0	0	0	0	0	0	0	5	0
7:45 AM	0	0	0	0	1	0	0	0	0	0	0	0	1	12
8:00 AM	0	0	0	0	0	0	0	0	0	0	0	0	0	8
8:15 AM	0	0	0	0	2	0	0	0	0	0	0	0	2	8
8:30 AM	0	0	0	0	3	0	0	0	0	0	0	0	3	6
8:45 AM	0	0	0	0	1	0	0	0	0	0	0	1	2	7
Count Total	0	3	0	0	15	0	0	0	0	0	0	1	19	0
Peak Hour	0	1	0	0	7	0	0	0	0	0	0	0	8	0

Note: U-Turn volumes for bikes are included in Left-Turn, if any.

INTERSECTION TURNING MOVEMENT COUNT SUMMARY

CLIENT: KITTELSON ASSOCIATES
 PROJECT: 2014 SCVTA CMP MONITORING
 DATE: TUESDAY SEPTEMBER 9, 2014
 PERIOD: 4:00 PM TO 6:00 PM
 INTERSECTION: N/S SB US-101 RAMPS
 E/W SANTA CLARA STREET (WEST)
 CITY: SAN JOSE

VEHICLES													
15 MIN COUNTS 4:00 PM TO 6:00 PM													
PERIOD	1 SBRT	2 SBTH	3 SBLT	4 WBRT	5 WBTH	6 WBLT	7 NBRT	8 NBTH	9 NBLT	10 EBRT	11 EBTH	12 EBLT	TOTAL
400-415	88	0	69	0	151	97	0	0	0	89	145	0	639
415-430	41	1	65	0	165	97	0	0	0	116	148	0	633
430-445	47	1	59	0	144	98	0	0	0	118	183	0	650
445-500	47	0	71	0	163	114	0	0	0	94	150	0	639
500-515	59	1	68	0	155	125	0	0	0	127	172	0	707
515-530	40	1	62	0	158	96	0	0	0	129	174	0	660
530-545	50	0	58	0	153	109	0	0	0	123	184	0	677
545-600	51	2	59	0	164	123	0	0	0	113	166	0	678
HOUR TOTALS													
TIME	1 SBRT	2 SBTH	3 SBLT	4 WBRT	5 WBTH	6 WBLT	7 NBRT	8 NBTH	9 NBLT	10 EBRT	11 EBTH	12 EBLT	TOTAL
400-500	223	2	264	0	623	406	0	0	0	417	626	0	2561
415-515	194	3	263	0	627	434	0	0	0	455	653	0	2629
430-530	193	3	260	0	620	433	0	0	0	468	679	0	2656
445-545	196	2	259	0	629	444	0	0	0	473	680	0	2683
500-600	200	4	247	0	630	453	0	0	0	492	696	0	2722

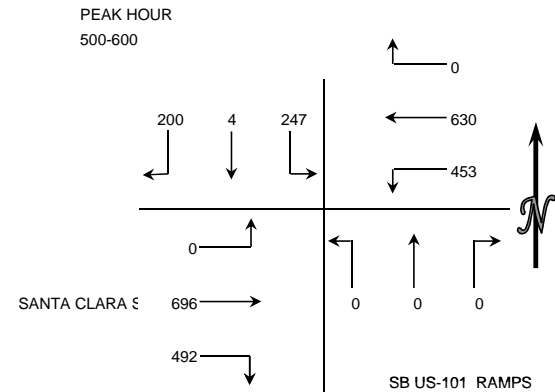

BICYCLES													
15 MIN COUNTS 4:00 PM TO 6:00 PM													
PERIOD	1 SBRT	2 SBTH	3 SBLT	4 WBRT	5 WBTH	6 WBLT	7 NBRT	8 NBTH	9 NBLT	10 EBRT	11 EBTH	12 EBLT	TOTAL
400-415	0	0	0	0	1	0	0	0	0	0	0	0	1
415-430	0	0	0	0	0	0	0	0	0	0	0	0	0
430-445	0	1	0	0	1	0	0	0	0	0	1	0	3
445-500	0	0	0	0	0	0	0	0	0	0	0	0	0
500-515	0	0	0	0	0	0	0	0	0	0	1	0	1
515-530	0	0	0	0	2	0	0	0	0	0	1	0	3
530-545	0	0	0	0	0	0	0	0	0	0	1	0	1
545-600	0	0	0	0	1	0	0	0	0	0	0	0	1
HOUR TOTALS													
TIME	1 SBRT	2 SBTH	3 SBLT	4 WBRT	5 WBTH	6 WBLT	7 NBRT	8 NBTH	9 NBLT	10 EBRT	11 EBTH	12 EBLT	TOTAL
400-500	0	1	0	0	2	0	0	0	0	0	1	0	4
415-515	0	1	0	0	1	0	0	0	0	0	2	0	4
430-530	0	1	0	0	3	0	0	0	0	0	3	0	7
445-545	0	0	0	0	2	0	0	0	0	0	3	0	5
500-600	0	0	0	0	3	0	0	0	0	0	3	0	6

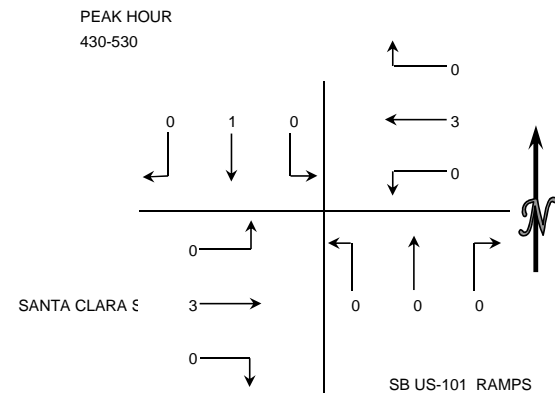

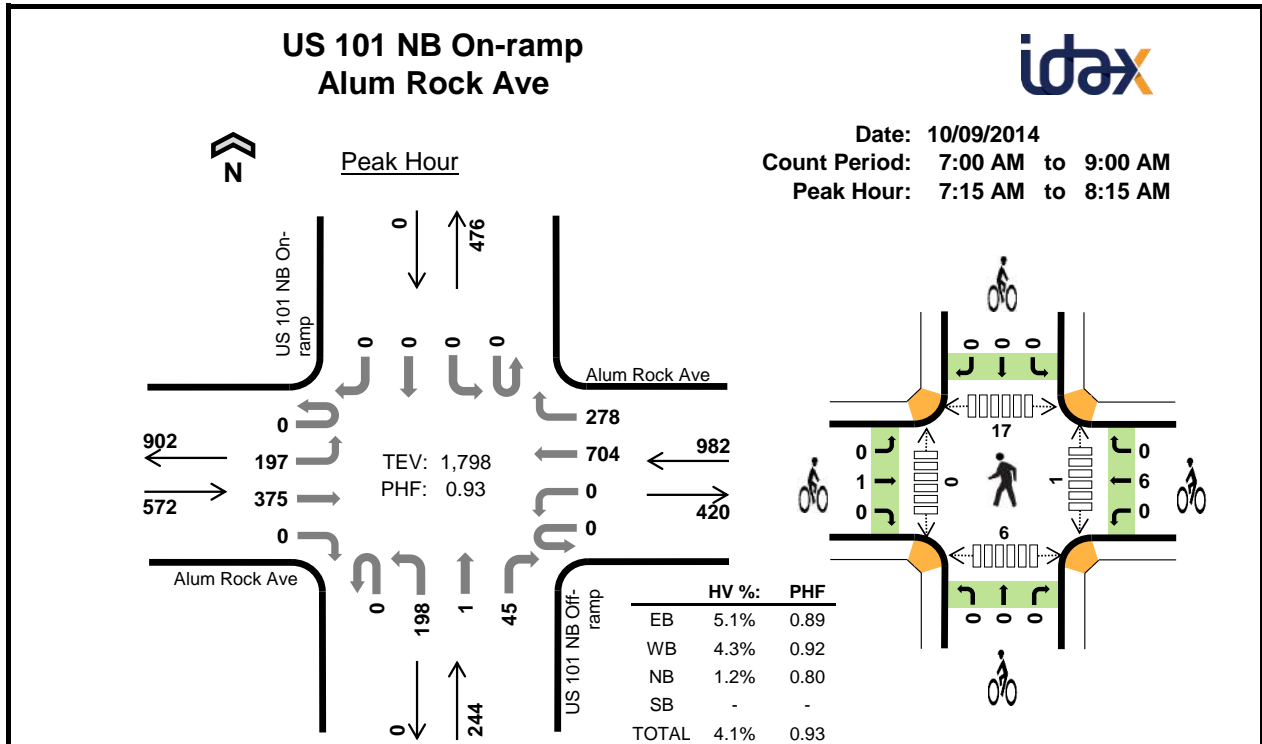

Two-Hour Count Summaries

Interval Start	Alum Rock Ave Eastbound				Alum Rock Ave Westbound				US 101 NB Off-ramp Northbound				US 101 NB On-ramp Southbound				15-min Total	Rolling One Hour	
	UT	LT	TH	RT	UT	LT	TH	RT	UT	LT	TH	RT	UT	LT	TH	RT			
7:00 AM	0	47	66	0	0	0	138	89	0	38	0	7	0	0	0	0	385	0	
7:15 AM	0	59	72	0	0	0	153	93	0	48	0	12	0	0	0	0	437	0	
7:30 AM	0	42	92	0	0	0	188	61	0	65	1	10	0	0	0	0	459	0	
7:45 AM	0	54	92	0	0	0	202	65	0	58	0	11	0	0	0	0	482	1,763	
8:00 AM	0	42	119	0	0	0	161	59	0	27	0	12	0	0	0	0	420	1,798	
8:15 AM	0	49	69	0	0	0	159	60	0	56	1	19	0	0	0	0	413	1,774	
8:30 AM	0	41	78	0	0	0	148	58	0	58	0	12	0	0	0	0	395	1,710	
8:45 AM	1	29	69	0	0	0	178	43	0	66	0	23	0	0	0	0	409	1,637	
Count Total	1	363	657	0	0	0	1327	528	0	416	2	106	0	0	0	0	3,400	0	
Peak Hour	All	0	197	375	0	0	0	704	278	0	198	1	45	0	0	0	0	1,798	0
	HV	0	4	25	0	0	0	27	15	0	3	0	0	0	0	0	0	74	0
	HV%	-	2%	7%	-	-	-	4%	5%	-	2%	0%	0%	-	-	-	-	4%	0

Note: Two-hour count summary volumes include heavy vehicles but exclude bicycles in overall count.

Interval Start	Heavy Vehicle Totals					Bicycles					Pedestrians (Crossing Leg)				
	EB	WB	NB	SB	Total	EB	WB	NB	SB	Total	East	West	North	South	Total
7:00 AM	9	11	0	0	20	2	3	0	0	5	1	0	7	2	10
7:15 AM	5	6	1	0	12	0	1	0	0	1	0	0	7	1	8
7:30 AM	8	12	1	0	21	0	2	0	0	2	0	0	4	0	4
7:45 AM	9	9	1	0	19	0	1	0	0	1	0	0	2	3	5
8:00 AM	7	15	0	0	22	1	2	0	0	3	1	0	4	2	7
8:15 AM	10	10	2	0	22	0	1	0	0	1	2	0	5	3	10
8:30 AM	8	14	3	0	25	0	2	0	0	2	0	0	4	0	4
8:45 AM	6	9	1	0	16	0	1	0	0	1	1	0	4	2	7
Count Total	62	86	9	0	157	3	13	0	0	16	5	0	37	13	55
Peak Hour	29	42	3	0	74	1	6	0	0	7	1	0	17	6	24

Two-Hour Count Summaries - Heavy Vehicles																		
Interval Start	Alum Rock Ave				Alum Rock Ave				US 101 NB Off-ramp				US 101 NB On-ramp				15-min Total	Rolling One Hour
	Eastbound				Westbound				Northbound				Southbound					
	UT	LT	TH	RT	UT	LT	TH	RT	UT	LT	TH	RT	UT	LT	TH	RT		
7:00 AM	0	1	8	0	0	0	10	1	0	0	0	0	0	0	0	0	20	0
7:15 AM	0	2	3	0	0	0	4	2	0	1	0	0	0	0	0	0	12	0
7:30 AM	0	0	8	0	0	0	9	3	0	1	0	0	0	0	0	0	21	0
7:45 AM	0	2	7	0	0	0	4	5	0	1	0	0	0	0	0	0	19	72
8:00 AM	0	0	7	0	0	0	10	5	0	0	0	0	0	0	0	0	22	74
8:15 AM	0	3	7	0	0	0	9	1	0	1	0	1	0	0	0	0	22	84
8:30 AM	0	1	7	0	0	0	11	3	0	3	0	0	0	0	0	0	25	88
8:45 AM	0	1	5	0	0	0	8	1	0	1	0	0	0	0	0	0	16	85
Count Total	0	10	52	0	0	0	65	21	0	8	0	1	0	0	0	0	157	0
Peak Hour	0	4	25	0	0	0	27	15	0	3	0	0	0	0	0	0	74	0
Two-Hour Count Summaries - Bikes																		
Interval Start	Alum Rock Ave			Alum Rock Ave			US 101 NB Off-ramp			US 101 NB On-ramp			15-min Total	Rolling One Hour				
	Eastbound			Westbound			Northbound			Southbound								
	LT	TH	RT	LT	TH	RT	LT	TH	RT	LT	TH	RT						
7:00 AM	0	2	0	0	3	0	0	0	0	0	0	0	5	0				
7:15 AM	0	0	0	0	1	0	0	0	0	0	0	0	1	0				
7:30 AM	0	0	0	0	2	0	0	0	0	0	0	0	2	0				
7:45 AM	0	0	0	0	1	0	0	0	0	0	0	0	1	9				
8:00 AM	0	1	0	0	2	0	0	0	0	0	0	0	3	7				
8:15 AM	0	0	0	0	1	0	0	0	0	0	0	0	1	7				
8:30 AM	0	0	0	0	2	0	0	0	0	0	0	0	2	7				
8:45 AM	0	0	0	0	1	0	0	0	0	0	0	0	1	7				
Count Total	0	3	0	0	13	0	0	0	0	0	0	0	16	0				
Peak Hour	0	1	0	0	6	0	0	0	0	0	0	0	7	0				
<i>Note: U-Turn volumes for bikes are included in Left-Turn, if any.</i>																		

INTERSECTION TURNING MOVEMENT COUNT SUMMARY

CLIENT: KITTELSON & ASSOCIATES, INC
 PROJECT: 2014 SCVTA CMP MONITORING
 DATE: TUESDAY SEPTEMBER 9, 2014
 PERIOD: 4:00 PM TO 6:00 PM
 INTERSECTION: N/S NB US-101 RAMP
 E/W SANTA CLARA STREET (EAST)
 CITY: SAN JOSE

VEHICLES													
15 MIN COUNTS													
4:00 PM TO 6:00 PM													
PERIOD	1	2	3	4	5	6	7	8	9	10	11	12	TOTAL
	SBRT	SBTH	SBLT	WBRT	WBTH	WBLT	NBRT	NBTH	NBLT	EBRT	EBTH	EBLT	
400-415	0	0	0	55	175	0	66	1	87	0	165	33	582
415-430	0	0	0	38	168	0	76	0	75	0	143	25	525
430-445	0	0	0	45	172	0	62	0	68	0	167	35	549
445-500	0	0	0	59	188	0	98	0	95	0	209	24	673
500-515	0	0	0	58	212	0	101	1	90	0	221	38	721
515-530	0	0	0	62	188	0	86	0	57	0	205	23	621
530-545	0	0	0	61	215	0	88	1	78	0	219	40	702
545-600	0	0	0	49	189	0	57	0	88	0	187	32	602
HOUR TOTALS													
TIME	1	2	3	4	5	6	7	8	9	10	11	12	TOTAL
	SBRT	SBTH	SBLT	WBRT	WBTH	WBLT	NBRT	NBTH	NBLT	EBRT	EBTH	EBLT	
400-500	0	0	0	197	703	0	302	1	325	0	684	117	2329
415-515	0	0	0	200	740	0	337	1	328	0	740	122	2468
430-530	0	0	0	224	760	0	347	1	310	0	802	120	2564
445-545	0	0	0	240	803	0	373	2	320	0	854	125	2717
500-600	0	0	0	230	804	0	332	2	313	0	832	133	2646

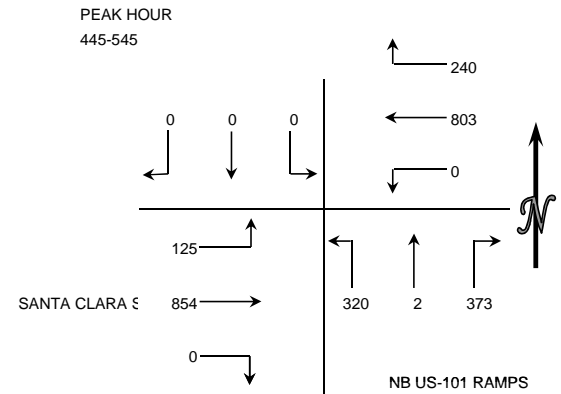

BICYCLES													
15 MIN COUNTS													
4:00 PM TO 6:00 PM													
PERIOD	1	2	3	4	5	6	7	8	9	10	11	12	TOTAL
	SBRT	SBTH	SBLT	WBRT	WBTH	WBLT	NBRT	NBTH	NBLT	EBRT	EBTH	EBLT	
400-415	0	0	0	1	1	0	1	0	0	0	0	0	3
415-430	0	0	0	4	2	0	0	0	0	0	0	0	6
430-445	0	0	0	0	0	0	0	0	0	0	0	0	0
445-500	0	0	0	1	0	0	0	0	0	0	0	0	1
500-515	0	0	0	0	1	0	0	0	0	0	0	0	1
515-530	0	0	0	0	0	0	0	0	0	0	0	0	0
530-545	0	0	0	0	0	0	0	0	0	0	0	0	0
545-600	0	0	0	0	1	0	1	0	0	0	0	0	2
HOUR TOTALS													
TIME	1	2	3	4	5	6	7	8	9	10	11	12	TOTAL
	SBRT	SBTH	SBLT	WBRT	WBTH	WBLT	NBRT	NBTH	NBLT	EBRT	EBTH	EBLT	
400-500	0	0	0	6	3	0	1	0	0	0	0	0	10
415-515	0	0	0	5	3	0	0	0	0	0	0	0	8
430-530	0	0	0	1	1	0	0	0	0	0	0	0	2
445-545	0	0	0	1	1	0	0	0	0	0	0	0	2
500-600	0	0	0	0	2	0	1	0	0	0	0	0	3

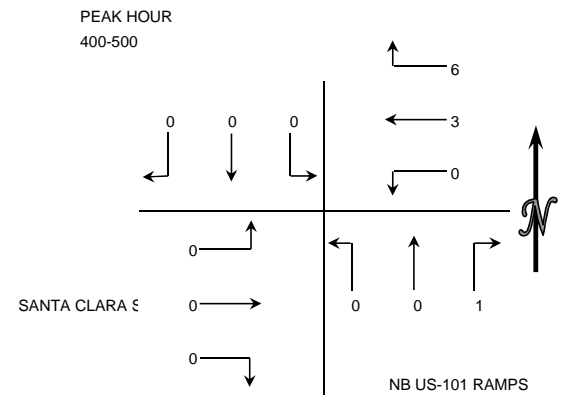

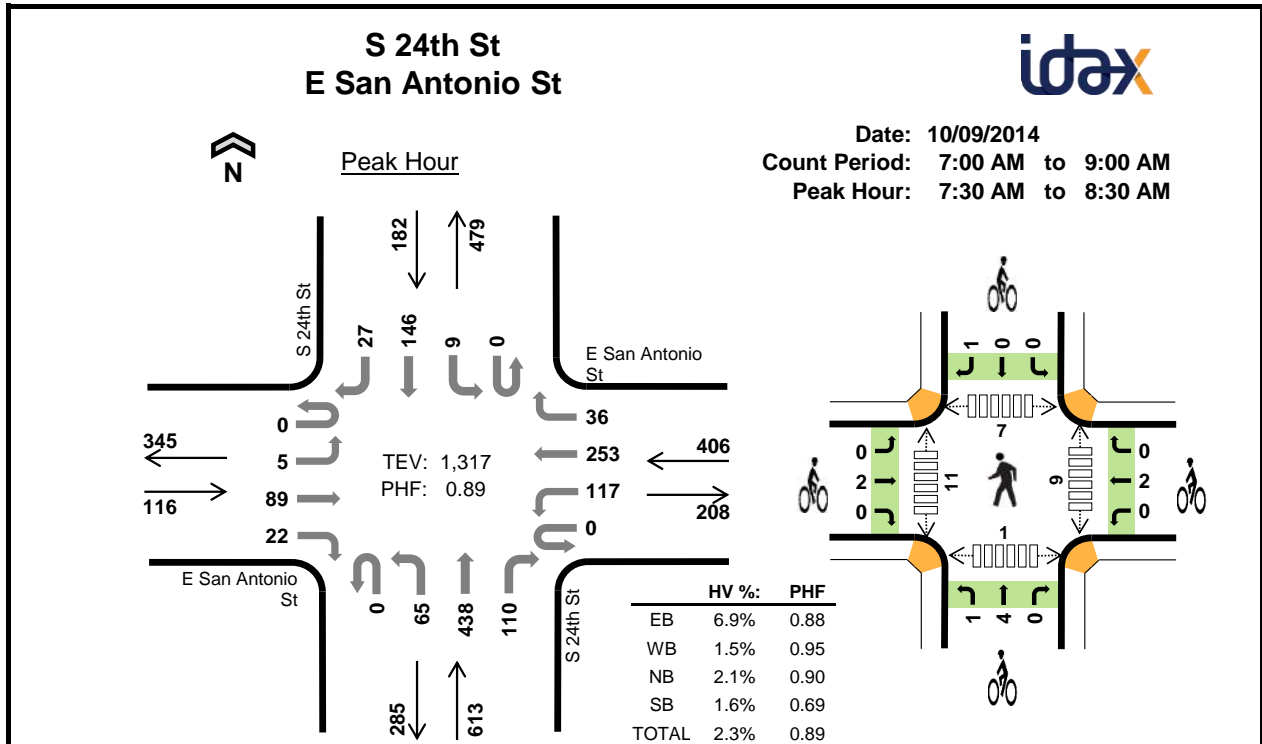

Two-Hour Count Summaries

Interval Start	E San Antonio St Eastbound				E San Antonio St Westbound				S 24th St Northbound				S 24th St Southbound				15-min Total	Rolling One Hour	
	UT	LT	TH	RT	UT	LT	TH	RT	UT	LT	TH	RT	UT	LT	TH	RT			
7:00 AM	0	0	10	4	0	22	16	6	0	6	89	12	0	3	25	0	193	0	
7:15 AM	0	2	19	0	0	30	72	6	0	12	106	24	0	0	34	2	307	0	
7:30 AM	0	1	27	5	0	32	62	12	0	15	125	24	0	4	37	4	348	0	
7:45 AM	0	4	21	4	0	29	68	10	0	22	117	28	0	0	55	11	369	1,217	
8:00 AM	0	0	23	6	0	32	65	5	0	10	78	23	0	3	33	7	285	1,309	
8:15 AM	0	0	18	7	0	24	58	9	0	18	118	35	0	2	21	5	315	1,317	
8:30 AM	0	3	22	7	0	21	68	5	0	18	108	26	0	4	31	7	320	1,289	
8:45 AM	0	3	24	5	0	25	57	11	0	14	116	22	0	2	26	9	314	1,234	
Count Total	0	13	164	38	0	215	466	64	0	115	857	194	0	18	262	45	2,451	0	
Peak Hour	All	0	5	89	22	0	117	253	36	0	65	438	110	0	9	146	27	1,317	0
	HV	0	0	2	6	0	0	6	0	0	7	3	3	0	0	3	0	30	0
	HV%	-	0%	2%	27%	-	0%	2%	0%	-	11%	1%	3%	-	0%	2%	0%	2%	0

Note: Two-hour count summary volumes include heavy vehicles but exclude bicycles in overall count.

Interval Start	Heavy Vehicle Totals					Bicycles					Pedestrians (Crossing Leg)				
	EB	WB	NB	SB	Total	EB	WB	NB	SB	Total	East	West	North	South	Total
7:00 AM	2	0	1	1	4	0	1	0	0	1	1	1	0	3	5
7:15 AM	1	2	5	3	11	2	0	1	0	3	1	3	1	4	9
7:30 AM	2	1	3	3	9	1	1	1	1	4	4	5	6	0	15
7:45 AM	2	2	3	0	7	0	1	1	0	2	2	3	0	0	5
8:00 AM	2	2	4	0	8	1	0	0	0	1	2	2	0	0	4
8:15 AM	2	1	3	0	6	0	0	3	0	3	1	1	1	1	4
8:30 AM	1	1	5	0	7	0	0	2	0	2	3	2	1	1	7
8:45 AM	1	3	2	2	8	0	0	0	0	0	3	2	2	0	7
Count Total	13	12	26	9	60	4	3	8	1	16	17	19	11	9	56
Peak Hour	8	6	13	3	30	2	2	5	1	10	9	11	7	1	28

Two-Hour Count Summaries - Heavy Vehicles																		
Interval Start	E San Antonio St				E San Antonio St				S 24th St				S 24th St				15-min Total	Rolling One Hour
	Eastbound				Westbound				Northbound				Southbound					
	UT	LT	TH	RT	UT	LT	TH	RT	UT	LT	TH	RT	UT	LT	TH	RT		
7:00 AM	0	0	1	1	0	0	0	0	0	0	1	0	0	0	1	0	4	0
7:15 AM	0	0	1	0	0	1	1	0	0	1	3	1	0	0	2	1	11	0
7:30 AM	0	0	1	1	0	0	1	0	0	1	2	0	0	0	3	0	9	0
7:45 AM	0	0	0	2	0	0	2	0	0	2	1	0	0	0	0	0	7	31
8:00 AM	0	0	0	2	0	0	2	0	0	2	0	2	0	0	0	0	8	35
8:15 AM	0	0	1	1	0	0	1	0	0	2	0	1	0	0	0	0	6	30
8:30 AM	0	0	0	1	0	1	0	0	0	1	3	1	0	0	0	0	7	28
8:45 AM	0	0	0	1	0	2	0	1	0	1	1	0	0	0	1	1	8	29
Count Total	0	0	4	9	0	4	7	1	0	10	11	5	0	0	7	2	60	0
Peak Hour	0	0	2	6	0	0	6	0	0	7	3	3	0	0	3	0	30	0

Two-Hour Count Summaries - Bikes														
Interval Start	E San Antonio St			E San Antonio St			S 24th St			S 24th St			15-min Total	Rolling One Hour
	Eastbound			Westbound			Northbound			Southbound				
	LT	TH	RT	LT	TH	RT	LT	TH	RT	LT	TH	RT		
7:00 AM	0	0	0	0	1	0	0	0	0	0	0	0	1	0
7:15 AM	0	2	0	0	0	0	1	0	0	0	0	0	3	0
7:30 AM	0	1	0	0	1	0	1	0	0	0	0	1	4	0
7:45 AM	0	0	0	0	1	0	0	1	0	0	0	0	2	10
8:00 AM	0	1	0	0	0	0	0	0	0	0	0	0	1	10
8:15 AM	0	0	0	0	0	0	0	3	0	0	0	0	3	10
8:30 AM	0	0	0	0	0	0	0	2	0	0	0	0	2	8
8:45 AM	0	0	0	0	0	0	0	0	0	0	0	0	0	6
Count Total	0	4	0	0	3	0	2	6	0	0	0	1	16	0
Peak Hour	0	2	0	0	2	0	1	4	0	0	0	1	10	0

Note: U-Turn volumes for bikes are included in Left-Turn, if any.

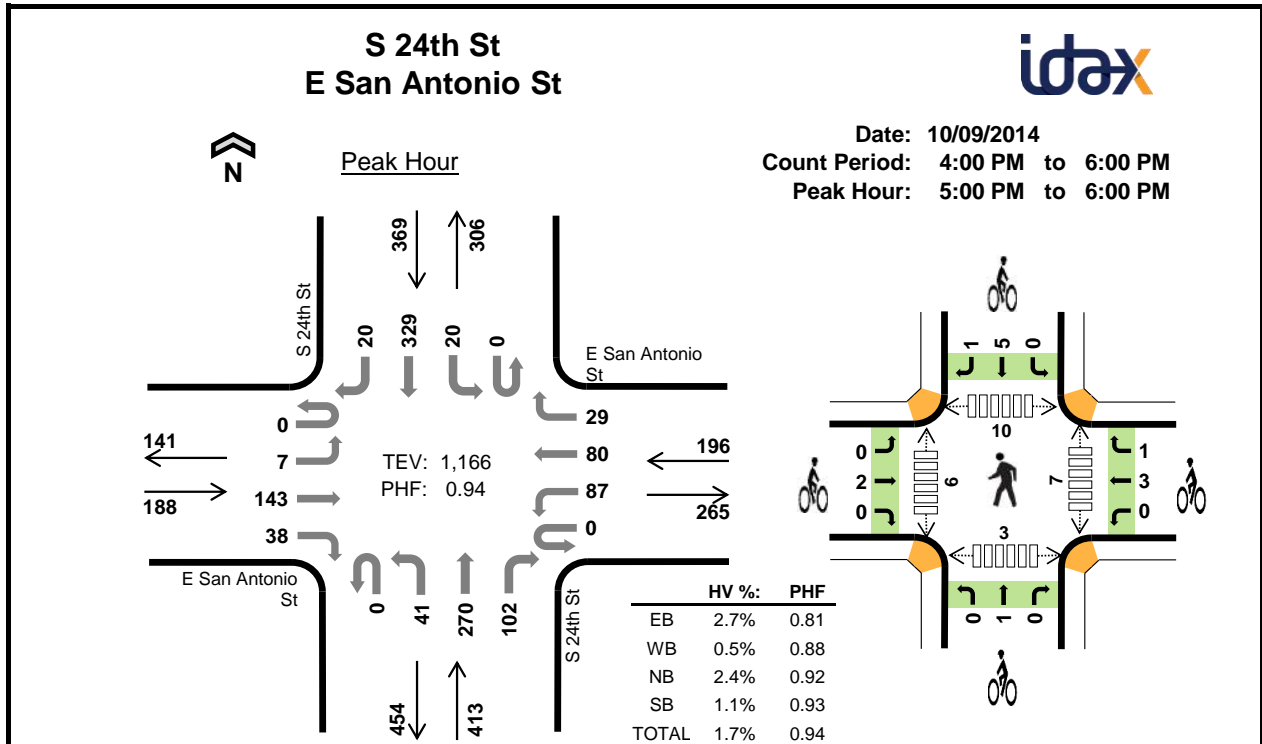

Two-Hour Count Summaries

Interval Start	E San Antonio St Eastbound				E San Antonio St Westbound				S 24th St Northbound				S 24th St Southbound				15-min Total	Rolling One Hour	
	UT	LT	TH	RT	UT	LT	TH	RT	UT	LT	TH	RT	UT	LT	TH	RT			
4:00 PM	0	4	28	9	0	23	25	8	0	5	70	33	0	7	100	7	319	0	
4:15 PM	0	3	27	6	0	26	16	5	0	6	72	36	0	4	89	4	294	0	
4:30 PM	0	6	24	9	0	20	17	3	0	13	69	28	0	6	75	5	275	0	
4:45 PM	0	1	29	11	0	26	21	4	0	8	55	24	0	3	76	3	261	1,149	
5:00 PM	0	1	24	7	0	23	23	10	0	14	70	28	0	6	85	2	293	1,123	
5:15 PM	0	1	40	8	0	24	20	5	0	9	73	29	0	7	68	3	287	1,116	
5:30 PM	0	1	46	11	0	19	11	8	0	3	58	20	0	5	85	9	276	1,117	
5:45 PM	0	4	33	12	0	21	26	6	0	15	69	25	0	2	91	6	310	1,166	
Count Total	0	21	251	73	0	182	159	49	0	73	536	223	0	40	669	39	2,315	0	
Peak Hour	All	0	7	143	38	0	87	80	29	0	41	270	102	0	20	329	20	1,166	0
	HV	0	0	1	4	0	0	1	0	0	5	4	1	0	0	3	1	20	0
	HV%	-	0%	1%	11%	-	0%	1%	0%	-	12%	1%	1%	-	0%	1%	5%	2%	0

Note: Two-hour count summary volumes include heavy vehicles but exclude bicycles in overall count.

Interval Start	Heavy Vehicle Totals					Bicycles					Pedestrians (Crossing Leg)				
	EB	WB	NB	SB	Total	EB	WB	NB	SB	Total	East	West	North	South	Total
4:00 PM	1	0	1	0	2	2	0	1	0	3	0	5	1	2	8
4:15 PM	3	2	0	1	6	0	1	2	1	4	7	2	1	5	15
4:30 PM	2	0	0	0	2	1	0	0	1	2	3	6	2	0	11
4:45 PM	1	1	1	2	5	1	1	0	0	2	2	0	1	1	4
5:00 PM	0	0	2	1	3	1	3	0	4	8	2	1	2	0	5
5:15 PM	2	0	2	0	4	0	0	0	0	0	1	1	2	0	4
5:30 PM	3	0	2	3	8	0	0	1	0	1	3	1	3	1	8
5:45 PM	0	1	4	0	5	1	1	0	2	4	1	3	3	2	9
Count Total	12	4	12	7	35	6	6	4	8	24	19	19	15	11	64
Peak Hour	5	1	10	4	20	2	4	1	6	13	7	6	10	3	26

Two-Hour Count Summaries - Heavy Vehicles																		
Interval Start	E San Antonio St				E San Antonio St				S 24th St				S 24th St				15-min Total	Rolling One Hour
	Eastbound				Westbound				Northbound				Southbound					
	UT	LT	TH	RT	UT	LT	TH	RT	UT	LT	TH	RT	UT	LT	TH	RT		
4:00 PM	0	0	0	1	0	0	0	0	0	0	1	0	0	0	0	0	2	0
4:15 PM	0	1	0	2	0	0	2	0	0	0	0	0	0	0	1	0	6	0
4:30 PM	0	0	1	1	0	0	0	0	0	0	0	0	0	0	0	0	2	0
4:45 PM	0	0	0	1	0	0	1	0	0	1	0	0	0	0	2	0	5	15
5:00 PM	0	0	0	0	0	0	0	0	0	2	0	0	0	0	1	0	3	16
5:15 PM	0	0	0	2	0	0	0	0	0	0	2	0	0	0	0	0	4	14
5:30 PM	0	0	1	2	0	0	0	0	0	2	0	0	0	0	2	1	8	20
5:45 PM	0	0	0	0	0	0	1	0	0	1	2	1	0	0	0	0	5	20
Count Total	0	1	2	9	0	0	4	0	0	6	5	1	0	0	6	1	35	0
Peak Hour	0	0	1	4	0	0	1	0	0	5	4	1	0	0	3	1	20	0
Two-Hour Count Summaries - Bikes																		
Interval Start	E San Antonio St			E San Antonio St			S 24th St			S 24th St			15-min Total	Rolling One Hour				
	Eastbound			Westbound			Northbound			Southbound								
	LT	TH	RT	LT	TH	RT	LT	TH	RT	LT	TH	RT						
4:00 PM	0	2	0	0	0	0	0	1	0	0	0	0	0	3	0			
4:15 PM	0	0	0	0	1	0	0	1	1	0	1	0	0	4	0			
4:30 PM	0	1	0	0	0	0	0	0	0	0	1	0	0	2	0			
4:45 PM	0	1	0	0	1	0	0	0	0	0	0	0	0	2	11			
5:00 PM	0	1	0	0	2	1	0	0	0	0	4	0	0	8	16			
5:15 PM	0	0	0	0	0	0	0	0	0	0	0	0	0	0	12			
5:30 PM	0	0	0	0	0	0	0	0	1	0	0	0	0	1	11			
5:45 PM	0	1	0	0	1	0	0	0	0	0	1	1	0	4	13			
Count Total	0	6	0	0	5	1	0	3	1	0	7	1	0	24	0			
Peak Hour	0	2	0	0	3	1	0	1	0	0	5	1	0	13	0			
<i>Note: U-Turn volumes for bikes are included in Left-Turn, if any.</i>																		

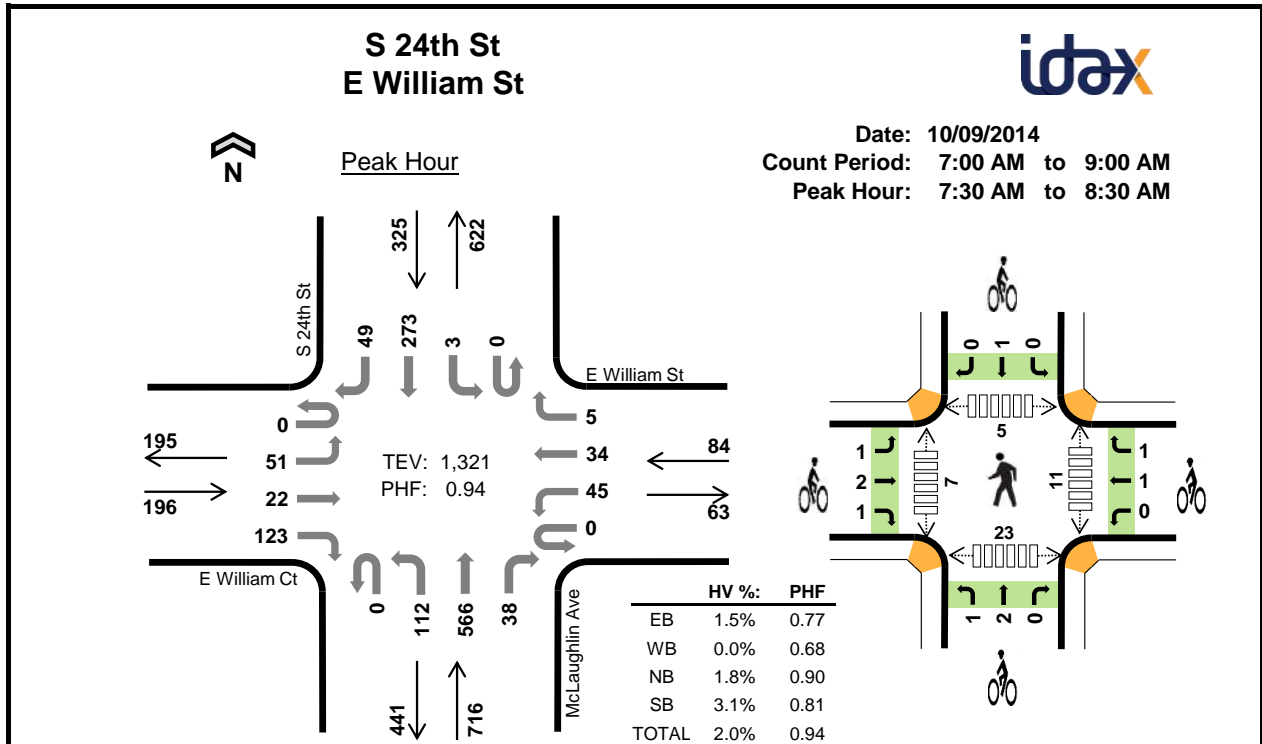

Two-Hour Count Summaries

Interval Start	E William Ct				E William St				McLaughlin Ave				S 24th St				15-min Total	Rolling One Hour	
	Eastbound				Westbound				Northbound				Southbound						
	UT	LT	TH	RT	UT	LT	TH	RT	UT	LT	TH	RT	UT	LT	TH	RT			
7:00 AM	0	3	1	33	0	12	1	3	0	15	100	8	0	0	56	6	238	0	
7:15 AM	0	15	2	32	0	12	8	3	0	28	131	10	0	0	63	11	315	0	
7:30 AM	0	9	8	47	0	12	5	2	0	32	150	7	0	0	73	7	352	0	
7:45 AM	0	9	2	18	0	15	13	3	0	28	154	9	0	1	82	17	351	1,256	
8:00 AM	0	19	11	33	0	9	11	0	0	29	100	9	0	1	63	15	300	1,318	
8:15 AM	0	14	1	25	0	9	5	0	0	23	162	13	0	1	55	10	318	1,321	
8:30 AM	0	15	4	36	0	9	21	0	0	38	134	13	0	1	49	11	331	1,300	
8:45 AM	0	18	17	39	0	7	18	0	0	22	148	10	0	3	40	13	335	1,284	
Count Total	0	102	46	263	0	85	82	11	0	215	1079	79	0	7	481	90	2,540	0	
Peak Hour	All	0	51	22	123	0	45	34	5	0	112	566	38	0	3	273	49	1,321	0
	HV	0	0	0	3	0	0	0	0	0	2	11	0	0	0	8	2	26	0
	HV%	-	0%	0%	2%	-	0%	0%	0%	-	2%	2%	0%	-	0%	3%	4%	2%	0

Note: Two-hour count summary volumes include heavy vehicles but exclude bicycles in overall count.

Interval Start	Heavy Vehicle Totals					Bicycles					Pedestrians (Crossing Leg)				
	EB	WB	NB	SB	Total	EB	WB	NB	SB	Total	East	West	North	South	Total
7:00 AM	1	0	2	3	6	0	0	0	1	1	1	1	0	1	3
7:15 AM	0	3	5	4	12	1	0	3	0	4	2	1	0	3	6
7:30 AM	1	0	5	4	10	0	0	1	0	1	0	5	3	0	8
7:45 AM	1	0	5	2	8	1	1	0	0	2	5	1	2	3	11
8:00 AM	1	0	2	2	5	1	1	1	0	3	6	1	0	7	14
8:15 AM	0	0	1	2	3	2	0	1	1	4	0	0	0	13	13
8:30 AM	2	1	7	2	12	0	1	0	1	2	5	0	0	10	15
8:45 AM	3	0	4	3	10	0	0	0	0	0	3	0	0	8	11
Count Total	9	4	31	22	66	5	3	6	3	17	22	9	5	45	81
Peak Hour	3	0	13	10	26	4	2	3	1	10	11	7	5	23	46

Two-Hour Count Summaries - Heavy Vehicles																		
Interval Start	E William Ct				E William St				McLaughlin Ave				S 24th St				15-min Total	Rolling One Hour
	Eastbound				Westbound				Northbound				Southbound					
	UT	LT	TH	RT	UT	LT	TH	RT	UT	LT	TH	RT	UT	LT	TH	RT		
7:00 AM	0	0	1	0	0	0	0	0	0	0	1	1	0	0	3	0	6	0
7:15 AM	0	0	0	0	0	0	1	2	0	0	5	0	0	0	4	0	12	0
7:30 AM	0	0	0	1	0	0	0	0	0	2	3	0	0	0	3	1	10	0
7:45 AM	0	0	0	1	0	0	0	0	0	0	5	0	0	0	2	0	8	36
8:00 AM	0	0	0	1	0	0	0	0	0	0	2	0	0	0	1	1	5	35
8:15 AM	0	0	0	0	0	0	0	0	0	0	1	0	0	0	2	0	3	26
8:30 AM	0	2	0	0	0	1	0	0	0	3	4	0	0	0	2	0	12	28
8:45 AM	0	0	0	3	0	0	0	0	0	1	3	0	0	0	3	0	10	30
Count Total	0	2	1	6	0	1	1	2	0	6	24	1	0	0	20	2	66	0
Peak Hour	0	0	0	3	0	0	0	0	0	2	11	0	0	0	8	2	26	0

Two-Hour Count Summaries - Bikes														
Interval Start	E William Ct			E William St			McLaughlin Ave			S 24th St			15-min Total	Rolling One Hour
	Eastbound			Westbound			Northbound			Southbound				
	LT	TH	RT	LT	TH	RT	LT	TH	RT	LT	TH	RT		
7:00 AM	0	0	0	0	0	0	0	0	0	0	1	0	1	0
7:15 AM	0	0	1	0	0	0	2	1	0	0	0	0	4	0
7:30 AM	0	0	0	0	0	0	0	1	0	0	0	0	1	0
7:45 AM	0	0	1	0	0	1	0	0	0	0	0	0	2	8
8:00 AM	0	1	0	0	1	0	1	0	0	0	0	0	3	10
8:15 AM	1	1	0	0	0	0	0	1	0	0	1	0	4	10
8:30 AM	0	0	0	0	1	0	0	0	0	0	1	0	2	11
8:45 AM	0	0	0	0	0	0	0	0	0	0	0	0	0	9
Count Total	1	2	2	0	2	1	3	3	0	0	3	0	17	0
Peak Hour	1	2	1	0	1	1	1	2	0	0	1	0	10	0

Note: U-Turn volumes for bikes are included in Left-Turn, if any.

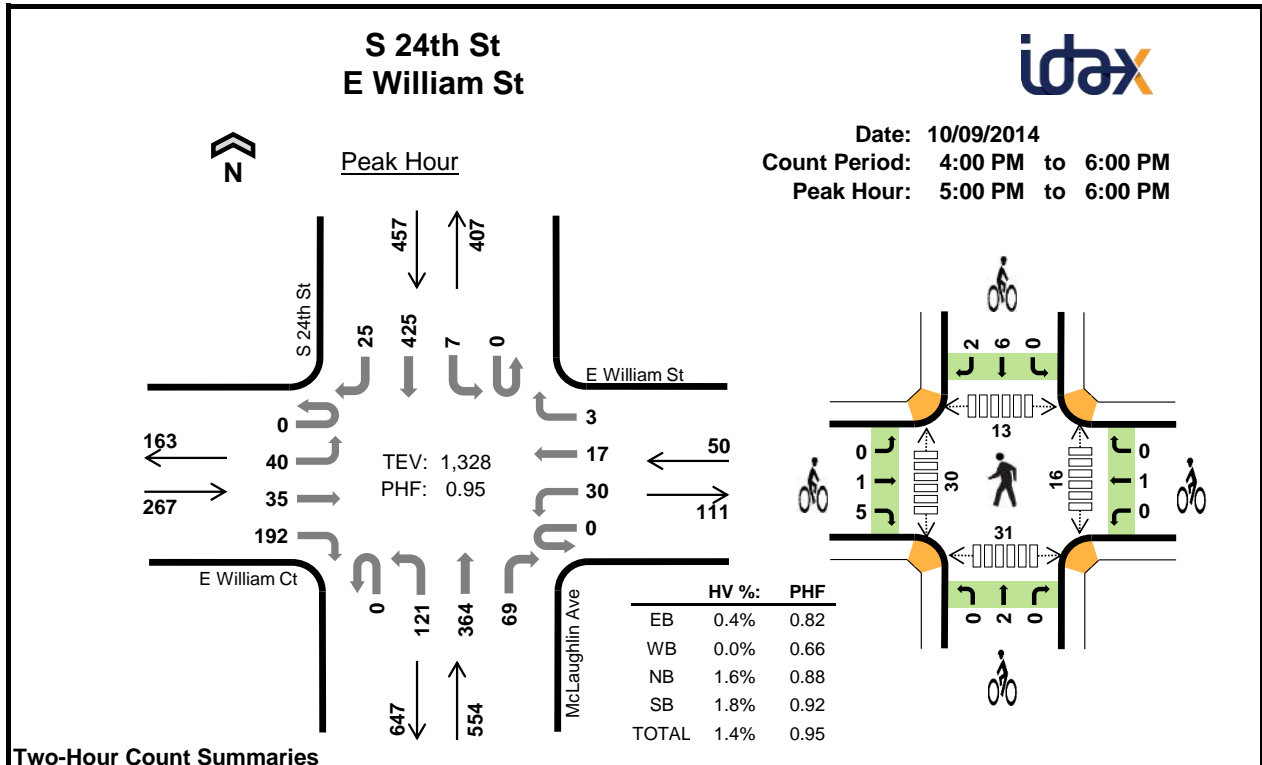

Two-Hour Count Summaries

Interval Start	E William Ct				E William St				McLaughlin Ave				S 24th St				15-min Total	Rolling One Hour	
	Eastbound				Westbound				Northbound				Southbound						
	UT	LT	TH	RT	UT	LT	TH	RT	UT	LT	TH	RT	UT	LT	TH	RT			
4:00 PM	0	22	6	23	0	8	3	3	0	35	87	18	0	4	112	4	325	0	
4:15 PM	0	14	10	51	0	8	4	1	0	21	96	13	0	3	112	3	336	0	
4:30 PM	0	11	14	33	0	10	4	0	0	19	93	21	0	2	112	7	326	0	
4:45 PM	0	18	11	45	0	10	5	1	0	33	72	17	0	0	117	4	333	1,320	
5:00 PM	0	8	7	42	0	7	2	1	0	24	95	22	0	3	105	4	320	1,315	
5:15 PM	0	8	8	40	0	4	5	1	0	36	101	20	0	2	102	2	329	1,308	
5:30 PM	0	9	10	62	0	11	7	1	0	28	74	13	0	1	103	11	330	1,312	
5:45 PM	0	15	10	48	0	8	3	0	0	33	94	14	0	1	115	8	349	1,328	
Count Total	0	105	76	344	0	66	33	8	0	229	712	138	0	16	878	43	2,648	0	
Peak Hour	All	0	40	35	192	0	30	17	3	0	121	364	69	0	7	425	25	1,328	0
	HV	0	0	0	1	0	0	0	0	0	0	8	1	0	0	8	0	18	0
	HV%	-	0%	0%	1%	-	0%	0%	0%	-	0%	2%	1%	-	0%	2%	0%	1%	0

Note: Two-hour count summary volumes include heavy vehicles but exclude bicycles in overall count.

Interval Start	Heavy Vehicle Totals					Bicycles					Pedestrians (Crossing Leg)				
	EB	WB	NB	SB	Total	EB	WB	NB	SB	Total	East	West	North	South	Total
4:00 PM	3	0	1	1	5	1	1	4	0	6	0	2	0	6	8
4:15 PM	0	0	1	4	5	0	0	2	1	3	1	1	0	3	5
4:30 PM	0	0	0	3	3	1	1	2	1	5	0	2	0	12	14
4:45 PM	2	0	3	2	7	0	0	0	0	0	0	1	0	5	6
5:00 PM	0	0	2	1	3	0	0	0	4	4	0	6	3	15	24
5:15 PM	1	0	3	3	7	1	1	1	0	3	5	10	6	6	27
5:30 PM	0	0	3	4	7	3	0	1	2	6	5	4	0	7	16
5:45 PM	0	0	1	0	1	2	0	0	2	4	6	10	4	3	23
Count Total	6	0	14	18	38	8	3	10	10	31	17	36	13	57	123
Peak Hour	1	0	9	8	18	6	1	2	8	17	16	30	13	31	90

Two-Hour Count Summaries - Heavy Vehicles																			
Interval Start	E William Ct				E William St				McLaughlin Ave				S 24th St				15-min Total	Rolling One Hour	
	Eastbound				Westbound				Northbound				Southbound						
	UT	LT	TH	RT	UT	LT	TH	RT	UT	LT	TH	RT	UT	LT	TH	RT			
4:00 PM	0	1	0	2	0	0	0	0	0	0	0	1	0	0	1	0	5	0	
4:15 PM	0	0	0	0	0	0	0	0	0	0	0	1	0	0	0	4	0	5	0
4:30 PM	0	0	0	0	0	0	0	0	0	0	0	0	0	0	0	3	0	3	0
4:45 PM	0	0	0	2	0	0	0	0	0	0	1	1	1	0	0	1	1	7	20
5:00 PM	0	0	0	0	0	0	0	0	0	0	0	2	0	0	0	1	0	3	18
5:15 PM	0	0	0	1	0	0	0	0	0	0	0	3	0	0	0	3	0	7	20
5:30 PM	0	0	0	0	0	0	0	0	0	0	0	2	1	0	0	4	0	7	24
5:45 PM	0	0	0	0	0	0	0	0	0	0	0	1	0	0	0	0	0	1	18
Count Total	0	1	0	5	0	0	0	0	0	0	1	10	3	0	0	17	1	38	0
Peak Hour	0	0	0	1	0	0	0	0	0	0	0	8	1	0	0	8	0	18	0
Two-Hour Count Summaries - Bikes																			
Interval Start	E William Ct			E William St			McLaughlin Ave			S 24th St			15-min Total	Rolling One Hour					
	Eastbound			Westbound			Northbound			Southbound									
	LT	TH	RT	LT	TH	RT	LT	TH	RT	LT	TH	RT							
4:00 PM	0	0	1	1	0	0	0	2	2	0	0	0	0	6	0				
4:15 PM	0	0	0	0	0	0	0	0	2	0	0	1	0	3	0				
4:30 PM	0	0	1	0	0	1	0	2	0	1	0	0	0	5	0				
4:45 PM	0	0	0	0	0	0	0	0	0	0	0	0	0	0	14				
5:00 PM	0	0	0	0	0	0	0	0	0	0	0	3	1	4	12				
5:15 PM	0	1	0	0	1	0	0	1	0	0	0	0	0	3	12				
5:30 PM	0	0	3	0	0	0	0	1	0	0	1	1	1	6	13				
5:45 PM	0	0	2	0	0	0	0	0	0	0	2	0	0	4	17				
Count Total	0	1	7	1	1	1	0	8	2	1	7	2	2	31	0				
Peak Hour	0	1	5	0	1	0	0	2	0	0	6	2	2	17	0				
<i>Note: U-Turn volumes for bikes are included in Left-Turn, if any.</i>																			

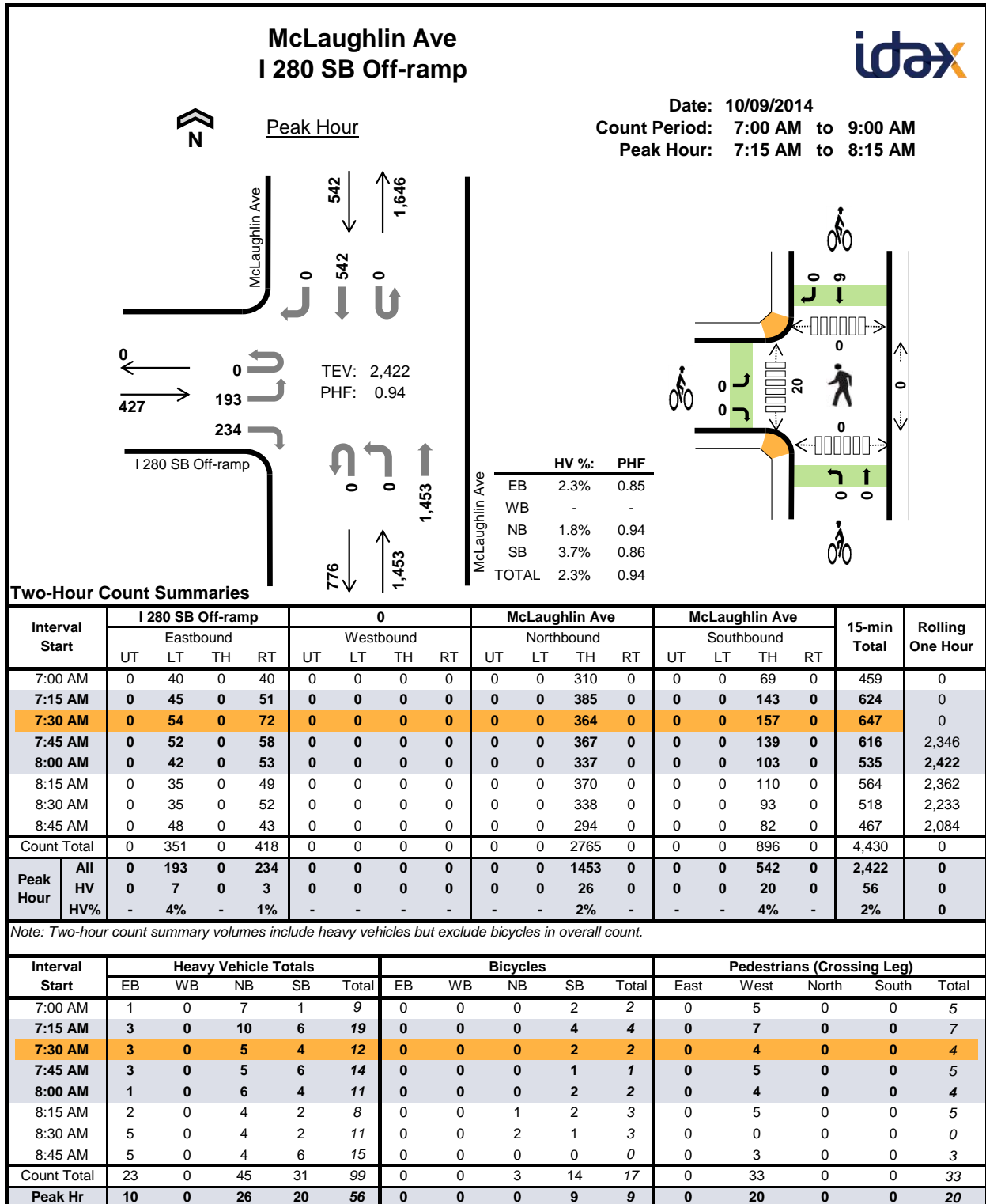

Two-Hour Count Summaries - Heavy Vehicles																		
Interval Start	I 280 SB Off-ramp				0				McLaughlin Ave				McLaughlin Ave				15-min Total	Rolling One Hour
	Eastbound				Westbound				Northbound				Southbound					
	UT	LT	TH	RT	UT	LT	TH	RT	UT	LT	TH	RT	UT	LT	TH	RT		
7:00 AM	0	0	0	1	0	0	0	0	0	0	7	0	0	0	1	0	9	0
7:15 AM	0	2	0	1	0	0	0	0	0	0	10	0	0	0	6	0	19	0
7:30 AM	0	2	0	1	0	0	0	0	0	0	5	0	0	0	4	0	12	0
7:45 AM	0	3	0	0	0	0	0	0	0	0	5	0	0	0	6	0	14	54
8:00 AM	0	0	0	1	0	0	0	0	0	0	6	0	0	0	4	0	11	56
8:15 AM	0	0	0	2	0	0	0	0	0	0	4	0	0	0	2	0	8	45
8:30 AM	0	0	0	5	0	0	0	0	0	0	4	0	0	0	2	0	11	44
8:45 AM	0	2	0	3	0	0	0	0	0	0	4	0	0	0	6	0	15	45
Count Total	0	9	0	14	0	0	0	0	0	0	45	0	0	0	31	0	99	0
Peak Hour	0	7	0	3	0	0	0	0	0	0	26	0	0	0	20	0	56	0
Two-Hour Count Summaries - Bikes																		
Interval Start	I 280 SB Off-ramp				0				McLaughlin Ave				McLaughlin Ave				15-min Total	Rolling One Hour
	Eastbound				Westbound				Northbound				Southbound					
	LT	TH	RT	UT	LT	TH	RT	UT	LT	TH	RT	UT	LT	TH	RT	UT		
7:00 AM	0	0	0	0	0	0	0	0	0	0	0	0	0	2	0	0	2	0
7:15 AM	0	0	0	0	0	0	0	0	0	0	0	0	0	4	0	0	4	0
7:30 AM	0	0	0	0	0	0	0	0	0	0	0	0	0	2	0	0	2	0
7:45 AM	0	0	0	0	0	0	0	0	0	0	0	0	0	1	0	0	1	9
8:00 AM	0	0	0	0	0	0	0	0	0	0	0	0	0	2	0	0	2	9
8:15 AM	0	0	0	0	0	0	0	0	0	1	0	0	0	2	0	0	3	8
8:30 AM	0	0	0	0	0	0	0	0	0	2	0	0	0	1	0	0	3	9
8:45 AM	0	0	0	0	0	0	0	0	0	0	0	0	0	0	0	0	0	8
Count Total	0	0	0	0	0	0	0	0	0	3	0	0	0	14	0	0	17	0
Peak Hour	0	0	0	0	0	0	0	0	0	0	0	0	0	9	0	0	9	0
<i>Note: U-Turn volumes for bikes are included in Left-Turn, if any.</i>																		

INTERSECTION TURNING MOVEMENT COUNT SUMMARY

CLIENT: KITTELSON ASSOCIATES
 PROJECT: 2014 SCVTA CMP MONITORING
 DATE: WEDNESDAY SEPTEMBER 24TH, 2014
 PERIOD: 4:00 PM TO 6:00 PM
 INTERSECTION: N/S HIGHWAY 280 (EAST OF RAMPS)
 E/W MCLAUGHLIN AVENUE
 CITY: SAN JOSE

VEHICLES													
15 MIN COUNTS													
4:00 PM TO 6:00 PM													
PERIOD	1 SBRT	2 SBTH	3 SBLT	4 WBRT	5 WBTH	6 WBLT	7 NBRT	8 NBTH	9 NBLT	10 EBRT	11 EBTH	12 EBLT	TOTAL
400-415	0	110	0	0	0	0	0	206	0	121	0	70	507
415-430	0	132	0	0	0	0	0	177	0	146	0	87	542
430-445	0	123	0	0	0	0	0	198	0	120	0	72	513
445-500	0	146	0	0	0	0	0	166	0	141	0	72	525
500-515	0	116	0	0	0	0	0	200	0	155	0	71	542
515-530	0	139	0	0	0	0	0	208	0	120	0	71	538
530-545	0	154	0	0	0	0	0	171	0	130	0	61	516
545-600	0	148	0	0	0	0	0	204	0	141	0	70	563
HOOR TOTALS													
TIME	1 SBRT	2 SBTH	3 SBLT	4 WBRT	5 WBTH	6 WBLT	7 NBRT	8 NBTH	9 NBLT	10 EBRT	11 EBTH	12 EBLT	TOTAL
400-500	0	511	0	0	0	0	0	747	0	528	0	301	2087
415-515	0	517	0	0	0	0	0	741	0	562	0	302	2122
430-530	0	524	0	0	0	0	0	772	0	536	0	286	2118
445-545	0	555	0	0	0	0	0	745	0	546	0	275	2121
500-600	0	557	0	0	0	0	0	783	0	546	0	273	2159

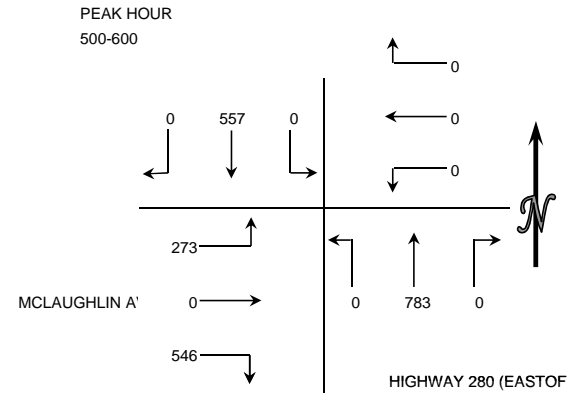

BICYCLES													
15 MIN COUNTS													
4:00 PM TO 6:00 PM													
PERIOD	1 SBRT	2 SBTH	3 SBLT	4 WBRT	5 WBTH	6 WBLT	7 NBRT	8 NBTH	9 NBLT	10 EBRT	11 EBTH	12 EBLT	TOTAL
400-415	0	5	0	0	0	0	0	1	0	0	0	0	6
415-430	0	1	0	0	0	0	0	3	0	0	0	0	4
430-445	0	2	0	0	0	0	0	4	0	0	0	0	6
445-500	0	5	0	0	0	0	0	0	0	0	0	0	5
500-515	0	2	0	0	0	0	0	2	0	0	0	0	4
515-530	0	0	0	0	0	0	0	3	0	0	0	0	3
530-545	0	2	0	0	0	0	0	2	0	0	0	0	4
545-600	0	1	0	0	0	0	0	2	0	0	0	0	3
HOOR TOTALS													
TIME	1 SBRT	2 SBTH	3 SBLT	4 WBRT	5 WBTH	6 WBLT	7 NBRT	8 NBTH	9 NBLT	10 EBRT	11 EBTH	12 EBLT	TOTAL
400-500	0	13	0	0	0	0	0	8	0	0	0	0	21
415-515	0	10	0	0	0	0	0	9	0	0	0	0	19
430-530	0	9	0	0	0	0	0	9	0	0	0	0	18
445-545	0	9	0	0	0	0	0	7	0	0	0	0	16
500-600	0	5	0	0	0	0	0	9	0	0	0	0	14

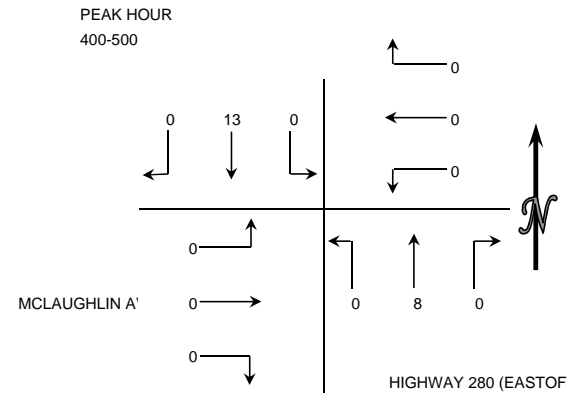

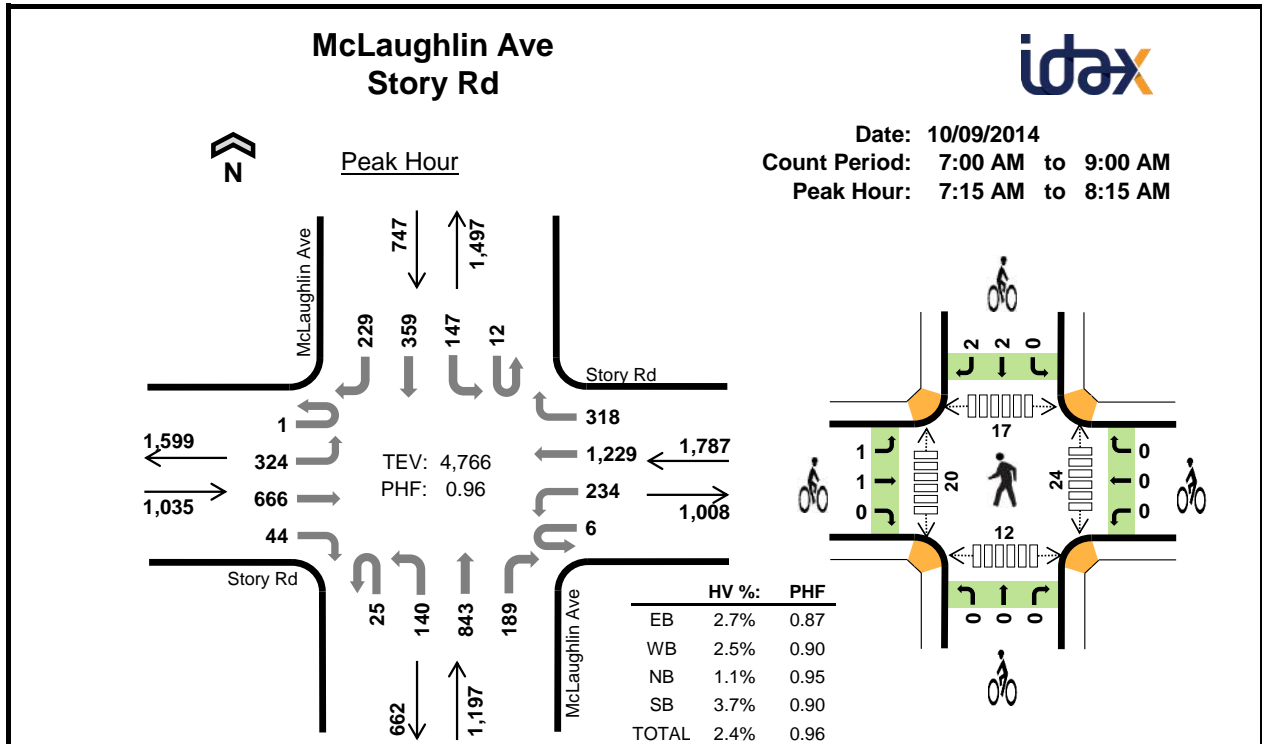

Two-Hour Count Summaries

Interval Start	Story Rd Eastbound				Story Rd Westbound				McLaughlin Ave Northbound				McLaughlin Ave Southbound				15-min Total	Rolling One Hour	
	UT	LT	TH	RT	UT	LT	TH	RT	UT	LT	TH	RT	UT	LT	TH	RT			
7:00 AM	2	64	107	7	6	40	225	73	3	17	192	50	0	34	48	27	895	0	
7:15 AM	0	61	136	8	3	58	290	86	4	27	226	57	2	38	91	60	1,147	0	
7:30 AM	1	102	185	11	1	66	312	65	4	34	215	46	3	32	107	59	1,243	0	
7:45 AM	0	83	188	8	0	40	285	86	8	47	216	43	7	48	93	60	1,212	4,497	
8:00 AM	0	78	157	17	2	70	342	81	9	32	186	43	0	29	68	50	1,164	4,766	
8:15 AM	1	77	116	10	4	57	285	76	7	44	193	43	0	47	68	52	1,080	4,699	
8:30 AM	1	65	156	12	4	52	325	65	1	26	208	34	0	38	50	54	1,091	4,547	
8:45 AM	1	70	166	11	9	41	360	91	5	46	153	46	0	36	54	41	1,130	4,465	
Count Total	6	600	1211	84	29	424	2424	623	41	273	1589	362	12	302	579	403	8,962	0	
Peak Hour	All	1	324	666	44	6	234	1229	318	25	140	843	189	12	147	359	229	4,766	0
	HV	0	9	19	0	0	3	32	10	0	2	8	3	0	5	13	9	113	0
	HV%	0%	3%	3%	0%	0%	1%	3%	3%	0%	1%	1%	2%	0%	3%	4%	4%	2%	0

Note: Two-hour count summary volumes include heavy vehicles but exclude bicycles in overall count.

Interval Start	Heavy Vehicle Totals					Bicycles					Pedestrians (Crossing Leg)				
	EB	WB	NB	SB	Total	EB	WB	NB	SB	Total	East	West	North	South	Total
7:00 AM	9	10	7	4	30	1	1	0	2	4	3	9	3	1	16
7:15 AM	7	11	8	10	36	0	0	0	1	1	5	3	7	2	17
7:30 AM	5	12	2	7	26	1	0	0	2	3	6	7	0	4	17
7:45 AM	9	8	3	8	28	1	0	0	0	1	7	5	4	3	19
8:00 AM	7	14	0	2	23	0	0	0	1	1	6	5	6	3	20
8:15 AM	9	18	2	9	38	0	0	0	1	1	2	3	10	6	21
8:30 AM	5	10	1	7	23	0	0	2	1	3	4	8	4	1	17
8:45 AM	7	13	6	9	35	0	0	0	0	0	4	5	6	5	20
Count Total	58	96	29	56	239	3	1	2	8	14	37	45	40	25	147
Peak Hour	28	45	13	27	113	2	0	0	4	6	24	20	17	12	73

Two-Hour Count Summaries - Heavy Vehicles																		
Interval Start	Story Rd				Story Rd				McLaughlin Ave				McLaughlin Ave				15-min Total	Rolling One Hour
	Eastbound				Westbound				Northbound				Southbound					
	UT	LT	TH	RT	UT	LT	TH	RT	UT	LT	TH	RT	UT	LT	TH	RT		
7:00 AM	0	0	9	0	0	2	5	3	0	0	4	3	0	2	1	1	30	0
7:15 AM	0	3	4	0	0	1	7	3	0	1	4	3	0	2	4	4	36	0
7:30 AM	0	1	4	0	0	1	10	1	0	0	2	0	0	1	4	2	26	0
7:45 AM	0	3	6	0	0	0	6	2	0	1	2	0	0	2	3	3	28	120
8:00 AM	0	2	5	0	0	1	9	4	0	0	0	0	0	0	2	0	23	113
8:15 AM	0	0	9	0	0	3	13	2	0	0	2	0	0	4	2	3	38	115
8:30 AM	0	1	4	0	0	1	9	0	0	0	1	0	0	2	1	4	23	112
8:45 AM	0	0	7	0	1	1	10	1	0	2	4	0	0	3	3	3	35	119
Count Total	0	10	48	0	1	10	69	16	0	4	19	6	0	16	20	20	239	0
Peak Hour	0	9	19	0	0	3	32	10	0	2	8	3	0	5	13	9	113	0

Two-Hour Count Summaries - Bikes														
Interval Start	Story Rd			Story Rd			McLaughlin Ave			McLaughlin Ave			15-min Total	Rolling One Hour
	Eastbound			Westbound			Northbound			Southbound				
	LT	TH	RT	LT	TH	RT	LT	TH	RT	LT	TH	RT		
7:00 AM	0	1	0	0	1	0	0	0	0	0	2	0	4	0
7:15 AM	0	0	0	0	0	0	0	0	0	0	1	0	1	0
7:30 AM	0	1	0	0	0	0	0	0	0	0	0	2	3	0
7:45 AM	1	0	0	0	0	0	0	0	0	0	0	0	1	9
8:00 AM	0	0	0	0	0	0	0	0	0	0	1	0	1	6
8:15 AM	0	0	0	0	0	0	0	0	0	0	1	0	1	6
8:30 AM	0	0	0	0	0	0	0	2	0	0	1	0	3	6
8:45 AM	0	0	0	0	0	0	0	0	0	0	0	0	0	5
Count Total	1	2	0	0	1	0	0	2	0	0	6	2	14	0
Peak Hour	1	1	0	0	0	0	0	0	0	0	2	2	6	0

Note: U-Turn volumes for bikes are included in Left-Turn, if any.

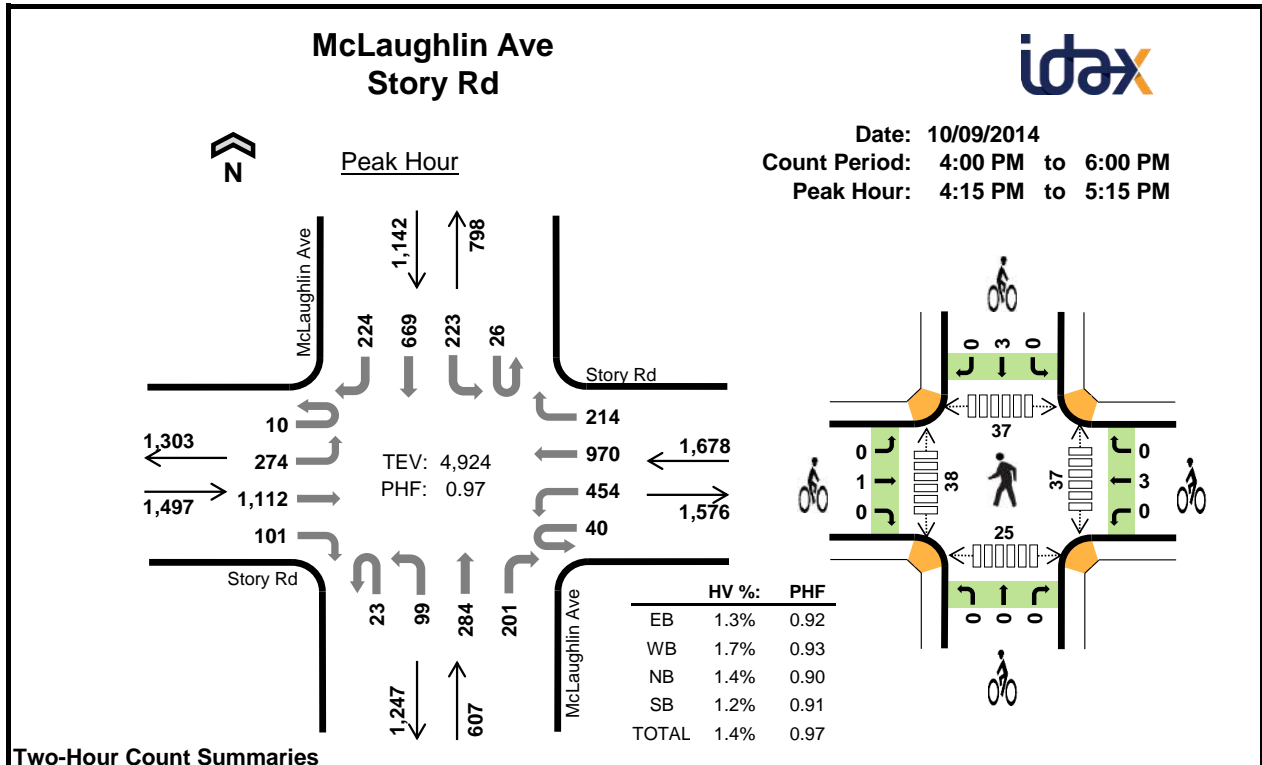

Two-Hour Count Summaries

Interval Start	Story Rd Eastbound				Story Rd Westbound				McLaughlin Ave Northbound				McLaughlin Ave Southbound				15-min Total	Rolling One Hour	
	UT	LT	TH	RT	UT	LT	TH	RT	UT	LT	TH	RT	UT	LT	TH	RT			
4:00 PM	2	79	222	21	11	121	227	42	6	18	60	63	5	73	182	66	1,198	0	
4:15 PM	3	69	306	29	10	95	250	58	7	24	59	53	2	64	151	55	1,235	0	
4:30 PM	1	74	238	22	9	119	243	56	6	20	76	56	12	56	168	56	1,212	0	
4:45 PM	1	55	279	29	11	115	262	61	4	25	68	40	8	60	186	60	1,264	4,909	
5:00 PM	5	76	289	21	10	125	215	39	6	30	81	52	4	43	164	53	1,213	4,924	
5:15 PM	2	56	271	30	16	102	187	63	10	30	73	58	14	58	162	58	1,190	4,879	
5:30 PM	2	63	262	20	8	129	194	36	8	26	73	61	5	63	176	75	1,201	4,868	
5:45 PM	3	59	280	35	11	96	219	34	5	28	66	46	11	62	152	55	1,162	4,766	
Count Total	19	531	2147	207	86	902	1797	389	52	201	556	429	61	479	1341	478	9,675	0	
Peak Hour	All	10	274	1112	101	40	454	970	214	23	99	284	201	26	223	669	224	4,924	0
	HV	0	5	15	0	0	1	22	5	0	1	5	2	0	2	9	2	69	0
	HV%	0%	2%	1%	0%	0%	0%	2%	2%	0%	1%	2%	1%	0%	1%	1%	1%	1%	0

Note: Two-hour count summary volumes include heavy vehicles but exclude bicycles in overall count.

Interval Start	Heavy Vehicle Totals					Bicycles					Pedestrians (Crossing Leg)				
	EB	WB	NB	SB	Total	EB	WB	NB	SB	Total	East	West	North	South	Total
4:00 PM	5	9	1	6	21	0	0	0	1	1	5	5	6	0	16
4:15 PM	2	8	1	6	17	0	0	0	1	1	12	6	6	6	30
4:30 PM	10	8	2	2	22	1	1	0	2	4	12	10	10	9	41
4:45 PM	1	5	3	2	11	0	2	0	0	2	6	12	6	3	27
5:00 PM	7	7	2	3	19	0	0	0	0	0	7	10	15	7	39
5:15 PM	2	4	2	2	10	0	1	0	2	3	10	13	13	0	36
5:30 PM	3	1	0	3	7	0	1	0	1	2	7	9	11	2	29
5:45 PM	3	1	1	1	6	0	0	0	0	0	8	8	10	6	32
Count Total	33	43	12	25	113	1	5	0	7	13	67	73	77	33	250
Peak Hour	20	28	8	13	69	1	3	0	3	7	37	38	37	25	137

Two-Hour Count Summaries - Heavy Vehicles																		
Interval Start	Story Rd				Story Rd				McLaughlin Ave				McLaughlin Ave				15-min Total	Rolling One Hour
	Eastbound				Westbound				Northbound				Southbound					
	UT	LT	TH	RT	UT	LT	TH	RT	UT	LT	TH	RT	UT	LT	TH	RT		
4:00 PM	0	0	5	0	0	1	6	2	0	0	1	0	0	5	1	0	21	0
4:15 PM	0	0	2	0	0	0	6	2	0	0	1	0	0	1	4	1	17	0
4:30 PM	0	3	7	0	0	1	7	0	0	0	0	2	0	0	1	1	22	0
4:45 PM	0	0	1	0	0	0	5	0	0	1	2	0	0	0	2	0	11	71
5:00 PM	0	2	5	0	0	0	4	3	0	0	2	0	0	1	2	0	19	69
5:15 PM	0	0	2	0	0	0	3	1	0	0	1	1	0	0	2	0	10	62
5:30 PM	0	0	3	0	0	0	0	1	0	0	0	0	0	0	3	0	7	47
5:45 PM	0	0	3	0	0	0	1	0	0	0	1	0	0	0	1	0	6	42
Count Total	0	5	28	0	0	2	32	9	0	1	8	3	0	7	16	2	113	0
Peak Hour	0	5	15	0	0	1	22	5	0	1	5	2	0	2	9	2	69	0

Two-Hour Count Summaries - Bikes														
Interval Start	Story Rd			Story Rd			McLaughlin Ave			McLaughlin Ave			15-min Total	Rolling One Hour
	Eastbound			Westbound			Northbound			Southbound				
	LT	TH	RT	LT	TH	RT	LT	TH	RT	LT	TH	RT		
4:00 PM	0	0	0	0	0	0	0	0	0	0	1	0	1	0
4:15 PM	0	0	0	0	0	0	0	0	0	0	1	0	1	0
4:30 PM	0	1	0	0	1	0	0	0	0	0	2	0	4	0
4:45 PM	0	0	0	0	2	0	0	0	0	0	0	0	2	8
5:00 PM	0	0	0	0	0	0	0	0	0	0	0	0	0	7
5:15 PM	0	0	0	0	1	0	0	0	0	0	2	0	3	9
5:30 PM	0	0	0	0	1	0	0	0	0	0	1	0	2	7
5:45 PM	0	0	0	0	0	0	0	0	0	0	0	0	0	5
Count Total	0	1	0	0	5	0	0	0	0	0	7	0	13	0
Peak Hour	0	1	0	0	3	0	0	0	0	0	3	0	7	0

Note: U-Turn volumes for bikes are included in Left-Turn, if any.

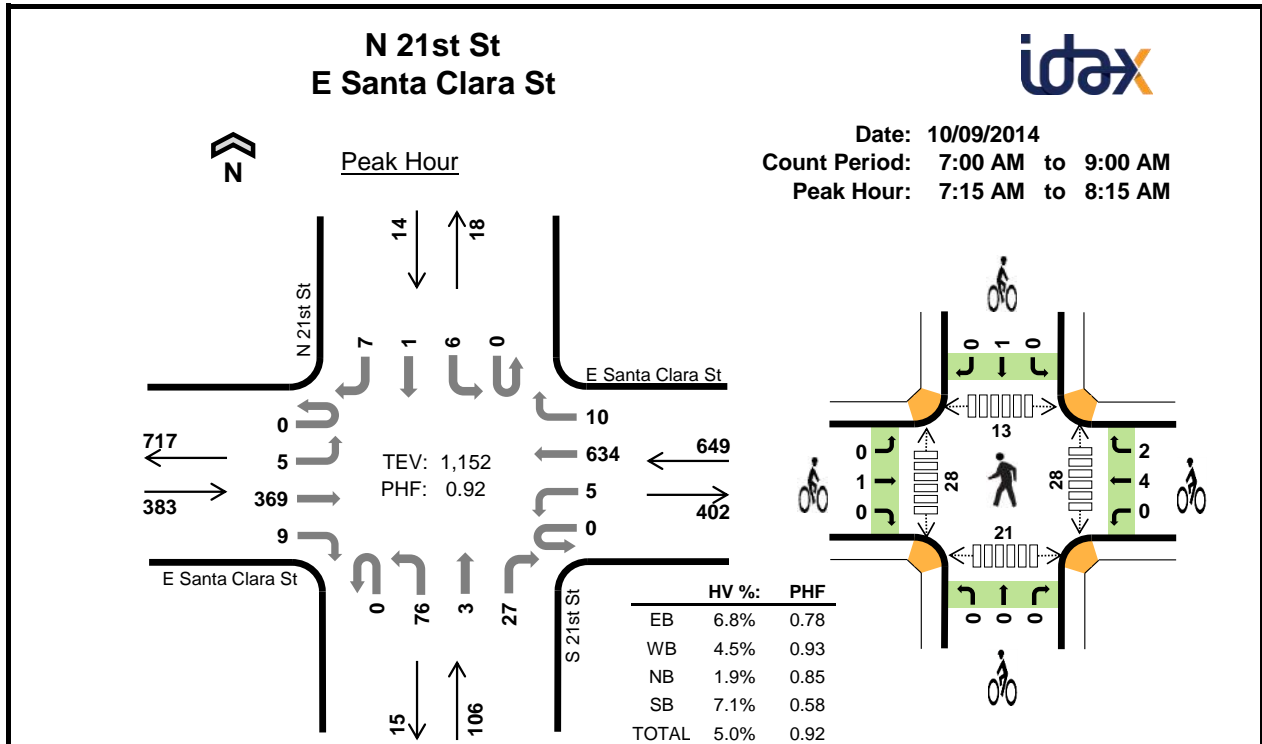

Two-Hour Count Summaries

Interval Start	E Santa Clara St Eastbound				E Santa Clara St Westbound				S 21st St Northbound				N 21st St Southbound				15-min Total	Rolling One Hour	
	UT	LT	TH	RT	UT	LT	TH	RT	UT	LT	TH	RT	UT	LT	TH	RT			
7:00 AM	0	1	64	2	0	1	101	0	0	1	1	6	0	2	0	2	181	0	
7:15 AM	0	0	71	0	0	1	154	4	0	24	0	4	0	1	0	1	260	0	
7:30 AM	0	2	79	1	0	0	174	1	0	22	1	8	0	1	1	0	290	0	
7:45 AM	0	2	101	5	0	2	164	4	0	19	1	10	0	3	0	3	314	1,045	
8:00 AM	0	1	118	3	0	2	142	1	0	11	1	5	0	1	0	3	288	1,152	
8:15 AM	0	8	74	4	0	0	141	2	0	7	2	5	0	2	0	1	246	1,138	
8:30 AM	0	3	76	4	0	2	157	5	0	13	1	4	0	3	1	1	270	1,118	
8:45 AM	0	6	94	1	0	4	181	6	0	17	3	7	0	4	0	4	327	1,131	
Count Total	0	23	677	20	0	12	1214	23	0	114	10	49	0	17	2	15	2,176	0	
Peak Hour	All	0	5	369	9	0	5	634	10	0	76	3	27	0	6	1	7	1,152	0
	HV	0	0	26	0	0	0	27	2	0	1	0	1	0	1	0	0	58	0
	HV%	-	0%	7%	0%	-	0%	4%	20%	-	1%	0%	4%	-	17%	0%	0%	5%	0

Note: Two-hour count summary volumes include heavy vehicles but exclude bicycles in overall count.

Interval Start	Heavy Vehicle Totals					Bicycles					Pedestrians (Crossing Leg)				
	EB	WB	NB	SB	Total	EB	WB	NB	SB	Total	East	West	North	South	Total
7:00 AM	5	6	0	0	11	1	2	0	0	3	0	2	2	3	7
7:15 AM	4	10	0	1	15	0	1	0	0	1	0	4	3	4	11
7:30 AM	6	5	1	0	12	1	2	0	0	3	5	10	4	5	24
7:45 AM	7	6	0	0	13	0	2	0	0	2	4	12	0	4	20
8:00 AM	9	8	1	0	18	0	1	0	1	2	19	2	6	8	35
8:15 AM	12	3	0	0	15	0	1	0	0	1	1	2	5	2	10
8:30 AM	3	8	0	0	11	0	3	1	0	4	23	1	3	6	33
8:45 AM	7	10	0	0	17	0	4	0	0	4	8	8	16	13	45
Count Total	53	56	2	1	112	2	16	1	1	20	60	41	39	45	185
Peak Hour	26	29	2	1	58	1	6	0	1	8	28	28	13	21	90

Two-Hour Count Summaries - Heavy Vehicles																		
Interval Start	E Santa Clara St				E Santa Clara St				S 21st St				N 21st St				15-min Total	Rolling One Hour
	Eastbound				Westbound				Northbound				Southbound					
	UT	LT	TH	RT	UT	LT	TH	RT	UT	LT	TH	RT	UT	LT	TH	RT		
7:00 AM	0	0	5	0	0	0	6	0	0	0	0	0	0	0	0	0	11	0
7:15 AM	0	0	4	0	0	0	8	2	0	0	0	0	0	1	0	0	15	0
7:30 AM	0	0	6	0	0	0	5	0	0	0	0	1	0	0	0	0	12	0
7:45 AM	0	0	7	0	0	0	6	0	0	0	0	0	0	0	0	0	13	51
8:00 AM	0	0	9	0	0	0	8	0	0	1	0	0	0	0	0	0	18	58
8:15 AM	0	0	11	1	0	0	3	0	0	0	0	0	0	0	0	0	15	58
8:30 AM	0	0	3	0	0	0	8	0	0	0	0	0	0	0	0	0	11	57
8:45 AM	0	0	7	0	0	0	10	0	0	0	0	0	0	0	0	0	17	61
Count Total	0	0	52	1	0	0	54	2	0	1	0	1	0	1	0	0	112	0
Peak Hour	0	0	26	0	0	0	27	2	0	1	0	1	0	1	0	0	58	0

Two-Hour Count Summaries - Bikes														
Interval Start	E Santa Clara St			E Santa Clara St			S 21st St			N 21st St			15-min Total	Rolling One Hour
	Eastbound			Westbound			Northbound			Southbound				
	LT	TH	RT	LT	TH	RT	LT	TH	RT	LT	TH	RT		
7:00 AM	0	1	0	0	2	0	0	0	0	0	0	0	3	0
7:15 AM	0	0	0	0	1	0	0	0	0	0	0	0	1	0
7:30 AM	0	1	0	0	1	1	0	0	0	0	0	0	3	0
7:45 AM	0	0	0	0	1	1	0	0	0	0	0	0	2	9
8:00 AM	0	0	0	0	1	0	0	0	0	0	1	0	2	8
8:15 AM	0	0	0	0	1	0	0	0	0	0	0	0	1	8
8:30 AM	0	0	0	0	3	0	1	0	0	0	0	0	4	9
8:45 AM	0	0	0	0	4	0	0	0	0	0	0	0	4	11
Count Total	0	2	0	0	14	2	1	0	0	0	1	0	20	0
Peak Hour	0	1	0	0	4	2	0	0	0	0	1	0	8	0

Note: U-Turn volumes for bikes are included in Left-Turn, if any.

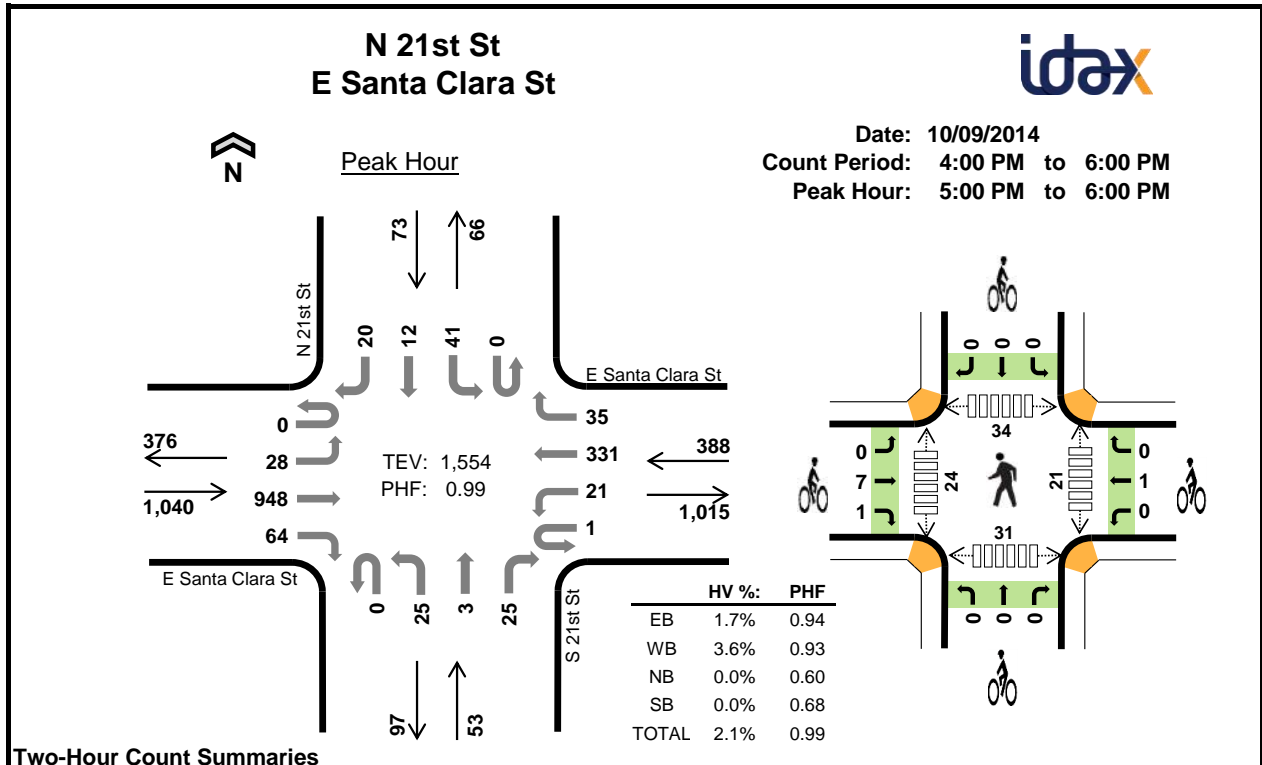

Two-Hour Count Summaries

Interval Start	E Santa Clara St Eastbound				E Santa Clara St Westbound				S 21st St Northbound				N 21st St Southbound				15-min Total	Rolling One Hour	
	UT	LT	TH	RT	UT	LT	TH	RT	UT	LT	TH	RT	UT	LT	TH	RT			
4:00 PM	0	2	194	14	0	3	81	6	0	6	1	4	0	14	4	3	332	0	
4:15 PM	0	2	187	8	0	7	69	5	0	4	2	6	0	6	4	3	303	0	
4:30 PM	0	7	204	10	1	7	73	13	0	2	1	10	0	3	0	5	336	0	
4:45 PM	0	6	208	11	0	4	93	14	0	6	1	3	0	9	0	5	360	1,331	
5:00 PM	0	4	258	14	0	7	80	6	0	3	0	4	0	10	3	3	392	1,391	
5:15 PM	0	3	237	15	0	7	89	7	0	5	0	4	0	8	0	6	381	1,469	
5:30 PM	0	6	233	16	1	4	88	11	0	7	1	7	0	6	4	6	390	1,523	
5:45 PM	0	15	220	19	0	3	74	11	0	10	2	10	0	17	5	5	391	1,554	
Count Total	0	45	1741	107	2	42	647	73	0	43	8	48	0	73	20	36	2,885	0	
Peak Hour	All	0	28	948	64	1	21	331	35	0	25	3	25	0	41	12	20	1,554	0
	HV	0	0	18	0	0	0	14	0	0	0	0	0	0	0	0	0	32	0
	HV%	-	0%	2%	0%	0%	0%	4%	0%	-	0%	0%	0%	-	0%	0%	0%	2%	0

Note: Two-hour count summary volumes include heavy vehicles but exclude bicycles in overall count.

Interval Start	Heavy Vehicle Totals					Bicycles					Pedestrians (Crossing Leg)				
	EB	WB	NB	SB	Total	EB	WB	NB	SB	Total	East	West	North	South	Total
4:00 PM	6	5	0	0	11	3	0	0	0	3	1	5	9	9	24
4:15 PM	5	1	0	0	6	2	3	0	0	5	0	6	9	4	19
4:30 PM	5	6	0	0	11	2	1	0	0	3	1	3	6	7	17
4:45 PM	6	4	1	0	11	5	0	1	0	6	2	10	11	5	28
5:00 PM	5	3	0	0	8	1	0	0	0	1	4	6	9	9	28
5:15 PM	5	4	0	0	9	2	1	0	0	3	7	2	10	5	24
5:30 PM	4	3	0	0	7	3	0	0	0	3	4	11	9	8	32
5:45 PM	4	4	0	0	8	2	0	0	0	2	6	5	6	9	26
Count Total	40	30	1	0	71	20	5	1	0	26	25	48	69	56	198
Peak Hour	18	14	0	0	32	8	1	0	0	9	21	24	34	31	110

Two-Hour Count Summaries - Heavy Vehicles																		
Interval Start	E Santa Clara St				E Santa Clara St				S 21st St				N 21st St				15-min Total	Rolling One Hour
	Eastbound				Westbound				Northbound				Southbound					
	UT	LT	TH	RT	UT	LT	TH	RT	UT	LT	TH	RT	UT	LT	TH	RT		
4:00 PM	0	0	6	0	0	0	5	0	0	0	0	0	0	0	0	0	11	0
4:15 PM	0	0	5	0	0	0	1	0	0	0	0	0	0	0	0	0	6	0
4:30 PM	0	0	5	0	0	0	6	0	0	0	0	0	0	0	0	0	11	0
4:45 PM	0	0	6	0	0	0	4	0	0	1	0	0	0	0	0	0	11	39
5:00 PM	0	0	5	0	0	0	3	0	0	0	0	0	0	0	0	0	8	36
5:15 PM	0	0	5	0	0	0	4	0	0	0	0	0	0	0	0	0	9	39
5:30 PM	0	0	4	0	0	0	3	0	0	0	0	0	0	0	0	0	7	35
5:45 PM	0	0	4	0	0	0	4	0	0	0	0	0	0	0	0	0	8	32
Count Total	0	0	40	0	0	0	30	0	0	1	0	0	0	0	0	0	71	0
Peak Hour	0	0	18	0	0	0	14	0	0	0	0	0	0	0	0	0	32	0

Two-Hour Count Summaries - Bikes														
Interval Start	E Santa Clara St			E Santa Clara St			S 21st St			N 21st St			15-min Total	Rolling One Hour
	Eastbound			Westbound			Northbound			Southbound				
	LT	TH	RT	LT	TH	RT	LT	TH	RT	LT	TH	RT		
4:00 PM	0	3	0	0	0	0	0	0	0	0	0	0	3	0
4:15 PM	0	0	2	0	3	0	0	0	0	0	0	0	5	0
4:30 PM	0	2	0	0	1	0	0	0	0	0	0	0	3	0
4:45 PM	0	5	0	0	0	0	1	0	0	0	0	0	6	17
5:00 PM	0	1	0	0	0	0	0	0	0	0	0	0	1	15
5:15 PM	0	2	0	0	1	0	0	0	0	0	0	0	3	13
5:30 PM	0	2	1	0	0	0	0	0	0	0	0	0	3	13
5:45 PM	0	2	0	0	0	0	0	0	0	0	0	0	2	9
Count Total	0	17	3	0	5	0	1	0	0	0	0	0	26	0
Peak Hour	0	7	1	0	1	0	0	0	0	0	0	0	9	0

Note: U-Turn volumes for bikes are included in Left-Turn, if any.

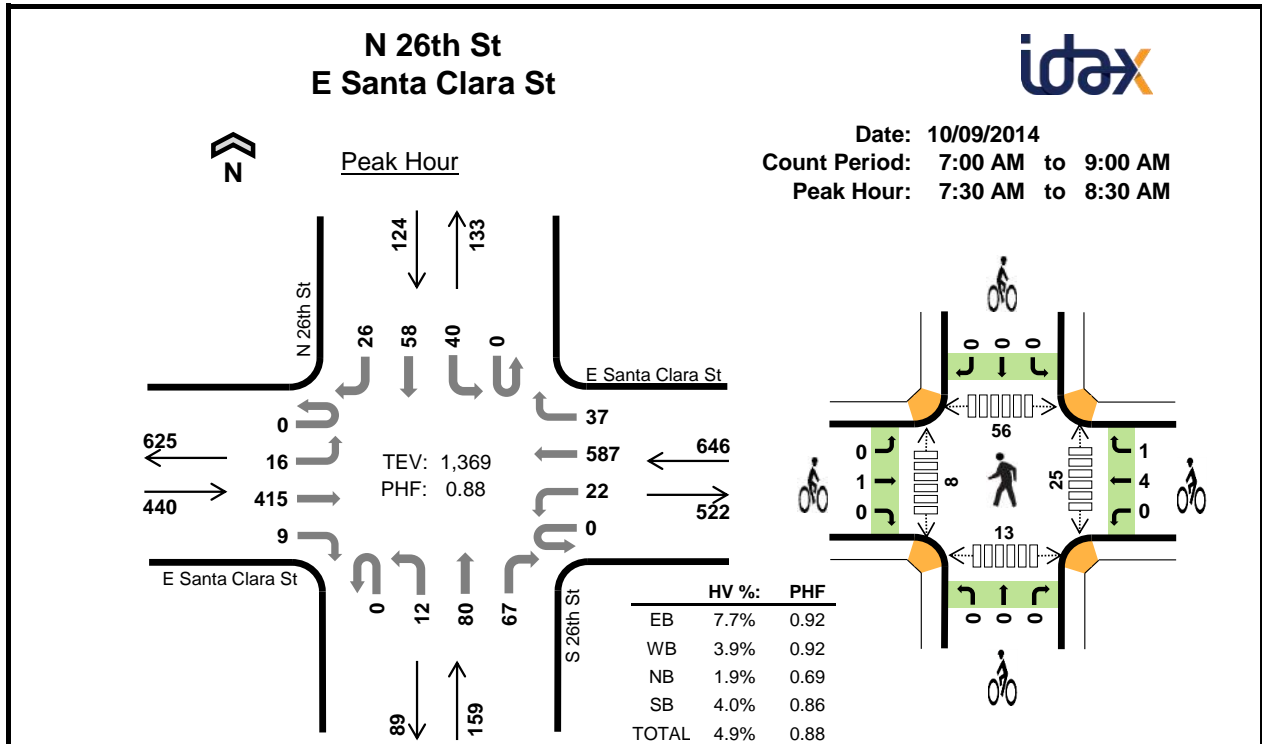

Two-Hour Count Summaries

Interval Start	E Santa Clara St Eastbound				E Santa Clara St Westbound				S 26th St Northbound				N 26th St Southbound				15-min Total	Rolling One Hour	
	UT	LT	TH	RT	UT	LT	TH	RT	UT	LT	TH	RT	UT	LT	TH	RT			
7:00 AM	0	6	79	0	0	1	101	5	0	0	9	8	0	9	0	9	227	0	
7:15 AM	0	4	90	0	0	4	129	11	0	2	16	9	0	12	11	5	293	0	
7:30 AM	0	4	99	3	0	3	159	14	0	6	21	21	0	14	14	4	362	0	
7:45 AM	0	2	114	3	0	3	159	14	0	3	35	20	0	11	16	9	389	1,271	
8:00 AM	0	7	108	2	0	6	127	7	0	1	15	13	0	8	18	4	316	1,360	
8:15 AM	0	3	94	1	0	10	142	2	0	2	9	13	0	7	10	9	302	1,369	
8:30 AM	0	6	102	4	0	7	171	6	0	5	8	17	0	7	5	8	346	1,353	
8:45 AM	0	5	108	1	0	7	186	16	0	1	13	16	0	6	9	7	375	1,339	
Count Total	0	37	794	14	0	41	1174	75	0	20	126	117	0	74	83	55	2,610	0	
Peak Hour	All	0	16	415	9	0	22	587	37	0	12	80	67	0	40	58	26	1,369	0
	HV	0	0	34	0	0	1	23	1	0	0	1	2	0	2	2	1	67	0
	HV%	-	0%	8%	0%	-	5%	4%	3%	-	0%	1%	3%	-	5%	3%	4%	5%	0

Note: Two-hour count summary volumes include heavy vehicles but exclude bicycles in overall count.

Interval Start	Heavy Vehicle Totals					Bicycles					Pedestrians (Crossing Leg)				
	EB	WB	NB	SB	Total	EB	WB	NB	SB	Total	East	West	North	South	Total
7:00 AM	3	6	0	1	10	0	3	0	0	3	4	2	7	0	13
7:15 AM	4	8	0	2	14	0	1	0	0	1	2	6	6	7	21
7:30 AM	5	7	0	2	14	1	2	0	0	3	12	5	15	4	36
7:45 AM	8	4	1	0	13	0	3	0	0	3	5	2	6	7	20
8:00 AM	8	9	1	0	18	0	0	0	0	0	6	1	32	1	40
8:15 AM	13	5	1	3	22	0	0	0	0	0	2	0	3	1	6
8:30 AM	5	10	0	2	17	0	1	0	0	1	4	1	27	1	33
8:45 AM	10	10	2	2	24	0	0	0	0	0	1	3	11	3	18
Count Total	56	59	5	12	132	1	10	0	0	11	36	20	107	24	187
Peak Hour	34	25	3	5	67	1	5	0	0	6	25	8	56	13	102

Two-Hour Count Summaries - Heavy Vehicles																		
Interval Start	E Santa Clara St				E Santa Clara St				S 26th St				N 26th St				15-min Total	Rolling One Hour
	Eastbound				Westbound				Northbound				Southbound					
	UT	LT	TH	RT	UT	LT	TH	RT	UT	LT	TH	RT	UT	LT	TH	RT		
7:00 AM	0	0	3	0	0	0	5	1	0	0	0	0	0	0	0	1	10	0
7:15 AM	0	0	4	0	0	0	8	0	0	0	0	0	0	0	2	0	14	0
7:30 AM	0	0	5	0	0	1	5	1	0	0	0	0	0	0	1	1	14	0
7:45 AM	0	0	8	0	0	0	4	0	0	0	0	1	0	0	0	0	13	51
8:00 AM	0	0	8	0	0	0	9	0	0	0	0	1	0	0	0	0	18	59
8:15 AM	0	0	13	0	0	0	5	0	0	0	1	0	0	1	1	1	22	67
8:30 AM	0	0	4	1	0	1	9	0	0	0	0	0	0	1	1	0	17	70
8:45 AM	0	0	10	0	0	0	10	0	0	0	2	0	0	0	1	1	24	81
Count Total	0	0	55	1	0	2	55	2	0	0	3	2	0	3	6	3	132	0
Peak Hour	0	0	34	0	0	1	23	1	0	0	1	2	0	2	2	1	67	0

Two-Hour Count Summaries - Bikes														
Interval Start	E Santa Clara St			E Santa Clara St			S 26th St			N 26th St			15-min Total	Rolling One Hour
	Eastbound			Westbound			Northbound			Southbound				
	LT	TH	RT	LT	TH	RT	LT	TH	RT	LT	TH	RT		
7:00 AM	0	0	0	1	2	0	0	0	0	0	0	0	3	0
7:15 AM	0	0	0	0	1	0	0	0	0	0	0	0	1	0
7:30 AM	0	1	0	0	2	0	0	0	0	0	0	0	3	0
7:45 AM	0	0	0	0	2	1	0	0	0	0	0	0	3	10
8:00 AM	0	0	0	0	0	0	0	0	0	0	0	0	0	7
8:15 AM	0	0	0	0	0	0	0	0	0	0	0	0	0	6
8:30 AM	0	0	0	0	1	0	0	0	0	0	0	0	1	4
8:45 AM	0	0	0	0	0	0	0	0	0	0	0	0	0	1
Count Total	0	1	0	1	8	1	0	0	0	0	0	0	11	0
Peak Hour	0	1	0	0	4	1	0	0	0	0	0	0	6	0

Note: U-Turn volumes for bikes are included in Left-Turn, if any.

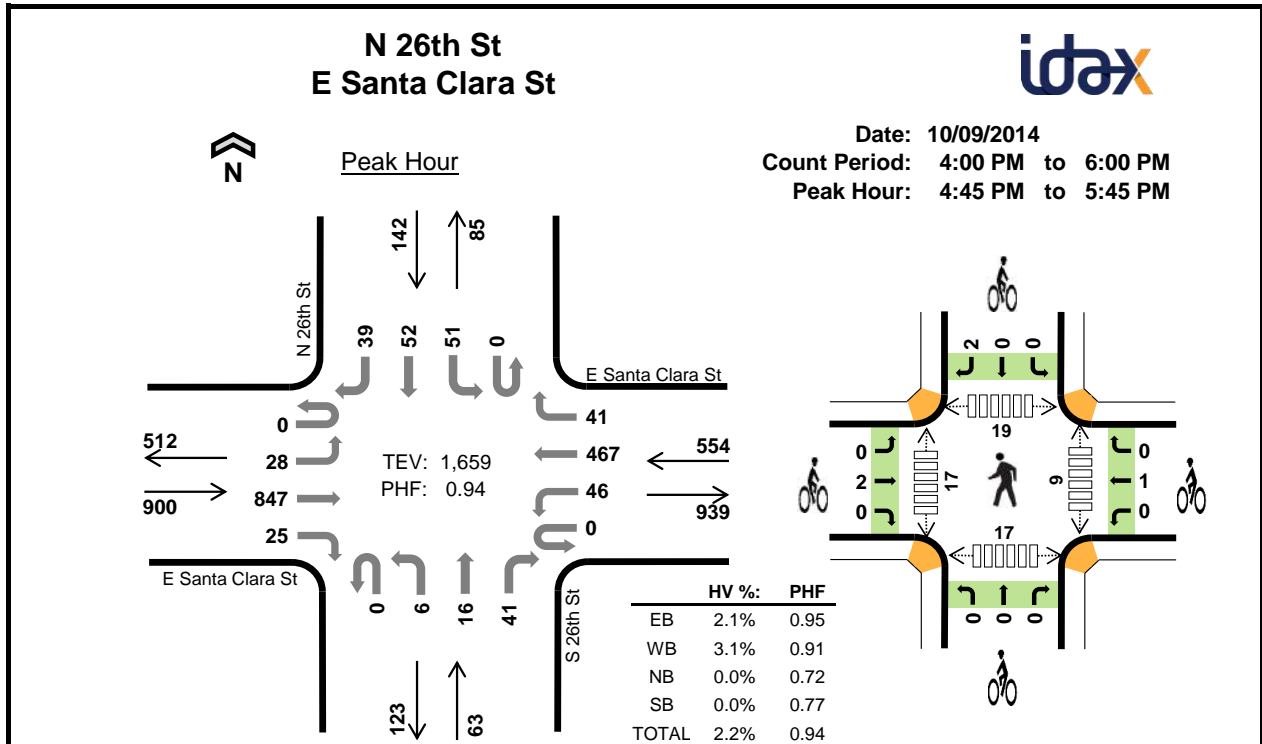

Two-Hour Count Summaries

Interval Start	E Santa Clara St Eastbound				E Santa Clara St Westbound				S 26th St Northbound				N 26th St Southbound				15-min Total	Rolling One Hour	
	UT	LT	TH	RT	UT	LT	TH	RT	UT	LT	TH	RT	UT	LT	TH	RT			
4:00 PM	0	7	176	7	0	5	107	11	0	1	5	12	0	10	10	11	362	0	
4:15 PM	0	4	180	5	0	11	116	8	0	2	4	9	0	8	14	5	366	0	
4:30 PM	0	6	178	8	0	8	98	10	0	5	5	9	0	14	11	9	361	0	
4:45 PM	0	7	202	5	0	12	131	10	0	1	2	7	0	13	7	12	409	1,498	
5:00 PM	0	9	222	7	0	10	105	11	0	3	3	16	0	12	12	6	416	1,552	
5:15 PM	0	7	217	9	0	10	125	11	0	0	7	10	0	14	22	10	442	1,628	
5:30 PM	0	5	206	4	0	14	106	9	0	2	4	8	0	12	11	11	392	1,659	
5:45 PM	0	8	193	8	0	5	117	13	0	1	9	10	0	6	9	6	385	1,635	
Count Total	0	53	1574	53	0	75	905	83	0	15	39	81	0	89	96	70	3,133	0	
Peak Hour	All	0	28	847	25	0	46	467	41	0	6	16	41	0	51	52	39	1,659	0
	HV	0	0	19	0	0	0	17	0	0	0	0	0	0	0	0	0	36	0
	HV%	-	0%	2%	0%	-	0%	4%	0%	-	0%	0%	0%	-	0%	0%	0%	2%	0

Note: Two-hour count summary volumes include heavy vehicles but exclude bicycles in overall count.

Interval Start	Heavy Vehicle Totals					Bicycles					Pedestrians (Crossing Leg)				
	EB	WB	NB	SB	Total	EB	WB	NB	SB	Total	East	West	North	South	Total
4:00 PM	8	5	0	1	14	0	1	0	0	1	2	6	7	4	19
4:15 PM	5	3	0	2	10	0	2	0	0	2	2	3	8	3	16
4:30 PM	7	4	0	1	12	2	2	0	0	4	3	5	13	6	27
4:45 PM	4	5	0	0	9	0	0	0	1	1	5	3	2	9	19
5:00 PM	8	3	0	0	11	1	0	0	0	1	1	7	6	4	18
5:15 PM	4	5	0	0	9	1	0	0	1	2	3	1	9	4	17
5:30 PM	3	4	0	0	7	0	1	0	0	1	0	6	2	0	8
5:45 PM	5	6	1	0	12	0	1	0	0	1	0	3	11	4	18
Count Total	44	35	1	4	84	4	7	0	2	13	16	34	58	34	142
Peak Hour	19	17	0	0	36	2	1	0	2	5	9	17	19	17	62

Two-Hour Count Summaries - Heavy Vehicles																		
Interval Start	E Santa Clara St				E Santa Clara St				S 26th St				N 26th St				15-min Total	Rolling One Hour
	Eastbound				Westbound				Northbound				Southbound					
	UT	LT	TH	RT	UT	LT	TH	RT	UT	LT	TH	RT	UT	LT	TH	RT		
4:00 PM	0	0	7	1	0	0	5	0	0	0	0	0	0	0	1	0	14	0
4:15 PM	0	0	5	0	0	0	3	0	0	0	0	0	0	0	1	1	10	0
4:30 PM	0	1	6	0	0	0	4	0	0	0	0	0	0	0	0	1	12	0
4:45 PM	0	0	4	0	0	0	5	0	0	0	0	0	0	0	0	0	9	45
5:00 PM	0	0	8	0	0	0	3	0	0	0	0	0	0	0	0	0	11	42
5:15 PM	0	0	4	0	0	0	5	0	0	0	0	0	0	0	0	0	9	41
5:30 PM	0	0	3	0	0	0	4	0	0	0	0	0	0	0	0	0	7	36
5:45 PM	0	0	5	0	0	0	5	1	0	0	0	0	1	0	0	0	12	39
Count Total	0	1	42	1	0	0	34	1	0	0	0	1	0	0	2	2	84	0
Peak Hour	0	0	19	0	0	0	17	0	0	0	0	0	0	0	0	0	36	0
Two-Hour Count Summaries - Bikes																		
Interval Start	E Santa Clara St			E Santa Clara St			S 26th St			N 26th St			15-min Total	Rolling One Hour				
	Eastbound			Westbound			Northbound			Southbound								
	LT	TH	RT	LT	TH	RT	LT	TH	RT	LT	TH	RT						
4:00 PM	0	0	0	0	1	0	0	0	0	0	0	0	0	0	1	0		
4:15 PM	0	0	0	0	2	0	0	0	0	0	0	0	0	0	2	0		
4:30 PM	0	2	0	0	1	1	0	0	0	0	0	0	0	0	4	0		
4:45 PM	0	0	0	0	0	0	0	0	0	0	0	0	0	1	1	8		
5:00 PM	0	1	0	0	0	0	0	0	0	0	0	0	0	0	1	8		
5:15 PM	0	1	0	0	0	0	0	0	0	0	0	0	1	2	8			
5:30 PM	0	0	0	0	1	0	0	0	0	0	0	0	0	1	5			
5:45 PM	0	0	0	0	1	0	0	0	0	0	0	0	0	1	5			
Count Total	0	4	0	0	6	1	0	0	0	0	0	2	13	0				
Peak Hour	0	2	0	0	1	0	0	0	0	0	0	2	5	0				

Note: U-Turn volumes for bikes are included in Left-Turn, if any.

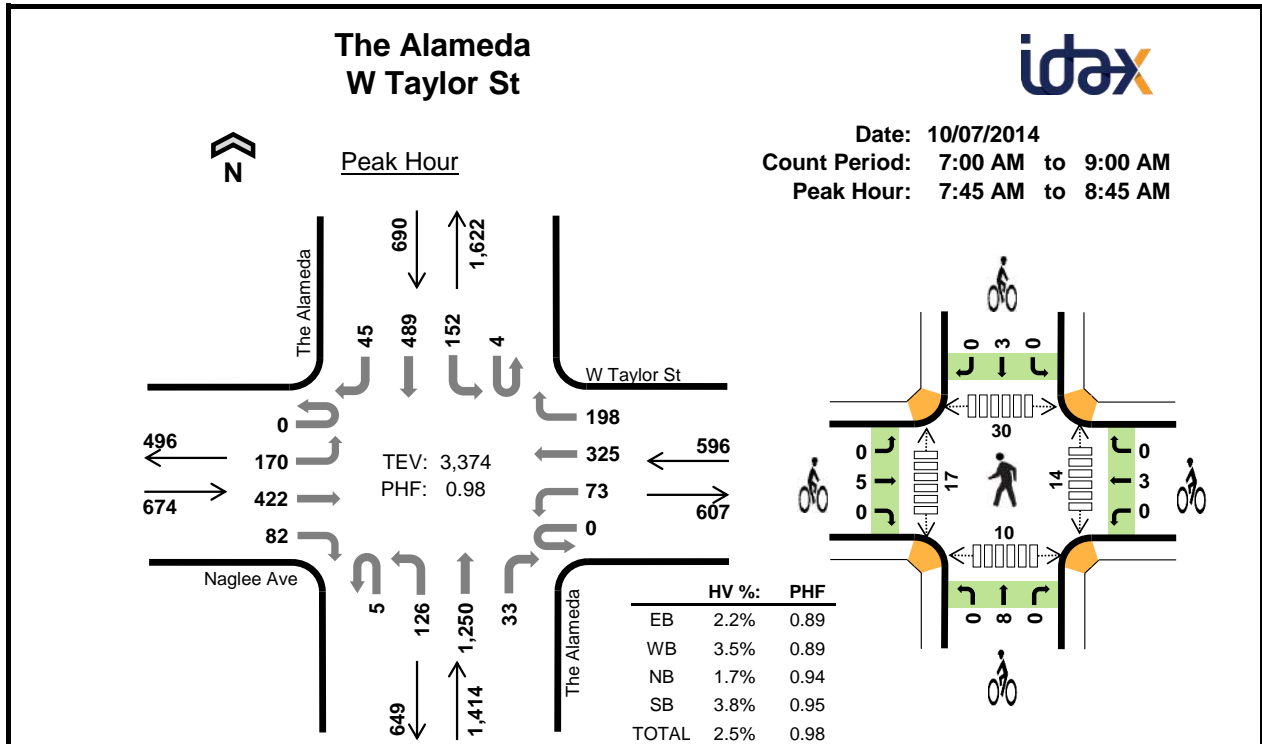

Two-Hour Count Summaries

Interval Start	Naglee Ave				W Taylor St				The Alameda				The Alameda				15-min Total	Rolling One Hour	
	Eastbound				Westbound				Northbound				Southbound						
	UT	LT	TH	RT	UT	LT	TH	RT	UT	LT	TH	RT	UT	LT	TH	RT			
7:00 AM	0	30	41	8	0	3	69	25	0	15	172	2	0	14	72	16	467	0	
7:15 AM	0	35	78	13	0	5	119	19	0	22	263	3	0	23	102	12	694	0	
7:30 AM	0	42	114	14	0	11	114	30	2	34	287	4	1	29	136	11	829	0	
7:45 AM	0	48	125	17	0	25	80	41	0	25	304	7	0	46	122	9	849	2,839	
8:00 AM	0	39	108	15	0	16	73	35	0	34	299	8	0	37	131	13	808	3,180	
8:15 AM	0	39	91	29	0	14	97	48	3	36	324	12	1	30	124	8	856	3,342	
8:30 AM	0	44	98	21	0	18	75	74	2	31	323	6	3	39	112	15	861	3,374	
8:45 AM	0	50	82	18	0	16	84	53	2	21	265	5	5	27	104	7	739	3,264	
Count Total	0	327	737	135	0	108	711	325	9	218	2237	47	10	245	903	91	6,103	0	
Peak Hour	All	0	170	422	82	0	73	325	198	5	126	1250	33	4	152	489	45	3,374	0
	HV	0	3	11	1	0	2	7	12	0	2	22	0	0	3	20	3	86	0
	HV%	-	2%	3%	1%	-	3%	2%	6%	0%	2%	2%	0%	0%	2%	4%	7%	3%	0

Note: Two-hour count summary volumes include heavy vehicles but exclude bicycles in overall count.

Interval Start	Heavy Vehicle Totals					Bicycles					Pedestrians (Crossing Leg)				
	EB	WB	NB	SB	Total	EB	WB	NB	SB	Total	East	West	North	South	Total
7:00 AM	2	9	5	4	20	0	0	0	0	0	7	2	17	4	30
7:15 AM	4	3	9	8	24	3	1	0	0	4	5	5	6	1	17
7:30 AM	1	6	6	7	20	0	1	3	1	5	1	2	6	0	9
7:45 AM	3	4	7	8	22	0	1	0	0	1	2	2	3	0	7
8:00 AM	5	4	8	9	26	1	1	3	1	6	3	8	8	2	21
8:15 AM	5	7	3	6	21	2	0	0	2	4	4	5	14	5	28
8:30 AM	2	6	6	3	17	2	1	5	0	8	5	2	5	3	15
8:45 AM	2	7	8	7	24	2	0	2	1	5	7	4	2	2	15
Count Total	24	46	52	52	174	10	5	13	5	33	34	30	61	17	142
Peak Hour	15	21	24	26	86	5	3	8	3	19	14	17	30	10	71

Two-Hour Count Summaries - Heavy Vehicles																		
Interval Start	Naglee Ave				W Taylor St				The Alameda				The Alameda				15-min Total	Rolling One Hour
	Eastbound				Westbound				Northbound				Southbound					
	UT	LT	TH	RT	UT	LT	TH	RT	UT	LT	TH	RT	UT	LT	TH	RT		
7:00 AM	0	1	1	0	0	0	4	5	0	0	5	0	0	0	4	0	20	0
7:15 AM	0	0	3	1	0	0	2	1	0	1	7	1	0	2	6	0	24	0
7:30 AM	0	0	1	0	0	0	2	4	0	0	6	0	0	0	7	0	20	0
7:45 AM	0	1	1	1	0	0	0	4	0	1	6	0	0	0	6	2	22	86
8:00 AM	0	1	4	0	0	0	1	3	0	0	8	0	0	2	6	1	26	92
8:15 AM	0	1	4	0	0	0	4	3	0	0	3	0	0	1	5	0	21	89
8:30 AM	0	0	2	0	0	2	2	2	0	1	5	0	0	0	3	0	17	86
8:45 AM	0	0	1	1	0	1	3	3	0	0	8	0	0	2	5	0	24	88
Count Total	0	4	17	3	0	3	18	25	0	3	48	1	0	7	42	3	174	0
Peak Hour	0	3	11	1	0	2	7	12	0	2	22	0	0	3	20	3	86	0
Two-Hour Count Summaries - Bikes																		
Interval Start	Naglee Ave			W Taylor St			The Alameda			The Alameda			15-min Total	Rolling One Hour				
	Eastbound			Westbound			Northbound			Southbound								
	LT	TH	RT	LT	TH	RT	LT	TH	RT	LT	TH	RT						
7:00 AM	0	0	0	0	0	0	0	0	0	0	0	0	0	0				
7:15 AM	0	3	0	0	1	0	0	0	0	0	0	0	4	0				
7:30 AM	0	0	0	0	1	0	0	3	0	0	1	0	5	0				
7:45 AM	0	0	0	0	1	0	0	0	0	0	0	0	1	10				
8:00 AM	0	1	0	0	1	0	0	3	0	0	1	0	6	16				
8:15 AM	0	2	0	0	0	0	0	0	0	0	2	0	4	16				
8:30 AM	0	2	0	0	1	0	0	5	0	0	0	0	8	19				
8:45 AM	0	2	0	0	0	0	0	2	0	0	1	0	5	23				
Count Total	0	10	0	0	5	0	0	13	0	0	5	0	33	0				
Peak Hour	0	5	0	0	3	0	0	8	0	0	3	0	19	0				

Note: U-Turn volumes for bikes are included in Left-Turn, if any.

INTERSECTION TURNING MOVEMENT COUNT SUMMARY

CLIENT: KITTELSON & ASSOCIATES, INC
 PROJECT: 2014 SCVTA CMP MONITORING
 DATE: TUESDAY SEPTEMBER 30, 2014
 PERIOD: 4:00 PM TO 6:00 PM
 INTERSECTION: N/S THE ALAMEDA (RTE 82)
 E/W NAGLEE AVENUE
 CITY: SAN JOSE

VEHICLES

15 MIN COUNTS														4:00 PM TO 6:00 PM
PERIOD	1	2	3	4	5	6	7	8	9	10	11	12	TOTAL	
	SBRT	SBTH	SBLT	WBRT	WBTH	WBLT	NBRT	NBTH	NBLT	EBRT	EBTH	EBLT		
400-415	6	214	51	39	69	27	7	111	23	12	84	18	661	
415-430	10	244	49	23	71	23	6	144	21	19	94	15	719	
430-445	20	229	39	38	71	21	9	131	24	21	90	25	718	
445-500	22	243	37	39	99	21	6	157	36	11	109	21	801	
500-515	22	278	64	50	78	22	8	147	34	11	93	24	831	
515-530	16	270	78	36	126	27	4	148	58	25	139	27	954	
530-545	13	296	86	39	101	29	8	126	26	19	103	21	867	
545-600	19	280	69	41	108	36	15	119	32	24	97	16	856	
HOUR TOTALS														
TIME	1	2	3	4	5	6	7	8	9	10	11	12	TOTAL	
	SBRT	SBTH	SBLT	WBRT	WBTH	WBLT	NBRT	NBTH	NBLT	EBRT	EBTH	EBLT		
400-500	58	930	176	139	310	92	28	543	104	63	377	79	2899	
415-515	74	994	189	150	319	87	29	579	115	62	386	85	3069	
430-530	80	1020	218	163	374	91	27	583	152	68	431	97	3304	
445-545	73	1087	265	164	404	99	26	578	154	66	444	93	3453	
500-600	70	1124	297	166	413	114	35	540	150	79	432	88	3508	

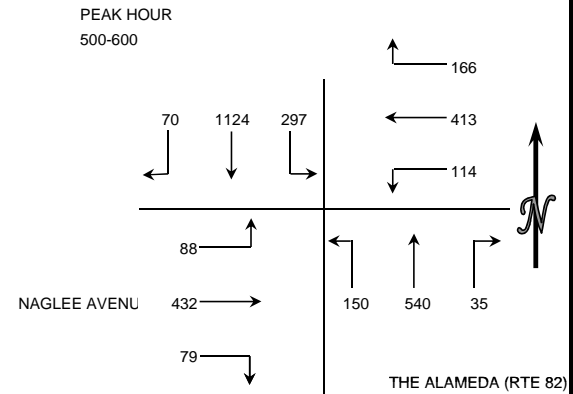

BICYCLES

15 MIN COUNTS														4:00 PM TO 6:00 PM
PERIOD	1	2	3	4	5	6	7	8	9	10	11	12	TOTAL	
	SBRT	SBTH	SBLT	WBRT	WBTH	WBLT	NBRT	NBTH	NBLT	EBRT	EBTH	EBLT		
400-415	0	3	0	0	2	0	0	2	0	0	2	0	9	
415-430	0	1	0	0	0	0	0	0	0	0	1	0	2	
430-445	0	1	0	0	2	0	0	2	0	0	0	0	5	
445-500	0	0	0	0	1	0	0	0	0	0	0	0	1	
500-515	0	0	0	0	1	0	0	2	0	0	0	0	3	
515-530	0	1	0	0	0	0	0	0	0	0	0	0	1	
530-545	0	1	0	0	2	0	0	0	0	0	0	0	3	
545-600	0	0	0	0	1	0	0	1	0	0	1	0	3	
HOUR TOTALS														
TIME	1	2	3	4	5	6	7	8	9	10	11	12	TOTAL	
	SBRT	SBTH	SBLT	WBRT	WBTH	WBLT	NBRT	NBTH	NBLT	EBRT	EBTH	EBLT		
400-500	0	5	0	0	5	0	0	4	0	0	3	0	17	
415-515	0	2	0	0	4	0	0	4	0	0	1	0	11	
430-530	0	2	0	0	4	0	0	4	0	0	0	0	10	
445-545	0	2	0	0	4	0	0	2	0	0	0	0	8	
500-600	0	2	0	0	4	0	0	3	0	0	1	0	10	

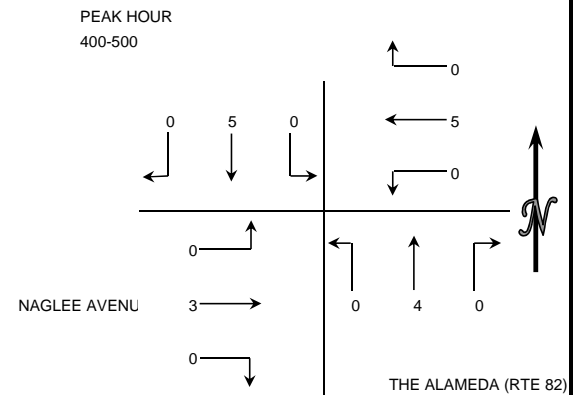

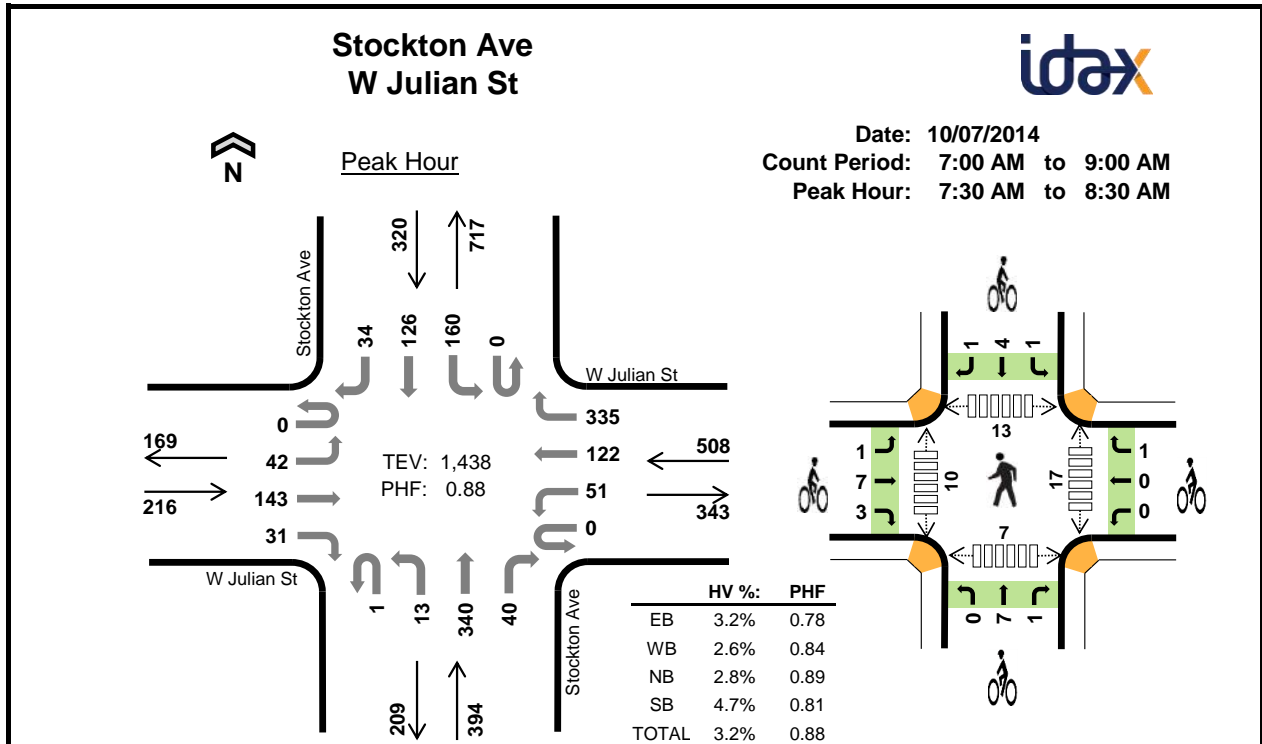

Two-Hour Count Summaries

Interval Start	W Julian St Eastbound				W Julian St Westbound				Stockton Ave Northbound				Stockton Ave Southbound				15-min Total	Rolling One Hour	
	UT	LT	TH	RT	UT	LT	TH	RT	UT	LT	TH	RT	UT	LT	TH	RT			
7:00 AM	0	1	18	2	0	11	33	38	0	0	43	7	0	22	14	2	191	0	
7:15 AM	0	4	22	5	0	12	36	48	0	1	58	11	0	22	19	2	240	0	
7:30 AM	0	11	31	5	0	9	25	75	0	0	91	11	0	45	33	5	341	0	
7:45 AM	0	5	46	9	0	12	39	101	0	8	77	12	0	49	40	10	408	1,180	
8:00 AM	0	21	40	8	0	19	28	86	0	3	99	9	0	37	30	10	390	1,379	
8:15 AM	0	5	26	9	0	11	30	73	1	2	73	8	0	29	23	9	299	1,438	
8:30 AM	0	4	40	11	0	16	26	37	0	3	82	9	0	35	30	4	297	1,394	
8:45 AM	0	5	35	6	0	7	40	44	0	4	64	11	0	31	18	8	273	1,259	
Count Total	0	56	258	55	0	97	257	502	1	21	587	78	0	270	207	50	2,439	0	
Peak Hour	All	0	42	143	31	0	51	122	335	1	13	340	40	0	160	126	34	1,438	0
	HV	0	1	4	2	0	2	3	8	0	1	6	4	0	8	6	1	46	0
	HV%	-	2%	3%	6%	-	4%	2%	2%	0%	8%	2%	10%	-	5%	5%	3%	3%	0

Note: Two-hour count summary volumes include heavy vehicles but exclude bicycles in overall count.

Interval Start	Heavy Vehicle Totals					Bicycles					Pedestrians (Crossing Leg)				
	EB	WB	NB	SB	Total	EB	WB	NB	SB	Total	East	West	North	South	Total
7:00 AM	0	1	1	3	5	0	0	2	2	4	0	0	0	0	0
7:15 AM	1	5	2	0	8	2	1	1	0	4	5	0	3	0	8
7:30 AM	1	5	5	6	17	4	1	4	2	11	5	3	3	3	14
7:45 AM	1	2	3	1	7	5	0	0	1	6	6	1	4	0	11
8:00 AM	3	3	2	2	10	0	0	4	0	4	5	3	1	2	11
8:15 AM	2	3	1	6	12	2	0	0	3	5	1	3	5	2	11
8:30 AM	4	3	0	9	16	2	0	1	0	3	6	2	2	1	11
8:45 AM	1	2	1	3	7	1	3	0	3	7	5	3	0	2	10
Count Total	13	24	15	30	82	16	5	12	11	44	33	15	18	10	76
Peak Hour	7	13	11	15	46	11	1	8	6	26	17	10	13	7	47

Two-Hour Count Summaries - Heavy Vehicles																		
Interval Start	W Julian St				W Julian St				Stockton Ave				Stockton Ave				15-min Total	Rolling One Hour
	Eastbound				Westbound				Northbound				Southbound					
	UT	LT	TH	RT	UT	LT	TH	RT	UT	LT	TH	RT	UT	LT	TH	RT		
7:00 AM	0	0	0	0	0	0	1	0	0	0	0	1	0	1	1	1	5	0
7:15 AM	0	0	0	1	0	1	1	3	0	0	1	1	0	0	0	0	8	0
7:30 AM	0	0	1	0	0	1	2	2	0	0	2	3	0	2	4	0	17	0
7:45 AM	0	0	0	1	0	0	0	2	0	1	1	1	0	1	0	0	7	37
8:00 AM	0	1	2	0	0	1	0	2	0	0	2	0	0	2	0	0	10	42
8:15 AM	0	0	1	1	0	0	1	2	0	0	1	0	0	3	2	1	12	46
8:30 AM	0	0	1	3	0	3	0	0	0	0	0	0	0	6	3	0	16	45
8:45 AM	0	0	1	0	0	0	0	2	0	1	0	0	0	3	0	0	7	45
Count Total	0	1	6	6	0	6	5	13	0	2	7	6	0	18	10	2	82	0
Peak Hour	0	1	4	2	0	2	3	8	0	1	6	4	0	8	6	1	46	0
Two-Hour Count Summaries - Bikes																		
Interval Start	W Julian St			W Julian St			Stockton Ave			Stockton Ave			15-min Total	Rolling One Hour				
	Eastbound			Westbound			Northbound			Southbound								
	LT	TH	RT	LT	TH	RT	LT	TH	RT	LT	TH	RT						
7:00 AM	0	0	0	0	0	0	0	2	0	1	0	1	4	0				
7:15 AM	1	1	0	0	1	0	0	0	1	0	0	0	4	0				
7:30 AM	0	2	2	0	0	1	0	4	0	0	2	0	11	0				
7:45 AM	1	3	1	0	0	0	0	0	0	0	1	0	6	25				
8:00 AM	0	0	0	0	0	0	0	3	1	0	0	0	4	25				
8:15 AM	0	2	0	0	0	0	0	0	0	1	1	1	5	26				
8:30 AM	0	1	1	0	0	0	0	1	0	0	0	0	3	18				
8:45 AM	0	0	1	0	1	2	0	0	0	1	1	1	7	19				
Count Total	2	9	5	0	2	3	0	10	2	3	5	3	44	0				
Peak Hour	1	7	3	0	0	1	0	7	1	1	4	1	26	0				
<i>Note: U-Turn volumes for bikes are included in Left-Turn, if any.</i>																		

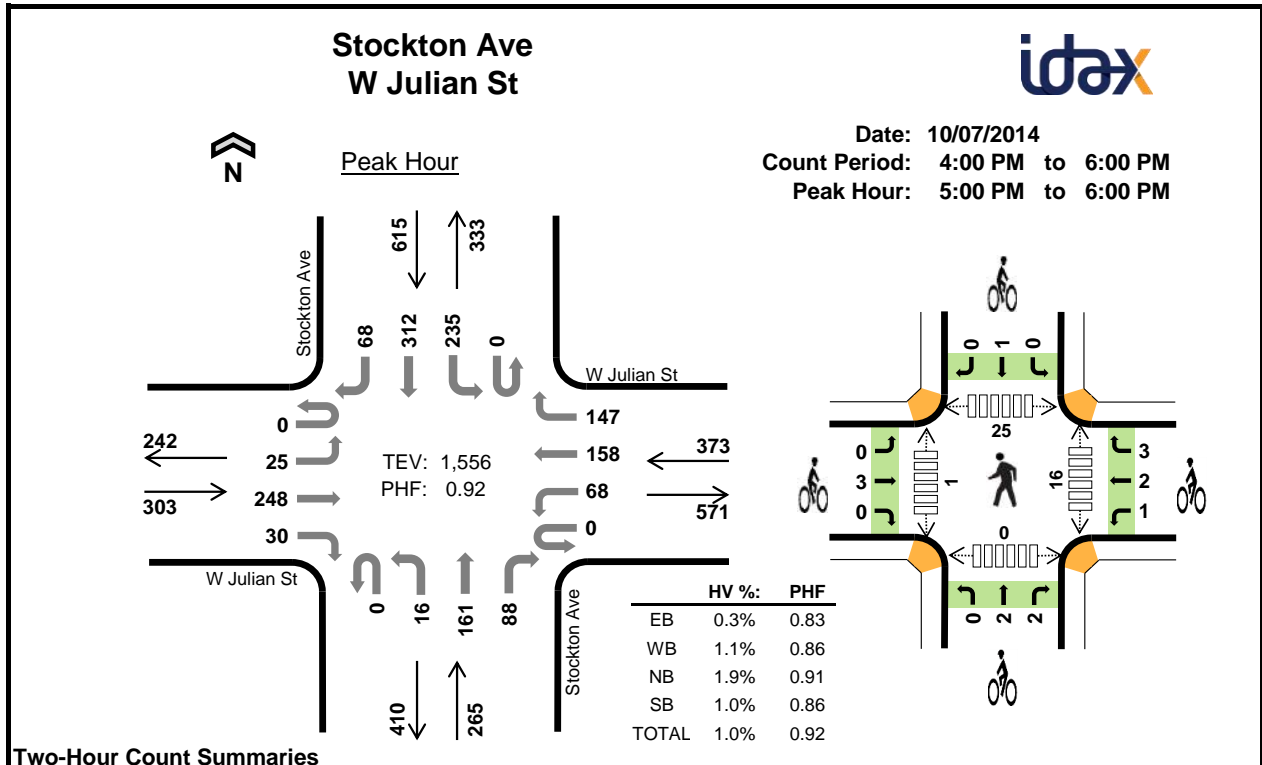

Two-Hour Count Summaries

Interval Start	W Julian St Eastbound				W Julian St Westbound				Stockton Ave Northbound				Stockton Ave Southbound				15-min Total	Rolling One Hour	
	UT	LT	TH	RT	UT	LT	TH	RT	UT	LT	TH	RT	UT	LT	TH	RT			
4:00 PM	0	7	51	6	0	22	39	38	0	0	33	10	0	51	47	7	311	0	
4:15 PM	0	5	52	5	0	8	35	34	0	1	35	10	0	49	63	14	311	0	
4:30 PM	0	3	50	5	0	10	51	29	0	6	34	19	0	56	54	8	325	0	
4:45 PM	0	10	33	9	0	15	32	29	0	2	36	22	0	53	65	12	318	1,265	
5:00 PM	0	1	72	9	0	14	42	53	0	5	40	20	0	63	78	21	418	1,372	
5:15 PM	0	11	58	5	0	23	43	33	0	5	45	23	0	71	93	15	425	1,486	
5:30 PM	0	9	71	11	0	15	34	28	0	3	39	24	0	56	73	18	381	1,542	
5:45 PM	0	4	47	5	0	16	39	33	0	3	37	21	0	45	68	14	332	1,556	
Count Total	0	50	434	55	0	123	315	277	0	25	299	149	0	444	541	109	2,821	0	
Peak Hour	All	0	25	248	30	0	68	158	147	0	16	161	88	0	235	312	68	1,556	0
	HV	0	0	1	0	0	0	1	3	0	0	4	1	0	3	3	0	16	0
	HV%	-	0%	0%	0%	-	0%	1%	2%	-	0%	2%	1%	-	1%	1%	0%	1%	0

Note: Two-hour count summary volumes include heavy vehicles but exclude bicycles in overall count.

Interval Start	Heavy Vehicle Totals					Bicycles					Pedestrians (Crossing Leg)				
	EB	WB	NB	SB	Total	EB	WB	NB	SB	Total	East	West	North	South	Total
4:00 PM	1	1	2	2	6	0	1	0	0	1	5	4	8	0	17
4:15 PM	1	2	1	2	6	0	2	0	2	4	2	1	2	0	5
4:30 PM	2	1	2	1	6	0	1	0	2	3	2	0	2	1	5
4:45 PM	0	1	2	1	4	0	3	2	1	6	4	4	2	2	12
5:00 PM	1	1	1	1	4	0	1	2	1	4	1	0	3	0	4
5:15 PM	0	0	4	2	6	1	1	1	0	3	11	1	6	0	18
5:30 PM	0	2	0	1	3	1	0	0	0	1	3	0	8	0	11
5:45 PM	0	1	0	2	3	1	4	1	0	6	1	0	8	0	9
Count Total	5	9	12	12	38	3	13	6	6	28	29	10	39	3	81
Peak Hour	1	4	5	6	16	3	6	4	1	14	16	1	25	0	42

Two-Hour Count Summaries - Heavy Vehicles																		
Interval Start	W Julian St				W Julian St				Stockton Ave				Stockton Ave				15-min Total	Rolling One Hour
	Eastbound				Westbound				Northbound				Southbound					
	UT	LT	TH	RT	UT	LT	TH	RT	UT	LT	TH	RT	UT	LT	TH	RT		
4:00 PM	0	0	0	1	0	0	1	0	0	0	1	1	0	1	1	0	6	0
4:15 PM	0	0	0	1	0	0	0	2	0	0	0	1	0	0	1	1	6	0
4:30 PM	0	0	2	0	0	1	0	0	0	0	2	0	0	1	0	0	6	0
4:45 PM	0	0	0	0	0	0	0	1	0	0	1	1	0	1	0	0	4	22
5:00 PM	0	0	1	0	0	0	1	0	0	0	1	0	0	0	1	0	4	20
5:15 PM	0	0	0	0	0	0	0	0	0	0	3	1	0	1	1	0	6	20
5:30 PM	0	0	0	0	0	0	0	2	0	0	0	0	0	1	0	0	3	17
5:45 PM	0	0	0	0	0	0	0	1	0	0	0	0	0	1	1	0	3	16
Count Total	0	0	3	2	0	1	2	6	0	0	8	4	0	6	5	1	38	0
Peak Hour	0	0	1	0	0	0	1	3	0	0	4	1	0	3	3	0	16	0
Two-Hour Count Summaries - Bikes																		
Interval Start	W Julian St			W Julian St			Stockton Ave			Stockton Ave			15-min Total	Rolling One Hour				
	Eastbound			Westbound			Northbound			Southbound								
	LT	TH	RT	LT	TH	RT	LT	TH	RT	LT	TH	RT						
4:00 PM	0	0	0	0	0	1	0	0	0	0	0	0	0	0	1	0		
4:15 PM	0	0	0	1	0	1	0	0	0	0	0	1	1	0	4	0		
4:30 PM	0	0	0	0	1	0	0	0	0	0	0	0	2	0	3	0		
4:45 PM	0	0	0	0	0	3	0	0	2	0	1	0	0	1	0	6	14	
5:00 PM	0	0	0	0	0	1	0	0	2	0	1	0	0	1	0	4	17	
5:15 PM	0	1	0	0	0	1	0	1	0	0	1	0	0	0	0	3	16	
5:30 PM	0	1	0	0	0	0	0	0	0	0	0	0	0	0	0	1	14	
5:45 PM	0	1	0	1	2	1	0	1	0	0	1	0	0	0	0	6	14	
Count Total	0	3	0	2	3	8	0	2	4	1	5	0	1	5	0	28	0	
Peak Hour	0	3	0	1	2	3	0	2	2	0	1	0	0	1	0	14	0	
<i>Note: U-Turn volumes for bikes are included in Left-Turn, if any.</i>																		

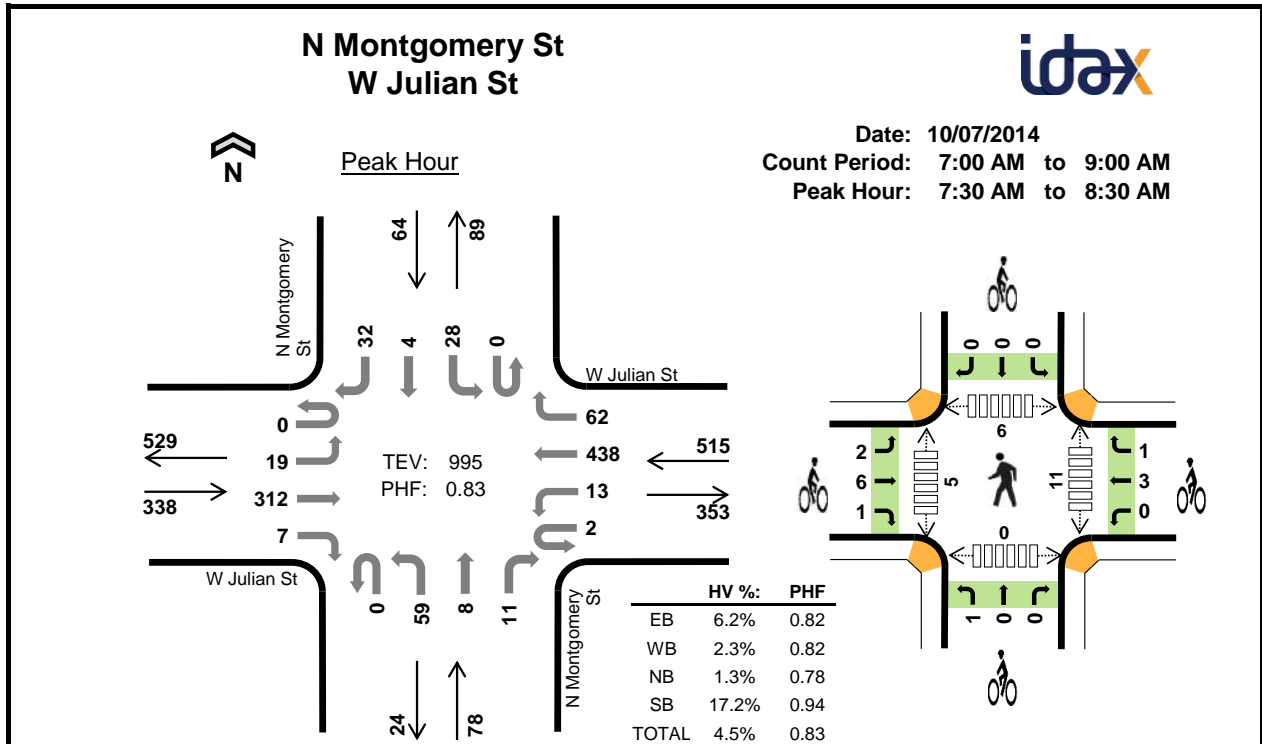

Two-Hour Count Summaries

Interval Start	W Julian St Eastbound				W Julian St Westbound				N Montgomery St Northbound				N Montgomery St Southbound				15-min Total	Rolling One Hour	
	UT	LT	TH	RT	UT	LT	TH	RT	UT	LT	TH	RT	UT	LT	TH	RT			
7:00 AM	0	6	37	1	0	0	76	15	0	2	2	0	0	11	1	5	156	0	
7:15 AM	0	3	50	2	0	3	87	20	0	6	3	2	0	7	1	6	190	0	
7:30 AM	0	6	78	2	0	5	84	12	0	9	3	3	0	6	0	11	219	0	
7:45 AM	0	5	96	2	2	2	134	19	0	19	1	2	0	9	2	6	299	864	
8:00 AM	0	4	85	3	0	3	115	16	0	14	0	2	0	7	0	8	257	965	
8:15 AM	0	4	53	0	0	3	105	15	0	17	4	4	0	6	2	7	220	995	
8:30 AM	0	7	68	2	0	0	74	12	0	5	1	0	0	6	0	6	181	957	
8:45 AM	0	6	71	3	0	4	87	26	0	1	2	0	0	11	1	6	218	876	
Count Total	0	41	538	15	2	20	762	135	0	73	16	13	0	63	7	55	1,740	0	
Peak Hour	All	0	19	312	7	2	13	438	62	0	59	8	11	0	28	4	32	995	0
	HV	0	4	17	0	0	0	10	2	0	0	1	0	0	5	1	5	45	0
	HV%	-	21%	5%	0%	0%	0%	2%	3%	-	0%	13%	0%	-	18%	25%	16%	5%	0

Note: Two-hour count summary volumes include heavy vehicles but exclude bicycles in overall count.

Interval Start	Heavy Vehicle Totals					Bicycles					Pedestrians (Crossing Leg)				
	EB	WB	NB	SB	Total	EB	WB	NB	SB	Total	East	West	North	South	Total
7:00 AM	2	2	0	6	10	1	1	0	1	3	2	0	1	0	3
7:15 AM	0	5	2	4	11	2	1	1	0	4	1	3	0	0	4
7:30 AM	8	2	0	3	13	2	0	1	0	3	2	0	0	0	2
7:45 AM	3	1	0	4	8	4	2	0	0	6	1	2	1	0	4
8:00 AM	6	5	0	1	12	2	1	0	0	3	5	2	1	0	8
8:15 AM	4	4	1	3	12	1	1	0	0	2	3	1	4	0	8
8:30 AM	5	7	0	1	13	0	0	0	0	0	2	0	0	0	2
8:45 AM	5	7	0	4	16	0	1	0	1	2	1	0	2	0	3
Count Total	33	33	3	26	95	12	7	2	2	23	17	8	9	0	34
Peak Hour	21	12	1	11	45	9	4	1	0	14	11	5	6	0	22

Two-Hour Count Summaries - Heavy Vehicles																		
Interval Start	W Julian St				W Julian St				N Montgomery St				N Montgomery St				15-min Total	Rolling One Hour
	Eastbound				Westbound				Northbound				Southbound					
	UT	LT	TH	RT	UT	LT	TH	RT	UT	LT	TH	RT	UT	LT	TH	RT		
7:00 AM	0	1	1	0	0	0	1	1	0	0	0	0	0	5	0	1	10	0
7:15 AM	0	0	0	0	0	0	3	2	0	1	1	0	0	1	0	3	11	0
7:30 AM	0	1	7	0	0	0	2	0	0	0	0	0	0	1	0	2	13	0
7:45 AM	0	1	2	0	0	0	1	0	0	0	0	0	0	2	1	1	8	42
8:00 AM	0	1	5	0	0	0	3	2	0	0	0	0	0	0	0	1	12	44
8:15 AM	0	1	3	0	0	0	4	0	0	0	1	0	0	2	0	1	12	45
8:30 AM	0	1	4	0	0	0	5	2	0	0	0	0	0	1	0	0	13	45
8:45 AM	0	0	5	0	0	0	2	5	0	0	0	0	0	3	0	1	16	53
Count Total	0	6	27	0	0	0	21	12	0	1	2	0	0	15	1	10	95	0
Peak Hour	0	4	17	0	0	0	10	2	0	0	1	0	0	5	1	5	45	0
Two-Hour Count Summaries - Bikes																		
Interval Start	W Julian St			W Julian St			N Montgomery St			N Montgomery St			15-min Total	Rolling One Hour				
	Eastbound			Westbound			Northbound			Southbound								
	LT	TH	RT	LT	TH	RT	LT	TH	RT	LT	TH	RT						
7:00 AM	0	0	1	0	0	1	0	0	0	0	1	0	3	0				
7:15 AM	0	2	0	0	1	0	0	0	1	0	0	0	4	0				
7:30 AM	0	2	0	0	0	0	1	0	0	0	0	0	3	0				
7:45 AM	0	3	1	0	2	0	0	0	0	0	0	0	6	16				
8:00 AM	1	1	0	0	0	1	0	0	0	0	0	0	3	16				
8:15 AM	1	0	0	0	1	0	0	0	0	0	0	0	2	14				
8:30 AM	0	0	0	0	0	0	0	0	0	0	0	0	0	11				
8:45 AM	0	0	0	0	1	0	0	0	0	0	1	0	2	7				
Count Total	2	8	2	0	5	2	1	0	1	0	1	1	23	0				
Peak Hour	2	6	1	0	3	1	1	0	0	0	0	0	14	0				
<i>Note: U-Turn volumes for bikes are included in Left-Turn, if any.</i>																		

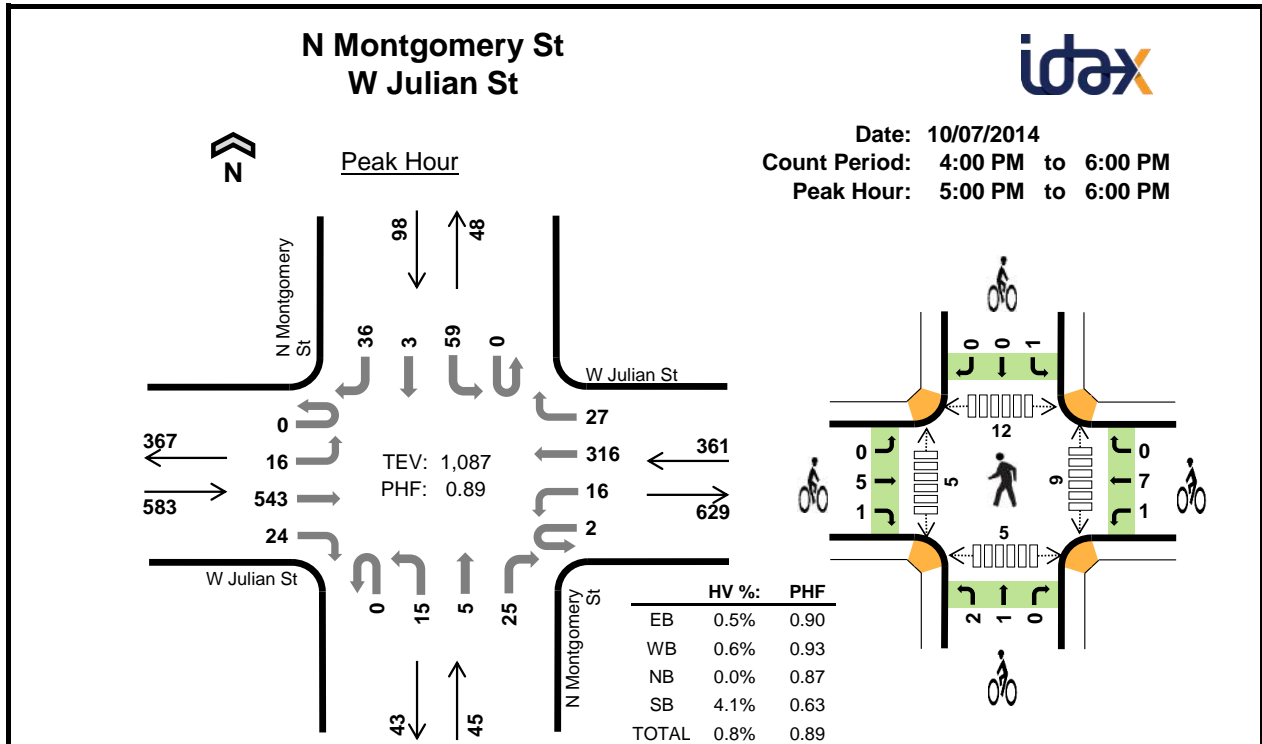

Two-Hour Count Summaries

Interval Start	W Julian St Eastbound				W Julian St Westbound				N Montgomery St Northbound				N Montgomery St Southbound				15-min Total	Rolling One Hour	
	UT	LT	TH	RT	UT	LT	TH	RT	UT	LT	TH	RT	UT	LT	TH	RT			
4:00 PM	0	9	103	2	0	1	78	10	0	6	0	8	0	30	1	11	259	0	
4:15 PM	0	7	96	4	0	2	78	7	0	2	2	2	0	9	1	4	214	0	
4:30 PM	0	4	123	5	1	3	79	13	0	3	0	3	0	18	1	6	259	0	
4:45 PM	0	2	94	3	1	5	78	10	0	3	1	2	0	10	1	3	213	945	
5:00 PM	0	4	151	4	1	1	86	9	0	7	0	4	0	23	0	16	306	992	
5:15 PM	0	6	148	8	1	2	87	4	0	3	2	7	0	15	2	5	290	1,068	
5:30 PM	0	2	136	5	0	1	71	9	0	3	3	7	0	11	1	12	261	1,070	
5:45 PM	0	4	108	7	0	12	72	5	0	2	0	7	0	10	0	3	230	1,087	
Count Total	0	38	959	38	4	27	629	67	0	29	8	40	0	126	7	60	2,032	0	
Peak Hour	All	0	16	543	24	2	16	316	27	0	15	5	25	0	59	3	36	1,087	0
	HV	0	2	1	0	0	0	1	1	0	0	0	0	0	1	0	3	9	0
	HV%	-	13%	0%	0%	0%	0%	0%	4%	-	0%	0%	0%	-	2%	0%	8%	1%	0

Note: Two-hour count summary volumes include heavy vehicles but exclude bicycles in overall count.

Interval Start	Heavy Vehicle Totals					Bicycles					Pedestrians (Crossing Leg)				
	EB	WB	NB	SB	Total	EB	WB	NB	SB	Total	East	West	North	South	Total
4:00 PM	2	5	0	2	9	1	1	0	0	2	4	0	6	0	10
4:15 PM	1	3	0	1	5	2	1	1	0	4	4	3	2	0	9
4:30 PM	4	1	2	2	9	0	4	0	1	5	2	1	2	1	6
4:45 PM	1	3	0	1	5	0	3	1	1	5	5	1	7	0	13
5:00 PM	2	0	0	2	4	1	1	1	0	3	4	1	3	1	9
5:15 PM	0	0	0	0	0	3	2	0	0	5	1	3	1	0	5
5:30 PM	0	2	0	1	3	1	1	0	1	3	2	1	5	4	12
5:45 PM	1	0	0	1	2	1	4	2	0	7	2	0	3	0	5
Count Total	11	14	2	10	37	9	17	5	3	34	24	10	29	6	69
Peak Hour	3	2	0	4	9	6	8	3	1	18	9	5	12	5	31

Two-Hour Count Summaries - Heavy Vehicles																			
Interval Start	W Julian St				W Julian St				N Montgomery St				N Montgomery St				15-min Total	Rolling One Hour	
	Eastbound				Westbound				Northbound				Southbound						
	UT	LT	TH	RT	UT	LT	TH	RT	UT	LT	TH	RT	UT	LT	TH	RT			
4:00 PM	0	1	1	0	0	0	4	1	0	0	0	0	0	0	2	0	0	9	0
4:15 PM	0	0	1	0	0	0	1	2	0	0	0	0	0	0	0	0	1	5	0
4:30 PM	0	1	2	1	0	0	0	1	0	1	0	1	0	2	0	0	9	0	
4:45 PM	0	0	1	0	0	0	0	3	0	0	0	0	0	0	0	1	5	28	
5:00 PM	0	1	1	0	0	0	0	0	0	0	0	0	0	1	0	1	4	23	
5:15 PM	0	0	0	0	0	0	0	0	0	0	0	0	0	0	0	0	0	0	18
5:30 PM	0	0	0	0	0	0	1	1	0	0	0	0	0	0	0	1	3	12	
5:45 PM	0	1	0	0	0	0	0	0	0	0	0	0	0	0	0	1	2	9	
Count Total	0	4	6	1	0	0	6	8	0	1	0	1	0	5	0	5	37	0	
Peak Hour	0	2	1	0	0	0	1	1	0	0	0	0	0	1	0	3	9	0	
Two-Hour Count Summaries - Bikes																			
Interval Start	W Julian St			W Julian St			N Montgomery St			N Montgomery St			15-min Total	Rolling One Hour					
	Eastbound			Westbound			Northbound			Southbound									
	LT	TH	RT	LT	TH	RT	LT	TH	RT	LT	TH	RT							
4:00 PM	0	1	0	0	1	0	0	0	0	0	0	0	0	0	2	0			
4:15 PM	0	2	0	0	1	0	1	0	0	0	0	0	0	4	0				
4:30 PM	0	0	0	1	1	2	0	0	0	0	0	0	1	5	0				
4:45 PM	0	0	0	0	3	0	0	1	0	0	0	0	1	5	16				
5:00 PM	0	1	0	0	1	0	1	0	0	0	0	0	0	3	17				
5:15 PM	0	2	1	0	2	0	0	0	0	0	0	0	0	5	18				
5:30 PM	0	1	0	1	0	0	0	0	0	0	1	0	0	3	16				
5:45 PM	0	1	0	0	4	0	1	1	0	0	0	0	0	7	18				
Count Total	0	8	1	2	13	2	3	2	0	1	0	2	34	0					
Peak Hour	0	5	1	1	7	0	2	1	0	1	0	0	18	0					
<i>Note: U-Turn volumes for bikes are included in Left-Turn, if any.</i>																			

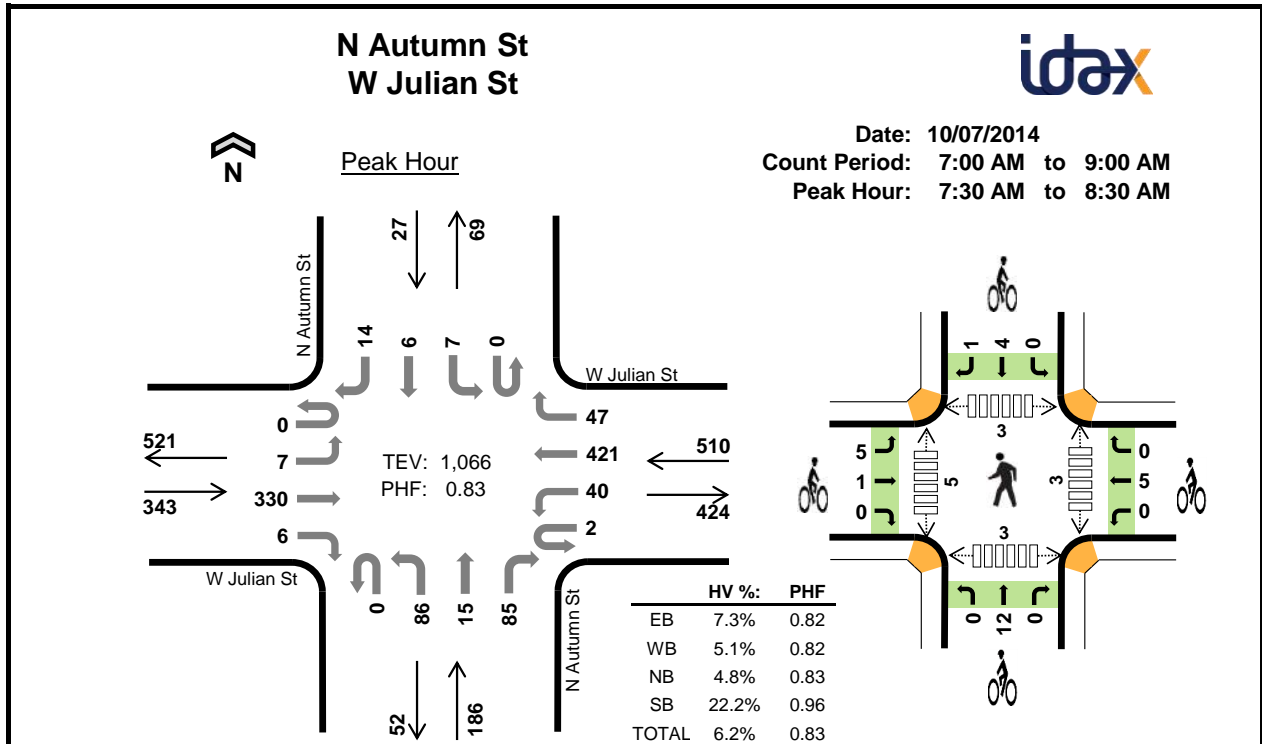

Two-Hour Count Summaries

Interval Start	W Julian St Eastbound				W Julian St Westbound				N Autumn St Northbound				N Autumn St Southbound				15-min Total	Rolling One Hour	
	UT	LT	TH	RT	UT	LT	TH	RT	UT	LT	TH	RT	UT	LT	TH	RT			
7:00 AM	0	2	46	0	0	1	97	20	0	5	2	14	0	1	1	0	189	0	
7:15 AM	0	1	58	1	0	2	86	13	0	7	3	7	0	1	2	5	186	0	
7:30 AM	0	2	79	0	0	15	86	9	0	13	2	13	0	1	1	4	225	0	
7:45 AM	0	2	101	2	1	11	133	10	0	32	5	19	0	2	1	4	323	923	
8:00 AM	0	3	85	4	1	4	105	22	0	24	4	28	0	2	2	3	287	1,021	
8:15 AM	0	0	65	0	0	10	97	6	0	17	4	25	0	2	2	3	231	1,066	
8:30 AM	0	3	69	1	1	6	61	8	0	9	3	21	0	1	0	7	190	1,031	
8:45 AM	0	1	85	0	1	10	95	4	0	20	3	16	0	3	0	1	239	947	
Count Total	0	14	588	8	4	59	760	92	0	127	26	143	0	13	9	27	1,870	0	
Peak Hour	All	0	7	330	6	2	40	421	47	0	86	15	85	0	7	6	14	1,066	0
	HV	0	1	23	1	0	2	19	5	0	5	1	3	0	0	3	3	66	0
	HV%	-	14%	7%	17%	0%	5%	5%	11%	-	6%	7%	4%	-	0%	50%	21%	6%	0

Note: Two-hour count summary volumes include heavy vehicles but exclude bicycles in overall count.

Interval Start	Heavy Vehicle Totals					Bicycles					Pedestrians (Crossing Leg)				
	EB	WB	NB	SB	Total	EB	WB	NB	SB	Total	East	West	North	South	Total
7:00 AM	8	2	0	1	11	0	0	1	0	1	3	2	1	0	6
7:15 AM	2	4	2	0	8	1	1	1	0	3	1	3	2	2	8
7:30 AM	8	5	1	1	15	1	0	0	1	2	2	1	1	0	4
7:45 AM	4	6	1	0	11	1	2	0	3	6	1	1	1	3	6
8:00 AM	5	8	5	4	22	2	2	7	1	12	0	2	0	0	2
8:15 AM	8	7	2	1	18	2	1	5	0	8	0	1	1	0	2
8:30 AM	8	9	3	4	24	1	1	0	0	2	0	0	0	1	1
8:45 AM	7	7	5	1	20	1	1	2	0	4	0	1	0	3	4
Count Total	50	48	19	12	129	9	8	16	5	38	7	11	6	9	33
Peak Hour	25	26	9	6	66	6	5	12	5	28	3	5	3	3	14

Two-Hour Count Summaries - Heavy Vehicles																		
Interval Start	W Julian St				W Julian St				N Autumn St				N Autumn St				15-min Total	Rolling One Hour
	Eastbound				Westbound				Northbound				Southbound					
	UT	LT	TH	RT	UT	LT	TH	RT	UT	LT	TH	RT	UT	LT	TH	RT		
7:00 AM	0	0	8	0	0	0	1	1	0	0	0	0	0	0	1	0	11	0
7:15 AM	0	0	2	0	0	0	4	0	0	1	0	1	0	0	0	0	8	0
7:30 AM	0	0	8	0	0	1	3	1	0	0	0	1	0	0	1	0	15	0
7:45 AM	0	0	4	0	0	1	3	2	0	1	0	0	0	0	0	0	11	45
8:00 AM	0	1	3	1	0	0	6	2	0	3	0	2	0	0	2	2	22	56
8:15 AM	0	0	8	0	0	0	7	0	0	1	1	0	0	0	0	1	18	66
8:30 AM	0	0	8	0	0	0	8	1	0	1	1	1	0	0	0	4	24	75
8:45 AM	0	1	6	0	0	0	7	0	0	5	0	0	0	0	1	0	20	84
Count Total	0	2	47	1	0	2	39	7	0	12	2	5	0	1	4	7	129	0
Peak Hour	0	1	23	1	0	2	19	5	0	5	1	3	0	0	3	3	66	0

Two-Hour Count Summaries - Bikes																
Interval Start	W Julian St			W Julian St			N Autumn St			N Autumn St			15-min Total	Rolling One Hour		
	Eastbound			Westbound			Northbound			Southbound						
	LT	TH	RT	LT	TH	RT	LT	TH	RT	LT	TH	RT				
7:00 AM	0	0	0	0	0	0	0	1	0	0	0	0	0	0	1	0
7:15 AM	0	1	0	0	1	0	0	1	0	0	0	0	0	0	3	0
7:30 AM	1	0	0	0	0	0	0	0	0	0	0	0	1	0	2	0
7:45 AM	0	1	0	0	2	0	0	0	0	0	0	0	2	1	6	12
8:00 AM	2	0	0	0	2	0	0	7	0	0	1	0	0	0	12	23
8:15 AM	2	0	0	0	1	0	0	5	0	0	0	0	0	0	8	28
8:30 AM	0	1	0	0	1	0	0	0	0	0	0	0	0	0	2	28
8:45 AM	0	1	0	0	1	0	1	1	0	0	0	0	0	0	4	26
Count Total	5	4	0	0	8	0	1	15	0	0	4	1	38	0		
Peak Hour	5	1	0	0	5	0	0	12	0	0	4	1	28	0		

Note: U-Turn volumes for bikes are included in Left-Turn, if any.

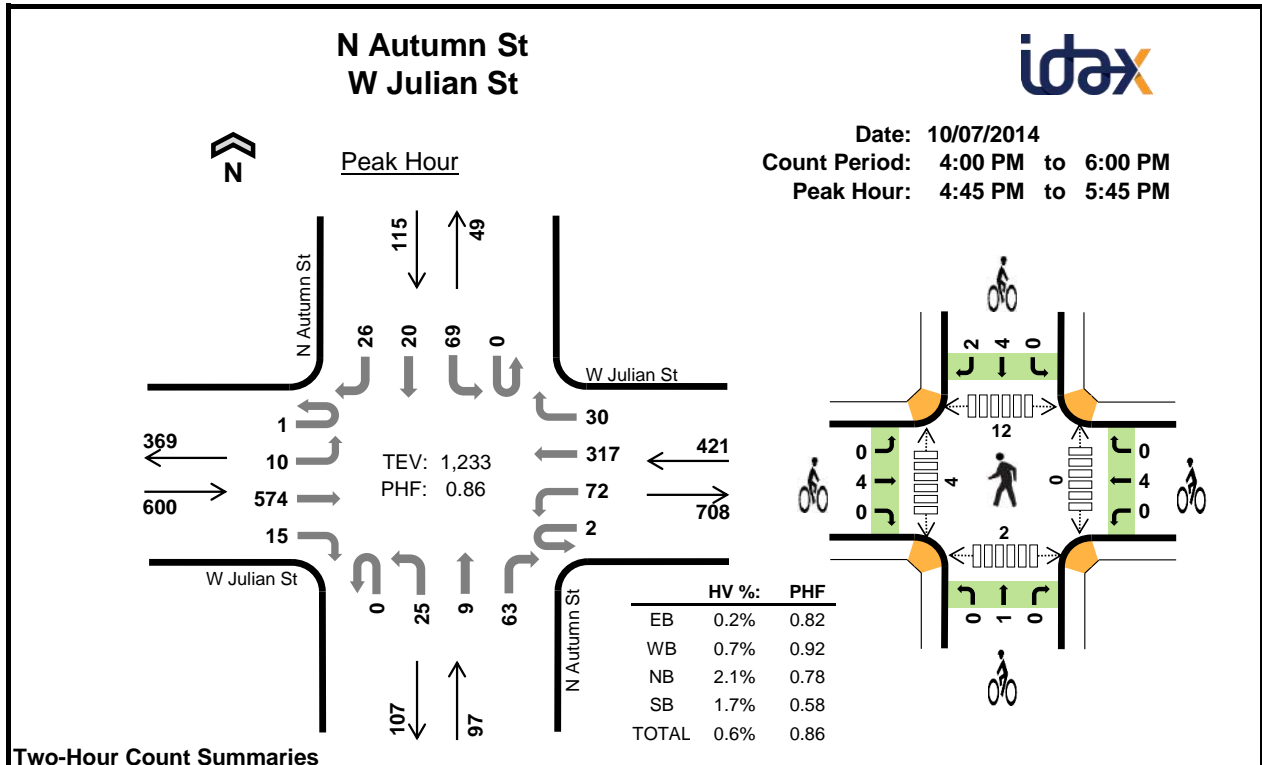

Two-Hour Count Summaries

Interval Start	W Julian St Eastbound				W Julian St Westbound				N Autumn St Northbound				N Autumn St Southbound				15-min Total	Rolling One Hour	
	UT	LT	TH	RT	UT	LT	TH	RT	UT	LT	TH	RT	UT	LT	TH	RT			
4:00 PM	0	2	130	3	2	19	80	5	0	3	2	12	0	13	3	6	280	0	
4:15 PM	0	3	102	2	1	14	85	6	0	1	2	14	0	9	1	2	242	0	
4:30 PM	0	0	135	2	2	18	79	8	0	3	4	9	0	17	1	9	287	0	
4:45 PM	1	2	104	2	1	11	80	7	0	7	5	19	0	20	5	6	270	1,079	
5:00 PM	0	3	173	7	1	18	86	3	0	4	3	10	0	29	7	14	358	1,157	
5:15 PM	0	3	150	5	0	26	78	11	0	5	0	18	0	9	6	2	313	1,228	
5:30 PM	0	2	147	1	0	17	73	9	0	9	1	16	0	11	2	4	292	1,233	
5:45 PM	1	1	115	5	2	12	76	5	0	4	0	16	0	14	1	3	255	1,218	
Count Total	2	16	1056	27	9	135	637	54	0	36	17	114	0	122	26	46	2,297	0	
Peak Hour	All	1	10	574	15	2	72	317	30	0	25	9	63	0	69	20	26	1,233	0
	HV	0	0	1	0	0	0	2	1	0	0	1	1	0	0	1	1	8	0
	HV%	0%	0%	0%	0%	0%	0%	1%	3%	-	0%	11%	2%	-	0%	5%	4%	1%	0

Note: Two-hour count summary volumes include heavy vehicles but exclude bicycles in overall count.

Interval Start	Heavy Vehicle Totals					Bicycles					Pedestrians (Crossing Leg)				
	EB	WB	NB	SB	Total	EB	WB	NB	SB	Total	East	West	North	South	Total
4:00 PM	3	1	2	1	7	1	1	1	0	3	1	3	2	1	7
4:15 PM	1	3	1	0	5	1	0	0	1	2	2	3	0	1	6
4:30 PM	5	2	1	0	8	0	1	0	5	6	1	0	1	0	2
4:45 PM	1	2	2	0	5	0	2	0	1	3	0	1	6	2	9
5:00 PM	0	0	0	0	0	1	1	0	1	3	0	0	2	0	2
5:15 PM	0	1	0	1	2	2	1	0	1	4	0	1	1	0	2
5:30 PM	0	0	0	1	1	1	0	1	3	5	0	2	3	0	5
5:45 PM	0	1	0	0	1	1	2	0	3	6	0	1	1	0	2
Count Total	10	10	6	3	29	7	8	2	15	32	4	11	16	4	35
Peak Hour	1	3	2	2	8	4	4	1	6	15	0	4	12	2	18

Two-Hour Count Summaries - Heavy Vehicles																			
Interval Start	W Julian St				W Julian St				N Autumn St				N Autumn St				15-min Total	Rolling One Hour	
	Eastbound				Westbound				Northbound				Southbound						
	UT	LT	TH	RT	UT	LT	TH	RT	UT	LT	TH	RT	UT	LT	TH	RT			
4:00 PM	0	0	3	0	0	0	1	0	0	1	0	1	0	0	0	0	1	7	0
4:15 PM	0	0	0	1	0	0	3	0	0	0	0	1	0	0	0	0	0	5	0
4:30 PM	0	0	4	1	0	1	1	0	0	0	0	1	0	0	0	0	0	8	0
4:45 PM	0	0	1	0	0	0	2	0	0	0	1	1	0	0	0	0	0	5	25
5:00 PM	0	0	0	0	0	0	0	0	0	0	0	0	0	0	0	0	0	0	18
5:15 PM	0	0	0	0	0	0	0	1	0	0	0	0	0	0	0	1	0	2	15
5:30 PM	0	0	0	0	0	0	0	0	0	0	0	0	0	0	0	0	1	1	8
5:45 PM	0	0	0	0	0	1	0	0	0	0	0	0	0	0	0	0	0	1	4
Count Total	0	0	8	2	0	2	7	1	0	1	1	4	0	0	1	2	29	0	
Peak Hour	0	0	1	0	0	0	2	1	0	0	1	1	0	0	1	1	8	0	

Two-Hour Count Summaries - Bikes																
Interval Start	W Julian St			W Julian St			N Autumn St			N Autumn St			15-min Total	Rolling One Hour		
	Eastbound			Westbound			Northbound			Southbound						
	LT	TH	RT	LT	TH	RT	LT	TH	RT	LT	TH	RT				
4:00 PM	0	1	0	0	1	0	0	1	0	0	0	0	0	0	3	0
4:15 PM	0	1	0	0	0	0	0	0	0	0	0	0	1	0	2	0
4:30 PM	0	0	0	0	1	0	0	0	0	0	0	0	3	2	6	0
4:45 PM	0	0	0	0	2	0	0	0	0	0	0	0	1	0	3	14
5:00 PM	0	1	0	0	1	0	0	0	0	0	0	0	1	0	3	14
5:15 PM	0	2	0	0	1	0	0	0	0	0	0	0	0	1	4	16
5:30 PM	0	1	0	0	0	0	0	1	0	0	2	1	0	1	5	15
5:45 PM	0	1	0	0	2	0	0	0	0	0	3	0	0	0	6	18
Count Total	0	7	0	0	8	0	0	2	0	0	11	4	32	0		
Peak Hour	0	4	0	0	4	0	0	1	0	0	4	2	15	0		

Note: U-Turn volumes for bikes are included in Left-Turn, if any.



Date: Tue, Oct 07, 2014
 Count Period: 7:00 AM to 9:00 AM
 Peak Hour: 7:45 AM to 8:45 AM

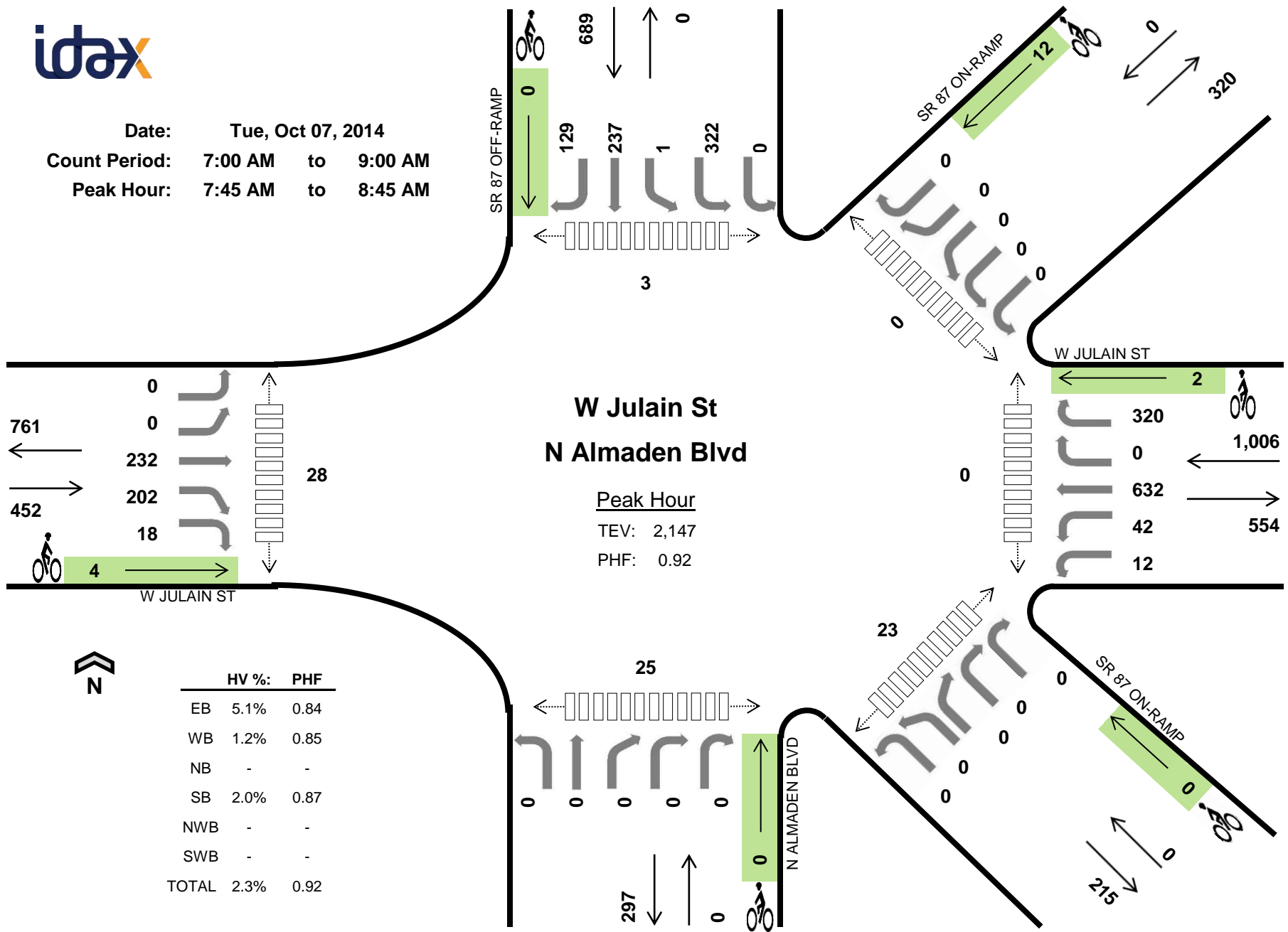

**W Julain St
 N Almaden Blvd**

Peak Hour
 TEV: 2,147
 PHF: 0.92



	HV %:	PHF
EB	5.1%	0.84
WB	1.2%	0.85
NB	-	-
SB	2.0%	0.87
NWB	-	-
SWB	-	-
TOTAL	2.3%	0.92

Two-Hour Count Summaries

Interval Start	W JULAIN ST					W JULAIN ST					N ALMADEN BLVD					SR 87 OFF-RAMP					SR 87 ON-RAMP					15-min Total	Rollin One Hour									
	Eastbound					Westbound					Northbound					Southbound					Northwestbound							Southwestbound								
	LT	BL	TH	BR	RT	HL	LT	TH	RT	HR	LT	TH	BR	RT	HR	HL	LT	BL	TH	RT	HL	BL	BR	RT	HR			HL	LT	BL	BR	HR				
7:00 AM	0	0	25	38	0	1	6	124	0	69	0	0	0	0	0	0	36	0	12	27	0	0	0	0	0	0	0	0	0	0	0	0	0	0	338	
7:15 AM	0	0	26	34	0	0	7	123	0	76	0	0	0	0	0	0	41	0	30	25	0	0	0	0	0	0	0	0	0	0	0	0	0	362		
7:30 AM	0	0	46	46	0	3	8	124	0	82	0	0	0	0	0	0	52	0	32	24	0	0	0	0	0	0	0	0	0	0	0	0	417			
7:45 AM	0	0	60	65	0	3	9	180	0	79	0	0	0	0	0	0	58	1	56	43	0	0	0	0	0	0	0	0	0	0	0	0	554	1,671		
8:00 AM	0	0	68	57	9	4	8	191	0	92	0	0	0	0	0	0	72	0	51	33	0	0	0	0	0	0	0	0	0	0	0	0	585	1,918		
8:15 AM	0	0	50	39	6	2	16	157	0	81	0	0	0	0	0	0	99	0	53	26	0	0	0	0	0	0	0	0	0	0	0	0	529	2,085		
8:30 AM	0	0	54	41	3	3	9	104	0	68	0	0	0	0	0	0	93	0	77	27	0	0	0	0	0	0	0	0	0	0	0	0	479	2,147		
8:45 AM	0	0	61	39	6	6	7	130	0	99	0	0	0	0	0	0	87	0	58	19	0	0	0	0	0	0	0	0	0	0	0	0	512	2,105		
Count Total	0	0	390	359	24	22	70	1,133	0	646	0	0	0	0	0	0	538	1	369	224	0	0	0	0	0	0	0	0	0	0	0	0	3776			
Peak Hr	0	0	232	202	18	12	42	632	0	320	0	0	0	0	0	0	42	322	1	237	129	0	0	0	0	0	0	0	0	0	0	0	2147			

Note: Two-hour count summary volumes include heavy vehicles but excludes bicycles in overall count.

Interval Start	Heavy Vehicle Totals							Bicycles							Pedestrians (Crossing Leg)						0	
	EB	WB	NB	SB	NWB	SWB	Total	EB	WB	NB	SB	NWB	SWB	Total	East	West	North	South	NE	SE		
7:00 AM	6	3	0	2	0	0	11	0	1	0	0	0	0	1	0	3	0	0	0	0	0	3
7:15 AM	4	7	0	3	0	0	14	3	0	0	0	0	0	3	0	3	0	1	0	1	0	5
7:30 AM	9	3	0	3	0	0	15	1	0	0	0	0	0	1	0	0	0	1	0	0	0	1
7:45 AM	5	3	0	4	0	0	12	2	0	0	0	0	0	2	0	2	3	3	0	1	0	9
8:00 AM	3	3	0	4	0	0	10	0	0	0	0	0	0	0	0	5	0	2	0	2	0	9
8:15 AM	8	2	0	4	0	0	14	0	1	0	0	0	0	1	0	0	0	4	0	4	0	8
8:30 AM	7	4	0	2	0	0	13	2	1	0	0	0	0	3	0	21	0	16	0	16	0	53
8:45 AM	3	9	0	3	0	0	15	2	0	0	0	0	0	2	0	4	0	6	0	6	0	16
Count Total	45	34	0	25	0	0	104	10	3	0	0	0	0	13	0	38	3	33	0	134	0	208
Peak Hr	23	12	0	14	0	0	49	4	2	0	0	0	0	6	0	28	3	25	0	23	0	79

INTERSECTION TURNING MOVEMENT COUNT SUMMARY

CLIENT: KITTELSON & ASSOCIATES, INC
 PROJECT: 2014 SCVTA CMP MONITORING
 DATE: TUESDAY SEPTEMBER 23, 2014
 PERIOD: 4:00 PM TO 6:00 PM
 INTERSECTION: N/S SB HWY-87 RAMPS
 E/W JULIAN STREET (WEST)
 CITY: SAN JOSE

VEHICLES													
15 MIN COUNTS 4:00 PM TO 6:00 PM													
PERIOD	1 SBRT	2 SBTH	3 SBLT	4 WBRT	5 WBTH	6 WBLT	7 NBRT	8 NBTH	9 NBLT	10 EBRT	11 EBTH	12 EBLT	TOTAL
400-415	14	31	35	204	83	26	0	0	0	4	189	0	586
415-430	15	28	33	202	112	26	0	0	0	5	146	0	582
430-445	21	31	31	183	100	33	0	0	0	9	196	0	619
445-500	21	33	22	215	85	41	0	0	0	9	229	0	670
500-515	25	20	28	200	105	50	0	0	0	11	262	0	716
515-530	23	16	38	349	124	61	0	0	0	10	268	0	904
530-545	19	19	39	216	104	58	0	0	0	10	211	0	691
545-600	37	15	32	202	111	38	0	0	0	12	169	0	656
HOUR TOTALS													
TIME	1 SBRT	2 SBTH	3 SBLT	4 WBRT	5 WBTH	6 WBLT	7 NBRT	8 NBTH	9 NBLT	10 EBRT	11 EBTH	12 EBLT	TOTAL
400-500	71	123	121	804	380	126	0	0	0	27	760	0	2412
415-515	82	112	114	800	402	150	0	0	0	34	833	0	2527
430-530	90	100	119	947	414	185	0	0	0	39	955	0	2849
445-545	88	88	127	980	418	210	0	0	0	40	970	0	2921
500-600	104	70	137	967	444	207	0	0	0	43	910	0	2882

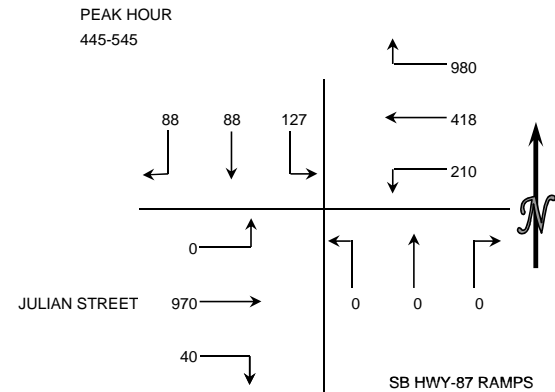

BICYCLES													
15 MIN COUNTS 4:00 PM TO 6:00 PM													
PERIOD	1 SBRT	2 SBTH	3 SBLT	4 WBRT	5 WBTH	6 WBLT	7 NBRT	8 NBTH	9 NBLT	10 EBRT	11 EBTH	12 EBLT	TOTAL
400-415	0	0	0	0	2	0	0	0	0	0	0	0	2
415-430	0	0	0	0	0	0	0	0	0	0	0	0	0
430-445	0	0	0	0	0	0	0	0	0	0	2	0	2
445-500	0	0	0	0	1	0	0	0	0	0	1	0	2
500-515	0	0	0	0	0	0	0	0	0	0	0	0	0
515-530	0	0	0	0	1	0	0	0	0	0	0	0	1
530-545	0	0	0	0	0	0	0	0	0	0	0	0	0
545-600	0	0	0	0	0	0	0	0	0	0	0	0	0
HOUR TOTALS													
TIME	1 SBRT	2 SBTH	3 SBLT	4 WBRT	5 WBTH	6 WBLT	7 NBRT	8 NBTH	9 NBLT	10 EBRT	11 EBTH	12 EBLT	TOTAL
400-500	0	0	0	0	3	0	0	0	0	0	3	0	6
415-515	0	0	0	0	1	0	0	0	0	0	3	0	4
430-530	0	0	0	0	2	0	0	0	0	0	3	0	5
445-545	0	0	0	0	2	0	0	0	0	0	1	0	3
500-600	0	0	0	0	1	0	0	0	0	0	0	0	1

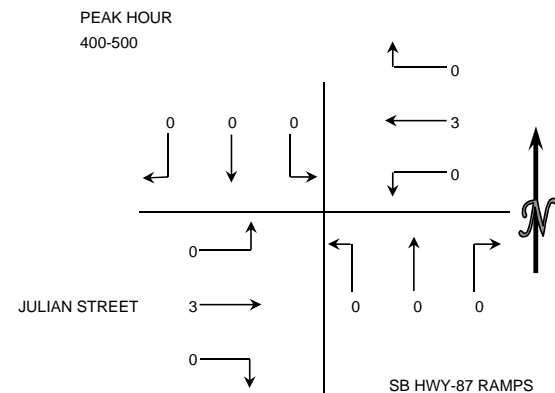



Date: Tue, Oct 07, 2014
 Count Period: 7:00 AM to 9:15 AM
 Peak Hour: 7:45 AM to 8:45 AM



	HV %:	PHF
EB	3.8%	0.88
WB	2.1%	0.92
NB	1.8%	0.89
SB	-	-
NEB	0.9%	0.85
TOTAL	2.0%	0.96

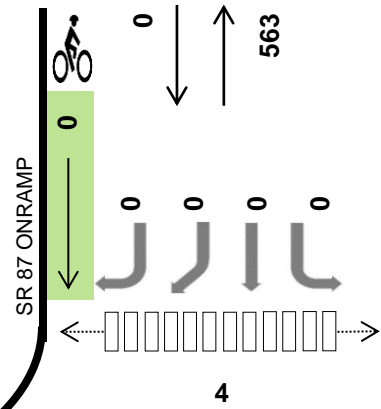

**W JULIAN ST
 NOTRE DAME AVE**

Peak Hour
 TEV: 2,613
 PHF: 0.96

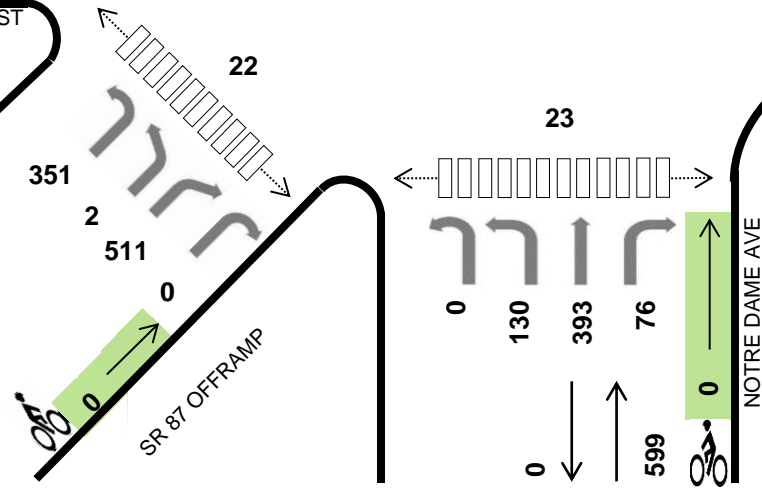
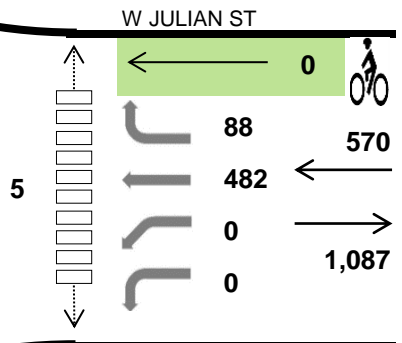
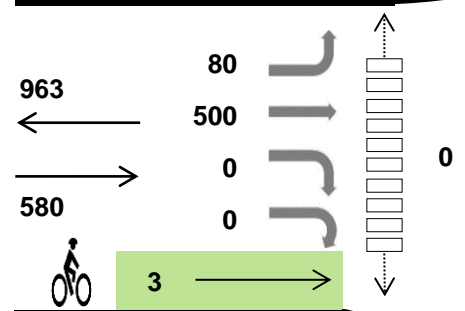

Six-Hour Count Summaries

Interval Start	W JULIAN ST Eastbound				W JULIAN ST Westbound				NOTRE DAME AVE Northbound				SR 87 ONRAMP Southbound				SR 87 OFFRAMP Northeastbound				15-min Total	Rolling One Hour
	LT	TH	RT	HR	LT	BL	TH	RT	HL	LT	TH	RT	LT	TH	BR	RT	HL	BL	BR	HR		
7:00 AM	15	51	0	0	0	0	103	20	0	18	59	10	0	0	0	0	77	0	54	0	407	
7:15 AM	13	55	0	0	0	0	113	13	0	27	93	13	0	0	0	0	82	0	69	0	478	
7:30 AM	13	72	0	0	0	0	108	24	0	16	104	19	0	0	0	0	77	0	81	0	514	
7:45 AM	26	108	0	0	0	0	132	23	0	28	104	14	0	0	0	0	106	1	122	0	664	2,063
8:00 AM	17	109	0	0	0	0	129	20	0	37	96	19	0	0	0	0	108	1	144	0	680	2,336
8:15 AM	17	138	0	0	0	0	108	25	0	40	109	19	0	0	0	0	87	0	126	0	669	2,527
8:30 AM	20	145	0	0	0	0	113	20	0	25	84	24	0	0	0	0	50	0	119	0	600	2,613
8:45 AM	21	128	0	0	0	0	113	30	0	31	116	44	0	0	0	0	45	0	122	0	650	2,599
9:00 AM	0	0	0	0	0	0	0	1	0	0	0	0	0	0	0	0	0	0	0	0	1	1,920
9:15 AM	0	0	0	0	0	0	0	0	0	0	0	0	0	0	0	0	0	0	0	0	0	1,251
9:30 AM	0	0	0	0	0	0	0	0	0	0	0	0	0	0	0	0	0	0	0	0	0	651
9:45 AM	0	0	0	0	0	0	0	0	0	0	0	0	0	0	0	0	0	0	0	0	0	1
10:00 AM	0	0	0	0	0	0	0	0	0	0	0	0	0	0	0	0	0	0	0	0	0	0
10:15 AM	0	0	0	0	0	0	0	0	0	0	0	0	0	0	0	0	0	0	0	0	0	0
10:30 AM	0	0	0	0	0	0	0	0	0	0	0	0	0	0	0	0	0	0	0	0	0	0
10:45 AM	0	0	0	0	0	0	0	0	0	0	0	0	0	0	0	0	0	0	0	0	0	0
11:00 AM	0	0	0	0	0	0	0	0	0	0	0	0	0	0	0	0	0	0	0	0	0	0
11:15 AM	0	0	0	0	0	0	0	0	0	0	0	0	0	0	0	0	0	0	0	0	0	0
11:30 AM	0	0	0	0	0	0	0	0	0	0	0	0	0	0	0	0	0	0	0	0	0	0
11:45 AM	0	0	0	0	0	0	0	0	0	0	0	0	0	0	0	0	0	0	0	0	0	0
12:00 PM	0	0	0	0	0	0	0	0	0	0	0	0	0	0	0	0	0	0	0	0	0	0
12:15 PM	0	0	0	0	0	0	0	0	0	0	0	0	0	0	0	0	0	0	0	0	0	0
12:30 PM	0	0	0	0	0	0	0	0	0	0	0	0	0	0	0	0	0	0	0	0	0	0
12:45 PM	0	0	0	0	0	0	0	0	0	0	0	0	0	0	0	0	0	0	0	0	0	0
Count Total	142	806	0	0	0	0	919	176	0	222	765	162	0	0	0	0	632	2	837	0	4,663	
Peak Hr	80	500	0	0	0	0	482	88	0	130	393	76	0	0	0	0	351	2	511	0	2,613	

Note: Six-hour count summary volumes include heavy vehicles but excludes bicycles in overall count.

Interval Start	Heavy Vehicle Totals						Bicycles						Pedestrians (Crossing Leg)								
	EB	WB	NB	SB	NEB	Total	EB	WB	NB	SB	NEB	Total	East	West	North	South	SW	Total			
7:00 AM	4	3	4	0	0	11	1	0	0	0	0	1	0	0	0	0	0	0	0	0	0
7:15 AM	3	4	2	0	3	12	2	0	0	0	0	1	3	2	0	0	2	1	1	5	5
7:30 AM	3	4	0	0	1	8	1	0	0	0	0	1	1	0	0	1	2	2	2	5	5
7:45 AM	3	1	0	0	3	7	2	0	0	0	0	2	2	2	0	3	4	3	12	12	12
8:00 AM	3	3	2	0	2	10	0	0	0	0	0	0	0	0	0	1	0	1	2	2	2
8:15 AM	11	3	5	0	1	20	0	0	0	0	0	0	0	3	0	0	5	4	12	12	12
8:30 AM	5	5	4	0	2	16	1	0	0	0	0	1	1	0	0	0	14	14	28	28	28
8:45 AM	4	0	3	0	4	11	2	0	0	0	0	2	2	2	0	0	6	6	14	14	14
9:00 AM	0	0	0	0	0	0	0	0	0	0	0	0	0	0	0	0	0	0	0	0	0
9:15 AM	0	0	0	0	0	0	0	0	0	0	0	0	0	0	0	0	0	0	0	0	0
9:30 AM	0	0	0	0	0	0	0	0	0	0	0	0	0	0	0	0	0	0	0	0	0
9:45 AM	0	0	0	0	0	0	0	0	0	0	0	0	0	0	0	0	0	0	0	0	0
10:00 AM	0	0	0	0	0	0	0	0	0	0	0	0	0	0	0	0	0	0	0	0	0
10:15 AM	0	0	0	0	0	0	0	0	0	0	0	0	0	0	0	0	0	0	0	0	0
10:30 AM	0	0	0	0	0	0	0	0	0	0	0	0	0	0	0	0	0	0	0	0	0
10:45 AM	0	0	0	0	0	0	0	0	0	0	0	0	0	0	0	0	0	0	0	0	0
11:00 AM	0	0	0	0	0	0	0	0	0	0	0	0	0	0	0	0	0	0	0	0	0
11:15 AM	0	0	0	0	0	0	0	0	0	0	0	0	0	0	0	0	0	0	0	0	0
11:30 AM	0	0	0	0	0	0	0	0	0	0	0	0	0	0	0	0	0	0	0	0	0
8:45 PM	0	0	0	0	0	0	0	0	0	0	0	0	0	0	0	0	0	0	0	0	0
12:00 PM	0	0	0	0	0	0	0	0	0	0	0	0	0	0	0	0	0	0	0	0	0
12:15 PM	0	0	0	0	0	0	0	0	0	0	0	0	0	0	0	0	0	0	0	0	0
12:30 PM	0	0	0	0	0	0	0	0	0	0	0	0	0	0	0	0	0	0	0	0	0
9:45 PM	0	0	0	0	0	0	0	0	0	0	0	0	0	0	0	0	0	0	0	0	0
Count Total	36	23	20	0	16	95	9	0	0	0	1	10	9	0	5	33	31	78	78	78	78
Peak Hr	22	12	11	0	8	53	3	0	0	0	0	3	5	0	4	23	22	54	54	54	54

INTERSECTION TURNING MOVEMENT COUNT SUMMARY

CLIENT: KITTELSON & ASSOCIATES, INC
 PROJECT: 2014 SCVTA CMP MONITORING
 DATE: TUESDAY SEPTEMBER 23, 2014
 PERIOD: 4:00 PM TO 6:00 PM
 INTERSECTION: N/S NB HWY-87 RAMPS
 E/W JULIAN STREET (EAST)
 CITY: SAN JOSE

VEHICLES																
15 MIN COUNTS 4:00 PM TO 6:00 PM																
PERIOD	1 SBRT	2 SBTH	3 SBLT	4 WBRT	5 WBTH	6 WBLT	7A NBRT	8A NBTH	9A NBLT	7B NBRT	8B NBTH	9B NBLT	10 EBRT	11 EBTH	12 EBLT	TOTAL
400-415	0	0	0	24	149	0	17	54	76	77	1	60	0	80	18	556
415-430	0	0	0	26	214	0	13	42	71	74	0	47	0	75	17	579
430-445	0	0	0	33	209	0	6	53	102	74	0	35	0	65	20	597
445-500	0	0	0	34	243	0	9	76	107	83	0	59	0	91	25	727
500-515	0	0	0	40	258	0	11	88	138	73	0	56	0	82	40	786
515-530	0	0	0	37	290	0	18	85	100	84	0	44	0	103	26	787
530-545	0	0	0	30	257	0	13	81	99	84	0	46	0	107	12	729
545-600	0	0	0	25	186	0	14	55	65	97	0	42	0	90	14	588
HOOR TOTALS																
TIME	1 SBRT	2 SBTH	3 SBLT	4 WBRT	5 WBTH	6 WBLT	7A NBRT	8A NBTH	9A NBLT	7B NBRT	8B NBTH	9B NBLT	10 EBRT	11 EBTH	12 EBLT	TOTAL
400-500	0	0	0	117	815	0	45	225	356	308	1	201	0	311	80	2459
415-515	0	0	0	133	924	0	39	259	418	304	0	197	0	313	102	2689
430-530	0	0	0	144	1000	0	44	302	447	314	0	194	0	341	111	2897
445-545	0	0	0	141	1048	0	51	330	444	324	0	205	0	383	103	3029
500-600	0	0	0	132	991	0	56	309	402	338	0	188	0	382	92	2890

PEAK HOUR
445-545



BICYCLES																
15 MIN COUNTS 4:00 PM TO 6:00 PM																
PERIOD	1 SBRT	2 SBTH	3 SBLT	4 WBRT	5 WBTH	6 WBLT	7A NBRT	8A NBTH	9A NBLT	7B NBRT	8B NBTH	9B NBLT	10 EBRT	11 EBTH	12 EBLT	TOTAL
400-415	0	0	0	0	2	0	0	1	0	0	0	0	0	0	0	3
415-430	0	0	0	0	0	0	0	0	0	0	0	0	0	0	0	0
430-445	0	0	0	0	0	0	0	0	0	0	0	0	0	2	0	2
445-500	0	0	0	0	1	0	0	0	0	0	0	0	0	1	0	2
500-515	0	0	0	0	0	0	0	0	0	0	0	0	0	0	0	0
515-530	0	0	0	0	1	0	0	0	0	0	0	0	0	0	0	1
530-545	0	0	0	0	0	0	0	0	0	0	0	0	0	0	0	0
545-600	0	0	0	0	0	0	0	0	0	0	0	0	0	0	0	0
HOOR TOTALS																
TIME	1 SBRT	2 SBTH	3 SBLT	4 WBRT	5 WBTH	6 WBLT	7A NBRT	8A NBTH	9A NBLT	7B NBRT	8B NBTH	9B NBLT	10 EBRT	11 EBTH	12 EBLT	TOTAL
400-500	0	0	0	0	3	0	0	1	0	0	0	0	0	3	0	7
415-515	0	0	0	0	1	0	0	0	0	0	0	0	0	3	0	4
430-530	0	0	0	0	2	0	0	0	0	0	0	0	0	3	0	5
445-545	0	0	0	0	2	0	0	0	0	0	0	0	0	1	0	3
500-600	0	0	0	0	1	0	0	0	0	0	0	0	0	0	0	1

PEAK HOUR
400-500



The Alameda W Julian St



Date: 10/07/2014
Count Period: 7:00 AM to 9:00 AM
Peak Hour: 7:45 AM to 8:45 AM

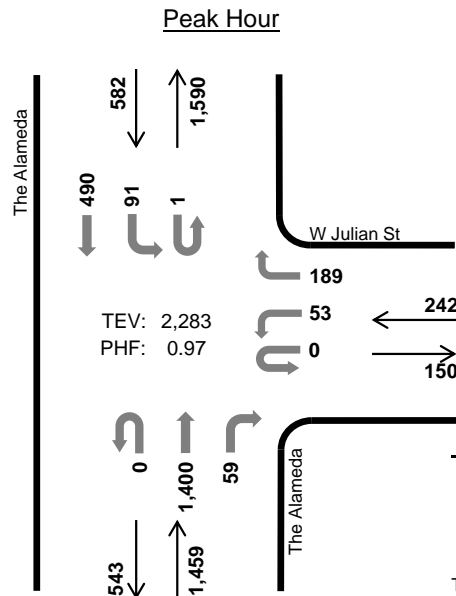

	HV %:	PHF
EB	-	-
WB	0.4%	0.86
NB	2.3%	0.98
SB	4.5%	0.93
TOTAL	2.6%	0.97

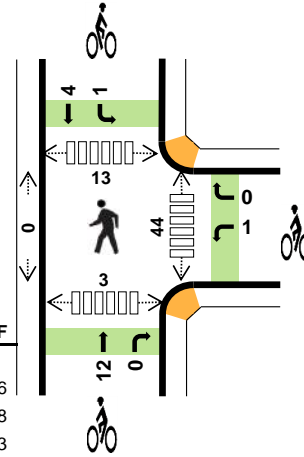

Two-Hour Count Summaries

Interval Start	0				W Julian St				The Alameda				The Alameda				15-min Total	Rolling One Hour	
	Eastbound				Westbound				Northbound				Southbound						
	UT	LT	TH	RT	UT	LT	TH	RT	UT	LT	TH	RT	UT	LT	TH	RT			
7:00 AM	0	0	0	0	0	4	0	38	0	0	155	6	0	11	63	0	277	0	
7:15 AM	0	0	0	0	0	15	0	60	0	0	254	7	0	19	93	0	448	0	
7:30 AM	0	0	0	0	0	9	0	52	0	0	296	8	0	29	129	0	523	0	
7:45 AM	0	0	0	0	0	18	0	48	0	0	360	12	0	22	130	0	590	1,838	
8:00 AM	0	0	0	0	0	13	0	57	0	0	355	14	1	20	112	0	572	2,133	
8:15 AM	0	0	0	0	0	9	0	50	0	0	354	15	0	23	133	0	584	2,269	
8:30 AM	0	0	0	0	0	13	0	34	0	0	331	18	0	26	115	0	537	2,283	
8:45 AM	0	0	0	0	0	15	0	43	0	0	269	21	1	28	105	0	482	2,175	
Count Total	0	0	0	0	0	96	0	382	0	0	2374	101	2	178	880	0	4,013	0	
Peak Hour	All	0	0	0	0	0	53	0	189	0	0	1400	59	1	91	490	0	2,283	0
	HV	0	0	0	0	0	0	0	1	0	0	33	0	0	2	24	0	60	0
	HV%	-	-	-	-	-	0%	-	1%	-	-	2%	0%	0%	2%	5%	-	3%	0

Note: Two-hour count summary volumes include heavy vehicles but exclude bicycles in overall count.

Interval Start	Heavy Vehicle Totals					Bicycles					Pedestrians (Crossing Leg)				
	EB	WB	NB	SB	Total	EB	WB	NB	SB	Total	East	West	North	South	Total
7:00 AM	0	1	5	5	11	0	0	1	0	1	8	0	3	0	11
7:15 AM	0	0	7	7	14	0	0	4	0	4	14	0	4	0	18
7:30 AM	0	4	4	7	15	0	0	3	3	6	23	0	4	0	27
7:45 AM	0	1	11	9	21	0	1	0	5	6	21	0	4	2	27
8:00 AM	0	0	6	4	10	0	0	3	0	3	11	0	3	0	14
8:15 AM	0	0	6	6	12	0	0	2	0	2	6	0	5	0	11
8:30 AM	0	0	10	7	17	0	0	7	0	7	6	0	1	1	8
8:45 AM	0	2	7	3	12	0	1	4	2	7	4	0	4	1	9
Count Total	0	8	56	48	112	0	2	24	10	36	93	0	28	4	125
Peak Hr	0	1	33	26	60	0	1	12	5	18	44	0	13	3	60

Two-Hour Count Summaries - Heavy Vehicles																		
Interval Start	0				W Julian St				The Alameda				The Alameda				15-min Total	Rolling One Hour
	Eastbound				Westbound				Northbound				Southbound					
	UT	LT	TH	RT	UT	LT	TH	RT	UT	LT	TH	RT	UT	LT	TH	RT		
7:00 AM	0	0	0	0	0	0	0	1	0	0	5	0	0	0	5	0	11	0
7:15 AM	0	0	0	0	0	0	0	0	0	0	7	0	0	2	5	0	14	0
7:30 AM	0	0	0	0	0	1	0	3	0	0	4	0	0	1	6	0	15	0
7:45 AM	0	0	0	0	0	0	0	1	0	0	11	0	0	1	8	0	21	61
8:00 AM	0	0	0	0	0	0	0	0	0	0	6	0	0	0	4	0	10	60
8:15 AM	0	0	0	0	0	0	0	0	0	0	6	0	0	0	6	0	12	58
8:30 AM	0	0	0	0	0	0	0	0	0	0	10	0	0	1	6	0	17	60
8:45 AM	0	0	0	0	0	0	0	2	0	0	7	0	0	1	2	0	12	51
Count Total	0	0	0	0	0	1	0	7	0	0	56	0	0	6	42	0	112	0
Peak Hour	0	0	0	0	0	0	0	1	0	0	33	0	0	2	24	0	60	0
Two-Hour Count Summaries - Bikes																		
Interval Start	0			W Julian St			The Alameda			The Alameda			15-min Total	Rolling One Hour				
	Eastbound			Westbound			Northbound			Southbound								
	LT	TH	RT	LT	TH	RT	LT	TH	RT	LT	TH	RT						
7:00 AM	0	0	0	0	0	0	0	1	0	0	0	0	1	0				
7:15 AM	0	0	0	0	0	0	0	4	0	0	0	0	4	0				
7:30 AM	0	0	0	0	0	0	0	3	0	0	3	0	6	0				
7:45 AM	0	0	0	1	0	0	0	0	0	1	4	0	6	17				
8:00 AM	0	0	0	0	0	0	0	3	0	0	0	0	3	19				
8:15 AM	0	0	0	0	0	0	0	2	0	0	0	0	2	17				
8:30 AM	0	0	0	0	0	0	0	7	0	0	0	0	7	18				
8:45 AM	0	0	0	1	0	0	0	4	0	0	2	0	7	19				
Count Total	0	0	0	2	0	0	0	24	0	1	9	0	36	0				
Peak Hour	0	0	0	1	0	0	0	12	0	1	4	0	18	0				
<i>Note: U-Turn volumes for bikes are included in Left-Turn, if any.</i>																		

The Alameda W Julian St



Date: 10/07/2014
 Count Period: 4:00 PM to 6:00 PM
 Peak Hour: 5:00 PM to 6:00 PM

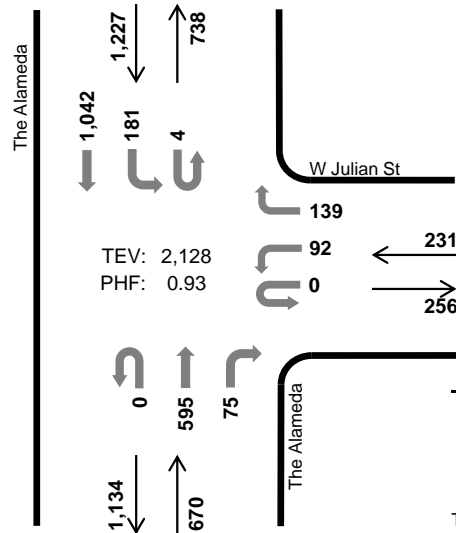

	HV %:	PHF
EB	-	-
WB	1.3%	0.85
NB	1.5%	0.86
SB	1.1%	0.92
TOTAL	1.3%	0.93

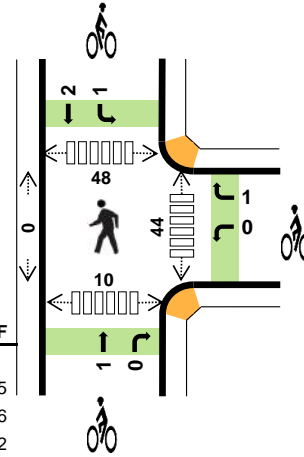

Two-Hour Count Summaries

Interval Start	0				W Julian St				The Alameda				The Alameda				15-min Total	Rolling One Hour	
	Eastbound				Westbound				Northbound				Southbound						
	UT	LT	TH	RT	UT	LT	TH	RT	UT	LT	TH	RT	UT	LT	TH	RT			
4:00 PM	0	0	0	0	0	16	0	27	0	0	130	15	0	30	200	0	418	0	
4:15 PM	0	0	0	0	0	20	0	28	0	0	136	22	0	26	233	0	465	0	
4:30 PM	0	0	0	0	0	23	0	33	0	0	129	13	1	41	201	0	441	0	
4:45 PM	0	0	0	0	0	11	0	32	0	0	152	25	0	36	236	0	492	1,816	
5:00 PM	0	0	0	0	0	34	0	34	0	0	134	19	1	46	242	0	510	1,908	
5:15 PM	0	0	0	0	0	19	0	40	0	0	178	16	1	52	265	0	571	2,014	
5:30 PM	0	0	0	0	0	19	0	34	0	0	145	24	2	44	240	0	508	2,081	
5:45 PM	0	0	0	0	0	20	0	31	0	0	138	16	0	39	295	0	539	2,128	
Count Total	0	0	0	0	0	162	0	259	0	0	1142	150	5	314	1912	0	3,944	0	
Peak Hour	All	0	0	0	0	0	92	0	139	0	0	595	75	4	181	1042	0	2,128	0
	HV	0	0	0	0	0	0	0	3	0	0	10	0	0	0	14	0	27	0
	HV%	-	-	-	-	-	0%	-	2%	-	-	2%	0%	0%	0%	1%	-	1%	0

Note: Two-hour count summary volumes include heavy vehicles but exclude bicycles in overall count.

Interval Start	Heavy Vehicle Totals					Bicycles					Pedestrians (Crossing Leg)				
	EB	WB	NB	SB	Total	EB	WB	NB	SB	Total	East	West	North	South	Total
4:00 PM	0	1	5	3	9	0	0	0	1	1	6	0	6	3	15
4:15 PM	0	1	7	7	15	0	0	0	0	0	10	0	2	6	18
4:30 PM	0	0	7	6	13	0	2	2	0	4	5	0	5	4	14
4:45 PM	0	0	3	5	8	0	0	0	1	1	8	0	10	2	20
5:00 PM	0	2	4	4	10	0	0	0	1	1	7	0	10	3	20
5:15 PM	0	1	3	3	7	0	0	0	0	0	8	0	8	3	19
5:30 PM	0	0	2	3	5	0	1	1	0	2	14	0	18	3	35
5:45 PM	0	0	1	4	5	0	0	0	2	2	15	0	12	1	28
Count Total	0	5	32	35	72	0	3	3	5	11	73	0	71	25	169
Peak Hr	0	3	10	14	27	0	1	1	3	5	44	0	48	10	102

Two-Hour Count Summaries - Heavy Vehicles																		
Interval Start	0				W Julian St				The Alameda				The Alameda				15-min Total	Rolling One Hour
	Eastbound				Westbound				Northbound				Southbound					
	UT	LT	TH	RT	UT	LT	TH	RT	UT	LT	TH	RT	UT	LT	TH	RT		
4:00 PM	0	0	0	0	0	0	0	1	0	0	5	0	0	0	3	0	9	0
4:15 PM	0	0	0	0	0	0	0	1	0	0	7	0	0	1	6	0	15	0
4:30 PM	0	0	0	0	0	0	0	0	0	0	7	0	0	2	4	0	13	0
4:45 PM	0	0	0	0	0	0	0	0	0	0	3	0	0	0	5	0	8	45
5:00 PM	0	0	0	0	0	0	0	2	0	0	4	0	0	0	4	0	10	46
5:15 PM	0	0	0	0	0	0	0	1	0	0	3	0	0	0	3	0	7	38
5:30 PM	0	0	0	0	0	0	0	0	0	0	2	0	0	0	3	0	5	30
5:45 PM	0	0	0	0	0	0	0	0	0	0	1	0	0	0	4	0	5	27
Count Total	0	0	0	0	0	0	0	5	0	0	32	0	0	3	32	0	72	0
Peak Hour	0	0	0	0	0	0	0	3	0	0	10	0	0	0	14	0	27	0
Two-Hour Count Summaries - Bikes																		
Interval Start	0			W Julian St			The Alameda			The Alameda			15-min Total	Rolling One Hour				
	Eastbound			Westbound			Northbound			Southbound								
	LT	TH	RT	LT	TH	RT	LT	TH	RT	LT	TH	RT						
4:00 PM	0	0	0	0	0	0	0	0	0	0	0	0	1	0	0	1	0	
4:15 PM	0	0	0	0	0	0	0	0	0	0	0	0	0	0	0	0	0	
4:30 PM	0	0	0	2	0	0	0	0	2	0	0	0	0	0	0	4	0	
4:45 PM	0	0	0	0	0	0	0	0	0	0	0	0	1	0	0	1	6	
5:00 PM	0	0	0	0	0	0	0	0	0	0	0	1	0	0	0	1	6	
5:15 PM	0	0	0	0	0	0	0	0	0	0	0	0	0	0	0	0	6	
5:30 PM	0	0	0	0	0	0	1	0	0	1	0	0	0	0	0	2	4	
5:45 PM	0	0	0	0	0	0	0	0	0	0	0	0	2	0	0	2	5	
Count Total	0	0	0	2	0	1	0	0	3	0	0	1	4	0	0	11	0	
Peak Hour	0	0	0	0	0	1	0	0	1	0	0	1	2	0	0	5	0	
<i>Note: U-Turn volumes for bikes are included in Left-Turn, if any.</i>																		

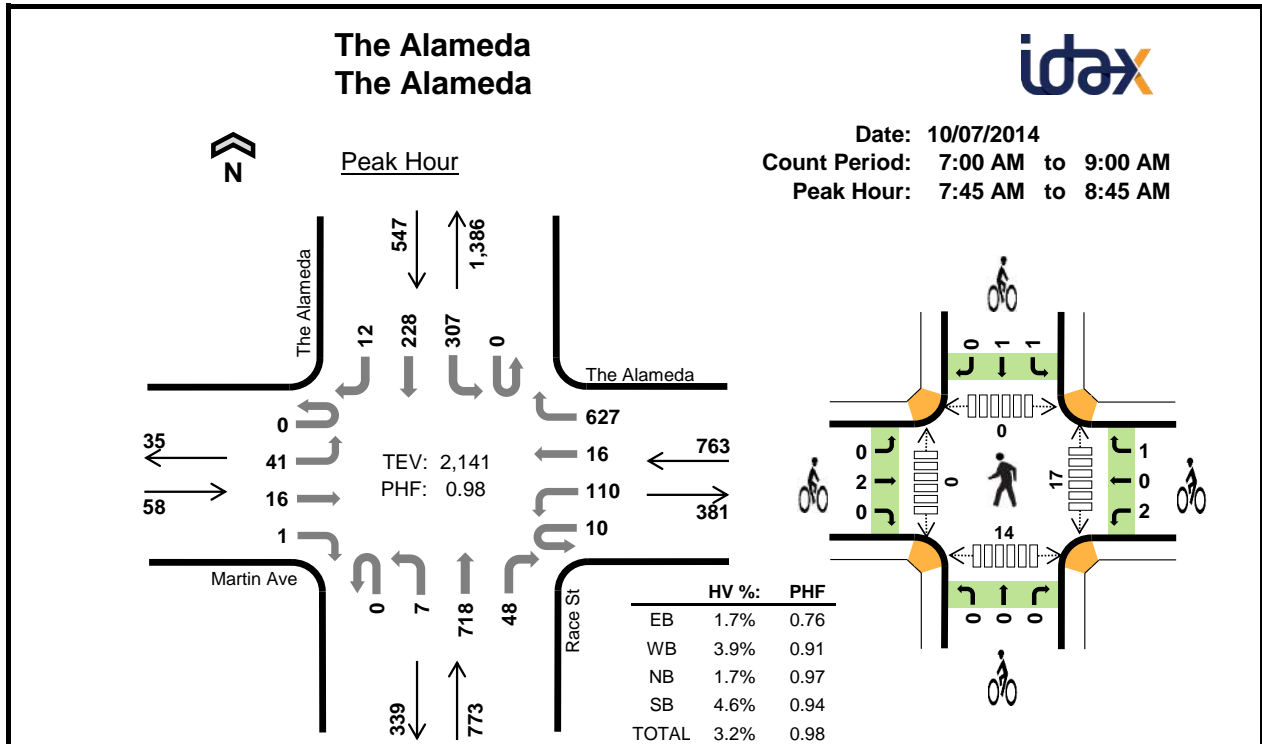

Two-Hour Count Summaries

Interval Start	Martin Ave				The Alameda				Race St				The Alameda				15-min Total	Rolling One Hour	
	Eastbound				Westbound				Northbound				Southbound						
	UT	LT	TH	RT	UT	LT	TH	RT	UT	LT	TH	RT	UT	LT	TH	RT			
7:00 AM	0	3	1	2	0	13	2	78	0	1	81	9	0	43	21	1	255	0	
7:15 AM	0	10	3	0	2	16	6	118	0	0	123	5	0	56	40	2	381	0	
7:30 AM	0	11	2	0	2	15	11	141	0	0	151	11	0	83	42	0	469	0	
7:45 AM	0	8	2	0	2	26	5	158	0	0	186	13	0	77	69	0	546	1,651	
8:00 AM	0	12	6	0	0	26	6	178	0	2	164	12	0	59	64	4	533	1,929	
8:15 AM	0	6	5	0	4	32	2	161	0	4	184	10	0	74	52	5	539	2,087	
8:30 AM	0	15	3	1	4	26	3	130	0	1	184	13	0	97	43	3	523	2,141	
8:45 AM	0	12	3	2	0	22	2	100	0	0	176	12	0	67	42	3	441	2,036	
Count Total	0	77	25	5	14	176	37	1064	0	8	1249	85	0	556	373	18	3,687	0	
Peak Hour	All	0	41	16	1	10	110	16	627	0	7	718	48	0	307	228	12	2,141	0
	HV	0	0	0	1	0	8	0	21	0	0	10	3	0	11	14	0	68	0
	HV%	-	0%	0%	100%	0%	7%	0%	3%	-	0%	1%	6%	-	4%	6%	0%	3%	0

Note: Two-hour count summary volumes include heavy vehicles but exclude bicycles in overall count.

Interval Start	Heavy Vehicle Totals					Bicycles					Pedestrians (Crossing Leg)				
	EB	WB	NB	SB	Total	EB	WB	NB	SB	Total	East	West	North	South	Total
7:00 AM	0	4	3	6	13	0	1	0	0	1	1	2	0	2	5
7:15 AM	0	4	4	5	13	0	0	1	0	1	4	0	0	1	5
7:30 AM	0	5	2	6	13	0	0	1	2	3	2	1	0	3	6
7:45 AM	0	12	4	8	24	0	0	0	1	1	3	0	0	4	7
8:00 AM	0	6	3	5	14	0	0	0	0	0	4	0	0	3	7
8:15 AM	0	5	2	5	12	0	2	0	1	3	5	0	0	4	9
8:30 AM	1	6	4	7	18	2	1	0	0	3	5	0	0	3	8
8:45 AM	0	8	3	3	14	0	0	0	1	1	5	0	0	1	6
Count Total	1	50	25	45	121	2	4	2	5	13	29	3	0	21	53
Peak Hour	1	29	13	25	68	2	3	0	2	7	17	0	0	14	31

Two-Hour Count Summaries - Heavy Vehicles																		
Interval Start	Martin Ave				The Alameda				Race St				The Alameda				15-min Total	Rolling One Hour
	Eastbound				Westbound				Northbound				Southbound					
	UT	LT	TH	RT	UT	LT	TH	RT	UT	LT	TH	RT	UT	LT	TH	RT		
7:00 AM	0	0	0	0	0	2	0	2	0	0	2	1	0	4	2	0	13	0
7:15 AM	0	0	0	0	0	0	0	4	0	0	3	1	0	4	1	0	13	0
7:30 AM	0	0	0	0	0	1	0	4	0	0	1	1	0	3	3	0	13	0
7:45 AM	0	0	0	0	0	3	0	9	0	0	2	2	0	4	4	0	24	63
8:00 AM	0	0	0	0	0	3	0	3	0	0	3	0	0	2	3	0	14	64
8:15 AM	0	0	0	0	0	0	0	5	0	0	2	0	0	3	2	0	12	63
8:30 AM	0	0	0	1	0	2	0	4	0	0	3	1	0	2	5	0	18	68
8:45 AM	0	0	0	0	0	3	0	5	0	0	3	0	0	3	0	0	14	58
Count Total	0	0	0	1	0	14	0	36	0	0	19	6	0	25	20	0	121	0
Peak Hour	0	0	0	1	0	8	0	21	0	0	10	3	0	11	14	0	68	0

Two-Hour Count Summaries - Bikes														
Interval Start	Martin Ave			The Alameda			Race St			The Alameda			15-min Total	Rolling One Hour
	Eastbound			Westbound			Northbound			Southbound				
	LT	TH	RT	LT	TH	RT	LT	TH	RT	LT	TH	RT		
7:00 AM	0	0	0	0	0	1	0	0	0	0	0	0	1	0
7:15 AM	0	0	0	0	0	0	0	1	0	0	0	0	1	0
7:30 AM	0	0	0	0	0	0	0	1	0	2	0	0	3	0
7:45 AM	0	0	0	0	0	0	0	0	0	1	0	0	1	6
8:00 AM	0	0	0	0	0	0	0	0	0	0	0	0	0	5
8:15 AM	0	0	0	2	0	0	0	0	0	0	1	0	3	7
8:30 AM	0	2	0	0	0	1	0	0	0	0	0	0	3	7
8:45 AM	0	0	0	0	0	0	0	0	0	0	1	0	1	7
Count Total	0	2	0	2	0	2	0	2	0	3	2	0	13	0
Peak Hour	0	2	0	2	0	1	0	0	0	1	1	0	7	0

Note: U-Turn volumes for bikes are included in Left-Turn, if any.

INTERSECTION TURNING MOVEMENT COUNT SUMMARY

CLIENT: KITTELSON & ASSOCIATES, INC
 PROJECT: 2014 SCVTA CMP MONITORING
 DATE: TUESDAY SEPTEMBER 30, 2014
 PERIOD: 4:00 PM TO 6:00 PM
 INTERSECTION: N/S THE ALAMEDA (RTE 82)
 E/W RACE STREET
 CITY: SAN JOSE

VEHICLES

15 MIN COUNTS														4:00 PM TO 6:00 PM
PERIOD	1 SBRT	2 SBTH	3 SBLT	4 WBRT	5 WBTH	6 WBLT	7 NBRT	8 NBTH	9 NBLT	10 EBRT	11 EBTH	12 EBLT	TOTAL	
400-415	7	99	143	73	0	36	23	71	4	3	6	5	470	
415-430	9	82	128	68	1	30	26	47	0	1	3	5	400	
430-445	4	80	144	62	3	49	38	70	2	4	6	4	466	
445-500	12	116	139	78	5	36	21	65	2	2	7	6	489	
500-515	2	104	149	89	4	38	24	67	2	0	5	2	486	
515-530	6	101	165	80	9	49	26	77	2	0	4	5	524	
530-545	7	107	184	82	19	47	37	89	2	0	4	3	581	
545-600	7	93	151	72	2	30	24	75	0	0	5	2	461	
HOUR TOTALS														
TIME	1 SBRT	2 SBTH	3 SBLT	4 WBRT	5 WBTH	6 WBLT	7 NBRT	8 NBTH	9 NBLT	10 EBRT	11 EBTH	12 EBLT	TOTAL	
400-500	32	377	554	281	9	151	108	253	8	10	22	20	1825	
415-515	27	382	560	297	13	153	109	249	6	7	21	17	1841	
430-530	24	401	597	309	21	172	109	279	8	6	22	17	1965	
445-545	27	428	637	329	37	170	108	298	8	2	20	16	2080	
500-600	22	405	649	323	34	164	111	308	6	0	18	12	2052	

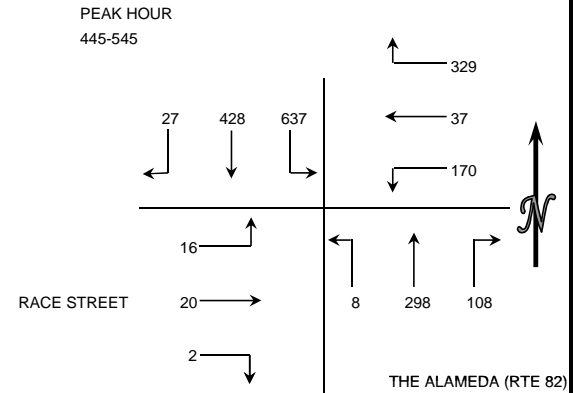

BICYCLES

15 MIN COUNTS														4:00 PM TO 6:00 PM
PERIOD	1 SBRT	2 SBTH	3 SBLT	4 WBRT	5 WBTH	6 WBLT	7 NBRT	8 NBTH	9 NBLT	10 EBRT	11 EBTH	12 EBLT	TOTAL	
400-415	0	1	1	3	0	0	0	0	0	0	0	0	6	
415-430	1	0	3	0	0	0	0	0	0	1	0	0	5	
430-445	0	1	2	0	0	0	0	1	0	0	1	0	5	
445-500	0	1	0	2	0	0	0	0	0	0	0	0	3	
500-515	0	0	2	0	0	1	0	0	0	0	2	0	5	
515-530	0	0	0	3	0	0	0	0	0	0	0	0	3	
530-545	0	0	0	0	0	1	0	0	0	0	0	0	1	
545-600	0	1	0	0	0	0	0	0	0	0	0	0	1	
HOUR TOTALS														
TIME	1 SBRT	2 SBTH	3 SBLT	4 WBRT	5 WBTH	6 WBLT	7 NBRT	8 NBTH	9 NBLT	10 EBRT	11 EBTH	12 EBLT	TOTAL	
400-500	1	3	6	5	0	0	0	1	0	1	1	1	19	
415-515	1	2	7	2	0	1	0	1	0	1	3	0	18	
430-530	0	2	4	5	0	1	0	1	0	0	3	0	16	
445-545	0	1	2	5	0	2	0	0	0	0	2	0	12	
500-600	0	1	2	3	0	2	0	0	0	0	2	0	10	

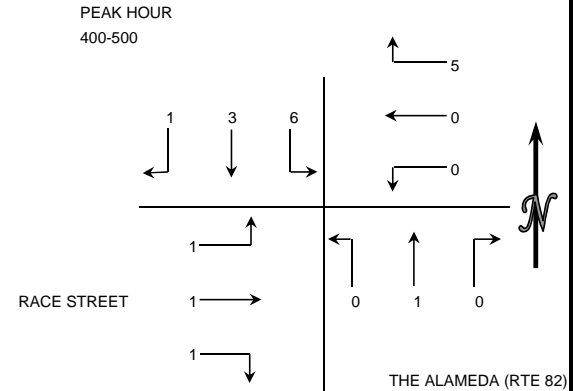

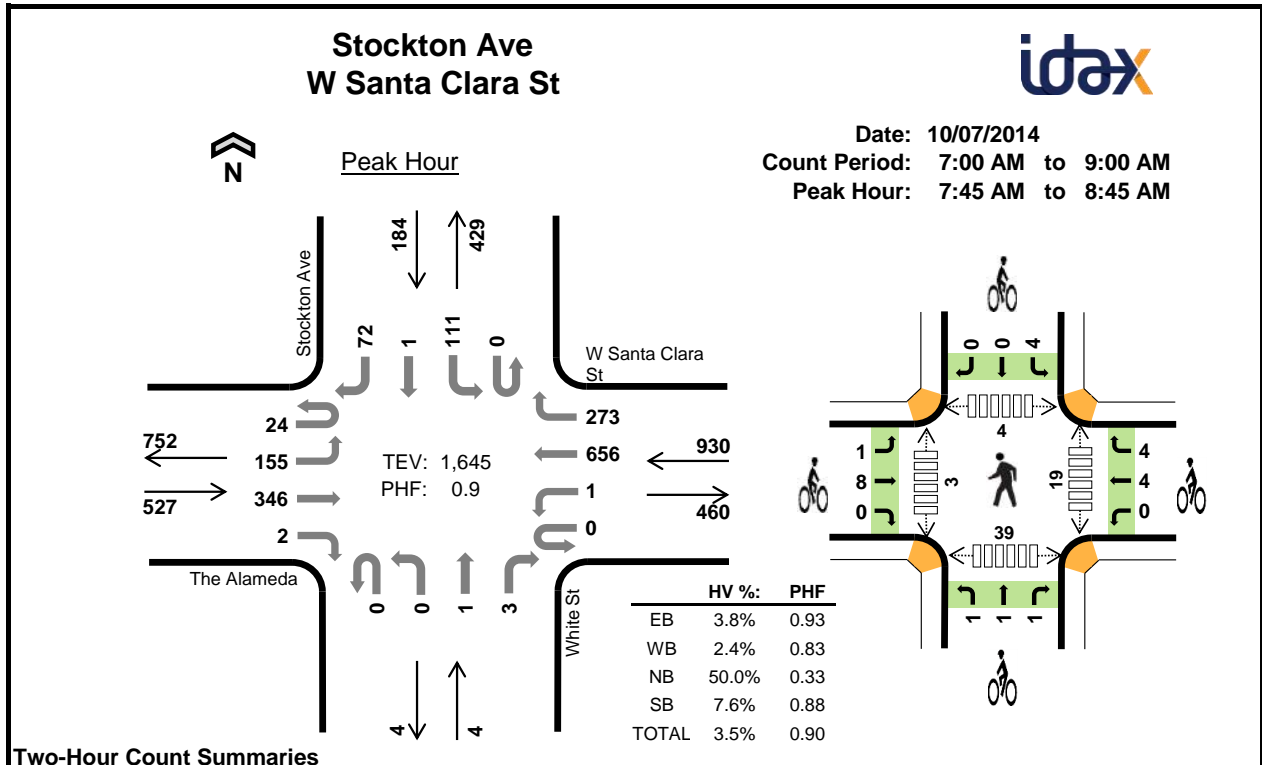

Two-Hour Count Summaries

Interval Start	The Alameda				W Santa Clara St				White St				Stockton Ave				15-min Total	Rolling One Hour	
	Eastbound				Westbound				Northbound				Southbound						
	UT	LT	TH	RT	UT	LT	TH	RT	UT	LT	TH	RT	UT	LT	TH	RT			
7:00 AM	2	27	55	1	0	0	93	33	0	0	1	1	0	11	2	8	234	0	
7:15 AM	2	27	63	3	0	1	136	40	0	0	0	0	0	21	1	10	304	0	
7:30 AM	8	44	97	0	0	0	137	60	0	0	0	0	0	27	0	11	384	0	
7:45 AM	4	43	90	0	0	0	121	63	0	0	0	1	0	31	1	15	369	1,291	
8:00 AM	10	39	78	1	0	0	194	85	0	0	0	0	0	29	0	23	459	1,516	
8:15 AM	6	31	82	1	0	0	188	65	0	0	1	2	0	24	0	19	419	1,631	
8:30 AM	4	42	96	0	0	1	153	60	0	0	0	0	0	27	0	15	398	1,645	
8:45 AM	5	35	82	0	0	0	136	36	0	0	1	1	0	24	0	7	327	1,603	
Count Total	41	288	643	6	0	2	1158	442	0	0	3	5	0	194	4	108	2,894	0	
Peak Hour	All	24	155	346	2	0	1	656	273	0	0	1	3	0	111	1	72	1,645	0
	HV	0	5	15	0	0	0	17	5	0	0	0	2	0	8	0	6	58	0
	HV%	0%	3%	4%	0%	-	0%	3%	2%	-	-	0%	67%	-	7%	0%	8%	4%	0

Note: Two-hour count summary volumes include heavy vehicles but exclude bicycles in overall count.

Interval Start	Heavy Vehicle Totals					Bicycles					Pedestrians (Crossing Leg)				
	EB	WB	NB	SB	Total	EB	WB	NB	SB	Total	East	West	North	South	Total
7:00 AM	5	4	1	0	10	1	3	0	0	4	0	0	2	4	6
7:15 AM	6	4	0	2	12	2	0	0	0	2	2	0	0	11	13
7:30 AM	5	5	0	4	14	6	1	2	2	11	13	0	0	6	19
7:45 AM	7	5	0	2	14	3	4	0	2	9	6	1	1	12	20
8:00 AM	3	6	0	2	11	4	2	2	0	8	5	1	0	8	14
8:15 AM	6	6	2	3	17	1	0	1	1	3	3	1	2	4	10
8:30 AM	4	5	0	7	16	1	2	0	1	4	5	0	1	15	21
8:45 AM	3	7	1	0	11	6	2	0	1	9	8	0	0	2	10
Count Total	39	42	4	20	105	24	14	5	7	50	42	3	6	62	113
Peak Hour	20	22	2	14	58	9	8	3	4	24	19	3	4	39	65

Two-Hour Count Summaries - Heavy Vehicles																		
Interval Start	The Alameda				W Santa Clara St				White St				Stockton Ave				15-min Total	Rolling One Hour
	Eastbound				Westbound				Northbound				Southbound					
	UT	LT	TH	RT	UT	LT	TH	RT	UT	LT	TH	RT	UT	LT	TH	RT		
7:00 AM	0	1	3	1	0	0	4	0	0	0	1	0	0	0	0	0		
7:15 AM	0	0	5	1	0	0	4	0	0	0	0	0	0	1	0	1		
7:30 AM	0	2	3	0	0	0	5	0	0	0	0	0	0	2	0	2		
7:45 AM	0	3	4	0	0	0	5	0	0	0	0	0	0	1	0	1		
8:00 AM	0	1	2	0	0	0	2	4	0	0	0	0	0	1	0	1		
8:15 AM	0	1	5	0	0	0	5	1	0	0	0	2	0	1	0	2		
8:30 AM	0	0	4	0	0	0	5	0	0	0	0	0	0	5	0	2		
8:45 AM	0	0	3	0	0	0	7	0	0	0	1	0	0	0	0	2		
Count Total	0	8	29	2	0	0	37	5	0	0	2	2	0	11	0	9		
Peak Hour	0	5	15	0	0	0	17	5	0	0	0	2	0	8	0	6		

Two-Hour Count Summaries - Bikes																
Interval Start	The Alameda			W Santa Clara St			White St			Stockton Ave			15-min Total	Rolling One Hour		
	Eastbound			Westbound			Northbound			Southbound						
	LT	TH	RT	LT	TH	RT	LT	TH	RT	LT	TH	RT				
7:00 AM	0	1	0	0	1	2	0	0	0	0	0	0				
7:15 AM	0	2	0	0	0	0	0	0	0	0	0	0				
7:30 AM	1	5	0	0	1	0	0	2	0	1	1	0				
7:45 AM	0	3	0	0	3	1	0	0	0	2	0	0				
8:00 AM	1	3	0	0	0	2	1	1	0	0	0	0				
8:15 AM	0	1	0	0	0	0	0	0	1	1	0	0				
8:30 AM	0	1	0	0	1	1	0	0	0	1	0	0				
8:45 AM	0	6	0	0	2	0	0	0	0	1	0	0				
Count Total	2	22	0	0	8	6	1	3	1	6	1	0				
Peak Hour	1	8	0	0	4	4	1	1	1	4	0	0				

Note: U-Turn volumes for bikes are included in Left-Turn, if any.

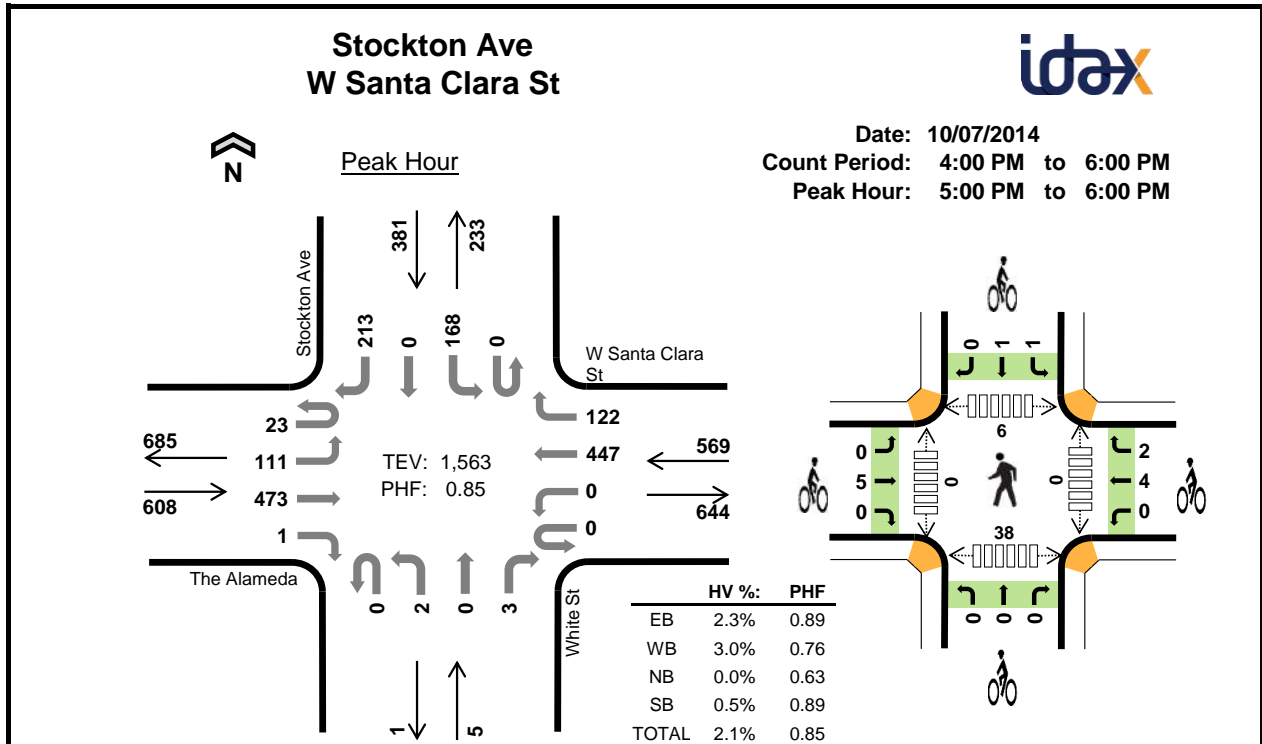

Two-Hour Count Summaries

Interval Start	The Alameda				W Santa Clara St				White St				Stockton Ave				15-min Total	Rolling One Hour	
	Eastbound				Westbound				Northbound				Southbound						
	UT	LT	TH	RT	UT	LT	TH	RT	UT	LT	TH	RT	UT	LT	TH	RT			
4:00 PM	4	17	102	0	0	0	92	25	0	0	0	6	0	37	0	34	317	0	
4:15 PM	3	21	113	0	0	0	93	29	0	0	0	1	0	33	1	41	335	0	
4:30 PM	4	16	105	0	0	0	103	34	0	0	0	0	0	32	1	47	342	0	
4:45 PM	4	25	114	0	0	0	113	29	0	0	0	0	0	39	0	46	370	1,364	
5:00 PM	5	23	93	0	0	0	108	25	0	1	0	1	0	52	0	44	352	1,399	
5:15 PM	3	38	122	1	0	0	147	39	0	1	0	0	0	44	0	63	458	1,522	
5:30 PM	10	27	115	0	0	0	99	28	0	0	0	1	0	41	0	58	379	1,559	
5:45 PM	5	23	143	0	0	0	93	30	0	0	0	1	0	31	0	48	374	1,563	
Count Total	38	190	907	1	0	0	848	239	0	2	0	10	0	309	2	381	2,927	0	
Peak Hour	All	23	111	473	1	0	0	447	122	0	2	0	3	0	168	0	213	1,563	0
	HV	0	2	12	0	0	0	12	5	0	0	0	0	0	2	0	0	33	0
	HV%	0%	2%	3%	0%	-	-	3%	4%	-	0%	-	0%	-	1%	-	0%	2%	0

Note: Two-hour count summary volumes include heavy vehicles but exclude bicycles in overall count.

Interval Start	Heavy Vehicle Totals					Bicycles					Pedestrians (Crossing Leg)				
	EB	WB	NB	SB	Total	EB	WB	NB	SB	Total	East	West	North	South	Total
4:00 PM	1	4	2	1	8	1	4	0	1	6	4	1	0	2	7
4:15 PM	6	6	0	0	12	2	0	0	2	4	2	1	0	9	12
4:30 PM	3	6	0	1	10	2	1	0	1	4	1	0	0	7	8
4:45 PM	6	4	0	0	10	4	3	1	0	8	6	0	1	10	17
5:00 PM	2	7	0	0	9	2	0	0	2	4	0	0	1	9	10
5:15 PM	7	4	0	1	12	1	3	0	0	4	0	0	1	13	14
5:30 PM	2	5	0	0	7	1	2	0	0	3	0	0	1	11	12
5:45 PM	3	1	0	1	5	1	1	0	0	2	0	0	3	5	8
Count Total	30	37	2	4	73	14	14	1	6	35	13	2	7	66	88
Peak Hour	14	17	0	2	33	5	6	0	2	13	0	0	6	38	44

Two-Hour Count Summaries - Heavy Vehicles																		
Interval Start	The Alameda				W Santa Clara St				White St				Stockton Ave				15-min Total	Rolling One Hour
	Eastbound				Westbound				Northbound				Southbound					
	UT	LT	TH	RT	UT	LT	TH	RT	UT	LT	TH	RT	UT	LT	TH	RT		
4:00 PM	0	0	1	0	0	0	3	1	0	0	0	2	0	1	0	0	8	0
4:15 PM	0	1	5	0	0	0	3	3	0	0	0	0	0	0	0	0	12	0
4:30 PM	0	0	3	0	0	0	6	0	0	0	0	0	0	0	0	1	10	0
4:45 PM	0	0	6	0	0	0	2	2	0	0	0	0	0	0	0	0	10	40
5:00 PM	0	0	2	0	0	0	4	3	0	0	0	0	0	0	0	0	9	41
5:15 PM	0	2	5	0	0	0	2	2	0	0	0	0	0	1	0	0	12	41
5:30 PM	0	0	2	0	0	0	5	0	0	0	0	0	0	0	0	0	7	38
5:45 PM	0	0	3	0	0	0	1	0	0	0	0	0	0	1	0	0	5	33
Count Total	0	3	27	0	0	0	26	11	0	0	0	2	0	3	0	1	73	0
Peak Hour	0	2	12	0	0	0	12	5	0	0	0	0	0	2	0	0	33	0

Two-Hour Count Summaries - Bikes														
Interval Start	The Alameda			W Santa Clara St			White St			Stockton Ave			15-min Total	Rolling One Hour
	Eastbound			Westbound			Northbound			Southbound				
	LT	TH	RT	LT	TH	RT	LT	TH	RT	LT	TH	RT		
4:00 PM	0	1	0	0	4	0	0	0	0	1	0	0	6	0
4:15 PM	1	1	0	0	0	0	0	0	0	2	0	0	4	0
4:30 PM	0	2	0	0	1	0	0	0	0	1	0	0	4	0
4:45 PM	0	4	0	0	1	2	0	0	1	0	0	0	8	22
5:00 PM	0	2	0	0	0	0	0	0	0	1	1	0	4	20
5:15 PM	0	1	0	0	3	0	0	0	0	0	0	0	4	20
5:30 PM	0	1	0	0	1	1	0	0	0	0	0	0	3	19
5:45 PM	0	1	0	0	0	1	0	0	0	0	0	0	2	13
Count Total	1	13	0	0	10	4	0	0	1	5	1	0	35	0
Peak Hour	0	5	0	0	4	2	0	0	0	1	1	0	13	0

Note: U-Turn volumes for bikes are included in Left-Turn, if any.

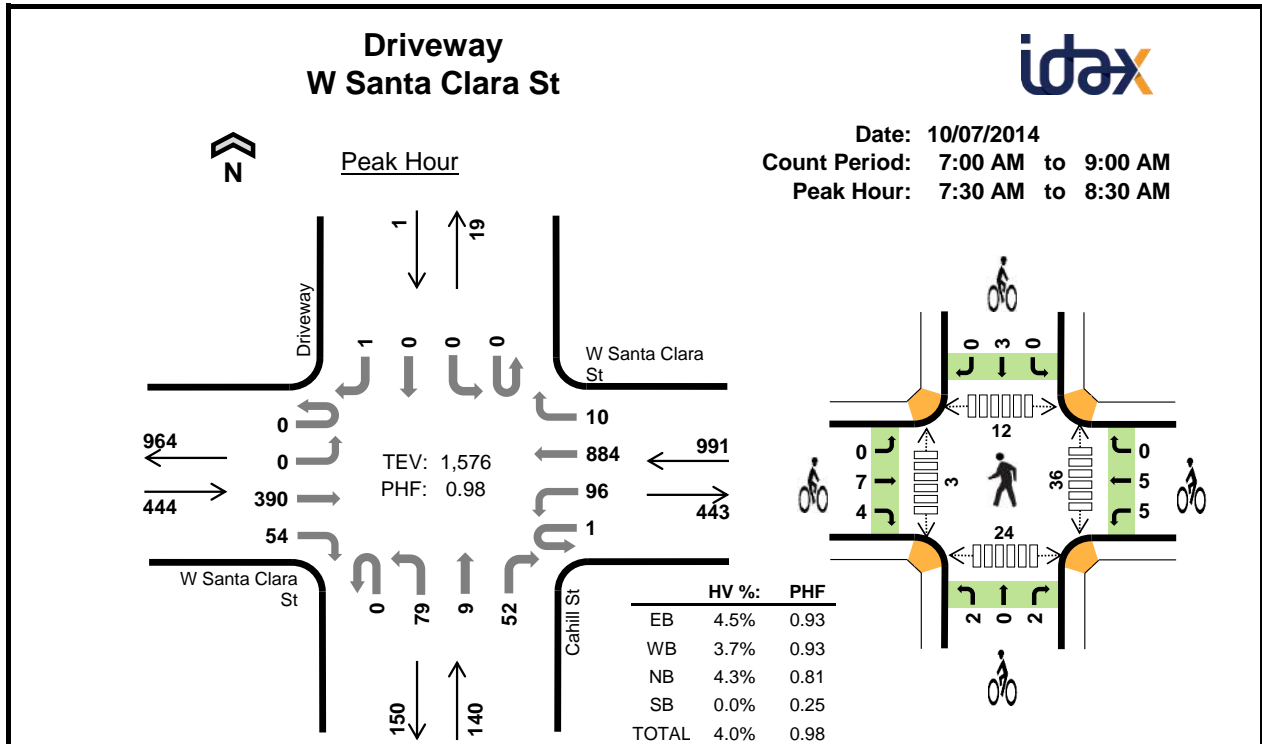

Two-Hour Count Summaries

Interval Start	W Santa Clara St Eastbound				W Santa Clara St Westbound				Cahill St Northbound				Driveway Southbound				15-min Total	Rolling One Hour
	UT	LT	TH	RT	UT	LT	TH	RT	UT	LT	TH	RT	UT	LT	TH	RT		
7:00 AM	0	0	54	12	0	16	117	3	0	9	0	7	0	0	0	0	218	0
7:15 AM	0	0	66	18	0	17	177	0	0	10	0	8	0	0	0	0	296	0
7:30 AM	0	0	97	20	1	35	181	1	0	25	0	18	0	0	0	0	378	0
7:45 AM	0	0	104	15	0	26	212	4	0	28	1	11	0	0	0	0	401	1,293
8:00 AM	0	0	83	12	0	18	248	1	0	19	6	15	0	0	0	0	402	1,477
8:15 AM	0	0	106	7	0	17	243	4	0	7	2	8	0	0	0	1	395	1,576
8:30 AM	0	0	111	16	0	24	180	8	0	12	1	9	0	0	0	0	361	1,559
8:45 AM	0	0	103	7	0	12	170	9	0	8	1	3	0	0	0	0	313	1,471
Count Total	0	0	724	107	1	165	1528	30	0	118	11	79	0	0	0	1	2,764	0
Peak Hour	All	0	0	390	54	1	96	884	10	0	79	9	52	0	0	0	1,576	0
	HV	0	0	19	1	1	14	22	0	0	2	0	4	0	0	0	63	0
	HV%	-	-	5%	2%	100%	15%	2%	0%	-	3%	0%	8%	-	-	0%	4%	0

Note: Two-hour count summary volumes include heavy vehicles but exclude bicycles in overall count.

Interval Start	Heavy Vehicle Totals					Bicycles					Pedestrians (Crossing Leg)				
	EB	WB	NB	SB	Total	EB	WB	NB	SB	Total	East	West	North	South	Total
7:00 AM	4	8	2	0	14	1	2	1	1	5	2	0	1	1	4
7:15 AM	6	7	0	0	13	2	0	2	0	4	3	0	2	5	10
7:30 AM	4	8	3	0	15	2	2	0	0	4	7	0	3	3	13
7:45 AM	6	11	0	0	17	4	5	1	0	10	14	2	7	6	29
8:00 AM	3	7	2	0	12	1	3	3	0	7	7	0	0	4	11
8:15 AM	7	11	1	0	19	4	0	0	3	7	8	1	2	11	22
8:30 AM	9	7	2	0	18	1	2	3	0	6	9	1	3	6	19
8:45 AM	3	10	0	0	13	8	3	0	0	11	7	0	0	3	10
Count Total	42	69	10	0	121	23	17	10	4	54	57	4	18	39	118
Peak Hour	20	37	6	0	63	11	10	4	3	28	36	3	12	24	75

Two-Hour Count Summaries - Heavy Vehicles																		
Interval Start	W Santa Clara St				W Santa Clara St				Cahill St				Driveway				15-min Total	Rolling One Hour
	Eastbound				Westbound				Northbound				Southbound					
	UT	LT	TH	RT	UT	LT	TH	RT	UT	LT	TH	RT	UT	LT	TH	RT		
7:00 AM	0	0	4	0	0	4	4	0	0	1	0	1	0	0	0	0	14	0
7:15 AM	0	0	5	1	0	3	4	0	0	0	0	0	0	0	0	0	13	0
7:30 AM	0	0	4	0	1	3	4	0	0	1	0	2	0	0	0	0	15	0
7:45 AM	0	0	6	0	0	4	7	0	0	0	0	0	0	0	0	0	17	59
8:00 AM	0	0	2	1	0	3	4	0	0	1	0	1	0	0	0	0	12	57
8:15 AM	0	0	7	0	0	4	7	0	0	0	0	1	0	0	0	0	19	63
8:30 AM	0	0	8	1	0	3	4	0	0	1	0	1	0	0	0	0	18	66
8:45 AM	0	0	3	0	0	3	7	0	0	0	0	0	0	0	0	0	13	62
Count Total	0	0	39	3	1	27	41	0	0	4	0	6	0	0	0	0	121	0
Peak Hour	0	0	19	1	1	14	22	0	0	2	0	4	0	0	0	0	63	0
Two-Hour Count Summaries - Bikes																		
Interval Start	W Santa Clara St			W Santa Clara St			Cahill St			Driveway			15-min Total	Rolling One Hour				
	Eastbound			Westbound			Northbound			Southbound								
	LT	TH	RT	LT	TH	RT	LT	TH	RT	LT	TH	RT						
7:00 AM	0	1	0	1	1	0	1	0	0	0	0	1	5	0				
7:15 AM	0	1	1	0	0	0	0	0	2	0	0	0	4	0				
7:30 AM	0	1	1	1	1	0	0	0	0	0	0	0	4	0				
7:45 AM	0	3	1	1	4	0	1	0	0	0	0	0	10	23				
8:00 AM	0	1	0	3	0	0	1	0	2	0	0	0	7	25				
8:15 AM	0	2	2	0	0	0	0	0	0	0	3	0	7	28				
8:30 AM	0	1	0	1	1	0	0	0	3	0	0	0	6	30				
8:45 AM	0	8	0	0	3	0	0	0	0	0	0	0	11	31				
Count Total	0	18	5	7	10	0	3	0	7	0	3	1	54	0				
Peak Hour	0	7	4	5	5	0	2	0	2	0	3	0	28	0				
<i>Note: U-Turn volumes for bikes are included in Left-Turn, if any.</i>																		

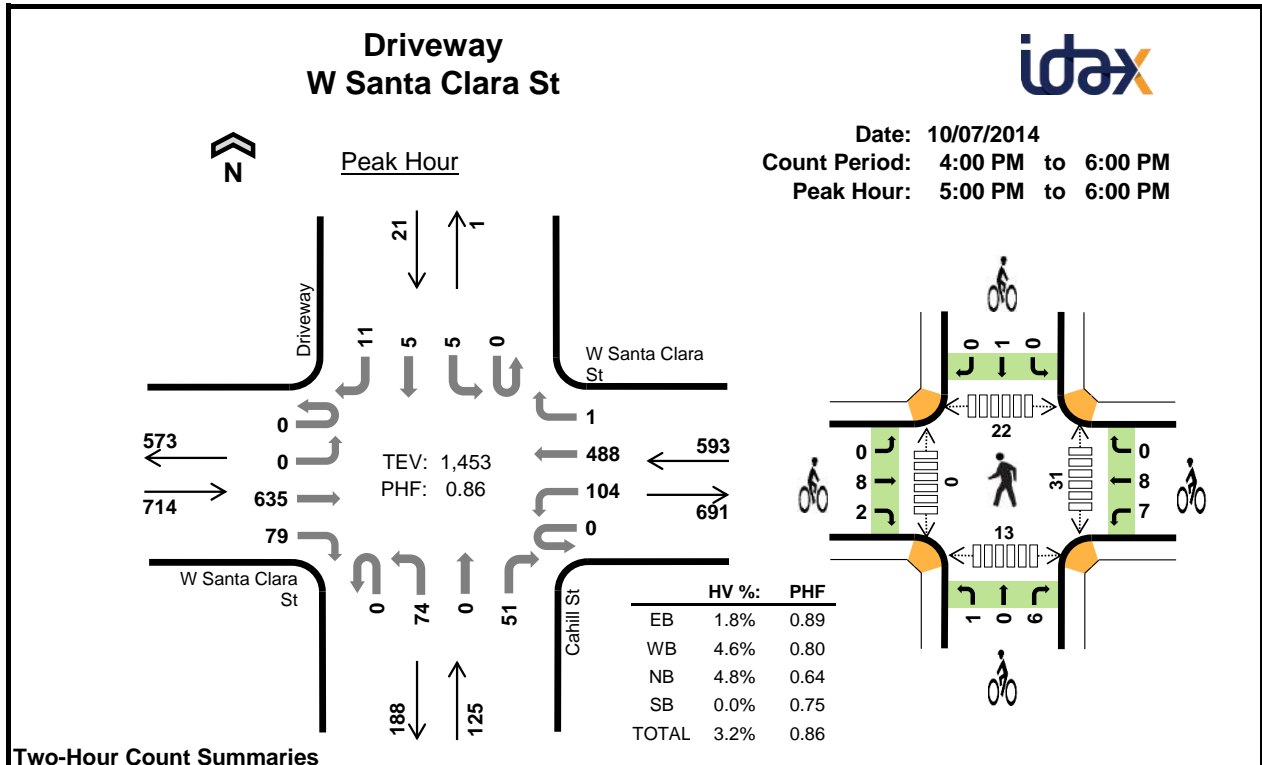

Two-Hour Count Summaries

Interval Start	W Santa Clara St Eastbound				W Santa Clara St Westbound				Cahill St Northbound				Driveway Southbound				15-min Total	Rolling One Hour	
	UT	LT	TH	RT	UT	LT	TH	RT	UT	LT	TH	RT	UT	LT	TH	RT			
4:00 PM	0	0	131	13	1	27	112	12	0	10	0	7	0	1	1	0	315	0	
4:15 PM	0	0	136	18	0	27	112	10	0	11	4	9	0	2	1	1	331	0	
4:30 PM	0	0	119	13	0	18	132	1	0	8	0	7	0	3	3	1	305	0	
4:45 PM	0	0	138	15	0	23	119	1	0	18	0	5	0	0	3	3	325	1,276	
5:00 PM	0	0	133	13	0	25	129	0	0	9	0	6	0	0	3	3	321	1,282	
5:15 PM	0	0	167	21	0	34	151	0	0	24	0	19	0	2	1	2	421	1,372	
5:30 PM	0	0	149	30	0	23	104	0	0	33	0	16	0	1	0	2	358	1,425	
5:45 PM	0	0	186	15	0	22	104	1	0	8	0	10	0	2	1	4	353	1,453	
Count Total	0	0	1159	138	1	199	963	25	0	121	4	79	0	11	13	16	2,729	0	
Peak Hour	All	0	0	635	79	0	104	488	1	0	74	0	51	0	5	5	11	1,453	0
	HV	0	0	10	3	0	14	13	0	0	2	0	4	0	0	0	0	46	0
	HV%	-	-	2%	4%	-	13%	3%	0%	-	3%	-	8%	-	0%	0%	0%	3%	0

Note: Two-hour count summary volumes include heavy vehicles but exclude bicycles in overall count.

Interval Start	Heavy Vehicle Totals					Bicycles					Pedestrians (Crossing Leg)				
	EB	WB	NB	SB	Total	EB	WB	NB	SB	Total	East	West	North	South	Total
4:00 PM	4	7	4	0	15	1	5	1	0	7	21	7	23	9	60
4:15 PM	4	10	0	0	14	4	3	0	0	7	16	7	11	4	38
4:30 PM	2	7	3	1	13	4	2	2	0	8	5	2	4	7	18
4:45 PM	6	9	2	0	17	5	1	0	0	6	5	0	7	4	16
5:00 PM	2	9	0	0	11	2	6	1	0	9	7	0	3	4	14
5:15 PM	5	8	3	0	16	3	4	1	0	8	13	0	6	3	22
5:30 PM	3	7	1	0	11	1	3	5	0	9	11	0	10	5	26
5:45 PM	3	3	2	0	8	4	2	0	1	7	0	0	3	1	4
Count Total	29	60	15	1	105	24	26	10	1	61	78	16	67	37	198
Peak Hour	13	27	6	0	46	10	15	7	1	33	31	0	22	13	66

Two-Hour Count Summaries - Heavy Vehicles																		
Interval Start	W Santa Clara St				W Santa Clara St				Cahill St				Driveway				15-min Total	Rolling One Hour
	Eastbound				Westbound				Northbound				Southbound					
	UT	LT	TH	RT	UT	LT	TH	RT	UT	LT	TH	RT	UT	LT	TH	RT		
4:00 PM	0	0	4	0	0	4	3	0	0	2	0	2	0	0	0	0	15	0
4:15 PM	0	0	4	0	0	4	6	0	0	0	0	0	0	0	0	0	14	0
4:30 PM	0	0	1	1	0	3	4	0	0	1	0	2	0	1	0	0	13	0
4:45 PM	0	0	5	1	0	5	4	0	0	1	0	1	0	0	0	0	17	59
5:00 PM	0	0	2	0	0	4	5	0	0	0	0	0	0	0	0	0	11	55
5:15 PM	0	0	3	2	0	5	3	0	0	1	0	2	0	0	0	0	16	57
5:30 PM	0	0	3	0	0	3	4	0	0	1	0	0	0	0	0	0	11	55
5:45 PM	0	0	2	1	0	2	1	0	0	0	0	2	0	0	0	0	8	46
Count Total	0	0	24	5	0	30	30	0	0	6	0	9	0	1	0	0	105	0
Peak Hour	0	0	10	3	0	14	13	0	0	2	0	4	0	0	0	0	46	0
Two-Hour Count Summaries - Bikes																		
Interval Start	W Santa Clara St			W Santa Clara St			Cahill St			Driveway			15-min Total	Rolling One Hour				
	Eastbound			Westbound			Northbound			Southbound								
	LT	TH	RT	LT	TH	RT	LT	TH	RT	LT	TH	RT						
4:00 PM	0	0	1	0	5	0	0	0	0	0	1	0	0	0	7	0		
4:15 PM	0	3	1	3	0	0	0	0	0	0	0	0	0	0	7	0		
4:30 PM	0	2	2	0	2	0	0	0	0	0	2	0	0	0	8	0		
4:45 PM	0	3	2	0	1	0	0	0	0	0	0	0	0	0	6	28		
5:00 PM	0	2	0	3	3	0	0	0	1	0	0	0	0	0	9	30		
5:15 PM	0	1	2	2	2	0	1	0	0	0	0	0	0	0	8	31		
5:30 PM	0	1	0	2	1	0	0	0	5	0	0	0	0	0	9	32		
5:45 PM	0	4	0	0	2	0	0	0	0	0	0	0	1	0	7	33		
Count Total	0	16	8	10	16	0	1	0	9	0	1	0	0	1	61	0		
Peak Hour	0	8	2	7	8	0	1	0	6	0	1	0	0	1	33	0		
<i>Note: U-Turn volumes for bikes are included in Left-Turn, if any.</i>																		

S Montgomery St W Santa Clara St



Peak Hour

Date: 10/07/2014
Count Period: 7:00 AM to 9:00 AM
Peak Hour: 7:30 AM to 8:30 AM

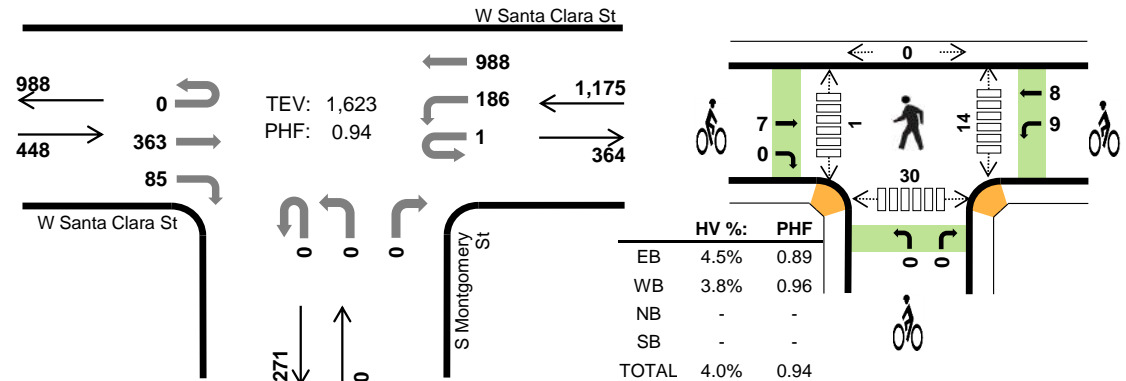

Two-Hour Count Summaries

Interval Start	W Santa Clara St Eastbound				W Santa Clara St Westbound				S Montgomery St Northbound				0 Southbound				15-min Total	Rolling One Hour	
	UT	LT	TH	RT	UT	LT	TH	RT	UT	LT	TH	RT	UT	LT	TH	RT			
7:00 AM	0	0	52	11	0	18	140	0	0	0	0	0	0	0	0	0	221	0	
7:15 AM	0	0	55	18	0	44	199	0	0	0	0	0	0	0	0	0	316	0	
7:30 AM	0	0	88	29	0	68	211	0	0	0	0	0	0	0	0	0	396	0	
7:45 AM	0	0	105	21	0	57	249	0	0	0	0	0	0	0	0	0	432	1,365	
8:00 AM	0	0	79	18	0	33	261	0	0	0	0	0	0	0	0	0	391	1,535	
8:15 AM	0	0	91	17	1	28	267	0	0	0	0	0	0	0	0	0	404	1,623	
8:30 AM	0	0	94	29	2	32	203	0	0	0	0	0	0	0	0	0	360	1,587	
8:45 AM	0	0	99	15	0	28	200	0	0	0	0	0	0	0	0	0	342	1,497	
Count Total	0	0	663	158	3	308	1730	0	0	0	0	0	0	0	0	0	2,862	0	
Peak Hour	All	0	0	363	85	1	186	988	0	0	0	0	0	0	0	0	0	1,623	0
	HV	0	0	17	3	0	9	36	0	0	0	0	0	0	0	0	0	65	0
	HV%	-	-	5%	4%	0%	5%	4%	-	-	-	-	-	-	-	-	-	4%	0

Note: Two-hour count summary volumes include heavy vehicles but exclude bicycles in overall count.

Interval Start	Heavy Vehicle Totals					Bicycles					Pedestrians (Crossing Leg)				
	EB	WB	NB	SB	Total	EB	WB	NB	SB	Total	East	West	North	South	Total
7:00 AM	5	8	0	0	13	1	1	0	0	2	1	0	0	2	3
7:15 AM	4	9	0	0	13	3	0	0	0	3	3	0	0	8	11
7:30 AM	7	12	0	0	19	1	8	0	0	9	3	0	0	13	16
7:45 AM	4	14	0	0	18	2	3	0	0	5	1	0	0	9	10
8:00 AM	3	10	0	0	13	3	3	0	0	6	3	0	0	6	9
8:15 AM	6	9	0	0	15	1	3	0	0	4	7	1	0	2	10
8:30 AM	8	9	0	0	17	4	3	1	0	8	1	2	0	4	7
8:45 AM	4	15	0	0	19	7	4	0	0	11	0	0	0	3	3
Count Total	41	86	0	0	127	22	25	1	0	48	19	3	0	47	69
Peak Hr	20	45	0	0	65	7	17	0	0	24	14	1	0	30	45

Two-Hour Count Summaries - Heavy Vehicles																		
Interval Start	W Santa Clara St				W Santa Clara St				S Montgomery St				O				15-min Total	Rolling One Hour
	Eastbound				Westbound				Northbound				Southbound					
	UT	LT	TH	RT	UT	LT	TH	RT	UT	LT	TH	RT	UT	LT	TH	RT		
7:00 AM	0	0	5	0	0	0	8	0	0	0	0	0	0	0	0	13	0	
7:15 AM	0	0	3	1	0	0	9	0	0	0	0	0	0	0	0	13	0	
7:30 AM	0	0	6	1	0	4	8	0	0	0	0	0	0	0	0	19	0	
7:45 AM	0	0	4	0	0	3	11	0	0	0	0	0	0	0	0	18	63	
8:00 AM	0	0	3	0	0	2	8	0	0	0	0	0	0	0	0	13	63	
8:15 AM	0	0	4	2	0	0	9	0	0	0	0	0	0	0	0	15	65	
8:30 AM	0	0	6	2	0	3	6	0	0	0	0	0	0	0	0	17	63	
8:45 AM	0	0	3	1	0	3	12	0	0	0	0	0	0	0	0	19	64	
Count Total	0	0	34	7	0	15	71	0	0	0	0	0	0	0	0	127	0	
Peak Hour	0	0	17	3	0	9	36	0	0	0	0	0	0	0	0	65	0	
Two-Hour Count Summaries - Bikes																		
Interval Start	W Santa Clara St			W Santa Clara St			S Montgomery St			O			15-min Total	Rolling One Hour				
	Eastbound			Westbound			Northbound			Southbound								
	LT	TH	RT	LT	TH	RT	LT	TH	RT	LT	TH	RT						
7:00 AM	0	1	0	0	1	0	0	0	0	0	0	0	2	0				
7:15 AM	0	3	0	0	0	0	0	0	0	0	0	0	3	0				
7:30 AM	0	1	0	6	2	0	0	0	0	0	0	0	9	0				
7:45 AM	0	2	0	0	3	0	0	0	0	0	0	0	5	19				
8:00 AM	0	3	0	0	3	0	0	0	0	0	0	0	6	23				
8:15 AM	0	1	0	3	0	0	0	0	0	0	0	0	4	24				
8:30 AM	0	4	0	1	2	0	0	0	1	0	0	0	8	23				
8:45 AM	0	7	0	1	3	0	0	0	0	0	0	0	11	29				
Count Total	0	22	0	11	14	0	0	0	1	0	0	0	48	0				
Peak Hour	0	7	0	9	8	0	0	0	0	0	0	0	24	0				
<i>Note: U-Turn volumes for bikes are included in Left-Turn, if any.</i>																		

LOCATION: Montgomery St -- Santa Clara St (Rte 82)
CITY/STATE: San Jose, CA

CLIENT ID: 3112

QC JOB #: 12781647

DATE: Wed, Sep 17 2014

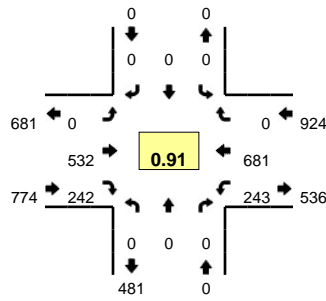

Peak-Hour: 4:50 PM -- 5:50 PM
Peak 15-Min: 5:05 PM -- 5:20 PM

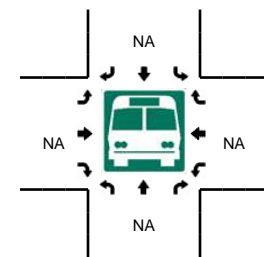
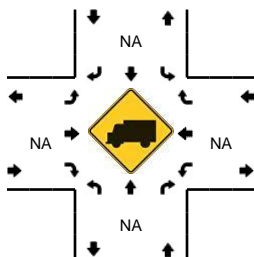
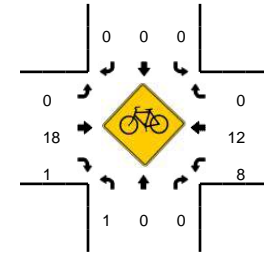
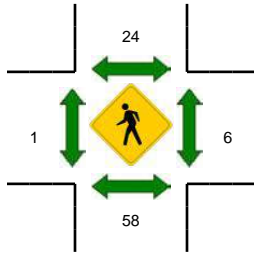
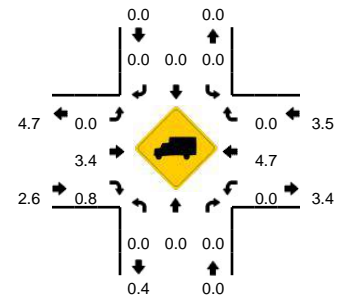

5-Min Count Period Beginning At	Montgomery St (Northbound)				Montgomery St (Southbound)				Santa Clara St (Rte 82) (Eastbound)				Santa Clara St (Rte 82) (Westbound)				Total	Hourly Totals
	Left	Thru	Right	U	Left	Thru	Right	U	Left	Thru	Right	U	Left	Thru	Right	U		
4:00 PM	0	0	0	0	0	0	0	0	0	30	13	0	12	41	0	0	96	
4:05 PM	0	0	0	0	0	0	0	0	0	33	16	0	6	57	0	1	113	
4:10 PM	0	0	0	0	0	0	0	0	0	35	11	0	9	48	0	1	104	
4:15 PM	0	0	0	0	0	0	0	0	0	41	10	0	8	48	0	0	107	
4:20 PM	0	0	0	0	0	0	0	0	0	38	14	0	11	35	0	0	98	
4:25 PM	0	0	0	0	0	0	0	0	0	43	25	0	15	36	0	0	119	
4:30 PM	0	0	0	0	0	0	0	0	0	28	12	0	14	39	0	0	93	
4:35 PM	0	0	0	0	0	0	0	0	0	41	18	0	7	45	0	0	111	
4:40 PM	0	0	0	0	0	0	0	0	0	30	14	0	17	43	0	1	105	
4:45 PM	0	0	0	0	0	0	0	0	0	46	15	0	12	54	0	0	127	
4:50 PM	0	0	0	0	0	0	0	0	0	32	22	0	19	60	0	0	133	
4:55 PM	0	0	0	0	0	0	0	0	0	52	13	0	12	56	0	2	135	1341
5:00 PM	0	0	0	0	0	0	0	0	0	38	12	0	21	53	0	0	124	1369
5:05 PM	0	0	0	0	0	0	0	0	0	54	20	0	19	61	0	0	154	1410
5:10 PM	0	0	0	0	0	0	0	0	0	42	22	0	24	56	0	0	144	1450
5:15 PM	0	0	0	0	0	0	0	0	0	47	18	0	16	86	0	0	167	1510
5:20 PM	0	0	0	0	0	0	0	0	0	29	23	0	16	56	0	0	124	1536
5:25 PM	0	0	0	0	0	0	0	0	0	46	11	0	17	51	0	0	125	1542
5:30 PM	0	0	0	0	0	0	0	0	0	39	27	0	36	56	0	2	160	1609
5:35 PM	0	0	0	0	0	0	0	0	0	58	27	0	15	58	0	0	158	1656
5:40 PM	0	0	0	0	0	0	0	0	0	41	26	0	28	37	0	0	132	1683
5:45 PM	0	0	0	0	0	0	0	0	0	54	21	0	16	51	0	0	142	1698
5:50 PM	0	0	0	0	0	0	0	0	0	33	14	0	17	39	0	0	103	1668
5:55 PM	0	0	0	0	0	0	0	0	0	42	18	0	18	69	0	0	147	1680
Peak 15-Min Flowrates	Northbound				Southbound				Eastbound				Westbound				Total	
	Left	Thru	Right	U	Left	Thru	Right	U	Left	Thru	Right	U	Left	Thru	Right	U		
All Vehicles	0	0	0	0	0	0	0	0	0	572	240	0	236	812	0	0	1860	
Heavy Trucks	0	0	0	0	0	0	0	0	0	20	4	0	0	24	0	0	48	
Pedestrians		64				20				4				4			92	
Bicycles	0	0	0	0	0	0	0	0	0	2	0	0	2	6	0	0	10	
Railroad																		
Stopped Buses																		

Comments:

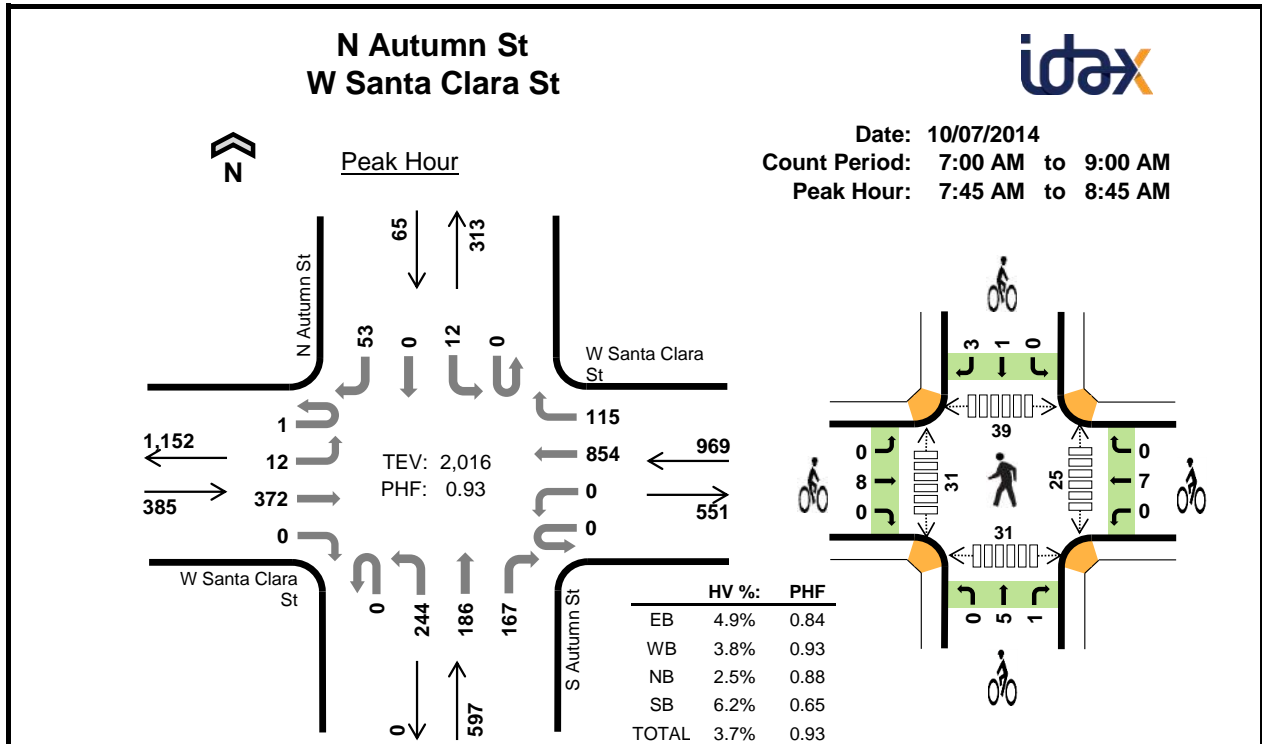

Two-Hour Count Summaries

Interval Start	W Santa Clara St Eastbound				W Santa Clara St Westbound				S Autumn St Northbound				N Autumn St Southbound				15-min Total	Rolling One Hour	
	UT	LT	TH	RT	UT	LT	TH	RT	UT	LT	TH	RT	UT	LT	TH	RT			
7:00 AM	0	4	49	0	0	0	113	10	0	28	15	11	0	1	0	7	238	0	
7:15 AM	0	2	57	0	0	0	206	10	0	26	14	18	0	2	0	6	341	0	
7:30 AM	1	3	74	0	0	0	197	14	0	55	29	23	0	5	0	21	422	0	
7:45 AM	0	2	112	0	0	0	225	36	0	61	42	41	0	5	0	20	544	1,545	
8:00 AM	0	4	77	0	0	0	220	33	0	71	57	35	0	1	0	11	509	1,816	
8:15 AM	0	6	89	0	0	0	214	30	0	68	49	52	0	5	0	10	523	1,998	
8:30 AM	1	0	94	0	0	0	195	16	0	44	38	39	0	1	0	12	440	2,016	
8:45 AM	2	1	101	0	0	0	157	13	0	39	29	48	0	1	0	9	400	1,872	
Count Total	4	22	653	0	0	0	1527	162	0	392	273	267	0	21	0	96	3,417	0	
Peak Hour	All	1	12	372	0	0	0	854	115	0	244	186	167	0	12	0	53	2,016	0
	HV	0	1	18	0	0	0	36	1	0	4	2	9	0	0	0	4	75	0
	HV%	0%	8%	5%	-	-	-	4%	1%	-	2%	1%	5%	-	0%	-	8%	4%	0

Note: Two-hour count summary volumes include heavy vehicles but exclude bicycles in overall count.

Interval Start	Heavy Vehicle Totals					Bicycles					Pedestrians (Crossing Leg)				
	EB	WB	NB	SB	Total	EB	WB	NB	SB	Total	East	West	North	South	Total
7:00 AM	6	10	2	0	18	2	1	1	0	4	2	2	6	6	16
7:15 AM	3	10	5	1	19	0	0	0	0	0	4	11	14	3	32
7:30 AM	7	8	3	1	19	2	5	1	0	8	3	10	9	6	28
7:45 AM	4	9	4	2	19	2	2	1	2	7	7	14	16	11	48
8:00 AM	6	9	5	2	22	3	2	4	0	9	8	6	6	6	26
8:15 AM	4	9	4	0	17	0	0	1	1	2	5	6	9	7	27
8:30 AM	5	10	2	0	17	3	3	0	1	7	5	5	8	7	25
8:45 AM	3	12	3	2	20	9	3	1	0	13	5	5	8	13	31
Count Total	38	77	28	8	151	21	16	9	4	50	39	59	76	59	233
Peak Hour	19	37	15	4	75	8	7	6	4	25	25	31	39	31	126

Two-Hour Count Summaries - Heavy Vehicles														15-min Total	Rolling One Hour				
Interval Start	W Santa Clara St				W Santa Clara St				S Autumn St				N Autumn St						
	Eastbound				Westbound				Northbound				Southbound						
	UT	LT	TH	RT	UT	LT	TH	RT	UT	LT	TH	RT	UT	LT	TH	RT			
7:00 AM	0	0	6	0	0	0	8	2	0	1	0	1	0	0	0	0	0	18	0
7:15 AM	0	1	2	0	0	0	9	1	0	1	2	2	0	1	0	0	0	19	0
7:30 AM	0	0	7	0	0	0	8	0	0	0	1	2	0	0	0	1	0	19	0
7:45 AM	0	0	4	0	0	0	9	0	0	2	0	2	0	0	0	2	0	19	75
8:00 AM	0	0	6	0	0	0	9	0	0	0	2	3	0	0	0	2	0	22	79
8:15 AM	0	1	3	0	0	0	9	0	0	2	0	2	0	0	0	0	0	17	77
8:30 AM	0	0	5	0	0	0	9	1	0	0	0	2	0	0	0	0	0	17	75
8:45 AM	0	0	3	0	0	0	11	1	0	2	1	0	0	0	0	2	0	20	76
Count Total	0	2	36	0	0	0	72	5	0	8	6	14	0	1	0	7	0	151	0
Peak Hour	0	1	18	0	0	0	36	1	0	4	2	9	0	0	0	4	0	75	0

Two-Hour Count Summaries - Bikes														15-min Total	Rolling One Hour		
Interval Start	W Santa Clara St			W Santa Clara St			S Autumn St			N Autumn St							
	Eastbound			Westbound			Northbound			Southbound							
	LT	TH	RT	LT	TH	RT	LT	TH	RT	LT	TH	RT	LT	TH	RT		
7:00 AM	1	1	0	0	1	0	0	1	0	0	0	0	0	0	0	4	0
7:15 AM	0	0	0	0	0	0	0	0	0	0	0	0	0	0	0	0	0
7:30 AM	1	1	0	0	5	0	0	1	0	0	0	0	0	0	0	8	0
7:45 AM	0	2	0	0	2	0	0	1	0	0	1	1	0	1	1	7	19
8:00 AM	0	3	0	0	2	0	0	3	1	0	0	0	0	0	0	9	24
8:15 AM	0	0	0	0	0	0	0	1	0	0	0	1	0	0	1	2	26
8:30 AM	0	3	0	0	3	0	0	0	0	0	0	1	0	0	1	7	25
8:45 AM	3	6	0	0	3	0	0	1	0	0	0	0	0	0	0	13	31
Count Total	5	16	0	0	16	0	0	8	1	0	1	3	0	1	3	50	0
Peak Hour	0	8	0	0	7	0	0	5	1	0	1	3	0	1	3	25	0

Note: U-Turn volumes for bikes are included in Left-Turn, if any.

LOCATION: Autumn St -- Santa Clara St
CITY/STATE: San Jose, CA

CLIENT ID: 3066

QC JOB #: 12781603
DATE: Tue, Sep 16 2014

Peak-Hour: 4:55 PM -- 5:55 PM
Peak 15-Min: 5:15 PM -- 5:30 PM

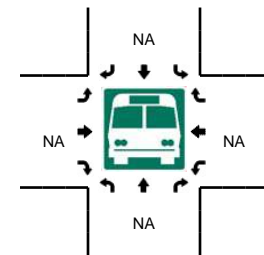
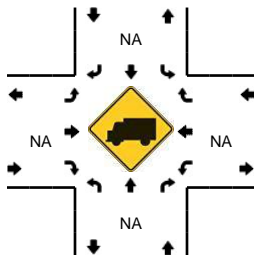
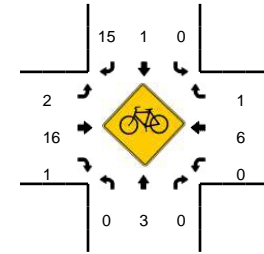
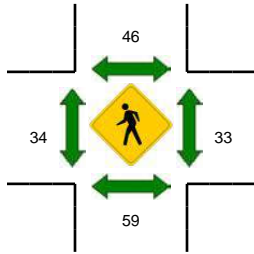
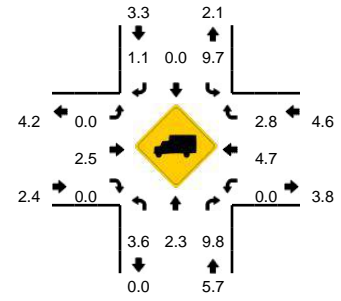
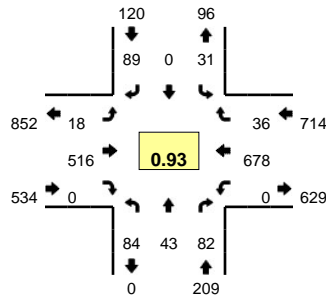

5-Min Count Period Beginning At	Autumn St (Northbound)				Autumn St (Southbound)				Santa Clara St (Eastbound)				Santa Clara St (Westbound)				Total	Hourly Totals
	Left	Thru	Right	U	Left	Thru	Right	U	Left	Thru	Right	U	Left	Thru	Right	U		
4:00 PM	6	5	4	0	0	0	9	0	0	27	0	0	0	31	2	1	85	
4:05 PM	4	3	5	0	2	0	4	0	1	27	0	0	0	55	3	0	104	
4:10 PM	5	4	5	0	2	0	7	0	2	41	0	0	0	44	1	1	112	
4:15 PM	10	3	3	0	2	0	11	0	3	46	0	0	0	36	6	0	120	
4:20 PM	5	5	4	0	4	0	10	0	0	31	0	0	0	31	5	0	95	
4:25 PM	3	6	3	0	1	0	3	0	2	48	0	0	0	40	3	0	109	
4:30 PM	4	5	7	0	0	0	7	0	4	31	0	1	0	37	3	0	99	
4:35 PM	6	6	0	0	2	0	8	0	1	31	0	1	0	38	3	0	96	
4:40 PM	5	6	6	0	4	0	9	0	2	31	0	0	0	40	8	0	111	
4:45 PM	8	7	4	0	2	0	8	0	1	35	0	0	0	42	2	0	109	
4:50 PM	8	5	7	0	1	0	8	0	1	32	0	0	0	41	3	0	106	
4:55 PM	5	6	6	0	2	0	6	0	1	37	0	0	0	61	0	0	124	1270
5:00 PM	8	2	5	0	2	0	7	0	1	42	0	0	0	46	5	0	118	1303
5:05 PM	3	3	9	0	4	0	6	0	2	39	0	1	0	78	4	0	149	1348
5:10 PM	9	2	8	0	5	0	3	0	1	40	0	0	0	60	6	0	134	1370
5:15 PM	7	4	9	0	0	0	9	0	3	38	0	0	0	60	3	0	133	1383
5:20 PM	9	4	7	0	1	0	15	0	4	50	0	0	0	54	3	0	147	1435
5:25 PM	5	1	5	0	3	0	5	0	1	53	0	0	0	65	4	0	142	1468
5:30 PM	4	1	8	0	3	0	6	0	1	41	0	0	0	38	4	0	106	1475
5:35 PM	8	4	9	0	3	0	8	0	1	54	0	0	0	61	1	0	149	1528
5:40 PM	9	8	6	0	4	0	4	0	0	39	0	0	0	62	1	0	133	1550
5:45 PM	11	5	7	0	3	0	14	0	2	33	0	0	0	55	3	0	133	1574
5:50 PM	6	3	3	0	1	0	6	0	0	50	0	0	0	38	2	0	109	1577
5:55 PM	10	3	5	0	1	0	6	0	1	30	0	0	0	60	1	0	117	1570
Peak 15-Min Flowrates	Northbound				Southbound				Eastbound				Westbound				Total	
	Left	Thru	Right	U	Left	Thru	Right	U	Left	Thru	Right	U	Left	Thru	Right	U		
All Vehicles	84	36	84	0	16	0	116	0	32	564	0	0	0	716	40	0	1688	
Heavy Trucks	0	0	4		4	0	4		0	8	0		0	44	4		68	
Pedestrians		84				64				36				40			224	
Bicycles	0	1	0		0	0	0		1	6	0		0	0	0		8	
Railroad																		
Stopped Buses																		

Comments:

SR 87 Off-ramp W Santa Clara St



Peak Hour

Date: 10/07/2014
Count Period: 7:00 AM to 9:00 AM
Peak Hour: 7:45 AM to 8:45 AM

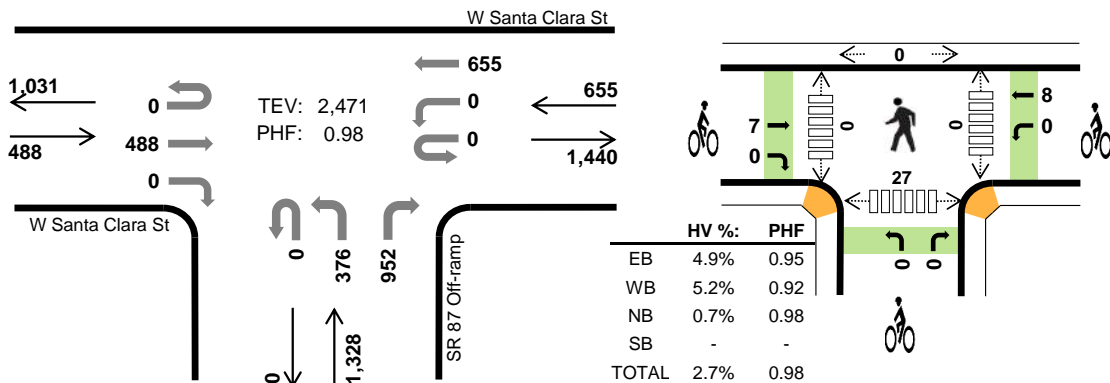

Two-Hour Count Summaries

Interval Start	W Santa Clara St Eastbound				W Santa Clara St Westbound				SR 87 Off-ramp Northbound				SR 87 Off-ramp Southbound				15-min Total	Rolling One Hour	
	UT	LT	TH	RT	UT	LT	TH	RT	UT	LT	TH	RT	UT	LT	TH	RT			
7:00 AM	0	0	55	0	0	0	85	0	0	55	0	159	0	0	0	0	354	0	
7:15 AM	0	0	65	0	0	0	145	0	0	84	0	130	0	0	0	0	424	0	
7:30 AM	0	0	97	0	0	0	150	0	0	107	0	170	0	0	0	0	524	0	
7:45 AM	0	0	119	0	0	0	178	0	0	134	0	195	0	0	0	0	626	1,928	
8:00 AM	0	0	120	0	0	0	176	0	0	89	0	245	0	0	0	0	630	2,204	
8:15 AM	0	0	120	0	0	0	160	0	0	77	0	250	0	0	0	0	607	2,387	
8:30 AM	0	0	129	0	0	0	141	0	0	76	0	262	0	0	0	0	608	2,471	
8:45 AM	0	0	136	0	0	0	126	0	0	69	0	221	0	0	0	0	552	2,397	
Count Total	0	0	841	0	0	0	1161	0	0	691	0	1632	0	0	0	0	4,325	0	
Peak Hour	All	0	0	488	0	0	0	655	0	0	376	0	952	0	0	0	0	2,471	0
	HV	0	0	24	0	0	0	34	0	0	2	0	7	0	0	0	0	67	0
	HV%	-	-	5%	-	-	-	5%	-	-	1%	-	1%	-	-	-	-	3%	0

Note: Two-hour count summary volumes include heavy vehicles but exclude bicycles in overall count.

Interval Start	Heavy Vehicle Totals					Bicycles					Pedestrians (Crossing Leg)				
	EB	WB	NB	SB	Total	EB	WB	NB	SB	Total	East	West	North	South	Total
7:00 AM	7	11	2	0	20	0	0	0	0	0	0	0	0	0	0
7:15 AM	4	7	10	0	21	0	1	0	0	1	0	0	0	0	0
7:30 AM	8	7	3	0	18	0	8	0	0	8	0	0	0	0	0
7:45 AM	4	11	1	0	16	0	4	0	0	4	0	0	0	0	0
8:00 AM	8	7	2	0	17	4	2	0	0	6	0	0	0	5	5
8:15 AM	5	8	3	0	16	0	0	0	0	0	0	0	0	11	11
8:30 AM	7	8	3	0	18	3	2	0	0	5	0	0	0	11	11
8:45 AM	4	14	6	0	24	4	4	0	0	8	0	0	0	13	13
Count Total	47	73	30	0	150	11	21	0	0	32	0	0	0	40	40
Peak Hr	24	34	9	0	67	7	8	0	0	15	0	0	0	27	27

Two-Hour Count Summaries - Heavy Vehicles																		
Interval Start	W Santa Clara St				W Santa Clara St				SR 87 Off-ramp				0				15-min Total	Rolling One Hour
	Eastbound				Westbound				Northbound				Southbound					
	UT	LT	TH	RT	UT	LT	TH	RT	UT	LT	TH	RT	UT	LT	TH	RT		
7:00 AM	0	0	7	0	0	0	11	0	0	0	0	2	0	0	0	0	20	0
7:15 AM	0	0	4	0	0	0	7	0	0	2	0	8	0	0	0	0	21	0
7:30 AM	0	0	8	0	0	0	7	0	0	2	0	1	0	0	0	0	18	0
7:45 AM	0	0	4	0	0	0	11	0	0	0	0	1	0	0	0	0	16	75
8:00 AM	0	0	8	0	0	0	7	0	0	0	0	2	0	0	0	0	17	72
8:15 AM	0	0	5	0	0	0	8	0	0	0	0	3	0	0	0	0	16	67
8:30 AM	0	0	7	0	0	0	8	0	0	2	0	1	0	0	0	0	18	67
8:45 AM	0	0	4	0	0	0	14	0	0	1	0	5	0	0	0	0	24	75
Count Total	0	0	47	0	0	0	73	0	0	7	0	23	0	0	0	0	150	0
Peak Hour	0	0	24	0	0	0	34	0	0	2	0	7	0	0	0	0	67	0
Two-Hour Count Summaries - Bikes																		
Interval Start	W Santa Clara St			W Santa Clara St			SR 87 Off-ramp			0			15-min Total	Rolling One Hour				
	Eastbound			Westbound			Northbound			Southbound								
	LT	TH	RT	LT	TH	RT	LT	TH	RT	LT	TH	RT						
7:00 AM	0	0	0	0	0	0	0	0	0	0	0	0	0	0	0	0	0	0
7:15 AM	0	0	0	0	1	0	0	0	0	0	0	0	0	0	0	0	1	0
7:30 AM	0	0	0	0	8	0	0	0	0	0	0	0	0	0	0	0	8	0
7:45 AM	0	0	0	0	4	0	0	0	0	0	0	0	0	0	0	0	4	13
8:00 AM	0	4	0	0	2	0	0	0	0	0	0	0	0	0	0	0	6	19
8:15 AM	0	0	0	0	0	0	0	0	0	0	0	0	0	0	0	0	0	18
8:30 AM	0	3	0	0	2	0	0	0	0	0	0	0	0	0	0	0	5	15
8:45 AM	0	4	0	0	4	0	0	0	0	0	0	0	0	0	0	0	8	19
Count Total	0	11	0	0	21	0	0	0	0	0	0	0	0	0	0	0	32	0
Peak Hour	0	7	0	0	8	0	0	0	0	0	0	0	0	0	0	0	15	0
<i>Note: U-Turn volumes for bikes are included in Left-Turn, if any.</i>																		

INTERSECTION TURNING MOVEMENT COUNT SUMMARY

CLIENT: KITTELSON & ASSOCIATES, INC
 PROJECT: 2014 SCVTA CMP MONITORING
 DATE: TUESDAY SEPTEMBER 23, 2014
 PERIOD: 4:00 PM TO 6:00 PM
 INTERSECTION: N/S NB HWY-87 OFF-RAMP
 E/W E. SANTA CLARA STREET
 CITY: SAN JOSE

VEHICLES

15 MIN COUNTS														4:00 PM TO 6:00 PM
PERIOD	1 SBRT	2 SBTH	3 SBLT	4 WBRT	5 WBTH	6 WBLT	7 NBRT	8 NBTH	9 NBLT	10 EBRT	11 EBTH	12 EBLT	TOTAL	
400-415	0	0	0	0	112	0	86	0	62	0	108	0	368	
415-430	0	0	0	0	118	0	135	0	85	0	113	0	451	
430-445	0	0	0	0	123	0	121	0	107	0	122	0	473	
445-500	0	0	0	0	128	0	144	0	118	0	148	0	538	
500-515	0	0	0	0	154	0	127	0	124	0	170	0	575	
515-530	0	0	0	0	165	0	141	0	131	0	188	0	625	
530-545	0	0	0	0	147	0	161	0	130	0	178	0	616	
545-600	0	0	0	0	160	0	141	0	144	0	174	0	619	
HOUR TOTALS														
TIME	1 SBRT	2 SBTH	3 SBLT	4 WBRT	5 WBTH	6 WBLT	7 NBRT	8 NBTH	9 NBLT	10 EBRT	11 EBTH	12 EBLT	TOTAL	
400-500	0	0	0	0	481	0	486	0	372	0	491	0	1830	
415-515	0	0	0	0	523	0	527	0	434	0	553	0	2037	
430-530	0	0	0	0	570	0	533	0	480	0	628	0	2211	
445-545	0	0	0	0	594	0	573	0	503	0	684	0	2354	
500-600	0	0	0	0	626	0	570	0	529	0	710	0	2435	

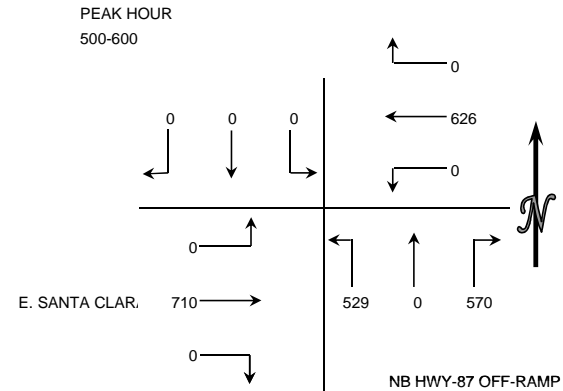

BICYCLES

15 MIN COUNTS														4:00 PM TO 6:00 PM
PERIOD	1 SBRT	2 SBTH	3 SBLT	4 WBRT	5 WBTH	6 WBLT	7 NBRT	8 NBTH	9 NBLT	10 EBRT	11 EBTH	12 EBLT	TOTAL	
400-415	0	0	0	0	4	0	0	0	0	0	4	0	8	
415-430	0	0	0	0	10	0	0	0	0	0	3	0	13	
430-445	0	0	0	0	4	0	0	0	0	0	9	0	13	
445-500	0	0	0	0	2	0	0	0	0	0	4	0	6	
500-515	0	0	0	0	12	0	0	0	0	0	2	0	14	
515-530	0	0	0	0	7	0	0	0	0	0	5	0	12	
530-545	0	0	0	0	4	0	0	0	0	0	4	0	8	
545-600	0	0	0	0	5	0	0	0	0	0	4	0	9	
HOUR TOTALS														
TIME	1 SBRT	2 SBTH	3 SBLT	4 WBRT	5 WBTH	6 WBLT	7 NBRT	8 NBTH	9 NBLT	10 EBRT	11 EBTH	12 EBLT	TOTAL	
400-500	0	0	0	0	20	0	0	0	0	0	20	0	40	
415-515	0	0	0	0	28	0	0	0	0	0	18	0	46	
430-530	0	0	0	0	25	0	0	0	0	0	20	0	45	
445-545	0	0	0	0	25	0	0	0	0	0	15	0	40	
500-600	0	0	0	0	28	0	0	0	0	0	15	0	43	

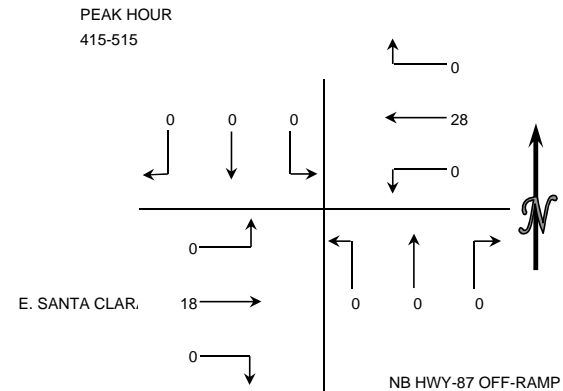

S Montgomery St W San Fernando St



Date: 10/07/2014
Count Period: 7:00 AM to 9:00 AM
Peak Hour: 7:15 AM to 8:15 AM

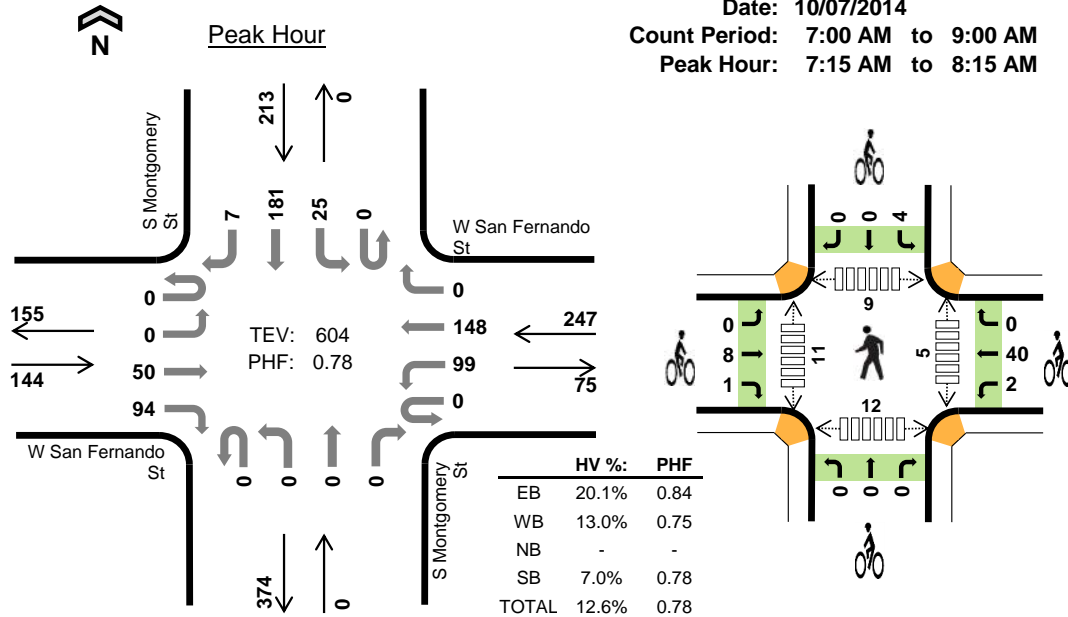

Two-Hour Count Summaries

Interval Start	W San Fernando St Eastbound				W San Fernando St Westbound				S Montgomery St Northbound				S Montgomery St Southbound				15-min Total	Rolling One Hour	
	UT	LT	TH	RT	UT	LT	TH	RT	UT	LT	TH	RT	UT	LT	TH	RT			
7:00 AM	0	0	9	15	0	12	29	0	0	0	0	0	0	3	24	0	92	0	
7:15 AM	0	0	6	21	0	28	23	0	0	0	0	0	0	1	32	0	111	0	
7:30 AM	0	0	11	32	0	36	46	0	0	0	0	0	0	12	53	3	193	0	
7:45 AM	0	0	15	21	0	18	37	0	0	0	0	0	0	7	53	1	152	548	
8:00 AM	0	0	18	20	0	17	42	0	0	0	0	0	0	5	43	3	148	604	
8:15 AM	0	0	12	22	0	9	24	0	0	0	0	0	0	5	37	0	109	602	
8:30 AM	0	0	14	23	0	18	25	0	0	0	0	0	0	8	58	2	148	557	
8:45 AM	0	0	11	17	0	14	25	0	0	0	0	0	0	6	29	1	103	508	
Count Total	0	0	96	171	0	152	251	0	0	0	0	0	0	47	329	10	1,056	0	
Peak Hour	All	0	0	50	94	0	99	148	0	0	0	0	0	0	25	181	7	604	0
	HV	0	0	25	4	0	9	23	0	0	0	0	0	0	5	10	0	76	0
	HV%	-	-	50%	4%	-	9%	16%	-	-	-	-	-	-	20%	6%	0%	13%	0

Note: Two-hour count summary volumes include heavy vehicles but exclude bicycles in overall count.

Interval Start	Heavy Vehicle Totals					Bicycles					Pedestrians (Crossing Leg)				
	EB	WB	NB	SB	Total	EB	WB	NB	SB	Total	East	West	North	South	Total
7:00 AM	6	4	0	1	11	0	6	0	0	6	0	1	0	1	2
7:15 AM	6	7	0	0	13	0	8	0	0	8	2	3	1	0	6
7:30 AM	6	6	0	8	20	2	19	0	1	22	0	2	0	6	8
7:45 AM	8	14	0	4	26	0	6	0	0	6	0	3	3	6	12
8:00 AM	9	5	0	3	17	7	9	0	3	19	3	3	5	0	11
8:15 AM	10	8	0	5	23	3	7	0	3	13	3	0	0	2	5
8:30 AM	8	5	0	6	19	9	3	1	4	17	1	2	2	4	9
8:45 AM	9	7	0	6	22	4	4	0	1	9	0	1	3	3	7
Count Total	62	56	0	33	151	25	62	1	12	100	9	15	14	22	60
Peak Hour	29	32	0	15	76	9	42	0	4	55	5	11	9	12	37

Two-Hour Count Summaries - Heavy Vehicles																		
Interval Start	W San Fernando St				W San Fernando St				S Montgomery St				S Montgomery St				15-min Total	Rolling One Hour
	Eastbound				Westbound				Northbound				Southbound					
	UT	LT	TH	RT	UT	LT	TH	RT	UT	LT	TH	RT	UT	LT	TH	RT		
7:00 AM	0	0	5	1	0	0	4	0	0	0	0	0	0	0	1	0	11	0
7:15 AM	0	0	6	0	0	2	5	0	0	0	0	0	0	0	0	0	13	0
7:30 AM	0	0	5	1	0	1	5	0	0	0	0	0	0	3	5	0	20	0
7:45 AM	0	0	6	2	0	5	9	0	0	0	0	0	0	1	3	0	26	70
8:00 AM	0	0	8	1	0	1	4	0	0	0	0	0	0	1	2	0	17	76
8:15 AM	0	0	7	3	0	1	7	0	0	0	0	0	0	0	5	0	23	86
8:30 AM	0	0	7	1	0	1	4	0	0	0	0	0	0	0	6	0	19	85
8:45 AM	0	0	7	2	0	1	6	0	0	0	0	0	0	1	5	0	22	81
Count Total	0	0	51	11	0	12	44	0	0	0	0	0	0	6	27	0	151	0
Peak Hour	0	0	25	4	0	9	23	0	0	0	0	0	0	5	10	0	76	0

Two-Hour Count Summaries - Bikes														
Interval Start	W San Fernando St			W San Fernando St			S Montgomery St			S Montgomery St			15-min Total	Rolling One Hour
	Eastbound			Westbound			Northbound			Southbound				
	LT	TH	RT	LT	TH	RT	LT	TH	RT	LT	TH	RT		
7:00 AM	0	0	0	1	5	0	0	0	0	0	0	0	6	0
7:15 AM	0	0	0	1	7	0	0	0	0	0	0	0	8	0
7:30 AM	0	2	0	0	19	0	0	0	0	1	0	0	22	0
7:45 AM	0	0	0	0	6	0	0	0	0	0	0	0	6	42
8:00 AM	0	6	1	1	8	0	0	0	0	3	0	0	19	55
8:15 AM	0	2	1	0	6	1	0	0	0	1	2	0	13	60
8:30 AM	0	9	0	0	3	0	0	1	0	3	1	0	17	55
8:45 AM	0	4	0	1	1	2	0	0	0	0	1	0	9	58
Count Total	0	23	2	4	55	3	0	1	0	8	4	0	100	0
Peak Hour	0	8	1	2	40	0	0	0	0	4	0	0	55	0

Note: U-Turn volumes for bikes are included in Left-Turn, if any.

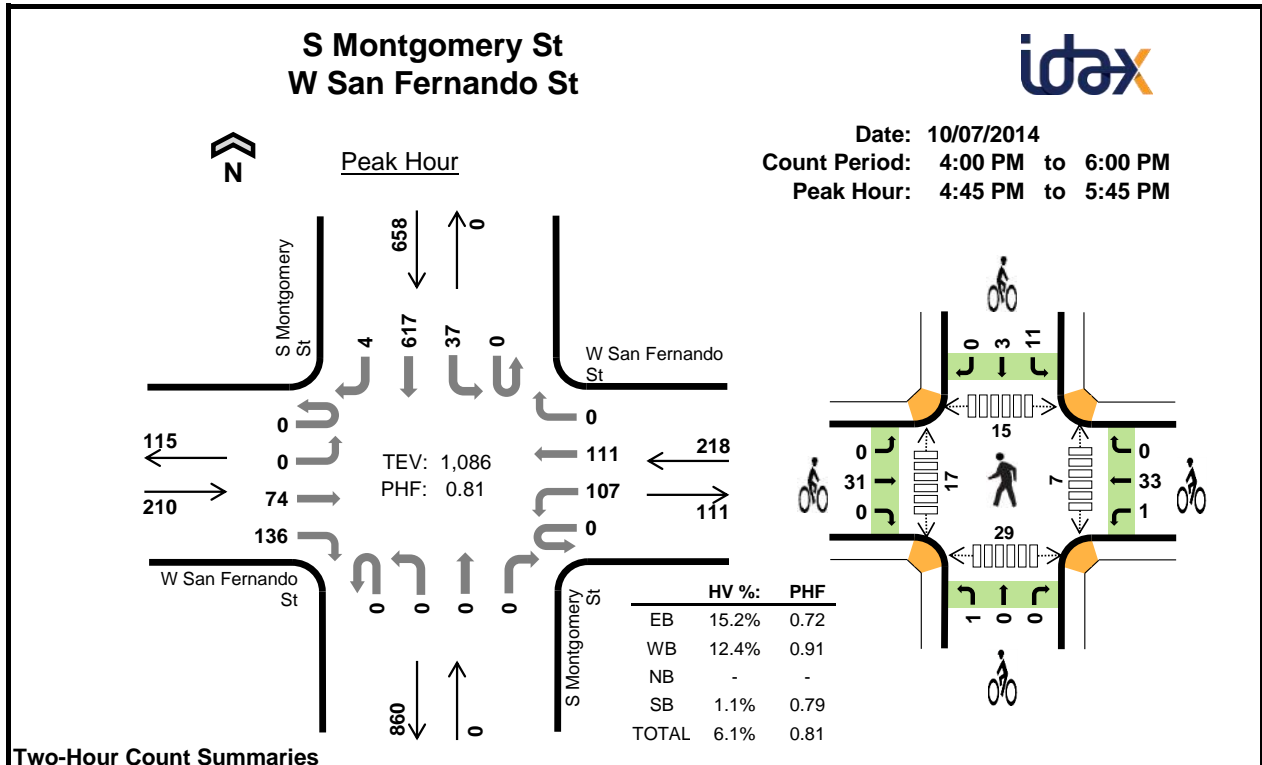

Two-Hour Count Summaries

Interval Start	W San Fernando St Eastbound				W San Fernando St Westbound				S Montgomery St Northbound				S Montgomery St Southbound				15-min Total	Rolling One Hour	
	UT	LT	TH	RT	UT	LT	TH	RT	UT	LT	TH	RT	UT	LT	TH	RT			
4:00 PM	0	0	12	24	0	21	21	0	0	0	0	0	0	3	86	0	167	0	
4:15 PM	0	0	8	24	0	28	16	0	0	0	0	0	0	6	71	5	158	0	
4:30 PM	0	0	9	17	0	19	25	0	0	1	0	0	0	8	82	3	164	0	
4:45 PM	0	0	15	22	0	22	26	0	0	0	0	0	0	2	89	0	176	665	
5:00 PM	0	0	16	21	0	30	28	0	0	0	0	0	0	9	145	1	250	748	
5:15 PM	0	0	21	42	0	35	25	0	0	0	0	0	0	11	191	1	326	916	
5:30 PM	0	0	22	51	0	20	32	0	0	0	0	0	0	15	192	2	334	1,086	
5:45 PM	0	0	9	13	0	22	22	0	0	0	0	0	0	10	97	3	176	1,086	
Count Total	0	0	112	214	0	197	195	0	0	1	0	0	0	64	953	15	1,751	0	
Peak Hour	All	0	0	74	136	0	107	111	0	0	0	0	0	0	37	617	4	1,086	0
	HV	0	0	24	8	0	3	24	0	0	0	0	0	0	2	5	0	66	0
	HV%	-	-	32%	6%	-	3%	22%	-	-	-	-	-	-	5%	1%	0%	6%	0

Note: Two-hour count summary volumes include heavy vehicles but exclude bicycles in overall count.

Interval Start	Heavy Vehicle Totals					Bicycles					Pedestrians (Crossing Leg)				
	EB	WB	NB	SB	Total	EB	WB	NB	SB	Total	East	West	North	South	Total
4:00 PM	8	7	0	1	16	6	9	0	3	18	1	0	1	3	5
4:15 PM	5	8	0	5	18	2	11	0	2	15	0	1	0	6	7
4:30 PM	6	6	0	2	14	1	4	1	2	8	1	3	1	3	8
4:45 PM	11	7	0	1	19	0	2	0	0	2	3	1	3	2	9
5:00 PM	6	6	0	3	15	7	5	0	4	16	1	3	3	4	11
5:15 PM	7	9	0	1	17	4	15	1	4	24	0	4	0	6	10
5:30 PM	8	5	0	2	15	20	12	0	6	38	3	9	9	17	38
5:45 PM	10	5	0	1	16	0	4	0	1	5	0	0	0	1	1
Count Total	61	53	0	16	130	40	62	2	22	126	9	21	17	42	89
Peak Hour	32	27	0	7	66	31	34	1	14	80	7	17	15	29	68

Two-Hour Count Summaries - Heavy Vehicles																		
Interval Start	W San Fernando St				W San Fernando St				S Montgomery St				S Montgomery St				15-min Total	Rolling One Hour
	Eastbound				Westbound				Northbound				Southbound					
	UT	LT	TH	RT	UT	LT	TH	RT	UT	LT	TH	RT	UT	LT	TH	RT		
4:00 PM	0	0	7	1	0	0	7	0	0	0	0	0	0	0	1	0	16	0
4:15 PM	0	0	4	1	0	2	6	0	0	0	0	0	0	1	4	0	18	0
4:30 PM	0	0	6	0	0	0	6	0	0	0	0	0	0	0	2	0	14	0
4:45 PM	0	0	8	3	0	0	7	0	0	0	0	0	0	0	1	0	19	67
5:00 PM	0	0	5	1	0	2	4	0	0	0	0	0	0	1	2	0	15	66
5:15 PM	0	0	5	2	0	1	8	0	0	0	0	0	0	0	1	0	17	65
5:30 PM	0	0	6	2	0	0	5	0	0	0	0	0	0	1	1	0	15	66
5:45 PM	0	0	6	4	0	1	4	0	0	0	0	0	0	0	1	0	16	63
Count Total	0	0	47	14	0	6	47	0	0	0	0	0	3	13	0	130	0	
Peak Hour	0	0	24	8	0	3	24	0	0	0	0	0	2	5	0	66	0	
Two-Hour Count Summaries - Bikes																		
Interval Start	W San Fernando St			W San Fernando St			S Montgomery St			S Montgomery St			15-min Total	Rolling One Hour				
	Eastbound			Westbound			Northbound			Southbound								
	LT	TH	RT	LT	TH	RT	LT	TH	RT	LT	TH	RT						
4:00 PM	0	6	0	1	8	0	0	0	0	1	2	0	18	0				
4:15 PM	0	1	1	1	10	0	0	0	0	0	2	0	15	0				
4:30 PM	0	1	0	1	3	0	0	1	0	0	2	0	8	0				
4:45 PM	0	0	0	0	2	0	0	0	0	0	0	0	2	43				
5:00 PM	0	7	0	0	5	0	0	0	0	2	2	0	16	41				
5:15 PM	0	4	0	1	14	0	1	0	0	4	0	0	24	50				
5:30 PM	0	20	0	0	12	0	0	0	0	5	1	0	38	80				
5:45 PM	0	0	0	2	2	0	0	0	0	0	1	0	5	83				
Count Total	0	39	1	6	56	0	1	1	0	12	10	0	126	0				
Peak Hour	0	31	0	1	33	0	1	0	0	11	3	0	80	0				
<i>Note: U-Turn volumes for bikes are included in Left-Turn, if any.</i>																		

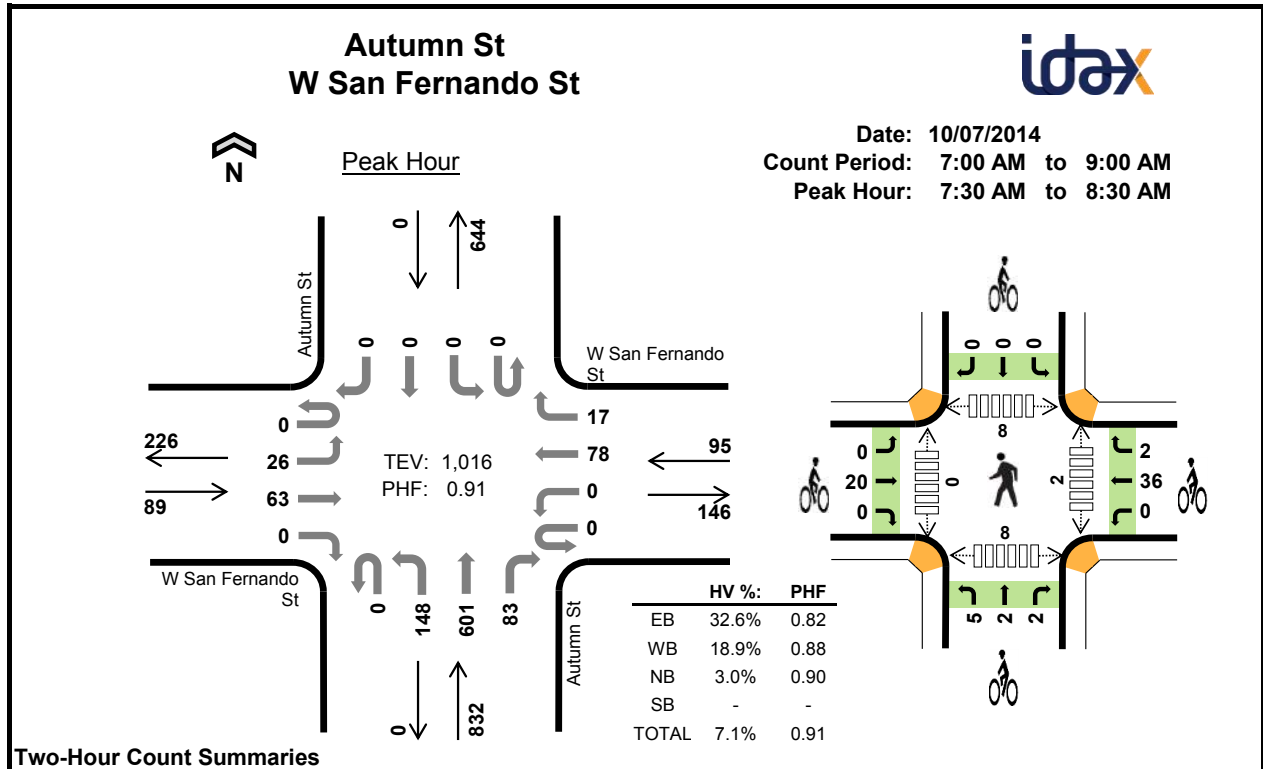

Two-Hour Count Summaries

Interval Start	W San Fernando St Eastbound				W San Fernando St Westbound				Autumn St Northbound				Autumn St Southbound				15-min Total	Rolling One Hour	
	UT	LT	TH	RT	UT	LT	TH	RT	UT	LT	TH	RT	UT	LT	TH	RT			
7:00 AM	0	5	6	0	0	0	13	2	0	25	61	4	0	0	0	0	116	0	
7:15 AM	0	1	6	0	0	0	19	1	0	42	83	13	0	0	0	0	165	0	
7:30 AM	0	7	20	0	0	0	23	3	0	55	120	8	0	0	0	0	236	0	
7:45 AM	0	8	14	0	0	0	21	6	0	33	156	24	0	0	0	0	262	779	
8:00 AM	0	6	16	0	0	0	23	4	0	34	178	19	0	0	0	0	280	943	
8:15 AM	0	5	13	0	0	0	11	4	0	26	147	32	0	0	0	0	238	1,016	
8:30 AM	0	6	15	0	0	0	16	7	0	25	119	30	0	0	0	0	218	998	
8:45 AM	0	5	11	0	0	0	15	3	0	25	127	36	0	0	0	0	222	958	
Count Total	0	43	101	0	0	0	141	30	0	265	991	166	0	0	0	0	1,737	0	
Peak Hour	All	0	26	63	0	0	0	78	17	0	148	601	83	0	0	0	0	1,016	0
	HV	0	6	23	0	0	0	18	0	0	11	9	5	0	0	0	0	72	0
	HV%	-	23%	37%	-	-	-	23%	0%	-	7%	1%	6%	-	-	-	-	7%	0

Note: Two-hour count summary volumes include heavy vehicles but exclude bicycles in overall count.

Interval Start	Heavy Vehicle Totals					Bicycles					Pedestrians (Crossing Leg)				
	EB	WB	NB	SB	Total	EB	WB	NB	SB	Total	East	West	North	South	Total
7:00 AM	4	2	1	0	7	0	6	2	1	9	1	0	0	1	2
7:15 AM	6	6	8	0	20	0	8	2	0	10	2	0	1	1	4
7:30 AM	7	3	3	0	13	6	20	3	0	29	0	0	2	1	3
7:45 AM	6	7	8	0	21	1	5	1	0	7	0	0	3	3	6
8:00 AM	9	4	8	0	21	9	8	4	0	21	2	0	3	3	8
8:15 AM	7	4	6	0	17	4	5	1	0	10	0	0	0	1	1
8:30 AM	7	3	3	0	13	12	3	0	0	15	1	0	4	3	8
8:45 AM	7	3	9	0	19	4	3	2	0	9	1	0	2	4	7
Count Total	53	32	46	0	131	36	58	15	1	110	7	0	15	17	39
Peak Hour	29	18	25	0	72	20	38	9	0	67	2	0	8	8	18

Two-Hour Count Summaries - Heavy Vehicles																		
Interval Start	W San Fernando St				W San Fernando St				Autumn St				Autumn St				15-min Total	Rolling One Hour
	Eastbound				Westbound				Northbound				Southbound					
	UT	LT	TH	RT	UT	LT	TH	RT	UT	LT	TH	RT	UT	LT	TH	RT		
7:00 AM	0	1	3	0	0	0	2	0	0	1	0	0	0	0	0	0	7	0
7:15 AM	0	1	5	0	0	0	6	0	0	3	5	0	0	0	0	0	20	0
7:30 AM	0	1	6	0	0	0	3	0	0	2	0	1	0	0	0	0	13	0
7:45 AM	0	1	5	0	0	0	7	0	0	3	4	1	0	0	0	0	21	61
8:00 AM	0	3	6	0	0	0	4	0	0	3	3	2	0	0	0	0	21	75
8:15 AM	0	1	6	0	0	0	4	0	0	3	2	1	0	0	0	0	17	72
8:30 AM	0	2	5	0	0	0	3	0	0	2	1	0	0	0	0	0	13	72
8:45 AM	0	1	6	0	0	0	3	0	0	5	3	1	0	0	0	0	19	70
Count Total	0	11	42	0	0	0	32	0	0	22	18	6	0	0	0	0	131	0
Peak Hour	0	6	23	0	0	0	18	0	0	11	9	5	0	0	0	0	72	0

Two-Hour Count Summaries - Bikes														
Interval Start	W San Fernando St			W San Fernando St			Autumn St			Autumn St			15-min Total	Rolling One Hour
	Eastbound			Westbound			Northbound			Southbound				
	LT	TH	RT	LT	TH	RT	LT	TH	RT	LT	TH	RT		
7:00 AM	0	0	0	0	6	0	0	1	1	1	0	0	9	0
7:15 AM	0	0	0	0	8	0	2	0	0	0	0	0	10	0
7:30 AM	0	6	0	0	18	2	1	1	1	0	0	0	29	0
7:45 AM	0	1	0	0	5	0	1	0	0	0	0	0	7	55
8:00 AM	0	9	0	0	8	0	2	1	1	0	0	0	21	67
8:15 AM	0	4	0	0	5	0	1	0	0	0	0	0	10	67
8:30 AM	0	12	0	0	3	0	0	0	0	0	0	0	15	53
8:45 AM	0	4	0	0	3	0	0	1	1	0	0	0	9	55
Count Total	0	36	0	0	56	2	7	4	4	1	0	0	110	0
Peak Hour	0	20	0	0	36	2	5	2	2	0	0	0	67	0

Note: U-Turn volumes for bikes are included in Left-Turn, if any.

Autumn St W San Fernando St



Date: 10/07/2014
Count Period: 4:00 PM to 6:00 PM
Peak Hour: 5:00 PM to 6:00 PM

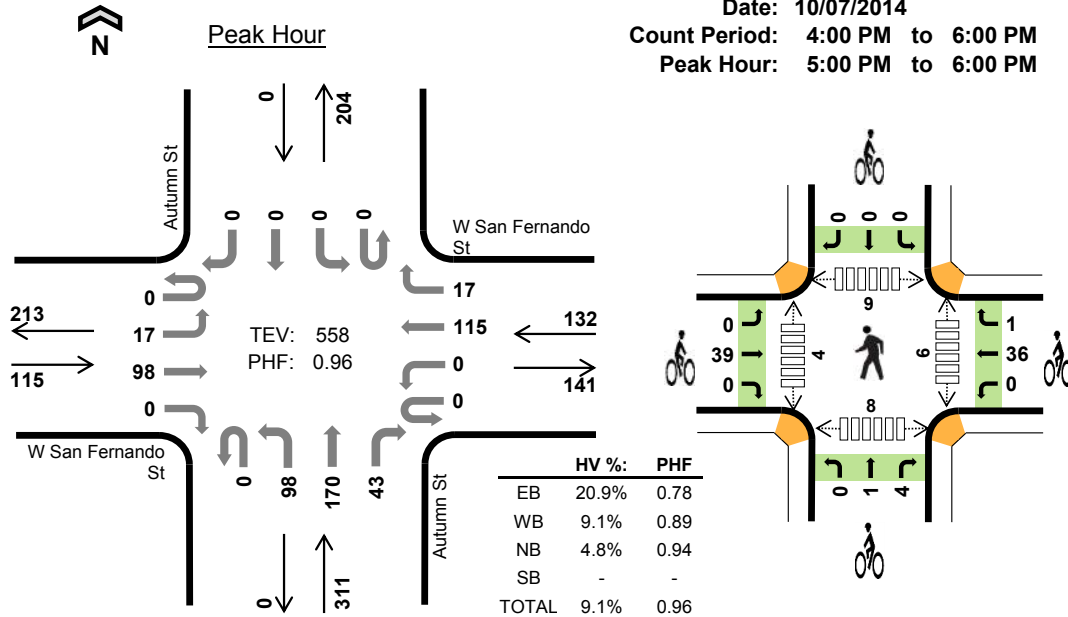

Two-Hour Count Summaries

Interval Start	W San Fernando St Eastbound				W San Fernando St Westbound				Autumn St Northbound				Autumn St Southbound				15-min Total	Rolling One Hour	
	UT	LT	TH	RT	UT	LT	TH	RT	UT	LT	TH	RT	UT	LT	TH	RT			
4:00 PM	0	4	9	0	0	0	20	4	0	21	38	5	0	0	0	0	101	0	
4:15 PM	0	3	10	0	0	0	27	0	0	16	48	7	0	0	0	0	111	0	
4:30 PM	0	2	17	0	0	0	26	2	0	20	38	8	0	0	0	0	113	0	
4:45 PM	0	6	10	0	0	0	29	3	0	18	45	8	0	0	0	0	119	444	
5:00 PM	0	4	20	0	0	0	34	3	0	29	45	9	0	0	0	0	144	487	
5:15 PM	0	6	30	0	0	0	32	3	0	20	45	10	0	0	0	0	146	522	
5:30 PM	0	4	33	0	0	0	22	4	0	30	31	20	0	0	0	0	144	553	
5:45 PM	0	3	15	0	0	0	27	7	0	19	49	4	0	0	0	0	124	558	
Count Total	0	32	144	0	0	0	217	26	0	173	339	71	0	0	0	0	1,002	0	
Peak Hour	All	0	17	98	0	0	0	115	17	0	98	170	43	0	0	0	0	558	0
	HV	0	5	19	0	0	0	11	1	0	12	2	1	0	0	0	0	51	0
	HV%	-	29%	19%	-	-	-	10%	6%	-	12%	1%	2%	-	-	-	-	9%	0

Note: Two-hour count summary volumes include heavy vehicles but exclude bicycles in overall count.

Interval Start	Heavy Vehicle Totals					Bicycles					Pedestrians (Crossing Leg)				
	EB	WB	NB	SB	Total	EB	WB	NB	SB	Total	East	West	North	South	Total
4:00 PM	5	4	6	0	15	2	11	1	3	17	1	2	2	2	7
4:15 PM	5	3	6	0	14	1	10	2	0	13	0	0	1	4	5
4:30 PM	6	4	3	0	13	1	4	2	0	7	2	1	1	3	7
4:45 PM	7	5	3	0	15	0	2	0	0	2	0	0	1	2	3
5:00 PM	5	2	6	0	13	7	8	1	0	16	3	0	4	4	11
5:15 PM	6	6	3	0	15	7	17	1	0	25	0	0	1	0	1
5:30 PM	7	1	4	0	12	25	11	2	0	38	2	1	4	2	9
5:45 PM	6	3	2	0	11	0	1	1	0	2	1	3	0	2	6
Count Total	47	28	33	0	108	43	64	10	3	120	9	7	14	19	49
Peak Hour	24	12	15	0	51	39	37	5	0	81	6	4	9	8	27

Two-Hour Count Summaries - Heavy Vehicles																		
Interval Start	W San Fernando St				W San Fernando St				Autumn St				Autumn St				15-min Total	Rolling One Hour
	Eastbound				Westbound				Northbound				Southbound					
	UT	LT	TH	RT	UT	LT	TH	RT	UT	LT	TH	RT	UT	LT	TH	RT		
4:00 PM	0	3	2	0	0	0	4	0	0	4	2	0	0	0	0	0	15	0
4:15 PM	0	1	4	0	0	0	3	0	0	4	2	0	0	0	0	0	14	0
4:30 PM	0	1	5	0	0	0	4	0	0	3	0	0	0	0	0	0	13	0
4:45 PM	0	3	4	0	0	0	4	1	0	2	1	0	0	0	0	0	15	57
5:00 PM	0	1	4	0	0	0	2	0	0	4	1	1	0	0	0	0	13	55
5:15 PM	0	1	5	0	0	0	5	1	0	2	1	0	0	0	0	0	15	56
5:30 PM	0	2	5	0	0	0	1	0	0	4	0	0	0	0	0	0	12	55
5:45 PM	0	1	5	0	0	0	3	0	0	2	0	0	0	0	0	0	11	51
Count Total	0	13	34	0	0	0	26	2	0	25	7	1	0	0	0	0	108	0
Peak Hour	0	5	19	0	0	0	11	1	0	12	2	1	0	0	0	0	51	0

Two-Hour Count Summaries - Bikes														
Interval Start	W San Fernando St			W San Fernando St			Autumn St			Autumn St			15-min Total	Rolling One Hour
	Eastbound			Westbound			Northbound			Southbound				
	LT	TH	RT	LT	TH	RT	LT	TH	RT	LT	TH	RT		
4:00 PM	0	2	0	0	10	1	0	1	0	0	3	0	17	0
4:15 PM	0	1	0	0	10	0	0	1	1	0	0	0	13	0
4:30 PM	1	0	0	0	4	0	0	1	1	0	0	0	7	0
4:45 PM	0	0	0	0	2	0	0	0	0	0	0	0	2	39
5:00 PM	0	7	0	0	8	0	0	1	0	0	0	0	16	38
5:15 PM	0	7	0	0	16	1	0	0	1	0	0	0	25	50
5:30 PM	0	25	0	0	11	0	0	0	2	0	0	0	38	81
5:45 PM	0	0	0	0	1	0	0	0	1	0	0	0	2	81
Count Total	1	42	0	0	62	2	0	4	6	0	3	0	120	0
Peak Hour	0	39	0	0	36	1	0	1	4	0	0	0	81	0

Note: U-Turn volumes for bikes are included in Left-Turn, if any.

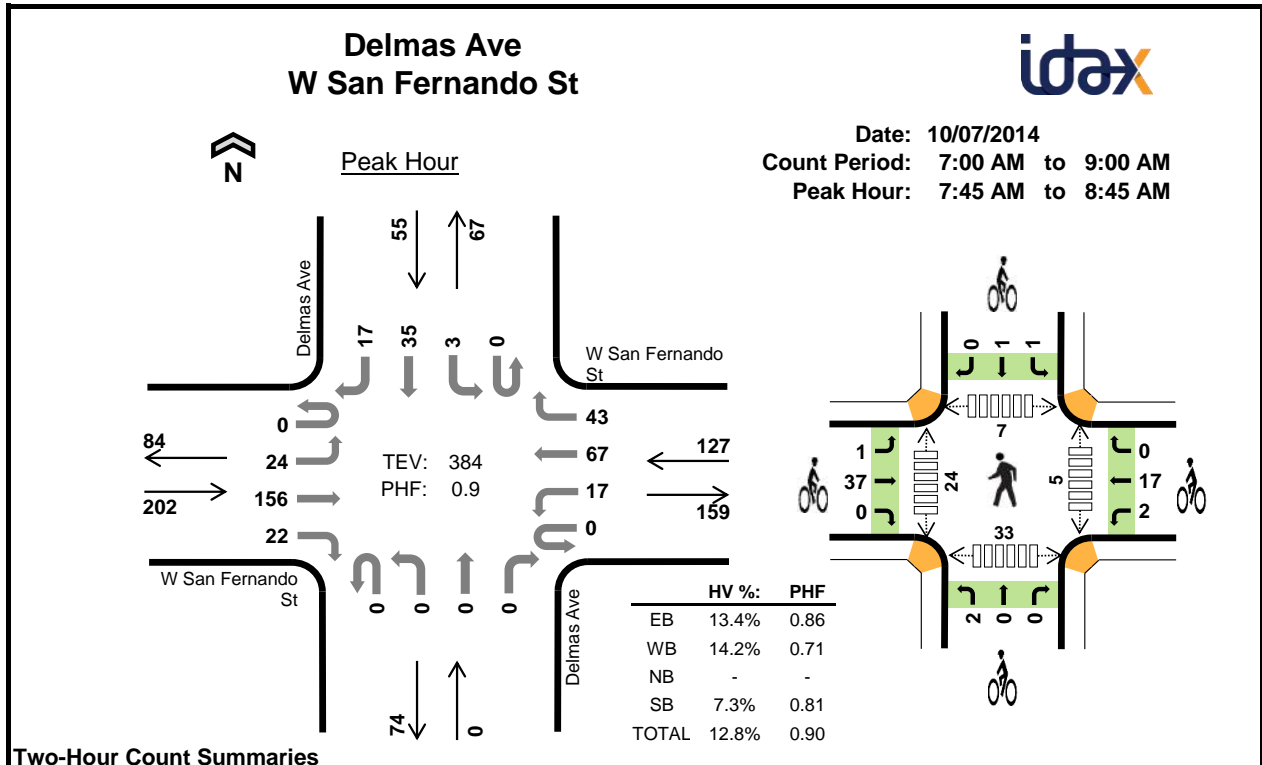

Two-Hour Count Summaries

Interval Start	W San Fernando St Eastbound				W San Fernando St Westbound				Delmas Ave Northbound				Delmas Ave Southbound				15-min Total	Rolling One Hour	
	UT	LT	TH	RT	UT	LT	TH	RT	UT	LT	TH	RT	UT	LT	TH	RT			
7:00 AM	0	0	9	7	0	1	13	3	0	0	0	0	0	1	3	1	38	0	
7:15 AM	0	0	13	0	0	0	7	5	0	0	0	0	0	0	4	1	30	0	
7:30 AM	0	3	27	5	0	2	26	5	0	0	0	0	0	1	8	1	78	0	
7:45 AM	0	4	32	6	0	4	24	12	0	0	0	0	0	0	11	5	98	244	
8:00 AM	0	7	35	5	0	7	20	18	0	0	0	0	0	1	8	6	107	313	
8:15 AM	0	12	42	5	0	0	7	8	0	0	0	0	0	1	13	3	91	374	
8:30 AM	0	1	47	6	0	6	16	5	0	0	0	0	0	1	3	3	88	384	
8:45 AM	0	2	46	2	0	9	13	9	0	0	0	0	0	0	11	1	93	379	
Count Total	0	29	251	36	0	29	126	65	0	0	0	0	0	5	61	21	623	0	
Peak Hour	All	0	24	156	22	0	17	67	43	0	0	0	0	0	3	35	17	384	0
	HV	0	0	21	6	0	0	18	0	0	0	0	0	0	0	4	0	49	0
	HV%	-	0%	13%	27%	-	0%	27%	0%	-	-	-	-	-	0%	11%	0%	13%	0

Note: Two-hour count summary volumes include heavy vehicles but exclude bicycles in overall count.

Interval Start	Heavy Vehicle Totals					Bicycles					Pedestrians (Crossing Leg)				
	EB	WB	NB	SB	Total	EB	WB	NB	SB	Total	East	West	North	South	Total
7:00 AM	3	3	0	0	6	2	6	1	1	10	2	5	0	6	13
7:15 AM	5	1	0	1	7	1	6	0	0	7	0	4	0	1	5
7:30 AM	7	4	0	0	11	6	20	1	1	28	0	14	3	5	22
7:45 AM	5	9	0	2	16	6	5	1	0	12	2	8	3	9	22
8:00 AM	6	2	0	1	9	10	4	0	2	16	1	3	1	10	15
8:15 AM	10	4	0	1	15	11	5	1	0	17	2	7	2	9	20
8:30 AM	6	3	0	0	9	11	5	0	0	16	0	6	1	5	12
8:45 AM	5	3	0	0	8	8	3	0	1	12	0	11	2	11	24
Count Total	47	29	0	5	81	55	54	4	5	118	7	58	12	56	133
Peak Hour	27	18	0	4	49	38	19	2	2	61	5	24	7	33	69

Two-Hour Count Summaries - Heavy Vehicles																		
Interval Start	W San Fernando St				W San Fernando St				Delmas Ave				Delmas Ave				15-min Total	Rolling One Hour
	Eastbound				Westbound				Northbound				Southbound					
	UT	LT	TH	RT	UT	LT	TH	RT	UT	LT	TH	RT	UT	LT	TH	RT		
7:00 AM	0	0	3	0	0	0	3	0	0	0	0	0	0	0	0	0	6	0
7:15 AM	0	0	5	0	0	0	1	0	0	0	0	0	0	0	1	0	7	0
7:30 AM	0	0	6	1	0	0	4	0	0	0	0	0	0	0	0	0	11	0
7:45 AM	0	0	4	1	0	0	9	0	0	0	0	0	0	0	2	0	16	40
8:00 AM	0	0	5	1	0	0	2	0	0	0	0	0	0	0	1	0	9	43
8:15 AM	0	0	7	3	0	0	4	0	0	0	0	0	0	0	1	0	15	51
8:30 AM	0	0	5	1	0	0	3	0	0	0	0	0	0	0	0	0	9	49
8:45 AM	0	0	5	0	0	0	3	0	0	0	0	0	0	0	0	0	8	41
Count Total	0	0	40	7	0	0	29	0	0	0	0	0	0	0	5	0	81	0
Peak Hour	0	0	21	6	0	0	18	0	0	0	0	0	0	0	4	0	49	0

Two-Hour Count Summaries - Bikes														
Interval Start	W San Fernando St			W San Fernando St			Delmas Ave			Delmas Ave			15-min Total	Rolling One Hour
	Eastbound			Westbound			Northbound			Southbound				
	LT	TH	RT	LT	TH	RT	LT	TH	RT	LT	TH	RT		
7:00 AM	0	2	0	0	6	0	0	0	1	1	0	0	10	0
7:15 AM	0	1	0	0	4	2	0	0	0	0	0	0	7	0
7:30 AM	0	5	1	0	19	1	0	1	0	1	0	0	28	0
7:45 AM	0	6	0	1	4	0	1	0	0	0	0	0	12	57
8:00 AM	0	10	0	0	4	0	0	0	0	1	1	0	16	63
8:15 AM	1	10	0	0	5	0	1	0	0	0	0	0	17	73
8:30 AM	0	11	0	1	4	0	0	0	0	0	0	0	16	61
8:45 AM	1	7	0	0	2	1	0	0	0	1	0	0	12	61
Count Total	2	52	1	2	48	4	2	1	1	4	1	0	118	0
Peak Hour	1	37	0	2	17	0	2	0	0	1	1	0	61	0

Note: U-Turn volumes for bikes are included in Left-Turn, if any.

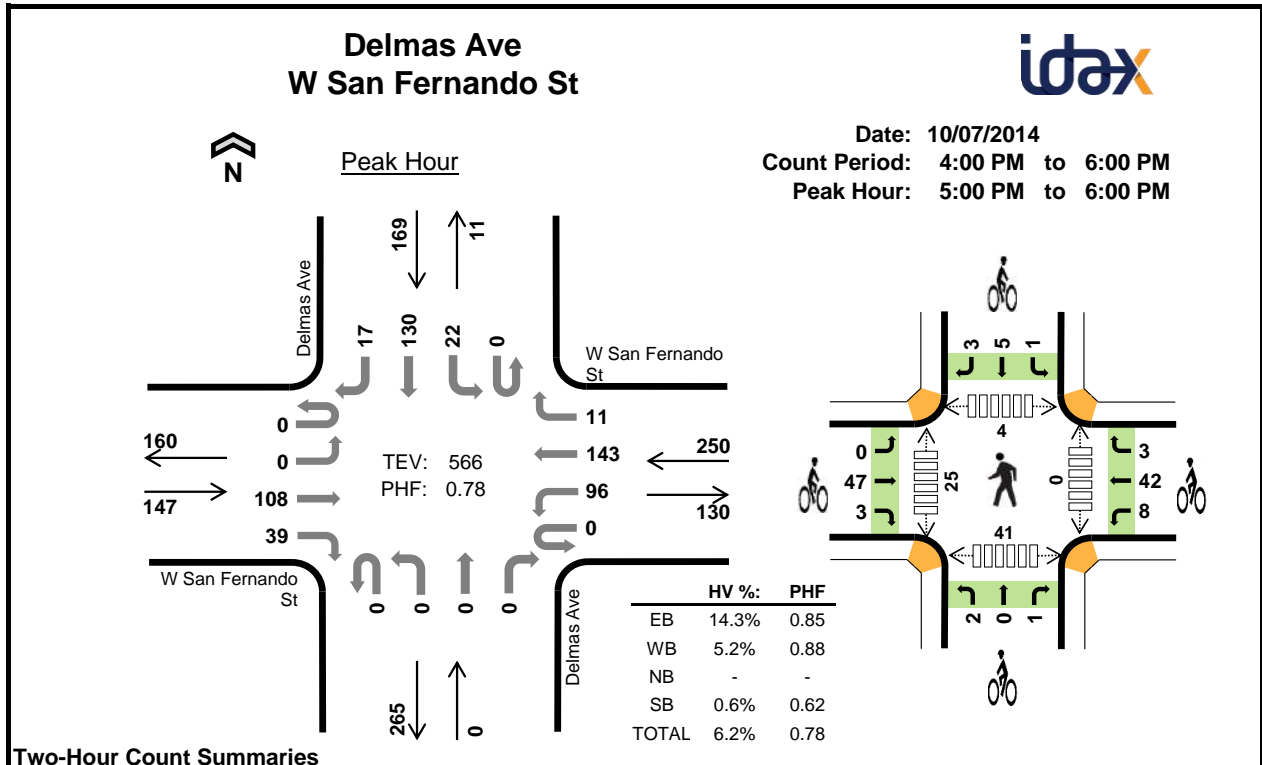

Two-Hour Count Summaries

Interval Start	W San Fernando St Eastbound				W San Fernando St Westbound				Delmas Ave Northbound				Delmas Ave Southbound				15-min Total	Rolling One Hour	
	UT	LT	TH	RT	UT	LT	TH	RT	UT	LT	TH	RT	UT	LT	TH	RT			
4:00 PM	0	1	16	5	0	14	18	2	0	0	0	0	0	4	19	3	82	0	
4:15 PM	0	2	11	4	0	16	37	2	0	0	0	0	0	3	27	3	105	0	
4:30 PM	0	3	14	7	0	14	20	2	0	0	0	0	0	2	23	3	88	0	
4:45 PM	0	0	22	6	0	18	33	4	0	0	0	0	0	1	23	2	109	384	
5:00 PM	0	0	21	7	0	27	36	3	0	0	0	0	0	5	27	2	128	430	
5:15 PM	0	0	32	11	0	26	44	1	0	0	0	0	0	10	49	9	182	507	
5:30 PM	0	0	26	12	0	22	28	4	0	0	0	0	0	5	24	2	123	542	
5:45 PM	0	0	29	9	0	21	35	3	0	0	0	0	0	2	30	4	133	566	
Count Total	0	6	171	61	0	158	251	21	0	0	0	0	0	32	222	28	950	0	
Peak Hour	All	0	0	108	39	0	96	143	11	0	0	0	0	0	22	130	17	566	0
	HV	0	0	19	2	0	0	13	0	0	0	0	0	0	0	1	0	35	0
	HV%	-	-	18%	5%	-	0%	9%	0%	-	-	-	-	-	0%	1%	0%	6%	0

Note: Two-hour count summary volumes include heavy vehicles but exclude bicycles in overall count.

Interval Start	Heavy Vehicle Totals					Bicycles					Pedestrians (Crossing Leg)				
	EB	WB	NB	SB	Total	EB	WB	NB	SB	Total	East	West	North	South	Total
4:00 PM	5	5	0	0	10	3	7	2	1	13	0	10	1	3	14
4:15 PM	5	5	0	0	10	1	12	1	1	15	0	6	2	4	12
4:30 PM	6	2	0	0	8	4	6	0	0	10	0	11	0	12	23
4:45 PM	4	6	0	1	11	0	3	0	1	4	0	7	2	5	14
5:00 PM	6	2	0	1	9	6	6	0	1	13	0	7	2	16	25
5:15 PM	4	7	0	0	11	12	19	0	1	32	0	3	0	9	12
5:30 PM	6	1	0	0	7	25	20	2	4	51	0	12	1	8	21
5:45 PM	5	3	0	0	8	7	8	1	3	19	0	3	1	8	12
Count Total	41	31	0	2	74	58	81	6	12	157	0	59	9	65	133
Peak Hour	21	13	0	1	35	50	53	3	9	115	0	25	4	41	70

Two-Hour Count Summaries - Heavy Vehicles																		
Interval Start	W San Fernando St				W San Fernando St				Delmas Ave				Delmas Ave				15-min Total	Rolling One Hour
	Eastbound				Westbound				Northbound				Southbound					
	UT	LT	TH	RT	UT	LT	TH	RT	UT	LT	TH	RT	UT	LT	TH	RT		
4:00 PM	0	0	5	0	0	0	5	0	0	0	0	0	0	0	0	0	10	0
4:15 PM	0	0	5	0	0	1	4	0	0	0	0	0	0	0	0	0	10	0
4:30 PM	0	0	6	0	0	0	2	0	0	0	0	0	0	0	0	0	8	0
4:45 PM	0	0	4	0	0	0	6	0	0	0	0	0	0	0	1	0	11	39
5:00 PM	0	0	5	1	0	0	2	0	0	0	0	0	0	0	1	0	9	38
5:15 PM	0	0	4	0	0	0	7	0	0	0	0	0	0	0	0	0	11	39
5:30 PM	0	0	5	1	0	0	1	0	0	0	0	0	0	0	0	0	7	38
5:45 PM	0	0	5	0	0	0	3	0	0	0	0	0	0	0	0	0	8	35
Count Total	0	0	39	2	0	1	30	0	0	0	0	0	0	0	2	0	74	0
Peak Hour	0	0	19	2	0	0	13	0	0	0	0	0	0	0	1	0	35	0

Two-Hour Count Summaries - Bikes														
Interval Start	W San Fernando St			W San Fernando St			Delmas Ave			Delmas Ave			15-min Total	Rolling One Hour
	Eastbound			Westbound			Northbound			Southbound				
	LT	TH	RT	LT	TH	RT	LT	TH	RT	LT	TH	RT		
4:00 PM	0	3	0	0	7	0	0	2	0	0	1	0	13	0
4:15 PM	0	1	0	0	11	1	0	0	1	0	1	0	15	0
4:30 PM	0	1	3	0	6	0	0	0	0	0	0	0	10	0
4:45 PM	0	0	0	0	2	1	0	0	0	1	0	0	4	42
5:00 PM	0	6	0	1	5	0	0	0	0	0	0	1	13	42
5:15 PM	0	9	3	2	17	0	0	0	0	0	1	0	32	59
5:30 PM	0	25	0	2	16	2	2	0	0	1	3	0	51	100
5:45 PM	0	7	0	3	4	1	0	0	1	0	1	2	19	115
Count Total	0	52	6	8	68	5	2	2	2	2	7	3	157	0
Peak Hour	0	47	3	8	42	3	2	0	1	1	5	3	115	0

Note: U-Turn volumes for bikes are included in Left-Turn, if any.

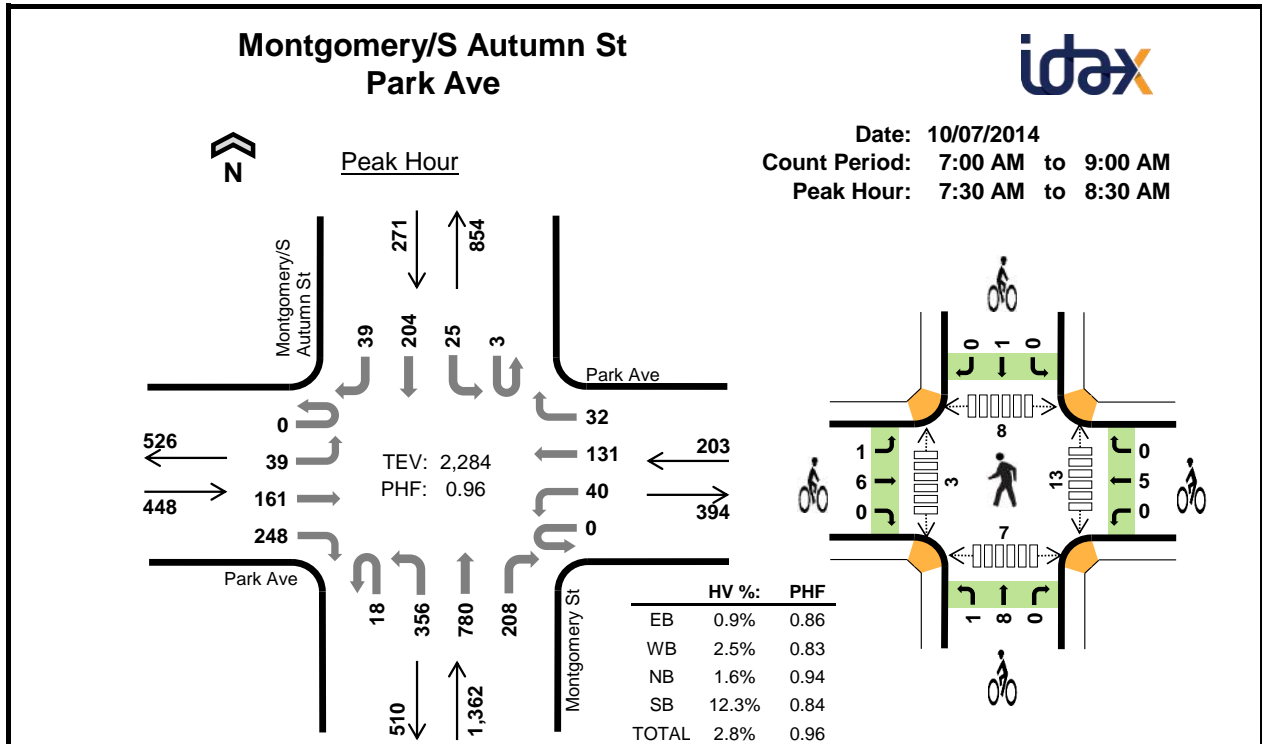

Two-Hour Count Summaries

Interval Start	Park Ave Eastbound				Park Ave Westbound				Montgomery St Northbound				Montgomery/S Autumn St Southbound				15-min Total	Rolling One Hour	
	UT	LT	TH	RT	UT	LT	TH	RT	UT	LT	TH	RT	UT	LT	TH	RT			
7:00 AM	0	2	20	29	0	4	14	5	4	61	96	22	0	5	25	3	290	0	
7:15 AM	0	5	29	57	0	4	19	8	7	108	145	27	1	2	61	6	479	0	
7:30 AM	0	10	47	73	0	13	41	4	4	80	179	54	1	5	53	15	579	0	
7:45 AM	0	7	34	67	0	12	33	16	3	105	196	40	0	8	62	11	594	1,942	
8:00 AM	0	9	34	62	0	9	35	9	1	96	209	56	2	8	40	8	578	2,230	
8:15 AM	0	13	46	46	0	6	22	3	10	75	196	58	0	4	49	5	533	2,284	
8:30 AM	0	14	54	40	0	5	32	6	11	52	143	51	1	6	60	10	485	2,190	
8:45 AM	0	12	33	35	0	8	22	5	2	37	177	65	0	0	52	11	459	2,055	
Count Total	0	72	297	409	0	61	218	56	42	614	1341	373	5	38	402	69	3,997	0	
Peak Hour	All	0	39	161	248	0	40	131	32	18	356	780	208	3	25	204	39	2,284	0
	HV	0	1	1	2	0	1	3	1	0	2	18	1	0	5	26	2	63	0
	HV%	-	3%	1%	1%	-	3%	2%	3%	0%	1%	2%	0%	0%	20%	13%	5%	3%	0

Note: Two-hour count summary volumes include heavy vehicles but exclude bicycles in overall count.

Interval Start	Heavy Vehicle Totals					Bicycles					Pedestrians (Crossing Leg)				
	EB	WB	NB	SB	Total	EB	WB	NB	SB	Total	East	West	North	South	Total
7:00 AM	1	0	1	2	4	1	2	3	0	6	0	1	0	3	4
7:15 AM	4	0	8	3	15	0	0	2	0	2	5	5	1	3	14
7:30 AM	2	0	4	7	13	2	2	4	0	8	3	2	3	1	9
7:45 AM	1	2	7	13	23	2	1	2	0	5	2	0	2	4	8
8:00 AM	1	2	5	3	11	2	2	2	0	6	3	0	2	0	5
8:15 AM	0	1	5	10	16	1	0	1	1	3	5	1	1	2	9
8:30 AM	1	1	2	6	10	0	2	0	0	2	0	2	0	0	2
8:45 AM	1	1	9	6	17	1	4	2	1	8	8	3	2	8	21
Count Total	11	7	41	50	109	9	13	16	2	40	26	14	11	21	72
Peak Hour	4	5	21	33	63	7	5	9	1	22	13	3	8	7	31

Two-Hour Count Summaries - Heavy Vehicles																		
Interval Start	Park Ave				Park Ave				Montgomery St				Montgomery/S Autumn St				15-min Total	Rolling One Hour
	Eastbound				Westbound				Northbound				Southbound					
	UT	LT	TH	RT	UT	LT	TH	RT	UT	LT	TH	RT	UT	LT	TH	RT		
7:00 AM	0	0	0	1	0	0	0	0	0	0	1	0	0	1	1	0	4	0
7:15 AM	0	0	4	0	0	0	0	0	1	0	7	0	0	0	3	0	15	0
7:30 AM	0	0	0	2	0	0	0	0	0	1	3	0	0	1	6	0	13	0
7:45 AM	0	0	1	0	0	0	1	1	0	1	5	1	0	1	10	2	23	55
8:00 AM	0	1	0	0	0	0	2	0	0	0	5	0	0	2	1	0	11	62
8:15 AM	0	0	0	0	0	1	0	0	0	0	5	0	0	1	9	0	16	63
8:30 AM	0	0	1	0	0	1	0	0	0	0	2	0	0	1	5	0	10	60
8:45 AM	0	0	0	1	0	1	0	0	0	1	8	0	0	0	5	1	17	54
Count Total	0	1	6	4	0	3	3	1	1	3	36	1	0	7	40	3	109	0
Peak Hour	0	1	1	2	0	1	3	1	0	2	18	1	0	5	26	2	63	0

Two-Hour Count Summaries - Bikes														
Interval Start	Park Ave			Park Ave			Montgomery St			Montgomery/S Autumn St			15-min Total	Rolling One Hour
	Eastbound			Westbound			Northbound			Southbound				
	LT	TH	RT	LT	TH	RT	LT	TH	RT	LT	TH	RT		
7:00 AM	1	0	0	0	2	0	1	2	0	0	0	0	6	0
7:15 AM	0	0	0	0	0	0	0	2	0	0	0	0	2	0
7:30 AM	1	1	0	0	2	0	1	3	0	0	0	0	8	0
7:45 AM	0	2	0	0	1	0	0	2	0	0	0	0	5	21
8:00 AM	0	2	0	0	2	0	0	2	0	0	0	0	6	21
8:15 AM	0	1	0	0	0	0	0	1	0	0	1	0	3	22
8:30 AM	0	0	0	0	2	0	0	0	0	0	0	0	2	16
8:45 AM	1	0	0	0	4	0	1	1	0	0	0	1	8	19
Count Total	3	6	0	0	13	0	3	13	0	0	1	1	40	0
Peak Hour	1	6	0	0	5	0	1	8	0	0	1	0	22	0

Note: U-Turn volumes for bikes are included in Left-Turn, if any.

Montgomery/S Autumn St Park Ave



Date: 10/07/2014
 Count Period: 4:00 PM to 6:00 PM
 Peak Hour: 5:00 PM to 6:00 PM

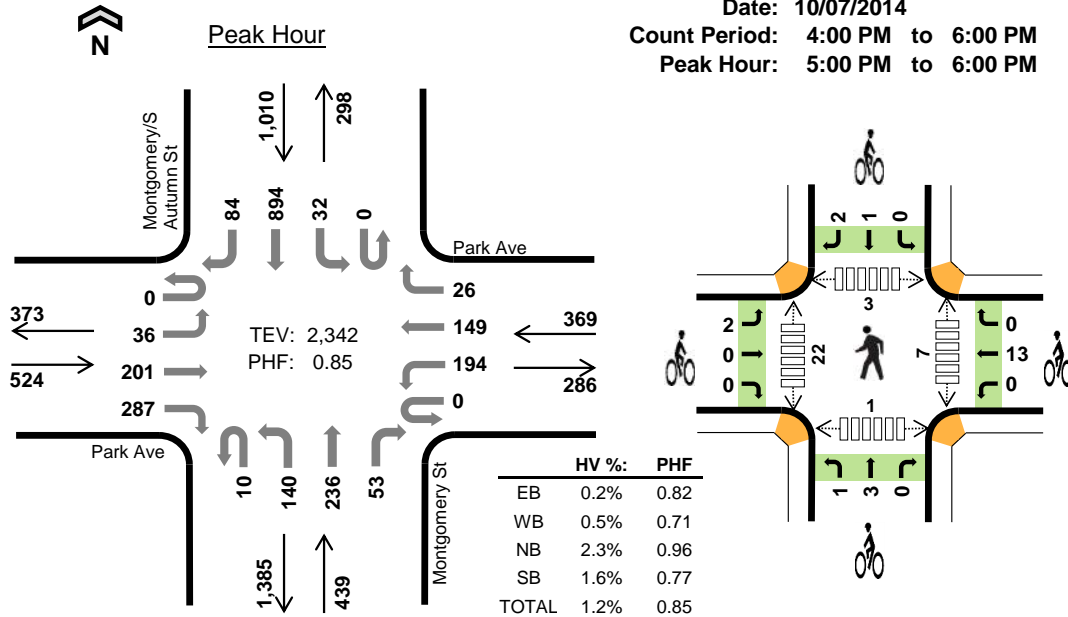

Two-Hour Count Summaries

Interval Start	Park Ave Eastbound				Park Ave Westbound				Montgomery St Northbound				Montgomery/S Autumn St Southbound				15-min Total	Rolling One Hour	
	UT	LT	TH	RT	UT	LT	TH	RT	UT	LT	TH	RT	UT	LT	TH	RT			
4:00 PM	0	0	24	31	0	27	21	4	6	17	58	23	2	4	118	9	344	0	
4:15 PM	0	5	38	42	1	28	23	6	3	35	47	15	3	2	103	12	363	0	
4:30 PM	0	5	30	72	0	35	42	4	3	31	58	12	0	7	93	8	400	0	
4:45 PM	0	9	35	61	1	38	37	7	3	35	49	15	1	6	109	10	416	1,523	
5:00 PM	0	12	68	80	0	45	41	11	2	35	60	17	0	7	186	12	576	1,755	
5:15 PM	0	11	45	60	0	77	51	2	1	37	63	12	0	12	284	31	686	2,078	
5:30 PM	0	9	59	81	0	45	31	7	1	35	55	15	0	10	242	23	613	2,291	
5:45 PM	0	4	29	66	0	27	26	6	6	33	58	9	0	3	182	18	467	2,342	
Count Total	0	55	328	493	2	322	272	47	25	258	448	118	6	51	1317	123	3,865	0	
Peak Hour	All	0	36	201	287	0	194	149	26	10	140	236	53	0	32	894	84	2,342	0
	HV	0	0	1	0	0	0	0	2	0	0	10	0	0	0	16	0	29	0
	HV%	-	0%	0%	0%	-	0%	0%	8%	0%	0%	4%	0%	-	0%	2%	0%	1%	0

Note: Two-hour count summary volumes include heavy vehicles but exclude bicycles in overall count.

Interval Start	Heavy Vehicle Totals					Bicycles					Pedestrians (Crossing Leg)				
	EB	WB	NB	SB	Total	EB	WB	NB	SB	Total	East	West	North	South	Total
4:00 PM	1	1	12	2	16	0	0	2	2	4	0	1	0	0	1
4:15 PM	0	0	4	8	12	0	0	2	1	3	0	2	1	1	4
4:30 PM	2	1	4	1	8	0	4	1	2	7	1	4	1	1	7
4:45 PM	2	4	4	4	14	0	2	0	0	2	1	2	0	1	4
5:00 PM	0	1	3	3	7	1	5	0	0	6	4	5	1	0	10
5:15 PM	0	0	3	4	7	1	2	1	1	5	2	3	0	0	5
5:30 PM	1	1	3	3	8	0	2	2	2	6	1	10	2	0	13
5:45 PM	0	0	1	6	7	0	4	1	0	5	0	4	0	1	5
Count Total	6	8	34	31	79	2	19	9	8	38	9	31	5	4	49
Peak Hour	1	2	10	16	29	2	13	4	3	22	7	22	3	1	33

Two-Hour Count Summaries - Heavy Vehicles																		
Interval Start	Park Ave				Park Ave				Montgomery St				Montgomery/S Autumn St				15-min Total	Rolling One Hour
	Eastbound				Westbound				Northbound				Southbound					
	UT	LT	TH	RT	UT	LT	TH	RT	UT	LT	TH	RT	UT	LT	TH	RT		
4:00 PM	0	0	0	1	0	0	0	1	0	2	6	4	0	0	2	0	16	0
4:15 PM	0	0	0	0	0	0	0	0	0	1	3	0	0	0	8	0	12	0
4:30 PM	0	0	1	1	0	0	1	0	0	1	3	0	0	0	1	0	8	0
4:45 PM	0	0	1	1	0	1	1	2	0	1	2	1	0	0	4	0	14	50
5:00 PM	0	0	0	0	0	0	0	1	0	0	3	0	0	0	3	0	7	41
5:15 PM	0	0	0	0	0	0	0	0	0	0	3	0	0	0	4	0	7	36
5:30 PM	0	0	1	0	0	0	0	1	0	0	3	0	0	0	3	0	8	36
5:45 PM	0	0	0	0	0	0	0	0	0	0	1	0	0	0	6	0	7	29
Count Total	0	0	3	3	0	1	2	5	0	5	24	5	0	0	31	0	79	0
Peak Hour	0	0	1	0	0	0	0	2	0	0	10	0	0	0	16	0	29	0
Two-Hour Count Summaries - Bikes																		
Interval Start	Park Ave			Park Ave			Montgomery St			Montgomery/S Autumn St			15-min Total	Rolling One Hour				
	Eastbound			Westbound			Northbound			Southbound								
	LT	TH	RT	LT	TH	RT	LT	TH	RT	LT	TH	RT						
4:00 PM	0	0	0	0	0	0	0	2	0	0	1	1	4	0				
4:15 PM	0	0	0	0	0	0	0	2	0	0	1	0	3	0				
4:30 PM	0	0	0	0	4	0	0	1	0	0	2	0	7	0				
4:45 PM	0	0	0	0	2	0	0	0	0	0	0	0	2	16				
5:00 PM	1	0	0	0	5	0	0	0	0	0	0	0	6	18				
5:15 PM	1	0	0	0	2	0	1	0	0	0	1	0	5	20				
5:30 PM	0	0	0	0	2	0	0	2	0	0	0	2	6	19				
5:45 PM	0	0	0	0	4	0	0	1	0	0	0	0	5	22				
Count Total	2	0	0	0	19	0	1	8	0	0	5	3	38	0				
Peak Hour	2	0	0	0	13	0	1	3	0	0	1	2	22	0				
<i>Note: U-Turn volumes for bikes are included in Left-Turn, if any.</i>																		

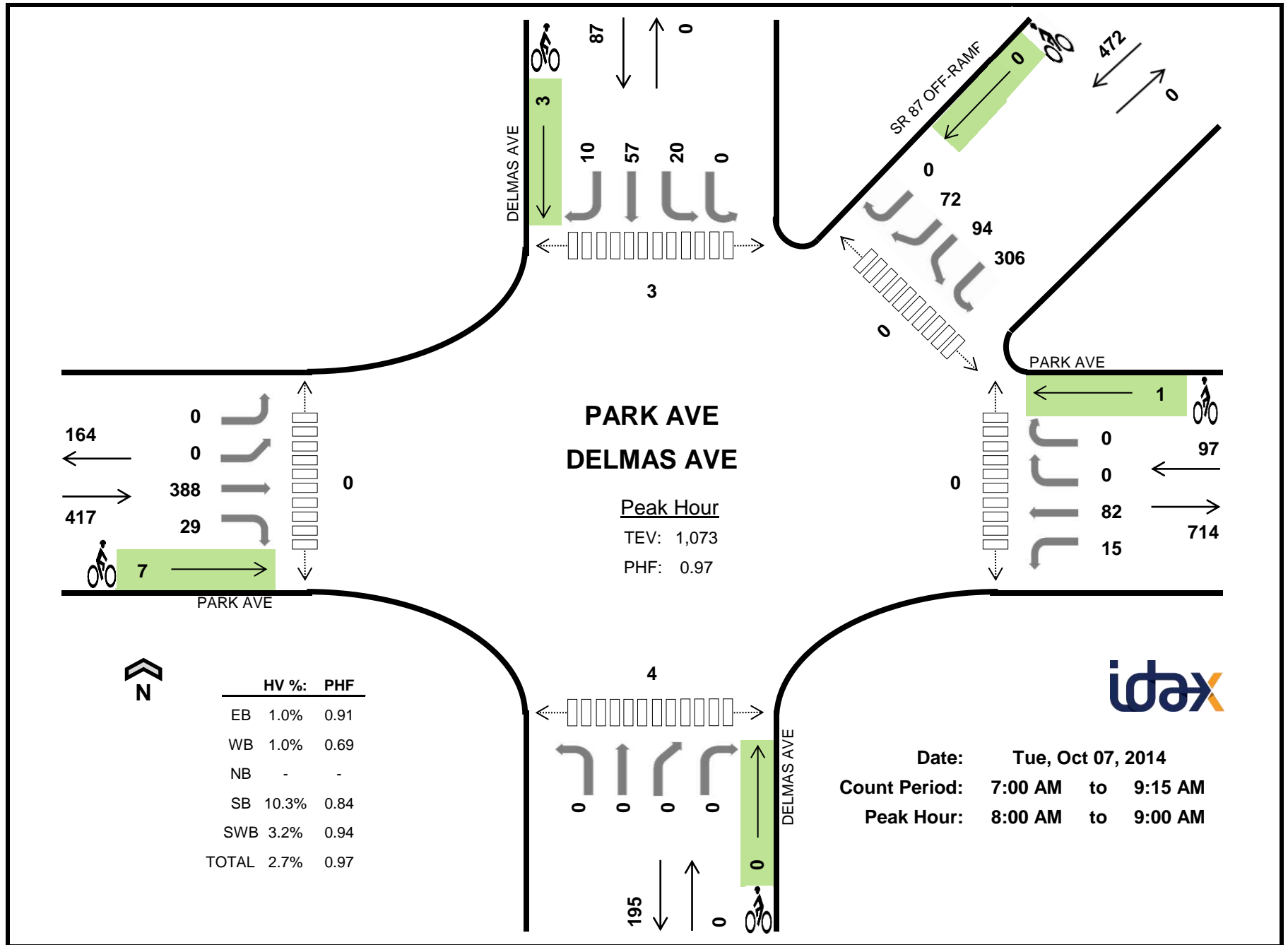

Six-Hour Count Summaries

Interval Start	PARK AVE Eastbound				PARK AVE Westbound				DELMAS AVE Northbound				DELMAS AVE Southbound				SR 87 OFF-RAMP Southwestbound				15-min Total	Rolling One Hour
	LT	BL	TH	RT	LT	TH	RT	HR	LT	TH	BR	RT	HL	LT	TH	RT	HL	BL	BR	HR		
7:00 AM	0	0	42	6	8	9	0	0	0	0	0	0	0	1	6	1	33	21	14	0	141	
7:15 AM	0	0	58	10	0	11	0	0	0	0	0	0	0	2	8	1	45	26	13	0	174	
7:30 AM	0	0	77	7	3	26	0	0	0	0	0	0	0	5	6	3	33	31	17	0	208	
7:45 AM	0	0	86	13	1	16	0	0	0	0	0	0	0	2	12	5	66	25	31	0	257	780
8:00 AM	0	0	87	5	3	32	0	0	0	0	0	0	0	9	12	5	62	24	21	0	260	899
8:15 AM	0	0	103	7	2	14	0	0	0	0	0	0	0	4	16	5	79	27	19	0	276	1,001
8:30 AM	0	0	106	9	5	20	0	0	0	0	0	0	0	1	9	0	83	22	17	0	272	1,065
8:45 AM	0	0	92	8	5	16	0	0	0	0	0	0	0	6	20	0	82	21	15	0	265	1,073
9:00 AM	0	0	0	0	0	0	0	0	0	0	0	0	0	0	0	0	0	0	0	0	0	813
9:15 AM	0	0	0	0	0	0	0	0	0	0	0	0	0	0	0	0	0	0	0	0	0	537
9:30 AM	0	0	0	0	0	0	0	0	0	0	0	0	0	0	0	0	0	0	0	0	0	265
9:45 AM	0	0	0	0	0	0	0	0	0	0	0	0	0	0	0	0	0	0	0	0	0	0
10:00 AM	0	0	0	0	0	0	0	0	0	0	0	0	0	0	0	0	0	0	0	0	0	0
10:15 AM	0	0	0	0	0	0	0	0	0	0	0	0	0	0	0	0	0	0	0	0	0	0
10:30 AM	0	0	0	0	0	0	0	0	0	0	0	0	0	0	0	0	0	0	0	0	0	0
10:45 AM	0	0	0	0	0	0	0	0	0	0	0	0	0	0	0	0	0	0	0	0	0	0
11:00 AM	0	0	0	0	0	0	0	0	0	0	0	0	0	0	0	0	0	0	0	0	0	0
11:15 AM	0	0	0	0	0	0	0	0	0	0	0	0	0	0	0	0	0	0	0	0	0	0
11:30 AM	0	0	0	0	0	0	0	0	0	0	0	0	0	0	0	0	0	0	0	0	0	0
11:45 AM	0	0	0	0	0	0	0	0	0	0	0	0	0	0	0	0	0	0	0	0	0	0
12:00 PM	0	0	0	0	0	0	0	0	0	0	0	0	0	0	0	0	0	0	0	0	0	0
12:15 PM	0	0	0	0	0	0	0	0	0	0	0	0	0	0	0	0	0	0	0	0	0	0
12:30 PM	0	0	0	0	0	0	0	0	0	0	0	0	0	0	0	0	0	0	0	0	0	0
12:45 PM	0	0	0	0	0	0	0	0	0	0	0	0	0	0	0	0	0	0	0	0	0	0
Count Total	0	0	651	65	27	144	0	0	0	0	0	0	0	30	89	20	483	197	147	0	1,853	
Peak Hr	0	0	388	29	15	82	0	0	0	0	0	0	0	20	57	10	306	94	72	0	1,073	

Note: Six-hour count summary volumes include heavy vehicles but excludes bicycles in overall count.

Interval Start	Heavy Vehicle Totals						Bicycles						Pedestrians (Crossing Leg)					
	EB	WB	NB	SB	SWB	Total	EB	WB	NB	SB	SWB	Total	East	West	North	South	NE	Total
7:00 AM	2	0	0	0	3	5	1	2	0	0	0	3	0	5	0	7	0	12
7:15 AM	4	0	0	1	3	8	0	0	0	1	0	1	0	1	0	1	0	2
7:30 AM	2	0	0	1	1	4	0	1	0	1	0	2	0	5	1	2	2	10
7:45 AM	1	1	0	1	1	4	3	1	0	0	0	4	0	2	0	0	1	3
8:00 AM	1	0	0	2	4	7	4	1	0	1	0	6	0	0	0	0	0	0
8:15 AM	1	1	0	6	3	11	1	0	0	1	0	2	0	0	1	0	0	1
8:30 AM	2	0	0	0	2	4	1	0	0	0	0	1	0	0	0	1	0	1
8:45 AM	0	0	0	1	6	7	1	0	0	1	0	2	0	0	2	3	0	5
9:00 AM	0	0	0	0	0	0	0	0	0	0	0	0	0	0	0	0	0	0
9:15 AM	0	0	0	0	0	0	0	0	0	0	0	0	0	0	0	0	0	0
9:30 AM	0	0	0	0	0	0	0	0	0	0	0	0	0	0	0	0	0	0
9:45 AM	0	0	0	0	0	0	0	0	0	0	0	0	0	0	0	0	0	0
10:00 AM	0	0	0	0	0	0	0	0	0	0	0	0	0	0	0	0	0	0
10:15 AM	0	0	0	0	0	0	0	0	0	0	0	0	0	0	0	0	0	0
10:30 AM	0	0	0	0	0	0	0	0	0	0	0	0	0	0	0	0	0	0
10:45 AM	0	0	0	0	0	0	0	0	0	0	0	0	0	0	0	0	0	0
11:00 AM	0	0	0	0	0	0	0	0	0	0	0	0	0	0	0	0	0	0
11:15 AM	0	0	0	0	0	0	0	0	0	0	0	0	0	0	0	0	0	0
11:30 AM	0	0	0	0	0	0	0	0	0	0	0	0	0	0	0	0	0	0
8:45 PM	0	0	0	0	0	0	0	0	0	0	0	0	0	0	0	0	0	0
12:00 PM	0	0	0	0	0	0	0	0	0	0	0	0	0	0	0	0	0	0
12:15 PM	0	0	0	0	0	0	0	0	0	0	0	0	0	0	0	0	0	0
12:30 PM	0	0	0	0	0	0	0	0	0	0	0	0	0	0	0	0	0	0
9:45 PM	0	0	0	0	0	0	0	0	0	0	0	0	0	0	0	0	0	0
Count Total	13	2	0	12	23	50	11	5	0	5	0	21	0	13	4	14	3	34
Peak Hr	4	1	0	9	15	29	7	1	0	3	0	11	0	0	3	4	0	7

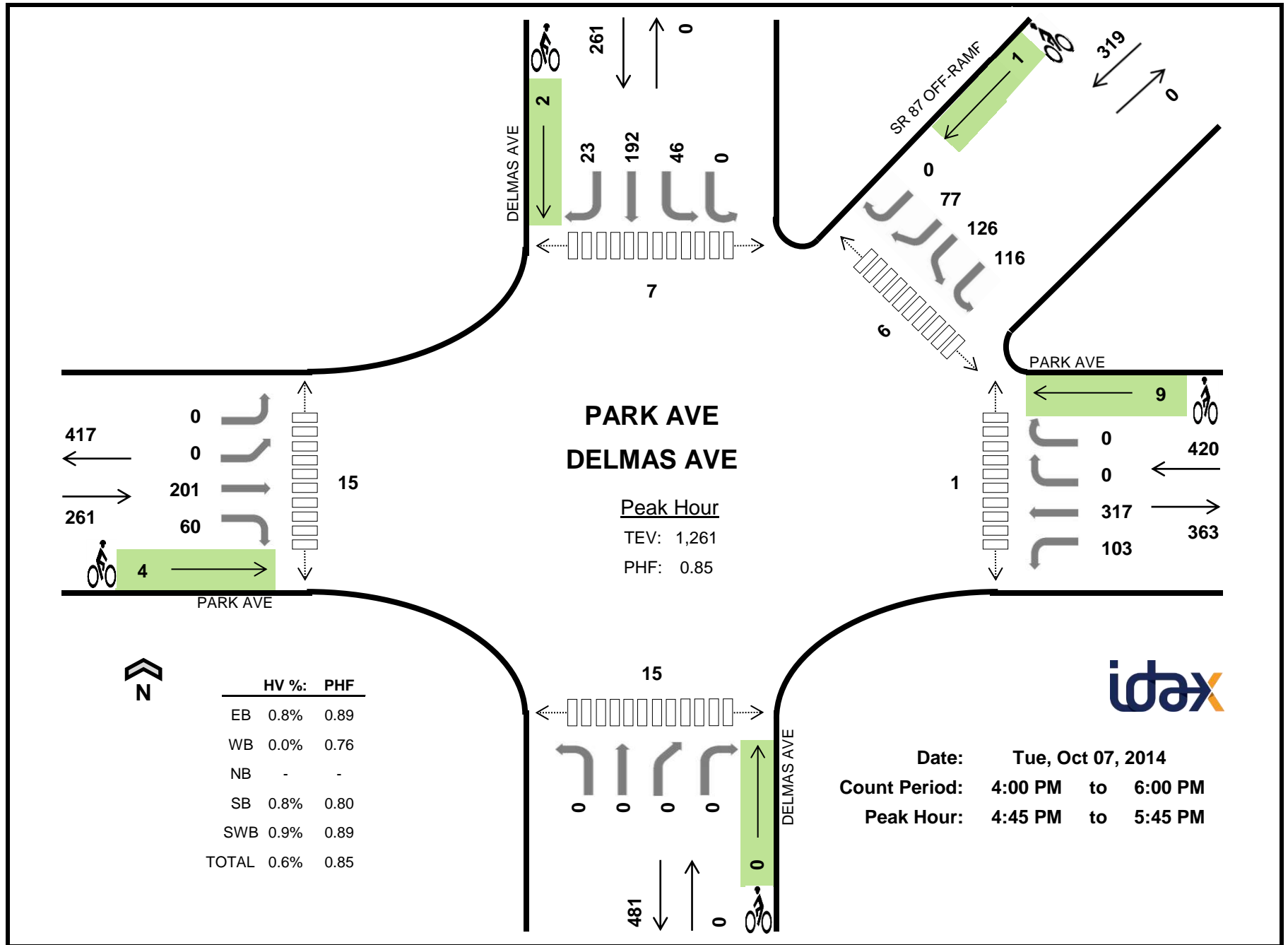

Two-Hour Count Summaries

Interval Start	PARK AVE Eastbound				PARK AVE Westbound				DELMAS AVE Northbound				DELMAS AVE Southbound				SR 87 OFF-RAMP Southwestbound				15-min Total	Rolling One Hour
	LT	BL	TH	RT	LT	TH	RT	HR	LT	TH	BR	RT	HL	LT	TH	RT	HL	BL	BR	HR		
4:00 PM	0	0	36	4	20	36	0	0	0	0	0	0	0	7	36	0	38	33	17	0	227	
4:15 PM	0	0	34	12	13	42	0	0	0	0	0	0	0	5	27	3	43	39	15	0	233	
4:30 PM	0	0	41	2	20	63	0	0	0	0	0	0	0	4	35	7	23	33	20	0	248	
4:45 PM	0	0	45	14	15	60	0	0	0	0	0	0	0	2	42	4	32	32	26	0	272	980
5:00 PM	0	0	49	17	32	97	0	0	0	0	0	0	0	10	46	8	29	30	19	0	337	1,090
5:15 PM	0	0	57	16	36	103	0	0	0	0	0	0	0	23	55	4	27	33	16	0	370	1,227
5:30 PM	0	0	50	13	20	57	0	0	0	0	0	0	0	11	49	7	28	31	16	0	282	1,261
5:45 PM	0	0	40	4	17	42	0	0	0	0	0	0	0	3	38	0	33	15	17	0	209	1,198
Count Total	0	0	352	82	173	500	0	0	0	0	0	0	0	65	328	33	253	246	146	0	2,178	
Peak Hr	0	0	201	60	103	317	0	0	0	0	0	0	0	46	192	23	116	126	77	0	1,261	

Note: Two-hour count summary volumes include heavy vehicles but excludes bicycles in overall count.

Interval Start	Heavy Vehicle Totals						Bicycles						Pedestrians (Crossing Leg)					
	EB	WB	NB	SB	SWB	Total	EB	WB	NB	SB	SWB	Total	East	West	North	South	NE	Total
4:00 PM	1	1	0	0	2	4	0	1	0	0	0	1	0	5	0	2	0	7
4:15 PM	1	1	0	1	1	4	2	0	0	1	0	3	0	4	0	0	0	4
4:30 PM	1	0	0	0	1	2	1	5	0	0	0	6	0	4	0	5	1	10
4:45 PM	1	0	0	0	2	3	1	2	0	0	1	4	0	0	0	2	1	3
5:00 PM	0	0	0	1	0	1	0	4	0	0	0	4	0	5	1	4	1	11
5:15 PM	0	0	0	0	0	0	1	1	0	2	0	4	1	3	5	3	3	15
5:30 PM	1	0	0	1	1	3	2	2	0	0	0	4	0	7	1	6	1	15
5:45 PM	0	0	0	0	0	0	2	3	0	0	0	5	0	3	0	2	0	5
Count Total	5	2	0	3	7	17	9	18	0	3	1	31	1	31	7	24	7	70
Peak Hr	2	0	0	2	3	7	4	9	0	2	1	16	1	15	7	15	6	44

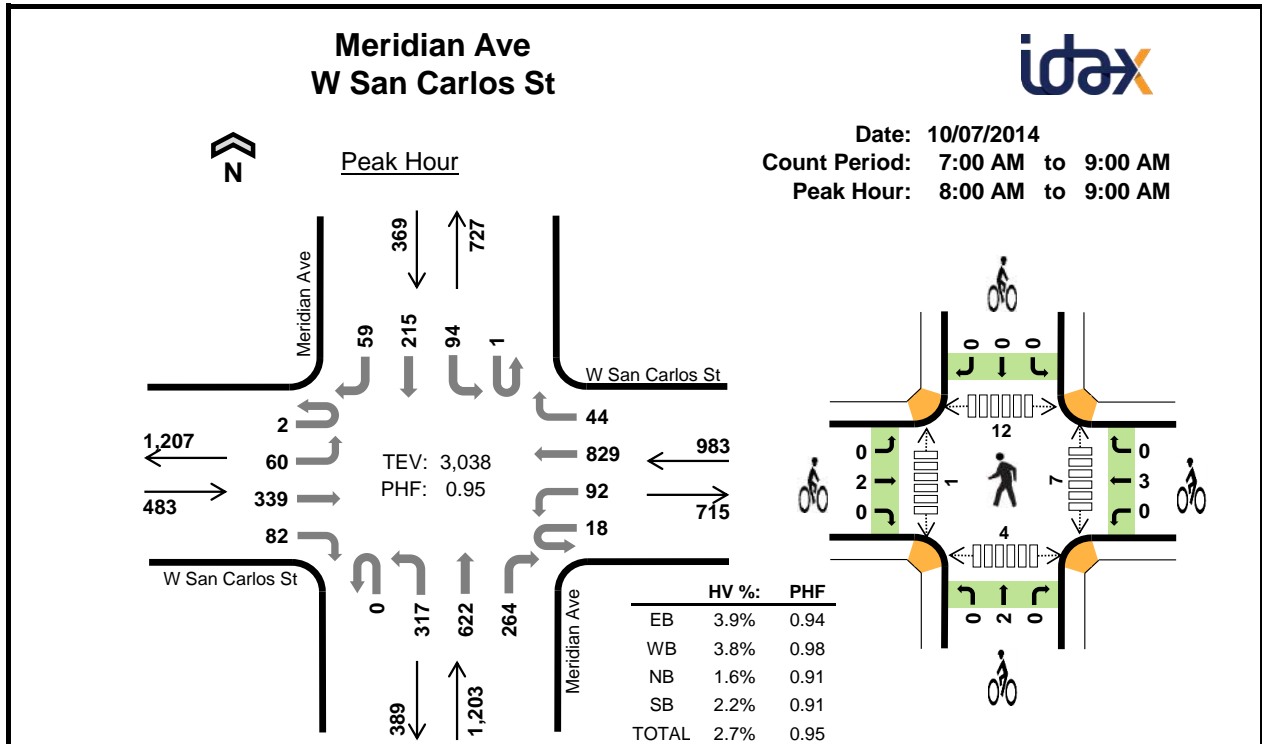

Two-Hour Count Summaries

Interval Start	W San Carlos St Eastbound				W San Carlos St Westbound				Meridian Ave Northbound				Meridian Ave Southbound				15-min Total	Rolling One Hour	
	UT	LT	TH	RT	UT	LT	TH	RT	UT	LT	TH	RT	UT	LT	TH	RT			
7:00 AM	2	2	55	16	3	33	182	10	0	42	67	16	0	11	45	10	494	0	
7:15 AM	1	12	57	20	7	24	233	19	0	87	107	25	0	15	63	9	679	0	
7:30 AM	4	19	77	20	4	20	220	8	0	104	125	36	0	25	56	8	726	0	
7:45 AM	3	19	86	17	1	30	202	4	0	75	161	35	0	36	66	17	752	2,651	
8:00 AM	2	13	78	21	8	26	202	14	0	78	134	39	1	25	53	18	712	2,869	
8:15 AM	0	14	86	17	3	27	208	9	0	81	164	87	0	31	53	17	797	2,987	
8:30 AM	0	20	93	16	5	22	208	6	0	78	160	57	0	18	52	12	747	3,008	
8:45 AM	0	13	82	28	2	17	211	15	0	80	164	81	0	20	57	12	782	3,038	
Count Total	12	112	614	155	33	199	1666	85	0	625	1082	376	1	181	445	103	5,689	0	
Peak Hour	All	2	60	339	82	18	92	829	44	0	317	622	264	1	94	215	59	3,038	0
	HV	1	2	15	1	0	4	28	5	0	2	6	11	0	4	2	2	83	0
	HV%	50%	3%	4%	1%	0%	4%	3%	11%	-	1%	1%	4%	0%	4%	1%	3%	3%	0

Note: Two-hour count summary volumes include heavy vehicles but exclude bicycles in overall count.

Interval Start	Heavy Vehicle Totals					Bicycles					Pedestrians (Crossing Leg)				
	EB	WB	NB	SB	Total	EB	WB	NB	SB	Total	East	West	North	South	Total
7:00 AM	6	8	1	4	19	1	1	0	0	2	3	0	7	0	10
7:15 AM	6	3	1	3	13	1	0	0	0	1	6	3	12	4	25
7:30 AM	2	9	0	1	12	0	0	0	1	1	2	4	6	0	12
7:45 AM	4	12	1	4	21	2	1	1	0	4	3	3	8	0	14
8:00 AM	8	8	4	4	24	0	1	0	0	1	3	1	4	0	8
8:15 AM	5	8	5	0	18	1	0	0	0	1	2	0	1	1	4
8:30 AM	3	8	3	2	16	0	2	0	0	2	1	0	6	3	10
8:45 AM	3	13	7	2	25	1	0	2	0	3	1	0	1	0	2
Count Total	37	69	22	20	148	6	5	3	1	15	21	11	45	8	85
Peak Hour	19	37	19	8	83	2	3	2	0	7	7	1	12	4	24

Two-Hour Count Summaries - Heavy Vehicles																			
Interval Start	W San Carlos St				W San Carlos St				Meridian Ave				Meridian Ave				15-min Total	Rolling One Hour	
	Eastbound				Westbound				Northbound				Southbound						
	UT	LT	TH	RT	UT	LT	TH	RT	UT	LT	TH	RT	UT	LT	TH	RT			
7:00 AM	0	0	4	2	0	0	8	0	0	0	0	1	0	0	4	0	19	0	
7:15 AM	0	0	4	2	0	0	3	0	0	1	0	0	0	0	0	3	0	13	0
7:30 AM	0	1	1	0	0	4	5	0	0	0	0	0	0	0	0	1	0	12	0
7:45 AM	0	0	4	0	0	5	7	0	0	0	1	0	0	0	0	4	0	21	65
8:00 AM	1	1	6	0	0	1	5	2	0	0	0	4	0	1	1	2	24	70	
8:15 AM	0	1	3	1	0	2	6	0	0	1	2	2	0	0	0	0	18	75	
8:30 AM	0	0	3	0	0	1	6	1	0	0	2	1	0	1	1	0	16	79	
8:45 AM	0	0	3	0	0	0	11	2	0	1	2	4	0	2	0	0	25	83	
Count Total	1	3	28	5	0	13	51	5	0	3	7	12	0	4	14	2	148	0	
Peak Hour	1	2	15	1	0	4	28	5	0	2	6	11	0	4	2	2	83	0	
Two-Hour Count Summaries - Bikes																			
Interval Start	W San Carlos St			W San Carlos St			Meridian Ave			Meridian Ave			15-min Total	Rolling One Hour					
	Eastbound			Westbound			Northbound			Southbound									
	LT	TH	RT	LT	TH	RT	LT	TH	RT	LT	TH	RT							
7:00 AM	0	1	0	0	1	0	0	0	0	0	0	0	0	0	0	2	0		
7:15 AM	0	1	0	0	0	0	0	0	0	0	0	0	0	0	0	1	0		
7:30 AM	0	0	0	0	0	0	0	0	0	0	0	0	0	1	0	1	0		
7:45 AM	0	2	0	0	0	1	0	1	0	0	0	0	0	0	0	4	8		
8:00 AM	0	0	0	0	0	1	0	0	0	0	0	0	0	0	0	1	7		
8:15 AM	0	1	0	0	0	0	0	0	0	0	0	0	0	0	0	1	7		
8:30 AM	0	0	0	0	0	2	0	0	0	0	0	0	0	0	0	2	8		
8:45 AM	0	1	0	0	0	0	0	0	0	2	0	0	0	0	0	3	7		
Count Total	0	6	0	0	0	5	0	1	2	0	0	0	0	1	0	15	0		
Peak Hour	0	2	0	0	0	3	0	0	2	0	0	0	0	0	0	7	0		
<i>Note: U-Turn volumes for bikes are included in Left-Turn, if any.</i>																			

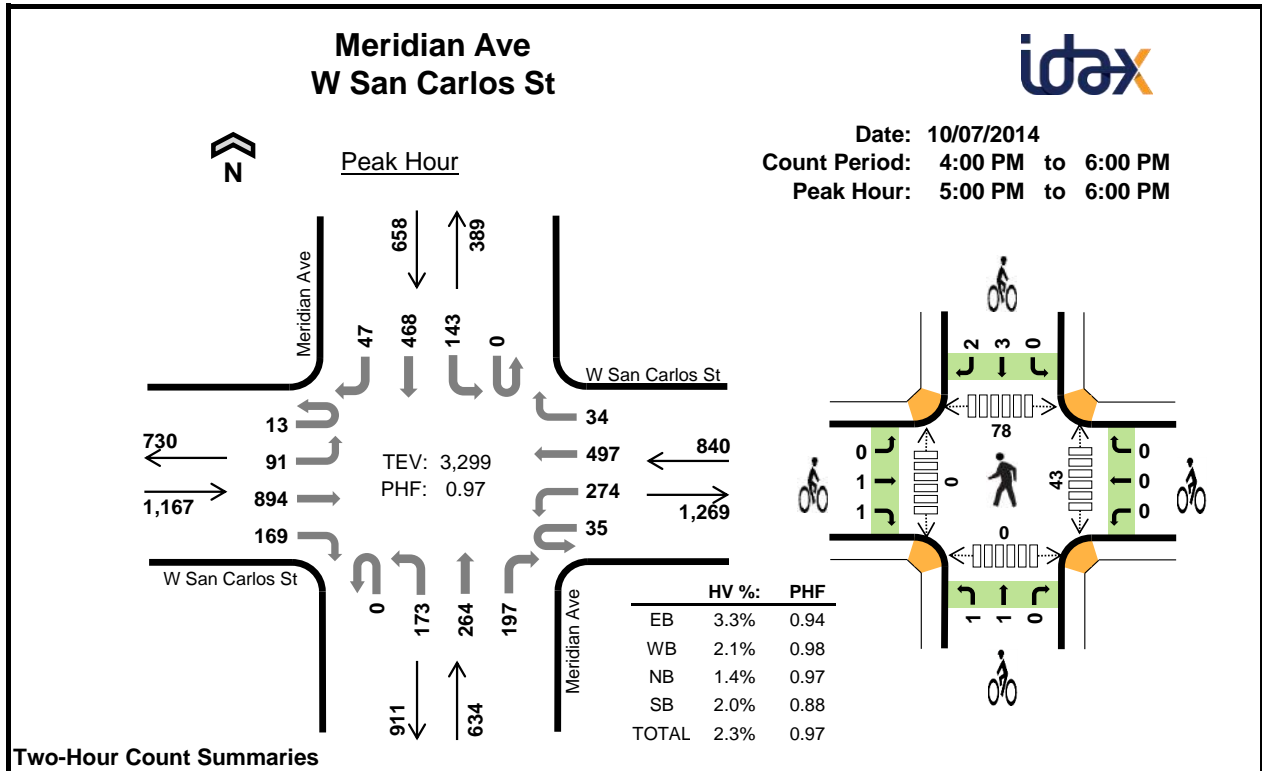

Two-Hour Count Summaries

Interval Start	W San Carlos St Eastbound				W San Carlos St Westbound				Meridian Ave Northbound				Meridian Ave Southbound				15-min Total	Rolling One Hour	
	UT	LT	TH	RT	UT	LT	TH	RT	UT	LT	TH	RT	UT	LT	TH	RT			
4:00 PM	5	25	176	37	8	54	113	9	0	29	64	36	0	26	98	16	696	0	
4:15 PM	2	23	186	30	8	47	95	18	0	37	77	49	0	22	126	11	731	0	
4:30 PM	5	25	225	30	12	57	116	9	0	28	64	38	0	40	108	11	768	0	
4:45 PM	2	15	189	26	7	51	121	15	0	24	70	48	0	39	116	8	731	2,926	
5:00 PM	3	30	205	38	6	70	121	7	0	45	74	41	0	21	97	15	773	3,003	
5:15 PM	3	19	222	52	12	63	133	6	0	39	66	49	0	39	137	10	850	3,122	
5:30 PM	3	23	245	38	8	75	117	11	0	33	65	58	0	43	121	13	853	3,207	
5:45 PM	4	19	222	41	9	66	126	10	0	56	59	49	0	40	113	9	823	3,299	
Count Total	27	179	1670	292	70	483	942	85	0	291	539	368	0	270	916	93	6,225	0	
Peak Hour	All	13	91	894	169	35	274	497	34	0	173	264	197	0	143	468	47	3,299	0
	HV	0	0	33	5	0	4	12	1	0	3	3	3	0	2	11	0	77	0
	HV%	0%	0%	4%	3%	0%	1%	2%	3%	-	2%	1%	2%	-	1%	2%	0%	2%	0

Note: Two-hour count summary volumes include heavy vehicles but exclude bicycles in overall count.

Interval Start	Heavy Vehicle Totals					Bicycles					Pedestrians (Crossing Leg)				
	EB	WB	NB	SB	Total	EB	WB	NB	SB	Total	East	West	North	South	Total
4:00 PM	5	3	4	0	12	0	1	0	0	1	15	2	17	1	35
4:15 PM	5	3	4	1	13	0	0	0	0	0	9	2	11	2	24
4:30 PM	1	4	4	0	9	0	0	0	0	0	10	0	13	3	26
4:45 PM	7	6	2	1	16	0	0	0	1	1	17	0	12	3	32
5:00 PM	7	3	3	0	13	0	0	1	1	2	10	0	21	0	31
5:15 PM	8	4	0	5	17	2	0	0	1	3	8	0	15	0	23
5:30 PM	11	6	3	5	25	0	0	1	0	1	18	0	28	0	46
5:45 PM	12	4	3	3	22	0	0	0	3	3	7	0	14	0	21
Count Total	56	33	23	15	127	2	1	2	6	11	94	4	131	9	238
Peak Hour	38	17	9	13	77	2	0	2	5	9	43	0	78	0	121

Two-Hour Count Summaries - Heavy Vehicles																		
Interval Start	W San Carlos St				W San Carlos St				Meridian Ave				Meridian Ave				15-min Total	Rolling One Hour
	Eastbound				Westbound				Northbound				Southbound					
	UT	LT	TH	RT	UT	LT	TH	RT	UT	LT	TH	RT	UT	LT	TH	RT		
4:00 PM	0	0	5	0	0	1	2	0	0	0	2	2	0	0	0	0	12	0
4:15 PM	0	1	4	0	0	0	3	0	0	1	1	2	0	0	0	1	13	0
4:30 PM	0	0	1	0	0	1	2	1	0	0	1	3	0	0	0	0	9	0
4:45 PM	0	0	6	1	0	0	5	1	0	0	1	1	0	1	0	0	16	50
5:00 PM	0	0	7	0	0	1	2	0	0	2	0	1	0	0	0	0	13	51
5:15 PM	0	0	5	3	0	0	3	1	0	0	0	0	0	0	5	0	17	55
5:30 PM	0	0	10	1	0	2	4	0	0	0	1	2	0	1	4	0	25	71
5:45 PM	0	0	11	1	0	1	3	0	0	1	2	0	0	1	2	0	22	77
Count Total	0	1	49	6	0	6	24	3	0	4	8	11	0	3	11	1	127	0
Peak Hour	0	0	33	5	0	4	12	1	0	3	3	3	0	2	11	0	77	0
Two-Hour Count Summaries - Bikes																		
Interval Start	W San Carlos St			W San Carlos St			Meridian Ave			Meridian Ave			15-min Total	Rolling One Hour				
	Eastbound			Westbound			Northbound			Southbound								
	LT	TH	RT	LT	TH	RT	LT	TH	RT	LT	TH	RT						
4:00 PM	0	0	0	0	1	0	0	0	0	0	0	0	1	0				
4:15 PM	0	0	0	0	0	0	0	0	0	0	0	0	0	0				
4:30 PM	0	0	0	0	0	0	0	0	0	0	0	0	0	0				
4:45 PM	0	0	0	0	0	0	0	0	0	0	0	1	0	2				
5:00 PM	0	0	0	0	0	0	0	0	1	0	0	0	1	3				
5:15 PM	0	1	1	0	0	0	0	0	0	0	0	0	1	6				
5:30 PM	0	0	0	0	0	0	0	1	0	0	0	0	0	7				
5:45 PM	0	0	0	0	0	0	0	0	0	0	0	0	1	9				
Count Total	0	1	1	0	1	0	0	1	1	0	0	1	3	0				
Peak Hour	0	1	1	0	0	0	0	1	1	0	0	0	3	0				

Note: U-Turn volumes for bikes are included in Left-Turn, if any.

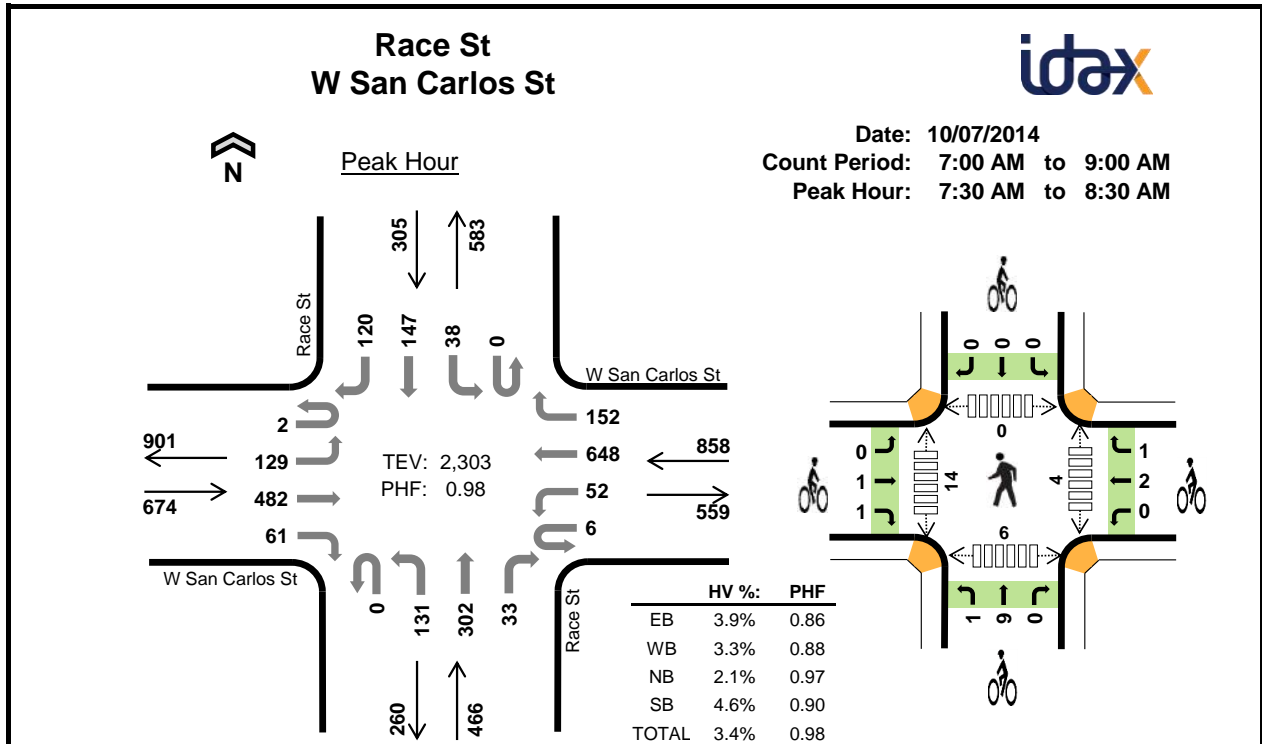

Two-Hour Count Summaries

Interval Start	W San Carlos St Eastbound				W San Carlos St Westbound				Race St Northbound				Race St Southbound				15-min Total	Rolling One Hour	
	UT	LT	TH	RT	UT	LT	TH	RT	UT	LT	TH	RT	UT	LT	TH	RT			
7:00 AM	0	10	64	14	1	6	172	26	0	25	22	6	0	4	15	26	391	0	
7:15 AM	3	14	89	8	0	1	234	26	0	31	57	6	0	10	29	22	530	0	
7:30 AM	0	29	116	14	1	9	195	39	0	37	74	7	0	4	34	17	576	0	
7:45 AM	0	31	109	16	1	12	160	26	0	31	80	7	0	12	31	38	554	2,051	
8:00 AM	1	29	117	17	4	15	160	39	0	32	79	9	0	13	43	28	586	2,246	
8:15 AM	1	40	140	14	0	16	133	48	0	31	69	10	0	9	39	37	587	2,303	
8:30 AM	2	38	129	15	1	20	137	47	0	33	49	20	0	8	27	23	549	2,276	
8:45 AM	1	28	130	19	0	16	143	40	0	26	49	10	0	11	38	24	535	2,257	
Count Total	8	219	894	117	8	95	1334	291	0	246	479	75	0	71	256	215	4,308	0	
Peak Hour	All	2	129	482	61	6	52	648	152	0	131	302	33	0	38	147	120	2,303	0
	HV	0	0	23	3	0	2	22	4	0	4	4	2	0	3	7	4	78	0
	HV%	0%	0%	5%	5%	0%	4%	3%	3%	-	3%	1%	6%	-	8%	5%	3%	3%	0

Note: Two-hour count summary volumes include heavy vehicles but exclude bicycles in overall count.

Interval Start	Heavy Vehicle Totals					Bicycles					Pedestrians (Crossing Leg)				
	EB	WB	NB	SB	Total	EB	WB	NB	SB	Total	East	West	North	South	Total
7:00 AM	3	8	2	4	17	1	2	0	0	3	0	4	0	4	8
7:15 AM	6	6	3	0	15	1	0	3	0	4	1	2	0	3	6
7:30 AM	5	10	1	3	19	0	1	3	0	4	1	10	0	6	17
7:45 AM	1	3	6	4	14	1	2	4	0	7	1	4	0	0	5
8:00 AM	14	9	1	5	29	1	0	3	0	4	0	0	0	0	0
8:15 AM	6	6	2	2	16	0	0	0	0	0	2	0	0	0	2
8:30 AM	6	11	4	3	24	0	0	0	0	0	0	0	0	2	2
8:45 AM	7	10	1	3	21	0	0	2	0	2	1	0	0	4	5
Count Total	48	63	20	24	155	4	5	15	0	24	6	20	0	19	45
Peak Hour	26	28	10	14	78	2	3	10	0	15	4	14	0	6	24

Two-Hour Count Summaries - Heavy Vehicles																		
Interval Start	W San Carlos St				W San Carlos St				Race St				Race St				15-min Total	Rolling One Hour
	Eastbound				Westbound				Northbound				Southbound					
	UT	LT	TH	RT	UT	LT	TH	RT	UT	LT	TH	RT	UT	LT	TH	RT		
7:00 AM	0	1	2	0	0	0	6	2	0	2	0	0	0	0	4	0	17	0
7:15 AM	0	0	5	1	0	0	6	0	0	0	3	0	0	0	0	0	15	0
7:30 AM	0	0	5	0	0	0	10	0	0	0	1	0	0	0	2	1	19	0
7:45 AM	0	0	1	0	0	0	2	1	0	2	2	2	0	2	1	1	14	65
8:00 AM	0	0	12	2	0	1	7	1	0	1	0	0	0	1	2	2	29	77
8:15 AM	0	0	5	1	0	1	3	2	0	1	1	0	0	0	2	0	16	78
8:30 AM	0	0	4	2	0	0	7	4	0	0	3	1	0	0	2	1	24	83
8:45 AM	0	0	7	0	0	1	8	1	0	0	1	0	0	1	1	1	21	90
Count Total	0	1	41	6	0	3	49	11	0	6	11	3	0	4	14	6	155	0
Peak Hour	0	0	23	3	0	2	22	4	0	4	4	2	0	3	7	4	78	0
Two-Hour Count Summaries - Bikes																		
Interval Start	W San Carlos St			W San Carlos St			Race St			Race St			15-min Total	Rolling One Hour				
	Eastbound			Westbound			Northbound			Southbound								
	LT	TH	RT	LT	TH	RT	LT	TH	RT	LT	TH	RT						
7:00 AM	0	1	0	0	2	0	0	0	0	0	0	0	0	0	0	3	0	
7:15 AM	0	1	0	0	0	0	0	0	0	3	0	0	0	0	0	4	0	
7:30 AM	0	0	0	0	0	0	1	1	2	0	0	0	0	0	0	4	0	
7:45 AM	0	1	0	0	2	0	0	0	4	0	0	0	0	0	0	7	18	
8:00 AM	0	0	1	0	0	0	0	0	3	0	0	0	0	0	0	4	19	
8:15 AM	0	0	0	0	0	0	0	0	0	0	0	0	0	0	0	0	15	
8:30 AM	0	0	0	0	0	0	0	0	0	0	0	0	0	0	0	0	11	
8:45 AM	0	0	0	0	0	0	0	0	2	0	0	0	0	0	0	2	6	
Count Total	0	3	1	0	4	1	1	1	14	0	0	0	0	0	0	24	0	
Peak Hour	0	1	1	0	2	1	1	1	9	0	0	0	0	0	0	15	0	

Note: U-Turn volumes for bikes are included in Left-Turn, if any.

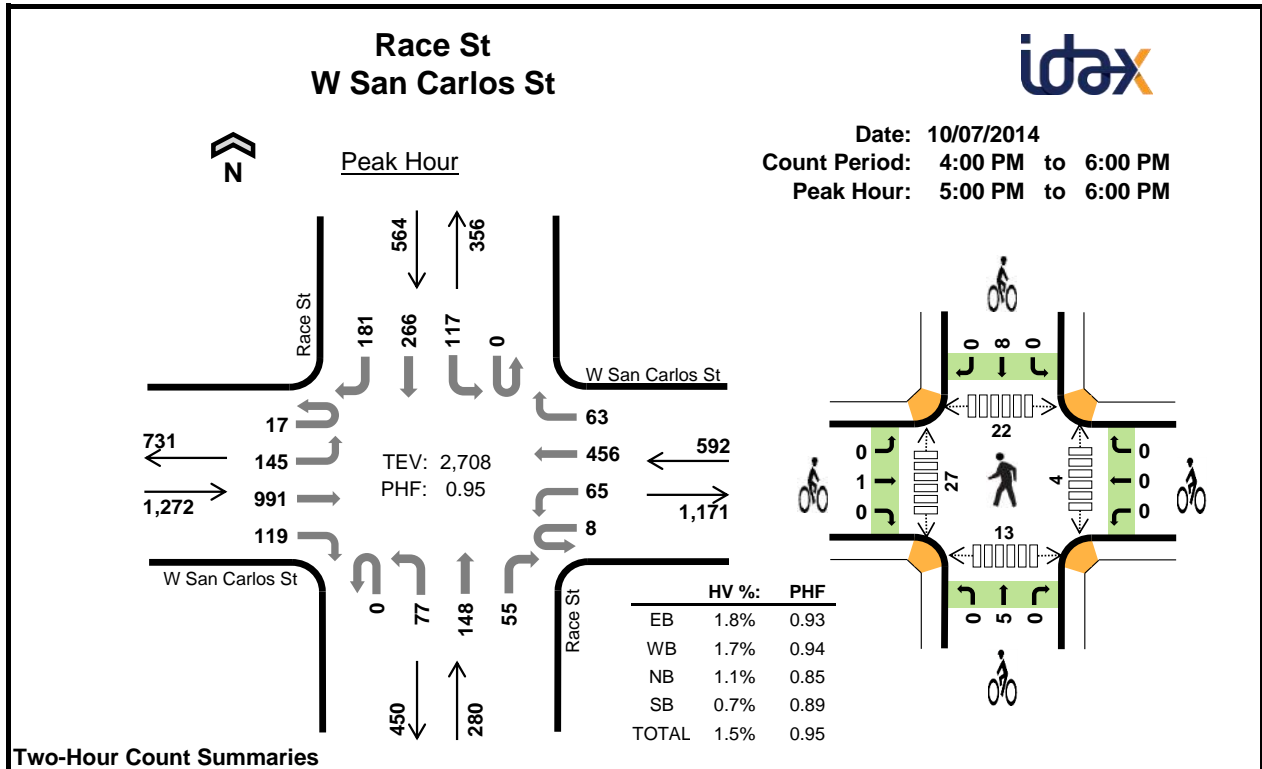

Two-Hour Count Summaries

Interval Start	W San Carlos St Eastbound				W San Carlos St Westbound				Race St Northbound				Race St Southbound				15-min Total	Rolling One Hour	
	UT	LT	TH	RT	UT	LT	TH	RT	UT	LT	TH	RT	UT	LT	TH	RT			
4:00 PM	5	28	167	21	5	12	116	12	0	18	36	23	0	19	52	38	552	0	
4:15 PM	8	32	225	25	5	7	115	10	0	22	27	12	0	35	50	49	622	0	
4:30 PM	2	29	214	24	5	11	87	12	0	21	44	13	0	22	57	49	590	0	
4:45 PM	1	22	233	33	2	11	141	21	0	15	41	19	0	17	61	48	665	2,429	
5:00 PM	4	36	209	34	2	14	108	12	0	22	33	9	0	29	66	41	619	2,496	
5:15 PM	1	38	259	27	5	12	121	18	0	13	40	17	0	33	69	56	709	2,583	
5:30 PM	6	36	267	34	0	18	106	18	0	25	41	16	0	26	70	38	701	2,694	
5:45 PM	6	35	256	24	1	21	121	15	0	17	34	13	0	29	61	46	679	2,708	
Count Total	33	256	1830	222	25	106	915	118	0	153	296	122	0	210	486	365	5,137	0	
Peak Hour	All	17	145	991	119	8	65	456	63	0	77	148	55	0	117	266	181	2,708	0
	HV	0	1	22	0	0	0	10	0	0	0	2	1	0	1	3	0	40	0
	HV%	0%	1%	2%	0%	0%	0%	2%	0%	-	0%	1%	2%	-	1%	1%	0%	1%	0

Note: Two-hour count summary volumes include heavy vehicles but exclude bicycles in overall count.

Interval Start	Heavy Vehicle Totals					Bicycles					Pedestrians (Crossing Leg)				
	EB	WB	NB	SB	Total	EB	WB	NB	SB	Total	East	West	North	South	Total
4:00 PM	5	4	2	4	15	2	0	1	1	4	0	9	4	4	17
4:15 PM	7	2	1	1	11	2	1	1	0	4	0	8	4	0	12
4:30 PM	6	2	0	1	9	0	0	1	1	2	1	6	1	4	12
4:45 PM	7	8	1	2	18	1	2	1	2	6	0	16	11	1	28
5:00 PM	5	1	0	1	7	0	0	0	1	1	1	0	12	3	16
5:15 PM	5	4	2	1	12	1	0	3	2	6	3	10	3	4	20
5:30 PM	6	2	0	2	10	0	0	2	1	3	0	6	5	2	13
5:45 PM	7	3	1	0	11	0	0	0	4	4	0	11	2	4	17
Count Total	48	26	7	12	93	6	3	9	12	30	5	66	42	22	135
Peak Hour	23	10	3	4	40	1	0	5	8	14	4	27	22	13	66

Two-Hour Count Summaries - Heavy Vehicles																		
Interval Start	W San Carlos St				W San Carlos St				Race St				Race St				15-min Total	Rolling One Hour
	Eastbound				Westbound				Northbound				Southbound					
	UT	LT	TH	RT	UT	LT	TH	RT	UT	LT	TH	RT	UT	LT	TH	RT		
4:00 PM	0	0	5	0	0	0	4	0	0	0	1	1	0	2	2	0	15	0
4:15 PM	0	1	6	0	0	0	2	0	0	0	1	0	0	0	1	0	11	0
4:30 PM	0	1	4	1	0	0	2	0	0	0	0	0	0	0	1	0	9	0
4:45 PM	0	0	7	0	0	0	8	0	0	0	1	0	0	0	2	0	18	53
5:00 PM	0	1	4	0	0	0	1	0	0	0	0	0	0	0	1	0	7	45
5:15 PM	0	0	5	0	0	0	4	0	0	0	1	1	0	1	0	0	12	46
5:30 PM	0	0	6	0	0	0	2	0	0	0	0	0	0	0	2	0	10	47
5:45 PM	0	0	7	0	0	0	3	0	0	0	1	0	0	0	0	0	11	40
Count Total	0	3	44	1	0	0	26	0	0	0	5	2	0	3	9	0	93	0
Peak Hour	0	1	22	0	0	0	10	0	0	0	2	1	0	1	3	0	40	0
Two-Hour Count Summaries - Bikes																		
Interval Start	W San Carlos St			W San Carlos St			Race St			Race St			15-min Total	Rolling One Hour				
	Eastbound			Westbound			Northbound			Southbound								
	LT	TH	RT	LT	TH	RT	LT	TH	RT	LT	TH	RT						
4:00 PM	0	1	1	0	0	0	0	1	0	0	1	0	0	4	0			
4:15 PM	0	2	0	0	1	0	0	1	0	0	0	0	0	4	0			
4:30 PM	0	0	0	0	0	0	0	1	0	0	1	0	0	2	0			
4:45 PM	0	1	0	0	2	0	0	1	0	0	2	0	0	6	16			
5:00 PM	0	0	0	0	0	0	0	0	0	0	1	0	0	1	13			
5:15 PM	0	1	0	0	0	0	0	3	0	0	2	0	0	6	15			
5:30 PM	0	0	0	0	0	0	0	2	0	0	1	0	0	3	16			
5:45 PM	0	0	0	0	0	0	0	0	0	0	4	0	0	4	14			
Count Total	0	5	1	0	3	0	0	9	0	0	12	0	0	30	0			
Peak Hour	0	1	0	0	0	0	0	5	0	0	8	0	0	14	0			
<i>Note: U-Turn volumes for bikes are included in Left-Turn, if any.</i>																		

City of San Jose
Citywide Traffic Database
(updated July 2, 2014)

Level Of Service Computation Report
2000 HCM Operations (Future Volume Alternative)
Existing (AM)

Intersection #3653: LINCOLN/SAN CARLOS

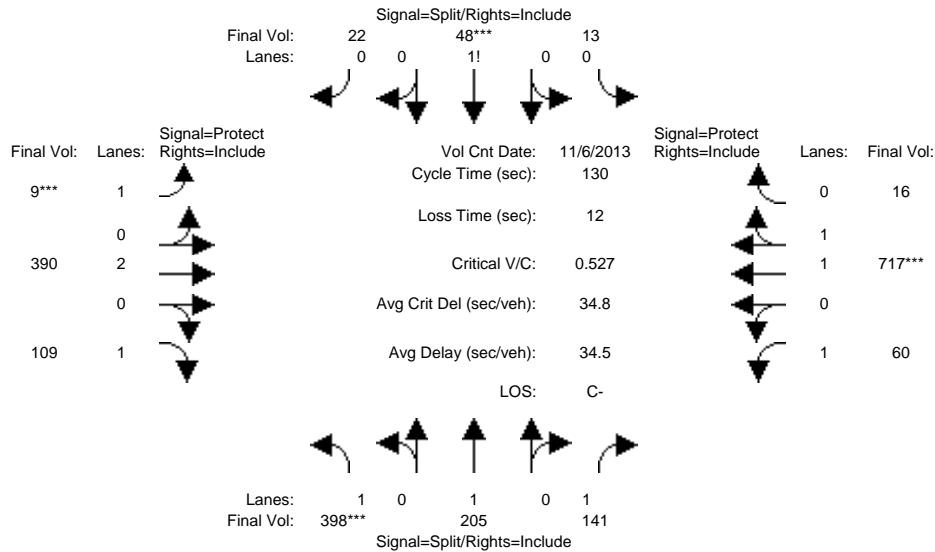

Approach:	North Bound			South Bound			East Bound			West Bound		
	L	T	R	L	T	R	L	T	R	L	T	R
Min. Green:	10	10	10	10	10	10	7	10	10	7	10	10
Y+R:	4.0	4.0	4.0	4.0	4.0	4.0	4.0	4.0	4.0	4.0	4.0	4.0

Volume Module:	>>	Count	Date:	6 Nov 2013	<<	7:30-8:30AM
Base Vol:	398	205	141	13	48	22
Growth Adj:	1.00	1.00	1.00	1.00	1.00	1.00
Initial Bse:	398	205	141	13	48	22
Added Vol:	0	0	0	0	0	0
ATI:	0	0	0	0	0	0
Initial Fut:	398	205	141	13	48	22
User Adj:	1.00	1.00	1.00	1.00	1.00	1.00
PHF Adj:	1.00	1.00	1.00	1.00	1.00	1.00
PHF Volume:	398	205	141	13	48	22
Reduct Vol:	0	0	0	0	0	0
Reduced Vol:	398	205	141	13	48	22
PCE Adj:	1.00	1.00	1.00	1.00	1.00	1.00
MLF Adj:	1.00	1.00	1.00	1.00	1.00	1.00
Final Volume:	398	205	141	13	48	22

Saturation Flow Module:	North Bound			South Bound			East Bound			West Bound		
Sat/Lane:	1900	1900	1900	1900	1900	1900	1900	1900	1900	1900	1900	1900
Adjustment:	0.92	1.00	0.92	0.92	0.92	0.92	0.92	1.00	0.92	0.92	0.97	0.95
Lanes:	1.00	1.00	1.00	0.16	0.58	0.26	1.00	2.00	1.00	1.00	1.96	0.04
Final Sat.:	1750	1900	1750	274	1012	464	1750	3800	1750	1750	3619	81

Capacity Analysis Module:	North Bound			South Bound			East Bound			West Bound		
Vol/Sat:	0.23	0.11	0.08	0.05	0.05	0.05	0.01	0.10	0.06	0.03	0.20	0.20
Crit Moves:	****			****			****			****		
Green Time:	53.4	53.4	53.4	11.1	11.1	11.1	7.0	35.1	35.1	18.4	46.5	46.5
Volume/Cap:	0.55	0.26	0.20	0.55	0.55	0.55	0.10	0.38	0.23	0.24	0.55	0.55
Delay/Veh:	30.2	25.5	24.7	61.5	61.5	61.5	58.9	38.8	37.2	50.1	34.0	34.0
User DelAdj:	1.00	1.00	1.00	1.00	1.00	1.00	1.00	1.00	1.00	1.00	1.00	1.00
AdjDel/Veh:	30.2	25.5	24.7	61.5	61.5	61.5	58.9	38.8	37.2	50.1	34.0	34.0
LOS by Move:	C	C	C	E	E	E	E+	D+	D+	D	C-	C-
HCM2kAvgQ:	13	5	4	4	4	4	0	6	4	2	12	12

Note: Queue reported is the number of cars per lane.

City of San Jose
Citywide Traffic Database
(updated July 2, 2014)

Level Of Service Computation Report
2000 HCM Operations (Future Volume Alternative)
Existing (PM)

Intersection #3653: LINCOLN/SAN CARLOS

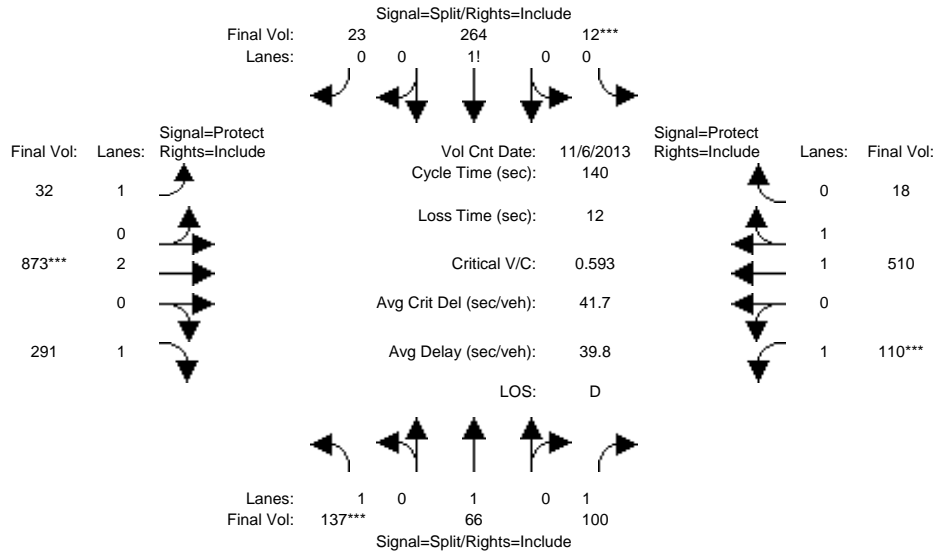

Approach:	North Bound			South Bound			East Bound			West Bound		
	L	T	R	L	T	R	L	T	R	L	T	R
Min. Green:	10	10	10	10	10	10	7	10	10	7	10	10
Y+R:	4.0	4.0	4.0	4.0	4.0	4.0	4.0	4.0	4.0	4.0	4.0	4.0
Volume Module: >> Count Date: 6 Nov 2013 << 5:00-6:00PM												
Base Vol:	137	66	100	12	264	23	32	873	291	110	510	18
Growth Adj:	1.00	1.00	1.00	1.00	1.00	1.00	1.00	1.00	1.00	1.00	1.00	1.00
Initial Bse:	137	66	100	12	264	23	32	873	291	110	510	18
Added Vol:	0	0	0	0	0	0	0	0	0	0	0	0
ATI:	0	0	0	0	0	0	0	0	0	0	0	0
Initial Fut:	137	66	100	12	264	23	32	873	291	110	510	18
User Adj:	1.00	1.00	1.00	1.00	1.00	1.00	1.00	1.00	1.00	1.00	1.00	1.00
PHF Adj:	1.00	1.00	1.00	1.00	1.00	1.00	1.00	1.00	1.00	1.00	1.00	1.00
PHF Volume:	137	66	100	12	264	23	32	873	291	110	510	18
Reduct Vol:	0	0	0	0	0	0	0	0	0	0	0	0
Reduced Vol:	137	66	100	12	264	23	32	873	291	110	510	18
PCE Adj:	1.00	1.00	1.00	1.00	1.00	1.00	1.00	1.00	1.00	1.00	1.00	1.00
MLF Adj:	1.00	1.00	1.00	1.00	1.00	1.00	1.00	1.00	1.00	1.00	1.00	1.00
Final Volume:	137	66	100	12	264	23	32	873	291	110	510	18
Saturation Flow Module:												
Sat/Lane:	1900	1900	1900	1900	1900	1900	1900	1900	1900	1900	1900	1900
Adjustment:	0.92	1.00	0.92	0.92	0.92	0.92	0.92	1.00	0.92	0.92	0.97	0.95
Lanes:	1.00	1.00	1.00	0.04	0.88	0.08	1.00	2.00	1.00	1.00	1.93	0.07
Final Sat.:	1750	1900	1750	70	1545	135	1750	3800	1750	1750	3574	126
Capacity Analysis Module:												
Vol/Sat:	0.08	0.03	0.06	0.17	0.17	0.17	0.02	0.23	0.17	0.06	0.14	0.14
Crit Moves:	****			****				****		****		
Green Time:	18.5	18.5	18.5	40.4	40.4	40.4	17.9	54.3	54.3	14.9	51.2	51.2
Volume/Cap:	0.59	0.26	0.43	0.59	0.59	0.59	0.14	0.59	0.43	0.59	0.39	0.39
Delay/Veh:	61.3	55.2	57.2	44.6	44.6	44.6	54.5	34.7	31.9	64.7	33.0	33.0
User DelAdj:	1.00	1.00	1.00	1.00	1.00	1.00	1.00	1.00	1.00	1.00	1.00	1.00
AdjDel/Veh:	61.3	55.2	57.2	44.6	44.6	44.6	54.5	34.7	31.9	64.7	33.0	33.0
LOS by Move:	E	E+	E+	D	D	D	D-	C-	C	E	C-	C-
HCM2kAvgQ:	7	3	5	12	12	12	1	15	10	6	8	8

Note: Queue reported is the number of cars per lane.

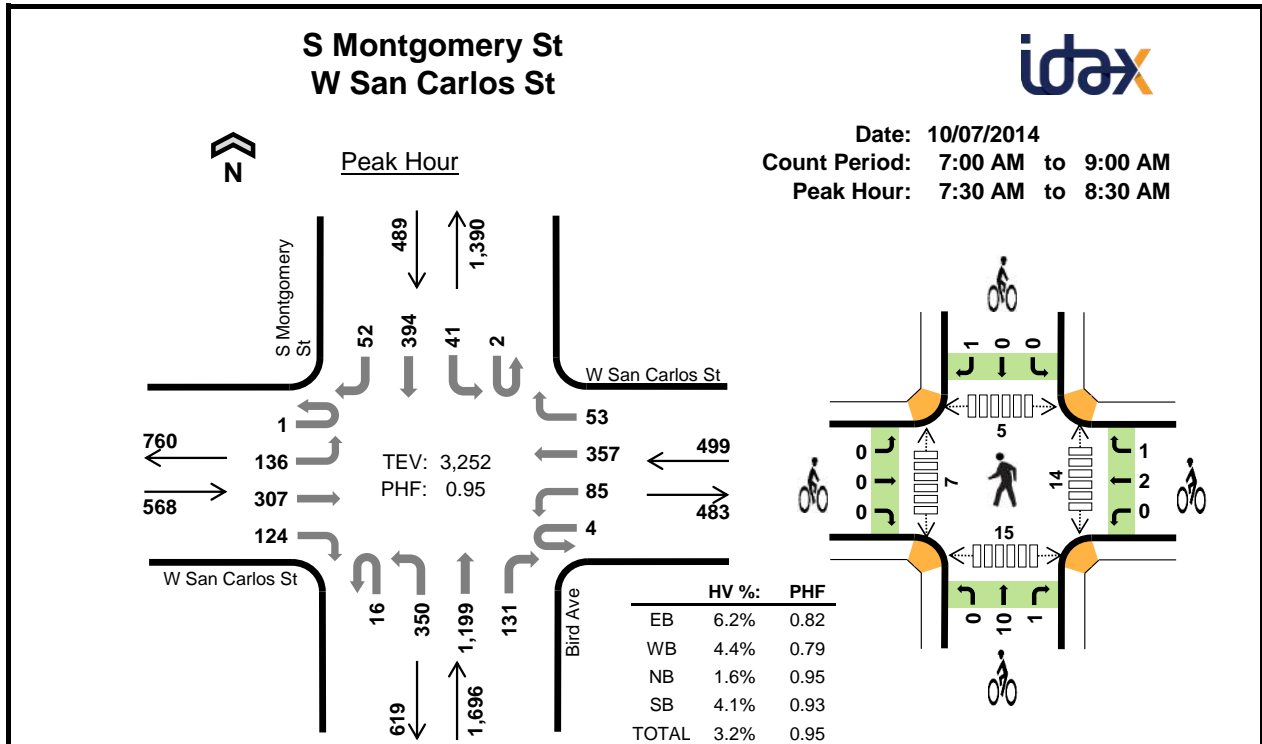

Two-Hour Count Summaries

Interval Start	W San Carlos St Eastbound				W San Carlos St Westbound				Bird Ave Northbound				S Montgomery St Southbound				15-min Total	Rolling One Hour	
	UT	LT	TH	RT	UT	LT	TH	RT	UT	LT	TH	RT	UT	LT	TH	RT			
	7:00 AM	0	12	35	15	0	16	77	16	2	83	161	16	0	5	46			6
7:15 AM	0	25	51	22	0	9	98	18	2	101	253	30	0	6	66	10	691	0	
7:30 AM	0	39	54	37	1	24	120	13	1	83	285	17	0	8	107	14	803	0	
7:45 AM	1	26	56	33	2	16	75	15	6	93	306	25	1	16	105	10	786	2,770	
8:00 AM	0	39	108	26	1	27	90	14	7	76	320	33	0	9	87	16	853	3,133	
8:15 AM	0	32	89	28	0	18	72	11	2	98	288	56	1	8	95	12	810	3,252	
8:30 AM	0	39	124	28	0	9	112	10	2	74	208	56	0	5	89	22	778	3,227	
8:45 AM	0	28	94	22	1	14	88	15	3	79	250	59	1	9	72	20	755	3,196	
Count Total	1	240	611	211	5	133	732	112	25	687	2071	292	3	66	667	110	5,966	0	
Peak Hour	All	1	136	307	124	4	85	357	53	16	350	1199	131	2	41	394	52	3,252	0
	HV	0	4	20	11	0	5	15	2	0	8	17	2	0	2	13	5	104	0
	HV%	0%	3%	7%	9%	0%	6%	4%	4%	0%	2%	1%	2%	0%	5%	3%	10%	3%	0

Note: Two-hour count summary volumes include heavy vehicles but exclude bicycles in overall count.

Interval Start	Heavy Vehicle Totals					Bicycles					Pedestrians (Crossing Leg)				
	EB	WB	NB	SB	Total	EB	WB	NB	SB	Total	East	West	North	South	Total
7:00 AM	8	6	1	1	16	1	4	3	0	8	1	2	2	6	11
7:15 AM	7	5	8	3	23	0	0	2	0	2	3	7	0	4	14
7:30 AM	6	4	8	3	21	0	1	5	0	6	6	5	2	4	17
7:45 AM	3	8	8	5	24	0	0	2	0	2	2	1	2	6	11
8:00 AM	16	6	3	2	27	0	2	3	1	6	0	1	0	3	4
8:15 AM	10	4	8	10	32	0	0	1	0	1	6	0	1	2	9
8:30 AM	7	6	8	4	25	0	0	2	0	2	3	2	0	4	9
8:45 AM	5	9	11	8	33	2	1	1	1	5	0	2	2	1	5
Count Total	62	48	55	36	201	3	8	19	2	32	21	20	9	30	80
Peak Hour	35	22	27	20	104	0	3	11	1	15	14	7	5	15	41

Two-Hour Count Summaries - Heavy Vehicles																		
Interval Start	W San Carlos St				W San Carlos St				Bird Ave				S Montgomery St				15-min Total	Rolling One Hour
	Eastbound				Westbound				Northbound				Southbound					
	UT	LT	TH	RT	UT	LT	TH	RT	UT	LT	TH	RT	UT	LT	TH	RT		
7:00 AM	0	0	5	3	0	3	3	0	0	0	1	0	0	0	1	0	16	0
7:15 AM	0	2	2	3	0	0	4	1	0	1	6	1	0	0	2	1	23	0
7:30 AM	0	1	4	1	0	0	4	0	0	3	4	1	0	0	1	2	21	0
7:45 AM	0	0	1	2	0	2	5	1	0	1	7	0	0	1	3	1	24	84
8:00 AM	0	3	10	3	0	3	3	0	0	2	1	0	0	1	1	0	27	95
8:15 AM	0	0	5	5	0	0	3	1	0	2	5	1	0	0	8	2	32	104
8:30 AM	0	0	5	2	0	0	6	0	0	3	3	2	0	0	2	2	25	108
8:45 AM	0	1	3	1	0	0	8	1	0	3	8	0	0	0	7	1	33	117
Count Total	0	7	35	20	0	8	36	4	0	15	35	5	0	2	25	9	201	0
Peak Hour	0	4	20	11	0	5	15	2	0	8	17	2	0	2	13	5	104	0

Two-Hour Count Summaries - Bikes														
Interval Start	W San Carlos St			W San Carlos St			Bird Ave			S Montgomery St			15-min Total	Rolling One Hour
	Eastbound			Westbound			Northbound			Southbound				
	LT	TH	RT	LT	TH	RT	LT	TH	RT	LT	TH	RT		
7:00 AM	0	1	0	0	4	0	0	3	0	0	0	0	8	0
7:15 AM	0	0	0	0	0	0	0	2	0	0	0	0	2	0
7:30 AM	0	0	0	0	1	0	0	5	0	0	0	0	6	0
7:45 AM	0	0	0	0	0	0	0	2	0	0	0	0	2	18
8:00 AM	0	0	0	0	1	1	0	2	1	0	0	1	6	16
8:15 AM	0	0	0	0	0	0	0	1	0	0	0	0	1	15
8:30 AM	0	0	0	0	0	0	0	2	0	0	0	0	2	11
8:45 AM	0	2	0	0	0	1	0	1	0	0	0	1	5	14
Count Total	0	3	0	0	6	2	0	18	1	0	0	2	32	0
Peak Hour	0	0	0	0	2	1	0	10	1	0	0	1	15	0

Note: U-Turn volumes for bikes are included in Left-Turn, if any.

LOCATION: Bird Ave (Rte 82) -- E San Carlos St (Rte 82)
CITY/STATE: San Jose, CA

CLIENT ID: 3077

QC JOB #: 12781614

DATE: Thu, Sep 18 2014

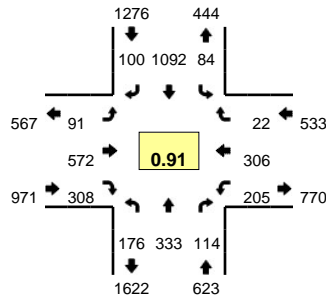

Peak-Hour: 4:55 PM -- 5:55 PM
Peak 15-Min: 5:10 PM -- 5:25 PM

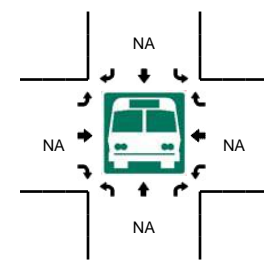
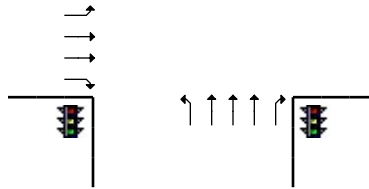
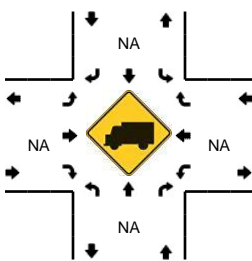
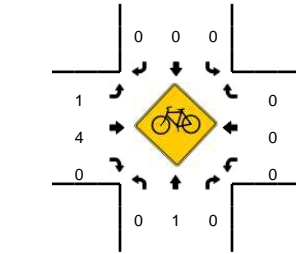
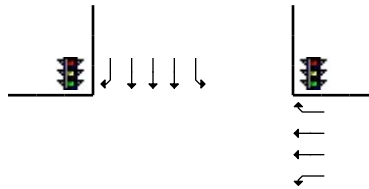
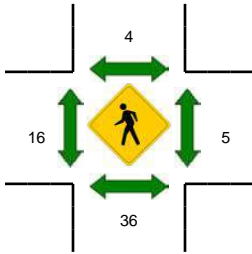
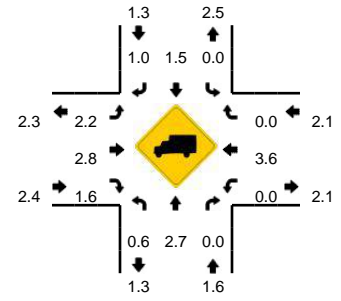

5-Min Count Period Beginning At	Bird Ave (Rte 82) (Northbound)				Bird Ave (Rte 82) (Southbound)				E San Carlos St (Rte 82) (Eastbound)				E San Carlos St (Rte 82) (Westbound)				Total	Hourly Totals
	Left	Thru	Right	U	Left	Thru	Right	U	Left	Thru	Right	U	Left	Thru	Right	U		
4:00 PM	9	28	6	1	4	51	5	0	10	31	26	1	12	15	5	0	204	
4:05 PM	12	18	4	1	4	41	5	0	5	53	21	0	13	21	3	0	201	
4:10 PM	7	28	6	0	4	75	3	0	4	12	29	0	18	23	4	0	213	
4:15 PM	6	25	6	3	9	53	4	0	1	42	16	0	9	35	3	0	212	
4:20 PM	4	24	6	2	3	63	8	0	3	17	19	0	17	28	1	0	195	
4:25 PM	12	14	4	0	4	40	5	0	11	45	18	0	11	21	2	0	187	
4:30 PM	5	27	12	1	2	56	8	0	7	25	29	0	14	14	1	0	201	
4:35 PM	13	25	9	1	0	53	6	0	4	41	27	0	7	34	1	0	221	
4:40 PM	8	26	7	0	0	57	5	0	4	31	23	0	17	16	1	0	195	
4:45 PM	14	15	5	2	6	56	6	0	13	50	14	1	11	22	1	0	216	
4:50 PM	7	30	10	2	5	83	11	0	4	21	20	1	19	26	3	0	242	
4:55 PM	16	21	8	1	2	60	9	0	6	58	25	0	9	27	6	0	248	2535
5:00 PM	6	31	8	2	11	84	7	0	9	26	28	0	16	22	2	0	252	2583
5:05 PM	16	24	5	3	7	53	4	0	7	56	31	0	18	21	3	0	248	2630
5:10 PM	7	34	7	2	3	107	6	0	12	42	17	1	23	23	2	0	286	2703
5:15 PM	18	24	6	0	13	82	10	0	6	46	35	0	15	47	2	0	304	2795
5:20 PM	14	41	18	1	10	128	6	0	11	43	19	1	24	32	0	0	348	2948
5:25 PM	13	22	3	1	7	98	5	0	6	58	33	0	13	23	1	0	283	3044
5:30 PM	10	24	11	0	5	99	11	0	11	43	28	0	19	25	2	0	288	3131
5:35 PM	11	36	9	3	6	89	13	0	2	49	18	0	15	28	0	0	279	3189
5:40 PM	14	27	10	3	8	122	13	0	7	49	20	0	16	19	2	0	310	3304
5:45 PM	22	26	13	1	4	78	10	0	3	53	31	0	20	32	2	0	295	3383
5:50 PM	12	23	16	0	8	92	6	0	9	49	23	0	17	7	0	0	262	3403
5:55 PM	11	24	7	4	4	52	3	0	4	54	29	0	17	30	2	0	241	3396
Peak 15-Min Flowrates	Northbound				Southbound				Eastbound				Westbound				Total	
	Left	Thru	Right	U	Left	Thru	Right	U	Left	Thru	Right	U	Left	Thru	Right	U		
All Vehicles	156	396	124	12	104	1268	88	0	116	524	284	8	248	408	16	0	3752	
Heavy Trucks	0	8	0		0	20	0		4	20	0		0	12	0		64	
Pedestrians		64				0				28				4			96	
Bicycles	0	1	0		0	0	0		0	1	0		0	0	0		2	
Railroad																		
Stopped Buses																		

Comments:

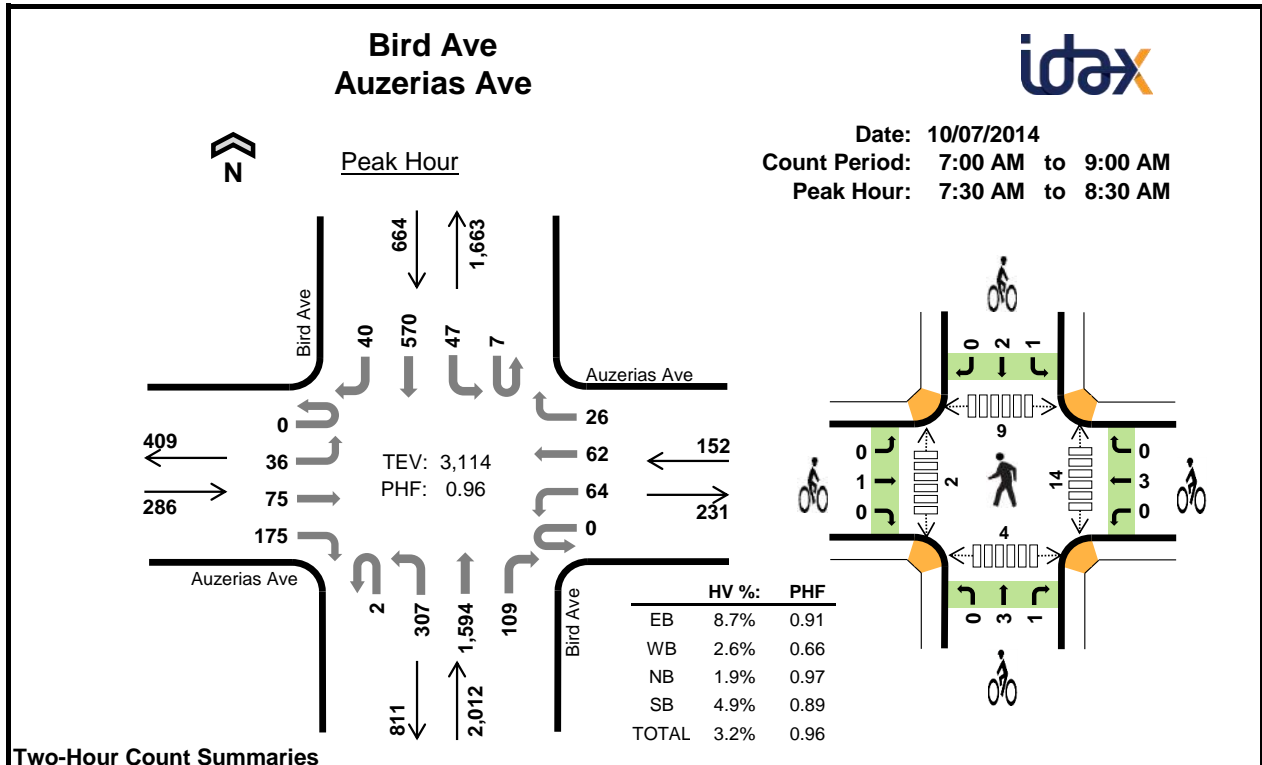

Two-Hour Count Summaries

Interval Start	Auzerias Ave Eastbound				Auzerias Ave Westbound				Bird Ave Northbound				Bird Ave Southbound				15-min Total	Rolling One Hour	
	UT	LT	TH	RT	UT	LT	TH	RT	UT	LT	TH	RT	UT	LT	TH	RT			
7:00 AM	0	4	5	31	0	21	14	7	0	74	263	11	1	8	76	10	525	0	
7:15 AM	0	2	14	31	0	12	21	7	0	91	355	22	3	7	97	8	670	0	
7:30 AM	0	8	9	55	0	12	11	7	0	81	369	25	1	9	161	16	764	0	
7:45 AM	0	11	20	48	0	32	22	4	0	80	400	27	1	19	138	7	809	2,768	
8:00 AM	0	8	29	32	0	10	14	9	2	68	407	32	3	8	152	11	785	3,028	
8:15 AM	0	9	17	40	0	10	15	6	0	78	418	25	2	11	119	6	756	3,114	
8:30 AM	0	16	17	31	0	10	11	9	0	70	309	29	1	11	123	8	645	2,995	
8:45 AM	0	11	24	44	0	8	15	8	0	55	362	25	1	9	101	5	668	2,854	
Count Total	0	69	135	312	0	115	123	57	2	597	2883	196	13	82	967	71	5,622	0	
Peak Hour	All	0	36	75	175	0	64	62	26	2	307	1594	109	7	47	570	40	3,114	0
	HV	0	1	7	17	0	0	4	0	0	15	21	2	0	3	25	4	99	0
	HV%	-	3%	9%	10%	-	0%	6%	0%	0%	5%	1%	2%	0%	6%	4%	10%	3%	0

Note: Two-hour count summary volumes include heavy vehicles but exclude bicycles in overall count.

Interval Start	Heavy Vehicle Totals					Bicycles					Pedestrians (Crossing Leg)				
	EB	WB	NB	SB	Total	EB	WB	NB	SB	Total	East	West	North	South	Total
7:00 AM	5	1	9	7	22	2	3	3	2	10	4	3	3	3	13
7:15 AM	8	2	11	7	28	1	2	3	2	8	1	3	3	1	8
7:30 AM	9	2	12	5	28	0	0	1	1	2	0	0	1	0	1
7:45 AM	5	1	9	9	24	1	2	0	0	3	4	0	3	1	8
8:00 AM	8	0	8	9	25	0	1	2	0	3	6	0	3	0	9
8:15 AM	3	1	9	9	22	0	0	1	2	3	4	2	2	3	11
8:30 AM	5	2	10	10	27	0	1	0	0	1	1	3	4	3	11
8:45 AM	6	5	18	8	37	0	3	1	0	4	0	3	3	4	10
Count Total	49	14	86	64	213	4	12	11	7	34	20	14	22	15	71
Peak Hour	25	4	38	32	99	1	3	4	3	11	14	2	9	4	29

Two-Hour Count Summaries - Heavy Vehicles																		
Interval Start	Auzerias Ave				Auzerias Ave				Bird Ave				Bird Ave				15-min Total	Rolling One Hour
	Eastbound				Westbound				Northbound				Southbound					
	UT	LT	TH	RT	UT	LT	TH	RT	UT	LT	TH	RT	UT	LT	TH	RT		
7:00 AM	0	0	1	4	0	0	1	0	0	7	2	0	0	0	4	3	22	0
7:15 AM	0	0	0	8	0	1	0	1	0	3	8	0	0	0	7	0	28	0
7:30 AM	0	0	0	9	0	0	2	0	0	3	7	2	0	1	3	1	28	0
7:45 AM	0	1	1	3	0	0	1	0	0	2	7	0	0	1	7	1	24	102
8:00 AM	0	0	4	4	0	0	0	0	0	6	2	0	0	1	6	2	25	105
8:15 AM	0	0	2	1	0	0	1	0	0	4	5	0	0	0	9	0	22	99
8:30 AM	0	2	0	3	0	0	0	2	0	7	3	0	0	1	9	0	27	98
8:45 AM	0	1	0	5	0	1	2	2	0	9	9	0	0	0	8	0	37	111
Count Total	0	4	8	37	0	2	7	5	0	41	43	2	0	4	53	7	213	0
Peak Hour	0	1	7	17	0	0	4	0	0	15	21	2	0	3	25	4	99	0

Two-Hour Count Summaries - Bikes														
Interval Start	Auzerias Ave			Auzerias Ave			Bird Ave			Bird Ave			15-min Total	Rolling One Hour
	Eastbound			Westbound			Northbound			Southbound				
	LT	TH	RT	LT	TH	RT	LT	TH	RT	LT	TH	RT		
7:00 AM	0	2	0	0	3	0	0	2	1	0	2	0	10	0
7:15 AM	0	1	0	0	2	0	0	3	0	0	2	0	8	0
7:30 AM	0	0	0	0	0	0	0	1	0	0	1	0	2	0
7:45 AM	0	1	0	0	2	0	0	0	0	0	0	0	3	23
8:00 AM	0	0	0	0	1	0	0	1	1	0	0	0	3	16
8:15 AM	0	0	0	0	0	0	0	1	0	1	1	0	3	11
8:30 AM	0	0	0	0	1	0	0	0	0	0	0	0	1	10
8:45 AM	0	0	0	0	3	0	0	1	0	0	0	0	4	11
Count Total	0	4	0	0	12	0	0	9	2	1	6	0	34	0
Peak Hour	0	1	0	0	3	0	0	3	1	1	2	0	11	0

Note: U-Turn volumes for bikes are included in Left-Turn, if any.

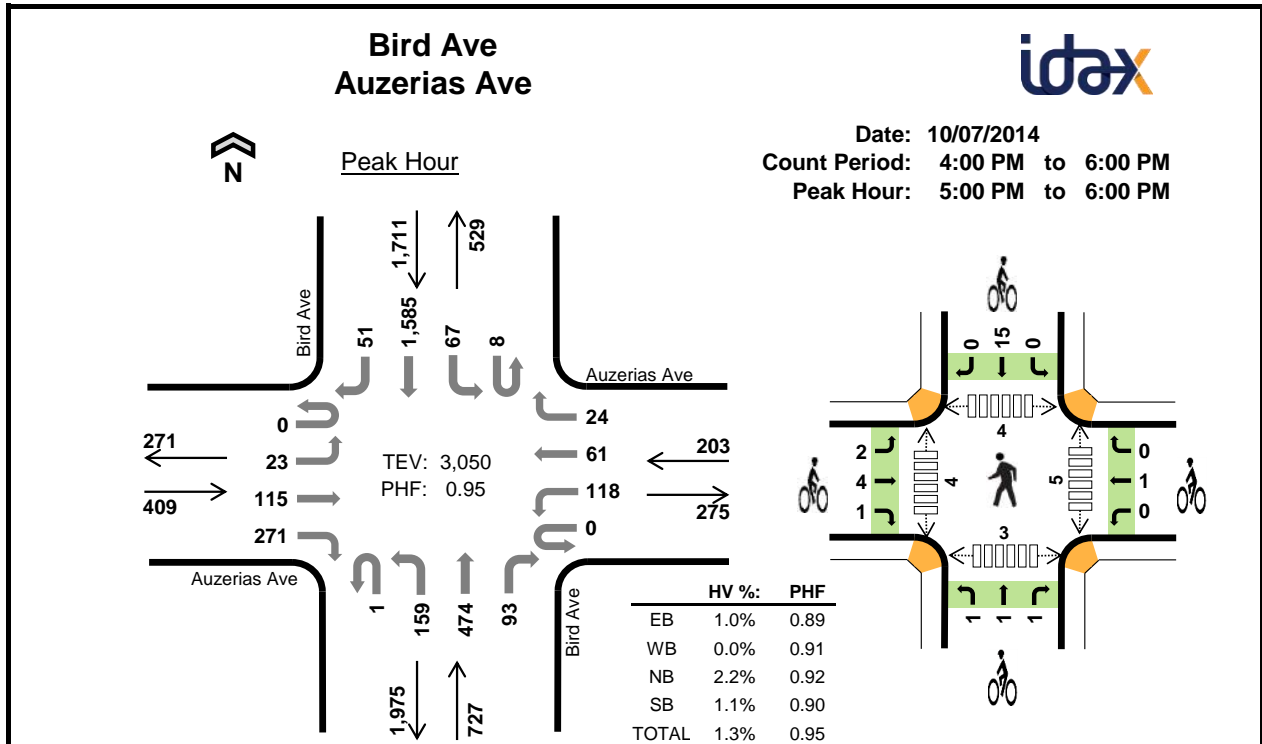

Two-Hour Count Summaries

Interval Start	Auzerias Ave Eastbound				Auzerias Ave Westbound				Bird Ave Northbound				Bird Ave Southbound				15-min Total	Rolling One Hour	
	UT	LT	TH	RT	UT	LT	TH	RT	UT	LT	TH	RT	UT	LT	TH	RT			
4:00 PM	0	10	39	68	0	18	11	10	0	29	110	18	5	18	227	2	565	0	
4:15 PM	0	9	31	46	0	25	9	7	0	43	132	12	4	9	230	10	567	0	
4:30 PM	0	4	37	67	0	17	9	7	0	41	119	31	5	17	287	4	645	0	
4:45 PM	0	7	43	57	0	31	9	3	0	39	135	32	3	14	276	6	655	2,432	
5:00 PM	0	11	24	80	0	24	12	7	1	46	114	22	4	16	354	13	728	2,595	
5:15 PM	0	6	26	57	0	38	12	6	0	40	114	25	0	26	441	10	801	2,829	
5:30 PM	0	3	34	57	0	25	23	8	0	36	103	29	1	13	423	12	767	2,951	
5:45 PM	0	3	31	77	0	31	14	3	0	37	143	17	3	12	367	16	754	3,050	
Count Total	0	53	265	509	0	209	99	51	1	311	970	186	25	125	2605	73	5,482	0	
Peak Hour	All	0	23	115	271	0	118	61	24	1	159	474	93	8	67	1585	51	3,050	0
	HV	0	0	1	3	0	0	0	0	0	10	6	0	0	0	18	1	39	0
	HV%	-	0%	1%	1%	-	0%	0%	0%	0%	6%	1%	0%	0%	0%	1%	2%	1%	0

Note: Two-hour count summary volumes include heavy vehicles but exclude bicycles in overall count.

Interval Start	Heavy Vehicle Totals					Bicycles					Pedestrians (Crossing Leg)				
	EB	WB	NB	SB	Total	EB	WB	NB	SB	Total	East	West	North	South	Total
4:00 PM	2	0	9	3	14	5	2	1	1	9	3	0	0	0	3
4:15 PM	0	2	5	1	8	0	0	2	2	4	0	0	0	0	0
4:30 PM	1	1	4	0	6	0	2	0	0	2	2	0	2	0	4
4:45 PM	1	0	6	4	11	0	1	0	1	2	1	1	2	0	4
5:00 PM	1	0	6	2	9	2	0	1	2	5	0	1	1	1	3
5:15 PM	0	0	3	5	8	3	1	1	7	12	0	0	0	0	0
5:30 PM	1	0	4	4	9	2	0	0	4	6	3	1	1	2	7
5:45 PM	2	0	3	8	13	0	0	1	2	3	2	2	2	0	6
Count Total	8	3	40	27	78	12	6	6	19	43	11	5	8	3	27
Peak Hour	4	0	16	19	39	7	1	3	15	26	5	4	4	3	16

Two-Hour Count Summaries - Heavy Vehicles																		
Interval Start	Auzerias Ave				Auzerias Ave				Bird Ave				Bird Ave				15-min Total	Rolling One Hour
	Eastbound				Westbound				Northbound				Southbound					
	UT	LT	TH	RT	UT	LT	TH	RT	UT	LT	TH	RT	UT	LT	TH	RT		
4:00 PM	0	1	0	1	0	0	0	0	0	0	9	0	1	0	2	0	14	0
4:15 PM	0	0	0	0	0	0	2	0	0	0	5	0	0	0	1	0	8	0
4:30 PM	0	1	0	0	0	1	0	0	0	0	4	0	0	0	0	0	6	0
4:45 PM	0	0	0	1	0	0	0	0	0	0	6	0	0	1	3	0	11	39
5:00 PM	0	0	0	1	0	0	0	0	0	4	2	0	0	0	2	0	9	34
5:15 PM	0	0	0	0	0	0	0	0	0	2	1	0	0	0	4	1	8	34
5:30 PM	0	0	0	1	0	0	0	0	0	2	2	0	0	0	4	0	9	37
5:45 PM	0	0	1	1	0	0	0	0	0	2	1	0	0	0	8	0	13	39
Count Total	0	2	1	5	0	1	2	0	0	10	30	0	1	1	24	1	78	0
Peak Hour	0	0	1	3	0	0	0	0	0	10	6	0	0	0	18	1	39	0
Two-Hour Count Summaries - Bikes																		
Interval Start	Auzerias Ave			Auzerias Ave			Bird Ave			Bird Ave			15-min Total	Rolling One Hour				
	Eastbound			Westbound			Northbound			Southbound								
	LT	TH	RT	LT	TH	RT	LT	TH	RT	LT	TH	RT						
4:00 PM	0	2	3	0	2	0	1	0	0	0	1	0	9	0				
4:15 PM	0	0	0	0	0	0	2	0	0	0	0	2	4	0				
4:30 PM	0	0	0	0	2	0	0	0	0	0	0	0	2	0				
4:45 PM	0	0	0	0	1	0	0	0	0	0	0	1	2	17				
5:00 PM	2	0	0	0	0	0	0	0	1	0	2	0	5	13				
5:15 PM	0	2	1	0	1	0	1	0	0	0	7	0	12	21				
5:30 PM	0	2	0	0	0	0	0	0	0	0	4	0	6	25				
5:45 PM	0	0	0	0	0	0	0	1	0	0	2	0	3	26				
Count Total	2	6	4	0	6	0	4	1	1	0	19	0	43	0				
Peak Hour	2	4	1	0	1	0	1	1	1	0	15	0	26	0				
<i>Note: U-Turn volumes for bikes are included in Left-Turn, if any.</i>																		

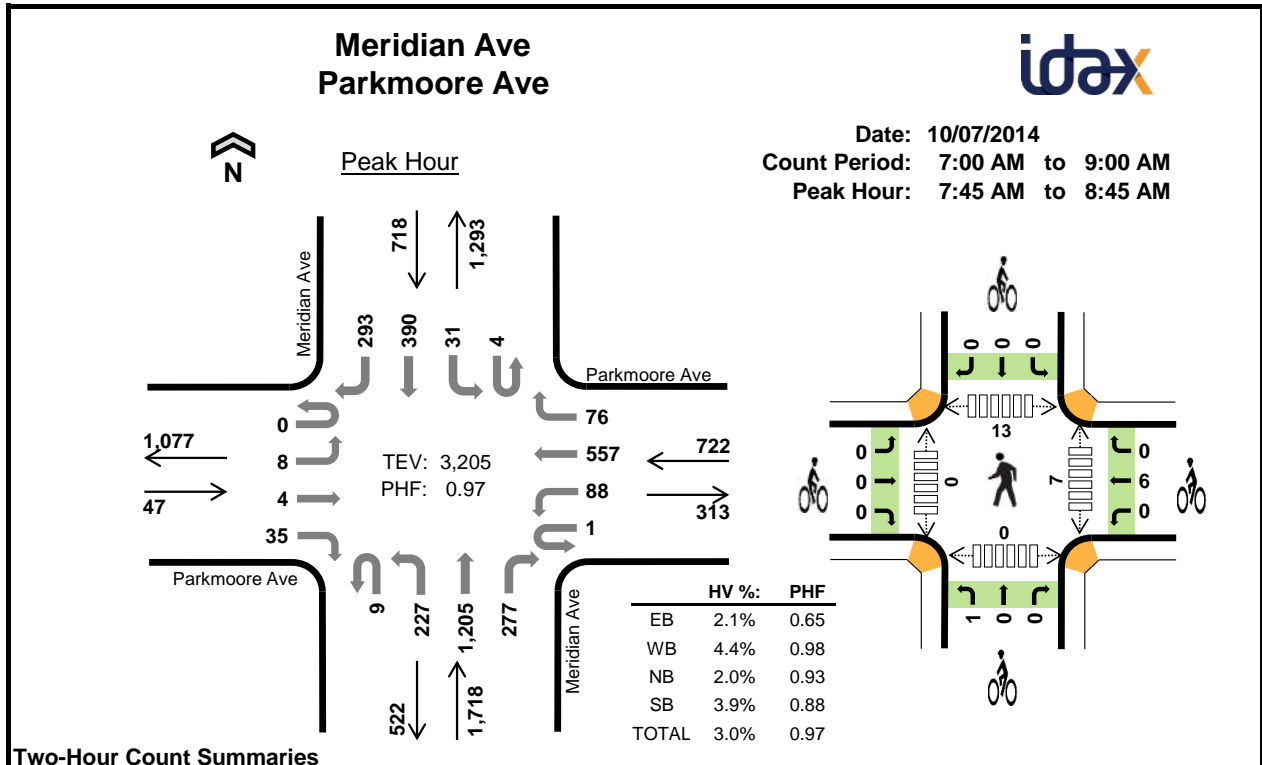

Two-Hour Count Summaries

Interval Start	Parkmoore Ave Eastbound				Parkmoore Ave Westbound				Meridian Ave Northbound				Meridian Ave Southbound				15-min Total	Rolling One Hour	
	UT	LT	TH	RT	UT	LT	TH	RT	UT	LT	TH	RT	UT	LT	TH	RT			
7:00 AM	0	2	1	7	0	16	95	16	2	41	187	34	0	0	83	66	550	0	
7:15 AM	0	3	3	10	0	15	151	21	2	52	205	60	2	6	93	73	696	0	
7:30 AM	0	3	1	16	0	27	156	29	0	49	280	23	2	4	121	67	778	0	
7:45 AM	0	0	0	7	0	22	142	21	1	50	290	48	1	11	114	77	784	2,808	
8:00 AM	0	3	2	13	1	27	132	15	4	61	276	99	1	7	114	68	823	3,081	
8:15 AM	0	1	1	5	0	23	136	24	2	54	337	71	0	6	83	74	817	3,202	
8:30 AM	0	4	1	10	0	16	147	16	2	62	302	59	2	7	79	74	781	3,205	
8:45 AM	0	4	2	6	0	21	123	20	3	53	325	53	1	6	73	67	757	3,178	
Count Total	0	20	11	74	1	167	1082	162	16	422	2202	447	9	47	760	566	5,986	0	
Peak Hour	All	0	8	4	35	1	88	557	76	9	227	1205	277	4	31	390	293	3,205	0
	HV	0	0	0	1	0	7	20	5	0	4	14	16	0	0	12	16	95	0
	HV%	-	0%	0%	3%	0%	8%	4%	7%	0%	2%	1%	6%	0%	0%	3%	5%	3%	0

Note: Two-hour count summary volumes include heavy vehicles but exclude bicycles in overall count.

Interval Start	Heavy Vehicle Totals					Bicycles					Pedestrians (Crossing Leg)				
	EB	WB	NB	SB	Total	EB	WB	NB	SB	Total	East	West	North	South	Total
7:00 AM	0	6	4	7	17	0	0	0	0	0	1	0	5	0	6
7:15 AM	0	9	4	5	18	1	0	0	0	1	2	0	4	0	6
7:30 AM	1	14	5	11	31	0	1	0	1	2	0	0	5	0	5
7:45 AM	0	8	7	10	25	0	3	0	0	3	2	0	5	0	7
8:00 AM	0	7	10	9	26	0	1	1	0	2	0	0	5	0	5
8:15 AM	0	11	11	5	27	0	1	0	0	1	0	0	1	0	1
8:30 AM	1	6	6	4	17	0	1	0	0	1	5	0	2	0	7
8:45 AM	0	6	9	3	18	0	1	0	2	3	0	0	2	0	2
Count Total	2	67	56	54	179	1	8	1	3	13	10	0	29	0	39
Peak Hour	1	32	34	28	95	0	6	1	0	7	7	0	13	0	20

Two-Hour Count Summaries - Heavy Vehicles														15-min Total	Rolling One Hour			
Interval Start	Parkmoore Ave				Parkmoore Ave				Meridian Ave				Meridian Ave					
	Eastbound				Westbound				Northbound				Southbound					
	UT	LT	TH	RT	UT	LT	TH	RT	UT	LT	TH	RT	UT	LT	TH	RT		
7:00 AM	0	0	0	0	0	1	4	1	0	1	2	1	0	0	6	1		
7:15 AM	0	0	0	0	0	0	7	2	0	0	2	2	0	0	3	2		
7:30 AM	0	0	0	1	0	1	10	3	0	1	2	2	0	0	6	5		
7:45 AM	0	0	0	0	0	2	4	2	0	0	4	3	0	0	2	8		
8:00 AM	0	0	0	0	0	2	4	1	0	3	2	5	0	0	5	4		
8:15 AM	0	0	0	0	0	2	9	0	0	1	4	6	0	0	3	2		
8:30 AM	0	0	0	1	0	1	3	2	0	0	4	2	0	0	2	2		
8:45 AM	0	0	0	0	0	2	4	0	0	0	6	3	0	1	2	0		
Count Total	0	0	0	2	0	11	45	11	0	6	26	24	0	1	29	24		
Peak Hour	0	0	0	1	0	7	20	5	0	4	14	16	0	0	12	16		

Two-Hour Count Summaries - Bikes														15-min Total	Rolling One Hour
Interval Start	Parkmoore Ave			Parkmoore Ave			Meridian Ave			Meridian Ave					
	Eastbound			Westbound			Northbound			Southbound					
	LT	TH	RT	LT	TH	RT	LT	TH	RT	LT	TH	RT			
7:00 AM	0	0	0	0	0	0	0	0	0	0	0	0			
7:15 AM	0	1	0	0	0	0	0	0	0	0	0	0			
7:30 AM	0	0	0	0	1	0	0	0	0	0	1	0			
7:45 AM	0	0	0	0	3	0	0	0	0	0	0	0			
8:00 AM	0	0	0	0	1	0	1	0	0	0	0	0			
8:15 AM	0	0	0	0	1	0	0	0	0	0	0	0			
8:30 AM	0	0	0	0	1	0	0	0	0	0	0	0			
8:45 AM	0	0	0	0	1	0	0	0	0	0	1	1			
Count Total	0	1	0	0	8	0	1	0	0	0	2	1			
Peak Hour	0	0	0	0	6	0	1	0	0	0	0	0			

Note: U-Turn volumes for bikes are included in Left-Turn, if any.

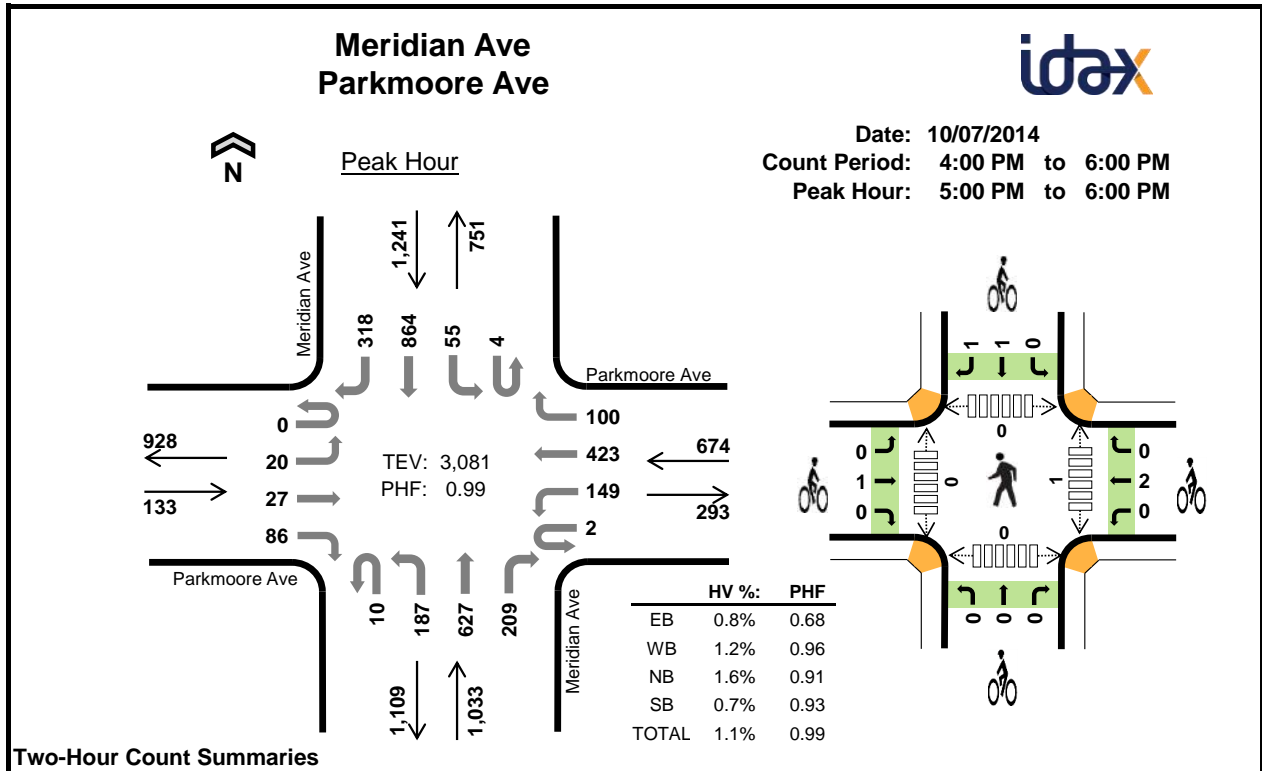

Two-Hour Count Summaries

Interval Start	Parkmoore Ave Eastbound				Parkmoore Ave Westbound				Meridian Ave Northbound				Meridian Ave Southbound				15-min Total	Rolling One Hour	
	UT	LT	TH	RT	UT	LT	TH	RT	UT	LT	TH	RT	UT	LT	TH	RT			
4:00 PM	0	10	7	25	0	46	118	38	3	52	132	57	2	17	143	77	727	0	
4:15 PM	0	4	2	30	0	45	79	26	1	40	168	66	2	12	199	72	746	0	
4:30 PM	0	6	4	27	0	49	95	21	4	43	142	45	2	11	190	76	715	0	
4:45 PM	0	6	10	15	0	34	83	21	1	52	139	82	3	22	179	89	736	2,924	
5:00 PM	0	7	12	30	1	43	94	31	2	36	151	55	0	12	192	93	759	2,956	
5:15 PM	0	4	2	18	0	45	109	22	3	51	148	51	1	15	218	79	766	2,976	
5:30 PM	0	5	8	18	0	33	112	20	2	48	153	49	2	15	249	67	781	3,042	
5:45 PM	0	4	5	20	1	28	108	27	3	52	175	54	1	13	205	79	775	3,081	
Count Total	0	46	50	183	2	323	798	206	19	374	1208	459	13	117	1575	632	6,005	0	
Peak Hour	All	0	20	27	86	2	149	423	100	10	187	627	209	4	55	864	318	3,081	0
	HV	0	0	0	1	0	0	5	3	0	1	11	4	0	0	8	1	34	0
	HV%	-	0%	0%	1%	0%	0%	1%	3%	0%	1%	2%	2%	0%	0%	1%	0%	1%	0

Note: Two-hour count summary volumes include heavy vehicles but exclude bicycles in overall count.

Interval Start	Heavy Vehicle Totals					Bicycles					Pedestrians (Crossing Leg)				
	EB	WB	NB	SB	Total	EB	WB	NB	SB	Total	East	West	North	South	Total
4:00 PM	2	5	8	3	18	0	0	0	0	0	0	0	7	0	7
4:15 PM	1	2	7	1	11	1	0	0	0	1	0	1	11	0	12
4:30 PM	0	0	5	2	7	0	0	0	0	0	0	0	0	0	0
4:45 PM	0	1	7	4	12	0	0	0	0	0	0	0	7	0	7
5:00 PM	0	4	3	1	8	1	0	0	0	1	0	0	0	0	0
5:15 PM	0	0	2	3	5	0	0	0	0	0	1	0	0	0	1
5:30 PM	0	3	6	4	13	0	1	0	1	2	0	0	0	0	0
5:45 PM	1	1	5	1	8	0	1	0	1	2	0	0	0	0	0
Count Total	4	16	43	19	82	2	2	0	2	6	1	1	25	0	27
Peak Hour	1	8	16	9	34	1	2	0	2	5	1	0	0	0	1

Two-Hour Count Summaries - Heavy Vehicles																		
Interval Start	Parkmoore Ave				Parkmoore Ave				Meridian Ave				Meridian Ave				15-min Total	Rolling One Hour
	Eastbound				Westbound				Northbound				Southbound					
	UT	LT	TH	RT	UT	LT	TH	RT	UT	LT	TH	RT	UT	LT	TH	RT		
4:00 PM	0	0	0	2	0	1	2	2	0	1	5	2	0	1	1	1	18	0
4:15 PM	0	0	0	1	0	0	1	1	0	1	2	4	0	0	1	0	11	0
4:30 PM	0	0	0	0	0	0	0	0	0	0	2	3	0	0	1	1	7	0
4:45 PM	0	0	0	0	0	0	1	0	0	0	5	2	0	1	2	1	12	48
5:00 PM	0	0	0	0	0	0	2	2	0	1	0	2	0	0	1	0	8	38
5:15 PM	0	0	0	0	0	0	0	0	0	0	2	0	0	0	3	0	5	32
5:30 PM	0	0	0	0	0	0	3	0	0	0	4	2	0	0	3	1	13	38
5:45 PM	0	0	0	1	0	0	0	1	0	0	5	0	0	0	1	0	8	34
Count Total	0	0	0	4	0	1	9	6	0	3	25	15	0	2	13	4	82	0
Peak Hour	0	0	0	1	0	0	5	3	0	1	11	4	0	0	8	1	34	0

Two-Hour Count Summaries - Bikes														
Interval Start	Parkmoore Ave			Parkmoore Ave			Meridian Ave			Meridian Ave			15-min Total	Rolling One Hour
	Eastbound			Westbound			Northbound			Southbound				
	LT	TH	RT	LT	TH	RT	LT	TH	RT	LT	TH	RT		
4:00 PM	0	0	0	0	0	0	0	0	0	0	0	0	0	0
4:15 PM	0	0	1	0	0	0	0	0	0	0	0	0	0	0
4:30 PM	0	0	0	0	0	0	0	0	0	0	0	0	0	0
4:45 PM	0	0	0	0	0	0	0	0	0	0	0	0	0	0
5:00 PM	0	1	0	0	0	0	0	0	0	0	0	0	1	2
5:15 PM	0	0	0	0	0	0	0	0	0	0	0	0	0	1
5:30 PM	0	0	0	0	1	0	0	0	0	0	1	0	2	3
5:45 PM	0	0	0	0	1	0	0	0	0	0	0	1	2	5
Count Total	0	1	1	0	2	0	0	0	0	0	1	1	6	0
Peak Hour	0	1	0	0	2	0	0	0	0	0	1	1	5	0

Note: U-Turn volumes for bikes are included in Left-Turn, if any.

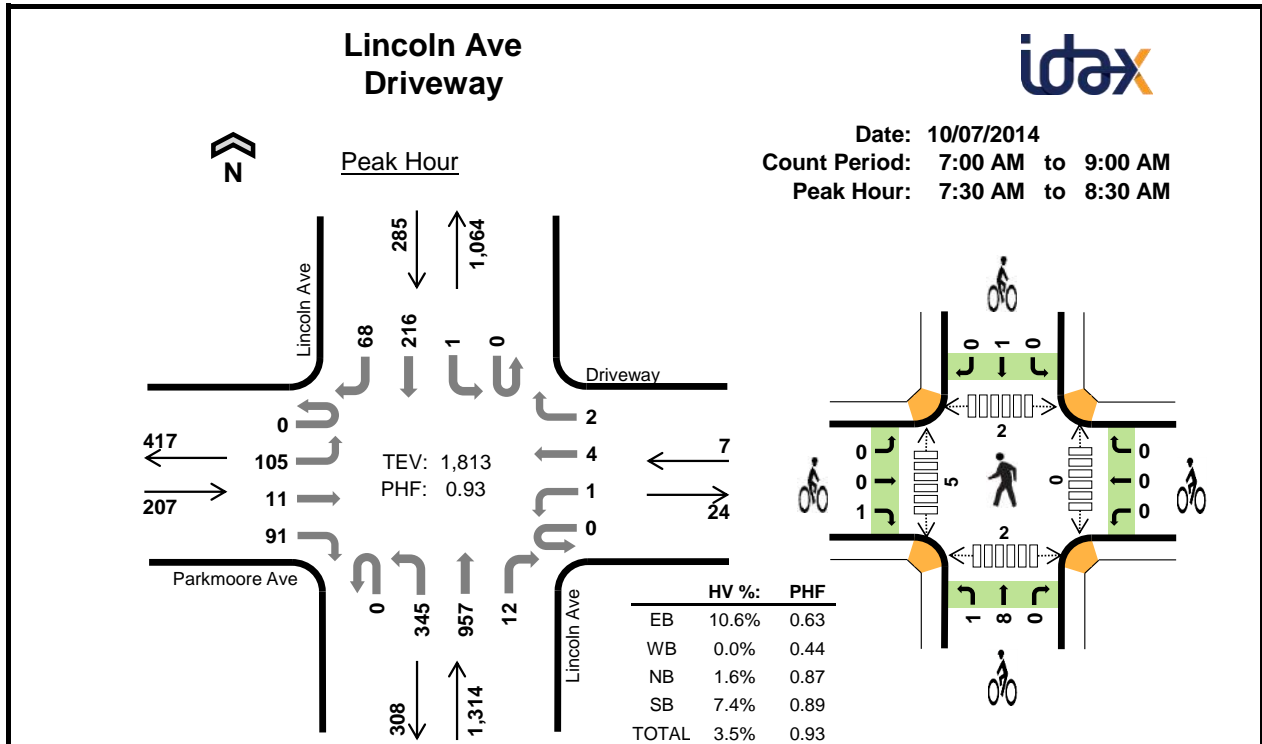

Two-Hour Count Summaries

Interval Start	Parkmoore Ave				Driveway				Lincoln Ave			Lincoln Ave			15-min Total	Rolling One Hour			
	Eastbound				Westbound				Northbound			Southbound							
	UT	LT	TH	RT	UT	LT	TH	RT	UT	LT	TH	RT	UT	LT	TH	RT			
7:00 AM	0	8	1	17	0	0	1	0	0	68	123	0	0	0	19	7	244	0	
7:15 AM	0	31	1	20	0	0	1	1	0	75	181	2	0	0	45	12	369	0	
7:30 AM	0	14	3	19	0	0	0	1	0	99	240	0	0	0	48	18	442	0	
7:45 AM	0	17	3	21	0	0	0	0	0	86	284	6	0	0	52	16	485	1,540	
8:00 AM	0	31	3	14	0	0	3	1	0	89	230	3	0	1	55	15	445	1,741	
8:15 AM	0	43	2	37	0	1	1	0	0	71	203	3	0	0	61	19	441	1,813	
8:30 AM	0	19	3	27	0	0	0	0	0	84	182	2	0	0	48	16	381	1,752	
8:45 AM	0	14	2	19	0	0	0	0	0	63	182	3	0	0	58	14	355	1,622	
Count Total	0	177	18	174	0	1	6	3	0	635	1625	19	0	1	386	117	3,162	0	
Peak Hour	All	0	105	11	91	0	1	4	2	0	345	957	12	0	1	216	68	1,813	0
	HV	0	17	0	5	0	0	0	0	0	13	8	0	0	0	11	10	64	0
	HV%	-	16%	0%	5%	-	0%	0%	0%	-	4%	1%	0%	-	0%	5%	15%	4%	0

Note: Two-hour count summary volumes include heavy vehicles but exclude bicycles in overall count.

Interval Start	Heavy Vehicle Totals					Bicycles					Pedestrians (Crossing Leg)				
	EB	WB	NB	SB	Total	EB	WB	NB	SB	Total	East	West	North	South	Total
7:00 AM	2	0	6	1	9	0	0	3	0	3	0	1	1	2	4
7:15 AM	4	0	6	2	12	0	0	6	0	6	0	4	1	2	7
7:30 AM	3	0	6	10	19	0	0	2	0	2	0	0	0	2	2
7:45 AM	4	0	6	4	14	0	0	2	0	2	0	1	0	1	
8:00 AM	5	0	4	2	11	1	0	5	1	7	0	0	1	1	
8:15 AM	10	0	5	5	20	0	0	0	0	0	0	4	1	5	
8:30 AM	3	0	5	1	9	0	0	1	1	2	0	3	1	4	
8:45 AM	2	0	4	6	12	1	0	1	0	2	0	0	1	1	
Count Total	33	0	42	31	106	2	0	20	2	24	0	13	6	6	25
Peak Hour	22	0	21	21	64	1	0	9	1	11	0	5	2	2	9

Two-Hour Count Summaries - Heavy Vehicles														15-min Total	Rolling One Hour			
Interval Start	Parkmoore Ave				Driveway				Lincoln Ave				Lincoln Ave					
	Eastbound				Westbound				Northbound				Southbound					
	UT	LT	TH	RT	UT	LT	TH	RT	UT	LT	TH	RT	UT	LT	TH	RT		
7:00 AM	0	1	0	1	0	0	0	0	0	1	5	0	0	0	1	0	9	0
7:15 AM	0	3	0	1	0	0	0	0	0	3	3	0	0	0	1	1	12	0
7:30 AM	0	2	0	1	0	0	0	0	0	3	3	0	0	0	5	5	19	0
7:45 AM	0	3	0	1	0	0	0	0	0	3	3	0	0	0	2	2	14	54
8:00 AM	0	5	0	0	0	0	0	0	0	3	1	0	0	0	2	0	11	56
8:15 AM	0	7	0	3	0	0	0	0	0	4	1	0	0	0	2	3	20	64
8:30 AM	0	2	0	1	0	0	0	0	0	1	4	0	0	0	0	1	9	54
8:45 AM	0	2	0	0	0	0	0	0	0	2	2	0	0	0	3	3	12	52
Count Total	0	25	0	8	0	0	0	0	0	20	22	0	0	0	16	15	106	0
Peak Hour	0	17	0	5	0	0	0	0	0	13	8	0	0	0	11	10	64	0

Two-Hour Count Summaries - Bikes														15-min Total	Rolling One Hour
Interval Start	Parkmoore Ave			Driveway			Lincoln Ave			Lincoln Ave					
	Eastbound			Westbound			Northbound			Southbound					
	LT	TH	RT	LT	TH	RT	LT	TH	RT	LT	TH	RT			
7:00 AM	0	0	0	0	0	0	0	3	0	0	0	0	3	0	
7:15 AM	0	0	0	0	0	0	0	6	0	0	0	0	6	0	
7:30 AM	0	0	0	0	0	0	0	2	0	0	0	0	2	0	
7:45 AM	0	0	0	0	0	0	1	1	0	0	0	0	2	13	
8:00 AM	0	0	1	0	0	0	0	5	0	0	1	0	7	17	
8:15 AM	0	0	0	0	0	0	0	0	0	0	0	0	0	11	
8:30 AM	0	0	0	0	0	0	1	0	0	0	0	1	2	11	
8:45 AM	0	0	1	0	0	0	0	1	0	0	0	0	2	11	
Count Total	0	0	2	0	0	0	2	18	0	0	1	1	24	0	
Peak Hour	0	0	1	0	0	0	1	8	0	0	1	0	11	0	

Note: U-Turn volumes for bikes are included in Left-Turn, if any.

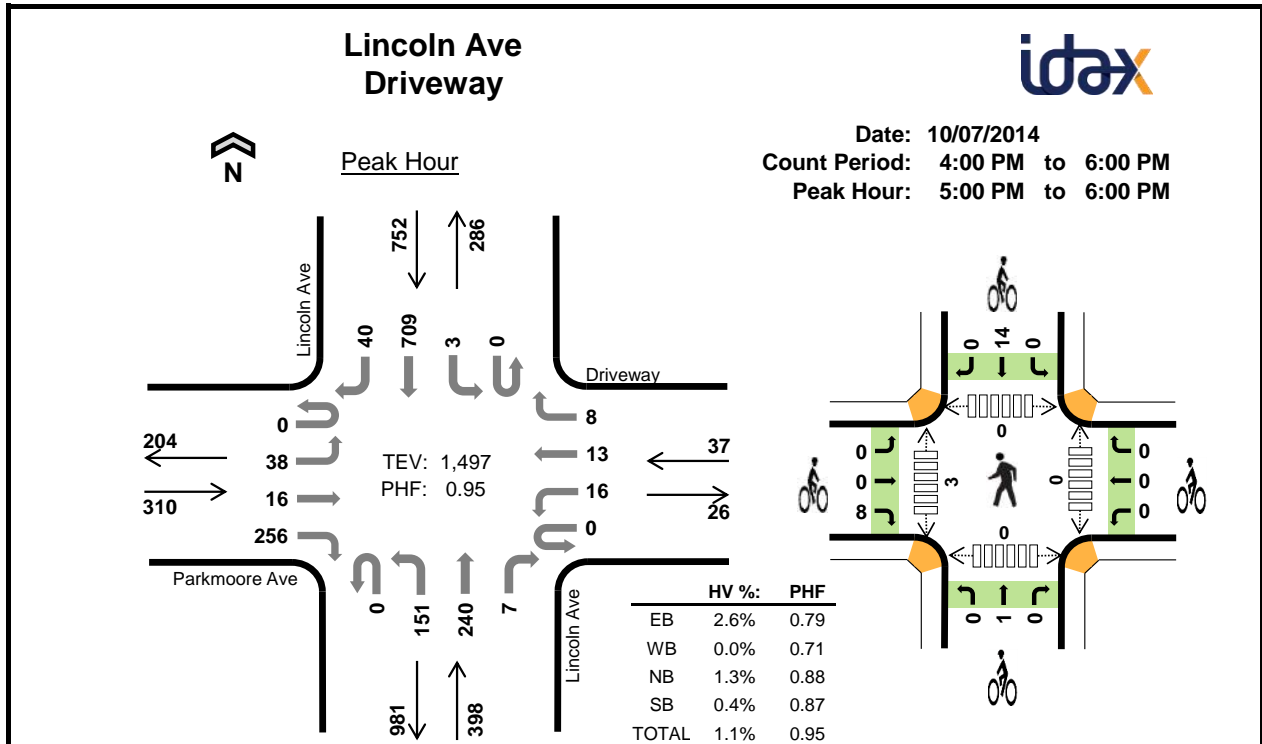

Two-Hour Count Summaries

Interval Start	Parkmoore Ave				Driveway				Lincoln Ave				Lincoln Ave				15-min Total	Rolling One Hour	
	Eastbound				Westbound				Northbound				Southbound						
	UT	LT	TH	RT	UT	LT	TH	RT	UT	LT	TH	RT	UT	LT	TH	RT			
4:00 PM	0	15	4	58	0	3	4	3	0	47	66	3	0	1	97	5	306	0	
4:15 PM	0	13	1	65	0	0	4	3	0	32	45	4	0	1	136	10	314	0	
4:30 PM	0	9	4	40	0	6	1	3	0	36	77	1	0	1	153	15	346	0	
4:45 PM	0	13	8	63	0	4	0	0	0	34	60	6	0	1	123	8	320	1,286	
5:00 PM	0	16	5	77	0	2	4	3	0	34	57	1	0	0	177	8	384	1,364	
5:15 PM	0	6	3	67	0	4	3	0	0	33	62	1	0	1	207	7	394	1,444	
5:30 PM	0	10	4	50	0	3	2	3	0	38	70	5	0	1	156	16	358	1,456	
5:45 PM	0	6	4	62	0	7	4	2	0	46	51	0	0	1	169	9	361	1,497	
Count Total	0	88	33	482	0	29	22	17	0	300	488	21	0	7	1218	78	2,783	0	
Peak Hour	All	0	38	16	256	0	16	13	8	0	151	240	7	0	3	709	40	1,497	0
	HV	0	3	0	5	0	0	0	0	0	0	5	0	0	0	1	2	16	0
	HV%	-	8%	0%	2%	-	0%	0%	0%	-	0%	2%	0%	-	0%	0%	5%	1%	0

Note: Two-hour count summary volumes include heavy vehicles but exclude bicycles in overall count.

Interval Start	Heavy Vehicle Totals					Bicycles					Pedestrians (Crossing Leg)				
	EB	WB	NB	SB	Total	EB	WB	NB	SB	Total	East	West	North	South	Total
4:00 PM	3	0	2	2	7	0	0	0	1	1	0	1	2	0	3
4:15 PM	4	0	0	1	5	0	0	1	1	2	0	1	0	0	1
4:30 PM	3	0	1	2	6	4	0	1	1	6	0	2	0	0	2
4:45 PM	3	0	0	1	4	0	0	0	0	0	0	1	2	0	3
5:00 PM	7	0	1	0	8	1	0	0	2	3	0	2	0	0	2
5:15 PM	0	0	1	1	2	0	0	0	6	6	0	0	0	0	0
5:30 PM	1	0	3	1	5	7	0	0	5	12	0	0	0	0	0
5:45 PM	0	0	0	1	1	0	0	1	1	2	0	1	0	0	1
Count Total	21	0	8	9	38	12	0	3	17	32	0	8	4	0	12
Peak Hour	8	0	5	3	16	8	0	1	14	23	0	3	0	0	3

Two-Hour Count Summaries - Heavy Vehicles																		
Interval Start	Parkmoore Ave				Driveway				Lincoln Ave				Lincoln Ave				15-min Total	Rolling One Hour
	Eastbound				Westbound				Northbound				Southbound					
	UT	LT	TH	RT	UT	LT	TH	RT	UT	LT	TH	RT	UT	LT	TH	RT		
4:00 PM	0	1	0	2	0	0	0	0	0	0	2	0	0	0	2	0	7	0
4:15 PM	0	2	0	2	0	0	0	0	0	0	0	0	0	0	1	0	5	0
4:30 PM	0	3	0	0	0	0	0	0	0	0	1	0	0	0	0	2	6	0
4:45 PM	0	1	0	2	0	0	0	0	0	0	0	0	0	0	0	1	4	22
5:00 PM	0	3	0	4	0	0	0	0	0	0	1	0	0	0	0	0	8	23
5:15 PM	0	0	0	0	0	0	0	0	0	0	1	0	0	0	1	0	2	20
5:30 PM	0	0	0	1	0	0	0	0	0	0	3	0	0	0	0	1	5	19
5:45 PM	0	0	0	0	0	0	0	0	0	0	0	0	0	0	0	1	1	16
Count Total	0	10	0	11	0	0	0	0	0	0	8	0	0	0	4	5	38	0
Peak Hour	0	3	0	5	0	0	0	0	0	0	5	0	0	0	1	2	16	0
Two-Hour Count Summaries - Bikes																		
Interval Start	Parkmoore Ave			Driveway			Lincoln Ave			Lincoln Ave			15-min Total	Rolling One Hour				
	Eastbound			Westbound			Northbound			Southbound								
	LT	TH	RT	LT	TH	RT	LT	TH	RT	LT	TH	RT						
4:00 PM	0	0	0	0	0	0	0	0	0	0	1	0	1	0				
4:15 PM	0	0	0	0	0	0	1	0	0	0	1	0	2	0				
4:30 PM	0	0	4	0	0	0	0	1	0	0	1	0	6	0				
4:45 PM	0	0	0	0	0	0	0	0	0	0	0	0	0	9				
5:00 PM	0	0	1	0	0	0	0	0	0	0	2	0	3	11				
5:15 PM	0	0	0	0	0	0	0	0	0	0	6	0	6	15				
5:30 PM	0	0	7	0	0	0	0	0	0	0	5	0	12	21				
5:45 PM	0	0	0	0	0	0	0	1	0	0	1	0	2	23				
Count Total	0	0	12	0	0	0	1	2	0	0	17	0	32	0				
Peak Hour	0	0	8	0	0	0	0	1	0	0	14	0	23	0				

Note: U-Turn volumes for bikes are included in Left-Turn, if any.

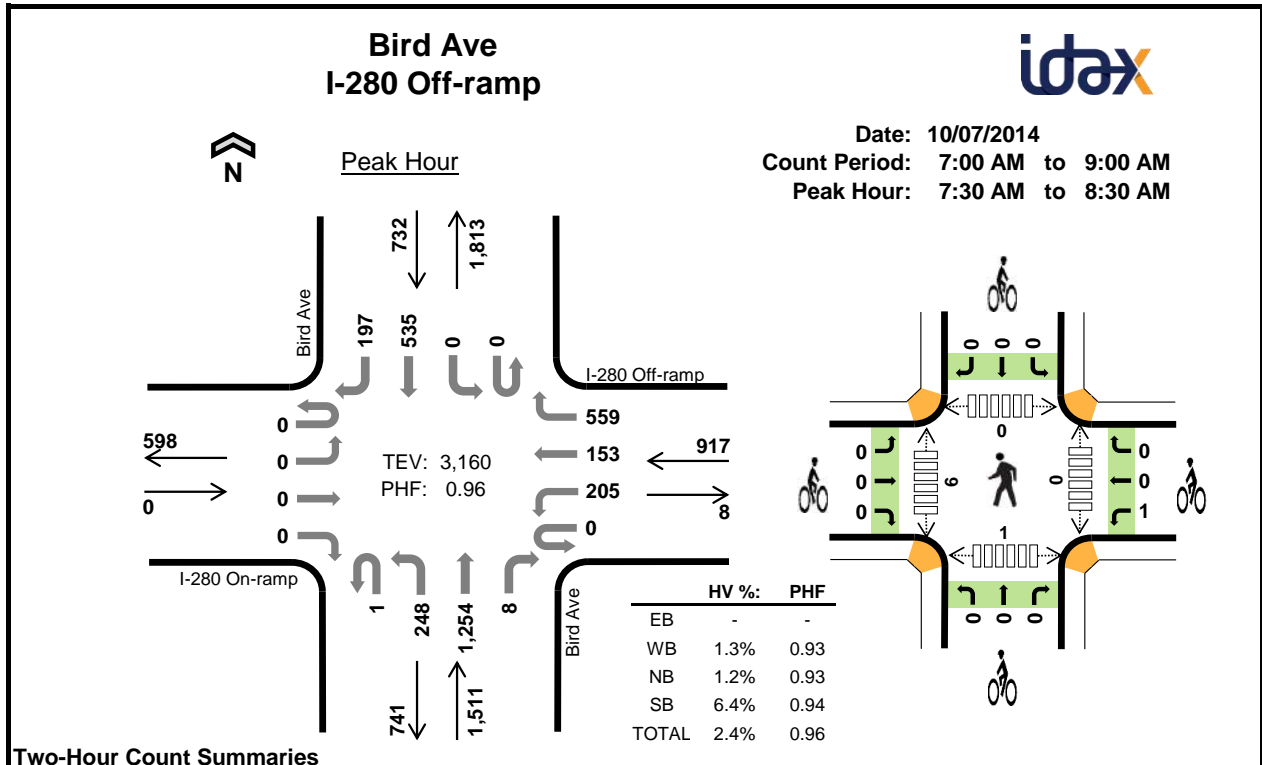

Two-Hour Count Summaries

Interval Start	I-280 On-ramp				I-280 Off-ramp				Bird Ave				Bird Ave				15-min Total	Rolling One Hour	
	Eastbound				Westbound				Northbound				Southbound						
	UT	LT	TH	RT	UT	LT	TH	RT	UT	LT	TH	RT	UT	LT	TH	RT			
7:00 AM	0	0	0	0	0	36	49	160	0	46	180	0	0	0	88	32	591	0	
7:15 AM	0	0	0	0	0	26	53	166	0	74	261	0	0	0	102	30	712	0	
7:30 AM	0	0	0	0	0	51	63	127	0	64	262	0	0	0	134	56	757	0	
7:45 AM	0	0	0	0	0	56	38	96	0	72	336	0	0	0	131	45	774	2,834	
8:00 AM	0	0	0	0	0	50	20	170	1	54	336	1	0	0	143	51	826	3,069	
8:15 AM	0	0	0	0	0	48	32	166	0	58	320	7	0	0	127	45	803	3,160	
8:30 AM	0	0	0	0	0	61	25	167	1	49	241	2	0	0	122	41	709	3,112	
8:45 AM	0	0	0	0	0	51	17	141	1	55	295	1	0	0	105	49	715	3,053	
Count Total	0	0	0	0	0	379	297	1193	3	472	2231	11	0	0	952	349	5,887	0	
Peak Hour	All	0	0	0	0	0	205	153	559	1	248	1254	8	0	0	535	197	3,160	0
	HV	0	0	0	0	0	2	0	10	0	2	16	0	0	0	34	13	77	0
	HV%	-	-	-	-	-	1%	0%	2%	0%	1%	1%	0%	-	-	6%	7%	2%	0

Note: Two-hour count summary volumes include heavy vehicles but exclude bicycles in overall count.

Interval Start	Heavy Vehicle Totals					Bicycles					Pedestrians (Crossing Leg)				
	EB	WB	NB	SB	Total	EB	WB	NB	SB	Total	East	West	North	South	Total
7:00 AM	0	3	4	10	17	0	0	0	1	1	0	1	0	0	1
7:15 AM	0	2	6	16	24	0	0	0	2	2	0	2	0	0	2
7:30 AM	0	2	5	15	22	0	1	0	0	1	0	1	0	0	1
7:45 AM	0	0	7	12	19	0	0	0	0	0	0	1	0	1	2
8:00 AM	0	6	2	10	18	0	0	0	0	0	0	1	0	0	1
8:15 AM	0	4	4	10	18	0	0	0	0	0	0	3	0	0	3
8:30 AM	0	3	4	12	19	0	0	0	1	1	0	3	0	0	3
8:45 AM	0	11	8	14	33	0	0	0	0	0	0	2	0	0	2
Count Total	0	31	40	99	170	0	1	0	4	5	0	14	0	1	15
Peak Hour	0	12	18	47	77	0	1	0	0	1	0	6	0	1	7

Two-Hour Count Summaries - Heavy Vehicles																		
Interval Start	I-280 On-ramp				I-280 Off-ramp				Bird Ave				Bird Ave				15-min Total	Rolling One Hour
	Eastbound				Westbound				Northbound				Southbound					
	UT	LT	TH	RT	UT	LT	TH	RT	UT	LT	TH	RT	UT	LT	TH	RT		
7:00 AM	0	0	0	0	0	0	0	3	0	0	4	0	0	0	8	2	17	0
7:15 AM	0	0	0	0	0	0	0	2	0	0	6	0	0	0	14	2	24	0
7:30 AM	0	0	0	0	0	2	0	0	0	1	4	0	0	0	12	3	22	0
7:45 AM	0	0	0	0	0	0	0	0	0	1	6	0	0	0	7	5	19	82
8:00 AM	0	0	0	0	0	0	0	6	0	0	2	0	0	0	8	2	18	83
8:15 AM	0	0	0	0	0	0	0	4	0	0	4	0	0	0	7	3	18	77
8:30 AM	0	0	0	0	0	0	0	3	0	0	4	0	0	0	7	5	19	74
8:45 AM	0	0	0	0	0	0	0	11	0	2	6	0	0	0	10	4	33	88
Count Total	0	0	0	0	0	2	0	29	0	4	36	0	0	0	73	26	170	0
Peak Hour	0	0	0	0	0	2	0	10	0	2	16	0	0	0	34	13	77	0
Two-Hour Count Summaries - Bikes																		
Interval Start	I-280 On-ramp			I-280 Off-ramp			Bird Ave			Bird Ave			15-min Total	Rolling One Hour				
	Eastbound			Westbound			Northbound			Southbound								
	LT	TH	RT	LT	TH	RT	LT	TH	RT	LT	TH	RT						
7:00 AM	0	0	0	0	0	0	0	0	0	0	0	0	1	0	1	0		
7:15 AM	0	0	0	0	0	0	0	0	0	0	0	0	1	1	2	0		
7:30 AM	0	0	0	1	0	0	0	0	0	0	0	0	0	0	1	0		
7:45 AM	0	0	0	0	0	0	0	0	0	0	0	0	0	0	0	4		
8:00 AM	0	0	0	0	0	0	0	0	0	0	0	0	0	0	0	3		
8:15 AM	0	0	0	0	0	0	0	0	0	0	0	0	0	0	0	1		
8:30 AM	0	0	0	0	0	0	0	0	0	0	0	0	1	0	1	1		
8:45 AM	0	0	0	0	0	0	0	0	0	0	0	0	0	0	0	1		
Count Total	0	0	0	1	0	0	0	0	0	0	0	0	3	1	5	0		
Peak Hour	0	0	0	1	0	0	0	0	0	0	0	0	0	0	1	0		

Note: U-Turn volumes for bikes are included in Left-Turn, if any.

INTERSECTION TURNING MOVEMENT COUNT SUMMARY

CLIENT: KITTELSON ASSOCIATES
 PROJECT: 2014 SCVTA CMP MONITORING
 DATE: WEDNESDAY SEPTEMBER 24, 2014
 PERIOD: 4:00 PM TO 6:00 PM
 INTERSECTION: N/S BIRD AVENUE (NORTH)
 E/W HIGHWAY 280 RAMP
 CITY: SAN JOSE

VEHICLES													
15 MIN COUNTS													
4:00 PM TO 6:00 PM													
PERIOD	1 SBRT	2 SBTH	3 SBLT	4 WBRT	5 WBTH	6 WBLT	7 NBRT	8 NBTH	9 NBLT	10 EBRT	11 EBTH	12 EBLT	TOTAL
400-415	100	226	0	63	0	65	0	100	30	0	0	0	584
415-430	84	225	0	45	0	77	0	82	38	0	0	0	551
430-445	92	229	0	43	0	75	0	111	49	0	0	0	599
445-500	118	258	0	61	1	79	0	90	35	0	0	0	642
500-515	128	293	0	61	0	81	0	107	39	0	0	0	709
515-530	173	336	0	60	2	106	0	84	30	0	0	0	791
530-545	154	339	0	47	14	99	0	107	45	0	0	0	805
545-600	134	293	0	67	6	130	0	97	41	0	0	0	768
HOUR TOTALS													
TIME	1 SBRT	2 SBTH	3 SBLT	4 WBRT	5 WBTH	6 WBLT	7 NBRT	8 NBTH	9 NBLT	10 EBRT	11 EBTH	12 EBLT	TOTAL
400-500	394	938	0	212	1	296	0	383	152	0	0	0	2376
415-515	422	1005	0	210	1	312	0	390	161	0	0	0	2501
430-530	511	1116	0	225	3	341	0	392	153	0	0	0	2741
445-545	573	1226	0	229	17	365	0	388	149	0	0	0	2947
500-600	589	1261	0	235	22	416	0	395	155	0	0	0	3073

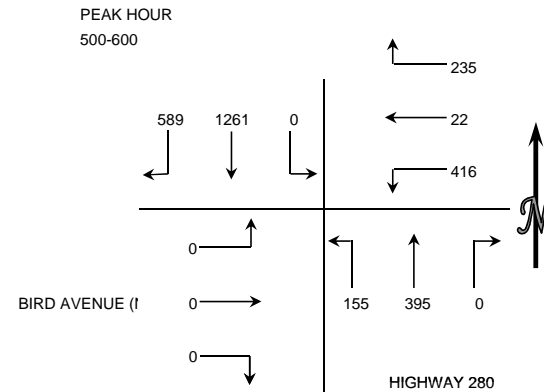

BICYCLES													
15 MIN COUNTS													
4:00 PM TO 6:00 PM													
PERIOD	1 SBRT	2 SBTH	3 SBLT	4 WBRT	5 WBTH	6 WBLT	7 NBRT	8 NBTH	9 NBLT	10 EBRT	11 EBTH	12 EBLT	TOTAL
400-415	0	2	1	0	0	0	0	0	0	0	0	0	3
415-430	0	2	0	0	0	0	0	1	0	0	0	0	3
430-445	0	1	3	0	0	0	0	0	0	0	0	0	4
445-500	0	4	1	0	0	0	0	1	0	0	0	0	6
500-515	0	5	0	0	0	0	0	1	0	0	0	0	6
515-530	0	7	0	0	0	0	0	0	0	0	0	0	7
530-545	0	8	0	0	0	0	0	1	0	0	0	0	9
545-600	0	0	0	0	0	0	0	0	0	0	0	0	0
HOUR TOTALS													
TIME	1 SBRT	2 SBTH	3 SBLT	4 WBRT	5 WBTH	6 WBLT	7 NBRT	8 NBTH	9 NBLT	10 EBRT	11 EBTH	12 EBLT	TOTAL
400-500	0	9	5	0	0	0	0	2	0	0	0	0	16
415-515	0	12	4	0	0	0	0	3	0	0	0	0	19
430-530	0	17	4	0	0	0	0	2	0	0	0	0	23
445-545	0	24	1	0	0	0	0	3	0	0	0	0	28
500-600	0	20	0	0	0	0	0	2	0	0	0	0	22

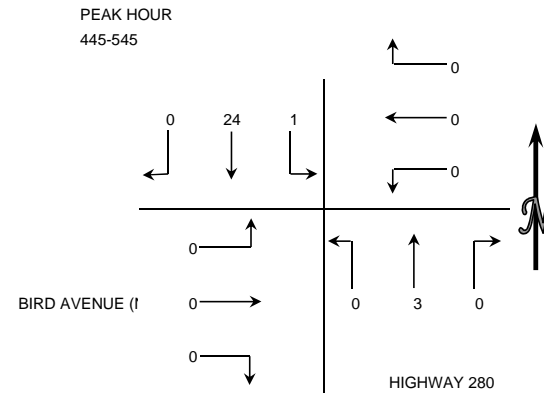

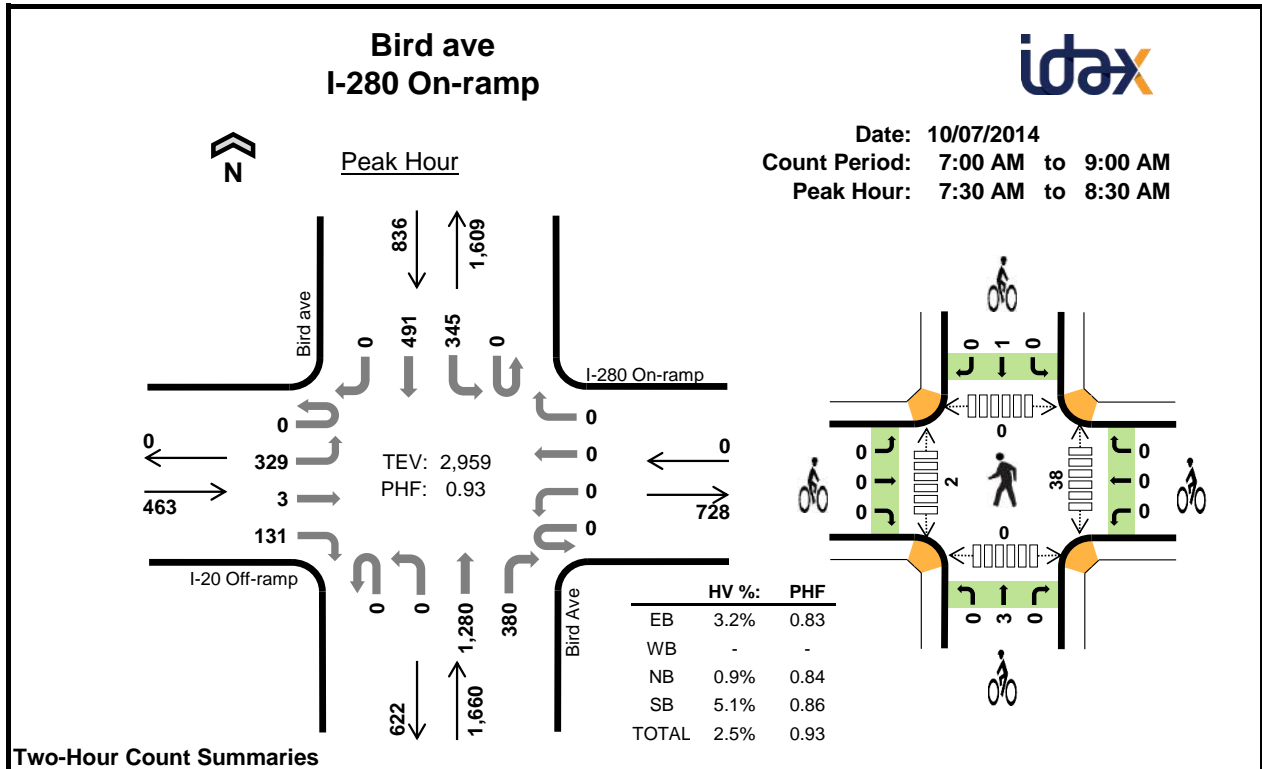

Two-Hour Count Summaries

Interval Start	I-20 Off-ramp				I-280 On-ramp				Bird Ave				Bird ave				15-min Total	Rolling One Hour
	Eastbound				Westbound				Northbound				Southbound					
	UT	LT	TH	RT	UT	LT	TH	RT	UT	LT	TH	RT	UT	LT	TH	RT		
7:00 AM	0	50	3	17	0	0	0	0	0	0	176	72	0	55	64	0	437	0
7:15 AM	0	62	0	21	0	0	0	0	1	0	263	90	0	81	63	0	581	0
7:30 AM	0	64	1	28	0	0	0	0	0	0	304	120	0	95	112	0	724	0
7:45 AM	0	82	0	35	0	0	0	0	0	0	327	94	0	94	150	0	782	2,524
8:00 AM	0	75	1	37	0	0	0	0	0	0	402	93	0	73	117	0	798	2,885
8:15 AM	0	108	1	31	0	0	0	0	0	0	247	73	0	83	112	0	655	2,959
8:30 AM	0	75	1	37	0	0	0	0	0	0	228	95	0	63	102	0	601	2,836
8:45 AM	0	124	1	30	0	0	0	0	0	0	219	65	0	75	97	0	611	2,665
Count Total	0	640	8	236	0	0	0	0	1	0	2166	702	0	619	817	0	5,189	0
Peak Hour	All	0	329	3	131	0	0	0	0	0	1280	380	0	345	491	0	2,959	0
	HV	0	13	0	2	0	0	0	0	0	12	3	0	30	13	0	73	0
	HV%	-	4%	0%	2%	-	-	-	-	-	-	1%	1%	-	9%	3%	-	2%

Note: Two-hour count summary volumes include heavy vehicles but exclude bicycles in overall count.

Interval Start	Heavy Vehicle Totals					Bicycles					Pedestrians (Crossing Leg)				
	EB	WB	NB	SB	Total	EB	WB	NB	SB	Total	East	West	North	South	Total
7:00 AM	4	0	3	6	13	0	0	1	4	5	8	3	0	0	11
7:15 AM	0	0	7	14	21	0	0	1	1	2	4	1	0	0	5
7:30 AM	3	0	5	15	23	0	0	1	1	2	6	0	0	0	6
7:45 AM	5	0	3	9	17	0	0	0	0	0	11	0	0	0	11
8:00 AM	3	0	4	6	13	0	0	0	0	0	16	1	0	0	17
8:15 AM	4	0	3	13	20	0	0	2	0	2	5	1	0	0	6
8:30 AM	6	0	0	7	13	0	0	1	1	2	4	1	1	1	7
8:45 AM	3	0	4	10	17	0	0	1	0	1	2	1	0	1	4
Count Total	28	0	29	80	137	0	0	7	7	14	56	8	1	2	67
Peak Hour	15	0	15	43	73	0	0	3	1	4	38	2	0	0	40

Two-Hour Count Summaries - Heavy Vehicles																		
Interval Start	I-20 Off-ramp				I-280 On-ramp				Bird Ave				Bird ave				15-min Total	Rolling One Hour
	Eastbound				Westbound				Northbound				Southbound					
	UT	LT	TH	RT	UT	LT	TH	RT	UT	LT	TH	RT	UT	LT	TH	RT		
7:00 AM	0	3	1	0	0	0	0	0	0	0	1	2	0	3	3	0	13	0
7:15 AM	0	0	0	0	0	0	0	0	0	0	6	1	0	10	4	0	21	0
7:30 AM	0	3	0	0	0	0	0	0	0	0	4	1	0	12	3	0	23	0
7:45 AM	0	5	0	0	0	0	0	0	0	0	3	0	0	8	1	0	17	74
8:00 AM	0	1	0	2	0	0	0	0	0	0	2	2	0	2	4	0	13	74
8:15 AM	0	4	0	0	0	0	0	0	0	0	3	0	0	8	5	0	20	73
8:30 AM	0	4	0	2	0	0	0	0	0	0	0	0	0	7	0	0	13	63
8:45 AM	0	3	0	0	0	0	0	0	0	0	4	0	0	5	5	0	17	63
Count Total	0	23	1	4	0	0	0	0	0	0	23	6	0	55	25	0	137	0
Peak Hour	0	13	0	2	0	0	0	0	0	0	12	3	0	30	13	0	73	0

Two-Hour Count Summaries - Bikes														
Interval Start	I-20 Off-ramp			I-280 On-ramp			Bird Ave			Bird ave			15-min Total	Rolling One Hour
	Eastbound			Westbound			Northbound			Southbound				
	LT	TH	RT	LT	TH	RT	LT	TH	RT	LT	TH	RT		
7:00 AM	0	0	0	0	0	0	0	1	0	0	4	0	5	0
7:15 AM	0	0	0	0	0	0	0	1	0	0	1	0	2	0
7:30 AM	0	0	0	0	0	0	0	1	0	0	1	0	2	0
7:45 AM	0	0	0	0	0	0	0	0	0	0	0	0	0	9
8:00 AM	0	0	0	0	0	0	0	0	0	0	0	0	0	4
8:15 AM	0	0	0	0	0	0	0	2	0	0	0	0	2	4
8:30 AM	0	0	0	0	0	0	0	1	0	0	1	0	2	4
8:45 AM	0	0	0	0	0	0	0	1	0	0	0	0	1	5
Count Total	0	0	0	0	0	0	0	7	0	0	7	0	14	0
Peak Hour	0	0	0	0	0	0	0	3	0	0	1	0	4	0

Note: U-Turn volumes for bikes are included in Left-Turn, if any.

INTERSECTION TURNING MOVEMENT COUNT SUMMARY

CLIENT: KITTELSON ASSOCIATES
 PROJECT: 2014 SCVTA CMP MONITORING
 DATE: WEDNESDAY SEPTEMBER 24, 2014
 PERIOD: 4:00 PM TO 6:00 PM
 INTERSECTION: N/S BIRD AVENUE SOUTH
 E/W HIGHWAY 280 RAMPS
 CITY: SAN JOSE

VEHICLES

15 MIN COUNTS													
4:00 PM TO 6:00 PM													
PERIOD	1 SBRT	2 SBTH	3 SBLT	4 WBRT	5 WBTH	6 WBLT	7 NBRT	8 NBTH	9 NBLT	10 EBRT	11 EBTH	12 EBLT	TOTAL
400-415	0	171	121	0	0	0	35	88	0	50	1	43	509
415-430	0	206	113	0	0	0	49	96	0	61	6	37	568
430-445	0	199	102	0	0	0	33	107	0	54	0	45	540
445-500	0	218	108	0	0	0	44	92	0	49	0	31	542
500-515	0	240	126	0	0	0	45	109	0	54	2	42	618
515-530	0	309	137	0	0	0	62	87	0	56	1	28	680
530-545	0	290	124	0	0	0	42	113	0	46	2	38	655
545-600	0	320	135	0	0	0	47	104	0	63	1	36	706
HOUR TOTALS													
TIME	1 SBRT	2 SBTH	3 SBLT	4 WBRT	5 WBTH	6 WBLT	7 NBRT	8 NBTH	9 NBLT	10 EBRT	11 EBTH	12 EBLT	TOTAL
400-500	0	794	444	0	0	0	161	383	0	214	7	156	2159
415-515	0	863	449	0	0	0	171	404	0	218	8	155	2268
430-530	0	966	473	0	0	0	184	395	0	213	3	146	2380
445-545	0	1057	495	0	0	0	193	401	0	205	5	139	2495
500-600	0	1159	522	0	0	0	196	413	0	219	6	144	2659

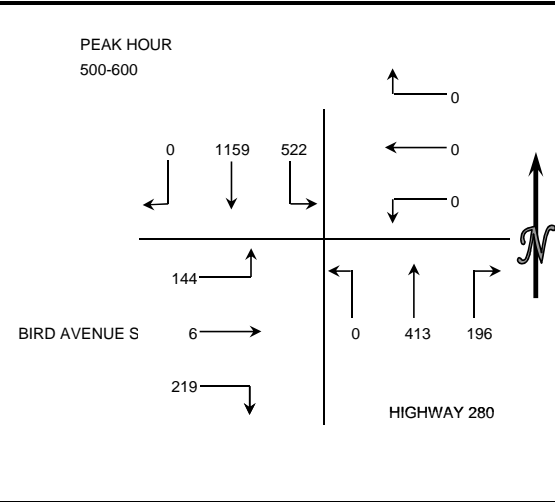

BICYCLES

15 MIN COUNTS													
4:00 PM TO 6:00 PM													
PERIOD	1 SBRT	2 SBTH	3 SBLT	4 WBRT	5 WBTH	6 WBLT	7 NBRT	8 NBTH	9 NBLT	10 EBRT	11 EBTH	12 EBLT	TOTAL
400-415	0	2	1	0	0	0	0	0	0	0	0	0	3
415-430	0	2	0	0	0	0	0	1	0	0	0	0	3
430-445	0	1	3	0	0	0	0	0	0	0	0	0	4
445-500	0	4	1	0	0	0	0	1	0	0	0	0	6
500-515	0	5	0	0	0	0	0	1	0	0	0	0	6
515-530	0	7	0	0	0	0	0	0	0	0	0	0	7
530-545	0	8	0	0	0	0	0	1	0	0	0	0	9
545-600	0	0	0	0	0	0	0	0	0	0	0	0	0
HOUR TOTALS													
TIME	1 SBRT	2 SBTH	3 SBLT	4 WBRT	5 WBTH	6 WBLT	7 NBRT	8 NBTH	9 NBLT	10 EBRT	11 EBTH	12 EBLT	TOTAL
400-500	0	9	5	0	0	0	0	2	0	0	0	0	16
415-515	0	12	4	0	0	0	0	3	0	0	0	0	19
430-530	0	17	4	0	0	0	0	2	0	0	0	0	23
445-545	0	24	1	0	0	0	0	3	0	0	0	0	28
500-600	0	20	0	0	0	0	0	2	0	0	0	0	22

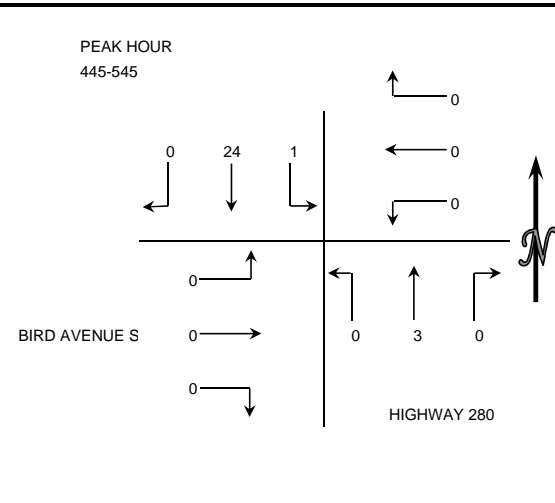

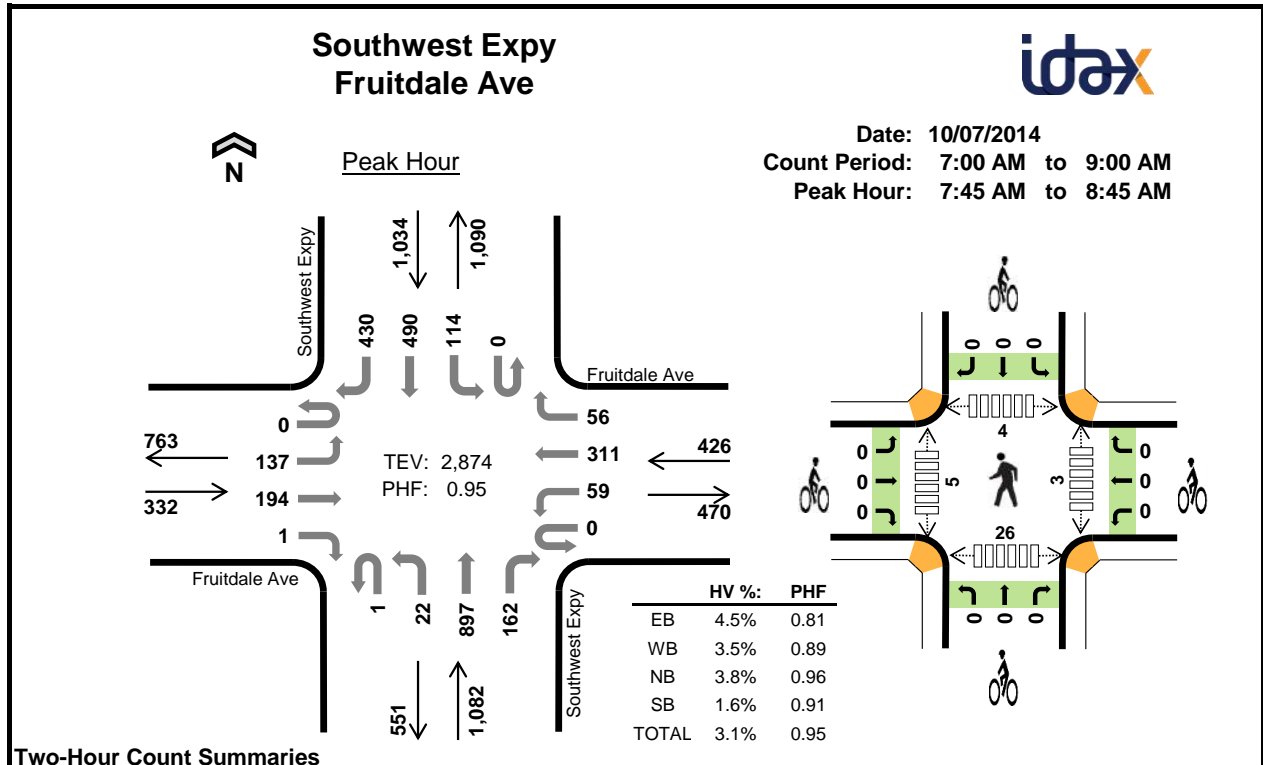

Two-Hour Count Summaries

Interval Start	Fruitdale Ave Eastbound				Fruitdale Ave Westbound				Southwest Expy Northbound				Southwest Expy Southbound				15-min Total	Rolling One Hour	
	UT	LT	TH	RT	UT	LT	TH	RT	UT	LT	TH	RT	UT	LT	TH	RT			
7:00 AM	0	24	15	1	0	4	48	16	1	1	153	6	0	26	77	74	446	0	
7:15 AM	0	34	25	1	0	10	52	23	0	3	182	17	0	14	97	94	552	0	
7:30 AM	0	31	34	0	0	17	67	19	0	2	225	20	0	17	85	112	629	0	
7:45 AM	0	35	47	0	0	16	83	17	0	3	230	23	0	18	147	112	731	2,358	
8:00 AM	0	48	54	0	0	15	63	16	0	8	230	38	0	33	142	110	757	2,669	
8:15 AM	0	25	59	0	0	13	94	12	0	7	220	54	0	18	108	97	707	2,824	
8:30 AM	0	29	34	1	0	15	71	11	1	4	217	47	0	45	93	111	679	2,874	
8:45 AM	0	25	29	1	0	15	92	18	1	4	169	38	0	35	130	96	653	2,796	
Count Total	0	251	297	4	0	105	570	132	3	32	1626	243	0	206	879	806	5,154	0	
Peak Hour	All	0	137	194	1	0	59	311	56	1	22	897	162	0	114	490	430	2,874	0
	HV	0	3	12	0	0	3	12	0	0	0	36	5	0	9	2	6	88	0
	HV%	-	2%	6%	0%	-	5%	4%	0%	0%	0%	4%	3%	-	8%	0%	1%	3%	0

Note: Two-hour count summary volumes include heavy vehicles but exclude bicycles in overall count.

Interval Start	Heavy Vehicle Totals					Bicycles					Pedestrians (Crossing Leg)				
	EB	WB	NB	SB	Total	EB	WB	NB	SB	Total	East	West	North	South	Total
7:00 AM	1	2	0	6	9	0	0	0	0	0	1	0	1	4	6
7:15 AM	1	2	2	4	9	0	0	1	0	1	4	1	2	13	20
7:30 AM	1	3	2	3	9	0	0	0	0	0	2	2	0	11	15
7:45 AM	7	4	9	4	24	0	0	0	0	0	1	0	2	9	12
8:00 AM	2	5	16	3	26	0	0	0	0	0	0	4	1	9	14
8:15 AM	3	4	9	5	21	0	0	0	0	0	2	1	1	4	8
8:30 AM	3	2	7	5	17	0	0	0	0	0	0	0	0	4	4
8:45 AM	2	5	2	6	15	0	2	1	0	3	3	1	3	5	12
Count Total	20	27	47	36	130	0	2	2	0	4	13	9	10	59	91
Peak Hour	15	15	41	17	88	0	0	0	0	0	3	5	4	26	38

Two-Hour Count Summaries - Heavy Vehicles																		
Interval Start	Fruitdale Ave				Fruitdale Ave				Southwest Expy				Southwest Expy				15-min Total	Rolling One Hour
	Eastbound				Westbound				Northbound				Southbound					
	UT	LT	TH	RT	UT	LT	TH	RT	UT	LT	TH	RT	UT	LT	TH	RT		
7:00 AM	0	0	1	0	0	0	2	0	0	0	0	0	0	0	5	1	9	0
7:15 AM	0	0	1	0	0	0	2	0	0	0	1	1	0	0	3	1	9	0
7:30 AM	0	0	1	0	0	0	3	0	0	0	2	0	0	0	0	3	9	0
7:45 AM	0	2	5	0	0	1	3	0	0	0	8	1	0	3	1	0	24	51
8:00 AM	0	0	2	0	0	1	4	0	0	0	13	3	0	1	0	2	26	68
8:15 AM	0	1	2	0	0	1	3	0	0	0	8	1	0	2	1	2	21	80
8:30 AM	0	0	3	0	0	0	2	0	0	0	7	0	0	3	0	2	17	88
8:45 AM	0	0	2	0	0	2	3	0	0	0	1	1	0	1	2	3	15	79
Count Total	0	3	17	0	0	5	22	0	0	0	40	7	0	10	12	14	130	0
Peak Hour	0	3	12	0	0	3	12	0	0	0	36	5	0	9	2	6	88	0

Two-Hour Count Summaries - Bikes														
Interval Start	Fruitdale Ave			Fruitdale Ave			Southwest Expy			Southwest Expy			15-min Total	Rolling One Hour
	Eastbound			Westbound			Northbound			Southbound				
	LT	TH	RT	LT	TH	RT	LT	TH	RT	LT	TH	RT		
7:00 AM	0	0	0	0	0	0	0	0	0	0	0	0	0	0
7:15 AM	0	0	0	0	0	0	0	0	1	0	0	0	1	0
7:30 AM	0	0	0	0	0	0	0	0	0	0	0	0	0	0
7:45 AM	0	0	0	0	0	0	0	0	0	0	0	0	0	1
8:00 AM	0	0	0	0	0	0	0	0	0	0	0	0	0	1
8:15 AM	0	0	0	0	0	0	0	0	0	0	0	0	0	0
8:30 AM	0	0	0	0	0	0	0	0	0	0	0	0	0	0
8:45 AM	0	0	0	0	2	0	0	0	1	0	0	0	3	3
Count Total	0	0	0	0	2	0	0	0	2	0	0	0	4	0
Peak Hour	0	0	0	0	0	0	0	0	0	0	0	0	0	0

Note: U-Turn volumes for bikes are included in Left-Turn, if any.

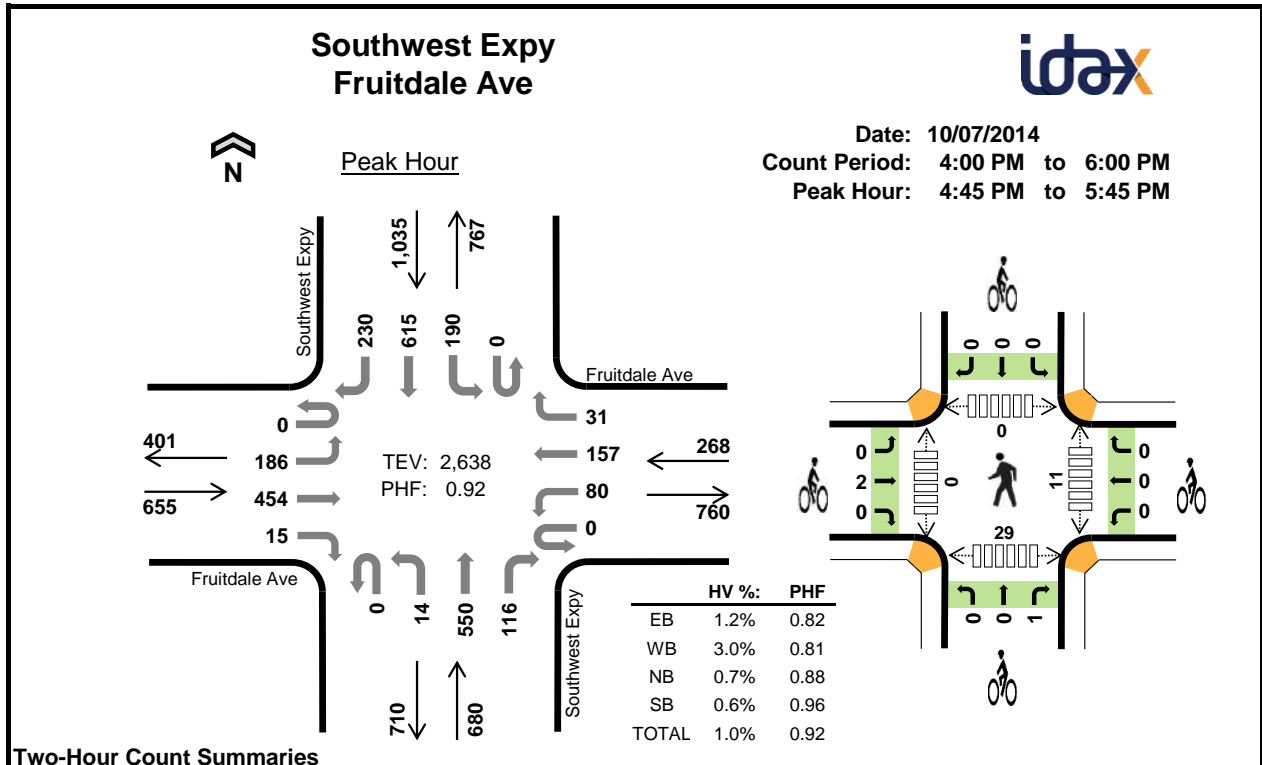

Two-Hour Count Summaries

Interval Start	Fruitdale Ave Eastbound				Fruitdale Ave Westbound				Southwest Expy Northbound				Southwest Expy Southbound				15-min Total	Rolling One Hour	
	UT	LT	TH	RT	UT	LT	TH	RT	UT	LT	TH	RT	UT	LT	TH	RT			
4:00 PM	0	69	63	5	0	21	29	8	0	4	115	24	0	26	123	56	543	0	
4:15 PM	0	57	107	3	0	13	46	10	0	2	118	40	1	44	127	71	639	0	
4:30 PM	0	58	91	3	0	28	47	8	0	2	107	28	0	38	128	73	611	0	
4:45 PM	0	35	78	3	0	7	48	6	0	1	124	24	0	58	153	52	589	2,382	
5:00 PM	0	68	128	3	0	25	48	10	0	4	139	27	0	53	150	64	719	2,558	
5:15 PM	0	53	135	3	0	19	29	6	0	6	156	32	0	37	169	63	708	2,627	
5:30 PM	0	30	113	6	0	29	32	9	0	3	131	33	0	42	143	51	622	2,638	
5:45 PM	0	23	78	4	0	16	49	8	0	7	109	40	0	51	119	66	570	2,619	
Count Total	0	393	793	30	0	158	328	65	0	29	999	248	1	349	1112	496	5,001	0	
Peak Hour	All	0	186	454	15	0	80	157	31	0	14	550	116	0	190	615	230	2,638	0
	HV	0	0	8	0	0	1	6	1	0	0	4	1	0	0	5	1	27	0
	HV%	-	0%	2%	0%	-	1%	4%	3%	-	0%	1%	1%	-	0%	1%	0%	1%	0

Note: Two-hour count summary volumes include heavy vehicles but exclude bicycles in overall count.

Interval Start	Heavy Vehicle Totals					Bicycles					Pedestrians (Crossing Leg)				
	EB	WB	NB	SB	Total	EB	WB	NB	SB	Total	East	West	North	South	Total
4:00 PM	3	5	6	2	16	0	1	0	0	1	2	2	0	4	8
4:15 PM	5	3	1	3	12	1	0	0	0	1	1	2	0	7	10
4:30 PM	2	3	1	3	9	0	0	0	0	0	1	0	0	3	4
4:45 PM	3	2	3	3	11	1	0	0	0	1	3	0	0	11	14
5:00 PM	1	1	0	1	3	0	0	1	0	1	0	0	0	5	5
5:15 PM	3	3	1	1	8	1	0	0	0	1	3	0	0	5	8
5:30 PM	1	2	1	1	5	0	0	0	0	0	5	0	0	8	13
5:45 PM	2	3	1	2	8	1	0	1	0	2	1	0	0	4	5
Count Total	20	22	14	16	72	4	1	2	0	7	16	4	0	47	67
Peak Hour	8	8	5	6	27	2	0	1	0	3	11	0	0	29	40

Two-Hour Count Summaries - Heavy Vehicles																		
Interval Start	Fruitdale Ave				Fruitdale Ave				Southwest Expy				Southwest Expy				15-min Total	Rolling One Hour
	Eastbound				Westbound				Northbound				Southbound					
	UT	LT	TH	RT	UT	LT	TH	RT	UT	LT	TH	RT	UT	LT	TH	RT		
4:00 PM	0	1	2	0	0	0	5	0	0	0	6	0	0	0	0	2	16	0
4:15 PM	0	1	4	0	0	0	2	1	0	0	1	0	0	0	3	0	12	0
4:30 PM	0	0	2	0	0	0	3	0	0	0	1	0	0	1	2	0	9	0
4:45 PM	0	0	3	0	0	0	2	0	0	0	3	0	0	0	2	1	11	48
5:00 PM	0	0	1	0	0	0	1	0	0	0	0	0	0	0	1	0	3	35
5:15 PM	0	0	3	0	0	0	2	1	0	0	1	0	0	0	1	0	8	31
5:30 PM	0	0	1	0	0	1	1	0	0	0	0	1	0	0	1	0	5	27
5:45 PM	0	0	2	0	0	0	2	1	0	0	1	0	0	0	1	1	8	24
Count Total	0	2	18	0	0	1	18	3	0	0	13	1	0	1	11	4	72	0
Peak Hour	0	0	8	0	0	1	6	1	0	0	4	1	0	0	5	1	27	0

Two-Hour Count Summaries - Bikes														
Interval Start	Fruitdale Ave			Fruitdale Ave			Southwest Expy			Southwest Expy			15-min Total	Rolling One Hour
	Eastbound			Westbound			Northbound			Southbound				
	LT	TH	RT	LT	TH	RT	LT	TH	RT	LT	TH	RT		
4:00 PM	0	0	0	0	1	0	0	0	0	0	0	0	1	0
4:15 PM	0	1	0	0	0	0	0	0	0	0	0	0	1	0
4:30 PM	0	0	0	0	0	0	0	0	0	0	0	0	0	0
4:45 PM	0	1	0	0	0	0	0	0	0	0	0	0	1	3
5:00 PM	0	0	0	0	0	0	0	0	1	0	0	0	1	3
5:15 PM	0	1	0	0	0	0	0	0	0	0	0	0	1	3
5:30 PM	0	0	0	0	0	0	0	0	0	0	0	0	0	3
5:45 PM	0	1	0	0	0	0	0	0	1	0	0	0	2	4
Count Total	0	4	0	0	1	0	0	0	2	0	0	0	7	0
Peak Hour	0	2	0	0	0	0	0	0	1	0	0	0	3	0

Note: U-Turn volumes for bikes are included in Left-Turn, if any.

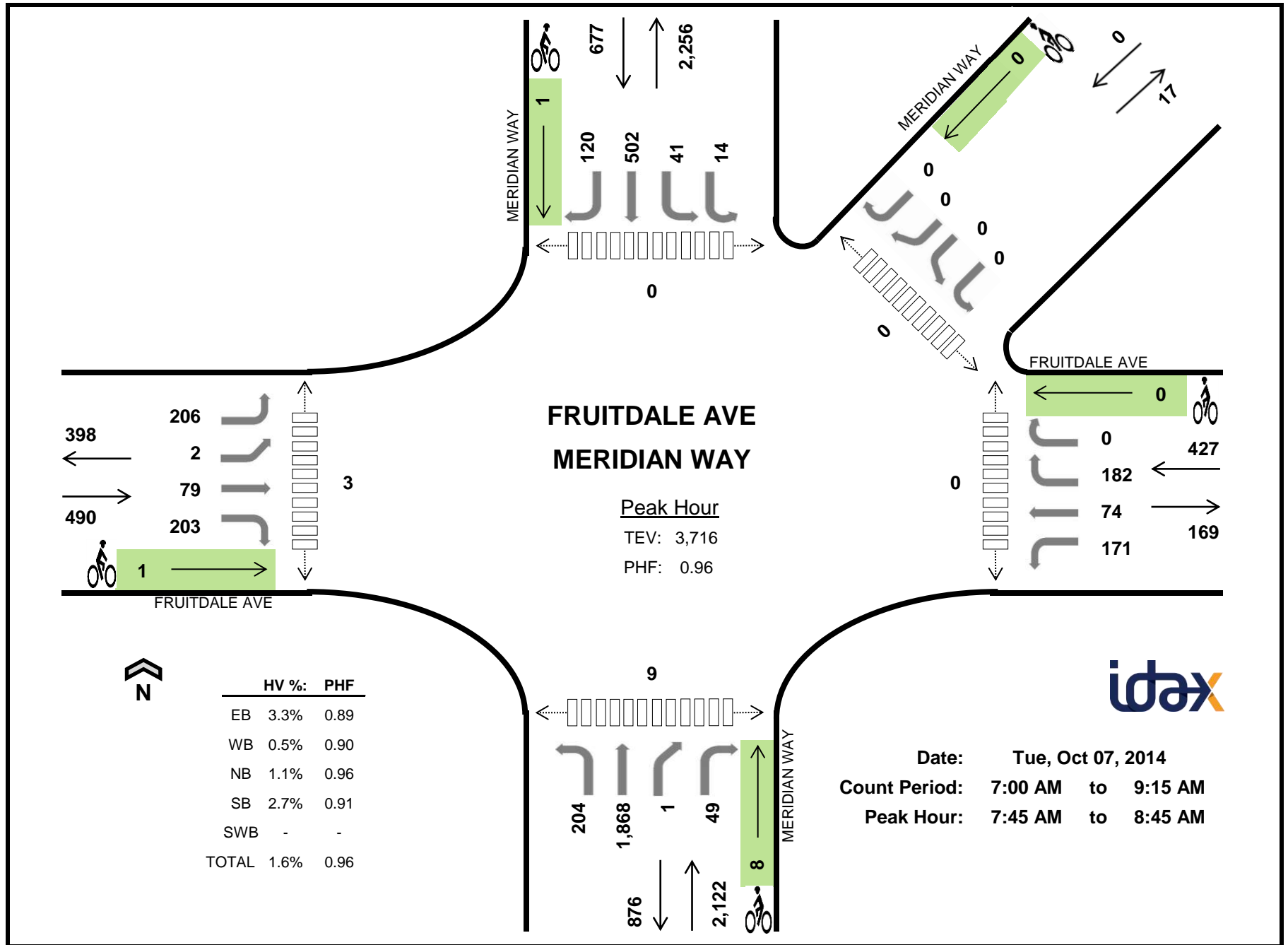

Six-Hour Count Summaries

Interval Start	FRUITDALE AVE Eastbound				FRUITDALE AVE Westbound				MERIDIAN WAY Northbound				MERIDIAN WAY Southbound				MERIDIAN WAY Southwestbound				15-min Total	Rolling One Hour
	LT	BL	TH	RT	LT	TH	RT	HR	LT	TH	BR	RT	HL	LT	TH	RT	HL	BL	BR	HR		
7:00 AM	26	0	5	17	16	20	36	0	30	475	0	1	2	3	91	26	0	0	0	0	748	
7:15 AM	33	0	16	24	28	10	59	0	35	499	0	10	3	3	89	21	0	0	0	0	830	
7:30 AM	26	0	16	41	16	25	70	0	52	462	0	16	2	14	93	27	0	0	0	0	860	
7:45 AM	37	0	14	39	36	21	46	0	49	493	0	11	5	4	147	31	0	0	0	0	933	3,371
8:00 AM	54	1	21	49	54	14	50	0	36	448	0	12	0	21	120	35	0	0	0	0	915	3,538
8:15 AM	55	0	24	59	45	14	47	0	64	468	1	11	3	11	136	31	0	0	0	0	969	3,677
8:30 AM	60	1	20	56	36	25	39	0	55	459	0	15	6	5	99	23	0	0	0	0	899	3,716
8:45 AM	47	0	14	50	33	20	34	0	70	462	0	11	4	10	128	24	0	0	0	0	907	3,690
9:00 AM	0	0	0	0	0	0	0	0	0	0	0	0	0	0	0	0	0	0	0	0	0	2,775
9:15 AM	0	0	0	0	0	0	0	0	0	0	0	0	0	0	0	0	0	0	0	0	0	1,806
9:30 AM	0	0	0	0	0	0	0	0	0	0	0	0	0	0	0	0	0	0	0	0	0	907
9:45 AM	0	0	0	0	0	0	0	0	0	0	0	0	0	0	0	0	0	0	0	0	0	0
10:00 AM	0	0	0	0	0	0	0	0	0	0	0	0	0	0	0	0	0	0	0	0	0	0
10:15 AM	0	0	0	0	0	0	0	0	0	0	0	0	0	0	0	0	0	0	0	0	0	0
10:30 AM	0	0	0	0	0	0	0	0	0	0	0	0	0	0	0	0	0	0	0	0	0	0
10:45 AM	0	0	0	0	0	0	0	0	0	0	0	0	0	0	0	0	0	0	0	0	0	0
11:00 AM	0	0	0	0	0	0	0	0	0	0	0	0	0	0	0	0	0	0	0	0	0	0
11:15 AM	0	0	0	0	0	0	0	0	0	0	0	0	0	0	0	0	0	0	0	0	0	0
11:30 AM	0	0	0	0	0	0	0	0	0	0	0	0	0	0	0	0	0	0	0	0	0	0
11:45 AM	0	0	0	0	0	0	0	0	0	0	0	0	0	0	0	0	0	0	0	0	0	0
12:00 PM	0	0	0	0	0	0	0	0	0	0	0	0	0	0	0	0	0	0	0	0	0	0
12:15 PM	0	0	0	0	0	0	0	0	0	0	0	0	0	0	0	0	0	0	0	0	0	0
12:30 PM	0	0	0	0	0	0	0	0	0	0	0	0	0	0	0	0	0	0	0	0	0	0
12:45 PM	0	0	0	0	0	0	0	0	0	0	0	0	0	0	0	0	0	0	0	0	0	0
Count Total	338	2	130	335	264	149	381	0	391	3,766	1	87	25	71	903	218	0	0	0	0	7,061	
Peak Hr	206	2	79	203	171	74	182	0	204	1,868	1	49	14	41	502	120	0	0	0	0	3,716	

Note: Six-hour count summary volumes include heavy vehicles but excludes bicycles in overall count.

Interval Start	Heavy Vehicle Totals						Bicycles						Pedestrians (Crossing Leg)							
	EB	WB	NB	SB	SWB	Total	EB	WB	NB	SB	SWB	Total	East	West	North	South	NE	Total		
7:00 AM	1	0	6	6	0	13	0	0	0	0	0	0	0	0	0	0	1	0	0	1
7:15 AM	1	1	6	2	0	10	0	0	7	0	0	7	0	0	0	4	0	0	4	
7:30 AM	0	1	3	5	0	9	0	2	0	1	0	3	0	0	0	8	0	0	8	
7:45 AM	5	1	7	4	0	17	1	0	1	0	0	2	0	0	0	2	0	0	2	
8:00 AM	4	1	5	6	0	16	0	0	1	1	0	2	0	1	0	4	0	0	5	
8:15 AM	4	0	6	4	0	14	0	0	2	0	0	2	0	2	0	1	0	0	3	
8:30 AM	3	0	5	4	0	12	0	0	4	0	0	4	0	0	0	2	0	0	2	
8:45 AM	3	1	9	1	0	14	0	1	4	0	0	5	0	0	0	4	0	0	4	
9:00 AM	0	0	0	0	0	0	0	0	0	0	0	0	0	0	0	0	0	0	0	
9:15 AM	0	0	0	0	0	0	0	0	0	0	0	0	0	0	0	0	0	0	0	
9:30 AM	0	0	0	0	0	0	0	0	0	0	0	0	0	0	0	0	0	0	0	
9:45 AM	0	0	0	0	0	0	0	0	0	0	0	0	0	0	0	0	0	0	0	
10:00 AM	0	0	0	0	0	0	0	0	0	0	0	0	0	0	0	0	0	0	0	
10:15 AM	0	0	0	0	0	0	0	0	0	0	0	0	0	0	0	0	0	0	0	
10:30 AM	0	0	0	0	0	0	0	0	0	0	0	0	0	0	0	0	0	0	0	
10:45 AM	0	0	0	0	0	0	0	0	0	0	0	0	0	0	0	0	0	0	0	
11:00 AM	0	0	0	0	0	0	0	0	0	0	0	0	0	0	0	0	0	0	0	
11:15 AM	0	0	0	0	0	0	0	0	0	0	0	0	0	0	0	0	0	0	0	
11:30 AM	0	0	0	0	0	0	0	0	0	0	0	0	0	0	0	0	0	0	0	
8:45 PM	0	0	0	0	0	0	0	0	0	0	0	0	0	0	0	0	0	0	0	
12:00 PM	0	0	0	0	0	0	0	0	0	0	0	0	0	0	0	0	0	0	0	
12:15 PM	0	0	0	0	0	0	0	0	0	0	0	0	0	0	0	0	0	0	0	
12:30 PM	0	0	0	0	0	0	0	0	0	0	0	0	0	0	0	0	0	0	0	
9:45 PM	0	0	0	0	0	0	0	0	0	0	0	0	0	0	0	0	0	0	0	
Count Total	21	5	47	32	0	105	1	3	19	2	0	25	0	3	0	26	0	0	29	
Peak Hr	16	2	23	18	0	59	1	0	8	1	0	10	0	3	0	9	0	0	12	

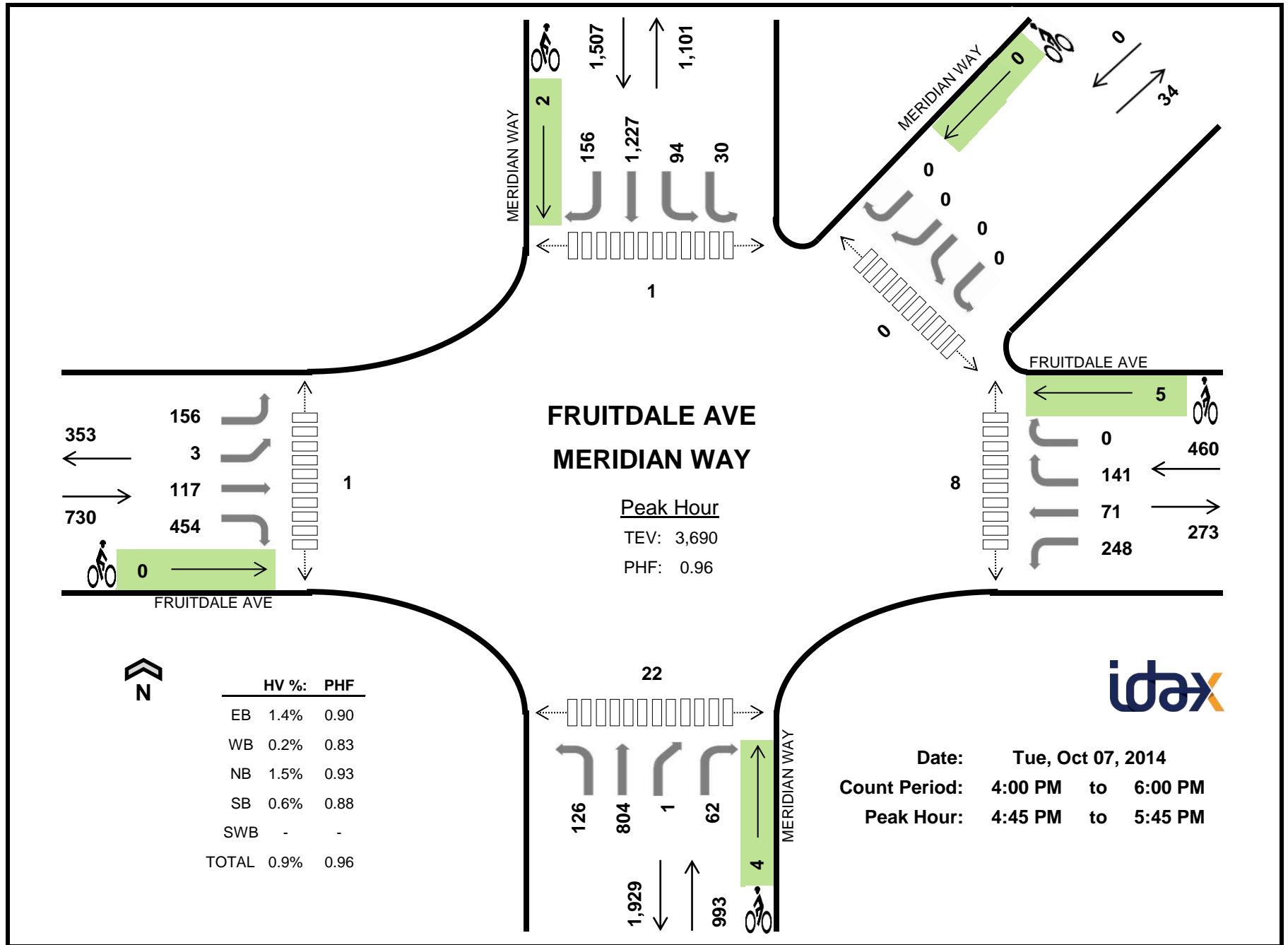

Two-Hour Count Summaries

Interval Start	FRUITDALE AVE Eastbound				FRUITDALE AVE Westbound				MERIDIAN WAY Northbound				MERIDIAN WAY Southbound				MERIDIAN WAY Southwestbound				15-min Total	Rolling One Hour
	LT	BL	TH	RT	LT	TH	RT	HR	LT	TH	BR	RT	HL	LT	TH	RT	HL	BL	BR	HR		
4:00 PM	35	1	32	63	57	15	37	0	20	179	0	4	5	23	219	31	0	0	0	0	721	
4:15 PM	39	1	19	110	33	11	22	0	27	218	0	14	4	28	329	45	0	0	0	0	900	
4:30 PM	44	1	27	88	53	27	30	0	25	184	0	17	8	18	312	40	0	0	0	0	874	
4:45 PM	23	1	25	93	49	14	30	0	37	217	0	12	8	21	291	41	0	0	0	0	862	3,357
5:00 PM	54	0	17	126	80	18	41	0	30	206	0	17	9	31	303	27	0	0	0	0	959	3,595
5:15 PM	38	0	42	123	68	16	42	0	29	197	0	13	6	19	280	43	0	0	0	0	916	3,611
5:30 PM	41	2	33	112	51	23	28	0	30	184	1	20	7	23	353	45	0	0	0	0	953	3,690
5:45 PM	34	0	27	88	53	24	27	0	32	200	1	20	7	22	277	39	0	0	0	0	851	3,679
Count Total	308	6	222	803	444	148	257	0	230	1,585	2	117	54	185	2,364	311	0	0	0	0	7,036	
Peak Hr	156	3	117	454	248	71	141	0	126	804	1	62	30	94	1,227	156	0	0	0	0	3,690	

Note: Two-hour count summary volumes include heavy vehicles but excludes bicycles in overall count.

Interval Start	Heavy Vehicle Totals						Bicycles						Pedestrians (Crossing Leg)							
	EB	WB	NB	SB	SWB	Total	EB	WB	NB	SB	SWB	Total	East	West	North	South	NE	Total		
4:00 PM	4	3	4	3	0	14	0	2	0	0	0	2	0	5	0	0	0	0	0	5
4:15 PM	5	1	6	7	0	19	0	0	1	1	0	2	0	0	0	0	0	0	0	0
4:30 PM	2	2	8	1	0	13	0	0	0	0	0	0	0	4	0	3	0	0	0	7
4:45 PM	3	1	4	2	0	10	0	0	0	0	0	0	0	0	0	8	0	0	0	8
5:00 PM	1	0	4	2	0	7	0	3	2	0	0	5	1	0	0	6	0	0	0	7
5:15 PM	4	0	4	2	0	10	0	1	2	1	0	4	6	1	1	3	0	0	0	11
5:30 PM	2	0	3	3	0	8	0	1	0	1	0	2	1	0	0	5	0	0	0	6
5:45 PM	2	0	5	3	0	10	0	1	0	0	0	1	0	4	0	2	0	0	0	6
Count Total	23	7	38	23	0	91	0	8	5	3	0	16	8	14	1	27	0	0	0	50
Peak Hr	10	1	15	9	0	35	0	5	4	2	0	11	8	1	1	22	0	0	0	32

AM Count Factor for Santa Clara Station

Node	NBL	NBT	NBR	SBL	SBT	SBR	EBL	EBT	EBR	WBL	WBT	WBR	Sum	Date	Source
5416	187	2938	133	79	994	260	260	732	108	176	797	474	7138	11/05/13	New Counts San Thomas Expwy and El Camino Real
1202	137	975	50	85	278	77	265	406	146	8	904	493	3824	11/06/13	New Counts Lafayette St and El Camino Real
9	127	2401	237	32	472	41	147	20	49	42	7	21	3596	11/05/13	New Counts Coleman Ave and Brokaw Rd
1008	2	1134	53	79	410	3	1	40	8	2	1	3	1736	11/06/13	New Counts Lafayette St and Harrison St
													16294		
5416	185	3436	74	102	994	459	241	600	158	186	778	345	7558	10/30/12	New Counts SAN THOMAS EXPRESSWAY & EL CAMINO REAL
1202	144	951	70	76	271	92	270	389	126	15	785	398	3587	10/30/12	New Counts LAFAYETTE STREET & EL CAMINO REAL
9	184	2142	112	24	416	47	190	20	63	34	15	10	3257	10/30/12	New Counts COLEMAN AVENUE & BROKAW ROAD
1008	5	1033	39	84	444	4	0	29	11	1	3	3	1656	03/26/13	New Counts LAFAYETTE STREET & HARRISON STREET
													16058		

Factor 1.01

PM Count Factor for Santa Clara Station

Node	NBL	NBT	NBR	SBL	SBT	SBR	EBL	EBT	EBR	WBL	WBT	WBR	Sum	Date	Source
5416	184	1044	191	229	3060	207	316	1090	263	235	865	156	7840	11/06/13	New Counts San Thomas Expwy and El Camino Real
1202	119	225	172	341	926	165	190	850	273	47	682	59	4049	11/06/13	New Counts Lafayette St and El Camino Real
9	224	600	27	0	2399	52	216	12	403	327	28	43	4331	11/06/13	New Counts Coleman Ave and Brokaw Rd
1008	4	329	34	127	1401	37	1	28	9	2	2	8	1982	11/06/13	New Counts Lafayette St and Harrison St
5335	287	918	0	0	1211	841	1611	0	1072	0	0	0	5940	11/06/13	New Counts De La Cruz Blvd and Central Expressway
													24142		
5416	172	936	187	162	2747	505	285	923	339	175	765	170	7366	09/06/12	CMP SAN THOMAS EXPRESSWAY & EL CAMINO REAL
1202	110	175	243	332	1094	245	184	794	205	43	605	88	4118	09/19/12	CMP LAFAYETTE STREET & EL CAMINO REAL
9	273	624	42	11	2081	73	237	19	376	226	24	16	4002	10/30/12	New Counts COLEMAN AVENUE & BROKAW ROAD
1008	4	314	20	134	1506	1	1	19	13	2	1	10	2025	03/26/13	New Counts LAFAYETTE STREET & HARRISON STREET
5335	161	508	0	0	1183	856	1893	0	1057	0	0	0	5658	09/05/12	CMP DE LA CRUZ BOULEVARD & CENTRAL EXPRESSWAY
													23169		

Factor 1.04

INTERSECTION CAR/PED/BIKE TRAFFIC COUNT RESULTS SUMMARY

CLIENT: KIMLEY-HORN ASSOCIATES, INC.
 PROJECT: 2012 SCVTA BART TRAFFIC COUNTS
 DATE: TUESDAY OCTOBER 30, 2012
 PERIOD: 7:00 AM TO 9:00 AM
 INTERSECTION: N/S LAFAYETTE STREET
 E/W REED STREET
 CITY: SANTA CLARA

VEHICLE COUNTS													
15 MIN COUNTS	1	2	3	4	5	6	7	8	9	10	11	12	TOTAL
PERIOD	SBRT	SBTH	SBLT	WBRT	WBTH	WBLT	NBRT	NBTH	NBLT	EBRT	EBTH	EBLT	TOTAL
700-715	2	49	3	9	0	0	10	165	0	0	0	1	239
715-730	2	76	2	15	0	3	10	223	0	0	0	1	332
730-745	1	87	6	12	1	3	22	310	0	1	0	0	443
745-800	2	107	7	2	0	1	10	302	0	3	0	0	434
800-815	3	113	5	7	2	6	10	390	0	0	0	0	536
815-830	1	115	6	8	0	4	16	416	0	0	0	1	567
830-845	11	84	3	7	1	7	17	377	0	3	0	1	511
845-900	5	93	5	13	1	8	29	407	0	1	0	2	564
HOUR TOTALS	1	2	3	4	5	6	7	8	9	10	11	12	TOTAL
PERIOD	SBRT	SBTH	SBLT	WBRT	WBTH	WBLT	NBRT	NBTH	NBLT	EBRT	EBTH	EBLT	TOTAL
700-800	7	319	18	38	1	7	52	1000	0	4	0	2	1448
715-815	8	383	20	36	3	13	52	1225	0	4	0	1	1745
730-830	7	422	24	29	3	14	58	1418	0	4	0	1	1980
745-845	17	419	21	24	3	18	53	1485	0	6	0	2	2048
800-900	20	405	19	35	4	25	72	1590	0	4	0	4	2178

AM PEAK HOUR: 800-900

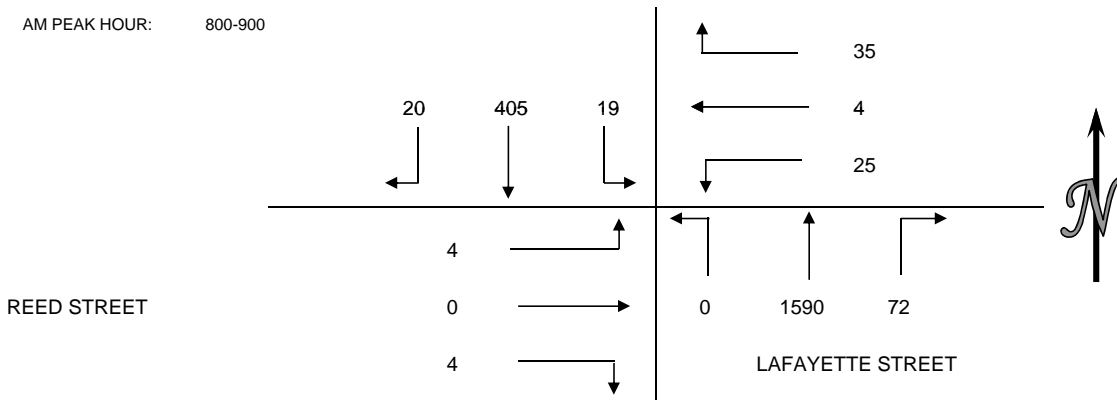

PEDESTRIAN COUNTS					
15 MIN COUNTS	NORTH LEG	EAST LEG	SOUTH LEG	WEST LEG	TOTAL
PERIOD	LEG	LEG	LEG	LEG	TOTAL
700-715	0	0	0	0	0
715-730	0	0	3	1	4
730-745	2	2	5	3	12
745-800	1	1	0	0	2
800-815	0	0	1	1	2
815-830	1	1	3	2	7
830-845	1	1	2	2	6
845-900	1	1	6	5	13
HOUR TOTALS	NORTH LEG	EAST LEG	SOUTH LEG	WEST LEG	TOTAL
PERIOD	LEG	LEG	LEG	LEG	TOTAL
700-800	3	3	8	4	18
715-815	3	3	9	5	20
730-830	4	4	9	6	23
745-845	3	3	6	5	17
800-900	3	3	12	10	28

BICYCLE COUNTS					
15 MIN COUNTS	NORTH LEG	EAST LEG	SOUTH LEG	WEST LEG	TOTAL
PERIOD	LEG	LEG	LEG	LEG	TOTAL
700-715	3	2	2	1	8
715-730	1	1	0	2	4
730-745	0	0	1	1	2
745-800	0	0	2	3	5
800-815	0	0	3	4	7
815-830	0	0	2	2	4
830-845	0	0	0	0	0
845-900	0	0	1	1	2
HOUR TOTALS	NORTH LEG	EAST LEG	SOUTH LEG	WEST LEG	TOTAL
PERIOD	LEG	LEG	LEG	LEG	TOTAL
700-800	4	3	5	7	19
715-815	1	1	6	10	18
730-830	0	0	8	10	18
745-845	0	0	7	9	16
800-900	0	0	6	7	13

INTERSECTION CAR/PED/BIKE TRAFFIC COUNT RESULTS SUMMARY

CLIENT: KIMLEY-HORN ASSOCIATES, INC.
 PROJECT: 2012 SCVTA BART TRAFFIC COUNTS
 DATE: TUESDAY OCTOBER 30, 2012
 PERIOD: 4:00 PM TO 6:00 PM
 INTERSECTION: N/S LAFAYETTE STREET
 E/W REED STREET
 CITY: SANTA CLARA

VEHICLE COUNTS													
15 MIN COUNTS	1	2	3	4	5	6	7	8	9	10	11	12	
PERIOD	SBRT	SBTH	SBLT	WBRT	WBTH	WBLT	NBRT	NBTH	NBLT	EBRT	EBTH	EBLT	TOTAL
400-415	2	265	11	5	0	7	16	111	0	4	0	1	422
415-430	3	259	4	5	0	5	13	92	0	2	1	0	384
430-445	1	331	20	7	1	10	14	109	0	2	1	0	496
445-500	2	352	10	5	0	9	14	110	0	2	1	3	508
500-515	2	411	21	8	2	12	16	127	0	2	1	2	604
515-530	3	373	8	4	0	17	12	106	0	0	1	0	524
530-545	2	432	12	4	1	13	6	83	0	2	1	1	557
545-600	1	313	12	1	1	9	10	80	0	1	0	0	428
HOURLY TOTALS	1	2	3	4	5	6	7	8	9	10	11	12	
PERIOD	SBRT	SBTH	SBLT	WBRT	WBTH	WBLT	NBRT	NBTH	NBLT	EBRT	EBTH	EBLT	TOTAL
400-500	8	1207	45	22	1	31	57	422	0	10	3	4	1810
415-515	8	1353	55	25	3	36	57	438	0	8	4	5	1992
430-530	8	1467	59	24	3	48	56	452	0	6	4	5	2132
445-545	9	1568	51	21	3	51	48	426	0	6	4	6	2193
500-600	8	1529	53	17	4	51	44	396	0	5	3	3	2113

AM PEAK HOUR: 445-545

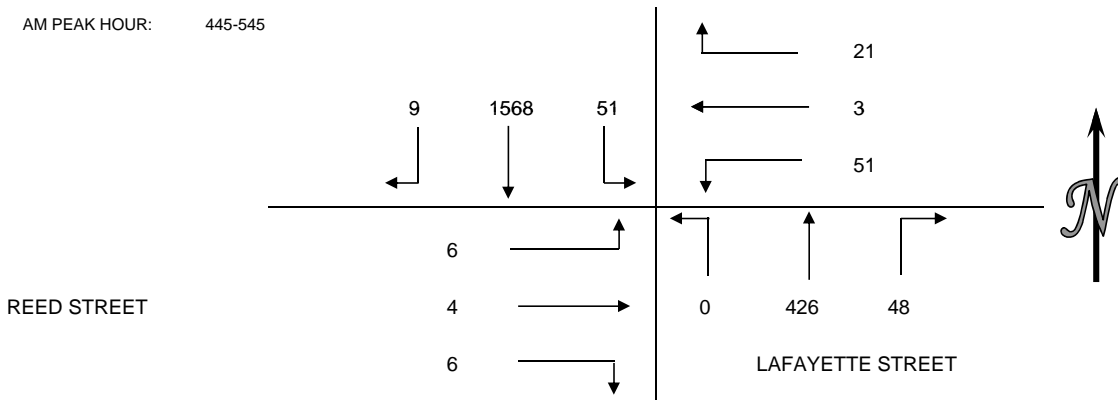

PEDESTRIAN COUNTS					
15 MIN COUNTS	NORTH LEG	EAST LEG	SOUTH LEG	WEST LEG	TOTAL
PERIOD	LEG	LEG	LEG	LEG	TOTAL
400-415	0	0	0	3	3
415-430	1	2	1	4	8
430-445	0	0	0	0	0
445-500	0	0	0	0	0
500-515	0	4	0	2	6
515-530	0	1	0	0	1
530-545	1	1	0	3	5
545-600	0	2	1	1	4
HOURLY TOTALS	NORTH LEG	EAST LEG	SOUTH LEG	WEST LEG	TOTAL
PERIOD	LEG	LEG	LEG	LEG	TOTAL
400-500	1	2	1	7	11
415-515	1	6	1	6	14
430-530	0	5	0	2	7
445-545	1	6	0	5	12
500-600	1	8	1	6	16

BICYCLE COUNTS					
15 MIN COUNTS	NORTH LEG	EAST LEG	SOUTH LEG	WEST LEG	TOTAL
PERIOD	LEG	LEG	LEG	LEG	TOTAL
400-415	0	0	0	0	0
415-430	0	2	0	2	4
430-445	0	1	0	1	2
445-500	0	0	0	1	1
500-515	0	3	0	5	8
515-530	0	3	0	1	4
530-545	1	1	2	0	4
545-600	0	1	0	1	2
HOURLY TOTALS	NORTH LEG	EAST LEG	SOUTH LEG	WEST LEG	TOTAL
PERIOD	LEG	LEG	LEG	LEG	TOTAL
400-500	0	3	0	4	7
415-515	0	6	0	9	15
430-530	0	7	0	8	15
445-545	1	7	2	7	17
500-600	1	8	2	7	18

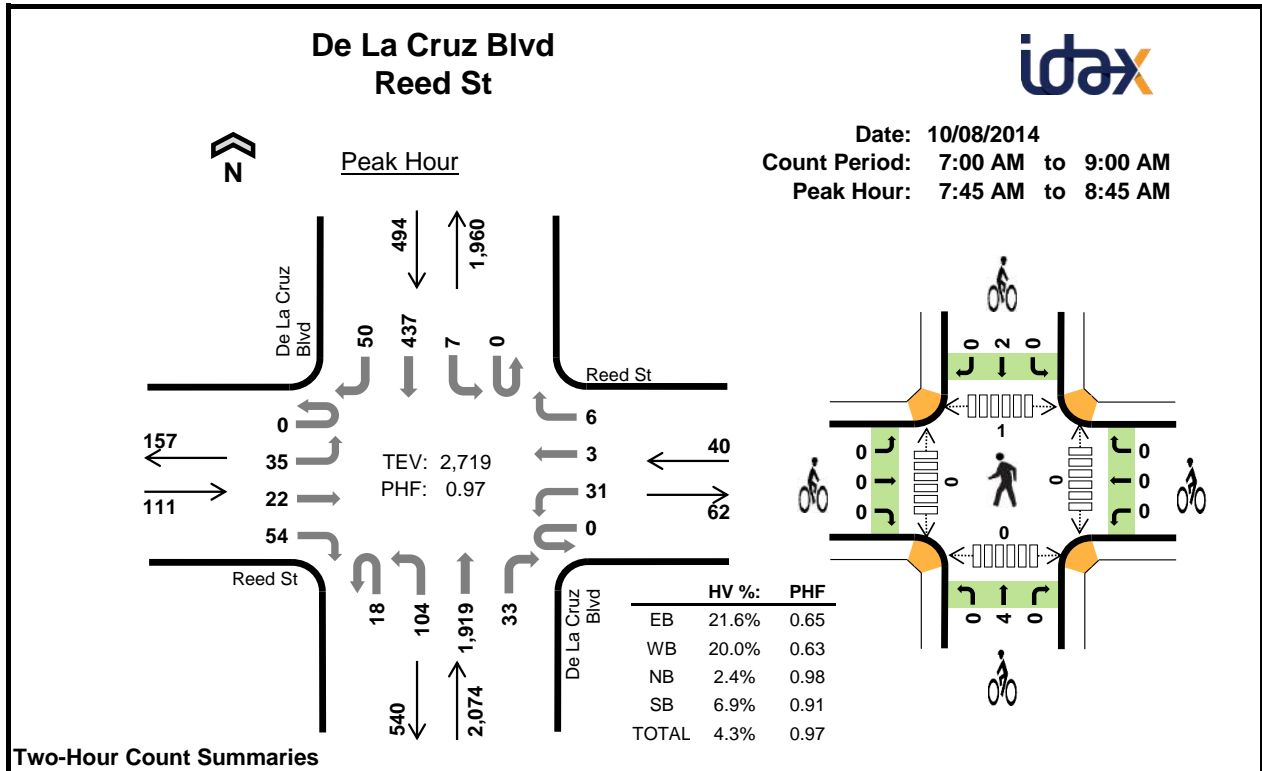

Two-Hour Count Summaries

Interval Start	Reed St Eastbound				Reed St Westbound				De La Cruz Blvd Northbound				De La Cruz Blvd Southbound				15-min Total	Rolling One Hour	
	UT	LT	TH	RT	UT	LT	TH	RT	UT	LT	TH	RT	UT	LT	TH	RT			
7:00 AM	0	12	2	19	0	1	1	2	1	37	357	14	0	4	72	10	532	0	
7:15 AM	0	8	7	7	0	3	1	2	2	19	442	14	0	1	72	11	589	0	
7:30 AM	0	6	1	20	0	8	1	3	3	16	446	10	1	5	84	9	613	0	
7:45 AM	0	10	3	12	0	9	3	4	1	25	491	13	0	1	102	8	682	2,416	
8:00 AM	0	10	7	8	0	4	0	2	6	21	464	10	0	2	101	12	647	2,531	
8:15 AM	0	5	3	10	0	8	0	0	4	37	483	6	0	1	113	22	692	2,634	
8:30 AM	0	10	9	24	0	10	0	0	7	21	481	4	0	3	121	8	698	2,719	
8:45 AM	0	7	2	13	0	5	0	2	3	25	481	4	0	1	106	9	658	2,695	
Count Total	0	68	34	113	0	48	6	15	27	201	3645	75	1	18	771	89	5,111	0	
Peak Hour	All	0	35	22	54	0	31	3	6	18	104	1919	33	0	7	437	50	2,719	0
	HV	0	10	3	11	0	7	1	0	7	7	31	5	0	0	28	6	116	0
	HV%	-	29%	14%	20%	-	23%	33%	0%	39%	7%	2%	15%	-	0%	6%	12%	4%	0

Note: Two-hour count summary volumes include heavy vehicles but exclude bicycles in overall count.

Interval Start	Heavy Vehicle Totals					Bicycles					Pedestrians (Crossing Leg)				
	EB	WB	NB	SB	Total	EB	WB	NB	SB	Total	East	West	North	South	Total
7:00 AM	7	1	9	4	21	0	0	0	0	0	0	0	0	0	0
7:15 AM	3	1	5	5	14	0	0	0	0	0	0	0	0	0	0
7:30 AM	7	4	10	9	30	0	0	1	0	1	0	0	0	0	0
7:45 AM	9	3	12	9	33	0	0	0	0	0	0	0	1	0	1
8:00 AM	3	2	8	2	15	0	0	4	1	5	0	0	0	0	0
8:15 AM	4	1	12	11	28	0	0	0	0	0	0	0	0	0	0
8:30 AM	8	2	18	12	40	0	0	0	1	1	0	0	0	0	0
8:45 AM	5	1	9	5	20	2	0	0	1	3	0	0	0	0	0
Count Total	46	15	83	57	201	2	0	5	3	10	0	0	1	0	1
Peak Hour	24	8	50	34	116	0	0	4	2	6	0	0	1	0	1

Two-Hour Count Summaries - Heavy Vehicles																			
Interval Start	Reed St				Reed St				De La Cruz Blvd				De La Cruz Blvd				15-min Total	Rolling One Hour	
	Eastbound				Westbound				Northbound				Southbound						
	UT	LT	TH	RT	UT	LT	TH	RT	UT	LT	TH	RT	UT	LT	TH	RT			
7:00 AM	0	3	0	4	0	1	0	0	0	1	8	0	0	0	4	0	21	0	
7:15 AM	0	1	0	2	0	1	0	0	0	0	2	3	0	0	0	4	1	14	0
7:30 AM	0	2	0	5	0	1	1	2	0	0	1	9	0	0	1	8	0	30	0
7:45 AM	0	4	1	4	0	2	1	0	0	0	2	9	1	0	0	9	0	33	98
8:00 AM	0	1	1	1	0	2	0	0	0	4	0	1	3	0	0	1	1	15	92
8:15 AM	0	2	0	2	0	1	0	0	0	2	3	7	0	0	0	8	3	28	106
8:30 AM	0	3	1	4	0	2	0	0	0	1	2	14	1	0	0	10	2	40	116
8:45 AM	0	1	0	4	0	1	0	0	0	1	2	6	0	0	0	5	0	20	103
Count Total	0	17	3	26	0	11	2	2	0	8	13	57	5	0	1	49	7	201	0
Peak Hour	0	10	3	11	0	7	1	0	0	7	7	31	5	0	0	28	6	116	0

Two-Hour Count Summaries - Bikes																			
Interval Start	Reed St			Reed St			De La Cruz Blvd			De La Cruz Blvd			15-min Total	Rolling One Hour					
	Eastbound			Westbound			Northbound			Southbound									
	LT	TH	RT	LT	TH	RT	LT	TH	RT	LT	TH	RT							
7:00 AM	0	0	0	0	0	0	0	0	0	0	0	0	0	0	0	0	0	0	0
7:15 AM	0	0	0	0	0	0	0	0	0	0	0	0	0	0	0	0	0	0	0
7:30 AM	0	0	0	0	0	0	0	1	0	0	0	0	0	0	0	0	1	0	0
7:45 AM	0	0	0	0	0	0	0	0	0	0	0	0	0	0	0	0	0	0	1
8:00 AM	0	0	0	0	0	0	0	0	4	0	0	0	0	1	0	0	5	6	6
8:15 AM	0	0	0	0	0	0	0	0	0	0	0	0	0	0	0	0	0	6	6
8:30 AM	0	0	0	0	0	0	0	0	0	0	0	0	0	1	0	0	1	6	6
8:45 AM	1	1	0	0	0	0	0	0	0	0	0	0	0	0	1	0	3	9	9
Count Total	1	1	0	0	0	0	0	1	4	0	0	0	0	2	1	0	10	0	0
Peak Hour	0	0	0	0	0	0	0	0	4	0	0	0	0	2	0	0	6	0	0

Note: U-Turn volumes for bikes are included in Left-Turn, if any.

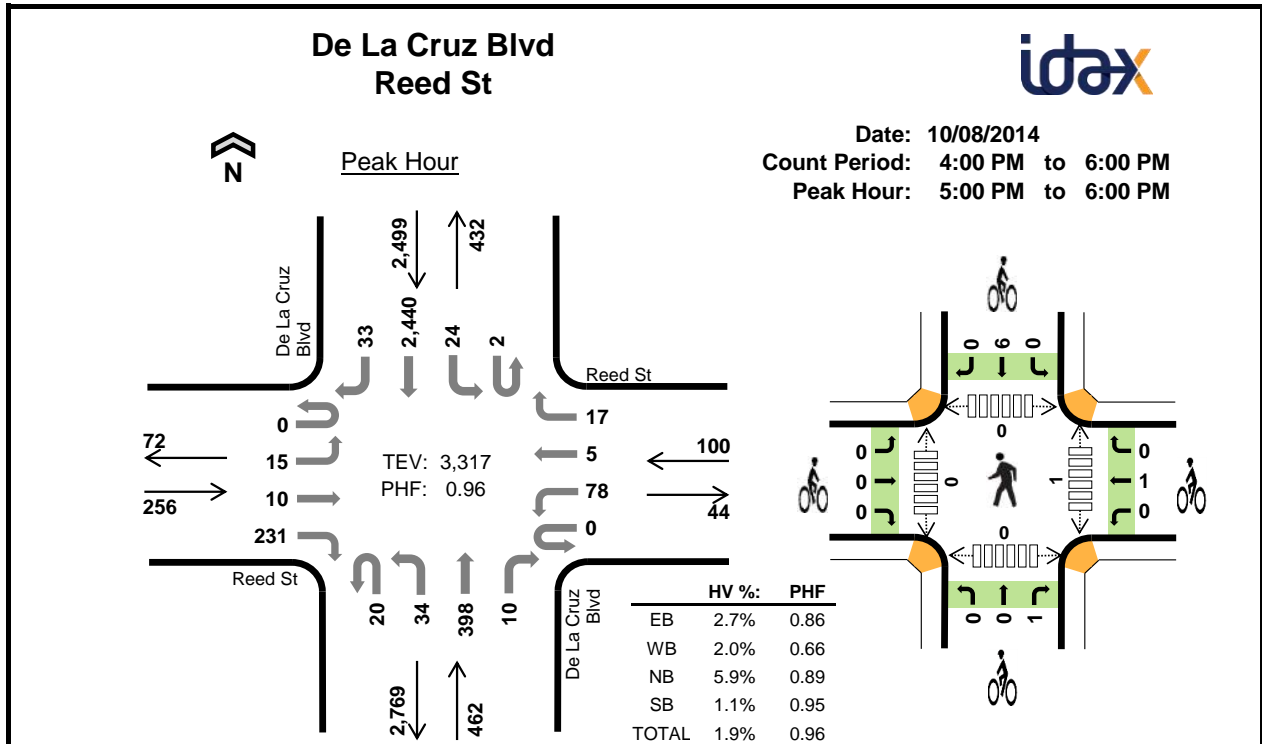

Two-Hour Count Summaries

Interval Start	Reed St Eastbound				Reed St Westbound				De La Cruz Blvd Northbound				De La Cruz Blvd Southbound				15-min Total	Rolling One Hour	
	UT	LT	TH	RT	UT	LT	TH	RT	UT	LT	TH	RT	UT	LT	TH	RT			
4:00 PM	0	13	3	69	0	28	0	3	6	10	116	7	0	1	396	12	664	0	
4:15 PM	0	11	8	38	0	18	2	5	8	5	89	7	0	5	454	8	658	0	
4:30 PM	0	9	3	43	0	27	3	2	5	6	93	5	0	3	512	13	724	0	
4:45 PM	0	13	1	56	0	24	2	4	6	6	97	1	0	1	521	12	744	2,790	
5:00 PM	0	3	1	56	0	25	3	10	5	4	103	2	2	3	540	9	766	2,892	
5:15 PM	0	7	5	56	0	19	1	3	3	8	102	2	0	9	614	12	841	3,075	
5:30 PM	0	2	2	70	0	18	1	2	5	4	90	4	0	8	635	9	850	3,201	
5:45 PM	0	3	2	49	0	16	0	2	7	18	103	2	0	4	651	3	860	3,317	
Count Total	0	61	25	437	0	175	12	31	45	61	793	30	2	34	4323	78	6,107	0	
Peak Hour	All	0	15	10	231	0	78	5	17	20	34	398	10	2	24	2440	33	3,317	0
	HV	0	1	1	5	0	2	0	0	1	6	19	0	0	0	24	3	62	0
	HV%	-	7%	10%	2%	-	3%	0%	0%	5%	18%	5%	0%	0%	0%	1%	9%	2%	0

Note: Two-hour count summary volumes include heavy vehicles but exclude bicycles in overall count.

Interval Start	Heavy Vehicle Totals					Bicycles					Pedestrians (Crossing Leg)				
	EB	WB	NB	SB	Total	EB	WB	NB	SB	Total	East	West	North	South	Total
4:00 PM	6	0	12	5	23	0	0	0	0	0	0	0	1	0	1
4:15 PM	4	1	6	7	18	1	0	0	0	1	0	0	0	0	0
4:30 PM	1	3	2	11	17	0	0	0	0	0	2	0	0	1	3
4:45 PM	1	0	5	6	12	0	0	0	1	1	0	0	0	0	0
5:00 PM	1	0	5	13	19	0	0	0	0	0	0	0	0	0	0
5:15 PM	4	1	9	7	21	0	0	0	3	3	0	0	0	0	0
5:30 PM	0	1	5	3	9	0	0	0	0	0	0	0	0	0	0
5:45 PM	2	0	7	4	13	0	1	1	3	5	1	0	0	0	1
Count Total	19	6	51	56	132	1	1	1	7	10	3	0	1	1	5
Peak Hour	7	2	26	27	62	0	1	1	6	8	1	0	0	0	1

Two-Hour Count Summaries - Heavy Vehicles																		
Interval Start	Reed St				Reed St				De La Cruz Blvd				De La Cruz Blvd				15-min Total	Rolling One Hour
	Eastbound				Westbound				Northbound				Southbound					
	UT	LT	TH	RT	UT	LT	TH	RT	UT	LT	TH	RT	UT	LT	TH	RT		
4:00 PM	0	2	2	2	0	0	0	0	0	4	8	0	0	0	5	0	23	0
4:15 PM	0	2	1	1	0	0	0	1	0	2	4	0	0	0	6	1	18	0
4:30 PM	0	0	0	1	0	0	3	0	0	0	2	0	0	1	10	0	17	0
4:45 PM	0	0	0	1	0	0	0	0	0	0	5	0	0	0	5	1	12	70
5:00 PM	0	0	0	1	0	0	0	0	0	1	4	0	0	0	11	2	19	66
5:15 PM	0	1	1	2	0	1	0	0	0	1	8	0	0	0	6	1	21	69
5:30 PM	0	0	0	0	0	1	0	0	0	1	4	0	0	0	3	0	9	61
5:45 PM	0	0	0	2	0	0	0	0	1	3	3	0	0	0	4	0	13	62
Count Total	0	5	4	10	0	2	3	1	1	12	38	0	0	1	50	5	132	0
Peak Hour	0	1	1	5	0	2	0	0	1	6	19	0	0	0	24	3	62	0

Two-Hour Count Summaries - Bikes														
Interval Start	Reed St			Reed St			De La Cruz Blvd			De La Cruz Blvd			15-min Total	Rolling One Hour
	Eastbound			Westbound			Northbound			Southbound				
	LT	TH	RT	LT	TH	RT	LT	TH	RT	LT	TH	RT		
4:00 PM	0	0	0	0	0	0	0	0	0	0	0	0	0	0
4:15 PM	1	0	0	0	0	0	0	0	0	0	0	0	1	0
4:30 PM	0	0	0	0	0	0	0	0	0	0	0	0	0	0
4:45 PM	0	0	0	0	0	0	0	0	0	0	1	0	1	2
5:00 PM	0	0	0	0	0	0	0	0	0	0	0	0	0	2
5:15 PM	0	0	0	0	0	0	0	0	0	0	3	0	3	4
5:30 PM	0	0	0	0	0	0	0	0	0	0	0	0	0	4
5:45 PM	0	0	0	0	1	0	0	0	1	0	3	0	5	8
Count Total	1	0	0	0	1	0	0	0	1	0	7	0	10	0
Peak Hour	0	0	0	0	1	0	0	0	1	0	6	0	8	0

Note: U-Turn volumes for bikes are included in Left-Turn, if any.

San Tomas Expy El Camino Real



Date: 10/08/2014
 Count Period: 7:00 AM to 9:00 AM
 Peak Hour: 7:45 AM to 8:45 AM

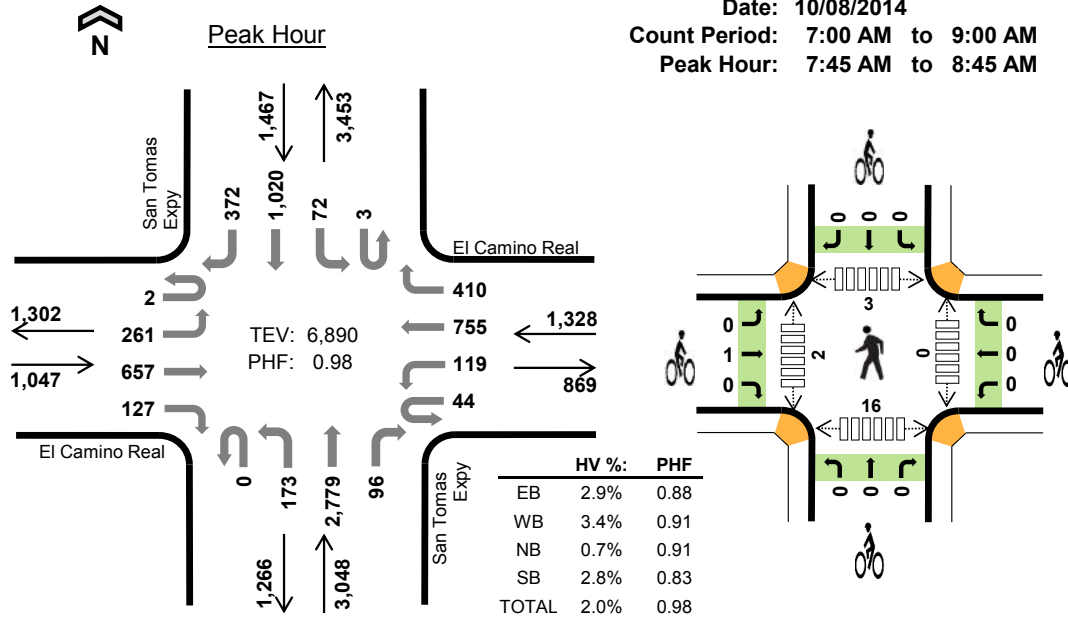

Two-Hour Count Summaries

Interval Start	El Camino Real Eastbound				El Camino Real Westbound				San Tomas Expy Northbound				San Tomas Expy Southbound				15-min Total	Rolling One Hour	
	UT	LT	TH	RT	UT	LT	TH	RT	UT	LT	TH	RT	UT	LT	TH	RT			
7:00 AM	0	45	67	10	6	18	89	29	2	37	474	18	0	20	115	32	962	0	
7:15 AM	0	43	69	20	9	19	116	47	0	54	535	31	1	19	177	57	1,197	0	
7:30 AM	1	50	106	15	7	35	154	60	0	56	661	35	0	14	201	83	1,478	0	
7:45 AM	0	60	179	22	11	30	183	82	0	47	729	23	2	18	215	122	1,723	5,360	
8:00 AM	1	69	192	34	10	33	162	93	0	40	613	23	1	26	311	104	1,712	6,110	
8:15 AM	0	58	149	36	16	28	200	115	0	43	668	21	0	12	271	74	1,691	6,604	
8:30 AM	1	74	137	35	7	28	210	120	0	43	769	29	0	16	223	72	1,764	6,890	
8:45 AM	1	70	183	29	10	29	225	109	0	29	705	26	0	34	189	74	1,713	6,880	
Count Total	4	469	1082	201	76	220	1339	655	2	349	5154	206	4	159	1702	618	12,240	0	
Peak Hour	All	2	261	657	127	44	119	755	410	0	173	2779	96	3	72	1020	372	6,890	0
	HV	0	2	26	2	1	6	36	1	0	2	19	0	0	1	33	7	136	0
	HV%	0%	1%	4%	2%	2%	5%	5%	0%	-	1%	1%	0%	0%	1%	3%	2%	2%	0

Note: Two-hour count summary volumes include heavy vehicles but exclude bicycles in overall count.

Interval Start	Heavy Vehicle Totals					Bicycles					Pedestrians (Crossing Leg)				
	EB	WB	NB	SB	Total	EB	WB	NB	SB	Total	East	West	North	South	Total
7:00 AM	4	5	2	16	27	0	0	0	1	1	2	0	0	2	4
7:15 AM	2	5	4	6	17	0	0	0	1	1	2	2	1	1	6
7:30 AM	6	7	5	9	27	2	0	0	0	2	0	1	0	0	1
7:45 AM	10	8	6	7	31	1	0	0	0	1	0	0	0	1	1
8:00 AM	5	9	4	10	28	0	0	0	0	0	0	1	2	9	12
8:15 AM	10	13	5	11	39	0	0	0	0	0	0	0	1	2	3
8:30 AM	5	14	6	13	38	0	0	0	0	0	0	1	0	4	5
8:45 AM	8	6	7	8	29	0	1	0	0	1	0	0	2	1	3
Count Total	50	67	39	80	236	3	1	0	2	6	4	5	6	20	35
Peak Hour	30	44	21	41	136	1	0	0	0	1	0	2	3	16	21

Two-Hour Count Summaries - Heavy Vehicles																		
Interval Start	El Camino Real				El Camino Real				San Tomas Expy				San Tomas Expy				15-min Total	Rolling One Hour
	Eastbound				Westbound				Northbound				Southbound					
	UT	LT	TH	RT	UT	LT	TH	RT	UT	LT	TH	RT	UT	LT	TH	RT		
7:00 AM	0	1	2	1	0	0	5	0	0	0	2	0	0	0	13	3	27	0
7:15 AM	0	0	2	0	0	0	4	1	0	0	4	0	0	0	4	2	17	0
7:30 AM	0	0	6	0	0	0	6	1	0	0	4	1	0	2	6	1	27	0
7:45 AM	0	2	8	0	0	2	6	0	0	1	5	0	0	0	4	3	31	102
8:00 AM	0	0	4	1	0	1	8	0	0	0	4	0	0	0	8	2	28	103
8:15 AM	0	0	10	0	1	1	11	0	0	1	4	0	0	1	8	2	39	125
8:30 AM	0	0	4	1	0	2	11	1	0	0	6	0	0	0	13	0	38	136
8:45 AM	0	1	5	2	0	0	6	0	0	2	5	0	0	0	7	1	29	134
Count Total	0	4	41	5	1	6	57	3	0	4	34	1	0	3	63	14	236	0
Peak Hour	0	2	26	2	1	6	36	1	0	2	19	0	0	1	33	7	136	0

Two-Hour Count Summaries - Bikes														
Interval Start	El Camino Real			El Camino Real			San Tomas Expy			San Tomas Expy			15-min Total	Rolling One Hour
	Eastbound			Westbound			Northbound			Southbound				
	LT	TH	RT	LT	TH	RT	LT	TH	RT	LT	TH	RT		
7:00 AM	0	0	0	0	0	0	0	0	0	0	1	0	1	0
7:15 AM	0	0	0	0	0	0	0	0	0	0	1	0	1	0
7:30 AM	0	2	0	0	0	0	0	0	0	0	0	0	2	0
7:45 AM	0	1	0	0	0	0	0	0	0	0	0	0	1	5
8:00 AM	0	0	0	0	0	0	0	0	0	0	0	0	0	4
8:15 AM	0	0	0	0	0	0	0	0	0	0	0	0	0	3
8:30 AM	0	0	0	0	0	0	0	0	0	0	0	0	0	1
8:45 AM	0	0	0	0	1	0	0	0	0	0	0	0	1	1
Count Total	0	3	0	0	1	0	0	0	0	0	2	0	6	0
Peak Hour	0	1	0	0	0	0	0	0	0	0	0	0	1	0

Note: U-Turn volumes for bikes are included in Left-Turn, if any.

LOCATION: San Tomas Expy -- El Camino Real (Rte 82)
CITY/STATE: Santa Clara, CA

QC JOB #: 12781729
DATE: Tue, Sep 23 2014

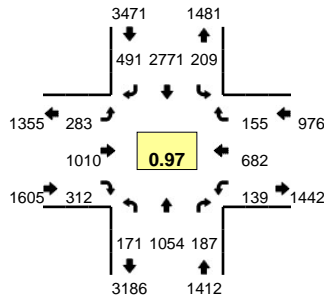

Peak-Hour: 4:45 PM -- 5:45 PM
Peak 15-Min: 5:00 PM -- 5:15 PM

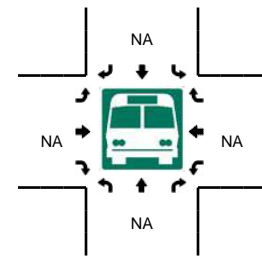
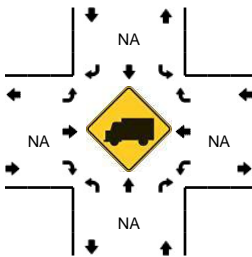
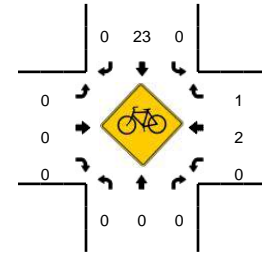
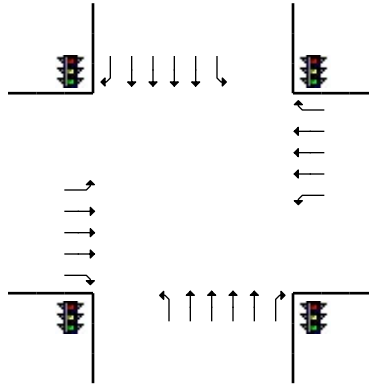
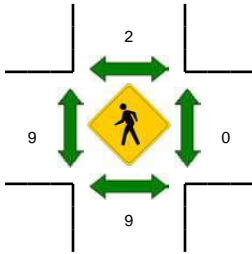
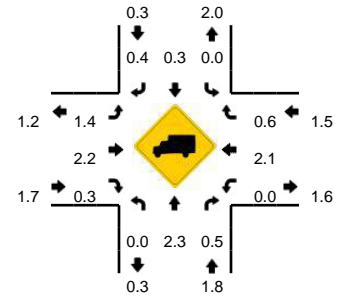

15-Min Count Period Beginning At	San Tomas Expy (Northbound)				San Tomas Expy (Southbound)				El Camino Real (Rte 82) (Eastbound)				El Camino Real (Rte 82) (Westbound)				Total	Hourly Totals
	Left	Thru	Right	U	Left	Thru	Right	U	Left	Thru	Right	U	Left	Thru	Right	U		
4:30 PM	27	234	47	0	41	714	103	0	74	224	77	4	34	151	30	11	1771	
4:45 PM	39	261	55	0	61	765	142	0	78	220	76	0	33	124	42	9	1905	
5:00 PM	43	302	50	0	55	727	123	0	50	246	67	5	19	182	43	10	1922	
5:15 PM	49	231	43	0	55	623	108	0	69	259	75	2	27	183	34	8	1766	7364
5:30 PM	40	260	39	0	38	656	118	0	75	285	94	4	24	193	36	9	1871	7464
5:45 PM	43	282	48	0	53	708	120	1	67	226	78	5	32	147	31	8	1849	7408
6:00 PM	44	269	37	0	43	527	116	0	61	249	36	2	31	176	31	8	1630	7116
6:15 PM	49	247	26	0	52	450	122	0	60	268	56	4	36	191	35	12	1608	6958
Peak 15-Min Flowrates	Northbound				Southbound				Eastbound				Westbound				Total	
	Left	Thru	Right	U	Left	Thru	Right	U	Left	Thru	Right	U	Left	Thru	Right	U		
All Vehicles	172	1208	200	0	220	2908	492	0	200	984	268	20	76	728	172	40	7688	
Heavy Trucks	0	32	4		0	4	0		4	24	0		0	16	0		84	
Pedestrians		8				4				4				0			16	
Bicycles	0	0	0		0	6	0		0	0	0		0	1	0		7	
Railroad																		
Stopped Buses																		

Comments: Separate out NB/SB HOV lanes.

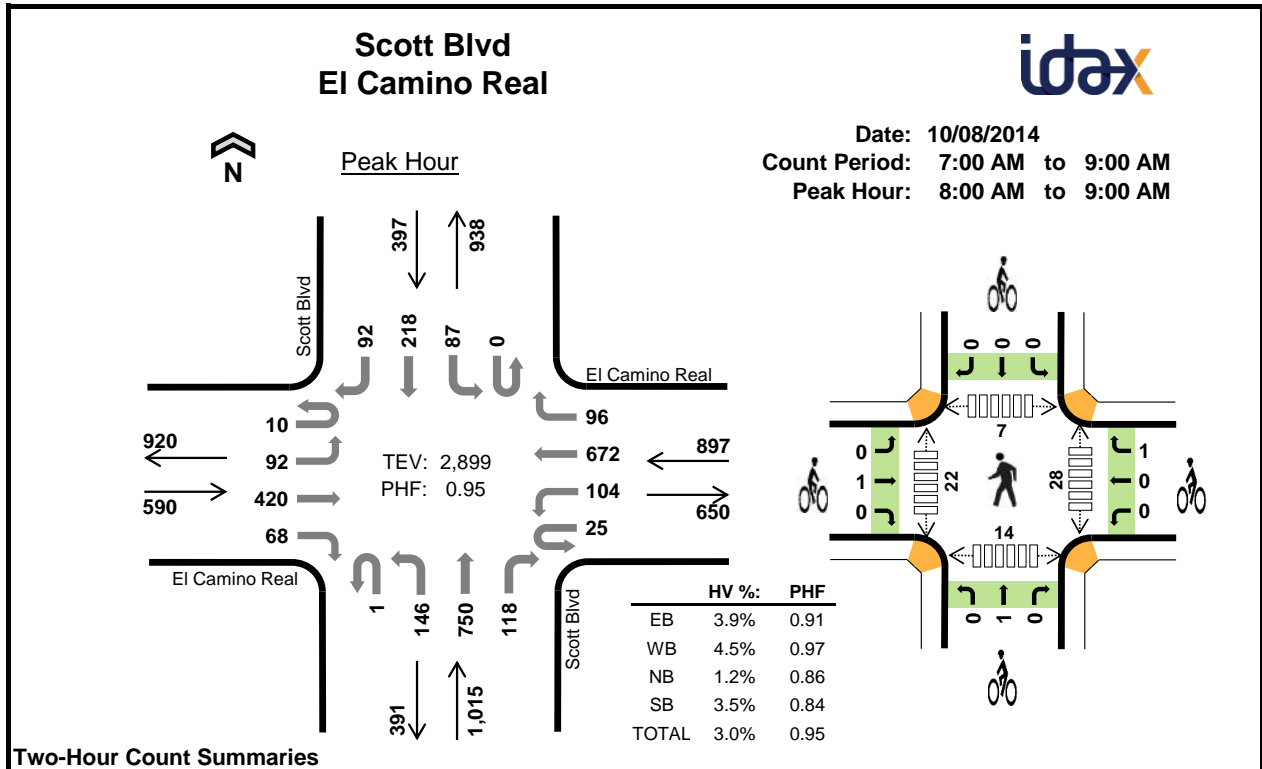

Two-Hour Count Summaries

Interval Start	El Camino Real Eastbound				El Camino Real Westbound				Scott Blvd Northbound				Scott Blvd Southbound				15-min Total	Rolling One Hour	
	UT	LT	TH	RT	UT	LT	TH	RT	UT	LT	TH	RT	UT	LT	TH	RT			
7:00 AM	2	8	57	5	5	15	93	17	1	23	72	15	0	13	27	12	365	0	
7:15 AM	2	13	73	6	4	10	141	21	0	38	87	17	0	16	37	17	482	0	
7:30 AM	3	27	83	10	13	11	187	33	1	37	117	23	0	16	35	36	632	0	
7:45 AM	3	38	104	14	4	21	189	37	2	36	155	24	0	22	43	23	715	2,194	
8:00 AM	0	23	117	22	6	24	179	18	0	34	157	26	0	26	63	10	705	2,534	
8:15 AM	2	23	98	19	5	27	166	34	0	47	165	21	0	17	35	31	690	2,742	
8:30 AM	3	22	98	16	5	27	160	21	1	36	227	32	0	22	51	24	745	2,855	
8:45 AM	5	24	107	11	9	26	167	23	0	29	201	39	0	22	69	27	759	2,899	
Count Total	20	178	737	103	51	161	1282	204	5	280	1181	197	0	154	360	180	5,093	0	
Peak Hour	All	10	92	420	68	25	104	672	96	1	146	750	118	0	87	218	92	2,899	0
	HV	0	4	19	0	1	3	30	5	0	3	7	2	0	2	10	2	88	0
	HV%	0%	4%	5%	0%	4%	3%	4%	5%	0%	2%	1%	2%	-	2%	5%	2%	3%	0

Note: Two-hour count summary volumes include heavy vehicles but exclude bicycles in overall count.

Interval Start	Heavy Vehicle Totals					Bicycles					Pedestrians (Crossing Leg)				
	EB	WB	NB	SB	Total	EB	WB	NB	SB	Total	East	West	North	South	Total
7:00 AM	3	5	1	4	13	1	1	0	0	2	0	0	2	0	2
7:15 AM	3	6	3	8	20	0	0	0	0	0	2	2	4	2	10
7:30 AM	9	12	1	1	23	0	1	0	0	1	2	4	4	1	11
7:45 AM	6	7	2	2	17	1	1	1	1	4	2	1	2	0	5
8:00 AM	2	10	4	2	18	0	0	0	0	0	2	3	2	1	8
8:15 AM	11	11	4	1	27	0	0	0	0	0	4	7	1	4	16
8:30 AM	6	9	1	5	21	1	1	0	0	2	15	7	2	3	27
8:45 AM	4	9	3	6	22	0	0	1	0	1	7	5	2	6	20
Count Total	44	69	19	29	161	3	4	2	1	10	34	29	19	17	99
Peak Hour	23	39	12	14	88	1	1	1	0	3	28	22	7	14	71

Two-Hour Count Summaries - Heavy Vehicles																		
Interval Start	El Camino Real				El Camino Real				Scott Blvd				Scott Blvd				15-min Total	Rolling One Hour
	Eastbound				Westbound				Northbound				Southbound					
	UT	LT	TH	RT	UT	LT	TH	RT	UT	LT	TH	RT	UT	LT	TH	RT		
7:00 AM	0	0	3	0	0	1	4	0	0	0	1	0	0	0	3	1	13	0
7:15 AM	0	0	3	0	0	1	5	0	0	1	2	0	0	3	2	3	20	0
7:30 AM	0	1	7	1	0	3	9	0	0	1	0	0	0	0	0	1	23	0
7:45 AM	0	2	4	0	0	3	4	0	0	0	2	0	0	1	1	0	17	73
8:00 AM	0	1	1	0	1	0	7	2	0	1	2	1	0	0	2	0	18	78
8:15 AM	0	3	8	0	0	1	9	1	0	2	2	0	0	0	1	0	27	85
8:30 AM	0	0	6	0	0	1	6	2	0	0	0	1	0	2	3	0	21	83
8:45 AM	0	0	4	0	0	1	8	0	0	0	3	0	0	0	4	2	22	88
Count Total	0	7	36	1	1	11	52	5	0	5	12	2	0	6	16	7	161	0
Peak Hour	0	4	19	0	1	3	30	5	0	3	7	2	0	2	10	2	88	0

Two-Hour Count Summaries - Bikes														
Interval Start	El Camino Real			El Camino Real			Scott Blvd			Scott Blvd			15-min Total	Rolling One Hour
	Eastbound			Westbound			Northbound			Southbound				
	LT	TH	RT	LT	TH	RT	LT	TH	RT	LT	TH	RT		
7:00 AM	0	1	0	0	1	0	0	0	0	0	0	0	2	0
7:15 AM	0	0	0	0	0	0	0	0	0	0	0	0	0	0
7:30 AM	0	0	0	0	0	1	0	0	0	0	0	0	1	0
7:45 AM	0	1	0	0	1	0	0	1	0	0	1	0	4	7
8:00 AM	0	0	0	0	0	0	0	0	0	0	0	0	0	5
8:15 AM	0	0	0	0	0	0	0	0	0	0	0	0	0	5
8:30 AM	0	1	0	0	0	1	0	0	0	0	0	0	2	6
8:45 AM	0	0	0	0	0	0	0	1	0	0	0	0	1	3
Count Total	0	3	0	0	2	2	0	2	0	0	1	0	10	0
Peak Hour	0	1	0	0	0	1	0	1	0	0	0	0	3	0

Note: U-Turn volumes for bikes are included in Left-Turn, if any.

INTERSECTION TURNING MOVEMENT COUNT SUMMARY

CLIENT: KITTELSON ASSOCIATES
 PROJECT: 2014 SCVTA CMP MONITORING
 DATE: WEDNESDAY SEPTEMBER 17, 2014
 PERIOD: 4:00 PM TO 6:00 PM
 INTERSECTION: N/S EL CAMINO REAL
 E/W SCOTT BOULEVARD
 CITY: SANTA CLARA

VEHICLES

15 MIN COUNTS														4:00 PM TO 6:00 PM
PERIOD	1	2	3	4	5	6	7	8	9	10	11	12	TOTAL	
	SBRT	SBTH	SBLT	WBRT	WBTH	WBLT	NBRT	NBTH	NBLT	EBRT	EBTH	EBLT		
400-415	9	130	20	30	126	50	13	157	45	14	69	28	691	
415-430	13	173	31	40	151	50	25	180	40	18	76	32	829	
430-445	23	159	39	39	137	49	13	161	42	16	52	22	752	
445-500	14	175	23	44	154	47	20	182	51	15	43	26	794	
500-515	17	219	41	44	188	46	31	206	63	17	38	41	951	
515-530	8	196	29	66	206	60	23	175	69	15	49	29	925	
530-545	19	201	41	37	203	65	14	209	53	22	64	42	970	
545-600	38	188	36	46	192	41	17	189	58	11	69	24	909	
HOOR TOTALS														
TIME	1	2	3	4	5	6	7	8	9	10	11	12	TOTAL	
	SBRT	SBTH	SBLT	WBRT	WBTH	WBLT	NBRT	NBTH	NBLT	EBRT	EBTH	EBLT		
400-500	59	637	113	153	568	196	71	680	178	63	240	108	3066	
415-515	67	726	134	167	630	192	89	729	196	66	209	121	3326	
430-530	62	749	132	193	685	202	87	724	225	63	182	118	3422	
445-545	58	791	134	191	751	218	88	772	236	69	194	138	3640	
500-600	82	804	147	193	789	212	85	779	243	65	220	136	3755	

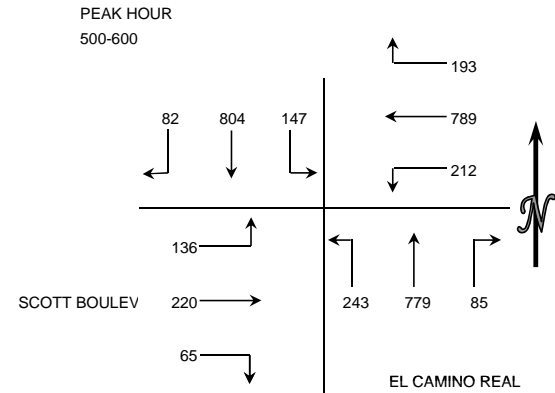

BICYCLES

15 MIN COUNTS														4:00 PM TO 6:00 PM
PERIOD	1	2	3	4	5	6	7	8	9	10	11	12	TOTAL	
	SBRT	SBTH	SBLT	WBRT	WBTH	WBLT	NBRT	NBTH	NBLT	EBRT	EBTH	EBLT		
400-415	0	0	0	0	2	0	0	3	0	0	2	0	7	
415-430	0	0	0	0	2	0	0	1	0	0	6	0	9	
430-445	0	0	0	0	2	0	0	1	1	0	0	0	4	
445-500	0	0	0	0	3	0	0	0	0	1	0	0	4	
500-515	0	0	0	0	2	0	0	0	0	0	0	0	2	
515-530	0	0	0	0	2	1	0	1	0	0	1	0	5	
530-545	0	1	0	0	2	0	2	1	0	0	0	0	6	
545-600	0	0	0	0	0	0	0	0	0	1	0	0	1	
HOOR TOTALS														
TIME	1	2	3	4	5	6	7	8	9	10	11	12	TOTAL	
	SBRT	SBTH	SBLT	WBRT	WBTH	WBLT	NBRT	NBTH	NBLT	EBRT	EBTH	EBLT		
400-500	0	0	0	0	9	0	0	5	1	1	8	0	24	
415-515	0	0	0	0	9	0	0	2	1	1	6	0	19	
430-530	0	0	0	0	9	1	0	2	1	1	1	0	15	
445-545	0	1	0	0	9	1	2	2	0	1	1	0	17	
500-600	0	1	0	0	6	1	2	2	0	1	1	0	14	

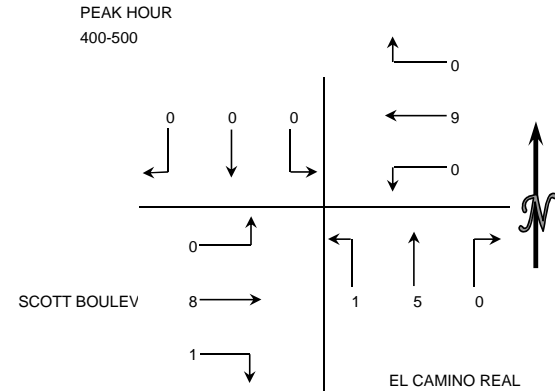

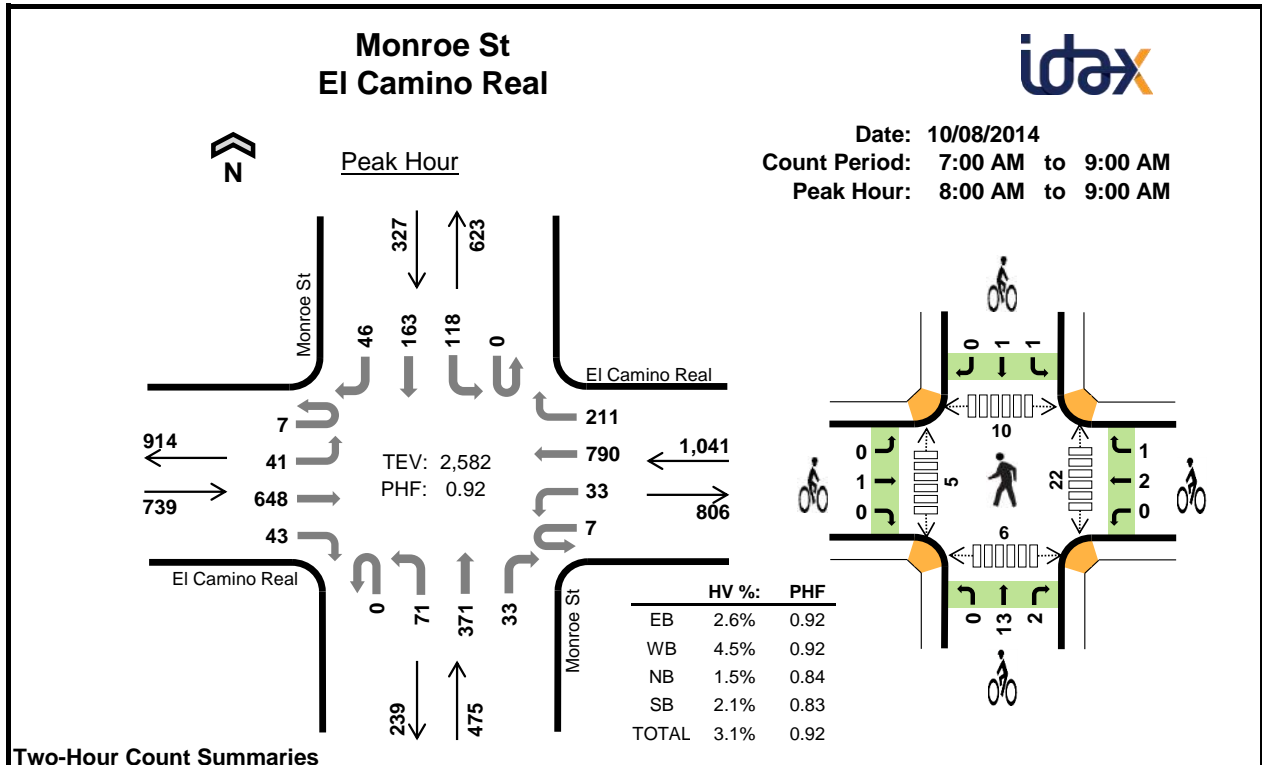

Two-Hour Count Summaries

Interval Start	El Camino Real Eastbound				El Camino Real Westbound				Monroe St Northbound				Monroe St Southbound				15-min Total	Rolling One Hour	
	UT	LT	TH	RT	UT	LT	TH	RT	UT	LT	TH	RT	UT	LT	TH	RT			
7:00 AM	0	4	86	4	0	4	110	22	0	4	33	5	0	20	20	7	319	0	
7:15 AM	0	4	84	6	0	6	148	31	0	8	54	4	0	26	30	2	403	0	
7:30 AM	0	8	118	7	0	7	223	45	0	15	48	10	0	20	26	8	535	0	
7:45 AM	0	6	148	17	0	12	202	50	0	21	75	5	0	17	48	12	613	1,870	
8:00 AM	0	6	160	16	1	7	174	58	0	12	76	5	0	22	57	10	604	2,155	
8:15 AM	2	9	156	12	1	8	223	51	0	25	109	8	0	36	46	16	702	2,454	
8:30 AM	3	11	155	9	3	6	208	53	0	17	88	13	0	25	26	15	632	2,551	
8:45 AM	2	15	177	6	2	12	185	49	0	17	98	7	0	35	34	5	644	2,582	
Count Total	7	63	1084	77	7	62	1473	359	0	119	581	57	0	201	287	75	4,452	0	
Peak Hour	All	7	41	648	43	7	33	790	211	0	71	371	33	0	118	163	46	2,582	0
	HV	0	0	18	1	0	1	43	3	0	1	5	1	0	3	3	1	80	0
	HV%	0%	0%	3%	2%	0%	3%	5%	1%	-	1%	1%	3%	-	3%	2%	2%	3%	0

Note: Two-hour count summary volumes include heavy vehicles but exclude bicycles in overall count.

Interval Start	Heavy Vehicle Totals					Bicycles					Pedestrians (Crossing Leg)				
	EB	WB	NB	SB	Total	EB	WB	NB	SB	Total	East	West	North	South	Total
7:00 AM	4	6	0	1	11	1	1	0	1	3	1	1	0	1	3
7:15 AM	5	5	1	0	11	0	1	3	0	4	2	3	0	0	5
7:30 AM	4	15	2	2	23	1	0	5	0	6	6	2	1	0	9
7:45 AM	4	5	3	5	17	1	1	8	4	14	0	2	0	0	2
8:00 AM	2	10	0	0	12	0	0	6	0	6	0	0	0	0	0
8:15 AM	8	16	2	4	30	0	0	4	0	4	4	0	4	0	8
8:30 AM	6	11	1	1	19	0	1	5	2	8	9	2	0	2	13
8:45 AM	3	10	4	2	19	1	2	0	0	3	9	3	6	4	22
Count Total	36	78	13	15	142	4	6	31	7	48	31	13	11	7	62
Peak Hour	19	47	7	7	80	1	3	15	2	21	22	5	10	6	43

Two-Hour Count Summaries - Heavy Vehicles																		
Interval Start	El Camino Real				El Camino Real				Monroe St				Monroe St				15-min Total	Rolling One Hour
	Eastbound				Westbound				Northbound				Southbound					
	UT	LT	TH	RT	UT	LT	TH	RT	UT	LT	TH	RT	UT	LT	TH	RT		
7:00 AM	0	0	4	0	0	1	4	1	0	0	0	0	0	0	1	0	11	0
7:15 AM	0	0	4	1	0	0	5	0	0	0	1	0	0	0	0	0	11	0
7:30 AM	0	0	3	1	0	0	13	2	0	1	1	0	0	1	0	1	23	0
7:45 AM	0	0	4	0	0	0	5	0	0	0	2	1	0	1	4	0	17	62
8:00 AM	0	0	2	0	0	0	9	1	0	0	0	0	0	0	0	0	12	63
8:15 AM	0	0	8	0	0	1	15	0	0	0	2	0	0	1	2	1	30	82
8:30 AM	0	0	6	0	0	0	11	0	0	0	1	0	0	1	0	0	19	78
8:45 AM	0	0	2	1	0	0	8	2	0	1	2	1	0	1	1	0	19	80
Count Total	0	0	33	3	0	2	70	6	0	2	9	2	0	5	8	2	142	0
Peak Hour	0	0	18	1	0	1	43	3	0	1	5	1	0	3	3	1	80	0

Two-Hour Count Summaries - Bikes																
Interval Start	El Camino Real			El Camino Real			Monroe St			Monroe St			15-min Total	Rolling One Hour		
	Eastbound			Westbound			Northbound			Southbound						
	LT	TH	RT	LT	TH	RT	LT	TH	RT	LT	TH	RT				
7:00 AM	0	1	0	0	1	0	0	0	0	1	0	0	3	0		
7:15 AM	0	0	0	0	1	0	0	3	0	0	0	0	4	0		
7:30 AM	0	1	0	0	0	0	0	4	1	0	0	0	6	0		
7:45 AM	0	1	0	0	1	0	0	7	1	0	4	0	14	27		
8:00 AM	0	0	0	0	0	0	0	6	0	0	0	0	6	30		
8:15 AM	0	0	0	0	0	0	0	4	0	0	0	0	4	30		
8:30 AM	0	0	0	0	0	1	0	3	2	1	1	0	8	32		
8:45 AM	0	1	0	0	2	0	0	0	0	0	0	0	3	21		
Count Total	0	4	0	0	5	1	0	27	4	2	5	0	48	0		
Peak Hour	0	1	0	0	2	1	0	13	2	1	1	0	21	0		

Note: U-Turn volumes for bikes are included in Left-Turn, if any.

INTERSECTION TURNING MOVEMENT COUNT SUMMARY

CLIENT: KITTELSON ASSOCIATES
 PROJECT: 2014 SCVTA CMP MONITORING
 DATE: WEDNESDAY SEPTEMBER 17, 2014
 PERIOD: 4:00 PM TO 6:00 PM
 INTERSECTION: N/S EL CAMINO REAL
 E/W MONROE STREET
 CITY: SANTA CLARA

VEHICLES

15 MIN COUNTS														4:00 PM TO 6:00 PM
PERIOD	1 SBRT	2 SBTH	3 SBLT	4 WBRT	5 WBTH	6 WBLT	7 NBRT	8 NBTH	9 NBLT	10 EBRT	11 EBTH	12 EBLT	TOTAL	
400-415	5	165	19	47	46	8	9	203	7	18	22	8	557	
415-430	12	159	28	47	40	5	20	206	11	15	33	7	583	
430-445	13	147	14	46	66	11	12	197	12	12	30	7	567	
445-500	13	196	28	53	81	10	16	211	21	11	25	5	670	
500-515	15	201	29	56	71	7	14	250	22	9	31	11	716	
515-530	28	161	36	65	125	10	15	196	21	17	45	5	724	
530-545	26	204	27	47	97	16	15	270	16	21	43	5	787	
545-600	16	200	33	70	128	15	13	191	28	17	34	5	750	
HOUR TOTALS														
TIME	1 SBRT	2 SBTH	3 SBLT	4 WBRT	5 WBTH	6 WBLT	7 NBRT	8 NBTH	9 NBLT	10 EBRT	11 EBTH	12 EBLT	TOTAL	
400-500	43	667	89	193	233	34	57	817	51	56	110	27	2377	
415-515	53	703	99	202	258	33	62	864	66	47	119	30	2536	
430-530	69	705	107	220	343	38	57	854	76	49	131	28	2677	
445-545	82	762	120	221	374	43	60	927	80	58	144	26	2897	
500-600	85	766	125	238	421	48	57	907	87	64	153	26	2977	

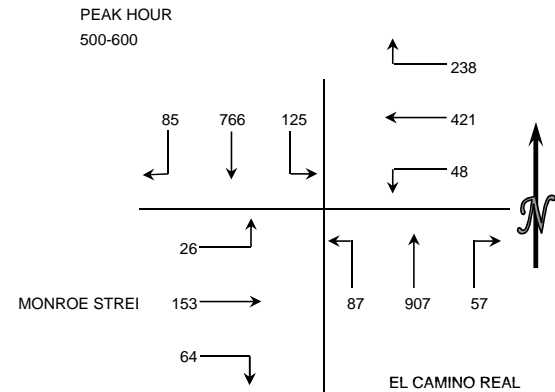

BICYCLES

15 MIN COUNTS														4:00 PM TO 6:00 PM
PERIOD	1 SBRT	2 SBTH	3 SBLT	4 WBRT	5 WBTH	6 WBLT	7 NBRT	8 NBTH	9 NBLT	10 EBRT	11 EBTH	12 EBLT	TOTAL	
400-415	0	1	0	0	1	0	0	0	0	0	3	0	5	
415-430	0	0	0	1	2	0	0	0	0	0	2	0	5	
430-445	0	2	0	0	5	0	0	0	0	0	0	0	7	
445-500	0	0	1	0	4	0	0	1	0	0	0	0	6	
500-515	0	1	0	0	5	0	0	2	0	0	1	0	9	
515-530	0	1	1	0	7	0	0	2	0	0	2	0	13	
530-545	0	0	0	0	7	0	0	0	0	0	5	0	12	
545-600	0	0	0	0	6	0	0	0	0	0	0	0	6	
HOUR TOTALS														
TIME	1 SBRT	2 SBTH	3 SBLT	4 WBRT	5 WBTH	6 WBLT	7 NBRT	8 NBTH	9 NBLT	10 EBRT	11 EBTH	12 EBLT	TOTAL	
400-500	0	3	1	1	12	0	0	1	0	0	5	0	23	
415-515	0	3	1	1	16	0	0	3	0	0	3	0	27	
430-530	0	4	2	0	21	0	0	5	0	0	3	0	35	
445-545	0	2	2	0	23	0	0	5	0	0	8	0	40	
500-600	0	2	1	0	25	0	0	4	0	0	8	0	40	

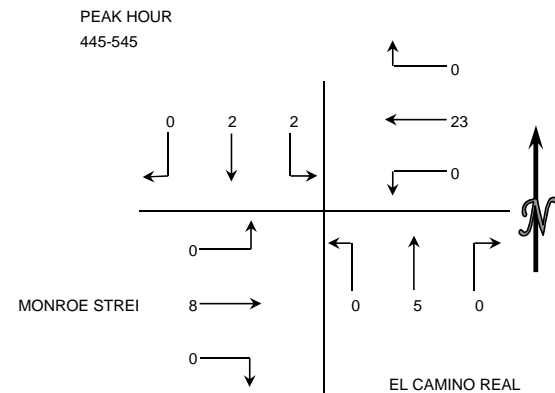

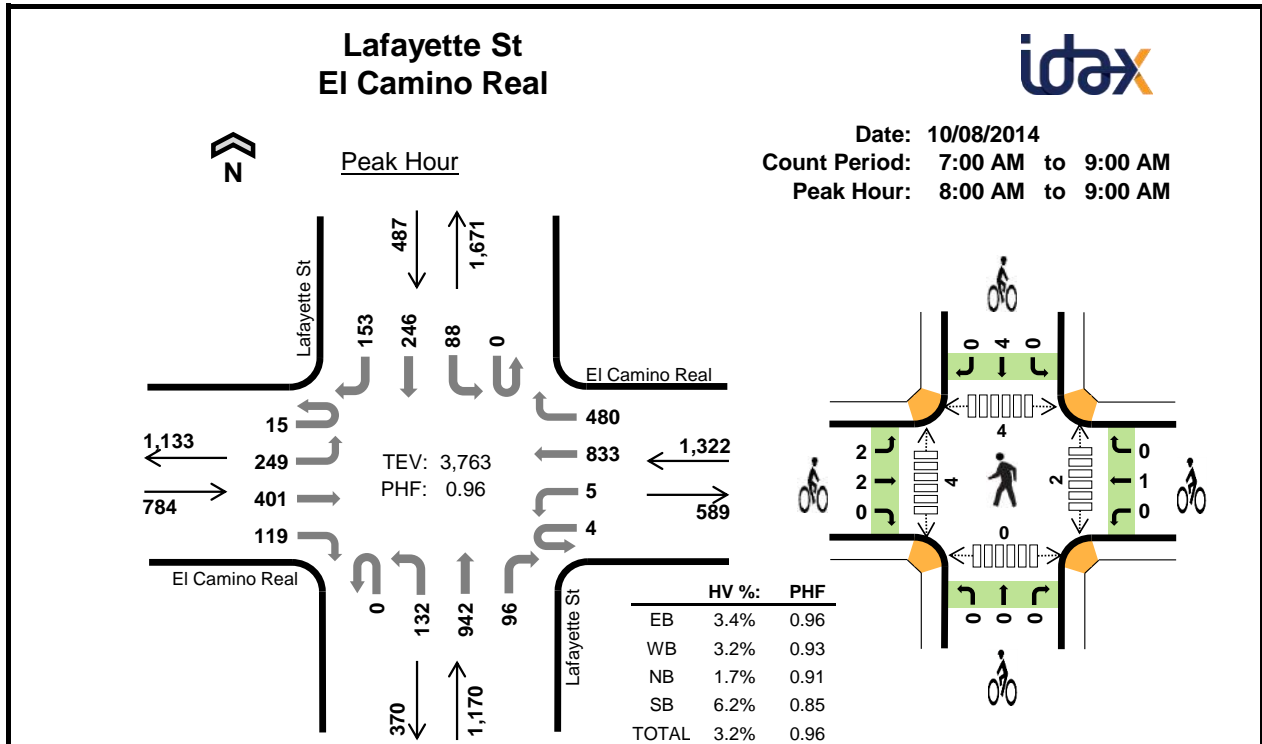

Two-Hour Count Summaries

Interval Start	El Camino Real Eastbound				El Camino Real Westbound				Lafayette St Northbound				Lafayette St Southbound				15-min Total	Rolling One Hour	
	UT	LT	TH	RT	UT	LT	TH	RT	UT	LT	TH	RT	UT	LT	TH	RT			
7:00 AM	3	40	51	26	2	4	120	75	0	16	115	18	0	16	29	14	529	0	
7:15 AM	1	40	58	21	1	0	165	100	0	22	145	22	0	12	60	17	664	0	
7:30 AM	2	57	79	23	0	4	207	121	0	27	206	13	0	11	53	22	825	0	
7:45 AM	7	63	87	24	0	0	188	111	0	29	241	22	0	22	70	43	907	2,925	
8:00 AM	2	58	97	25	0	1	182	127	0	35	214	21	0	22	79	37	900	3,296	
8:15 AM	8	58	101	33	2	0	219	125	0	27	237	25	0	24	74	45	978	3,610	
8:30 AM	3	69	99	26	1	2	234	117	0	36	225	29	0	20	36	40	937	3,722	
8:45 AM	2	64	104	35	1	2	198	111	0	34	266	21	0	22	57	31	948	3,763	
Count Total	28	449	676	213	7	13	1513	887	0	226	1649	171	0	149	458	249	6,688	0	
Peak Hour	All	15	249	401	119	4	5	833	480	0	132	942	96	0	88	246	153	3,763	0
	HV	1	7	16	3	1	0	38	3	0	3	9	8	0	5	13	12	119	0
	HV%	7%	3%	4%	3%	25%	0%	5%	1%	-	2%	1%	8%	-	6%	5%	8%	3%	0

Note: Two-hour count summary volumes include heavy vehicles but exclude bicycles in overall count.

Interval Start	Heavy Vehicle Totals					Bicycles					Pedestrians (Crossing Leg)				
	EB	WB	NB	SB	Total	EB	WB	NB	SB	Total	East	West	North	South	Total
7:00 AM	5	7	4	4	20	4	1	0	2	7	1	0	0	1	2
7:15 AM	4	6	2	9	21	1	1	1	0	3	0	0	0	0	0
7:30 AM	7	12	4	7	30	3	0	1	0	4	2	0	0	0	2
7:45 AM	7	3	1	7	18	4	0	0	2	6	0	2	0	1	3
8:00 AM	4	8	6	7	25	0	0	0	0	0	0	2	0	0	2
8:15 AM	9	12	2	9	32	0	1	0	1	2	1	1	0	0	2
8:30 AM	8	12	8	7	35	4	0	0	1	5	1	0	4	0	5
8:45 AM	6	10	4	7	27	0	0	0	2	2	0	1	0	0	1
Count Total	50	70	31	57	208	16	3	2	8	29	5	6	4	2	17
Peak Hour	27	42	20	30	119	4	1	0	4	9	2	4	4	0	10

Two-Hour Count Summaries - Heavy Vehicles																		
Interval Start	El Camino Real				El Camino Real				Lafayette St				Lafayette St				15-min Total	Rolling One Hour
	Eastbound				Westbound				Northbound				Southbound					
	UT	LT	TH	RT	UT	LT	TH	RT	UT	LT	TH	RT	UT	LT	TH	RT		
7:00 AM	0	2	3	0	0	0	5	2	0	0	3	1	0	1	2	1	20	0
7:15 AM	0	1	3	0	0	0	5	1	0	1	1	0	0	3	5	1	21	0
7:30 AM	2	2	3	0	0	0	9	3	0	0	2	2	0	1	4	2	30	0
7:45 AM	0	1	6	0	0	0	1	2	0	0	0	1	0	0	5	2	18	89
8:00 AM	0	1	3	0	0	0	8	0	0	1	4	1	0	0	3	4	25	94
8:15 AM	1	1	6	1	0	0	10	2	0	0	0	2	0	1	3	5	32	105
8:30 AM	0	4	3	1	1	0	10	1	0	1	4	3	0	2	2	3	35	110
8:45 AM	0	1	4	1	1	0	10	0	0	1	1	2	0	2	5	0	27	119
Count Total	3	13	31	3	1	0	58	11	0	4	15	12	0	10	29	18	208	0
Peak Hour	1	7	16	3	1	0	38	3	0	3	9	8	0	5	13	12	119	0
Two-Hour Count Summaries - Bikes																		
Interval Start	El Camino Real			El Camino Real			Lafayette St			Lafayette St			15-min Total	Rolling One Hour				
	Eastbound			Westbound			Northbound			Southbound								
	LT	TH	RT	LT	TH	RT	LT	TH	RT	LT	TH	RT						
7:00 AM	1	3	0	0	1	0	0	0	0	0	2	0	7	0				
7:15 AM	0	0	1	0	1	0	0	1	0	0	0	0	3	0				
7:30 AM	1	2	0	0	0	0	0	1	0	0	0	0	4	0				
7:45 AM	1	3	0	0	0	0	0	0	0	0	2	0	6	20				
8:00 AM	0	0	0	0	0	0	0	0	0	0	0	0	0	13				
8:15 AM	0	0	0	0	1	0	0	0	0	0	1	0	2	12				
8:30 AM	2	2	0	0	0	0	0	0	0	0	1	0	5	13				
8:45 AM	0	0	0	0	0	0	0	0	0	0	2	0	2	9				
Count Total	5	10	1	0	3	0	0	2	0	0	8	0	29	0				
Peak Hour	2	2	0	0	1	0	0	0	0	0	4	0	9	0				
<i>Note: U-Turn volumes for bikes are included in Left-Turn, if any.</i>																		

INTERSECTION TURNING MOVEMENT COUNT SUMMARY

CLIENT: KITTELSON ASSOCIATES
 PROJECT: 2014 SCVTA CMP MONITORING
 DATE: WEDNESDAY SEPTEMBER 17, 2014
 PERIOD: 4:00 PM TO 6:00 PM
 INTERSECTION: N/S EL CAMINO REAL
 E/W LAFAYETTE STREET
 CITY: SANTA CLARA

VEHICLES													
15 MIN COUNTS													
4:00 PM TO 6:00 PM													
PERIOD	1 SBRT	2 SBTH	3 SBLT	4 WBRT	5 WBTH	6 WBLT	7 NBRT	8 NBTH	9 NBLT	10 EBRT	11 EBTH	12 EBLT	TOTAL
400-415	73	149	35	45	184	50	8	121	6	26	56	35	788
415-430	45	172	26	52	162	54	15	99	6	18	32	31	712
430-445	82	190	40	58	204	75	64	104	6	35	56	31	945
445-500	68	194	45	52	252	64	12	126	12	40	59	42	966
500-515	72	235	63	42	237	74	19	180	6	53	58	40	1079
515-530	21	203	50	48	256	64	8	152	11	43	75	30	961
530-545	50	252	48	28	220	71	8	163	16	44	53	52	1005
545-600	52	180	71	50	234	76	2	145	17	54	69	30	980
HOOR TOTALS													
TIME	1 SBRT	2 SBTH	3 SBLT	4 WBRT	5 WBTH	6 WBLT	7 NBRT	8 NBTH	9 NBLT	10 EBRT	11 EBTH	12 EBLT	TOTAL
400-500	268	705	146	207	802	243	99	450	30	119	203	139	3411
415-515	267	791	174	204	855	267	110	509	30	146	205	144	3702
430-530	243	822	198	200	949	277	103	562	35	171	248	143	3951
445-545	211	884	206	170	965	273	47	621	45	180	245	164	4011
500-600	195	870	232	168	947	285	37	640	50	194	255	152	4025

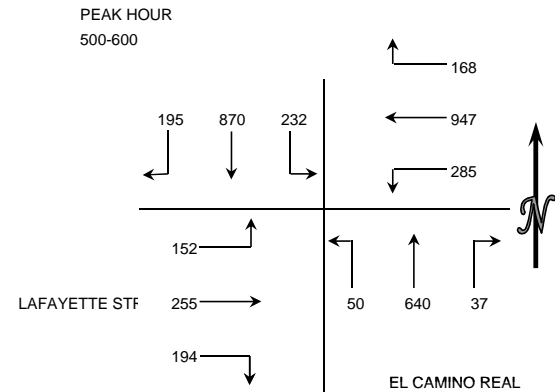

BICYCLES													
15 MIN COUNTS													
4:00 PM TO 6:00 PM													
PERIOD	1 SBRT	2 SBTH	3 SBLT	4 WBRT	5 WBTH	6 WBLT	7 NBRT	8 NBTH	9 NBLT	10 EBRT	11 EBTH	12 EBLT	TOTAL
400-415	0	1	0	1	4	0	0	1	0	0	0	0	7
415-430	0	0	0	0	3	0	0	0	0	0	0	0	3
430-445	0	0	0	1	1	1	1	1	0	0	0	0	5
445-500	0	0	0	0	0	0	0	1	0	4	0	0	5
500-515	0	0	0	0	2	0	0	0	0	0	0	0	2
515-530	0	0	1	2	1	0	0	0	0	1	0	0	5
530-545	0	0	0	0	5	0	0	0	0	0	0	0	5
545-600	0	0	0	2	0	0	0	2	0	0	1	0	5
HOOR TOTALS													
TIME	1 SBRT	2 SBTH	3 SBLT	4 WBRT	5 WBTH	6 WBLT	7 NBRT	8 NBTH	9 NBLT	10 EBRT	11 EBTH	12 EBLT	TOTAL
400-500	0	1	0	2	8	1	1	3	0	4	0	0	20
415-515	0	0	0	1	6	1	1	2	0	4	0	0	15
430-530	0	0	1	3	4	1	1	2	0	5	0	0	17
445-545	0	0	1	2	8	0	0	1	0	5	0	0	17
500-600	0	0	1	4	8	0	0	2	0	1	1	0	17

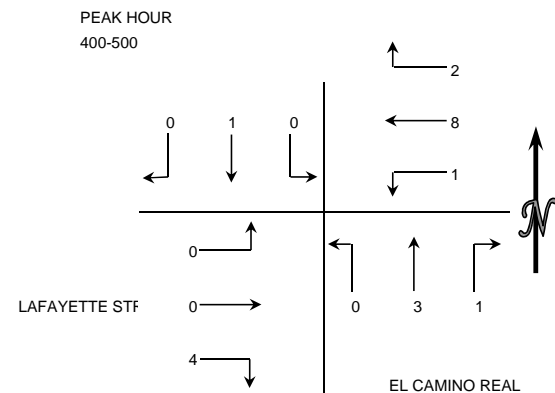

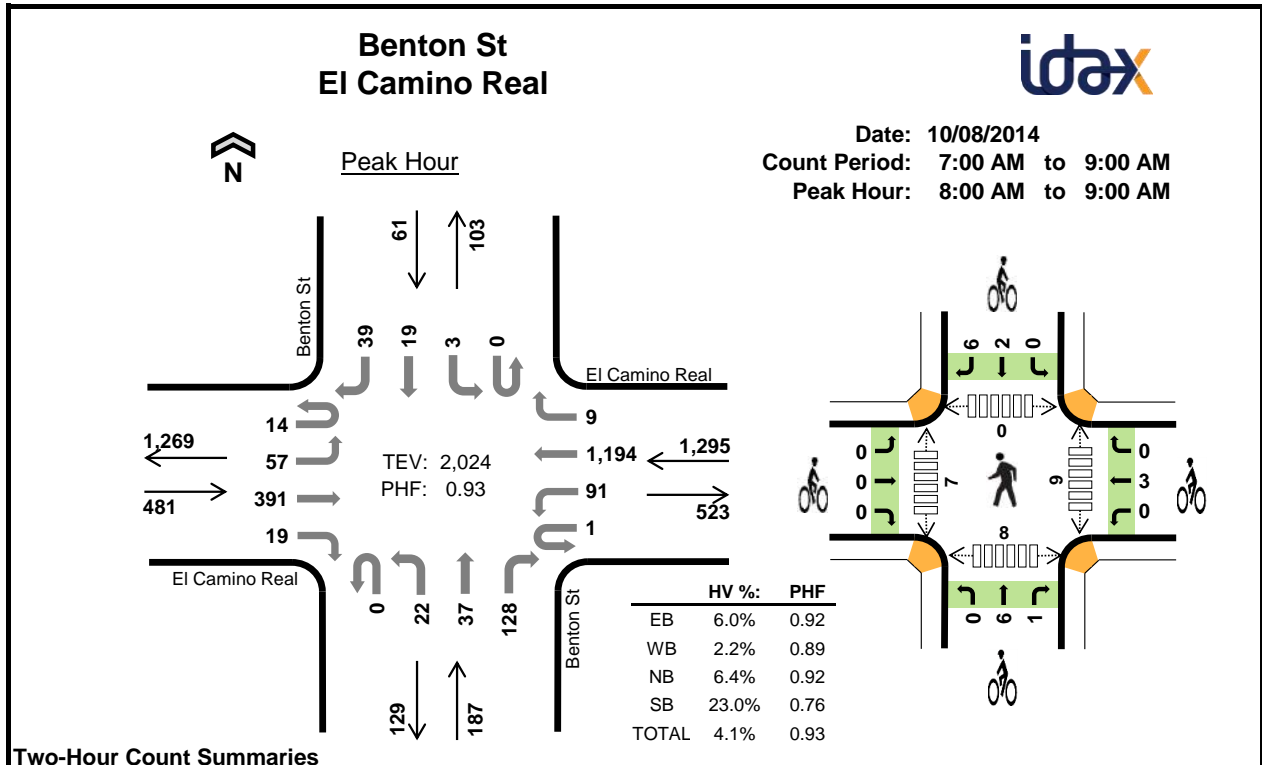

Two-Hour Count Summaries

Interval Start	El Camino Real Eastbound				El Camino Real Westbound				Benton St Northbound				Benton St Southbound				15-min Total	Rolling One Hour	
	UT	LT	TH	RT	UT	LT	TH	RT	UT	LT	TH	RT	UT	LT	TH	RT			
7:00 AM	0	11	58	2	0	23	162	3	0	4	8	9	0	3	4	7	294	0	
7:15 AM	2	8	66	0	0	19	249	4	0	1	9	11	0	1	12	9	391	0	
7:30 AM	3	3	76	4	1	28	257	0	0	8	5	14	0	0	4	4	407	0	
7:45 AM	2	18	69	3	0	29	268	3	0	3	15	27	0	1	7	12	457	1,549	
8:00 AM	4	12	88	9	1	19	291	1	0	4	11	30	0	0	2	12	484	1,739	
8:15 AM	5	19	103	4	0	15	335	1	0	4	11	29	0	2	7	11	546	1,894	
8:30 AM	3	17	94	4	0	21	244	2	0	7	10	34	0	0	4	11	451	1,938	
8:45 AM	2	9	106	2	0	36	324	5	0	7	5	35	0	1	6	5	543	2,024	
Count Total	21	97	660	28	2	190	2130	19	0	38	74	189	0	8	46	71	3,573	0	
Peak Hour	All	14	57	391	19	1	91	1194	9	0	22	37	128	0	3	19	39	2,024	0
	HV	0	14	15	0	0	3	25	0	0	1	4	7	0	1	7	6	83	0
	HV%	0%	25%	4%	0%	0%	3%	2%	0%	-	5%	11%	5%	-	33%	37%	15%	4%	0

Note: Two-hour count summary volumes include heavy vehicles but exclude bicycles in overall count.

Interval Start	Heavy Vehicle Totals					Bicycles					Pedestrians (Crossing Leg)				
	EB	WB	NB	SB	Total	EB	WB	NB	SB	Total	East	West	North	South	Total
7:00 AM	4	6	2	2	14	2	1	2	0	5	3	1	2	4	10
7:15 AM	7	6	3	4	20	0	0	3	0	3	3	1	3	0	7
7:30 AM	5	9	4	0	18	0	1	0	0	1	1	1	0	1	3
7:45 AM	8	8	4	4	24	0	0	0	0	0	7	1	1	1	10
8:00 AM	4	5	1	2	12	0	0	0	1	1	2	0	0	3	5
8:15 AM	10	6	4	4	24	0	1	6	0	7	2	1	0	0	3
8:30 AM	7	9	1	3	20	0	2	1	7	10	4	2	0	5	11
8:45 AM	8	8	6	5	27	0	0	0	0	0	1	4	0	0	5
Count Total	53	57	25	24	159	2	5	12	8	27	23	11	6	14	54
Peak Hour	29	28	12	14	83	0	3	7	8	18	9	7	0	8	24

Two-Hour Count Summaries - Heavy Vehicles																		
Interval Start	El Camino Real				El Camino Real				Benton St				Benton St				15-min Total	Rolling One Hour
	Eastbound				Westbound				Northbound				Southbound					
	UT	LT	TH	RT	UT	LT	TH	RT	UT	LT	TH	RT	UT	LT	TH	RT		
7:00 AM	0	2	2	0	0	2	4	0	0	0	1	1	0	0	0	2	14	0
7:15 AM	0	4	3	0	0	2	4	0	0	0	1	2	0	0	3	1	20	0
7:30 AM	0	1	4	0	0	2	7	0	0	1	2	1	0	0	0	0	18	0
7:45 AM	1	3	4	0	0	4	4	0	0	0	1	3	0	0	3	1	24	76
8:00 AM	0	3	1	0	0	0	5	0	0	0	1	0	0	0	1	1	12	74
8:15 AM	0	5	5	0	0	2	4	0	0	0	1	3	0	0	3	1	24	78
8:30 AM	0	3	4	0	0	0	9	0	0	0	1	0	0	0	1	2	20	80
8:45 AM	0	3	5	0	0	1	7	0	0	1	1	4	0	1	2	2	27	83
Count Total	1	24	28	0	0	13	44	0	0	2	9	14	0	1	13	10	159	0
Peak Hour	0	14	15	0	0	3	25	0	0	1	4	7	0	1	7	6	83	0
Two-Hour Count Summaries - Bikes																		
Interval Start	El Camino Real			El Camino Real			Benton St			Benton St			15-min Total	Rolling One Hour				
	Eastbound			Westbound			Northbound			Southbound								
	LT	TH	RT	LT	TH	RT	LT	TH	RT	LT	TH	RT						
7:00 AM	2	0	0	0	1	0	0	1	1	0	0	0	5	0				
7:15 AM	0	0	0	0	0	0	0	2	1	0	0	0	3	0				
7:30 AM	0	0	0	0	1	0	0	0	0	0	0	0	1	0				
7:45 AM	0	0	0	0	0	0	0	0	0	0	0	0	0	9				
8:00 AM	0	0	0	0	0	0	0	0	0	0	1	0	1	5				
8:15 AM	0	0	0	0	1	0	0	5	1	0	0	0	7	9				
8:30 AM	0	0	0	0	2	0	0	1	0	0	1	6	10	18				
8:45 AM	0	0	0	0	0	0	0	0	0	0	0	0	0	18				
Count Total	2	0	0	0	5	0	0	9	3	0	2	6	27	0				
Peak Hour	0	0	0	0	3	0	0	6	1	0	2	6	18	0				
<i>Note: U-Turn volumes for bikes are included in Left-Turn, if any.</i>																		

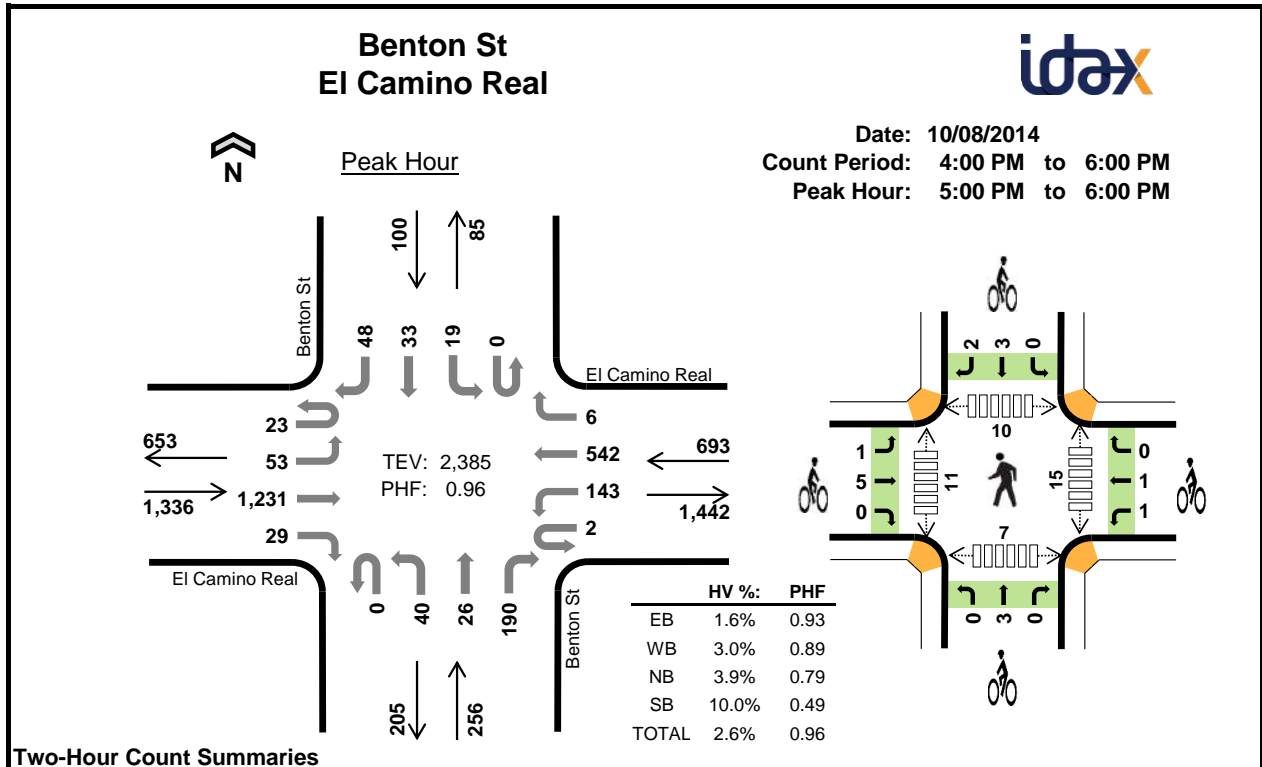

Two-Hour Count Summaries

Interval Start	El Camino Real Eastbound				El Camino Real Westbound				Benton St Northbound				Benton St Southbound				15-min Total	Rolling One Hour	
	UT	LT	TH	RT	UT	LT	TH	RT	UT	LT	TH	RT	UT	LT	TH	RT			
4:00 PM	7	12	186	5	0	25	105	2	0	9	3	34	0	3	6	8	405	0	
4:15 PM	7	14	229	5	0	17	108	2	0	4	3	43	0	0	5	7	444	0	
4:30 PM	4	16	205	8	0	22	90	5	0	9	5	29	0	5	10	7	415	0	
4:45 PM	6	18	279	10	0	32	108	1	0	9	2	35	0	3	10	11	524	1,788	
5:00 PM	4	7	279	5	1	42	129	1	0	8	6	53	0	6	8	10	559	1,942	
5:15 PM	6	19	321	12	1	46	145	2	0	11	5	44	0	1	2	5	620	2,118	
5:30 PM	7	8	312	8	0	40	131	2	0	14	8	59	0	3	5	9	606	2,309	
5:45 PM	6	19	319	4	0	15	137	1	0	7	7	34	0	9	18	24	600	2,385	
Count Total	47	113	2130	57	2	239	953	16	0	71	39	331	0	30	64	81	4,173	0	
Peak Hour	All	23	53	1231	29	2	143	542	6	0	40	26	190	0	19	33	48	2,385	0
	HV	0	12	10	0	0	3	18	0	0	0	4	6	0	0	6	4	63	0
	HV%	0%	23%	1%	0%	0%	2%	3%	0%	-	0%	15%	3%	-	0%	18%	8%	3%	0

Note: Two-hour count summary volumes include heavy vehicles but exclude bicycles in overall count.

Interval Start	Heavy Vehicle Totals					Bicycles					Pedestrians (Crossing Leg)				
	EB	WB	NB	SB	Total	EB	WB	NB	SB	Total	East	West	North	South	Total
4:00 PM	9	7	3	3	22	0	0	0	0	0	0	1	0	1	2
4:15 PM	8	7	3	2	20	0	0	0	0	0	3	2	2	0	7
4:30 PM	3	7	2	3	15	0	1	1	0	2	5	2	0	0	7
4:45 PM	7	5	2	3	17	0	0	0	0	0	4	1	1	1	7
5:00 PM	4	5	4	3	16	2	0	3	0	5	4	0	2	0	6
5:15 PM	7	6	2	2	17	1	2	0	0	3	4	2	3	1	10
5:30 PM	5	6	4	2	17	1	0	0	0	1	1	2	2	2	7
5:45 PM	6	4	0	3	13	2	0	0	5	7	6	7	3	4	20
Count Total	49	47	20	21	137	6	3	4	5	18	27	17	13	9	66
Peak Hour	22	21	10	10	63	6	2	3	5	16	15	11	10	7	43

Two-Hour Count Summaries - Heavy Vehicles																		
Interval Start	El Camino Real				El Camino Real				Benton St				Benton St				15-min Total	Rolling One Hour
	Eastbound				Westbound				Northbound				Southbound					
	UT	LT	TH	RT	UT	LT	TH	RT	UT	LT	TH	RT	UT	LT	TH	RT		
4:00 PM	0	4	5	0	0	1	6	0	0	0	1	2	0	0	2	1	22	0
4:15 PM	1	3	4	0	0	1	6	0	0	0	1	2	0	0	1	1	20	0
4:30 PM	0	0	3	0	0	1	6	0	0	0	2	0	0	0	2	1	15	0
4:45 PM	0	4	3	0	0	1	4	0	0	0	1	1	0	0	2	1	17	74
5:00 PM	0	3	1	0	0	1	4	0	0	0	1	3	0	0	2	1	16	68
5:15 PM	0	5	2	0	0	1	5	0	0	0	1	1	0	0	1	1	17	65
5:30 PM	0	1	4	0	0	1	5	0	0	0	2	2	0	0	1	1	17	67
5:45 PM	0	3	3	0	0	0	4	0	0	0	0	0	0	0	2	1	13	63
Count Total	1	23	25	0	0	7	40	0	0	0	9	11	0	0	13	8	137	0
Peak Hour	0	12	10	0	0	3	18	0	0	0	4	6	0	0	6	4	63	0
Two-Hour Count Summaries - Bikes																		
Interval Start	El Camino Real			El Camino Real			Benton St			Benton St			15-min Total	Rolling One Hour				
	Eastbound			Westbound			Northbound			Southbound								
	LT	TH	RT	LT	TH	RT	LT	TH	RT	LT	TH	RT						
4:00 PM	0	0	0	0	0	0	0	0	0	0	0	0	0	0	0	0	0	0
4:15 PM	0	0	0	0	0	0	0	0	0	0	0	0	0	0	0	0	0	0
4:30 PM	0	0	0	0	1	0	0	1	0	0	0	0	0	0	0	0	2	0
4:45 PM	0	0	0	0	0	0	0	0	0	0	0	0	0	0	0	0	0	2
5:00 PM	0	2	0	0	0	0	0	0	3	0	0	0	0	0	0	0	5	7
5:15 PM	0	1	0	1	1	0	0	0	0	0	0	0	0	0	0	0	3	10
5:30 PM	0	1	0	0	0	0	0	0	0	0	0	0	0	0	0	0	1	9
5:45 PM	1	1	0	0	0	0	0	0	0	0	0	0	0	3	2	7	16	
Count Total	1	5	0	1	2	0	0	4	0	0	3	2	0	3	2	18	0	
Peak Hour	1	5	0	1	1	0	0	3	0	0	3	2	0	3	2	16	0	
<i>Note: U-Turn volumes for bikes are included in Left-Turn, if any.</i>																		

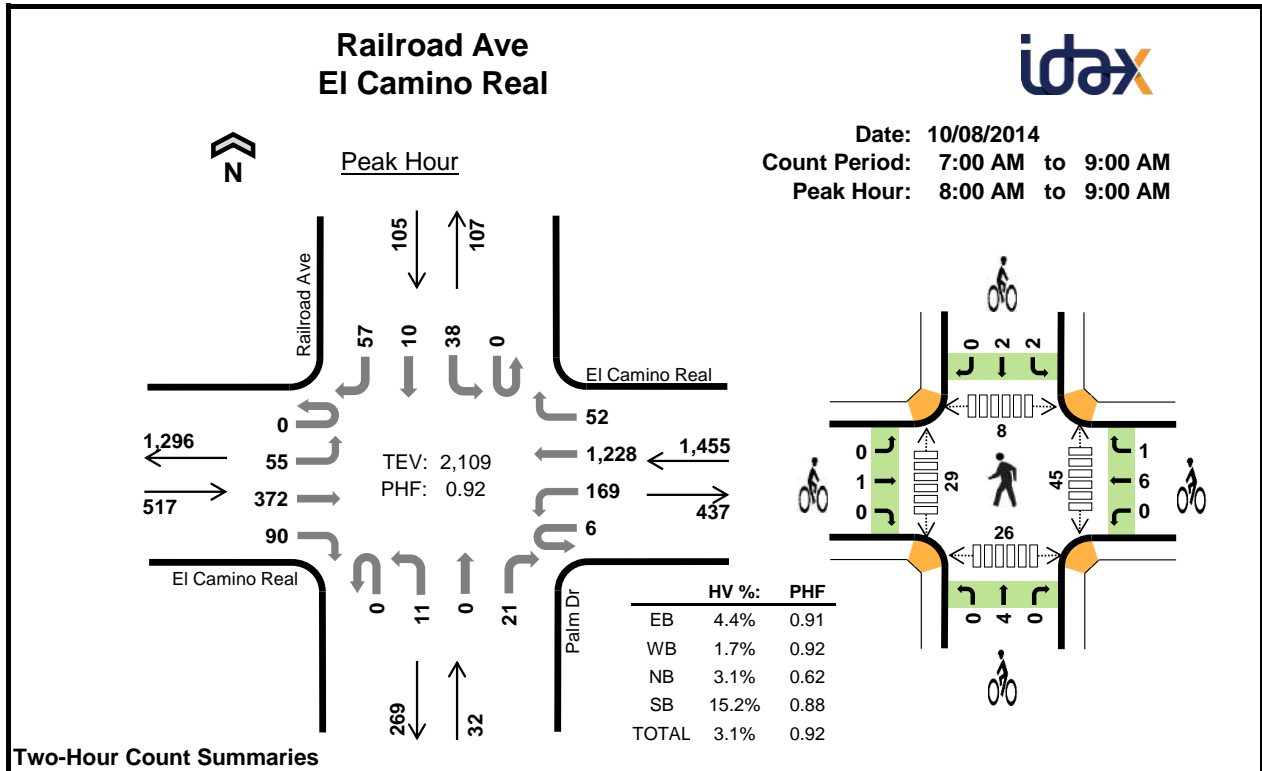

Two-Hour Count Summaries

Interval Start	El Camino Real Eastbound				El Camino Real Westbound				Palm Dr Northbound				Railroad Ave Southbound				15-min Total	Rolling One Hour	
	UT	LT	TH	RT	UT	LT	TH	RT	UT	LT	TH	RT	UT	LT	TH	RT			
7:00 AM	0	5	46	14	0	21	165	26	0	7	0	3	0	12	1	8	308	0	
7:15 AM	0	12	58	10	0	17	264	9	0	0	0	3	0	13	1	3	390	0	
7:30 AM	0	6	67	13	3	30	267	2	0	1	0	5	0	8	2	18	422	0	
7:45 AM	0	16	81	22	3	48	286	19	0	1	1	1	0	10	1	11	500	1,620	
8:00 AM	0	13	88	8	1	49	299	16	0	3	0	3	0	10	2	14	506	1,818	
8:15 AM	0	16	95	26	2	24	318	19	0	4	0	9	0	7	1	11	532	1,960	
8:30 AM	0	10	95	24	1	42	279	11	0	0	0	3	0	12	4	14	495	2,033	
8:45 AM	0	16	94	32	2	54	332	6	0	4	0	6	0	9	3	18	576	2,109	
Count Total	0	94	624	149	12	285	2210	108	0	20	1	33	0	81	15	97	3,729	0	
Peak Hour	All	0	55	372	90	6	169	1228	52	0	11	0	21	0	38	10	57	2,109	0
	HV	0	9	13	1	1	3	20	1	0	0	0	1	0	10	0	6	65	0
	HV%	-	16%	3%	1%	17%	2%	2%	2%	-	0%	-	5%	-	26%	0%	11%	3%	0

Note: Two-hour count summary volumes include heavy vehicles but exclude bicycles in overall count.

Interval Start	Heavy Vehicle Totals					Bicycles					Pedestrians (Crossing Leg)				
	EB	WB	NB	SB	Total	EB	WB	NB	SB	Total	East	West	North	South	Total
7:00 AM	2	3	0	3	8	0	2	0	2	4	3	7	1	4	15
7:15 AM	7	5	0	3	15	0	0	0	2	2	3	4	4	3	14
7:30 AM	1	6	0	5	12	1	0	0	3	4	7	5	5	1	18
7:45 AM	8	6	0	5	19	5	1	3	4	13	12	11	2	6	31
8:00 AM	2	5	0	4	11	0	0	1	1	2	9	8	2	11	30
8:15 AM	8	6	0	3	17	1	3	2	1	7	12	5	1	4	22
8:30 AM	5	9	0	4	18	0	3	1	2	6	17	10	4	6	37
8:45 AM	8	5	1	5	19	0	1	0	0	1	7	6	1	5	19
Count Total	41	45	1	32	119	7	10	7	15	39	70	56	20	40	186
Peak Hour	23	25	1	16	65	1	7	4	4	16	45	29	8	26	108

Two-Hour Count Summaries - Heavy Vehicles																		
Interval Start	El Camino Real				El Camino Real				Palm Dr				Railroad Ave				15-min Total	Rolling One Hour
	Eastbound				Westbound				Northbound				Southbound					
	UT	LT	TH	RT	UT	LT	TH	RT	UT	LT	TH	RT	UT	LT	TH	RT		
7:00 AM	0	0	2	0	0	0	3	0	0	0	0	0	0	1	0	2	8	0
7:15 AM	0	5	2	0	0	0	5	0	0	0	0	0	0	2	0	1	15	0
7:30 AM	0	0	1	0	0	0	6	0	0	0	0	0	0	2	0	3	12	0
7:45 AM	0	5	3	0	0	0	6	0	0	0	0	0	0	3	0	2	19	54
8:00 AM	0	1	1	0	0	2	3	0	0	0	0	0	0	3	0	1	11	57
8:15 AM	0	4	4	0	1	0	4	1	0	0	0	0	0	2	0	1	17	59
8:30 AM	0	1	4	0	0	1	8	0	0	0	0	0	0	3	0	1	18	65
8:45 AM	0	3	4	1	0	0	5	0	0	0	0	1	0	2	0	3	19	65
Count Total	0	19	21	1	1	3	40	1	0	0	0	1	0	18	0	14	119	0
Peak Hour	0	9	13	1	1	3	20	1	0	0	0	1	0	10	0	6	65	0
Two-Hour Count Summaries - Bikes																		
Interval Start	El Camino Real			El Camino Real			Palm Dr			Railroad Ave			15-min Total	Rolling One Hour				
	Eastbound			Westbound			Northbound			Southbound								
	LT	TH	RT	LT	TH	RT	LT	TH	RT	LT	TH	RT						
7:00 AM	0	0	0	0	2	0	0	0	0	0	2	0	4	0				
7:15 AM	0	0	0	0	0	0	0	0	0	2	0	0	2	0				
7:30 AM	0	1	0	0	0	0	0	0	0	0	2	1	4	0				
7:45 AM	0	5	0	1	0	0	0	3	0	0	3	1	13	23				
8:00 AM	0	0	0	0	0	0	0	1	0	1	0	0	2	21				
8:15 AM	0	1	0	0	2	1	0	2	0	0	1	0	7	26				
8:30 AM	0	0	0	0	3	0	0	1	0	1	1	0	6	28				
8:45 AM	0	0	0	0	1	0	0	0	0	0	0	0	1	16				
Count Total	0	7	0	1	8	1	0	7	0	4	9	2	39	0				
Peak Hour	0	1	0	0	6	1	0	4	0	2	2	0	16	0				
<i>Note: U-Turn volumes for bikes are included in Left-Turn, if any.</i>																		

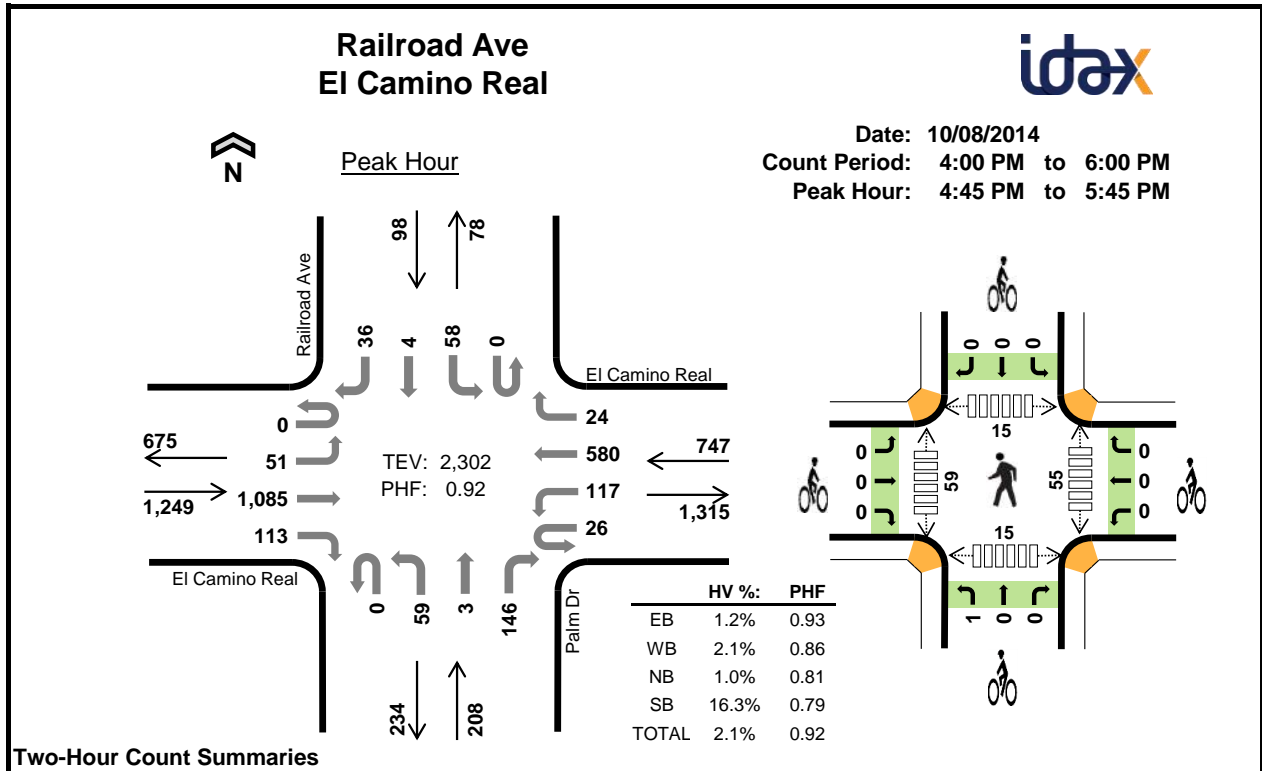

Two-Hour Count Summaries

Interval Start	El Camino Real Eastbound				El Camino Real Westbound				Palm Dr Northbound				Railroad Ave Southbound				15-min Total	Rolling One Hour	
	UT	LT	TH	RT	UT	LT	TH	RT	UT	LT	TH	RT	UT	LT	TH	RT			
4:00 PM	1	9	218	5	4	10	103	3	0	15	5	52	0	12	1	8	446	0	
4:15 PM	1	16	241	11	9	13	115	8	0	8	1	28	0	5	0	6	462	0	
4:30 PM	0	14	232	12	9	28	97	3	0	8	1	34	0	24	1	17	480	0	
4:45 PM	0	11	280	22	8	29	121	8	0	7	1	22	0	19	0	11	539	1,927	
5:00 PM	0	15	239	25	7	29	149	3	0	19	0	45	0	12	0	4	547	2,028	
5:15 PM	0	10	272	38	3	33	175	7	0	9	0	50	0	17	3	11	628	2,194	
5:30 PM	0	15	294	28	8	26	135	6	0	24	2	29	0	10	1	10	588	2,302	
5:45 PM	0	14	251	19	3	15	134	10	0	13	0	26	0	24	0	6	515	2,278	
Count Total	2	104	2027	160	51	183	1029	48	0	103	10	286	0	123	6	73	4,205	0	
Peak Hour	All	0	51	1085	113	26	117	580	24	0	59	3	146	0	58	4	36	2,302	0
	HV	0	10	4	1	1	0	14	0	0	0	0	2	0	9	0	7	48	0
	HV%	-	20%	0%	1%	4%	0%	2%	0%	-	0%	0%	1%	-	16%	0%	19%	2%	0

Note: Two-hour count summary volumes include heavy vehicles but exclude bicycles in overall count.

Interval Start	Heavy Vehicle Totals					Bicycles					Pedestrians (Crossing Leg)				
	EB	WB	NB	SB	Total	EB	WB	NB	SB	Total	East	West	North	South	Total
4:00 PM	4	4	0	5	13	0	0	0	0	0	18	8	2	2	30
4:15 PM	6	7	0	2	15	0	0	5	1	6	9	5	1	2	17
4:30 PM	6	3	1	4	14	0	1	5	0	6	20	14	5	6	45
4:45 PM	4	5	0	3	12	0	0	0	0	0	14	26	3	4	47
5:00 PM	4	3	1	4	12	0	0	0	0	0	24	17	2	4	47
5:15 PM	2	4	0	4	10	0	0	1	0	1	10	7	5	2	24
5:30 PM	5	3	1	5	14	0	0	0	0	0	7	9	5	5	26
5:45 PM	7	2	0	4	13	0	0	0	5	5	12	11	2	2	27
Count Total	38	31	3	31	103	0	1	11	6	18	114	97	25	27	263
Peak Hour	15	15	2	16	48	0	0	1	0	1	55	59	15	15	144

Two-Hour Count Summaries - Heavy Vehicles																		
Interval Start	El Camino Real				El Camino Real				Palm Dr				Railroad Ave				15-min Total	Rolling One Hour
	Eastbound				Westbound				Northbound				Southbound					
	UT	LT	TH	RT	UT	LT	TH	RT	UT	LT	TH	RT	UT	LT	TH	RT		
4:00 PM	0	2	2	0	0	0	4	0	0	0	0	0	0	3	0	2	13	0
4:15 PM	1	2	2	1	0	0	7	0	0	0	0	0	0	1	0	1	15	0
4:30 PM	0	4	2	0	0	0	3	0	0	1	0	0	0	1	1	2	14	0
4:45 PM	0	2	1	1	1	0	4	0	0	0	0	0	0	2	0	1	12	54
5:00 PM	0	4	0	0	0	0	3	0	0	0	0	1	0	2	0	2	12	53
5:15 PM	0	1	1	0	0	0	4	0	0	0	0	0	0	2	0	2	10	48
5:30 PM	0	3	2	0	0	0	3	0	0	0	0	1	0	3	0	2	14	48
5:45 PM	0	2	5	0	0	0	2	0	0	0	0	0	0	2	0	2	13	49
Count Total	1	20	15	2	1	0	30	0	0	1	0	2	0	16	1	14	103	0
Peak Hour	0	10	4	1	1	0	14	0	0	0	0	2	0	9	0	7	48	0

Two-Hour Count Summaries - Bikes														
Interval Start	El Camino Real			El Camino Real			Palm Dr			Railroad Ave			15-min Total	Rolling One Hour
	Eastbound			Westbound			Northbound			Southbound				
	LT	TH	RT	LT	TH	RT	LT	TH	RT	LT	TH	RT		
4:00 PM	0	0	0	0	0	0	0	0	0	0	0	0	0	0
4:15 PM	0	0	0	0	0	0	0	5	0	0	1	0	6	0
4:30 PM	0	0	0	0	1	0	0	5	0	0	0	0	6	0
4:45 PM	0	0	0	0	0	0	0	0	0	0	0	0	0	12
5:00 PM	0	0	0	0	0	0	0	0	0	0	0	0	0	12
5:15 PM	0	0	0	0	0	0	1	0	0	0	0	0	1	7
5:30 PM	0	0	0	0	0	0	0	0	0	0	0	0	0	1
5:45 PM	0	0	0	0	0	0	0	0	0	0	5	0	5	6
Count Total	0	0	0	0	1	0	1	10	0	0	6	0	18	0
Peak Hour	0	0	0	0	0	0	1	0	0	0	0	0	1	0

Note: U-Turn volumes for bikes are included in Left-Turn, if any.

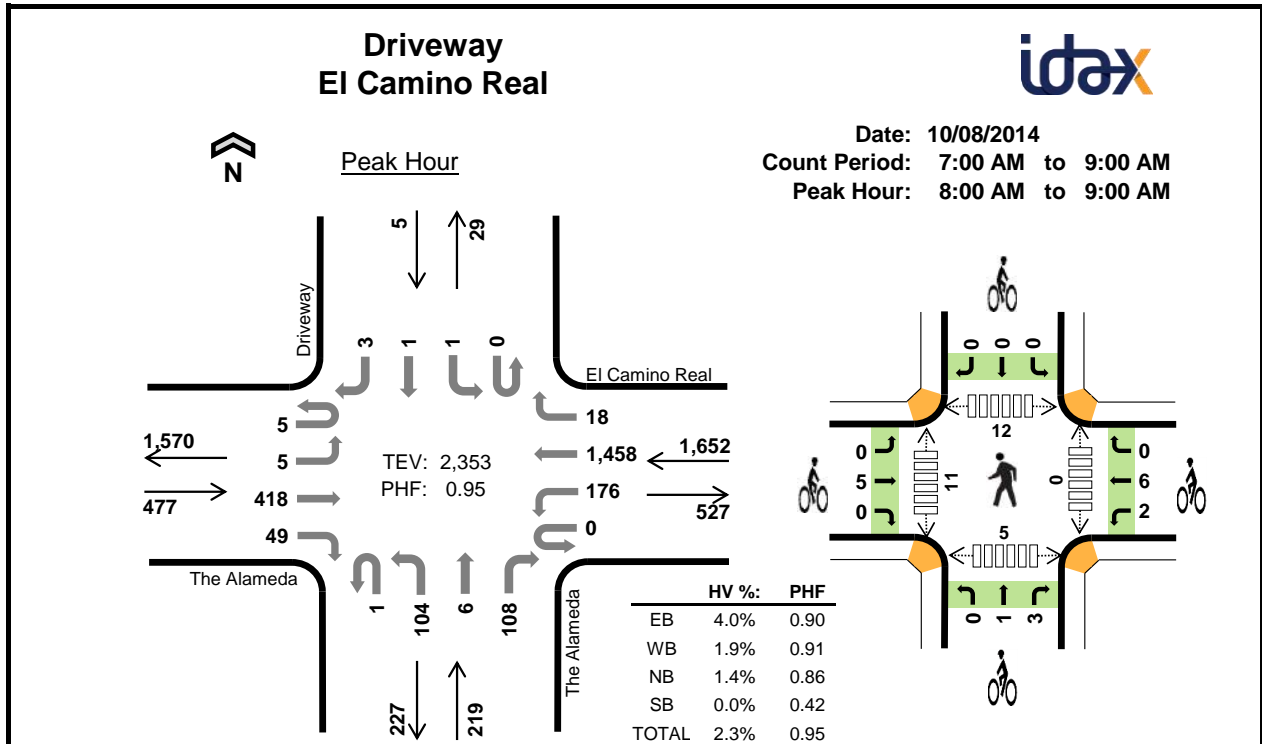

Two-Hour Count Summaries

Interval Start	The Alameda				EI Camino Real				The Alameda				Driveway				15-min Total	Rolling One Hour	
	Eastbound				Westbound				Northbound				Southbound						
	UT	LT	TH	RT	UT	LT	TH	RT	UT	LT	TH	RT	UT	LT	TH	RT			
7:00 AM	0	0	74	10	0	35	230	0	0	12	0	9	0	0	0	0	370	0	
7:15 AM	0	2	93	5	0	31	275	2	0	9	0	15	0	0	0	0	432	0	
7:30 AM	0	2	109	13	0	35	320	3	0	15	1	27	0	0	1	0	526	0	
7:45 AM	0	1	101	11	0	44	347	5	0	23	3	29	0	0	0	1	565	1,893	
8:00 AM	1	1	113	18	0	47	370	5	0	29	0	35	0	0	1	0	620	2,143	
8:15 AM	2	0	102	11	0	34	353	5	0	28	3	23	0	0	0	0	561	2,272	
8:30 AM	1	1	113	10	0	47	337	2	1	22	2	28	0	0	0	1	565	2,311	
8:45 AM	1	3	90	10	0	48	398	6	0	25	1	22	0	1	0	2	607	2,353	
Count Total	5	10	795	88	0	321	2630	28	1	163	10	188	0	1	2	4	4,246	0	
Peak Hour	All	5	5	418	49	0	176	1458	18	1	104	6	108	0	1	1	3	2,353	0
	HV	0	0	15	4	0	1	29	1	0	1	0	2	0	0	0	0	53	0
	HV%	0%	0%	4%	8%	-	1%	2%	6%	0%	1%	0%	2%	-	0%	0%	0%	2%	0

Note: Two-hour count summary volumes include heavy vehicles but exclude bicycles in overall count.

Interval Start	Heavy Vehicle Totals					Bicycles					Pedestrians (Crossing Leg)				
	EB	WB	NB	SB	Total	EB	WB	NB	SB	Total	East	West	North	South	Total
7:00 AM	4	4	0	0	8	0	1	0	0	1	0	0	0	0	0
7:15 AM	5	4	2	0	11	1	2	1	0	4	0	1	1	1	3
7:30 AM	2	8	0	0	10	2	0	2	0	4	0	4	3	1	8
7:45 AM	5	1	2	0	8	1	1	0	0	2	0	4	2	3	9
8:00 AM	3	7	2	0	12	1	1	0	0	2	0	0	1	0	1
8:15 AM	6	8	0	0	14	1	4	1	0	6	0	1	2	0	3
8:30 AM	5	9	1	0	15	2	2	0	0	4	0	7	6	3	16
8:45 AM	5	7	0	0	12	1	1	3	0	5	0	3	3	2	8
Count Total	35	48	7	0	90	9	12	7	0	28	0	20	18	10	48
Peak Hour	19	31	3	0	53	5	8	4	0	17	0	11	12	5	28

Two-Hour Count Summaries - Heavy Vehicles																		
Interval Start	The Alameda				El Camino Real				The Alameda				Driveway				15-min Total	Rolling One Hour
	Eastbound				Westbound				Northbound				Southbound					
	UT	LT	TH	RT	UT	LT	TH	RT	UT	LT	TH	RT	UT	LT	TH	RT		
7:00 AM	0	0	4	0	0	0	4	0	0	0	0	0	0	0	0	0	8	0
7:15 AM	0	0	5	0	0	1	3	0	0	0	0	2	0	0	0	0	11	0
7:30 AM	0	0	2	0	0	1	7	0	0	0	0	0	0	0	0	0	10	0
7:45 AM	0	0	5	0	0	0	1	0	0	1	0	1	0	0	0	0	8	37
8:00 AM	0	0	3	0	0	0	7	0	0	1	0	1	0	0	0	0	12	41
8:15 AM	0	0	4	2	0	1	7	0	0	0	0	0	0	0	0	0	14	44
8:30 AM	0	0	3	2	0	0	9	0	0	0	0	1	0	0	0	0	15	49
8:45 AM	0	0	5	0	0	0	6	1	0	0	0	0	0	0	0	0	12	53
Count Total	0	0	31	4	0	3	44	1	0	2	0	5	0	0	0	0	90	0
Peak Hour	0	0	15	4	0	1	29	1	0	1	0	2	0	0	0	0	53	0

Two-Hour Count Summaries - Bikes																
Interval Start	The Alameda			El Camino Real			The Alameda			Driveway			15-min Total	Rolling One Hour		
	Eastbound			Westbound			Northbound			Southbound						
	LT	TH	RT	LT	TH	RT	LT	TH	RT	LT	TH	RT				
7:00 AM	0	0	0	0	1	0	0	0	0	0	0	0	1	0		
7:15 AM	0	1	0	1	1	0	1	0	0	0	0	0	4	0		
7:30 AM	0	2	0	0	0	0	0	0	2	0	0	0	4	0		
7:45 AM	0	1	0	0	1	0	0	0	0	0	0	0	2	11		
8:00 AM	0	1	0	0	1	0	0	0	0	0	0	0	2	12		
8:15 AM	0	1	0	1	3	0	0	1	0	0	0	0	6	14		
8:30 AM	0	2	0	1	1	0	0	0	0	0	0	0	4	14		
8:45 AM	0	1	0	0	1	0	0	0	3	0	0	0	5	17		
Count Total	0	9	0	3	9	0	1	1	5	0	0	0	28	0		
Peak Hour	0	5	0	2	6	0	0	1	3	0	0	0	17	0		

Note: U-Turn volumes for bikes are included in Left-Turn, if any.

INTERSECTION TURNING MOVEMENT COUNT SUMMARY

CLIENT: KITTELSON ASSOCIATES
 PROJECT: 2014 SCVTA CMP MONITORING
 DATE: WEDNESDAY SEPTEMBER 17, 2014
 PERIOD: 4:00 PM TO 6:00 PM
 INTERSECTION: N/S EL CAMINO REAL
 E/W THE ALAMEDA
 CITY: SANTA CLARA

VEHICLES

15 MIN COUNTS														4:00 PM TO 6:00 PM													
PERIOD	1	2	3	4	5	6	7	8	9	10	11	12	TOTAL	1	2	3	4	5	6	7	8	9	10	11	12	TOTAL	
	SBRT	SBTH	SBLT	WBRT	WBTH	WBLT	NBRT	NBTH	NBLT	EBRT	EBTH	EBLT		SBRT	SBTH	SBLT	WBRT	WBTH	WBLT	NBRT	NBTH	NBLT	EBRT	EBTH	EBLT		
400-415	19	281	1	6	3	14	3	106	33	52	0	15	533	19	281	1	6	3	14	3	106	33	52	0	15	533	
415-430	26	254	1	1	0	4	1	110	43	67	2	10	519	26	254	1	1	0	4	1	110	43	67	2	10	519	
430-445	24	258	0	1	2	4	2	126	47	77	1	23	565	24	258	0	1	2	4	2	126	47	77	1	23	565	
445-500	31	291	1	1	2	5	6	152	76	67	1	34	667	31	291	1	1	2	5	6	152	76	67	1	34	667	
500-515	45	392	1	4	1	14	7	169	71	75	1	39	819	45	392	1	4	1	14	7	169	71	75	1	39	819	
515-530	35	338	5	2	3	7	5	162	43	61	0	24	685	35	338	5	2	3	7	5	162	43	61	0	24	685	
530-545	44	433	0	1	2	3	5	162	52	78	1	26	807	44	433	0	1	2	3	5	162	52	78	1	26	807	
545-600	40	343	0	1	2	4	2	136	44	56	0	28	656	40	343	0	1	2	4	2	136	44	56	0	28	656	
HOUR TOTALS																											
TIME	1	2	3	4	5	6	7	8	9	10	11	12	TOTAL	1	2	3	4	5	6	7	8	9	10	11	12	TOTAL	
	SBRT	SBTH	SBLT	WBRT	WBTH	WBLT	NBRT	NBTH	NBLT	EBRT	EBTH	EBLT		SBRT	SBTH	SBLT	WBRT	WBTH	WBLT	NBRT	NBTH	NBLT	EBRT	EBTH	EBLT		
400-500	100	1084	3	9	7	27	12	494	199	263	4	82	2284	100	1084	3	9	7	27	12	494	199	263	4	82	2284	
415-515	126	1195	3	7	5	27	16	557	237	286	5	106	2570	126	1195	3	7	5	27	16	557	237	286	5	106	2570	
430-530	135	1279	7	8	8	30	20	609	237	280	3	120	2736	135	1279	7	8	8	30	20	609	237	280	3	120	2736	
445-545	155	1454	7	8	8	29	23	645	242	281	3	123	2978	155	1454	7	8	8	29	23	645	242	281	3	123	2978	
500-600	164	1506	6	8	8	28	19	629	210	270	2	117	2967	164	1506	6	8	8	28	19	629	210	270	2	117	2967	

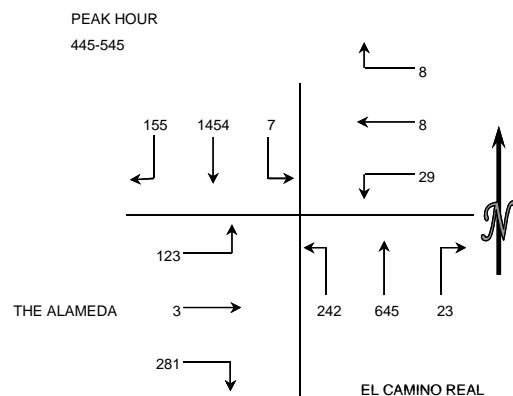

BICYCLES

15 MIN COUNTS														4:00 PM TO 6:00 PM													
PERIOD	1	2	3	4	5	6	7	8	9	10	11	12	TOTAL	1	2	3	4	5	6	7	8	9	10	11	12	TOTAL	
	SBRT	SBTH	SBLT	WBRT	WBTH	WBLT	NBRT	NBTH	NBLT	EBRT	EBTH	EBLT		SBRT	SBTH	SBLT	WBRT	WBTH	WBLT	NBRT	NBTH	NBLT	EBRT	EBTH	EBLT		
400-415	0	0	0	1	0	0	0	1	1	0	0	0	3	0	0	0	1	0	0	0	1	1	0	0	0	3	
415-430	0	0	0	0	0	0	0	3	0	0	0	0	3	0	0	0	0	0	0	0	3	0	0	0	0	3	
430-445	0	1	0	0	0	0	0	2	0	0	0	1	4	0	1	0	0	0	0	0	2	0	0	0	1	4	
445-500	0	3	0	0	0	0	0	4	0	0	1	0	8	0	3	0	0	0	0	0	4	0	0	1	0	8	
500-515	0	1	0	0	0	0	0	1	1	1	0	0	4	0	1	0	0	0	0	0	1	1	1	0	0	4	
515-530	1	1	0	0	0	0	0	1	0	0	0	0	3	1	1	0	0	0	0	0	1	0	0	0	0	3	
530-545	0	0	0	0	0	0	0	3	1	0	0	0	4	0	0	0	0	0	0	0	3	1	0	0	0	4	
545-600	1	0	0	0	0	0	0	2	0	0	0	0	3	1	0	0	0	0	0	0	2	0	0	0	0	3	
HOUR TOTALS																											
TIME	1	2	3	4	5	6	7	8	9	10	11	12	TOTAL	1	2	3	4	5	6	7	8	9	10	11	12	TOTAL	
	SBRT	SBTH	SBLT	WBRT	WBTH	WBLT	NBRT	NBTH	NBLT	EBRT	EBTH	EBLT		SBRT	SBTH	SBLT	WBRT	WBTH	WBLT	NBRT	NBTH	NBLT	EBRT	EBTH	EBLT		
400-500	0	4	0	1	0	0	0	10	1	0	1	1	18	0	4	0	1	0	0	0	10	1	0	1	1	18	
415-515	0	5	0	0	0	0	0	10	1	1	1	1	19	0	5	0	0	0	0	0	10	1	1	1	1	19	
430-530	1	6	0	0	0	0	0	8	1	1	1	1	19	1	6	0	0	0	0	0	8	1	1	1	1	19	
445-545	1	5	0	0	0	0	0	9	2	1	1	0	19	1	5	0	0	0	0	0	9	2	1	1	0	19	
500-600	2	2	0	0	0	0	0	7	2	1	0	0	14	2	2	0	0	0	0	0	7	2	1	0	0	14	

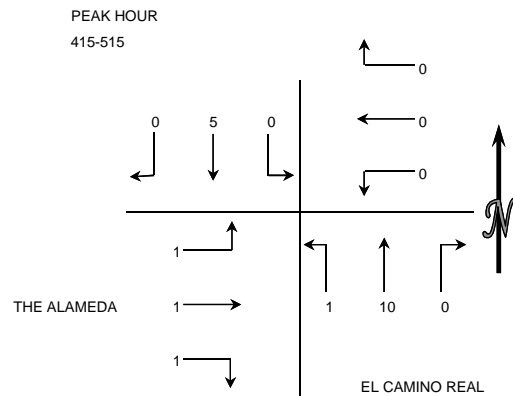

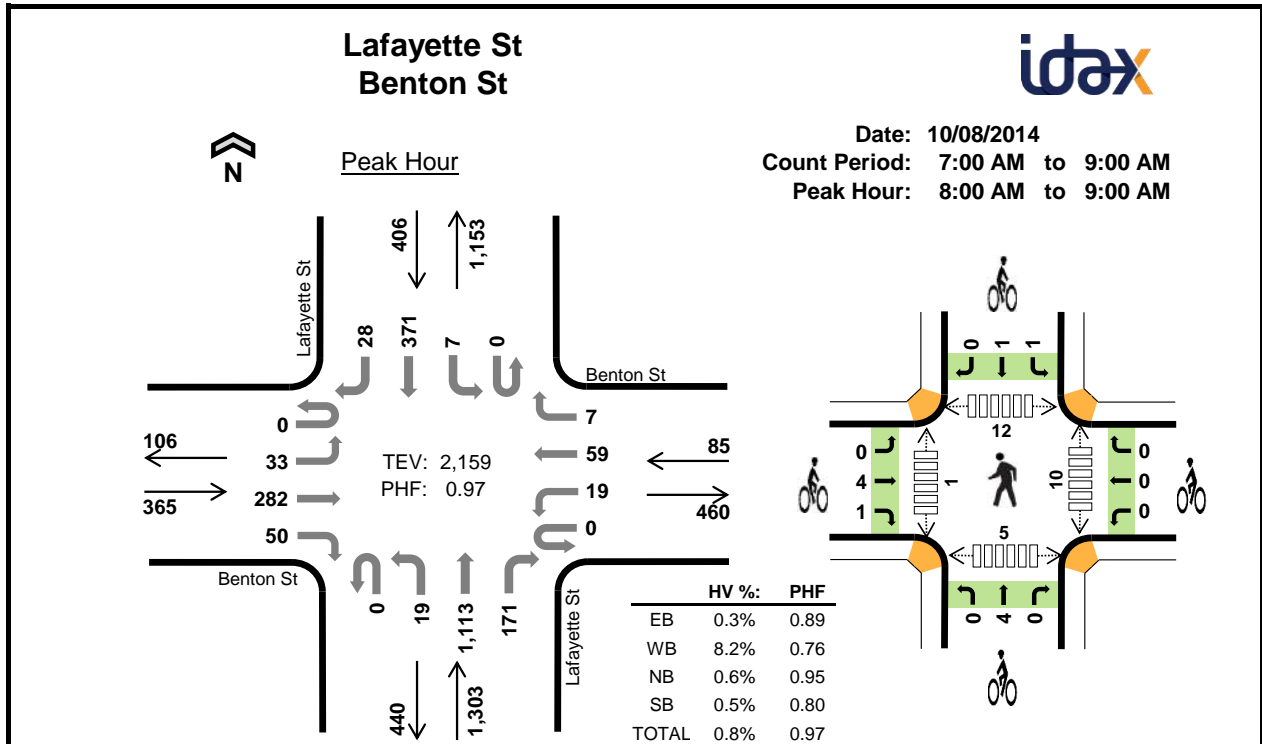

Two-Hour Count Summaries

Interval Start	Benton St Eastbound				Benton St Westbound				Lafayette St Northbound				Lafayette St Southbound				15-min Total	Rolling One Hour	
	UT	LT	TH	RT	UT	LT	TH	RT	UT	LT	TH	RT	UT	LT	TH	RT			
7:00 AM	0	5	34	5	0	4	16	0	0	2	127	8	0	4	54	1	260	0	
7:15 AM	0	5	37	0	0	5	19	2	0	5	185	20	0	1	83	3	365	0	
7:30 AM	0	3	44	9	0	4	19	0	0	4	226	33	0	2	76	6	426	0	
7:45 AM	0	11	68	12	0	6	22	0	0	3	278	41	0	1	104	5	551	1,602	
8:00 AM	0	8	58	15	0	3	15	1	0	3	279	43	0	2	111	4	542	1,884	
8:15 AM	0	3	75	14	0	7	9	3	0	4	270	43	0	1	119	7	555	2,074	
8:30 AM	0	14	82	7	0	2	16	1	0	7	267	44	0	1	61	3	505	2,153	
8:45 AM	0	8	67	14	0	7	19	2	0	5	297	41	0	3	80	14	557	2,159	
Count Total	0	57	465	76	0	38	135	9	0	33	1929	273	0	15	688	43	3,761	0	
Peak Hour	All	0	33	282	50	0	19	59	7	0	19	1113	171	0	7	371	28	2,159	0
	HV	0	1	0	0	0	0	7	0	0	0	8	0	0	2	0	0	18	0
	HV%	-	3%	0%	0%	-	0%	12%	0%	-	0%	1%	0%	-	29%	0%	0%	1%	0

Note: Two-hour count summary volumes include heavy vehicles but exclude bicycles in overall count.

Interval Start	Heavy Vehicle Totals					Bicycles					Pedestrians (Crossing Leg)				
	EB	WB	NB	SB	Total	EB	WB	NB	SB	Total	East	West	North	South	Total
7:00 AM	2	1	3	2	8	2	0	0	1	3	0	0	0	1	1
7:15 AM	3	5	2	7	17	0	1	1	0	2	0	0	0	1	1
7:30 AM	3	2	1	6	12	4	1	2	0	7	1	1	1	1	4
7:45 AM	2	5	2	5	14	0	1	0	0	1	2	3	0	6	11
8:00 AM	0	1	3	0	4	0	0	1	0	1	4	0	3	0	7
8:15 AM	0	3	2	0	5	3	0	3	1	7	4	1	2	0	7
8:30 AM	1	0	2	0	3	1	0	0	0	1	1	0	6	2	9
8:45 AM	0	3	1	2	6	1	0	0	1	2	1	0	1	3	5
Count Total	11	20	16	22	69	11	3	7	3	24	13	5	14	14	46
Peak Hour	1	7	8	2	18	5	0	4	2	11	10	1	12	5	28

Two-Hour Count Summaries - Heavy Vehicles																		
Interval Start	Benton St				Benton St				Lafayette St				Lafayette St				15-min Total	Rolling One Hour
	Eastbound				Westbound				Northbound				Southbound					
	UT	LT	TH	RT	UT	LT	TH	RT	UT	LT	TH	RT	UT	LT	TH	RT		
7:00 AM	0	0	2	0	0	0	1	0	0	0	3	0	0	1	1	0	8	0
7:15 AM	0	0	3	0	0	1	4	0	0	1	1	0	0	0	7	0	17	0
7:30 AM	0	1	1	1	0	0	2	0	0	0	1	0	0	1	4	1	12	0
7:45 AM	0	0	2	0	0	2	3	0	0	0	2	0	0	0	4	1	14	51
8:00 AM	0	0	0	0	0	0	1	0	0	0	3	0	0	0	0	0	4	47
8:15 AM	0	0	0	0	0	0	3	0	0	0	2	0	0	0	0	0	5	35
8:30 AM	0	1	0	0	0	0	0	0	0	0	2	0	0	0	0	0	3	26
8:45 AM	0	0	0	0	0	0	3	0	0	0	1	0	0	2	0	0	6	18
Count Total	0	2	8	1	0	3	17	0	0	1	15	0	0	4	16	2	69	0
Peak Hour	0	1	0	0	0	0	7	0	0	0	8	0	0	2	0	0	18	0
Two-Hour Count Summaries - Bikes																		
Interval Start	Benton St			Benton St			Lafayette St			Lafayette St			15-min Total	Rolling One Hour				
	Eastbound			Westbound			Northbound			Southbound								
	LT	TH	RT	LT	TH	RT	LT	TH	RT	LT	TH	RT						
7:00 AM	0	2	0	0	0	0	0	0	0	0	1	0	3	0				
7:15 AM	0	0	0	0	1	0	1	0	0	0	0	0	2	0				
7:30 AM	0	4	0	0	1	0	0	2	0	0	0	0	7	0				
7:45 AM	0	0	0	0	1	0	0	0	0	0	0	0	1	13				
8:00 AM	0	0	0	0	0	0	0	1	0	0	0	0	1	11				
8:15 AM	0	3	0	0	0	0	0	3	0	1	0	0	7	16				
8:30 AM	0	1	0	0	0	0	0	0	0	0	0	0	1	10				
8:45 AM	0	0	1	0	0	0	0	0	0	0	1	0	2	11				
Count Total	0	10	1	0	3	0	1	6	0	1	2	0	24	0				
Peak Hour	0	4	1	0	0	0	0	4	0	1	1	0	11	0				

Note: U-Turn volumes for bikes are included in Left-Turn, if any.

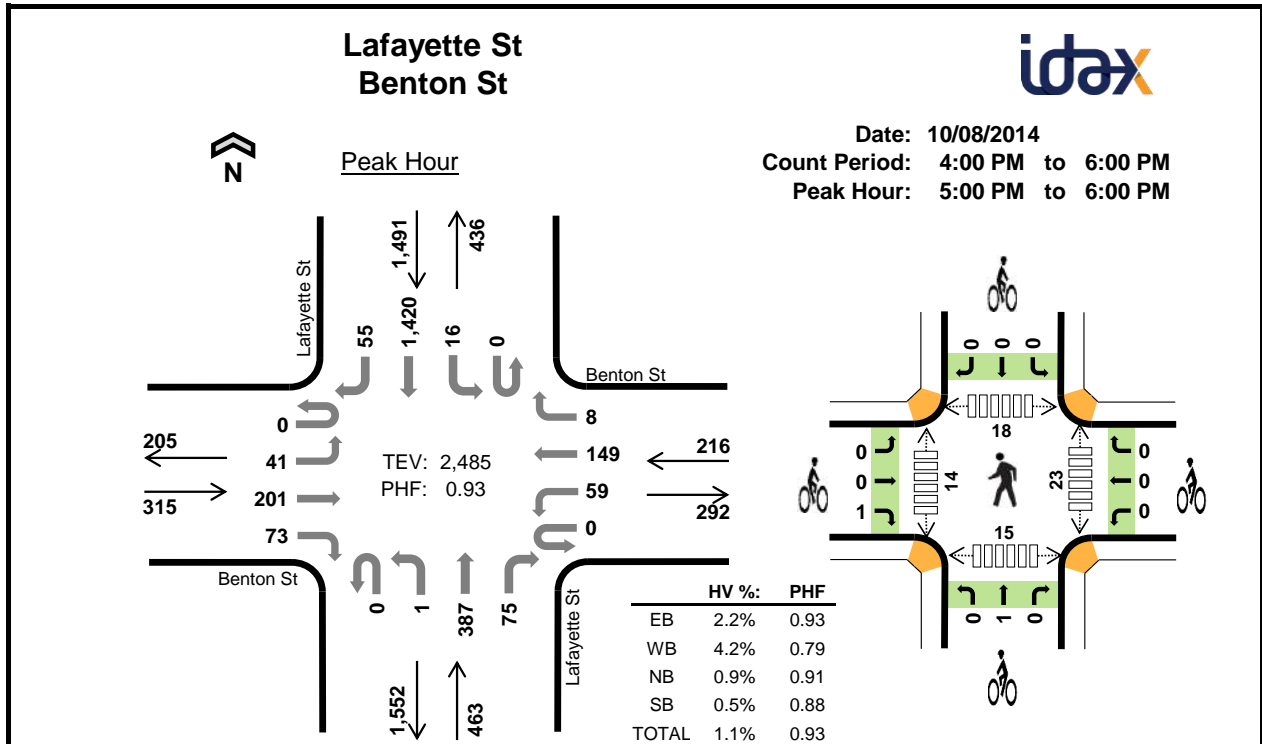

Two-Hour Count Summaries

Interval Start	Benton St Eastbound				Benton St Westbound				Lafayette St Northbound				Lafayette St Southbound				15-min Total	Rolling One Hour	
	UT	LT	TH	RT	UT	LT	TH	RT	UT	LT	TH	RT	UT	LT	TH	RT			
4:00 PM	0	5	30	12	0	7	30	1	0	0	77	15	0	4	222	11	414	0	
4:15 PM	0	4	44	17	0	10	20	1	0	0	80	19	0	3	255	12	465	0	
4:30 PM	0	10	35	16	0	14	28	1	0	0	80	9	0	7	272	20	492	0	
4:45 PM	0	6	45	16	0	12	30	3	0	0	87	26	0	6	297	20	548	1,919	
5:00 PM	0	8	56	16	0	9	52	3	0	0	95	18	0	5	325	16	603	2,108	
5:15 PM	0	12	47	17	0	12	29	2	0	1	98	18	0	7	348	12	603	2,246	
5:30 PM	0	9	61	15	0	22	43	3	0	0	86	20	0	2	339	14	614	2,368	
5:45 PM	0	12	37	25	0	16	25	0	0	0	108	19	0	2	408	13	665	2,485	
Count Total	0	66	355	134	0	102	257	14	0	1	711	144	0	36	2466	118	4,404	0	
Peak Hour	All	0	41	201	73	0	59	149	8	0	1	387	75	0	16	1420	55	2,485	0
	HV	0	0	7	0	0	2	7	0	0	0	4	0	0	0	7	0	27	0
	HV%	-	0%	3%	0%	-	3%	5%	0%	-	0%	1%	0%	-	0%	0%	0%	1%	0

Note: Two-hour count summary volumes include heavy vehicles but exclude bicycles in overall count.

Interval Start	Heavy Vehicle Totals					Bicycles					Pedestrians (Crossing Leg)				
	EB	WB	NB	SB	Total	EB	WB	NB	SB	Total	East	West	North	South	Total
4:00 PM	1	4	0	0	5	0	0	0	1	1	2	1	7	0	10
4:15 PM	2	2	2	1	7	0	0	0	1	1	1	4	1	1	7
4:30 PM	3	4	0	0	7	1	0	0	1	2	2	2	1	0	5
4:45 PM	3	3	1	1	8	4	3	0	2	9	3	1	2	2	8
5:00 PM	1	3	1	2	7	1	0	0	0	1	5	3	6	5	19
5:15 PM	3	1	0	2	6	0	0	0	0	0	3	6	1	3	13
5:30 PM	3	3	3	1	10	0	0	0	0	0	4	2	5	5	16
5:45 PM	0	2	0	2	4	0	0	1	0	1	11	3	6	2	22
Count Total	16	22	7	9	54	6	3	1	5	15	31	22	29	18	100
Peak Hour	7	9	4	7	27	1	0	1	0	2	23	14	18	15	70

Two-Hour Count Summaries - Heavy Vehicles																		
Interval Start	Benton St				Benton St				Lafayette St				Lafayette St				15-min Total	Rolling One Hour
	Eastbound				Westbound				Northbound				Southbound					
	UT	LT	TH	RT	UT	LT	TH	RT	UT	LT	TH	RT	UT	LT	TH	RT		
4:00 PM	0	0	1	0	0	0	4	0	0	0	0	0	0	0	0	0	5	0
4:15 PM	0	0	2	0	0	0	2	0	0	0	2	0	0	0	1	0	7	0
4:30 PM	0	0	3	0	0	2	2	0	0	0	0	0	0	0	0	0	7	0
4:45 PM	0	0	3	0	0	1	2	0	0	0	1	0	0	0	1	0	8	27
5:00 PM	0	0	1	0	0	0	3	0	0	0	1	0	0	0	2	0	7	29
5:15 PM	0	0	3	0	0	0	1	0	0	0	0	0	0	0	2	0	6	28
5:30 PM	0	0	3	0	0	1	2	0	0	0	3	0	0	0	1	0	10	31
5:45 PM	0	0	0	0	0	1	1	0	0	0	0	0	0	0	2	0	4	27
Count Total	0	0	16	0	0	5	17	0	0	0	7	0	0	0	9	0	54	0
Peak Hour	0	0	7	0	0	2	7	0	0	0	4	0	0	0	7	0	27	0
Two-Hour Count Summaries - Bikes																		
Interval Start	Benton St			Benton St			Lafayette St			Lafayette St			15-min Total	Rolling One Hour				
	Eastbound			Westbound			Northbound			Southbound								
	LT	TH	RT	LT	TH	RT	LT	TH	RT	LT	TH	RT						
4:00 PM	0	0	0	0	0	0	0	0	0	0	1	0	1	0				
4:15 PM	0	0	0	0	0	0	0	0	0	0	1	0	1	0				
4:30 PM	0	1	0	0	0	0	0	0	0	0	1	0	2	0				
4:45 PM	0	4	0	1	2	0	0	0	0	0	2	0	9	13				
5:00 PM	0	0	1	0	0	0	0	0	0	0	0	0	1	13				
5:15 PM	0	0	0	0	0	0	0	0	0	0	0	0	0	12				
5:30 PM	0	0	0	0	0	0	0	0	0	0	0	0	0	10				
5:45 PM	0	0	0	0	0	0	0	1	0	0	0	0	1	2				
Count Total	0	5	1	1	2	0	0	1	0	0	5	0	15	0				
Peak Hour	0	0	1	0	0	0	0	1	0	0	0	0	2	0				
<i>Note: U-Turn volumes for bikes are included in Left-Turn, if any.</i>																		

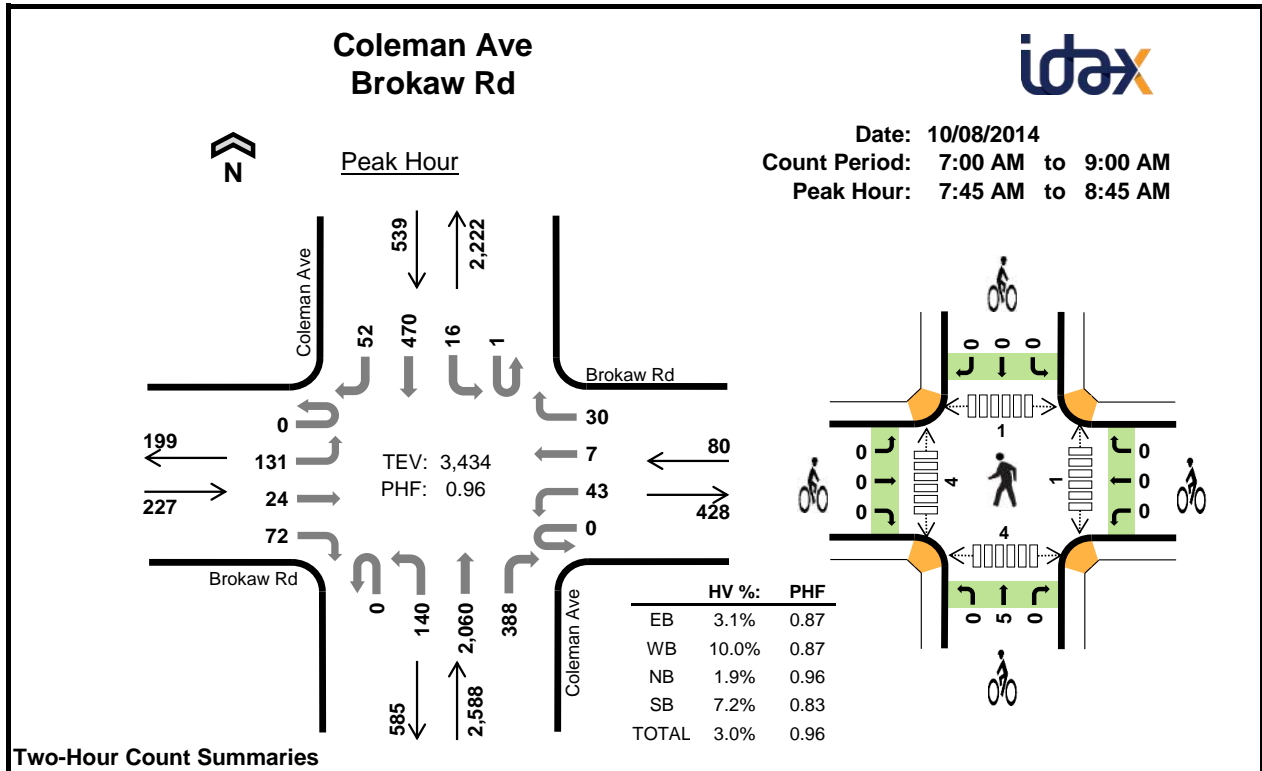

Two-Hour Count Summaries

Interval Start	Brokaw Rd Eastbound				Brokaw Rd Westbound				Coleman Ave Northbound			Coleman Ave Southbound				15-min Total	Rolling One Hour		
	UT	LT	TH	RT	UT	LT	TH	RT	UT	LT	TH	RT	UT	LT	TH			RT	
7:00 AM	0	30	2	12	0	4	0	1	0	43	426	57	0	2	83	2	662	0	
7:15 AM	0	31	5	9	0	2	1	3	0	30	468	75	0	4	90	4	722	0	
7:30 AM	0	25	2	12	0	8	0	3	0	30	518	74	0	4	102	7	785	0	
7:45 AM	0	32	8	21	0	10	1	6	0	38	542	97	0	3	104	18	880	3,049	
8:00 AM	0	27	6	15	0	6	1	14	0	30	501	109	1	6	106	11	833	3,220	
8:15 AM	0	31	7	15	0	12	4	3	0	45	501	84	0	4	115	9	830	3,328	
8:30 AM	0	41	3	21	0	15	1	7	0	27	516	98	0	3	145	14	891	3,434	
8:45 AM	0	28	8	16	0	9	1	8	0	37	491	84	2	3	110	15	812	3,366	
Count Total	0	245	41	121	0	66	9	45	0	280	3963	678	3	29	855	80	6,415	0	
Peak Hour	All	0	131	24	72	0	43	7	30	0	140	2060	388	1	16	470	52	3,434	0
	HV	0	4	0	3	0	7	1	0	0	4	43	1	0	0	36	3	102	0
	HV%	-	3%	0%	4%	-	16%	14%	0%	-	3%	2%	0%	0%	0%	8%	6%	3%	0

Note: Two-hour count summary volumes include heavy vehicles but exclude bicycles in overall count.

Interval Start	Heavy Vehicle Totals					Bicycles					Pedestrians (Crossing Leg)				
	EB	WB	NB	SB	Total	EB	WB	NB	SB	Total	East	West	North	South	Total
7:00 AM	2	2	7	5	16	0	0	1	0	1	0	0	0	0	0
7:15 AM	0	0	6	7	13	0	0	1	0	1	0	0	0	0	0
7:30 AM	1	0	15	9	25	0	0	0	0	0	0	0	0	0	0
7:45 AM	1	1	8	13	23	0	0	2	0	2	0	1	0	0	1
8:00 AM	1	1	9	7	18	0	0	0	0	0	1	0	0	2	3
8:15 AM	1	6	14	4	25	0	0	2	0	2	0	0	0	0	0
8:30 AM	4	0	17	15	36	0	0	1	0	1	0	3	1	2	6
8:45 AM	0	1	13	8	22	0	0	0	1	1	0	1	0	0	1
Count Total	10	11	89	68	178	0	0	7	1	8	1	5	1	4	11
Peak Hour	7	8	48	39	102	0	0	5	0	5	1	4	1	4	10

Two-Hour Count Summaries - Heavy Vehicles																		
Interval Start	Brokaw Rd				Brokaw Rd				Coleman Ave				Coleman Ave				15-min Total	Rolling One Hour
	Eastbound				Westbound				Northbound				Southbound					
	UT	LT	TH	RT	UT	LT	TH	RT	UT	LT	TH	RT	UT	LT	TH	RT		
7:00 AM	0	0	1	1	0	1	0	1	0	0	7	0	0	0	4	1	16	0
7:15 AM	0	0	0	0	0	0	0	0	0	0	6	0	0	0	7	0	13	0
7:30 AM	0	0	0	1	0	0	0	0	0	0	15	0	0	0	8	1	25	0
7:45 AM	0	1	0	0	0	1	0	0	0	0	8	0	0	0	13	0	23	77
8:00 AM	0	1	0	0	0	1	0	0	0	0	9	0	0	0	6	1	18	79
8:15 AM	0	0	0	1	0	5	1	0	0	2	11	1	0	0	4	0	25	91
8:30 AM	0	2	0	2	0	0	0	0	0	2	15	0	0	0	13	2	36	102
8:45 AM	0	0	0	0	0	1	0	0	0	0	12	1	0	0	7	1	22	101
Count Total	0	4	1	5	0	9	1	1	0	4	83	2	0	0	62	6	178	0
Peak Hour	0	4	0	3	0	7	1	0	0	4	43	1	0	0	36	3	102	0
Two-Hour Count Summaries - Bikes																		
Interval Start	Brokaw Rd			Brokaw Rd			Coleman Ave			Coleman Ave			15-min Total	Rolling One Hour				
	Eastbound			Westbound			Northbound			Southbound								
	LT	TH	RT	LT	TH	RT	LT	TH	RT	LT	TH	RT						
7:00 AM	0	0	0	0	0	0	0	1	0	0	0	0	1	0				
7:15 AM	0	0	0	0	0	0	0	1	0	0	0	0	1	0				
7:30 AM	0	0	0	0	0	0	0	0	0	0	0	0	0	0				
7:45 AM	0	0	0	0	0	0	0	2	0	0	0	0	2	4				
8:00 AM	0	0	0	0	0	0	0	0	0	0	0	0	0	3				
8:15 AM	0	0	0	0	0	0	0	2	0	0	0	0	2	4				
8:30 AM	0	0	0	0	0	0	0	1	0	0	0	0	1	5				
8:45 AM	0	0	0	0	0	0	0	0	0	0	1	0	1	4				
Count Total	0	0	0	0	0	0	0	7	0	0	1	0	8	0				
Peak Hour	0	0	0	0	0	0	0	5	0	0	0	0	5	0				
<i>Note: U-Turn volumes for bikes are included in Left-Turn, if any.</i>																		

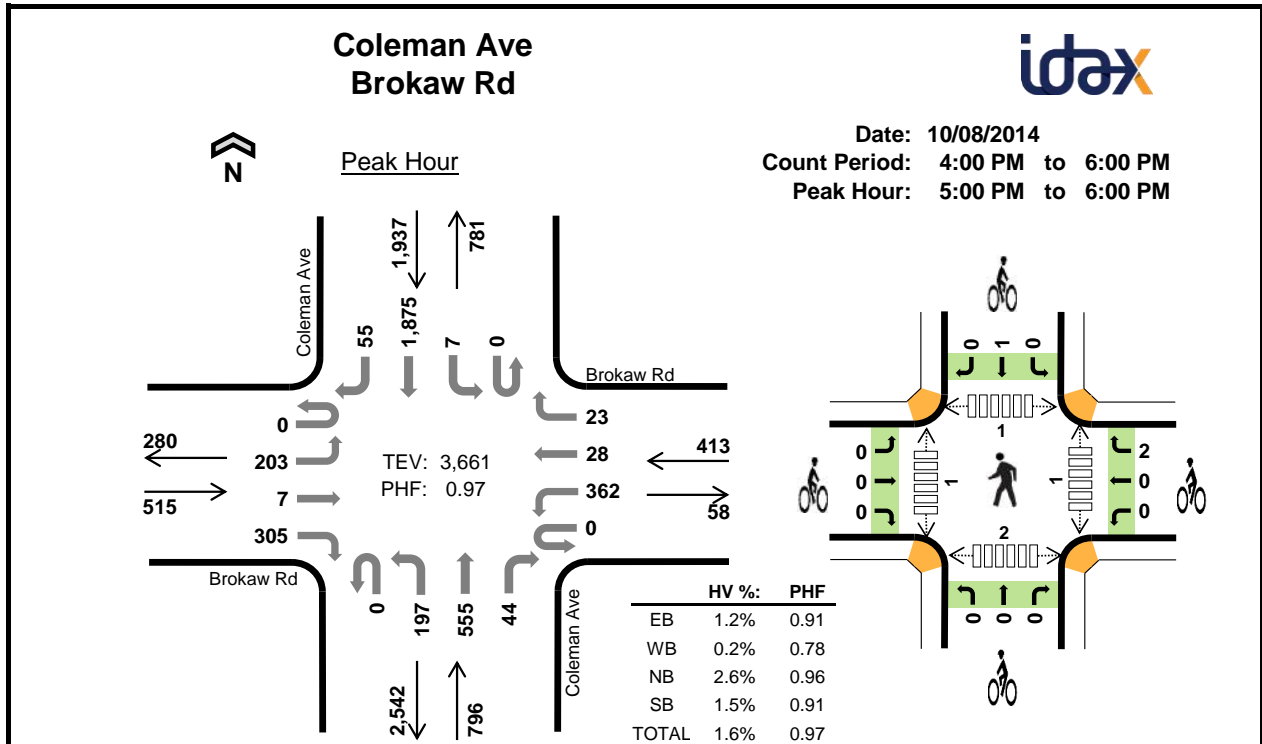

Two-Hour Count Summaries

Interval Start	Brokaw Rd Eastbound				Brokaw Rd Westbound				Coleman Ave Northbound				Coleman Ave Southbound				15-min Total	Rolling One Hour	
	UT	LT	TH	RT	UT	LT	TH	RT	UT	LT	TH	RT	UT	LT	TH	RT			
4:00 PM	0	65	3	70	0	72	4	7	1	47	145	12	0	3	457	9	895	0	
4:15 PM	0	44	4	69	0	54	6	8	0	56	97	10	0	3	438	12	801	0	
4:30 PM	0	48	5	76	0	62	4	10	0	41	119	13	0	6	449	10	843	0	
4:45 PM	0	52	4	89	0	73	5	6	0	63	94	15	0	7	430	14	852	3,391	
5:00 PM	0	48	3	57	0	75	2	2	0	65	130	12	0	1	514	15	924	3,420	
5:15 PM	0	55	1	86	0	107	8	8	0	48	148	8	0	3	430	15	917	3,536	
5:30 PM	0	45	1	77	0	112	13	8	0	27	138	12	0	2	431	14	880	3,573	
5:45 PM	0	55	2	85	0	68	5	5	0	57	139	12	0	1	500	11	940	3,661	
Count Total	0	412	23	609	0	623	47	54	1	404	1010	94	0	26	3649	100	7,052	0	
Peak Hour	All	0	203	7	305	0	362	28	23	0	197	555	44	0	7	1875	55	3,661	0
	HV	0	0	1	5	0	1	0	0	0	1	19	1	0	0	25	5	58	0
	HV%	-	0%	14%	2%	-	0%	0%	0%	-	1%	3%	2%	-	0%	1%	9%	2%	0

Note: Two-hour count summary volumes include heavy vehicles but exclude bicycles in overall count.

Interval Start	Heavy Vehicle Totals					Bicycles					Pedestrians (Crossing Leg)				
	EB	WB	NB	SB	Total	EB	WB	NB	SB	Total	East	West	North	South	Total
4:00 PM	3	3	11	8	25	0	1	0	3	4	2	3	1	0	6
4:15 PM	1	0	4	8	13	0	0	0	1	1	0	0	0	0	0
4:30 PM	7	3	3	15	28	0	0	0	0	0	3	0	0	0	3
4:45 PM	3	2	4	7	16	0	0	0	0	0	1	0	2	2	5
5:00 PM	1	1	7	10	19	0	0	0	0	0	0	1	0	0	1
5:15 PM	2	0	4	8	14	0	1	0	0	1	0	0	0	1	1
5:30 PM	1	0	8	5	14	0	0	0	0	0	0	0	0	0	0
5:45 PM	2	0	2	7	11	0	1	0	1	2	1	0	1	1	3
Count Total	20	9	43	68	140	0	3	0	5	8	7	4	4	4	19
Peak Hour	6	1	21	30	58	0	2	0	1	3	1	1	1	2	5

Two-Hour Count Summaries - Heavy Vehicles																			
Interval Start	Brokaw Rd				Brokaw Rd				Coleman Ave				Coleman Ave				15-min Total	Rolling One Hour	
	Eastbound				Westbound				Northbound				Southbound						
	UT	LT	TH	RT	UT	LT	TH	RT	UT	LT	TH	RT	UT	LT	TH	RT			
4:00 PM	0	2	0	1	0	3	0	0	0	1	10	0	0	0	6	2	25	0	
4:15 PM	0	0	0	1	0	0	0	0	0	0	1	3	0	0	0	6	2	13	0
4:30 PM	0	1	1	5	0	1	2	0	0	0	2	1	0	0	11	4	28	0	
4:45 PM	0	2	0	1	0	2	0	0	0	0	2	1	1	0	0	6	1	16	82
5:00 PM	0	0	0	1	0	1	0	0	0	0	0	7	0	0	0	6	4	19	76
5:15 PM	0	0	1	1	0	0	0	0	0	0	0	3	1	0	0	7	1	14	77
5:30 PM	0	0	0	1	0	0	0	0	0	0	1	7	0	0	0	5	0	14	63
5:45 PM	0	0	0	2	0	0	0	0	0	0	0	2	0	0	0	7	0	11	58
Count Total	0	5	2	13	0	7	2	0	0	5	35	3	0	0	54	14	140	0	
Peak Hour	0	0	1	5	0	1	0	0	0	1	19	1	0	0	25	5	58	0	
Two-Hour Count Summaries - Bikes																			
Interval Start	Brokaw Rd			Brokaw Rd			Coleman Ave			Coleman Ave			15-min Total	Rolling One Hour					
	Eastbound			Westbound			Northbound			Southbound									
	LT	TH	RT	LT	TH	RT	LT	TH	RT	LT	TH	RT							
4:00 PM	0	0	0	1	0	0	0	0	0	0	3	0	4	0					
4:15 PM	0	0	0	0	0	0	0	0	0	0	1	0	1	0					
4:30 PM	0	0	0	0	0	0	0	0	0	0	0	0	0	0					
4:45 PM	0	0	0	0	0	0	0	0	0	0	0	0	0	5					
5:00 PM	0	0	0	0	0	0	0	0	0	0	0	0	0	1					
5:15 PM	0	0	0	0	0	1	0	0	0	0	0	0	1	1					
5:30 PM	0	0	0	0	0	0	0	0	0	0	0	0	0	1					
5:45 PM	0	0	0	0	0	1	0	0	0	0	1	0	2	3					
Count Total	0	0	0	1	0	2	0	0	0	0	5	0	8	0					
Peak Hour	0	0	0	0	0	2	0	0	0	0	1	0	3	0					
<i>Note: U-Turn volumes for bikes are included in Left-Turn, if any.</i>																			

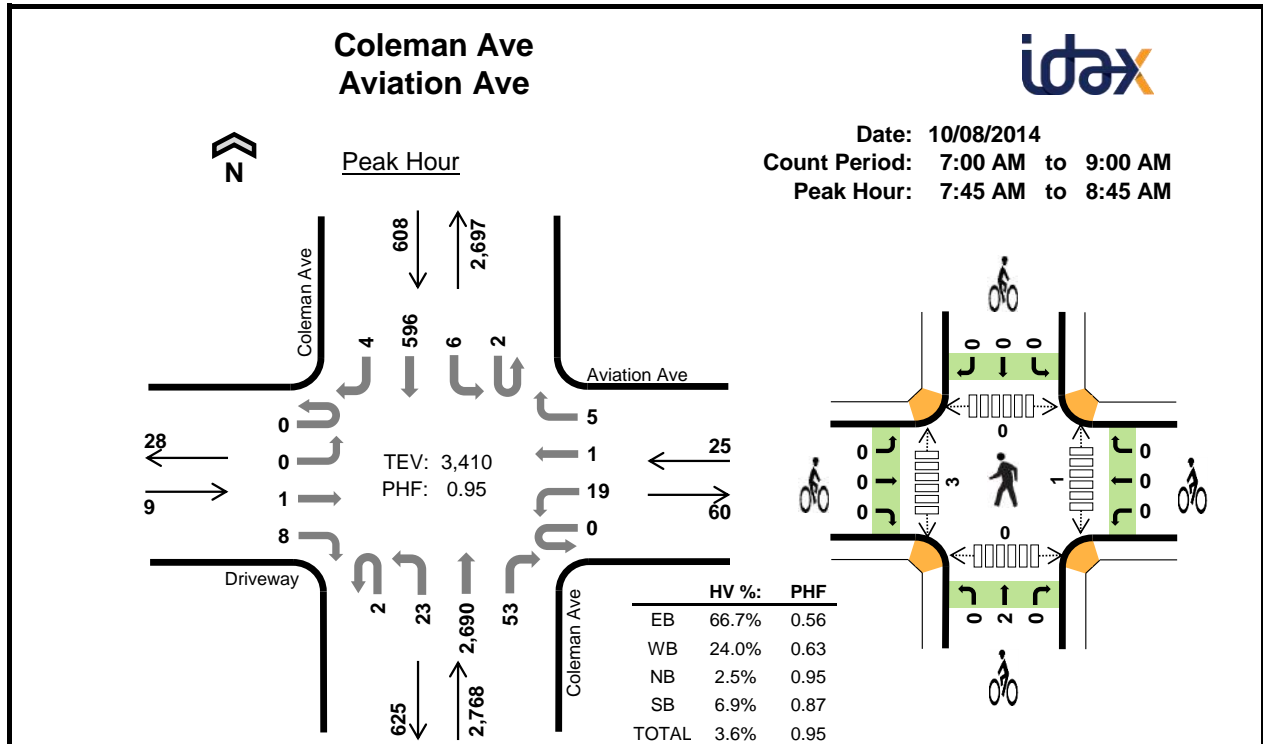

Two-Hour Count Summaries

Interval Start	Driveway				Aviation Ave				Coleman Ave				Coleman Ave				15-min Total	Rolling One Hour	
	Eastbound				Westbound				Northbound				Southbound						
	UT	LT	TH	RT	UT	LT	TH	RT	UT	LT	TH	RT	UT	LT	TH	RT			
7:00 AM	0	0	0	1	0	8	0	3	0	6	546	20	1	2	110	0	697	0	
7:15 AM	0	0	0	1	0	3	0	1	0	0	617	14	0	1	97	0	734	0	
7:30 AM	0	0	0	2	0	5	0	0	0	3	657	12	2	2	103	1	787	0	
7:45 AM	0	0	1	1	0	5	0	0	0	5	705	16	0	2	148	1	884	3,102	
8:00 AM	0	0	0	1	0	4	0	1	0	2	632	17	0	1	124	0	782	3,187	
8:15 AM	0	0	0	4	0	4	1	0	1	4	668	11	2	3	149	3	850	3,303	
8:30 AM	0	0	0	2	0	6	0	4	1	12	685	9	0	0	175	0	894	3,410	
8:45 AM	0	0	0	2	0	3	0	0	0	4	682	9	0	1	139	0	840	3,366	
Count Total	0	0	1	14	0	38	1	9	2	36	5192	108	5	12	1045	5	6,468	0	
Peak Hour	All	0	0	1	8	0	19	1	5	2	23	2690	53	2	6	596	4	3,410	0
	HV	0	0	0	6	0	6	0	0	1	6	55	6	0	0	42	0	122	0
	HV%	-	-	0%	75%	-	32%	0%	0%	50%	26%	2%	11%	0%	0%	7%	0%	4%	0

Note: Two-hour count summary volumes include heavy vehicles but exclude bicycles in overall count.

Interval Start	Heavy Vehicle Totals					Bicycles					Pedestrians (Crossing Leg)				
	EB	WB	NB	SB	Total	EB	WB	NB	SB	Total	East	West	North	South	Total
7:00 AM	1	2	15	8	26	0	0	0	1	1	0	0	0	0	0
7:15 AM	0	2	9	8	19	0	0	1	0	1	0	0	0	0	0
7:30 AM	2	2	16	11	31	0	0	0	0	0	1	0	0	0	1
7:45 AM	1	1	10	13	25	0	0	1	0	1	1	0	0	0	1
8:00 AM	1	2	17	4	24	0	0	0	0	0	0	1	0	0	1
8:15 AM	2	2	18	12	34	0	0	1	0	1	0	2	0	0	2
8:30 AM	2	1	23	13	39	0	0	0	0	0	0	0	0	0	0
8:45 AM	2	1	19	9	31	0	0	1	1	2	0	1	0	1	2
Count Total	11	13	127	78	229	0	0	4	2	6	2	4	0	1	7
Peak Hour	6	6	68	42	122	0	0	2	0	2	1	3	0	0	4

Two-Hour Count Summaries - Heavy Vehicles																		
Interval Start	Driveway				Aviation Ave				Coleman Ave				Coleman Ave				15-min Total	Rolling One Hour
	Eastbound				Westbound				Northbound				Southbound					
	UT	LT	TH	RT	UT	LT	TH	RT	UT	LT	TH	RT	UT	LT	TH	RT		
7:00 AM	0	0	0	1	0	2	0	0	0	2	8	5	0	0	8	0	26	0
7:15 AM	0	0	0	0	0	2	0	0	0	0	8	1	0	0	8	0	19	0
7:30 AM	0	0	0	2	0	2	0	0	0	2	13	1	0	0	10	1	31	0
7:45 AM	0	0	0	1	0	1	0	0	0	1	8	1	0	0	13	0	25	101
8:00 AM	0	0	0	1	0	2	0	0	0	1	14	2	0	0	4	0	24	99
8:15 AM	0	0	0	2	0	2	0	0	1	1	15	1	0	0	12	0	34	114
8:30 AM	0	0	0	2	0	1	0	0	0	3	18	2	0	0	13	0	39	122
8:45 AM	0	0	0	2	0	1	0	0	0	1	17	1	0	0	9	0	31	128
Count Total	0	0	0	11	0	13	0	0	1	11	101	14	0	0	77	1	229	0
Peak Hour	0	0	0	6	0	6	0	0	1	6	55	6	0	0	42	0	122	0

Two-Hour Count Summaries - Bikes																
Interval Start	Driveway			Aviation Ave			Coleman Ave			Coleman Ave			15-min Total	Rolling One Hour		
	Eastbound			Westbound			Northbound			Southbound						
	LT	TH	RT	LT	TH	RT	LT	TH	RT	LT	TH	RT				
7:00 AM	0	0	0	0	0	0	0	0	0	0	1	0	1	0		
7:15 AM	0	0	0	0	0	0	0	1	0	0	0	0	1	0		
7:30 AM	0	0	0	0	0	0	0	0	0	0	0	0	0	0		
7:45 AM	0	0	0	0	0	0	0	1	0	0	0	0	1	3		
8:00 AM	0	0	0	0	0	0	0	0	0	0	0	0	0	2		
8:15 AM	0	0	0	0	0	0	0	1	0	0	0	0	1	2		
8:30 AM	0	0	0	0	0	0	0	0	0	0	0	0	0	2		
8:45 AM	0	0	0	0	0	0	0	1	0	0	1	0	2	3		
Count Total	0	0	0	0	0	0	0	4	0	0	2	0	6	0		
Peak Hour	0	0	0	0	0	0	0	2	0	0	0	0	2	0		

Note: U-Turn volumes for bikes are included in Left-Turn, if any.

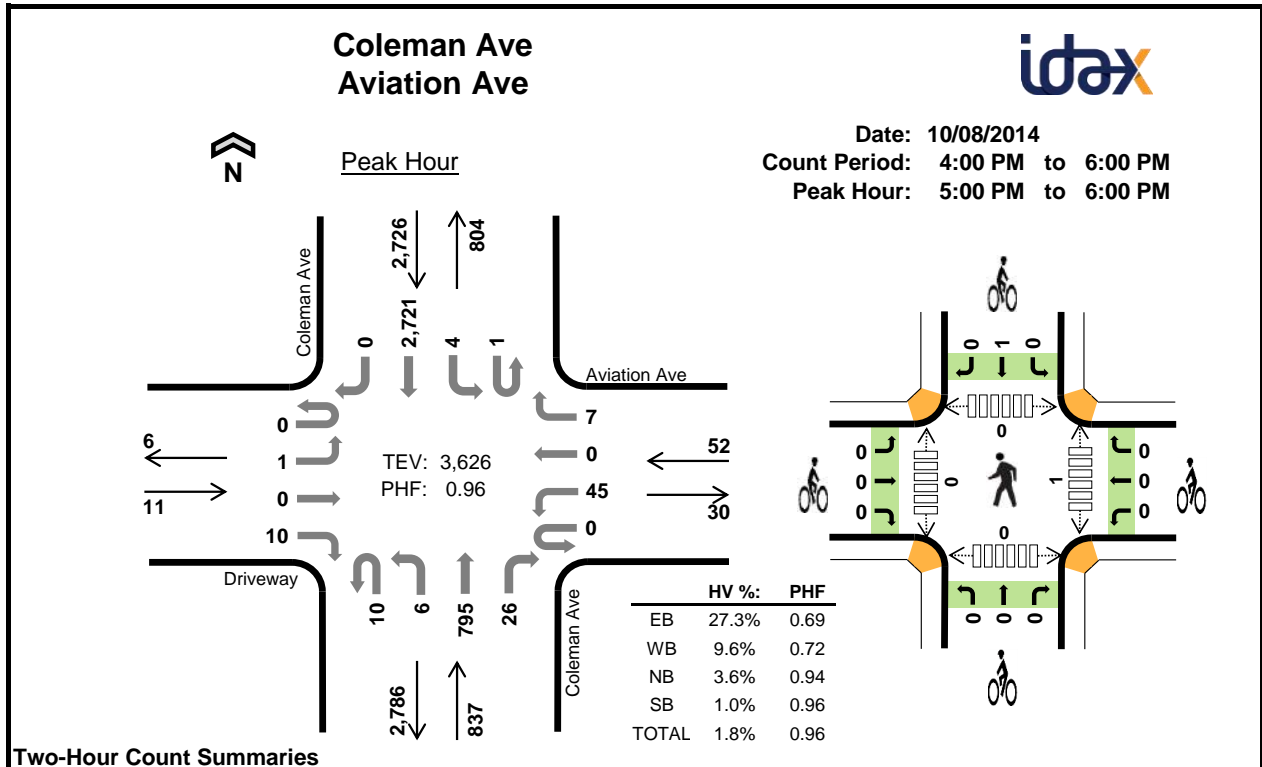

Two-Hour Count Summaries

Interval Start	Driveway				Aviation Ave				Coleman Ave				Coleman Ave				15-min Total	Rolling One Hour	
	Eastbound				Westbound				Northbound				Southbound						
	UT	LT	TH	RT	UT	LT	TH	RT	UT	LT	TH	RT	UT	LT	TH	RT			
4:00 PM	0	0	0	1	0	11	0	2	2	1	189	10	2	4	573	0	795	0	
4:15 PM	0	1	0	5	0	12	0	1	1	2	168	7	0	2	613	0	812	0	
4:30 PM	0	0	0	1	0	26	0	4	2	1	174	2	0	2	574	0	786	0	
4:45 PM	0	0	0	0	0	13	0	2	3	2	188	3	1	2	640	0	854	3,247	
5:00 PM	0	0	0	2	0	7	0	3	2	1	193	8	0	0	647	0	863	3,315	
5:15 PM	0	0	0	1	0	11	0	0	3	2	211	7	1	3	703	0	942	3,445	
5:30 PM	0	1	0	3	0	13	0	0	3	2	195	6	0	1	703	0	927	3,586	
5:45 PM	0	0	0	4	0	14	0	4	2	1	196	5	0	0	668	0	894	3,626	
Count Total	0	2	0	17	0	107	0	16	18	12	1514	48	4	14	5121	0	6,873	0	
Peak Hour	All	0	1	0	10	0	45	0	7	10	6	795	26	1	4	2721	0	3,626	0
	HV	0	0	0	3	0	5	0	0	0	3	21	6	0	0	26	0	64	0
	HV%	-	0%	-	30%	-	11%	-	0%	0%	50%	3%	23%	0%	0%	1%	-	2%	0

Note: Two-hour count summary volumes include heavy vehicles but exclude bicycles in overall count.

Interval Start	Heavy Vehicle Totals					Bicycles					Pedestrians (Crossing Leg)					
	EB	WB	NB	SB	Total	EB	WB	NB	SB	Total	East	West	North	South	Total	
4:00 PM	1	1	20	10	32	0	0	0	1	1	1	0	0	0	0	1
4:15 PM	1	1	7	8	17	0	0	0	0	0	0	0	0	0	0	0
4:30 PM	1	5	2	11	19	0	0	0	0	0	0	0	0	0	0	
4:45 PM	0	1	8	8	17	0	1	0	0	1	0	0	0	0	0	
5:00 PM	1	1	4	8	14	0	0	0	1	1	0	0	0	0	0	
5:15 PM	1	0	9	6	16	0	0	0	0	0	1	0	0	0	1	
5:30 PM	1	1	12	7	21	0	0	0	0	0	0	0	0	0	0	
5:45 PM	0	3	5	5	13	0	0	0	0	0	0	0	0	0	0	
Count Total	6	13	67	63	149	0	1	0	2	3	2	0	0	0	2	
Peak Hour	3	5	30	26	64	0	0	0	1	1	1	0	0	0	1	

Two-Hour Count Summaries - Heavy Vehicles																		
Interval Start	Driveway				Aviation Ave				Coleman Ave				Coleman Ave				15-min Total	Rolling One Hour
	Eastbound				Westbound				Northbound				Southbound					
	UT	LT	TH	RT	UT	LT	TH	RT	UT	LT	TH	RT	UT	LT	TH	RT		
4:00 PM	0	0	0	1	0	1	0	0	0	1	13	6	0	0	10	0	32	0
4:15 PM	0	0	0	1	0	1	0	0	0	1	5	1	0	0	8	0	17	0
4:30 PM	0	0	0	1	0	5	0	0	0	0	2	0	0	0	11	0	19	0
4:45 PM	0	0	0	0	0	1	0	0	0	1	6	1	0	0	8	0	17	85
5:00 PM	0	0	0	1	0	1	0	0	0	1	3	0	0	0	8	0	14	67
5:15 PM	0	0	0	1	0	0	0	0	0	1	7	1	0	0	6	0	16	66
5:30 PM	0	0	0	1	0	1	0	0	0	1	7	4	0	0	7	0	21	68
5:45 PM	0	0	0	0	0	3	0	0	0	0	4	1	0	0	5	0	13	64
Count Total	0	0	0	6	0	13	0	0	0	6	47	14	0	0	63	0	149	0
Peak Hour	0	0	0	3	0	5	0	0	0	3	21	6	0	0	26	0	64	0
Two-Hour Count Summaries - Bikes																		
Interval Start	Driveway			Aviation Ave			Coleman Ave			Coleman Ave			15-min Total	Rolling One Hour				
	Eastbound			Westbound			Northbound			Southbound								
	LT	TH	RT	LT	TH	RT	LT	TH	RT	LT	TH	RT						
4:00 PM	0	0	0	0	0	0	0	0	0	0	1	0	1	0				
4:15 PM	0	0	0	0	0	0	0	0	0	0	0	0	0	0				
4:30 PM	0	0	0	0	0	0	0	0	0	0	0	0	0	0				
4:45 PM	0	0	0	1	0	0	0	0	0	0	0	0	1	2				
5:00 PM	0	0	0	0	0	0	0	0	0	0	1	0	1	2				
5:15 PM	0	0	0	0	0	0	0	0	0	0	0	0	0	2				
5:30 PM	0	0	0	0	0	0	0	0	0	0	0	0	0	2				
5:45 PM	0	0	0	0	0	0	0	0	0	0	0	0	0	1				
Count Total	0	0	0	1	0	0	0	0	0	0	2	0	3	0				
Peak Hour	0	0	0	0	0	0	0	0	0	0	1	0	1	0				
<i>Note: U-Turn volumes for bikes are included in Left-Turn, if any.</i>																		

Coleman Ave Newhall Dr



Date: 10/08/2014
Count Period: 7:00 AM to 9:00 AM
Peak Hour: 7:45 AM to 8:45 AM

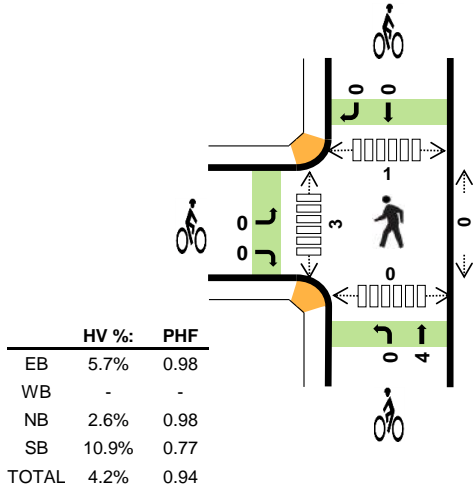
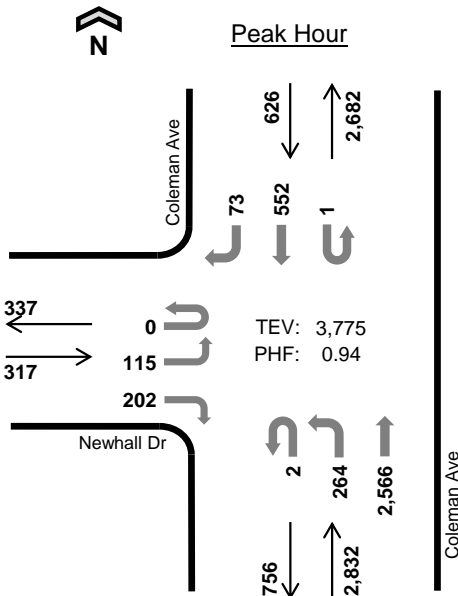

Two-Hour Count Summaries

Interval Start	Newhall Dr				0				Coleman Ave				Coleman Ave				15-min Total	Rolling One Hour	
	Eastbound				Westbound				Northbound				Southbound						
	UT	LT	TH	RT	UT	LT	TH	RT	UT	LT	TH	RT	UT	LT	TH	RT			
7:00 AM	0	26	0	41	0	0	0	0	0	76	537	0	0	0	98	15	793	0	
7:15 AM	1	32	0	45	0	0	0	0	2	61	568	0	0	0	94	17	820	0	
7:30 AM	0	29	0	54	0	0	0	0	2	45	663	0	0	0	94	16	903	0	
7:45 AM	0	32	0	47	0	0	0	0	1	68	653	0	0	0	120	18	939	3,455	
8:00 AM	0	28	0	49	0	0	0	0	1	63	608	0	0	0	122	19	890	3,552	
8:15 AM	0	28	0	53	0	0	0	0	0	69	652	0	0	0	128	16	946	3,678	
8:30 AM	0	27	0	53	0	0	0	0	0	64	653	0	1	0	182	20	1,000	3,775	
8:45 AM	0	21	0	49	0	0	0	0	0	80	638	0	1	0	120	16	925	3,761	
Count Total	1	223	0	391	0	0	0	0	6	526	4972	0	2	0	958	137	7,216	0	
Peak Hour	All	0	115	0	202	0	0	0	0	2	264	2566	0	1	0	552	73	3,775	0
	HV	0	8	0	10	0	0	0	0	0	13	61	0	0	0	64	4	160	0
	HV%	-	7%	-	5%	-	-	-	-	0%	5%	2%	-	0%	-	12%	5%	4%	0

Note: Two-hour count summary volumes include heavy vehicles but exclude bicycles in overall count.

Interval Start	Heavy Vehicle Totals					Bicycles					Pedestrians (Crossing Leg)				
	EB	WB	NB	SB	Total	EB	WB	NB	SB	Total	East	West	North	South	Total
7:00 AM	7	0	20	10	37	0	0	0	1	1	0	1	0	0	1
7:15 AM	6	0	15	10	31	0	0	1	0	1	0	0	0	0	0
7:30 AM	3	0	17	14	34	0	0	0	0	0	0	0	0	0	0
7:45 AM	3	0	15	16	34	0	0	3	0	3	0	0	0	0	0
8:00 AM	6	0	15	11	32	0	0	0	0	0	0	0	0	0	0
8:15 AM	6	0	21	18	45	0	0	1	0	1	0	3	0	0	3
8:30 AM	3	0	23	23	49	0	0	0	0	0	0	0	1	0	1
8:45 AM	4	0	23	15	42	0	0	0	0	0	0	0	0	0	0
Count Total	38	0	149	117	304	0	0	5	1	6	0	4	1	0	5
Peak Hr	18	0	74	68	160	0	0	4	0	4	0	3	1	0	4

Two-Hour Count Summaries - Heavy Vehicles																		
Interval Start	Newhall Dr				0				Coleman Ave				Coleman Ave				15-min Total	Rolling One Hour
	Eastbound				Westbound				Northbound				Southbound					
	UT	LT	TH	RT	UT	LT	TH	RT	UT	LT	TH	RT	UT	LT	TH	RT		
7:00 AM	0	1	0	6	0	0	0	0	0	4	16	0	0	0	10	0	37	0
7:15 AM	0	0	0	6	0	0	0	0	0	2	13	0	0	0	10	0	31	0
7:30 AM	0	0	0	3	0	0	0	0	0	2	15	0	0	0	12	2	34	0
7:45 AM	0	1	0	2	0	0	0	0	0	3	12	0	0	0	15	1	34	136
8:00 AM	0	4	0	2	0	0	0	0	0	4	11	0	0	0	10	1	32	131
8:15 AM	0	2	0	4	0	0	0	0	0	2	19	0	0	0	18	0	45	145
8:30 AM	0	1	0	2	0	0	0	0	0	4	19	0	0	0	21	2	49	160
8:45 AM	0	0	0	4	0	0	0	0	0	4	19	0	0	0	15	0	42	168
Count Total	0	9	0	29	0	0	0	0	0	25	124	0	0	0	111	6	304	0
Peak Hour	0	8	0	10	0	0	0	0	0	13	61	0	0	0	64	4	160	0
Two-Hour Count Summaries - Bikes																		
Interval Start	Newhall Dr			0			Coleman Ave			Coleman Ave			15-min Total	Rolling One Hour				
	Eastbound			Westbound			Northbound			Southbound								
	LT	TH	RT	LT	TH	RT	LT	TH	RT	LT	TH	RT						
7:00 AM	0	0	0	0	0	0	0	0	0	0	1	0	1	0				
7:15 AM	0	0	0	0	0	0	0	1	0	0	0	0	1	0				
7:30 AM	0	0	0	0	0	0	0	0	0	0	0	0	0	0				
7:45 AM	0	0	0	0	0	0	0	3	0	0	0	0	3	5				
8:00 AM	0	0	0	0	0	0	0	0	0	0	0	0	0	4				
8:15 AM	0	0	0	0	0	0	0	1	0	0	0	0	1	4				
8:30 AM	0	0	0	0	0	0	0	0	0	0	0	0	0	4				
8:45 AM	0	0	0	0	0	0	0	0	0	0	0	0	0	1				
Count Total	0	0	0	0	0	0	0	5	0	0	1	0	6	0				
Peak Hour	0	0	0	0	0	0	0	4	0	0	0	0	4	0				
<i>Note: U-Turn volumes for bikes are included in Left-Turn, if any.</i>																		

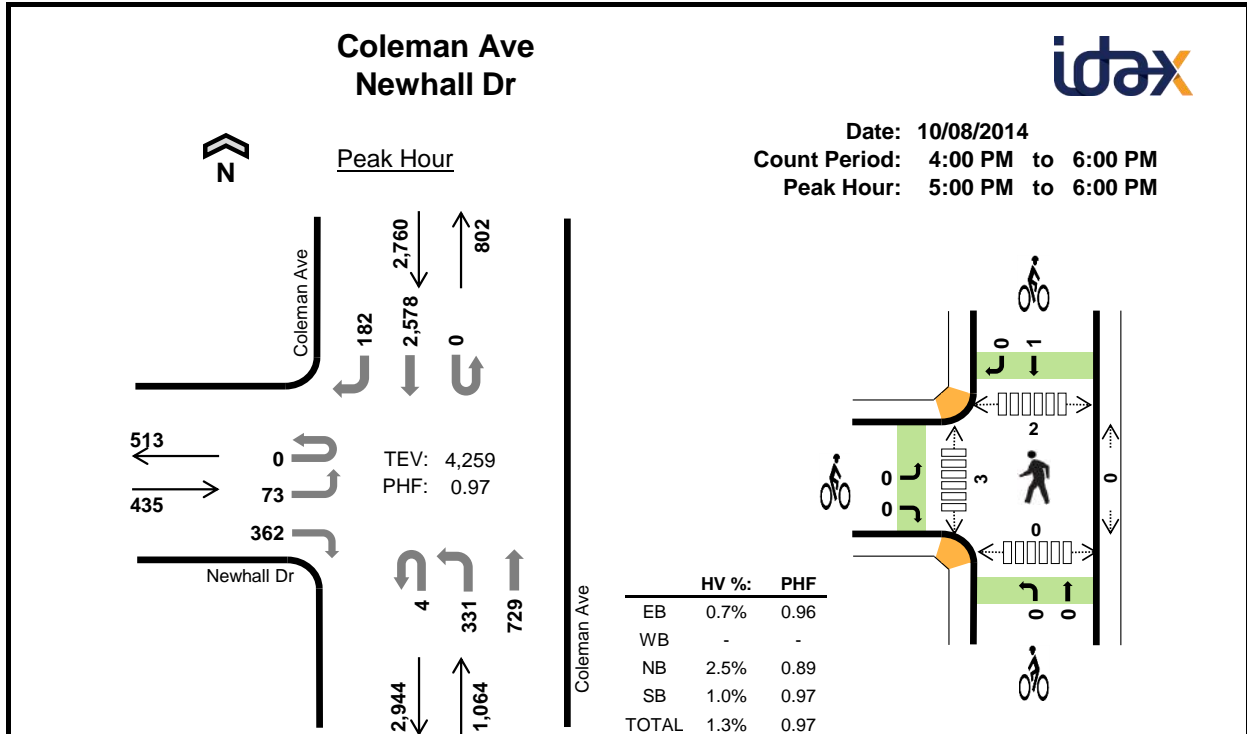

Two-Hour Count Summaries

Interval Start	Newhall Dr				0				Coleman Ave				Coleman Ave				15-min Total	Rolling One Hour	
	Eastbound				Westbound				Northbound				Southbound						
	UT	LT	TH	RT	UT	LT	TH	RT	UT	LT	TH	RT	UT	LT	TH	RT			
4:00 PM	0	16	0	81	0	0	0	0	1	60	175	0	0	0	549	52	934	0	
4:15 PM	0	20	0	75	0	0	0	0	1	74	140	0	0	0	573	42	925	0	
4:30 PM	0	20	0	99	0	0	0	0	0	71	136	0	0	0	597	37	960	0	
4:45 PM	0	14	0	83	0	0	0	0	0	67	165	0	0	0	558	34	921	3,740	
5:00 PM	0	14	0	95	0	0	0	0	0	94	177	0	0	0	622	38	1,040	3,846	
5:15 PM	0	15	0	98	0	0	0	0	1	93	206	0	0	0	637	47	1,097	4,018	
5:30 PM	0	20	0	85	0	0	0	0	2	77	179	0	0	0	664	51	1,078	4,136	
5:45 PM	0	24	0	84	0	0	0	0	1	67	167	0	0	0	655	46	1,044	4,259	
Count Total	0	143	0	700	0	0	0	0	6	603	1345	0	0	0	4855	347	7,999	0	
Peak Hour	All	0	73	0	362	0	0	0	0	4	331	729	0	0	0	2578	182	4,259	0
	HV	0	0	0	3	0	0	0	0	0	1	25	0	0	0	28	0	57	0
	HV%	-	0%	-	1%	-	-	-	-	0%	0%	3%	-	-	-	1%	0%	1%	0

Note: Two-hour count summary volumes include heavy vehicles but exclude bicycles in overall count.

Interval Start	Heavy Vehicle Totals					Bicycles					Pedestrians (Crossing Leg)				
	EB	WB	NB	SB	Total	EB	WB	NB	SB	Total	East	West	North	South	Total
4:00 PM	6	0	16	10	32	0	0	0	0	0	0	0	0	0	0
4:15 PM	2	0	6	5	13	0	0	0	2	2	0	1	0	0	1
4:30 PM	0	0	4	15	19	0	0	0	0	0	0	0	0	0	0
4:45 PM	0	0	8	6	14	0	0	0	1	1	0	0	0	0	0
5:00 PM	1	0	4	9	14	0	0	0	1	1	0	0	0	0	0
5:15 PM	0	0	7	6	13	0	0	0	0	0	0	1	1	0	2
5:30 PM	1	0	10	7	18	0	0	0	0	0	0	2	1	0	3
5:45 PM	1	0	5	6	12	0	0	0	0	0	0	0	0	0	0
Count Total	11	0	60	64	135	0	0	0	4	4	0	4	2	0	6
Peak Hr	3	0	26	28	57	0	0	0	1	1	0	3	2	0	5

Two-Hour Count Summaries - Heavy Vehicles																		
Interval Start	Newhall Dr				0				Coleman Ave				Coleman Ave				15-min Total	Rolling One Hour
	Eastbound				Westbound				Northbound				Southbound					
	UT	LT	TH	RT	UT	LT	TH	RT	UT	LT	TH	RT	UT	LT	TH	RT		
4:00 PM	0	2	0	4	0	0	0	0	0	1	15	0	0	0	7	3	32	0
4:15 PM	0	0	0	2	0	0	0	0	0	0	6	0	0	0	5	0	13	0
4:30 PM	0	0	0	0	0	0	0	0	0	0	4	0	0	0	14	1	19	0
4:45 PM	0	0	0	0	0	0	0	0	0	1	7	0	0	0	5	1	14	78
5:00 PM	0	0	0	1	0	0	0	0	0	0	4	0	0	0	9	0	14	60
5:15 PM	0	0	0	0	0	0	0	0	0	0	7	0	0	0	6	0	13	60
5:30 PM	0	0	0	1	0	0	0	0	0	1	9	0	0	0	7	0	18	59
5:45 PM	0	0	0	1	0	0	0	0	0	0	5	0	0	0	6	0	12	57
Count Total	0	2	0	9	0	0	0	0	0	3	57	0	0	0	59	5	135	0
Peak Hour	0	0	0	3	0	0	0	0	0	1	25	0	0	0	28	0	57	0
Two-Hour Count Summaries - Bikes																		
Interval Start	Newhall Dr			0			Coleman Ave			Coleman Ave			15-min Total	Rolling One Hour				
	Eastbound			Westbound			Northbound			Southbound								
	LT	TH	RT	LT	TH	RT	LT	TH	RT	LT	TH	RT						
4:00 PM	0	0	0	0	0	0	0	0	0	0	0	0	0	0				
4:15 PM	0	0	0	0	0	0	0	0	0	0	2	0	2	0				
4:30 PM	0	0	0	0	0	0	0	0	0	0	0	0	0	0				
4:45 PM	0	0	0	0	0	0	0	0	0	0	1	0	1	3				
5:00 PM	0	0	0	0	0	0	0	0	0	0	1	0	1	4				
5:15 PM	0	0	0	0	0	0	0	0	0	0	0	0	0	2				
5:30 PM	0	0	0	0	0	0	0	0	0	0	0	0	0	2				
5:45 PM	0	0	0	0	0	0	0	0	0	0	0	0	0	1				
Count Total	0	0	0	0	0	0	0	0	0	0	4	0	4	0				
Peak Hour	0	0	0	0	0	0	0	0	0	0	1	0	1	0				
<i>Note: U-Turn volumes for bikes are included in Left-Turn, if any.</i>																		

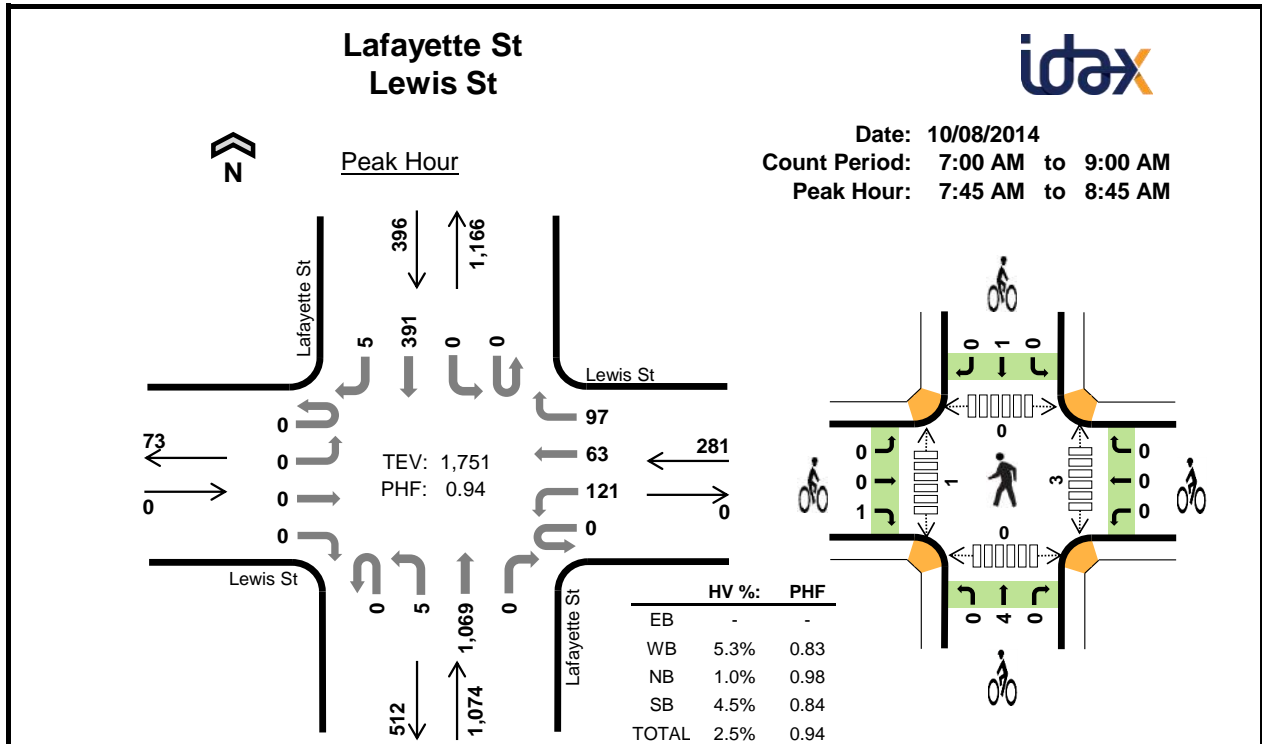

Two-Hour Count Summaries

Interval Start	Lewis St Eastbound				Lewis St Westbound				Lafayette St Northbound				Lafayette St Southbound				15-min Total	Rolling One Hour	
	UT	LT	TH	RT	UT	LT	TH	RT	UT	LT	TH	RT	UT	LT	TH	RT			
7:00 AM	0	0	0	0	0	16	9	21	0	0	139	0	0	0	62	1	248	0	
7:15 AM	0	0	0	0	0	16	11	21	0	0	170	0	0	0	93	0	311	0	
7:30 AM	0	0	0	0	0	22	15	14	0	1	220	0	0	0	84	1	357	0	
7:45 AM	0	0	0	0	0	40	21	24	0	1	273	0	0	0	106	0	465	1,381	
8:00 AM	0	0	0	0	0	29	10	20	0	3	262	0	0	0	105	2	431	1,564	
8:15 AM	0	0	0	0	0	38	16	25	0	1	267	0	0	0	117	1	465	1,718	
8:30 AM	0	0	0	0	0	14	16	28	0	0	267	0	0	0	63	2	390	1,751	
8:45 AM	0	0	0	0	0	40	22	20	0	3	278	0	0	0	97	2	462	1,748	
Count Total	0	0	0	0	0	215	120	173	0	9	1876	0	0	0	727	9	3,129	0	
Peak Hour	All	0	0	0	0	0	121	63	97	0	5	1069	0	0	0	391	5	1,751	0
	HV	0	0	0	0	0	1	6	8	0	0	11	0	0	0	18	0	44	0
	HV%	-	-	-	-	-	1%	10%	8%	-	0%	1%	-	-	-	5%	0%	3%	0

Note: Two-hour count summary volumes include heavy vehicles but exclude bicycles in overall count.

Interval Start	Heavy Vehicle Totals					Bicycles					Pedestrians (Crossing Leg)				
	EB	WB	NB	SB	Total	EB	WB	NB	SB	Total	East	West	North	South	Total
7:00 AM	0	3	3	2	8	0	0	0	0	0	0	0	0	0	0
7:15 AM	0	1	1	4	6	0	0	0	1	1	0	0	0	1	0
7:30 AM	0	3	2	4	9	0	0	2	0	2	1	0	0	0	1
7:45 AM	0	4	2	7	13	1	0	0	0	1	0	0	0	0	0
8:00 AM	0	2	4	4	10	0	0	1	0	1	2	0	0	0	2
8:15 AM	0	4	1	3	8	0	0	2	0	2	1	1	0	0	2
8:30 AM	0	5	4	4	13	0	0	1	1	2	0	0	0	0	0
8:45 AM	0	2	2	6	10	0	0	0	2	2	0	6	0	0	6
Count Total	0	24	19	34	77	1	0	6	4	11	4	7	1	0	12
Peak Hour	0	15	11	18	44	1	0	4	1	6	3	1	0	0	4

Two-Hour Count Summaries - Heavy Vehicles																		
Interval Start	Lewis St				Lewis St				Lafayette St				Lafayette St				15-min Total	Rolling One Hour
	Eastbound				Westbound				Northbound				Southbound					
	UT	LT	TH	RT	UT	LT	TH	RT	UT	LT	TH	RT	UT	LT	TH	RT		
7:00 AM	0	0	0	0	0	1	2	0	0	0	3	0	0	0	2	0	8	0
7:15 AM	0	0	0	0	0	1	0	0	0	0	1	0	0	0	4	0	6	0
7:30 AM	0	0	0	0	0	0	1	2	0	0	2	0	0	0	4	0	9	0
7:45 AM	0	0	0	0	0	0	3	1	0	0	2	0	0	0	7	0	13	36
8:00 AM	0	0	0	0	0	0	1	1	0	0	4	0	0	0	4	0	10	38
8:15 AM	0	0	0	0	0	1	1	2	0	0	1	0	0	0	3	0	8	40
8:30 AM	0	0	0	0	0	0	1	4	0	0	4	0	0	0	4	0	13	44
8:45 AM	0	0	0	0	0	0	0	2	0	0	2	0	0	0	5	1	10	41
Count Total	0	0	0	0	0	3	9	12	0	0	19	0	0	0	33	1	77	0
Peak Hour	0	0	0	0	0	1	6	8	0	0	11	0	0	0	18	0	44	0

Two-Hour Count Summaries - Bikes															
Interval Start	Lewis St			Lewis St			Lafayette St			Lafayette St			15-min Total	Rolling One Hour	
	Eastbound			Westbound			Northbound			Southbound					
	LT	TH	RT	LT	TH	RT	LT	TH	RT	LT	TH	RT			
7:00 AM	0	0	0	0	0	0	0	0	0	0	0	0	0	0	
7:15 AM	0	0	0	0	0	0	0	0	0	0	1	0	1	0	
7:30 AM	0	0	0	0	0	0	0	2	0	0	0	0	2	0	
7:45 AM	0	0	1	0	0	0	0	0	0	0	0	0	1	4	
8:00 AM	0	0	0	0	0	0	0	1	0	0	0	0	1	5	
8:15 AM	0	0	0	0	0	0	0	2	0	0	0	0	2	6	
8:30 AM	0	0	0	0	0	0	0	1	0	0	1	0	2	6	
8:45 AM	0	0	0	0	0	0	0	0	0	0	2	0	2	7	
Count Total	0	0	1	0	0	0	0	6	0	0	4	0	11	0	
Peak Hour	0	0	1	0	0	0	0	4	0	0	1	0	6	0	

Note: U-Turn volumes for bikes are included in Left-Turn, if any.

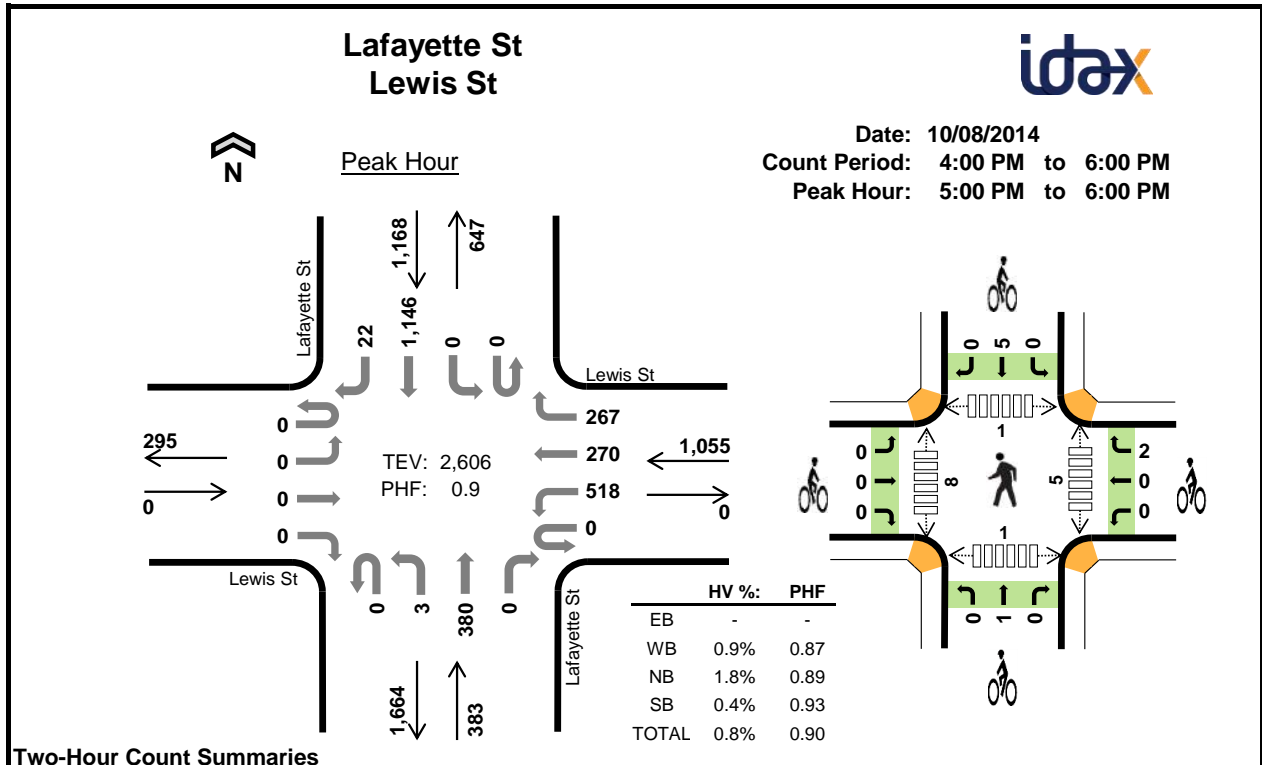

Two-Hour Count Summaries

Interval Start	Lewis St Eastbound				Lewis St Westbound				Lafayette St Northbound				Lafayette St Southbound				15-min Total	Rolling One Hour	
	UT	LT	TH	RT	UT	LT	TH	RT	UT	LT	TH	RT	UT	LT	TH	RT			
4:00 PM	0	0	0	0	0	50	31	27	0	1	72	0	0	0	219	6	406	0	
4:15 PM	0	0	0	0	0	65	38	34	0	0	67	0	0	0	233	2	439	0	
4:30 PM	0	0	0	0	0	90	40	38	0	1	92	0	0	0	268	2	531	0	
4:45 PM	0	0	0	0	0	95	36	49	0	2	75	0	0	0	245	3	505	1,881	
5:00 PM	0	0	0	0	0	115	51	52	0	1	92	0	0	0	290	4	605	2,080	
5:15 PM	0	0	0	0	0	127	65	74	0	0	91	0	0	0	263	2	622	2,263	
5:30 PM	0	0	0	0	0	129	68	71	0	0	91	0	0	0	285	11	655	2,387	
5:45 PM	0	0	0	0	0	147	86	70	0	2	106	0	0	0	308	5	724	2,606	
Count Total	0	0	0	0	0	818	415	415	0	7	686	0	0	0	2111	35	4,487	0	
Peak Hour	All	0	0	0	0	0	518	270	267	0	3	380	0	0	0	1146	22	2,606	0
	HV	0	0	0	0	0	1	2	6	0	0	7	0	0	0	5	0	21	0
	HV%	-	-	-	-	-	0%	1%	2%	-	0%	2%	-	-	-	0%	0%	1%	0

Note: Two-hour count summary volumes include heavy vehicles but exclude bicycles in overall count.

Interval Start	Heavy Vehicle Totals					Bicycles					Pedestrians (Crossing Leg)				
	EB	WB	NB	SB	Total	EB	WB	NB	SB	Total	East	West	North	South	Total
4:00 PM	0	3	0	1	4	0	0	0	1	1	0	2	1	2	5
4:15 PM	0	2	1	0	3	0	0	1	1	2	1	1	1	1	4
4:30 PM	0	1	3	1	5	0	2	1	1	4	1	2	1	1	5
4:45 PM	0	3	2	0	5	0	0	0	1	1	1	2	1	0	4
5:00 PM	0	3	2	1	6	0	0	0	1	1	0	1	0	0	1
5:15 PM	0	0	2	2	4	0	0	0	2	2	0	3	0	0	3
5:30 PM	0	3	3	0	6	0	0	1	2	3	1	1	1	0	3
5:45 PM	0	3	0	2	5	0	2	0	0	2	4	3	0	1	8
Count Total	0	18	13	7	38	0	4	3	9	16	8	15	5	5	33
Peak Hour	0	9	7	5	21	0	2	1	5	8	5	8	1	1	15

Two-Hour Count Summaries - Heavy Vehicles																		
Interval Start	Lewis St				Lewis St				Lafayette St				Lafayette St				15-min Total	Rolling One Hour
	Eastbound				Westbound				Northbound				Southbound					
	UT	LT	TH	RT	UT	LT	TH	RT	UT	LT	TH	RT	UT	LT	TH	RT		
4:00 PM	0	0	0	0	0	0	1	2	0	0	0	0	0	0	1	0	4	0
4:15 PM	0	0	0	0	0	0	0	2	0	0	1	0	0	0	0	0	3	0
4:30 PM	0	0	0	0	0	0	0	1	0	0	3	0	0	0	0	1	5	0
4:45 PM	0	0	0	0	0	1	0	2	0	0	2	0	0	0	0	0	5	17
5:00 PM	0	0	0	0	0	0	0	3	0	0	2	0	0	0	1	0	6	19
5:15 PM	0	0	0	0	0	0	0	0	0	0	2	0	0	0	2	0	4	20
5:30 PM	0	0	0	0	0	1	1	1	0	0	3	0	0	0	0	0	6	21
5:45 PM	0	0	0	0	0	0	1	2	0	0	0	0	0	0	2	0	5	21
Count Total	0	0	0	0	0	2	3	13	0	0	13	0	0	0	6	1	38	0
Peak Hour	0	0	0	0	0	1	2	6	0	0	7	0	0	0	5	0	21	0
Two-Hour Count Summaries - Bikes																		
Interval Start	Lewis St			Lewis St			Lafayette St			Lafayette St			15-min Total	Rolling One Hour				
	Eastbound			Westbound			Northbound			Southbound								
	LT	TH	RT	LT	TH	RT	LT	TH	RT	LT	TH	RT						
4:00 PM	0	0	0	0	0	0	0	0	0	0	1	0	1	0				
4:15 PM	0	0	0	0	0	0	0	0	1	0	0	1	0	2				
4:30 PM	0	0	0	0	0	2	0	1	0	0	1	0	4	0				
4:45 PM	0	0	0	0	0	0	0	0	0	0	0	1	0	1				
5:00 PM	0	0	0	0	0	0	0	0	0	0	0	1	0	1				
5:15 PM	0	0	0	0	0	0	0	0	0	0	0	2	0	2				
5:30 PM	0	0	0	0	0	0	0	1	0	0	2	0	3	7				
5:45 PM	0	0	0	0	0	2	0	0	0	0	0	0	2	8				
Count Total	0	0	0	0	0	4	0	3	0	0	9	0	16	0				
Peak Hour	0	0	0	0	0	2	0	1	0	0	5	0	8	0				
<i>Note: U-Turn volumes for bikes are included in Left-Turn, if any.</i>																		

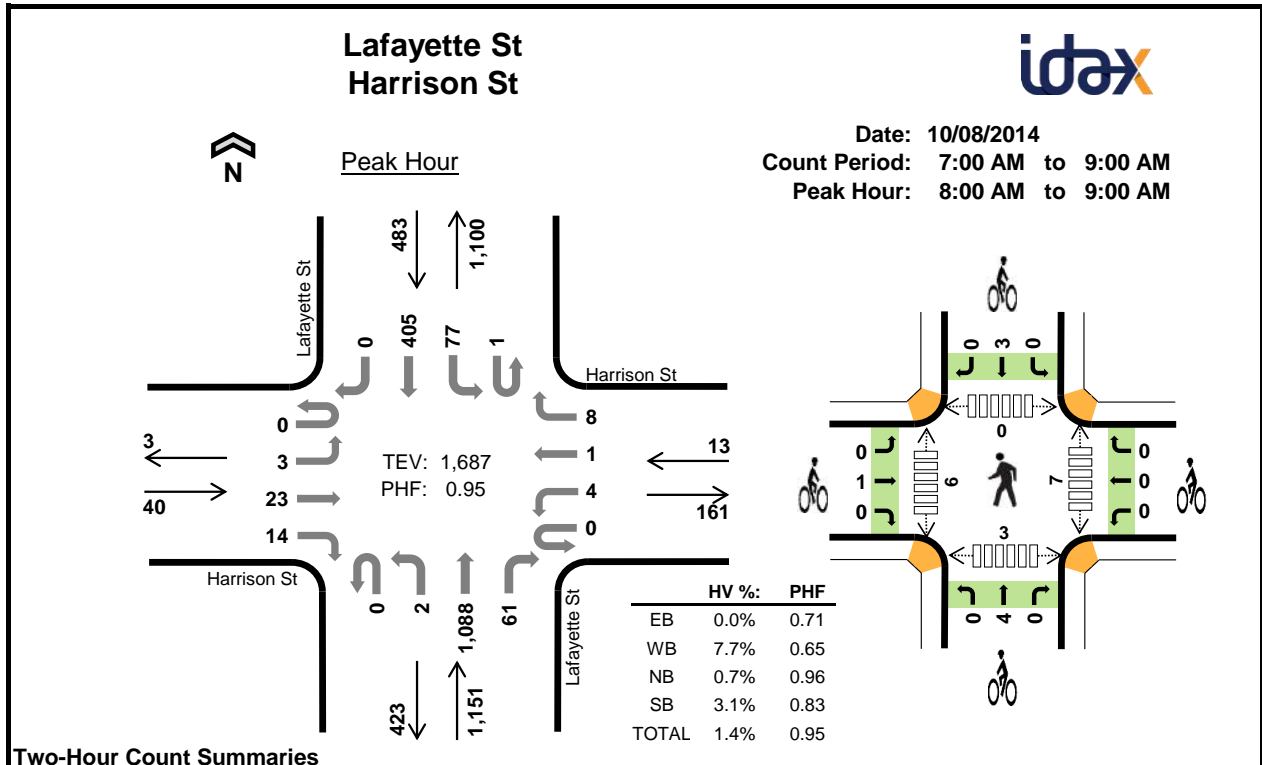

Two-Hour Count Summaries

Interval Start	Harrison St Eastbound				Harrison St Westbound				Lafayette St Northbound			Lafayette St Southbound				15-min Total	Rolling One Hour		
	UT	LT	TH	RT	UT	LT	TH	RT	UT	LT	TH	RT	UT	LT	TH			RT	
7:00 AM	0	1	6	2	0	2	0	0	0	0	130	5	0	19	58	0	223	0	
7:15 AM	0	0	12	1	0	1	1	0	0	1	168	10	0	17	82	1	294	0	
7:30 AM	0	2	8	2	0	0	0	2	0	2	241	6	0	13	81	0	357	0	
7:45 AM	0	0	9	2	0	0	2	1	0	0	283	10	0	15	114	0	436	1,310	
8:00 AM	0	2	6	1	0	2	0	0	0	0	264	13	0	19	115	0	422	1,509	
8:15 AM	0	0	4	3	0	0	1	2	0	1	269	16	0	18	128	0	442	1,657	
8:30 AM	0	1	6	7	0	1	0	2	0	1	268	18	1	19	59	0	383	1,683	
8:45 AM	0	0	7	3	0	1	0	4	0	0	287	14	0	21	103	0	440	1,687	
Count Total	0	6	58	21	0	7	4	11	0	5	1910	92	1	141	740	1	2,997	0	
Peak Hour	All	0	3	23	14	0	4	1	8	0	2	1088	61	1	77	405	0	1,687	0
	HV	0	0	0	0	0	0	0	1	0	0	7	1	0	0	15	0	24	0
	HV%	-	0%	0%	0%	-	0%	0%	13%	-	0%	1%	2%	0%	0%	4%	-	1%	0

Note: Two-hour count summary volumes include heavy vehicles but exclude bicycles in overall count.

Interval Start	Heavy Vehicle Totals					Bicycles					Pedestrians (Crossing Leg)				
	EB	WB	NB	SB	Total	EB	WB	NB	SB	Total	East	West	North	South	Total
7:00 AM	0	0	4	2	6	1	0	0	0	1	1	0	0	0	1
7:15 AM	0	0	1	6	7	0	0	0	0	0	0	0	0	0	0
7:30 AM	0	0	2	5	7	0	0	2	0	2	0	1	0	1	2
7:45 AM	0	0	1	3	4	0	0	0	0	0	0	0	0	1	1
8:00 AM	0	0	3	4	7	0	0	1	0	1	2	0	0	2	4
8:15 AM	0	0	2	4	6	0	0	1	1	2	3	2	0	0	5
8:30 AM	0	0	3	2	5	0	0	1	0	1	0	1	0	0	1
8:45 AM	0	1	0	5	6	1	0	1	2	4	2	3	0	1	6
Count Total	0	1	16	31	48	2	0	6	3	11	8	7	0	5	20
Peak Hour	0	1	8	15	24	1	0	4	3	8	7	6	0	3	16

Two-Hour Count Summaries - Heavy Vehicles																		
Interval Start	Harrison St				Harrison St				Lafayette St				Lafayette St				15-min Total	Rolling One Hour
	Eastbound				Westbound				Northbound				Southbound					
	UT	LT	TH	RT	UT	LT	TH	RT	UT	LT	TH	RT	UT	LT	TH	RT		
7:00 AM	0	0	0	0	0	0	0	0	0	0	4	0	0	0	2	0	6	0
7:15 AM	0	0	0	0	0	0	0	0	0	0	1	0	0	0	6	0	7	0
7:30 AM	0	0	0	0	0	0	0	0	0	0	2	0	0	0	5	0	7	0
7:45 AM	0	0	0	0	0	0	0	0	0	0	1	0	0	0	3	0	4	24
8:00 AM	0	0	0	0	0	0	0	0	0	0	3	0	0	0	4	0	7	25
8:15 AM	0	0	0	0	0	0	0	0	0	0	1	1	0	0	4	0	6	24
8:30 AM	0	0	0	0	0	0	0	0	0	0	3	0	0	0	2	0	5	22
8:45 AM	0	0	0	0	0	0	0	1	0	0	0	0	0	0	5	0	6	24
Count Total	0	0	0	0	0	0	0	1	0	0	15	1	0	0	31	0	48	0
Peak Hour	0	0	0	0	0	0	0	1	0	0	7	1	0	0	15	0	24	0
Two-Hour Count Summaries - Bikes																		
Interval Start	Harrison St			Harrison St			Lafayette St			Lafayette St			15-min Total	Rolling One Hour				
	Eastbound			Westbound			Northbound			Southbound								
	LT	TH	RT	LT	TH	RT	LT	TH	RT	LT	TH	RT						
7:00 AM	0	0	1	0	0	0	0	0	0	0	0	0	0	0	0	1	0	
7:15 AM	0	0	0	0	0	0	0	0	0	0	0	0	0	0	0	0	0	
7:30 AM	0	0	0	0	0	0	0	2	0	0	0	0	0	0	0	2	0	
7:45 AM	0	0	0	0	0	0	0	0	0	0	0	0	0	0	0	0	3	
8:00 AM	0	0	0	0	0	0	0	1	0	0	0	0	0	0	0	1	3	
8:15 AM	0	0	0	0	0	0	0	1	0	0	1	0	0	1	0	2	5	
8:30 AM	0	0	0	0	0	0	0	1	0	0	0	0	0	0	0	1	4	
8:45 AM	0	1	0	0	0	0	0	1	0	0	2	0	0	2	0	4	8	
Count Total	0	1	1	0	0	0	0	6	0	0	3	0	0	3	0	11	0	
Peak Hour	0	1	0	0	0	0	0	4	0	0	3	0	0	3	0	8	0	
<i>Note: U-Turn volumes for bikes are included in Left-Turn, if any.</i>																		

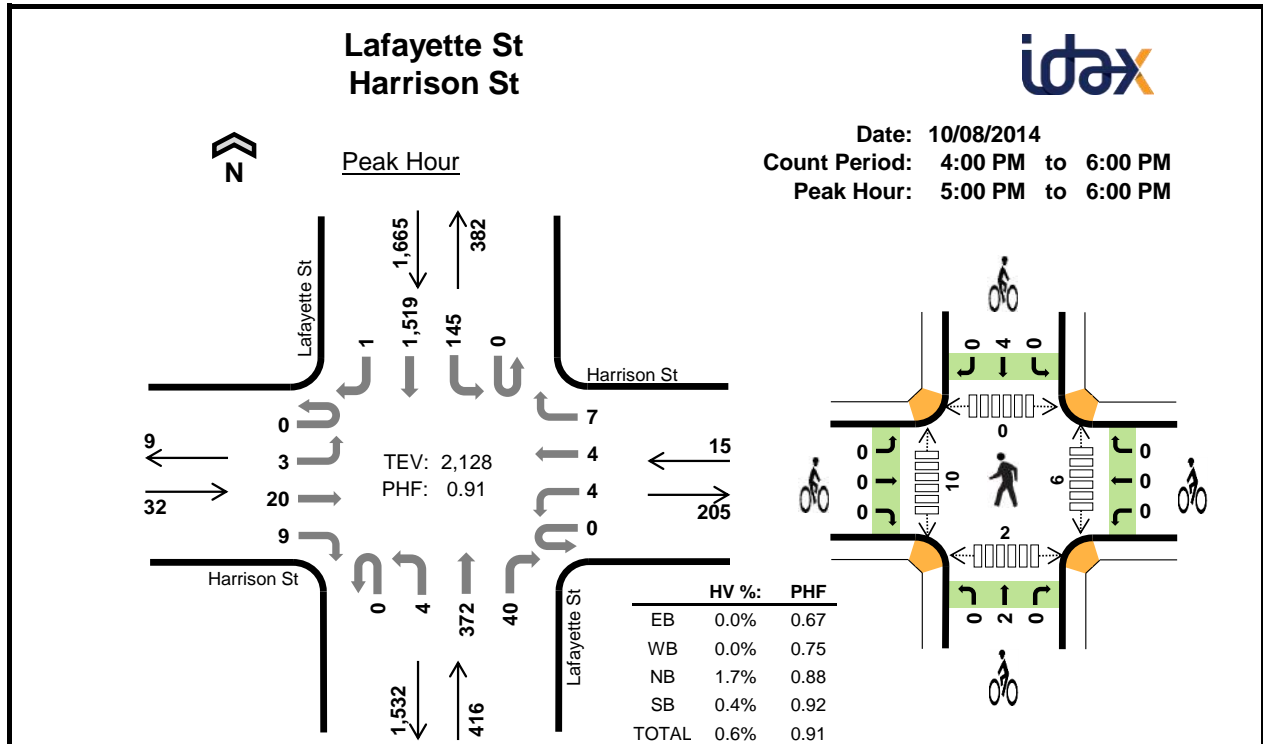

Two-Hour Count Summaries

Interval Start	Harrison St Eastbound				Harrison St Westbound				Lafayette St Northbound				Lafayette St Southbound				15-min Total	Rolling One Hour	
	UT	LT	TH	RT	UT	LT	TH	RT	UT	LT	TH	RT	UT	LT	TH	RT			
4:00 PM	0	0	5	1	0	1	2	0	0	0	72	6	0	35	232	2	356	0	
4:15 PM	0	0	5	1	0	0	3	0	0	1	68	7	0	33	261	2	381	0	
4:30 PM	0	0	7	3	0	2	1	0	0	0	90	5	0	32	318	1	459	0	
4:45 PM	0	1	5	5	0	1	1	0	0	0	75	6	0	32	303	1	430	1,626	
5:00 PM	0	0	4	0	0	0	1	2	0	0	90	13	0	40	368	0	518	1,788	
5:15 PM	0	2	8	2	0	3	0	1	0	1	89	8	0	29	357	0	500	1,907	
5:30 PM	0	1	2	3	0	1	3	1	0	1	89	7	0	40	378	1	527	1,975	
5:45 PM	0	0	6	4	0	0	0	3	0	2	104	12	0	36	416	0	583	2,128	
Count Total	0	4	42	19	0	8	11	7	0	5	677	64	0	277	2633	7	3,754	0	
Peak Hour	All	0	3	20	9	0	4	4	7	0	4	372	40	0	145	1519	1	2,128	0
	HV	0	0	0	0	0	0	0	0	0	0	7	0	0	0	6	0	13	0
	HV%	-	0%	0%	0%	-	0%	0%	0%	-	0%	2%	0%	-	0%	0%	0%	1%	0

Note: Two-hour count summary volumes include heavy vehicles but exclude bicycles in overall count.

Interval Start	Heavy Vehicle Totals					Bicycles					Pedestrians (Crossing Leg)				
	EB	WB	NB	SB	Total	EB	WB	NB	SB	Total	East	West	North	South	Total
4:00 PM	0	0	0	1	1	0	0	0	1	1	1	2	0	0	3
4:15 PM	0	0	1	1	2	0	0	0	1	1	0	2	0	0	2
4:30 PM	1	0	0	1	2	0	0	0	1	1	1	1	0	0	2
4:45 PM	0	0	1	1	2	0	0	0	2	2	1	4	0	0	5
5:00 PM	0	0	2	1	3	0	0	0	1	1	0	3	0	1	4
5:15 PM	0	0	2	2	4	0	0	0	2	2	0	4	0	0	4
5:30 PM	0	0	3	1	4	0	0	1	1	2	1	1	0	0	2
5:45 PM	0	0	0	2	2	0	0	1	0	1	5	2	0	1	8
Count Total	1	0	9	10	20	0	0	2	9	11	9	19	0	2	30
Peak Hour	0	0	7	6	13	0	0	2	4	6	6	10	0	2	18

Two-Hour Count Summaries - Heavy Vehicles																		
Interval Start	Harrison St				Harrison St				Lafayette St				Lafayette St				15-min Total	Rolling One Hour
	Eastbound				Westbound				Northbound				Southbound					
	UT	LT	TH	RT	UT	LT	TH	RT	UT	LT	TH	RT	UT	LT	TH	RT		
4:00 PM	0	0	0	0	0	0	0	0	0	0	0	0	0	1	0	0	1	0
4:15 PM	0	0	0	0	0	0	0	0	0	0	1	0	0	0	1	0	2	0
4:30 PM	0	0	0	1	0	0	0	0	0	0	0	0	0	0	1	0	2	0
4:45 PM	0	0	0	0	0	0	0	0	0	0	1	0	0	0	1	0	2	7
5:00 PM	0	0	0	0	0	0	0	0	0	0	2	0	0	0	1	0	3	9
5:15 PM	0	0	0	0	0	0	0	0	0	0	2	0	0	0	2	0	4	11
5:30 PM	0	0	0	0	0	0	0	0	0	0	3	0	0	0	1	0	4	13
5:45 PM	0	0	0	0	0	0	0	0	0	0	0	0	0	0	2	0	2	13
Count Total	0	0	0	1	0	0	0	0	0	0	9	0	0	1	9	0	20	0
Peak Hour	0	0	0	0	0	0	0	0	0	0	7	0	0	0	6	0	13	0
Two-Hour Count Summaries - Bikes																		
Interval Start	Harrison St			Harrison St			Lafayette St			Lafayette St			15-min Total	Rolling One Hour				
	Eastbound			Westbound			Northbound			Southbound								
	LT	TH	RT	LT	TH	RT	LT	TH	RT	LT	TH	RT						
4:00 PM	0	0	0	0	0	0	0	0	0	0	1	0	1	0				
4:15 PM	0	0	0	0	0	0	0	0	0	0	1	0	1	0				
4:30 PM	0	0	0	0	0	0	0	0	0	0	1	0	1	0				
4:45 PM	0	0	0	0	0	0	0	0	0	0	1	1	2	5				
5:00 PM	0	0	0	0	0	0	0	0	0	0	1	0	1	5				
5:15 PM	0	0	0	0	0	0	0	0	0	0	2	0	2	6				
5:30 PM	0	0	0	0	0	0	0	0	1	0	1	0	2	7				
5:45 PM	0	0	0	0	0	0	0	0	1	0	0	0	1	6				
Count Total	0	0	0	0	0	0	0	0	2	0	8	1	11	0				
Peak Hour	0	0	0	0	0	0	0	0	2	0	4	0	6	0				
<i>Note: U-Turn volumes for bikes are included in Left-Turn, if any.</i>																		

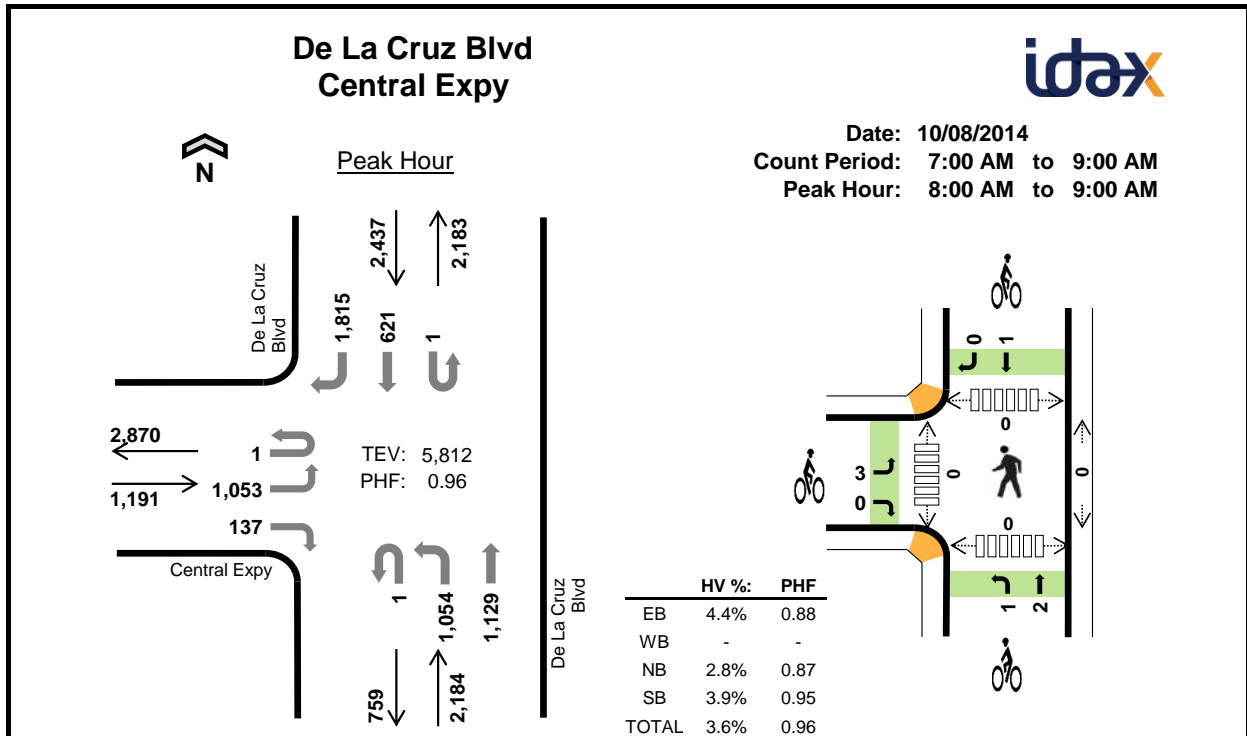

Two-Hour Count Summaries

Interval Start	Central Expy				0				De La Cruz Blvd				De La Cruz Blvd				15-min Total	Rolling One Hour	
	Eastbound				Westbound				Northbound				Southbound						
	UT	LT	TH	RT	UT	LT	TH	RT	UT	LT	TH	RT	UT	LT	TH	RT			
7:00 AM	0	153	0	21	0	0	0	0	0	162	178	0	0	0	140	391	1,045	0	
7:15 AM	0	139	0	35	0	0	0	0	0	188	189	0	0	0	152	415	1,118	0	
7:30 AM	0	186	0	35	0	0	0	0	0	244	206	0	0	0	133	421	1,225	0	
7:45 AM	0	234	0	33	0	0	0	0	0	236	195	0	1	0	180	418	1,297	4,685	
8:00 AM	1	205	0	36	0	0	0	0	0	342	285	0	0	0	187	452	1,508	5,148	
8:15 AM	0	272	0	13	0	0	0	0	0	244	294	0	0	0	162	456	1,441	5,471	
8:30 AM	0	286	0	53	0	0	0	0	1	241	285	0	0	0	145	452	1,463	5,709	
8:45 AM	0	290	0	35	0	0	0	0	0	227	265	0	1	0	127	455	1,400	5,812	
Count Total	1	1765	0	261	0	0	0	0	1	1884	1897	0	2	0	1226	3460	10,497	0	
Peak Hour	All	1	1053	0	137	0	0	0	0	1	1054	1129	0	1	0	621	1815	5,812	0
	HV	0	50	0	2	0	0	0	0	0	18	43	0	0	0	45	50	208	0
	HV%	0%	5%	-	1%	-	-	-	-	0%	2%	4%	-	0%	-	7%	3%	4%	0

Note: Two-hour count summary volumes include heavy vehicles but exclude bicycles in overall count.

Interval Start	Heavy Vehicle Totals					Bicycles					Pedestrians (Crossing Leg)				
	EB	WB	NB	SB	Total	EB	WB	NB	SB	Total	East	West	North	South	Total
7:00 AM	10	0	13	19	42	0	0	0	0	0	0	0	0	0	0
7:15 AM	12	0	13	19	44	0	0	0	0	0	0	0	0	0	0
7:30 AM	12	0	13	11	36	0	0	0	0	0	0	0	0	0	0
7:45 AM	7	0	15	17	39	2	0	0	0	2	0	0	0	0	0
8:00 AM	12	0	17	27	56	0	0	0	0	0	0	0	0	0	0
8:15 AM	10	0	14	19	43	1	0	2	1	4	0	0	0	0	0
8:30 AM	23	0	16	22	61	1	0	0	0	1	0	0	0	0	0
8:45 AM	7	0	14	27	48	1	0	1	0	2	0	0	0	0	0
Count Total	93	0	115	161	369	5	0	3	1	9	0	0	0	0	0
Peak Hr	52	0	61	95	208	3	0	3	1	7	0	0	0	0	0

Two-Hour Count Summaries - Heavy Vehicles																		
Interval Start	Central Expy				0				De La Cruz Blvd				De La Cruz Blvd				15-min Total	Rolling One Hour
	Eastbound				Westbound				Northbound				Southbound					
	UT	LT	TH	RT	UT	LT	TH	RT	UT	LT	TH	RT	UT	LT	TH	RT		
7:00 AM	0	9	0	1	0	0	0	0	0	1	12	0	0	0	7	12	42	0
7:15 AM	0	11	0	1	0	0	0	0	0	3	10	0	0	0	8	11	44	0
7:30 AM	0	9	0	3	0	0	0	0	0	4	9	0	0	0	8	3	36	0
7:45 AM	0	7	0	0	0	0	0	0	0	6	9	0	0	0	7	10	39	161
8:00 AM	0	11	0	1	0	0	0	0	0	9	8	0	0	0	12	15	56	175
8:15 AM	0	10	0	0	0	0	0	0	0	3	11	0	0	0	7	12	43	174
8:30 AM	0	22	0	1	0	0	0	0	0	3	13	0	0	0	13	9	61	199
8:45 AM	0	7	0	0	0	0	0	0	0	3	11	0	0	0	13	14	48	208
Count Total	0	86	0	7	0	0	0	0	0	32	83	0	0	0	75	86	369	0
Peak Hour	0	50	0	2	0	0	0	0	0	18	43	0	0	0	45	50	208	0
Two-Hour Count Summaries - Bikes																		
Interval Start	Central Expy			0			De La Cruz Blvd			De La Cruz Blvd			15-min Total	Rolling One Hour				
	Eastbound			Westbound			Northbound			Southbound								
	LT	TH	RT	LT	TH	RT	LT	TH	RT	LT	TH	RT						
7:00 AM	0	0	0	0	0	0	0	0	0	0	0	0	0	0	0	0	0	
7:15 AM	0	0	0	0	0	0	0	0	0	0	0	0	0	0	0	0	0	
7:30 AM	0	0	0	0	0	0	0	0	0	0	0	0	0	0	0	0	0	
7:45 AM	2	0	0	0	0	0	0	0	0	0	0	0	0	0	0	2	2	
8:00 AM	0	0	0	0	0	0	0	0	0	0	0	0	0	0	0	0	2	
8:15 AM	1	0	0	0	0	0	0	2	0	0	1	0	0	1	0	4	6	
8:30 AM	1	0	0	0	0	0	0	0	0	0	0	0	0	0	0	1	7	
8:45 AM	1	0	0	0	0	0	1	0	0	0	0	0	0	0	0	2	7	
Count Total	5	0	0	0	0	0	1	2	0	0	1	0	0	1	0	9	0	
Peak Hour	3	0	0	0	0	0	1	2	0	0	1	0	0	1	0	7	0	
<i>Note: U-Turn volumes for bikes are included in Left-Turn, if any.</i>																		

LOCATION: De la Cruz Blvd -- Central Expy
CITY/STATE: Santa Clara, CA

CLIENT ID: 5335

QC JOB #: 12781724
DATE: Thu, Oct 02 2014

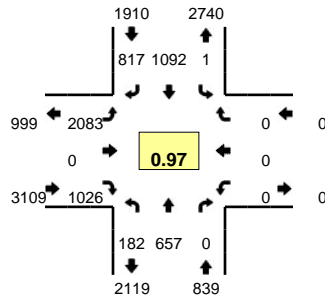

Peak-Hour: 5:00 PM -- 6:00 PM
Peak 15-Min: 5:45 PM -- 6:00 PM

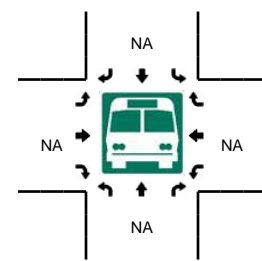
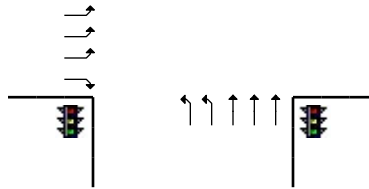
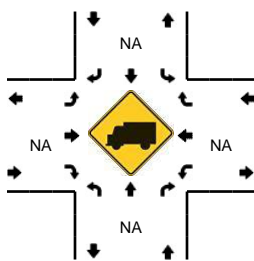
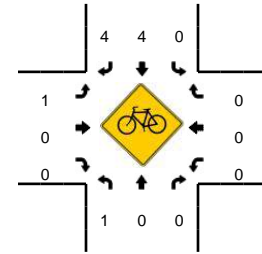
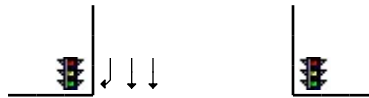
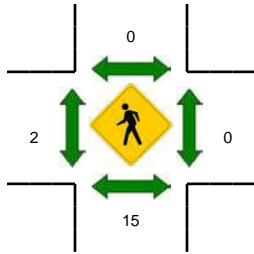
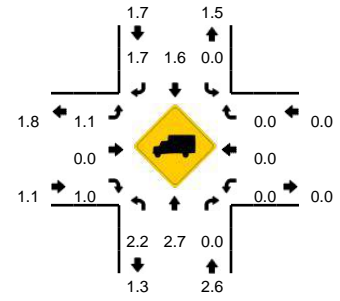

15-Min Count Period Beginning At	De la Cruz Blvd (Northbound)				De la Cruz Blvd (Southbound)				Central Expy (Eastbound)				Central Expy (Westbound)				Total	Hourly Totals
	Left	Thru	Right	U	Left	Thru	Right	U	Left	Thru	Right	U	Left	Thru	Right	U		
4:30 PM	33	164	0	0	0	193	161	0	464	0	240	0	0	0	0	0	1255	
4:45 PM	25	136	0	0	0	212	185	0	476	0	231	1	0	0	0	0	1266	
5:00 PM	57	209	0	1	0	255	186	0	511	0	214	1	0	0	0	0	1434	5393
5:15 PM	56	163	0	0	0	293	178	0	497	0	251	0	0	0	0	0	1438	5610
5:30 PM	41	156	0	0	0	252	215	0	532	0	276	0	0	0	0	0	1472	5858
5:45 PM	27	129	0	0	0	292	238	1	542	0	285	0	0	0	0	0	1514	5858
6:00 PM	44	158	0	0	0	282	195	0	449	0	275	0	0	0	0	0	1403	5827
6:15 PM	30	155	0	0	0	255	198	0	443	0	262	0	0	0	0	0	1343	5732
Peak 15-Min Flowrates	Northbound				Southbound				Eastbound				Westbound				Total	
	Left	Thru	Right	U	Left	Thru	Right	U	Left	Thru	Right	U	Left	Thru	Right	U		
All Vehicles	108	516	0	0	0	1168	952	4	2168	0	1140	0	0	0	0	0	6056	
Heavy Trucks	0	20	0	0	0	16	16	0	16	0	4	0	0	0	0	0	72	
Pedestrians		12				0				0				0			12	
Bicycles	0	0	0		0	3	1		0	0	0		0	0	0		4	
Railroad																		
Stopped Buses																		

Comments: Separate out EB HOV lane.

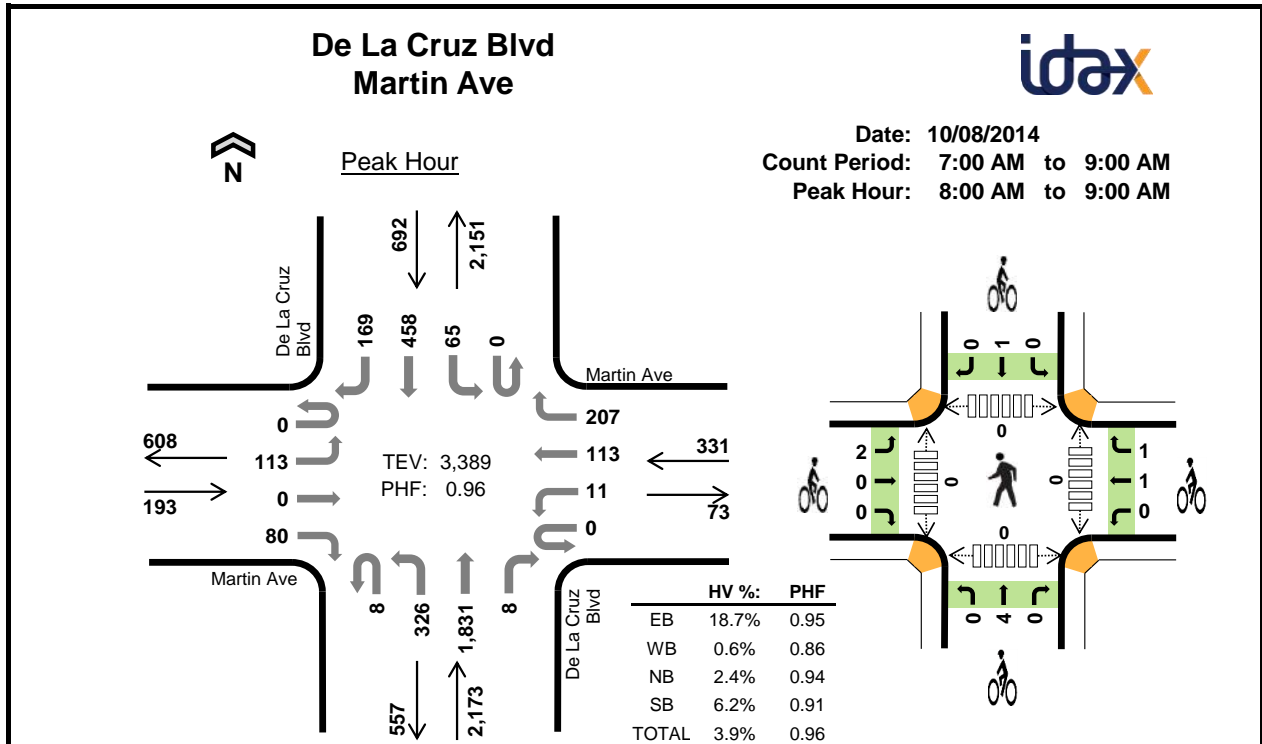

Two-Hour Count Summaries

Interval Start	Martin Ave Eastbound				Martin Ave Westbound				De La Cruz Blvd Northbound				De La Cruz Blvd Southbound				15-min Total	Rolling One Hour	
	UT	LT	TH	RT	UT	LT	TH	RT	UT	LT	TH	RT	UT	LT	TH	RT			
7:00 AM	0	25	1	17	0	2	8	28	8	48	298	0	1	21	79	56	592	0	
7:15 AM	0	20	3	12	0	1	18	29	3	61	376	2	0	20	98	51	694	0	
7:30 AM	0	22	8	10	0	2	12	54	2	70	316	2	0	17	99	41	655	0	
7:45 AM	0	18	3	13	0	3	35	46	0	68	355	3	1	16	104	73	738	2,679	
8:00 AM	0	32	0	19	0	0	28	32	0	85	495	1	0	23	116	51	882	2,969	
8:15 AM	0	25	0	20	0	4	30	62	3	71	422	3	0	10	115	50	815	3,090	
8:30 AM	0	26	0	23	0	4	22	60	4	94	448	4	0	21	123	33	862	3,297	
8:45 AM	0	30	0	18	0	3	33	53	1	76	466	0	0	11	104	35	830	3,389	
Count Total	0	198	15	132	0	19	186	364	21	573	3176	15	2	139	838	390	6,068	0	
Peak Hour	All	0	113	0	80	0	11	113	207	8	326	1831	8	0	65	458	169	3,389	0
	HV	0	24	0	12	0	0	1	1	0	21	30	0	0	2	22	19	132	0
	HV%	-	21%	-	15%	-	0%	1%	0%	0%	6%	2%	0%	-	3%	5%	11%	4%	0

Note: Two-hour count summary volumes include heavy vehicles but exclude bicycles in overall count.

Interval Start	Heavy Vehicle Totals					Bicycles					Pedestrians (Crossing Leg)				
	EB	WB	NB	SB	Total	EB	WB	NB	SB	Total	East	West	North	South	Total
7:00 AM	7	1	12	7	27	0	0	0	0	0	1	0	0	0	1
7:15 AM	12	1	4	9	26	0	0	0	0	0	0	0	0	0	1
7:30 AM	7	2	12	9	30	0	0	0	0	0	0	0	0	0	0
7:45 AM	10	1	7	8	26	0	0	0	0	0	0	4	1	0	5
8:00 AM	5	0	15	9	29	0	1	0	1	2	0	0	0	0	0
8:15 AM	8	0	9	9	26	0	1	0	0	1	0	0	0	0	0
8:30 AM	12	0	15	12	39	2	0	3	0	5	0	0	0	0	0
8:45 AM	11	2	12	13	38	0	0	1	0	1	0	0	0	0	0
Count Total	72	7	86	76	241	2	2	4	1	9	1	4	1	1	7
Peak Hour	36	2	51	43	132	2	2	4	1	9	0	0	0	0	0

Two-Hour Count Summaries - Heavy Vehicles																		
Interval Start	Martin Ave				Martin Ave				De La Cruz Blvd				De La Cruz Blvd				15-min Total	Rolling One Hour
	Eastbound				Westbound				Northbound				Southbound					
	UT	LT	TH	RT	UT	LT	TH	RT	UT	LT	TH	RT	UT	LT	TH	RT		
7:00 AM	0	5	0	2	0	0	0	1	1	1	10	0	0	0	1	6	27	0
7:15 AM	0	9	0	3	0	0	0	1	0	1	3	0	0	0	4	5	26	0
7:30 AM	0	5	0	2	0	0	1	1	0	3	9	0	0	0	7	2	30	0
7:45 AM	0	6	0	4	0	0	0	1	0	2	5	0	0	0	4	4	26	109
8:00 AM	0	2	0	3	0	0	0	0	0	4	11	0	0	0	5	4	29	111
8:15 AM	0	6	0	2	0	0	0	0	0	4	5	0	0	0	6	3	26	111
8:30 AM	0	7	0	5	0	0	0	0	0	8	7	0	0	0	5	7	39	120
8:45 AM	0	9	0	2	0	0	1	1	0	5	7	0	0	2	6	5	38	132
Count Total	0	49	0	23	0	0	2	5	1	28	57	0	0	2	38	36	241	0
Peak Hour	0	24	0	12	0	0	1	1	0	21	30	0	0	2	22	19	132	0

Two-Hour Count Summaries - Bikes																
Interval Start	Martin Ave			Martin Ave			De La Cruz Blvd			De La Cruz Blvd			15-min Total	Rolling One Hour		
	Eastbound			Westbound			Northbound			Southbound						
	LT	TH	RT	LT	TH	RT	LT	TH	RT	LT	TH	RT				
7:00 AM	0	0	0	0	0	0	0	0	0	0	0	0	0	0		
7:15 AM	0	0	0	0	0	0	0	0	0	0	0	0	0	0		
7:30 AM	0	0	0	0	0	0	0	0	0	0	0	0	0	0		
7:45 AM	0	0	0	0	0	0	0	0	0	0	0	0	0	0		
8:00 AM	0	0	0	0	0	0	1	0	0	0	0	0	1	0		
8:15 AM	0	0	0	0	1	0	0	0	0	0	0	0	0	1		
8:30 AM	2	0	0	0	0	0	0	0	3	0	0	0	0	5		
8:45 AM	0	0	0	0	0	0	0	0	1	0	0	0	0	1		
Count Total	2	0	0	0	1	1	0	4	0	0	1	0	9	0		
Peak Hour	2	0	0	0	1	1	0	4	0	0	1	0	9	0		

Note: U-Turn volumes for bikes are included in Left-Turn, if any.

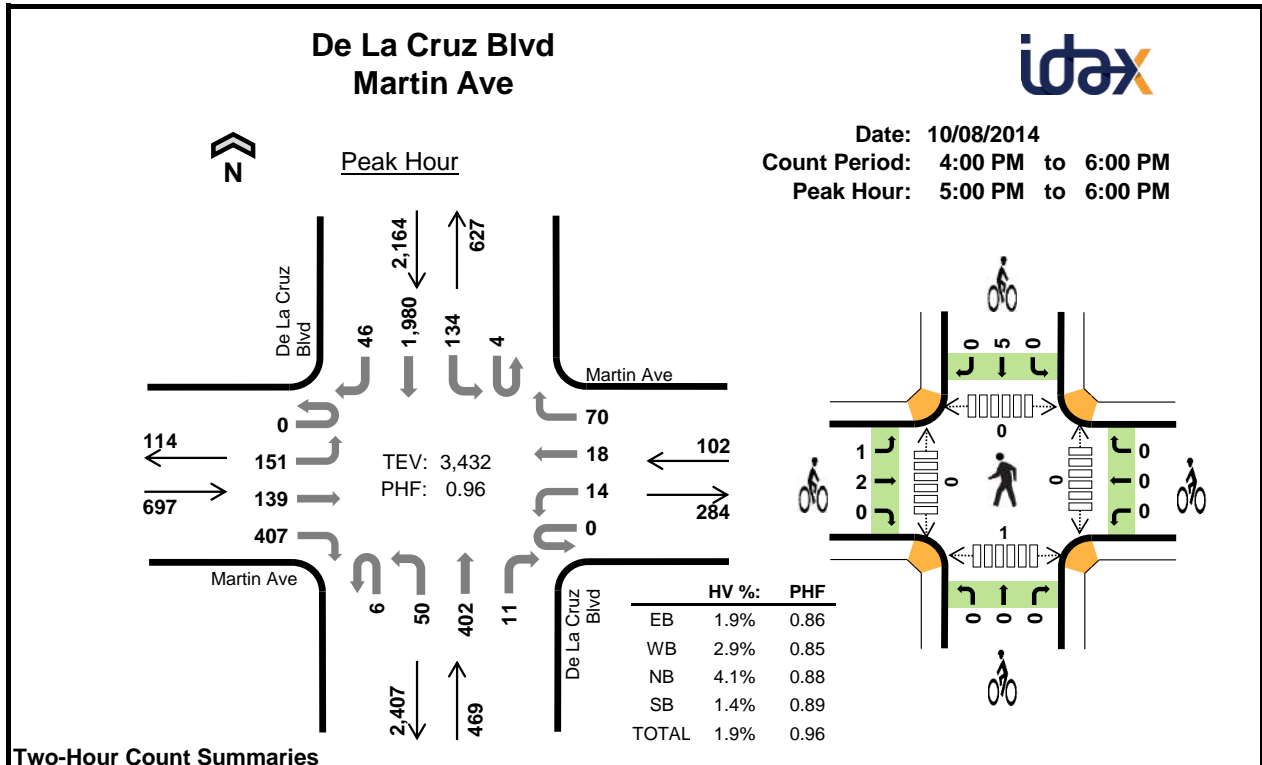

Two-Hour Count Summaries

Interval Start	Martin Ave Eastbound				Martin Ave Westbound				De La Cruz Blvd Northbound				De La Cruz Blvd Southbound				15-min Total	Rolling One Hour	
	UT	LT	TH	RT	UT	LT	TH	RT	UT	LT	TH	RT	UT	LT	TH	RT			
4:00 PM	0	49	26	90	0	4	7	17	2	13	129	7	3	18	315	16	696	0	
4:15 PM	0	23	14	64	0	3	2	25	1	12	98	6	2	16	405	18	689	0	
4:30 PM	0	59	25	98	0	11	5	26	1	13	94	3	1	18	403	12	769	0	
4:45 PM	0	27	28	84	0	1	3	20	1	13	103	1	2	19	440	16	758	2,912	
5:00 PM	0	66	34	102	0	6	4	18	3	13	114	4	1	27	436	11	839	3,055	
5:15 PM	0	25	34	102	0	6	8	16	3	15	94	7	1	38	461	9	819	3,185	
5:30 PM	0	36	46	110	0	2	5	22	0	14	86	0	2	40	516	13	892	3,308	
5:45 PM	0	24	25	93	0	0	1	14	0	8	108	0	0	29	567	13	882	3,432	
Count Total	0	309	232	743	0	33	35	158	11	101	826	28	12	205	3543	108	6,344	0	
Peak Hour	All	0	151	139	407	0	14	18	70	6	50	402	11	4	134	1980	46	3,432	0
	HV	0	4	0	9	0	0	0	3	0	7	12	0	0	4	22	4	65	0
	HV%	-	3%	0%	2%	-	0%	0%	4%	0%	14%	3%	0%	0%	3%	1%	9%	2%	0

Note: Two-hour count summary volumes include heavy vehicles but exclude bicycles in overall count.

Interval Start	Heavy Vehicle Totals					Bicycles					Pedestrians (Crossing Leg)				
	EB	WB	NB	SB	Total	EB	WB	NB	SB	Total	East	West	North	South	Total
4:00 PM	2	3	12	12	29	0	0	0	1	1	0	0	0	0	0
4:15 PM	3	0	10	13	26	0	0	0	0	0	0	0	0	0	0
4:30 PM	4	1	3	7	15	0	0	0	1	1	0	0	0	0	0
4:45 PM	5	0	5	4	14	0	0	0	2	2	0	0	0	0	0
5:00 PM	3	1	5	11	20	1	0	0	1	2	0	0	0	1	1
5:15 PM	3	2	6	6	17	0	0	0	1	1	0	0	0	0	0
5:30 PM	5	0	6	7	18	1	0	0	0	1	0	0	0	0	0
5:45 PM	2	0	2	6	10	1	0	0	3	4	0	0	0	0	0
Count Total	27	7	49	66	149	3	0	0	9	12	0	0	0	1	1
Peak Hour	13	3	19	30	65	3	0	0	5	8	0	0	0	1	1

Two-Hour Count Summaries - Heavy Vehicles																		
Interval Start	Martin Ave				Martin Ave				De La Cruz Blvd				De La Cruz Blvd				15-min Total	Rolling One Hour
	Eastbound				Westbound				Northbound				Southbound					
	UT	LT	TH	RT	UT	LT	TH	RT	UT	LT	TH	RT	UT	LT	TH	RT		
4:00 PM	0	2	0	0	0	0	1	2	0	2	10	0	0	1	11	0	29	0
4:15 PM	0	1	1	1	0	0	0	0	0	0	9	1	0	2	8	3	26	0
4:30 PM	0	2	0	2	0	0	1	0	0	0	3	0	0	1	6	0	15	0
4:45 PM	0	3	1	1	0	0	0	0	0	0	4	1	0	0	3	1	14	84
5:00 PM	0	0	0	3	0	0	0	1	0	2	3	0	0	1	10	0	20	75
5:15 PM	0	0	0	3	0	0	0	2	0	2	4	0	0	1	2	3	17	66
5:30 PM	0	3	0	2	0	0	0	0	0	3	3	0	0	2	4	1	18	69
5:45 PM	0	1	0	1	0	0	0	0	0	0	2	0	0	0	6	0	10	65
Count Total	0	12	2	13	0	0	2	5	0	9	38	2	0	8	50	8	149	0
Peak Hour	0	4	0	9	0	0	0	3	0	7	12	0	0	4	22	4	65	0
Two-Hour Count Summaries - Bikes																		
Interval Start	Martin Ave			Martin Ave			De La Cruz Blvd			De La Cruz Blvd			15-min Total	Rolling One Hour				
	Eastbound			Westbound			Northbound			Southbound								
	LT	TH	RT	LT	TH	RT	LT	TH	RT	LT	TH	RT						
4:00 PM	0	0	0	0	0	0	0	0	0	0	1	0	1	0				
4:15 PM	0	0	0	0	0	0	0	0	0	0	0	0	0	0				
4:30 PM	0	0	0	0	0	0	0	0	0	0	1	0	1	0				
4:45 PM	0	0	0	0	0	0	0	0	0	0	1	1	2	4				
5:00 PM	0	1	0	0	0	0	0	0	0	0	1	0	2	5				
5:15 PM	0	0	0	0	0	0	0	0	0	0	1	0	1	6				
5:30 PM	1	0	0	0	0	0	0	0	0	0	0	0	1	6				
5:45 PM	0	1	0	0	0	0	0	0	0	0	3	0	4	8				
Count Total	1	2	0	0	0	0	0	0	0	0	8	1	12	0				
Peak Hour	1	2	0	0	0	0	0	0	0	0	5	0	8	0				

Note: U-Turn volumes for bikes are included in Left-Turn, if any.

Appendix D
Volume Summary Tables

BART Phase II Extension Project

	Intersection		TRAFFIX	MODEL
	N/S street	E/W street	Node #	Node #
1	21st St	Julian St	3612	4028
2	24th St	Julian St	3613	8525
3	28th St	Julian St	4005	6443
4	US-101 SB	Julian St	3210	60610
5	US-101 NB	McKee Rd	3211	60613
6	King Rd	McKee Rd	3625	8730
7	17th St	Santa Clara St	3783	4710
8	24th St	Santa Clara St	3790	8524
9	28th St	Santa Clara St	3788	6586
10	US-101 SB	Santa Clara St *	3023	8517
11	US-101 NB	Santa Clara St *	3016	8514
12	24th St	San Antonio St	3762	8523
13	24th St	E William St	3832	8521
14	McLaughlin Ave	I-280 SB *	3036	60617
15	McLaughlin Ave	Story Rd	3683	7968
16	The Alameda	Taylor St *	3058	4148
17	Stockton Ave	Julian St	3608	8592
18	Montgomery St	Julian St	3606	4027
19	Autumn St	Julian St	3263	7570
20	SR-87 [W]	Julian St *	3014	8697
21	SR-87 [E]	Julian St *	3013	8683
22	The Alameda	Julian St	3227	8612
23	Race St	The Alameda *	3059	8613
24	Stockton Ave	The Alameda	3230	6629
25	Cahill St	Santa Clara St	3363	6632
26	Montgomery St	Santa Clara St *	3112	8588
27	Autumn St	Santa Clara St *	3066	7571
28	SR-87 NB	Santa Clara St *	3015	8668
29	Montgomery St	San Fernando St	3710	6634
30	Autumn St	San Fernando St	3264	6635
31	Delmas Ave	San Fernando St	3985	8726
32	Montgomery St	Park Ave	3709	8675
33	Delmas Ave	Park Ave	3445	8719
34	Meridian Ave	San Carlos St	3693	8652
35	Race St	San Carlos St	3748	8399
36	Lincoln Ave	San Carlos St	3653	8400
37	Bird Ave	San Carlos St *	3077	8674
38	Bird Ave	Auzerais Ave	3266	8677
39	Meridian Ave	Parkmoor Ave	3690	8404
40	Lincoln Ave	Parkmoor Ave	3651	8398
41	Bird Ave	I-280 [N] *	3032	8682
42	Bird Ave	I-280 [S] *	3033	8437
43	SW Expressway	Fruitdale Ave	3553	8359
44	Meridian Ave	Fruitdale Ave	3552	8378
45	Lafayette St	Reed St	7	6461
46	De La Cruz Blvd	Reed St	175	6460
47	San Tomas Expwy	El Camino Real *	5416	8900
48	Scott Blvd	El Camino Real *	1205	8889
49	Monroe St	El Camino Real *	1204	8834
50	Lafayette St	El Camino Real *	1202	8835
51	El Camino Real	Benton St	106	8796
52	El Camino Real	Railroad Ave	1012	60622
53	El Camino Real	The Alameda *	1213	8799
54	Lafayette St	Benton St	107	8838
55	Coleman Ave	Brokaw Rd	9	6462
56	Coleman Ave	Aviation Ave	3411	60625
57	Coleman Ave	Newhall Dr	4047	4076
58	Lafayette St	Lewis St	5444	6470
59	Lafayette St	Harrison St	1008	7197
60	De La Cruz Blvd	Central Expressway *	5335	4798
61	De La Cruz Blvd	Martin Ave	6	6450
63	21st St	Santa Clara St	3789	6858
64	26th St	Santa Clara St	4022	8526

* Denotes CMP Intersection

Intersection Number: 1
 Traffix Node #: 3612
 Model Node #: 4028
 Intersection Name: 21st St and Julian St
 Peak Hour: AM

Date of Analysis: 06/15/15
 Count Date: 10/09/14

Scenario:	Movements												Total:
	North Approach			East Approach			South Approach			West Approach			
	RT	TH	LT	RT	TH	LT	RT	TH	LT	RT	TH	LT	
Existing Conditions	25	0	287	414	802	0	0	0	0	0	409	2	1939
Project Trips	0	0	1	-1	-20	0	0	0	0	0	20	-1	-1
Existing Plus Project Conditions	25	0	288	413	782	0	0	0	0	0	429	1	1938
2025													
2025 No Project Background	25	0	287	414	825	0	0	0	0	0	409	2	1962
2025 No Project Drive Access	0	0	0	0	2	0	0	0	0	0	1	0	3
2025 No Project Conditions	25	0	287	414	827	0	0	0	0	0	410	2	1965
2025 Project Background	25	0	287	411	792	0	0	0	0	0	401	1	1917
2025 No Project Drive Access	0	0	0	0	-2	0	0	0	0	0	-1	0	-3
2025 Project Drive Access	0	0	2	0	4	0	0	0	0	0	63	0	69
Change in Bkgrd (car-->BART)	0	0	0	-3	-33	0	0	0	0	0	-8	-1	-45
2025 Net Project Trips	0	0	2	-3	-31	0	0	0	0	0	54	-1	21
2025 Project Conditions	25	0	289	411	796	0	0	0	0	0	464	1	1986
2035													
2035 No Project Background	29	0	287	414	806	0	0	0	0	0	409	2	1947
2035 No Project Drive Access	0	0	0	1	2	0	0	0	0	0	1	0	4
2035 No Project Conditions	29	0	287	415	808	0	0	0	0	0	410	2	1951
2035 Project Background	28	0	285	411	770	0	0	0	0	0	399	1	1894
2035 No Project Drive Access	0	0	0	-1	-2	0	0	0	0	0	-1	0	-4
2035 Project Drive Access	0	0	6	1	6	0	0	0	0	0	85	0	98
Change in Bkgrd (car-->BART)	-1	0	-2	-3	-36	0	0	0	0	0	-10	-1	-53
2035 Net Project Trips	-1	0	4	-3	-32	0	0	0	0	0	74	-1	41
2035 Project Conditions	28	0	291	412	776	0	0	0	0	0	484	1	1992

Intersection Number: 2
 Traffix Node #: 3613
 Model Node #: 8525
 Intersection Name: 24th St and Julian St
 Peak Hour: AM

Date of Analysis: 06/15/15
 Count Date: 10/09/14

Scenario:	Movements												Total:
	North Approach			East Approach			South Approach			West Approach			
	RT	TH	LT	RT	TH	LT	RT	TH	LT	RT	TH	LT	
Existing Conditions	0	0	0	0	1042	121	134	0	242	166	495	0	2200
Project Trips	0	0	0	0	-19	-17	-3	0	-2	0	20	0	-21
Existing Plus Project Conditions	0	0	0	0	1023	104	131	0	240	166	515	0	2179
2025													
2025 No Project Background	0	0	0	0	1058	335	134	0	242	166	495	0	2430
2025 No Project Drive Access	0	0	0	0	2	2	7	0	0	0	1	0	12
2025 No Project Conditions	0	0	0	0	1060	337	141	0	242	166	496	0	2442
2025 Project Background	0	0	0	0	1028	310	131	0	238	166	486	0	2359
2025 No Project Drive Access	0	0	0	0	-2	-2	-7	0	0	0	-1	0	-12
2025 Project Drive Access	0	0	0	0	4	2	0	0	0	0	65	0	71
Change in Bkgrd (car-->BART)	0	0	0	0	-30	-25	-3	0	-4	0	-9	0	-71
2025 Net Project Trips	0	0	0	0	-28	-25	-10	0	-4	0	55	0	-12
2025 Project Conditions	0	0	0	0	1032	312	131	0	238	166	551	0	2430
2035													
2035 No Project Background	0	0	0	0	1042	377	134	0	331	166	495	0	2545
2035 No Project Drive Access	0	0	0	0	2	3	3	0	1	0	1	0	10
2035 No Project Conditions	0	0	0	0	1044	380	137	0	332	166	496	0	2555
2035 Project Background	0	0	0	0	1009	341	130	0	325	165	484	0	2454
2035 No Project Drive Access	0	0	0	0	-2	-3	-3	0	-1	0	-1	0	-10
2035 Project Drive Access	0	0	0	0	7	5	1	0	0	0	91	0	104
Change in Bkgrd (car-->BART)	0	0	0	0	-33	-36	-4	0	-6	-1	-11	0	-91
2035 Net Project Trips	0	0	0	0	-28	-34	-6	0	-7	-1	79	0	3
2035 Project Conditions	0	0	0	0	1016	346	131	0	325	165	575	0	2558

Intersection Number: 3
 Traffic Node #: 4005
 Model Node #: 6443
 Intersection Name: 28th St and Julian St
 Peak Hour: AM

Date of Analysis: 06/15/15
 Count Date: 04/09/15

Scenario:	Movements												Total:
	North Approach			East Approach			South Approach			West Approach			
	RT	TH	LT	RT	TH	LT	RT	TH	LT	RT	TH	LT	
Existing Conditions	2	24	182	142	798	36	100	42	71	21	591	2	2011
Project Trips	-1	0	-1	-1	-35	33	18	0	1	30	-16	-1	27
Existing Plus Project Conditions	1	24	181	141	763	69	118	42	72	51	575	1	2038
2025													
2025 No Project Background	10	25	187	142	1023	136	100	49	82	28	591	3	2376
2025 No Project Drive Access	0	0	0	0	4	0	0	0	0	0	8	0	12
2025 No Project Conditions	10	25	187	142	1027	136	100	49	82	28	599	3	2388
2025 Project Background	8	25	186	141	974	132	100	49	81	28	572	2	2298
2025 No Project Drive Access	0	0	0	0	-4	0	0	0	0	0	-8	0	-12
2025 Project Drive Access	0	0	0	0	3	127	29	0	3	66	0	0	228
Change in Bkgrd (car->BART)	-2	0	-1	-1	-49	-4	0	0	-1	0	-19	-1	-78
2025 Net Project Trips	-2	0	-1	-1	-50	123	29	0	2	66	-27	-1	138
2025 Project Conditions	8	25	186	141	977	259	129	49	84	94	572	2	2526
2035													
2035 No Project Background	19	25	192	142	935	202	100	48	88	34	591	8	2384
2035 No Project Drive Access	0	0	0	0	6	0	0	0	0	0	6	0	12
2035 No Project Conditions	19	25	192	142	941	202	100	48	88	34	597	8	2396
2035 Project Background	16	25	189	140	874	196	100	48	87	34	568	7	2284
2035 No Project Drive Access	0	0	0	0	-6	0	0	0	0	0	-6	0	-12
2035 Project Drive Access	0	1	0	0	5	150	33	0	6	96	1	0	292
Change in Bkgrd (car->BART)	-3	0	-3	-2	-61	-6	0	0	-1	0	-23	-1	-100
2035 Net Project Trips	-3	1	-3	-2	-62	144	33	0	5	96	-28	-1	180
2035 Project Conditions	16	26	189	140	879	346	133	48	93	130	569	7	2576

Intersection Number: 4
 Traffic Node #: 3210
 Model Node #: 60610
 Intersection Name: US-101 SB and Julian St
 Peak Hour: AM

Date of Analysis: 06/15/15
 Count Date: 10/09/14

Scenario:	Movements												Total:
	North Approach			East Approach			South Approach			West Approach			
	RT	TH	LT	RT	TH	LT	RT	TH	LT	RT	TH	LT	
Existing Conditions	0	0	0	0	938	513	320	0	106	408	549	0	2834
Project Trips	0	0	0	0	0	-1	-5	0	-3	18	-17	0	-8
Existing Plus Project Conditions	0	0	0	0	938	512	315	0	103	426	532	0	2826
2025													
2025 No Project Background	0	0	0	0	1273	716	320	0	106	408	549	0	3372
2025 No Project Drive Access	0	0	0	0	4	5	0	0	0	0	9	0	18
2025 No Project Conditions	0	0	0	0	1277	721	320	0	106	408	558	0	3390
2025 Project Background	0	0	0	0	1228	712	320	0	95	404	533	0	3292
2025 No Project Drive Access	0	0	0	0	-4	-5	0	0	0	0	-9	0	-18
2025 Project Drive Access	0	0	0	0	82	0	0	0	47	27	2	0	158
Change in Bkgrd (car->BART)	0	0	0	0	-45	-4	0	0	-11	-4	-16	0	-80
2025 Net Project Trips	0	0	0	0	33	-9	0	0	36	23	-23	0	60
2025 Project Conditions	0	0	0	0	1310	712	320	0	142	431	535	0	3450
2035													
2035 No Project Background	0	0	0	0	1188	804	320	0	150	408	549	0	3419
2035 No Project Drive Access	0	0	0	0	6	9	0	0	0	0	6	0	21
2035 No Project Conditions	0	0	0	0	1194	813	320	0	150	408	555	0	3440
2035 Project Background	0	0	0	0	1135	800	320	0	136	402	530	0	3323
2035 No Project Drive Access	0	0	0	0	-6	-9	0	0	0	0	-6	0	-21
2035 Project Drive Access	0	0	0	0	89	0	0	0	66	29	4	0	188
Change in Bkgrd (car->BART)	0	0	0	0	-53	-4	0	0	-14	-6	-19	0	-96
2035 Net Project Trips	0	0	0	0	30	-13	0	0	52	23	-21	0	71
2035 Project Conditions	0	0	0	0	1224	800	320	0	202	431	534	0	3511

Intersection Number: 5
 Traffix Node #: 3211
 Model Node #: 60613
 Intersection Name: US-101 NB and McKee Rd
 Peak Hour: AM

Date of Analysis: 06/15/15
 Count Date: 10/09/14

Scenario:	Movements												Total:
	North Approach			East Approach			South Approach			West Approach			
	RT	TH	LT	RT	TH	LT	RT	TH	LT	RT	TH	LT	
Existing Conditions	0	0	0	376	1181	0	241	6	240	0	761	114	2919
Project Trips	0	0	0	-7	-21	0	-1	0	20	0	-15	-8	-32
Existing Plus Project Conditions	0	0	0	369	1160	0	240	6	260	0	746	106	2887
2025													
2025 No Project Background	0	0	0	722	1649	0	241	6	240	0	1060	114	4032
2025 No Project Drive Access	0	0	0	0	10	0	67	0	0	0	8	0	85
2025 No Project Conditions	0	0	0	722	1659	0	308	6	240	0	1068	114	4117
2025 Project Background	0	0	0	699	1604	0	233	6	239	0	1045	108	3934
2025 No Project Drive Access	0	0	0	0	-10	0	-67	0	0	0	-8	0	-85
2025 Project Drive Access	0	0	0	0	24	0	1	0	19	0	1	0	45
Change in Bkgrd (car-->BART)	0	0	0	-23	-45	0	-8	0	-1	0	-15	-6	-98
2025 Net Project Trips	0	0	0	-23	-31	0	-74	0	18	0	-22	-6	-138
2025 Project Conditions	0	0	0	699	1628	0	234	6	258	0	1046	108	3979
2035													
2035 No Project Background	0	0	0	712	1713	0	241	6	240	0	1109	114	4135
2035 No Project Drive Access	0	0	0	2	14	0	64	0	0	0	6	0	86
2035 No Project Conditions	0	0	0	714	1727	0	305	6	240	0	1115	114	4221
2035 Project Background	0	0	0	701	1659	0	235	6	240	0	1089	109	4039
2035 No Project Drive Access	0	0	0	-2	-14	0	-64	0	0	0	-6	0	-86
2035 Project Drive Access	0	0	0	2	38	0	0	0	26	0	3	0	69
Change in Bkgrd (car-->BART)	0	0	0	-11	-54	0	-6	0	0	0	-20	-5	-96
2035 Net Project Trips	0	0	0	-11	-30	0	-70	0	26	0	-23	-5	-113
2035 Project Conditions	0	0	0	703	1697	0	235	6	266	0	1092	109	4108

Intersection Number: 6
 Traffix Node #: 3625
 Model Node #: 8730
 Intersection Name: King Rd and McKee Rd
 Peak Hour: AM

Date of Analysis: 06/15/15
 Count Date: 10/09/14

Scenario:	Movements												Total:
	North Approach			East Approach			South Approach			West Approach			
	RT	TH	LT	RT	TH	LT	RT	TH	LT	RT	TH	LT	
Existing Conditions	326	259	80	287	754	122	162	645	167	82	537	331	3752
Project Trips	-3	5	1	4	-24	-5	-1	11	1	0	-9	-2	-22
Existing Plus Project Conditions	323	264	81	291	730	117	161	656	168	82	528	329	3730
2025													
2025 No Project Background	500	358	80	287	1185	201	169	697	404	104	741	331	5057
2025 No Project Drive Access	8	21	1	3	2	0	0	98	0	0	0	75	208
2025 No Project Conditions	508	379	81	290	1187	201	169	795	404	104	741	406	5265
2025 Project Background	484	349	80	286	1147	193	169	691	395	104	730	322	4950
2025 No Project Drive Access	-8	-21	-1	-3	-2	0	0	-98	0	0	0	-75	-208
2025 Project Drive Access	1	8	1	3	9	1	0	22	13	0	1	2	61
Change in Bkgrd (car-->BART)	-16	-9	0	-1	-38	-8	0	-6	-9	0	-11	-9	-107
2025 Net Project Trips	-23	-22	0	-1	-31	-7	0	-82	4	0	-10	-82	-254
2025 Project Conditions	485	357	81	289	1156	194	169	713	408	104	731	324	5011
2035													
2035 No Project Background	541	600	80	287	1094	301	195	780	467	115	783	331	5574
2035 No Project Drive Access	11	28	1	7	5	1	0	127	1	0	0	71	252
2035 No Project Conditions	552	628	81	294	1099	302	195	907	468	115	783	402	5826
2035 Project Background	516	583	80	286	1063	293	195	776	462	115	768	322	5459
2035 No Project Drive Access	-11	-28	-1	-7	-5	-1	0	-127	-1	0	0	-71	-252
2035 Project Drive Access	1	8	1	6	18	2	0	26	16	1	1	0	80
Change in Bkgrd (car-->BART)	-25	-17	0	-1	-31	-8	0	-4	-5	0	-15	-9	-115
2035 Net Project Trips	-35	-37	0	-2	-18	-7	0	-105	10	1	-14	-80	-287
2035 Project Conditions	517	591	81	292	1081	295	195	802	478	116	769	322	5539

Intersection Number: 7
 Traffic Node #: 3783
 Model Node #: 4710
 Intersection Name: 17th St and Santa Clara St
 Peak Hour: AM

Date of Analysis: 06/15/15
 Count Date: 10/09/14

Scenario:	Movements												Total:
	North Approach			East Approach			South Approach			West Approach			
	RT	TH	LT	RT	TH	LT	RT	TH	LT	RT	TH	LT	
Existing Conditions	23	37	59	92	734	8	4	3	7	4	311	16	1298
Project Trips	0	0	0	-1	-26	0	1	-1	-1	0	28	0	0
Existing Plus Project Conditions	23	37	59	91	708	8	5	2	6	4	339	16	1298
2025													
2025 No Project Background	26	45	63	224	734	8	4	3	140	5	357	22	1631
2025 No Project Drive Access	0	0	0	5	4	0	0	1	1	0	1	1	13
2025 No Project Conditions	26	45	63	229	738	8	4	4	141	5	358	23	1644
2025 Project Background	26	45	63	216	700	8	4	1	135	5	351	22	1576
2025 No Project Drive Access	0	0	0	-5	-4	0	0	-1	-1	0	-1	-1	-13
2025 Project Drive Access	0	0	0	1	5	0	1	0	1	0	31	0	39
Change in Bkgrd (car->BART)	0	0	0	-8	-34	0	0	-2	-5	0	-6	0	-55
2025 Net Project Trips	0	0	0	-12	-33	0	1	-3	-5	0	24	-1	-29
2025 Project Conditions	26	45	63	217	705	8	5	1	136	5	382	22	1615
2035													
2035 No Project Background	23	54	86	99	749	8	4	135	69	8	403	31	1669
2035 No Project Drive Access	0	0	0	7	6	0	0	2	1	0	1	2	19
2035 No Project Conditions	23	54	86	106	755	8	4	137	70	8	404	33	1688
2035 Project Background	23	54	86	94	700	8	4	130	65	8	394	31	1597
2035 No Project Drive Access	0	0	0	-7	-6	0	0	-2	-1	0	-1	-2	-19
2035 Project Drive Access	0	0	0	3	7	0	3	1	1	0	53	0	68
Change in Bkgrd (car->BART)	0	0	0	-5	-49	0	0	-5	-4	0	-9	0	-72
2035 Net Project Trips	0	0	0	-9	-48	0	3	-6	-4	0	43	-2	-23
2035 Project Conditions	23	54	86	97	707	8	7	131	66	8	447	31	1665

Intersection Number: 8
 Traffic Node #: 3790
 Model Node #: 8524
 Intersection Name: 24th St and Santa Clara St
 Peak Hour: AM

Date of Analysis: 06/15/15
 Count Date: 11/05/13

Scenario:	Movements												Total:
	North Approach			East Approach			South Approach			West Approach			
	RT	TH	LT	RT	TH	LT	RT	TH	LT	RT	TH	LT	
Existing Conditions	78	141	23	39	822	67	117	265	86	38	354	51	2081
Project Trips	-14	-3	0	-1	-9	1	32	-4	-5	-1	33	-2	27
Existing Plus Project Conditions	64	138	23	38	813	68	149	261	81	37	387	49	2108
2025													
2025 No Project Background	225	196	35	55	822	106	138	265	86	57	376	51	2412
2025 No Project Drive Access	1	1	0	0	2	0	0	7	5	0	0	0	16
2025 No Project Conditions	226	197	35	55	824	106	138	272	91	57	376	51	2428
2025 Project Background	206	189	35	50	806	103	135	259	79	55	374	49	2340
2025 No Project Drive Access	-1	-1	0	0	-2	0	0	-7	-5	0	0	0	-16
2025 Project Drive Access	1	0	0	0	3	1	49	0	1	0	32	0	87
Change in Bkgrd (car->BART)	-19	-7	0	-5	-16	-3	-3	-6	-7	-2	-2	-2	-72
2025 Net Project Trips	-19	-8	0	-5	-15	-2	46	-13	-11	-2	30	-2	-1
2025 Project Conditions	207	189	35	50	809	104	184	259	80	55	406	49	2427
2035													
2035 No Project Background	314	147	30	94	822	161	138	265	86	72	427	51	2607
2035 No Project Drive Access	3	1	0	0	2	0	5	5	6	1	1	0	24
2035 No Project Conditions	317	148	30	94	824	161	143	270	92	73	428	51	2631
2035 Project Background	284	141	30	91	807	158	135	258	80	69	423	49	2525
2035 No Project Drive Access	-3	-1	0	0	-2	0	-5	-5	-6	-1	-1	0	-24
2035 Project Drive Access	4	1	0	0	3	2	66	0	2	0	58	0	136
Change in Bkgrd (car->BART)	-30	-6	0	-3	-15	-3	-3	-7	-6	-3	-4	-2	-82
2035 Net Project Trips	-29	-6	0	-3	-14	-1	58	-12	-10	-4	53	-2	30
2035 Project Conditions	288	142	30	91	810	160	201	258	82	69	481	49	2661

Intersection Number: 9
 Traffic Node #: 3788
 Model Node #: 6586
 Intersection Name: 28th St and Santa Clara St
 Peak Hour: AM

Date of Analysis: 06/15/15
 Count Date: 10/09/14

Scenario:	Movements												Total:
	North Approach			East Approach			South Approach			West Approach			
	RT	TH	LT	RT	TH	LT	RT	TH	LT	RT	TH	LT	
Existing Conditions	35	51	71	124	606	46	196	147	47	24	474	37	1858
Project Trips	1	0	3	74	-11	-2	-7	7	0	0	-2	66	129
Existing Plus Project Conditions	36	51	74	198	595	44	189	154	47	24	472	103	1987
2025													
2025 No Project Background	50	143	72	146	606	46	260	147	47	25	552	38	2132
2025 No Project Drive Access	0	0	0	0	2	0	2	0	0	0	1	0	5
2025 No Project Conditions	50	143	72	146	608	46	262	147	47	25	553	38	2137
2025 Project Background	50	139	72	145	584	43	252	147	47	25	546	38	2088
2025 No Project Drive Access	0	0	0	0	-2	0	-2	0	0	0	-1	0	-5
2025 Project Drive Access	3	1	15	99	2	0	0	21	0	0	0	81	222
Change in Bkgrd (car-->BART)	0	-4	0	-1	-22	-3	-8	0	0	0	-6	0	-44
2025 Net Project Trips	3	-3	15	98	-22	-3	-10	21	0	0	-7	81	173
2025 Project Conditions	53	140	87	244	586	43	252	168	47	25	546	119	2310
2035													
2035 No Project Background	73	194	71	141	606	46	279	147	55	30	608	50	2300
2035 No Project Drive Access	0	0	0	0	2	0	4	0	0	0	5	0	11
2035 No Project Conditions	73	194	71	141	608	46	283	147	55	30	613	50	2311
2035 Project Background	73	189	71	140	585	43	269	147	54	30	600	50	2251
2035 No Project Drive Access	0	0	0	0	-2	0	-4	0	0	0	-5	0	-11
2035 Project Drive Access	4	3	18	106	1	0	0	33	0	0	0	123	288
Change in Bkgrd (car-->BART)	0	-5	0	-1	-21	-3	-10	0	-1	0	-8	0	-49
2035 Net Project Trips	4	-2	18	105	-22	-3	-14	33	-1	0	-13	123	228
2035 Project Conditions	77	192	89	246	586	43	269	180	54	30	600	173	2539

Intersection Number: 10
 Traffic Node #: 3023
 Model Node #: 8517
 Intersection Name: US-101 SB and Santa Clara St *
 Peak Hour: AM

Date of Analysis: 06/15/15
 Count Date: 10/09/14

Scenario:	Movements												Total:
	North Approach			East Approach			South Approach			West Approach			
	RT	TH	LT	RT	TH	LT	RT	TH	LT	RT	TH	LT	
Existing Conditions	123	0	161	0	647	288	0	0	0	350	442	0	2011
Project Trips	-2	0	-2	0	63	-2	0	0	0	0	-6	0	51
Existing Plus Project Conditions	121	0	159	0	710	286	0	0	0	350	436	0	2062
2025													
2025 No Project Background	146	0	176	0	647	441	0	0	0	401	532	0	2343
2025 No Project Drive Access	0	0	0	0	2	4	0	0	0	0	3	0	9
2025 No Project Conditions	146	0	176	0	649	445	0	0	0	401	535	0	2352
2025 Project Background	144	0	174	0	623	429	0	0	0	397	522	0	2289
2025 No Project Drive Access	0	0	0	0	-2	-4	0	0	0	0	-3	0	-9
2025 Project Drive Access	5	0	0	0	96	1	0	0	0	15	0	0	117
Change in Bkgrd (car-->BART)	-2	0	-2	0	-24	-12	0	0	0	-4	-10	0	-54
2025 Net Project Trips	3	0	-2	0	70	-15	0	0	0	11	-13	0	54
2025 Project Conditions	149	0	174	0	719	430	0	0	0	412	522	0	2406
2035													
2035 No Project Background	139	0	214	0	647	459	0	0	0	451	559	0	2469
2035 No Project Drive Access	0	0	0	0	2	9	0	0	0	0	8	0	19
2035 No Project Conditions	139	0	214	0	649	468	0	0	0	451	567	0	2488
2035 Project Background	137	0	211	0	625	450	0	0	0	444	547	0	2414
2035 No Project Drive Access	0	0	0	0	-2	-9	0	0	0	0	-8	0	-19
2035 Project Drive Access	1	0	0	0	106	1	0	0	0	17	1	0	126
Change in Bkgrd (car-->BART)	-2	0	-3	0	-22	-9	0	0	0	-7	-12	0	-55
2035 Net Project Trips	-1	0	-3	0	82	-17	0	0	0	10	-19	0	52
2035 Project Conditions	138	0	211	0	731	451	0	0	0	461	548	0	2540

Intersection Number: 11
 Traffix Node #: 3016
 Model Node #: 8514
 Intersection Name: US-101 NB and Santa Clara St *
 Peak Hour: AM

Date of Analysis: 06/15/15
 Count Date: 10/09/14

Scenario:	Movements												Total:
	North Approach			East Approach			South Approach			West Approach			
	RT	TH	LT	RT	TH	LT	RT	TH	LT	RT	TH	LT	
Existing Conditions	0	0	0	278	704	0	45	1	198	0	375	197	1798
Project Trips	0	0	0	-2	-7	0	3	0	69	0	-2	-6	55
Existing Plus Project Conditions	0	0	0	276	697	0	48	1	267	0	373	191	1853
2025													
2025 No Project Background	0	0	0	278	902	0	137	1	198	0	411	267	2194
2025 No Project Drive Access	0	0	0	1	7	0	12	0	0	0	0	2	22
2025 No Project Conditions	0	0	0	279	909	0	149	1	198	0	411	269	2216
2025 Project Background	0	0	0	268	872	0	133	1	193	0	408	259	2134
2025 No Project Drive Access	0	0	0	-1	-7	0	-12	0	0	0	0	-2	-22
2025 Project Drive Access	0	0	0	2	20	0	7	0	77	0	0	0	106
Change in Bkgrd (car-->BART)	0	0	0	-10	-30	0	-4	0	-5	0	-3	-8	-60
2025 Net Project Trips	0	0	0	-9	-17	0	-9	0	72	0	-3	-10	24
2025 Project Conditions	0	0	0	270	892	0	140	1	270	0	408	259	2240
2035													
2035 No Project Background	0	0	0	278	997	0	182	1	198	0	477	266	2399
2035 No Project Drive Access	0	0	0	0	11	0	26	0	0	0	0	7	44
2035 No Project Conditions	0	0	0	278	1008	0	208	1	198	0	477	273	2443
2035 Project Background	0	0	0	275	967	0	180	1	197	0	472	257	2349
2035 No Project Drive Access	0	0	0	0	-11	0	-26	0	0	0	0	-7	-44
2035 Project Drive Access	0	0	0	0	27	0	4	0	81	0	1	0	113
Change in Bkgrd (car-->BART)	0	0	0	-3	-30	0	-2	0	-1	0	-5	-9	-50
2035 Net Project Trips	0	0	0	-3	-14	0	-24	0	80	0	-4	-16	19
2035 Project Conditions	0	0	0	275	994	0	184	1	278	0	473	257	2462

Intersection Number: 12
 Traffix Node #: 3762
 Model Node #: 8523
 Intersection Name: 24th St and San Antonio St
 Peak Hour: AM

Date of Analysis: 06/15/15
 Count Date: 10/09/14

Scenario:	Movements												Total:
	North Approach			East Approach			South Approach			West Approach			
	RT	TH	LT	RT	TH	LT	RT	TH	LT	RT	TH	LT	
Existing Conditions	27	146	9	36	253	117	110	438	65	22	89	5	1317
Project Trips	-2	-2	0	-1	0	0	2	24	0	0	0	1	22
Existing Plus Project Conditions	25	144	9	35	253	117	112	462	65	22	89	6	1339
2025													
2025 No Project Background	73	201	10	36	337	117	119	438	111	22	93	9	1566
2025 No Project Drive Access	0	0	0	1	0	0	0	9	0	0	0	1	11
2025 No Project Conditions	73	201	10	37	337	117	119	447	111	22	93	10	1577
2025 Project Background	69	197	10	33	334	117	119	426	108	22	93	9	1537
2025 No Project Drive Access	0	0	0	-1	0	0	0	-9	0	0	0	-1	-11
2025 Project Drive Access	1	1	0	1	0	0	0	46	0	0	0	1	50
Change in Bkgrd (car-->BART)	-4	-4	0	-3	-3	0	0	-12	-3	0	0	0	-29
2025 Net Project Trips	-3	-3	0	-3	-3	0	0	25	-3	0	0	0	10
2025 Project Conditions	70	198	10	34	334	117	119	472	108	22	93	10	1587
2035													
2035 No Project Background	27	274	10	36	410	119	110	438	118	23	92	25	1682
2035 No Project Drive Access	0	1	0	1	2	0	0	12	0	0	0	1	17
2035 No Project Conditions	27	275	10	37	412	119	110	450	118	23	92	26	1699
2035 Project Background	24	267	10	35	403	119	110	426	116	23	92	23	1648
2035 No Project Drive Access	0	-1	0	-1	-2	0	0	-12	0	0	0	-1	-17
2035 Project Drive Access	1	2	0	1	2	0	0	62	0	0	0	4	72
Change in Bkgrd (car-->BART)	-3	-7	0	-1	-7	0	0	-12	-2	0	0	-2	-34
2035 Net Project Trips	-2	-6	0	-1	-7	0	0	38	-2	0	0	1	21
2035 Project Conditions	25	269	10	36	405	119	110	488	116	23	92	27	1720

Intersection Number: 13
 Traffic Node #: 3832
 Model Node #: 8521
 Intersection Name: 24th St and E William St
 Peak Hour: AM

Date of Analysis: 06/15/15
 Count Date: 10/09/14

Scenario:	Movements												Total:
	North Approach			East Approach			South Approach			West Approach			
	RT	TH	LT	RT	TH	LT	RT	TH	LT	RT	TH	LT	
Existing Conditions	49	273	3	5	34	45	38	566	112	123	22	51	1321
Project Trips	0	-1	0	-5	0	-2	-1	30	0	0	0	0	21
Existing Plus Project Conditions	49	272	3	0	34	43	37	596	112	123	22	51	1342
2025													
2025 No Project Background	74	299	6	13	65	45	38	566	125	139	45	51	1466
2025 No Project Drive Access	0	0	0	1	0	0	0	8	0	0	0	0	9
2025 No Project Conditions	74	299	6	14	65	45	38	574	125	139	45	51	1475
2025 Project Background	73	297	5	9	64	41	35	556	125	139	44	51	1439
2025 No Project Drive Access	0	0	0	-1	0	0	0	-8	0	0	0	0	-9
2025 Project Drive Access	0	0	0	0	0	0	0	46	0	0	0	0	46
Change in Bkgrd (car-->BART)	-1	-2	-1	-4	-1	-4	-3	-10	0	0	-1	0	-27
2025 Net Project Trips	-1	-2	-1	-5	-1	-4	-3	28	0	0	-1	0	10
2025 Project Conditions	73	297	5	9	64	41	35	602	125	139	44	51	1485
2035													
2035 No Project Background	105	337	15	34	80	45	43	566	139	131	53	51	1599
2035 No Project Drive Access	0	1	0	1	0	0	0	11	0	0	0	0	13
2035 No Project Conditions	105	338	15	35	80	45	43	577	139	131	53	51	1612
2035 Project Background	102	333	13	28	77	41	42	559	139	131	52	51	1568
2035 No Project Drive Access	0	-1	0	-1	0	0	0	-11	0	0	0	0	-13
2035 Project Drive Access	1	1	0	1	0	0	0	61	0	0	0	0	64
Change in Bkgrd (car-->BART)	-3	-4	-2	-6	-3	-4	-1	-7	0	0	-1	0	-31
2035 Net Project Trips	-2	-4	-2	-6	-3	-4	-1	43	0	0	-1	0	20
2035 Project Conditions	103	334	13	29	77	41	42	620	139	131	52	51	1632

Intersection Number: 14
 Traffic Node #: 3036
 Model Node #: 60617
 Intersection Name: McLaughlin Ave and I-280 SB *
 Peak Hour: AM

Date of Analysis: 06/15/15
 Count Date: 10/09/14

Scenario:	Movements												Total:
	North Approach			East Approach			South Approach			West Approach			
	RT	TH	LT	RT	TH	LT	RT	TH	LT	RT	TH	LT	
Existing Conditions	0	542	0	0	0	0	0	1453	0	234	0	193	2422
Project Trips	0	0	0	0	0	0	0	14	0	-1	0	11	24
Existing Plus Project Conditions	0	542	0	0	0	0	0	1467	0	233	0	204	2446
2025													
2025 No Project Background	0	559	0	0	0	0	0	1487	0	264	0	193	2503
2025 No Project Drive Access	0	0	0	0	0	0	0	12	0	1	0	0	13
2025 No Project Conditions	0	559	0	0	0	0	0	1499	0	265	0	193	2516
2025 Project Background	0	558	0	0	0	0	0	1455	0	261	0	190	2464
2025 No Project Drive Access	0	0	0	0	0	0	0	-12	0	-1	0	0	-13
2025 Project Drive Access	0	0	0	0	0	0	0	40	0	1	0	9	50
Change in Bkgrd (car-->BART)	0	-1	0	0	0	0	0	-32	0	-3	0	-3	-39
2025 Net Project Trips	0	-1	0	0	0	0	0	-4	0	-3	0	6	-2
2025 Project Conditions	0	558	0	0	0	0	0	1495	0	262	0	199	2514
2035													
2035 No Project Background	0	572	0	0	0	0	0	1472	0	358	0	193	2595
2035 No Project Drive Access	0	0	0	0	0	0	0	14	0	1	0	0	15
2035 No Project Conditions	0	572	0	0	0	0	0	1486	0	359	0	193	2610
2035 Project Background	0	571	0	0	0	0	0	1457	0	355	0	191	2574
2035 No Project Drive Access	0	0	0	0	0	0	0	-14	0	-1	0	0	-15
2035 Project Drive Access	0	0	0	0	0	0	0	56	0	1	0	8	65
Change in Bkgrd (car-->BART)	0	-1	0	0	0	0	0	-15	0	-3	0	-2	-21
2035 Net Project Trips	0	-1	0	0	0	0	0	27	0	-3	0	6	29
2035 Project Conditions	0	571	0	0	0	0	0	1513	0	356	0	199	2639

Intersection Number: 15
 Trafix Node #: 3683
 Model Node #: 7968
 Intersection Name: McLaughlin Ave and Story Rd
 Peak Hour: AM

Date of Analysis: 06/15/15
 Count Date: 10/09/14

Scenario:	Movements												Total:
	North Approach			East Approach			South Approach			West Approach			
	RT	TH	LT	RT	TH	LT	RT	TH	LT	RT	TH	LT	
Existing Conditions	229	359	159	318	1229	240	189	843	165	44	666	325	4766
Project Trips	0	0	0	-1	-2	0	-6	9	0	0	0	6	6
Existing Plus Project Conditions	229	359	159	317	1227	240	183	852	165	44	666	331	4772
2025													
2025 No Project Background	261	361	170	348	1443	246	190	843	198	51	759	392	5262
2025 No Project Drive Access	0	1	0	2	8	2	8	8	0	0	3	2	34
2025 No Project Conditions	261	362	170	350	1451	248	198	851	198	51	762	394	5296
2025 Project Background	261	359	170	336	1423	243	181	826	195	51	755	389	5189
2025 No Project Drive Access	0	-1	0	-2	-8	-2	-8	-8	0	0	-3	-2	-34
2025 Project Drive Access	0	1	0	2	4	2	5	22	0	0	2	16	54
Change in Bkgrd (car-->BART)	0	-2	0	-12	-20	-3	-9	-17	-3	0	-4	-3	-73
2025 Net Project Trips	0	-2	0	-12	-24	-3	-12	-3	-3	0	-5	11	-53
2025 Project Conditions	261	360	170	338	1427	245	186	848	195	51	757	405	5243
2035													
2035 No Project Background	293	382	226	475	1416	250	276	843	221	50	806	370	5608
2035 No Project Drive Access	0	1	0	2	9	2	13	9	1	0	3	3	43
2035 No Project Conditions	293	383	226	477	1425	252	289	852	222	50	809	373	5651
2035 Project Background	292	380	225	468	1403	248	268	837	219	50	804	368	5562
2035 No Project Drive Access	0	-1	0	-2	-9	-2	-13	-9	-1	0	-3	-3	-43
2035 Project Drive Access	0	1	0	5	3	3	6	31	1	0	2	22	74
Change in Bkgrd (car-->BART)	-1	-2	-1	-7	-13	-2	-8	-6	-2	0	-2	-2	-46
2035 Net Project Trips	-1	-2	-1	-4	-19	-1	-15	16	-2	0	-3	17	-15
2035 Project Conditions	292	381	225	473	1406	251	274	868	220	50	806	390	5636

Intersection Number: 16
 Trafix Node #: 3058
 Model Node #: 4148
 Intersection Name: The Alameda and Taylor St *
 Peak Hour: AM

Date of Analysis: 06/15/15
 Count Date: 10/07/14

Scenario:	Movements												Total:
	North Approach			East Approach			South Approach			West Approach			
	RT	TH	LT	RT	TH	LT	RT	TH	LT	RT	TH	LT	
Existing Conditions	45	489	156	198	325	73	33	1250	131	82	422	170	3374
Project Trips	0	-3	-3	-6	-1	0	0	-15	3	0	2	-1	-24
Existing Plus Project Conditions	45	486	153	192	324	73	33	1235	134	82	424	169	3350
2025													
2025 No Project Background	60	588	291	198	748	76	43	1293	197	135	537	185	4351
2025 No Project Drive Access	0	1	0	0	0	0	0	2	0	1	0	1	5
2025 No Project Conditions	60	589	291	198	748	76	43	1295	197	136	537	186	4356
2025 Project Background	60	574	279	191	735	76	43	1270	194	135	533	185	4275
2025 No Project Drive Access	0	-1	0	0	0	0	0	-2	0	-1	0	-1	-5
2025 Project Drive Access	0	2	0	0	2	0	0	2	4	5	1	0	16
Change in Bkgrd (car-->BART)	0	-14	-12	-7	-13	0	0	-23	-3	0	-4	0	-76
2025 Net Project Trips	0	-13	-12	-7	-11	0	0	-23	1	4	-3	-1	-65
2025 Project Conditions	60	576	279	191	737	76	43	1272	198	140	534	185	4291
2035													
2035 No Project Background	49	674	355	198	823	75	33	1348	218	156	638	170	4737
2035 No Project Drive Access	0	1	0	0	1	0	0	2	0	2	0	1	7
2035 No Project Conditions	49	675	355	198	824	75	33	1350	218	158	638	171	4744
2035 Project Background	49	653	336	193	813	75	33	1330	216	156	634	169	4657
2035 No Project Drive Access	0	-1	0	0	-1	0	0	-2	0	-2	0	-1	-7
2035 Project Drive Access	0	3	0	0	2	0	0	2	4	8	2	0	21
Change in Bkgrd (car-->BART)	0	-21	-19	-5	-10	0	0	-18	-2	0	-4	-1	-80
2035 Net Project Trips	0	-19	-19	-5	-9	0	0	-18	2	6	-2	-2	-66
2035 Project Conditions	49	656	336	193	815	75	33	1332	220	164	636	169	4678

Intersection Number: 17
 Traffic Node #: 3608
 Model Node #: 8592
 Intersection Name: Stockton Ave and Julian St
 Peak Hour: AM

Date of Analysis: 06/15/15
 Count Date: 10/07/14

Scenario:	Movements												Total:
	North Approach			East Approach			South Approach			West Approach			
	RT	TH	LT	RT	TH	LT	RT	TH	LT	RT	TH	LT	
Existing Conditions	34	126	160	335	122	51	40	340	14	31	143	42	1438
Project Trips	0	-1	-1	-1	-2	0	0	-4	-1	0	-1	-1	-12
Existing Plus Project Conditions	34	125	159	334	120	51	40	336	13	31	142	41	1426
2025													
2025 No Project Background	37	177	160	452	170	54	58	340	14	35	174	42	1713
2025 No Project Drive Access	0	1	0	0	0	0	0	1	0	1	0	0	3
2025 No Project Conditions	37	178	160	452	170	54	58	341	14	36	174	42	1716
2025 Project Background	37	171	159	449	167	54	58	330	13	35	173	42	1688
2025 No Project Drive Access	0	-1	0	0	0	0	0	-1	0	-1	0	0	-3
2025 Project Drive Access	0	1	0	0	0	0	1	1	0	1	1	0	5
Change in Bkgrd (car-->BART)	0	-6	-1	-3	-3	0	0	-10	-1	0	-1	0	-25
2025 Net Project Trips	0	-6	-1	-3	-3	0	1	-10	-1	0	0	0	-23
2025 Project Conditions	37	172	159	449	167	54	59	331	13	36	174	42	1693
2035													
2035 No Project Background	39	225	160	501	147	63	101	340	14	40	193	42	1865
2035 No Project Drive Access	0	1	0	0	0	0	0	1	0	1	0	0	3
2035 No Project Conditions	39	226	160	501	147	63	101	341	14	41	193	42	1868
2035 Project Background	39	213	157	497	145	63	99	330	13	40	191	42	1829
2035 No Project Drive Access	0	-1	0	0	0	0	0	-1	0	-1	0	0	-3
2035 Project Drive Access	0	2	0	0	0	0	1	2	0	1	1	0	7
Change in Bkgrd (car-->BART)	0	-12	-3	-4	-2	0	-2	-10	-1	0	-2	0	-36
2035 Net Project Trips	0	-11	-3	-4	-2	0	-1	-9	-1	0	-1	0	-32
2035 Project Conditions	39	215	157	497	145	63	100	332	13	41	192	42	1836

Intersection Number: 18
 Traffic Node #: 3606
 Model Node #: 4027
 Intersection Name: Montgomery St and Julian St
 Peak Hour: AM

Date of Analysis: 06/15/15
 Count Date: 10/07/14

Scenario:	Movements												Total:
	North Approach			East Approach			South Approach			West Approach			
	RT	TH	LT	RT	TH	LT	RT	TH	LT	RT	TH	LT	
Existing Conditions	32	4	28	62	438	15	11	8	59	7	312	19	995
Project Trips	0	0	0	0	-3	0	0	0	0	0	-1	0	-4
Existing Plus Project Conditions	32	4	28	62	435	15	11	8	59	7	311	19	991
2025													
2025 No Project Background	32	6	31	64	633	15	11	12	66	7	402	19	1298
2025 No Project Drive Access	0	0	0	0	0	0	0	0	0	0	0	0	0
2025 No Project Conditions	32	6	31	64	633	15	11	12	66	7	402	19	1298
2025 Project Background	32	6	31	64	627	15	11	12	66	7	399	19	1289
2025 No Project Drive Access	0	0	0	0	0	0	0	0	0	0	0	0	0
2025 Project Drive Access	0	0	0	0	0	0	0	0	0	0	1	0	1
Change in Bkgrd (car-->BART)	0	0	0	0	-6	0	0	0	0	0	-3	0	-9
2025 Net Project Trips	0	0	0	0	-6	0	0	0	0	0	-2	0	-8
2025 Project Conditions	32	6	31	64	627	15	11	12	66	7	400	19	1290
2035													
2035 No Project Background	32	4	28	66	669	15	11	8	65	49	449	19	1415
2035 No Project Drive Access	0	0	0	0	0	0	0	0	0	0	0	0	0
2035 No Project Conditions	32	4	28	66	669	15	11	8	65	49	449	19	1415
2035 Project Background	32	4	28	66	662	15	11	8	65	48	444	19	1402
2035 No Project Drive Access	0	0	0	0	0	0	0	0	0	0	0	0	0
2035 Project Drive Access	0	0	0	0	0	0	0	0	0	0	2	0	2
Change in Bkgrd (car-->BART)	0	0	0	0	-7	0	0	0	0	-1	-5	0	-13
2035 Net Project Trips	0	0	0	0	-7	0	0	0	0	-1	-3	0	-11
2035 Project Conditions	32	4	28	66	662	15	11	8	65	48	446	19	1404

Intersection Number: 19
 Traffic Node #: 3263
 Model Node #: 7570
 Intersection Name: Autumn St and Julian St
 Peak Hour: AM

Date of Analysis: 06/15/15
 Count Date: 10/07/14

Scenario:	Movements												Total:
	North Approach			East Approach			South Approach			West Approach			
	RT	TH	LT	RT	TH	LT	RT	TH	LT	RT	TH	LT	
Existing Conditions	14	6	7	47	421	42	85	15	86	6	330	7	1066
Project Trips	0	0	0	-1	-3	-2	-3	0	0	0	-1	0	-10
Existing Plus Project Conditions	14	6	7	46	418	40	82	15	86	6	329	7	1056
2025													
2025 No Project Background	19	139	460	204	613	191	85	223	86	6	398	31	2455
2025 No Project Drive Access	0	0	0	0	0	12	3	0	0	0	0	0	15
2025 No Project Conditions	19	139	460	204	613	203	88	223	86	6	398	31	2470
2025 Project Background	19	137	446	195	607	183	80	218	86	6	395	31	2403
2025 No Project Drive Access	0	0	0	0	0	-12	-3	0	0	0	0	0	-15
2025 Project Drive Access	0	0	0	0	0	11	5	0	0	0	1	0	17
Change in Bkgrd (car-->BART)	0	-2	-14	-9	-6	-8	-5	-5	0	0	-3	0	-52
2025 Net Project Trips	0	-2	-14	-9	-6	-9	-3	-5	0	0	-2	0	-50
2025 Project Conditions	19	137	446	195	607	194	85	218	86	6	396	31	2420
2035													
2035 No Project Background	20	204	437	151	649	298	85	255	86	6	423	48	2662
2035 No Project Drive Access	0	1	0	0	0	17	5	1	0	0	0	0	24
2035 No Project Conditions	20	205	437	151	649	315	90	256	86	6	423	48	2686
2035 Project Background	20	199	420	146	642	275	80	250	86	6	419	48	2591
2035 No Project Drive Access	0	-1	0	0	0	-17	-5	-1	0	0	0	0	-24
2035 Project Drive Access	0	1	0	0	0	15	6	0	0	0	2	0	24
Change in Bkgrd (car-->BART)	0	-5	-17	-5	-7	-23	-5	-5	0	0	-4	0	-71
2035 Net Project Trips	0	-5	-17	-5	-7	-25	-4	-6	0	0	-2	0	-71
2035 Project Conditions	20	200	420	146	642	290	86	250	86	6	421	48	2615

Intersection Number: 20
 Traffic Node #: 3014
 Model Node #: 8697
 Intersection Name: SR-87 [W] and Julian St *
 Peak Hour: AM

Date of Analysis: 06/15/15
 Count Date: 10/07/14

Scenario:	Movements												Total:
	North Approach			East Approach			South Approach			West Approach			
	RT	TH	LT	RT	TH	LT	RT	TH	LT	RT	TH	LT	
Existing Conditions	129	237	323	0	632	54	0	0	0	18	434	0	1827
Project Trips	-4	-16	-16	0	-5	0	0	0	0	0	-3	0	-44
Existing Plus Project Conditions	125	221	307	0	627	54	0	0	0	18	431	0	1783
2025													
2025 No Project Background	129	237	323	0	1084	64	0	0	0	185	632	0	2654
2025 No Project Drive Access	5	0	1	0	7	0	0	0	0	0	3	0	16
2025 No Project Conditions	134	237	324	0	1091	64	0	0	0	185	635	0	2670
2025 Project Background	122	228	316	0	1064	64	0	0	0	176	619	0	2589
2025 No Project Drive Access	-5	0	-1	0	-7	0	0	0	0	0	-3	0	-16
2025 Project Drive Access	5	0	0	0	5	0	0	0	0	0	6	0	16
Change in Bkgrd (car-->BART)	-7	-9	-7	0	-20	0	0	0	0	-9	-13	0	-65
2025 Net Project Trips	-7	-9	-8	0	-22	0	0	0	0	-9	-10	0	-65
2025 Project Conditions	127	228	316	0	1069	64	0	0	0	176	625	0	2605
2035													
2035 No Project Background	129	237	323	0	1160	54	0	0	0	217	617	0	2737
2035 No Project Drive Access	6	0	0	0	11	0	0	0	0	0	6	0	23
2035 No Project Conditions	135	237	323	0	1171	54	0	0	0	217	623	0	2760
2035 Project Background	115	229	317	0	1136	54	0	0	0	206	602	0	2659
2035 No Project Drive Access	-6	0	0	0	-11	0	0	0	0	0	-6	0	-23
2035 Project Drive Access	5	0	0	0	10	0	0	0	0	0	8	0	23
Change in Bkgrd (car-->BART)	-14	-8	-6	0	-24	0	0	0	0	-11	-15	0	-78
2035 Net Project Trips	-15	-8	-6	0	-25	0	0	0	0	-11	-13	0	-78
2035 Project Conditions	120	229	317	0	1146	54	0	0	0	206	610	0	2682

Intersection Number: 21
 Traffix Node #: 3013
 Model Node #: 8683
 Intersection Name: SR-87 [E] and Julian St *
 Peak Hour: AM

Date of Analysis: 06/15/15
 Count Date: 10/07/14

Scenario:	Movements												Total:
	North Approach			East Approach			South Approach			West Approach			
	RT	TH	LT	RT	TH	LT	RT	TH	LT	RT	TH	LT	
Existing Conditions	511	2	351	88	482	0	76	393	130	0	500	80	2613
Project Trips	4	0	-1	-1	-3	0	0	-14	-1	0	-13	-2	-31
Existing Plus Project Conditions	515	2	350	87	479	0	76	379	129	0	487	78	2582
2025													
2025 No Project Background	535	2	513	215	566	0	154	393	151	0	500	80	3109
2025 No Project Drive Access	0	0	0	0	7	0	1	2	0	0	2	1	13
2025 No Project Conditions	535	2	513	215	573	0	155	395	151	0	502	81	3122
2025 Project Background	521	2	504	207	556	0	154	383	146	0	490	77	3040
2025 No Project Drive Access	0	0	0	0	-7	0	-1	-2	0	0	-2	-1	-13
2025 Project Drive Access	14	0	0	0	5	0	0	0	0	0	6	0	25
Change in Bkgrd (car-->BART)	-14	0	-9	-8	-10	0	0	-10	-5	0	-10	-3	-69
2025 Net Project Trips	0	0	-9	-8	-12	0	-1	-12	-5	0	-6	-4	-57
2025 Project Conditions	535	2	504	207	561	0	154	383	146	0	496	77	3065
2035													
2035 No Project Background	650	2	423	223	670	0	132	393	196	0	500	80	3269
2035 No Project Drive Access	1	0	1	0	10	0	0	2	0	0	3	2	19
2035 No Project Conditions	651	2	424	223	680	0	132	395	196	0	503	82	3288
2035 Project Background	636	2	420	217	652	0	131	383	192	0	488	79	3200
2035 No Project Drive Access	-1	0	-1	0	-10	0	0	-2	0	0	-3	-2	-19
2035 Project Drive Access	19	0	1	0	9	0	1	0	0	0	8	0	38
Change in Bkgrd (car-->BART)	-14	0	-3	-6	-18	0	-1	-10	-4	0	-12	-1	-69
2035 Net Project Trips	4	0	-3	-6	-19	0	0	-12	-4	0	-7	-3	-50
2035 Project Conditions	655	2	421	217	661	0	132	383	192	0	496	79	3238

Intersection Number: 22
 Traffix Node #: 3227
 Model Node #: 8612
 Intersection Name: The Alameda and Julian St
 Peak Hour: AM

Date of Analysis: 06/15/15
 Count Date: 10/07/14

Scenario:	Movements												Total:
	North Approach			East Approach			South Approach			West Approach			
	RT	TH	LT	RT	TH	LT	RT	TH	LT	RT	TH	LT	
Existing Conditions	0	490	92	189	0	53	59	1400	0	0	0	0	2283
Project Trips	0	-2	-1	-1	0	0	0	-11	0	0	0	0	-15
Existing Plus Project Conditions	0	488	91	188	0	53	59	1389	0	0	0	0	2268
2025													
2025 No Project Background	0	652	123	189	0	87	59	1547	0	0	0	0	2657
2025 No Project Drive Access	0	3	0	0	0	0	0	1	0	0	0	0	4
2025 No Project Conditions	0	655	123	189	0	87	59	1548	0	0	0	0	2661
2025 Project Background	0	639	121	188	0	87	59	1522	0	0	0	0	2616
2025 No Project Drive Access	0	-3	0	0	0	0	0	-1	0	0	0	0	-4
2025 Project Drive Access	0	7	0	0	0	0	0	6	0	0	0	0	13
Change in Bkgrd (car-->BART)	0	-13	-2	-1	0	0	0	-25	0	0	0	0	-41
2025 Net Project Trips	0	-9	-2	-1	0	0	0	-20	0	0	0	0	-32
2025 Project Conditions	0	646	121	188	0	87	59	1528	0	0	0	0	2629
2035													
2035 No Project Background	0	764	130	189	0	109	59	1619	0	0	0	0	2870
2035 No Project Drive Access	0	4	0	0	0	0	0	2	0	0	0	0	6
2035 No Project Conditions	0	768	130	189	0	109	59	1621	0	0	0	0	2876
2035 Project Background	0	744	129	188	0	109	59	1600	0	0	0	0	2829
2035 No Project Drive Access	0	-4	0	0	0	0	0	-2	0	0	0	0	-6
2035 Project Drive Access	0	11	0	0	0	0	0	7	0	0	0	0	18
Change in Bkgrd (car-->BART)	0	-20	-1	-1	0	0	0	-19	0	0	0	0	-41
2035 Net Project Trips	0	-13	-1	-1	0	0	0	-14	0	0	0	0	-29
2035 Project Conditions	0	755	129	188	0	109	59	1607	0	0	0	0	2847

Intersection Number: 23
 Traffic Node #: 3059
 Model Node #: 8613
 Intersection Name: Race St and The Alameda *
 Peak Hour: AM

Date of Analysis: 06/15/15
 Count Date: 10/07/14

Scenario:	Movements												Total:
	North Approach			East Approach			South Approach			West Approach			
	RT	TH	LT	RT	TH	LT	RT	TH	LT	RT	TH	LT	
Existing Conditions	1	16	41	0	627	136	48	718	7	240	307	0	2141
Project Trips	0	0	0	0	-7	0	0	-3	0	0	-1	0	-11
Existing Plus Project Conditions	1	16	41	0	620	136	48	715	7	240	306	0	2130
2025													
2025 No Project Background	1	25	45	0	743	177	50	744	7	304	438	0	2534
2025 No Project Drive Access	0	0	0	0	0	0	0	1	0	0	2	0	3
2025 No Project Conditions	1	25	45	0	743	177	50	745	7	304	440	0	2537
2025 Project Background	1	25	45	0	723	177	50	739	7	303	428	0	2498
2025 No Project Drive Access	0	0	0	0	0	0	0	-1	0	0	-2	0	-3
2025 Project Drive Access	0	0	0	0	6	2	1	0	0	0	7	0	16
Change in Bkgrd (car->BART)	0	0	0	0	-20	0	0	-5	0	-1	-10	0	-36
2025 Net Project Trips	0	0	0	0	-14	2	1	-6	0	-1	-5	0	-23
2025 Project Conditions	1	25	45	0	729	179	51	739	7	303	435	0	2514
2035													
2035 No Project Background	1	32	48	0	839	223	62	718	11	341	536	0	2811
2035 No Project Drive Access	0	1	0	0	0	1	0	1	0	0	3	0	6
2035 No Project Conditions	1	33	48	0	839	224	62	719	11	341	539	0	2817
2035 Project Background	1	32	48	0	823	223	61	715	11	341	517	0	2772
2035 No Project Drive Access	0	-1	0	0	0	-1	0	-1	0	0	-3	0	-6
2035 Project Drive Access	0	1	0	0	7	3	1	0	0	0	11	0	23
Change in Bkgrd (car->BART)	0	0	0	0	-16	0	-1	-3	0	0	-19	0	-39
2035 Net Project Trips	0	0	0	0	-9	2	0	-4	0	0	-11	0	-22
2035 Project Conditions	1	33	48	0	830	226	62	715	11	341	528	0	2795

Intersection Number: 24
 Traffic Node #: 3230
 Model Node #: 6629
 Intersection Name: Stockton Ave and The Alameda
 Peak Hour: AM

Date of Analysis: 06/15/15
 Count Date: 10/07/14

Scenario:	Movements												Total:
	North Approach			East Approach			South Approach			West Approach			
	RT	TH	LT	RT	TH	LT	RT	TH	LT	RT	TH	LT	
Existing Conditions	72	1	111	273	656	0	3	1	0	2	346	179	1644
Project Trips	-2	0	0	-2	-4	0	0	0	0	0	-2	-2	-12
Existing Plus Project Conditions	70	1	111	271	652	0	3	1	0	2	344	177	1632
2025													
2025 No Project Background	135	1	111	273	849	0	3	1	0	2	420	241	2036
2025 No Project Drive Access	0	0	1	1	1	0	0	0	0	0	3	0	6
2025 No Project Conditions	135	1	112	274	850	0	3	1	0	2	423	241	2042
2025 Project Background	129	1	110	266	833	0	3	1	0	2	409	236	1990
2025 No Project Drive Access	0	0	-1	-1	-1	0	0	0	0	0	-3	0	-6
2025 Project Drive Access	0	0	2	1	8	0	0	0	0	0	8	1	20
Change in Bkgrd (car->BART)	-6	0	-1	-7	-16	0	0	0	0	0	-11	-5	-46
2025 Net Project Trips	-6	0	0	-7	-9	0	0	0	0	0	-6	-4	-32
2025 Project Conditions	129	1	112	267	841	0	3	1	0	2	417	237	2010
2035													
2035 No Project Background	176	1	126	273	900	0	3	1	0	2	483	358	2323
2035 No Project Drive Access	0	0	2	1	1	0	0	0	0	0	7	0	11
2035 No Project Conditions	176	1	128	274	901	0	3	1	0	2	490	358	2334
2035 Project Background	164	1	125	270	887	0	3	1	0	2	467	350	2270
2035 No Project Drive Access	0	0	-2	-1	-1	0	0	0	0	0	-7	0	-11
2035 Project Drive Access	0	0	3	3	10	0	0	0	0	0	15	1	32
Change in Bkgrd (car->BART)	-12	0	-1	-3	-13	0	0	0	0	0	-16	-8	-53
2035 Net Project Trips	-12	0	0	-1	-4	0	0	0	0	0	-8	-7	-32
2035 Project Conditions	164	1	128	273	897	0	3	1	0	2	482	351	2302

Intersection Number: 25
 Traffic Node #: 3363
 Model Node #: 6632
 Intersection Name: Cahill St and Santa Clara St
 Peak Hour: AM

Date of Analysis: 06/15/15
 Count Date: 10/07/14

Scenario:	Movements												Total:
	North Approach			East Approach			South Approach			West Approach			
	RT	TH	LT	RT	TH	LT	RT	TH	LT	RT	TH	LT	
Existing Conditions	1	0	0	10	884	97	52	9	79	54	390	0	1576
Project Trips	0	0	0	0	-10	4	-1	0	4	2	-5	0	-6
Existing Plus Project Conditions	1	0	0	10	874	101	51	9	83	56	385	0	1570
2025													
2025 No Project Background	1	0	0	10	970	97	52	9	79	54	466	0	1738
2025 No Project Drive Access	0	0	0	0	0	2	2	0	1	3	2	0	10
2025 No Project Conditions	1	0	0	10	970	99	54	9	80	57	468	0	1748
2025 Project Background	1	0	0	10	947	97	52	9	79	54	454	0	1703
2025 No Project Drive Access	0	0	0	0	0	-2	-2	0	-1	-3	-2	0	-10
2025 Project Drive Access	0	0	0	0	0	3	2	0	9	8	2	0	24
Change in Bkgrd (car-->BART)	0	0	0	0	-23	0	0	0	0	0	-12	0	-35
2025 Net Project Trips	0	0	0	0	-23	1	0	0	8	5	-12	0	-21
2025 Project Conditions	1	0	0	10	947	100	54	9	88	62	456	0	1727
2035													
2035 No Project Background	1	0	0	10	952	97	52	9	79	54	547	0	1801
2035 No Project Drive Access	0	0	0	0	0	3	3	0	2	6	3	0	17
2035 No Project Conditions	1	0	0	10	952	100	55	9	81	60	550	0	1818
2035 Project Background	1	0	0	10	934	97	52	9	79	54	531	0	1767
2035 No Project Drive Access	0	0	0	0	0	-3	-3	0	-2	-6	-3	0	-17
2035 Project Drive Access	0	0	0	0	0	6	3	0	12	15	3	0	39
Change in Bkgrd (car-->BART)	0	0	0	0	-18	0	0	0	0	0	-16	0	-34
2035 Net Project Trips	0	0	0	0	-18	3	0	0	10	9	-16	0	-12
2035 Project Conditions	1	0	0	10	934	103	55	9	91	69	534	0	1806

Intersection Number: 26
 Traffic Node #: 3112
 Model Node #: 8588
 Intersection Name: Montgomery St and Santa Clara St *
 Peak Hour: AM

Date of Analysis: 06/15/15
 Count Date: 10/07/14

Scenario:	Movements												Total:
	North Approach			East Approach			South Approach			West Approach			
	RT	TH	LT	RT	TH	LT	RT	TH	LT	RT	TH	LT	
Existing Conditions	0	0	0	0	988	187	0	0	0	85	363	0	1623
Project Trips	0	0	0	0	-6	-2	0	0	0	1	-7	0	-14
Existing Plus Project Conditions	0	0	0	0	982	185	0	0	0	86	356	0	1609
2025													
2025 No Project Background	0	0	0	0	1026	17	59	0	45	8	507	0	1662
2025 No Project Drive Access	0	0	0	0	2	17	1	0	0	2	2	0	24
2025 No Project Conditions	0	0	0	0	1028	34	60	0	45	10	509	0	1686
2025 Project Background	0	0	0	0	1004	16	56	0	45	8	495	0	1624
2025 No Project Drive Access	0	0	0	0	-2	-17	-1	0	0	-2	-2	0	-24
2025 Project Drive Access	0	0	0	0	3	16	1	0	0	2	2	0	24
Change in Bkgrd (car-->BART)	0	0	0	0	-22	-1	-3	0	0	0	-12	0	-38
2025 Net Project Trips	0	0	0	0	-21	-2	-3	0	0	0	-12	0	-38
2025 Project Conditions	0	0	0	0	1007	32	57	0	45	10	497	0	1648
2035													
2035 No Project Background	0	0	0	0	989	24	71	0	64	11	588	0	1747
2035 No Project Drive Access	0	0	0	0	3	22	1	0	0	3	3	0	32
2035 No Project Conditions	0	0	0	0	992	46	72	0	64	14	591	0	1779
2035 Project Background	0	0	0	0	972	22	66	0	64	11	572	0	1707
2035 No Project Drive Access	0	0	0	0	-3	-22	-1	0	0	-3	-3	0	-32
2035 Project Drive Access	0	0	0	0	6	20	1	0	0	3	3	0	33
Change in Bkgrd (car-->BART)	0	0	0	0	-17	-2	-5	0	0	0	-16	0	-40
2035 Net Project Trips	0	0	0	0	-14	-4	-5	0	0	0	-16	0	-39
2035 Project Conditions	0	0	0	0	978	42	67	0	64	14	575	0	1740

Intersection Number: 27
 Traffix Node #: 3066
 Model Node #: 7571
 Intersection Name: Autumn St and Santa Clara St *
 Peak Hour: AM

Date of Analysis: 06/15/15
 Count Date: 10/07/14

Scenario:	Movements												Total:
	North Approach			East Approach			South Approach			West Approach			
	RT	TH	LT	RT	TH	LT	RT	TH	LT	RT	TH	LT	
Existing Conditions	53	0	12	115	854	0	167	186	244	0	372	13	2016
Project Trips	-1	0	-1	0	-6	0	0	0	-2	0	-5	-2	-17
Existing Plus Project Conditions	52	0	11	115	848	0	167	186	242	0	367	11	1999
2025													
2025 No Project Background	53	226	37	186	854	220	167	333	244	87	474	41	2922
2025 No Project Drive Access	5	7	0	0	15	14	0	1	0	0	1	2	45
2025 No Project Conditions	58	233	37	186	869	234	167	334	244	87	475	43	2967
2025 Project Background	52	220	36	183	836	216	167	327	239	87	463	38	2864
2025 No Project Drive Access	-5	-7	0	0	-15	-14	0	-1	0	0	-1	-2	-45
2025 Project Drive Access	5	6	0	0	15	13	1	4	0	0	1	2	47
Change in Bkgrd (car-->BART)	-1	-6	-1	-3	-18	-4	0	-6	-5	0	-11	-3	-58
2025 Net Project Trips	-1	-7	-1	-3	-18	-5	1	-3	-5	0	-11	-3	-56
2025 Project Conditions	57	226	36	183	851	229	168	331	239	87	464	40	2911
2035													
2035 No Project Background	53	280	48	194	854	198	167	405	244	108	557	32	3140
2035 No Project Drive Access	7	12	0	0	19	14	0	2	0	0	1	2	57
2035 No Project Conditions	60	292	48	194	873	212	167	407	244	108	558	34	3197
2035 Project Background	51	263	47	192	840	191	167	400	242	108	540	28	3069
2035 No Project Drive Access	-7	-12	0	0	-19	-14	0	-2	0	0	-1	-2	-57
2035 Project Drive Access	7	10	0	0	19	13	0	5	0	0	1	2	57
Change in Bkgrd (car-->BART)	-2	-17	-1	-2	-14	-7	0	-5	-2	0	-17	-4	-71
2035 Net Project Trips	-2	-19	-1	-2	-14	-8	0	-2	-2	0	-17	-4	-71
2035 Project Conditions	58	273	47	192	859	204	167	405	242	108	541	30	3126

Intersection Number: 28
 Traffix Node #: 3015
 Model Node #: 8668
 Intersection Name: SR-87 NB and Santa Clara St *
 Peak Hour: AM

Date of Analysis: 06/15/15
 Count Date: 10/07/14

Scenario:	Movements												Total:
	North Approach			East Approach			South Approach			West Approach			
	RT	TH	LT	RT	TH	LT	RT	TH	LT	RT	TH	LT	
Existing Conditions	0	0	0	0	655	0	952	0	376	0	488	0	2471
Project Trips	0	0	0	0	-5	0	-16	0	-2	0	-3	0	-26
Existing Plus Project Conditions	0	0	0	0	650	0	936	0	374	0	485	0	2445
2025													
2025 No Project Background	0	0	0	0	829	0	952	0	376	0	510	0	2667
2025 No Project Drive Access	0	0	0	0	11	0	0	0	17	0	1	0	29
2025 No Project Conditions	0	0	0	0	840	0	952	0	393	0	511	0	2696
2025 Project Background	0	0	0	0	819	0	926	0	362	0	506	0	2613
2025 No Project Drive Access	0	0	0	0	-11	0	0	0	-17	0	-1	0	-29
2025 Project Drive Access	0	0	0	0	10	0	1	0	19	0	2	0	32
Change in Bkgrd (car-->BART)	0	0	0	0	-10	0	-26	0	-14	0	-4	0	-54
2025 Net Project Trips	0	0	0	0	-11	0	-25	0	-12	0	-3	0	-51
2025 Project Conditions	0	0	0	0	829	0	927	0	381	0	508	0	2645
2035													
2035 No Project Background	0	0	0	0	929	0	952	0	376	0	497	0	2754
2035 No Project Drive Access	0	0	0	0	13	0	0	0	20	0	1	0	34
2035 No Project Conditions	0	0	0	0	942	0	952	0	396	0	498	0	2788
2035 Project Background	0	0	0	0	914	0	929	0	367	0	492	0	2702
2035 No Project Drive Access	0	0	0	0	-13	0	0	0	-20	0	-1	0	-34
2035 Project Drive Access	0	0	0	0	12	0	2	0	20	0	1	0	35
Change in Bkgrd (car-->BART)	0	0	0	0	-15	0	-23	0	-9	0	-5	0	-52
2035 Net Project Trips	0	0	0	0	-16	0	-21	0	-9	0	-5	0	-51
2035 Project Conditions	0	0	0	0	926	0	931	0	387	0	493	0	2737

Intersection Number: 29
 Traffix Node #: 3710
 Model Node #: 6634
 Intersection Name: Montgomery St and San Fernando St
 Peak Hour: AM

Date of Analysis: 06/15/15
 Count Date: 10/07/14

Scenario:	Movements												Total:
	North Approach			East Approach			South Approach			West Approach			
	RT	TH	LT	RT	TH	LT	RT	TH	LT	RT	TH	LT	
Existing Conditions	7	181	25	0	148	99	0	0	0	94	50	0	604
Project Trips	-1	0	0	0	16	0	0	0	0	8	10	0	33
Existing Plus Project Conditions	6	181	25	0	164	99	0	0	0	102	60	0	637
2025													
2025 No Project Background	7	10	25	45	148	10	10	10	10	10	50	59	394
2025 No Project Drive Access	0	0	1	24	9	0	0	0	0	0	9	1	44
2025 No Project Conditions	7	10	26	69	157	10	10	10	10	10	59	60	438
2025 Project Background	6	10	25	45	148	10	10	10	10	10	50	56	390
2025 No Project Drive Access	0	0	-1	-24	-9	0	0	0	0	0	-9	-1	-44
2025 Project Drive Access	0	0	1	24	34	0	0	0	0	0	32	0	91
Change in Bkgrd (car-->BART)	-1	0	0	0	0	0	0	0	0	0	0	-3	-4
2025 Net Project Trips	-1	0	0	0	25	0	0	0	0	0	23	-4	43
2025 Project Conditions	6	10	26	69	182	10	10	10	10	10	82	56	481
2035													
2035 No Project Background	7	10	25	64	148	10	10	10	10	10	50	71	425
2035 No Project Drive Access	0	0	1	37	16	0	0	0	0	0	16	1	71
2035 No Project Conditions	7	10	26	101	164	10	10	10	10	10	66	72	496
2035 Project Background	5	10	25	64	148	10	10	10	10	10	50	66	418
2035 No Project Drive Access	0	0	-1	-37	-16	0	0	0	0	0	-16	-1	-71
2035 Project Drive Access	0	0	1	35	48	0	0	0	0	0	47	0	131
Change in Bkgrd (car-->BART)	-2	0	0	0	0	0	0	0	0	0	0	-5	-7
2035 Net Project Trips	-2	0	0	-2	32	0	0	0	0	0	31	-6	53
2035 Project Conditions	5	10	26	99	196	10	10	10	10	10	97	66	549

Intersection Number: 30
 Traffix Node #: 3264
 Model Node #: 6635
 Intersection Name: Autumn St and San Fernando St
 Peak Hour: AM

Date of Analysis: 06/15/15
 Count Date: 10/07/14

Scenario:	Movements												Total:
	North Approach			East Approach			South Approach			West Approach			
	RT	TH	LT	RT	TH	LT	RT	TH	LT	RT	TH	LT	
Existing Conditions	0	0	0	17	78	0	83	601	148	0	63	26	1016
Project Trips	0	0	0	-1	0	0	-1	-3	15	0	10	0	20
Existing Plus Project Conditions	0	0	0	16	78	0	82	598	163	0	73	26	1036
2025													
2025 No Project Background	10	446	6	26	78	51	114	704	174	84	63	26	1782
2025 No Project Drive Access	2	1	0	4	7	0	0	19	24	8	2	0	67
2025 No Project Conditions	12	447	6	30	85	51	114	723	198	92	65	26	1849
2025 Project Background	10	434	6	26	78	49	112	693	174	84	63	26	1755
2025 No Project Drive Access	-2	-1	0	-4	-7	0	0	-19	-24	-8	-2	0	-67
2025 Project Drive Access	2	1	0	4	7	0	0	23	49	21	12	0	119
Change in Bkgrd (car-->BART)	0	-12	0	0	0	-2	-2	-11	0	0	0	0	-27
2025 Net Project Trips	0	-12	0	0	0	-2	-2	-7	25	13	10	0	25
2025 Project Conditions	12	435	6	30	85	49	112	716	223	105	75	26	1874
2035													
2035 No Project Background	10	501	4	50	78	69	155	686	187	84	63	26	1913
2035 No Project Drive Access	3	2	0	7	11	0	0	31	40	14	3	0	111
2035 No Project Conditions	13	503	4	57	89	69	155	717	227	98	66	26	2024
2035 Project Background	10	476	4	50	78	64	152	678	187	84	63	26	1872
2035 No Project Drive Access	-3	-2	0	-7	-11	0	0	-31	-40	-14	-3	0	-111
2035 Project Drive Access	2	1	0	7	12	0	0	33	69	30	19	0	173
Change in Bkgrd (car-->BART)	0	-25	0	0	0	-5	-3	-8	0	0	0	0	-41
2035 Net Project Trips	-1	-26	0	0	1	-5	-3	-6	29	16	16	0	21
2035 Project Conditions	12	477	4	57	90	64	152	711	256	114	82	26	2045

Intersection Number: 31
 Trafix Node #: 3985
 Model Node #: 8726
 Intersection Name: Delmas Ave and San Fernando St
 Peak Hour: AM

Date of Analysis: 06/15/15
 Count Date: 10/07/14

Scenario:	Movements												Total:
	North Approach			East Approach			South Approach			West Approach			
	RT	TH	LT	RT	TH	LT	RT	TH	LT	RT	TH	LT	
Existing Conditions	17	35	3	43	67	17	0	0	0	22	156	24	384
Project Trips	0	-4	0	0	0	0	0	0	0	10	-1	0	5
Existing Plus Project Conditions	17	31	3	43	67	17	0	0	0	32	155	24	389
2025													
2025 No Project Background	49	101	21	116	91	25	0	0	0	27	181	29	640
2025 No Project Drive Access	0	0	0	0	9	0	0	0	0	1	1	0	11
2025 No Project Conditions	49	101	21	116	100	25	0	0	0	28	182	29	651
2025 Project Background	49	94	20	115	89	25	0	0	0	27	179	29	627
2025 No Project Drive Access	0	0	0	0	-9	0	0	0	0	-1	-1	0	-11
2025 Project Drive Access	0	0	0	0	10	0	0	0	0	12	1	0	23
Change in Bkgrd (car-->BART)	0	-7	-1	-1	-2	0	0	0	0	0	-2	0	-13
2025 Net Project Trips	0	-7	-1	-1	-1	0	0	0	0	11	-2	0	-1
2025 Project Conditions	49	94	20	115	99	25	0	0	0	39	180	29	650
2035													
2035 No Project Background	61	173	39	107	123	30	0	0	0	25	221	33	812
2035 No Project Drive Access	0	0	0	0	18	0	0	0	0	2	1	0	21
2035 No Project Conditions	61	173	39	107	141	30	0	0	0	27	222	33	833
2035 Project Background	61	164	36	106	118	30	0	0	0	25	218	33	791
2035 No Project Drive Access	0	0	0	0	-18	0	0	0	0	-2	-1	0	-21
2035 Project Drive Access	0	0	0	0	19	0	0	0	0	18	1	0	38
Change in Bkgrd (car-->BART)	0	-9	-3	-1	-5	0	0	0	0	0	-3	0	-21
2035 Net Project Trips	0	-9	-3	-1	-4	0	0	0	0	16	-3	0	-4
2035 Project Conditions	61	164	36	106	137	30	0	0	0	43	219	33	829

Intersection Number: 32
 Trafix Node #: 3709
 Model Node #: 8675
 Intersection Name: Montgomery St and Park Ave
 Peak Hour: AM

Date of Analysis: 06/15/15
 Count Date: 10/07/14

Scenario:	Movements												Total:
	North Approach			East Approach			South Approach			West Approach			
	RT	TH	LT	RT	TH	LT	RT	TH	LT	RT	TH	LT	
Existing Conditions	39	204	28	32	131	40	208	780	374	248	161	39	2284
Project Trips	0	7	0	0	0	0	-1	11	-1	0	0	0	16
Existing Plus Project Conditions	39	211	28	32	131	40	207	791	373	248	161	39	2300
2025													
2025 No Project Background	65	400	30	32	147	87	226	1078	376	250	169	39	2899
2025 No Project Drive Access	0	9	0	0	0	0	0	42	0	0	0	0	51
2025 No Project Conditions	65	409	30	32	147	87	226	1120	376	250	169	39	2950
2025 Project Background	65	397	30	32	147	86	223	1056	373	250	169	39	2867
2025 No Project Drive Access	0	-9	0	0	0	0	0	-42	0	0	0	0	-51
2025 Project Drive Access	0	21	0	0	0	0	0	70	0	0	0	0	91
Change in Bkgrd (car-->BART)	0	-3	0	0	0	-1	-3	-22	-3	0	0	0	-32
2025 Net Project Trips	0	9	0	0	0	-1	-3	6	-3	0	0	0	8
2025 Project Conditions	65	418	30	32	147	86	223	1126	373	250	169	39	2958
2035													
2035 No Project Background	64	478	32	36	192	124	267	1171	476	261	197	46	3344
2035 No Project Drive Access	0	14	0	0	0	0	1	67	0	0	0	1	83
2035 No Project Conditions	64	492	32	36	192	124	268	1238	476	261	197	47	3427
2035 Project Background	64	470	32	35	191	122	263	1128	473	260	197	46	3281
2035 No Project Drive Access	0	-14	0	0	0	0	-1	-67	0	0	0	-1	-83
2035 Project Drive Access	1	30	0	0	0	0	0	99	0	0	0	1	131
Change in Bkgrd (car-->BART)	0	-8	0	-1	-1	-2	-4	-43	-3	-1	0	0	-63
2035 Net Project Trips	1	8	0	-1	-1	-2	-5	-11	-3	-1	0	0	-15
2035 Project Conditions	65	500	32	35	191	122	263	1227	473	260	197	47	3412

Intersection Number: 33
 Traffic Node #: 3445
 Model Node #: 8719
 Intersection Name: Delmas Ave and Park Ave
 Peak Hour: AM

Date of Analysis: 06/15/15
 Count Date: 10/07/14

Scenario:	Movements												Total:
	North Approach			East Approach			South Approach			West Approach			
	RT	TH	LT	RT	TH	LT	RT	TH	LT	RT	TH	LT	
Existing Conditions	10	57	20	0	82	15	72	94	306	29	388	0	1073
Project Trips	0	9	-1	0	0	0	-1	-2	-4	0	-1	0	0
Existing Plus Project Conditions	10	66	19	0	82	15	71	92	302	29	387	0	1073
2025													
2025 No Project Background	10	169	34	0	124	15	72	156	312	32	388	0	1312
2025 No Project Drive Access	0	1	0	0	0	0	0	0	0	0	0	0	1
2025 No Project Conditions	10	170	34	0	124	15	72	156	312	32	388	0	1313
2025 Project Background	10	165	32	0	124	15	72	153	308	32	386	0	1297
2025 No Project Drive Access	0	-1	0	0	0	0	0	0	0	0	0	0	-1
2025 Project Drive Access	0	12	0	0	0	0	0	0	0	0	0	0	12
Change in Bkgrd (car->BART)	0	-4	-2	0	0	0	0	-3	-4	0	-2	0	-15
2025 Net Project Trips	0	7	-2	0	0	0	0	-3	-4	0	-2	0	-4
2025 Project Conditions	10	177	32	0	124	15	72	153	308	32	386	0	1309
2035													
2035 No Project Background	10	245	53	0	177	15	72	229	307	43	434	0	1585
2035 No Project Drive Access	0	2	0	0	0	0	0	0	0	0	1	0	3
2035 No Project Conditions	10	247	53	0	177	15	72	229	307	43	435	0	1588
2035 Project Background	10	239	48	0	176	15	72	226	303	43	432	0	1564
2035 No Project Drive Access	0	-2	0	0	0	0	0	0	0	0	-1	0	-3
2035 Project Drive Access	0	18	0	0	0	0	0	0	0	0	1	0	19
Change in Bkgrd (car->BART)	0	-6	-5	0	-1	0	0	-3	-4	0	-2	0	-21
2035 Net Project Trips	0	10	-5	0	-1	0	0	-3	-4	0	-2	0	-5
2035 Project Conditions	10	257	48	0	176	15	72	226	303	43	433	0	1583

Intersection Number: 34
 Traffic Node #: 3693
 Model Node #: 8652
 Intersection Name: Meridian Ave and San Carlos St
 Peak Hour: AM

Date of Analysis: 06/15/15
 Count Date: 10/07/14

Scenario:	Movements												Total:
	North Approach			East Approach			South Approach			West Approach			
	RT	TH	LT	RT	TH	LT	RT	TH	LT	RT	TH	LT	
Existing Conditions	59	215	95	44	829	110	264	622	317	82	339	62	3038
Project Trips	0	0	0	0	-2	0	1	0	0	0	0	0	-1
Existing Plus Project Conditions	59	215	95	44	827	110	265	622	317	82	339	62	3037
2025													
2025 No Project Background	59	281	95	44	1104	110	283	764	371	127	607	112	3957
2025 No Project Drive Access	0	0	0	0	0	0	1	0	0	0	2	0	3
2025 No Project Conditions	59	281	95	44	1104	110	284	764	371	127	609	112	3960
2025 Project Background	58	281	95	43	1088	110	282	761	370	127	604	111	3930
2025 No Project Drive Access	0	0	0	0	0	0	-1	0	0	0	-2	0	-3
2025 Project Drive Access	0	0	0	0	1	0	3	0	0	0	3	0	7
Change in Bkgrd (car->BART)	-1	0	0	-1	-16	0	-1	-3	-1	0	-3	-1	-27
2025 Net Project Trips	-1	0	0	-1	-15	0	1	-3	-1	0	-2	-1	-23
2025 Project Conditions	58	281	95	43	1089	110	285	761	370	127	607	111	3937
2035													
2035 No Project Background	84	339	95	44	1025	149	314	774	454	173	716	165	4332
2035 No Project Drive Access	0	0	0	0	1	0	4	1	0	0	4	0	10
2035 No Project Conditions	84	339	95	44	1026	149	318	775	454	173	720	165	4342
2035 Project Background	83	339	95	43	1018	149	313	772	454	173	711	162	4312
2035 No Project Drive Access	0	0	0	0	-1	0	-4	-1	0	0	-4	0	-10
2035 Project Drive Access	0	1	0	0	2	1	6	2	0	0	7	0	19
Change in Bkgrd (car->BART)	-1	0	0	-1	-7	0	-1	-2	0	0	-5	-3	-20
2035 Net Project Trips	-1	1	0	-1	-6	1	1	-1	0	0	-2	-3	-11
2035 Project Conditions	83	340	95	43	1020	150	319	774	454	173	718	162	4331

Intersection Number: 35
 Traffix Node #: 3748
 Model Node #: 8399
 Intersection Name: Race St and San Carlos St
 Peak Hour: AM

Date of Analysis: 06/15/15
 Count Date: 10/07/14

Scenario:	Movements												Total:
	North Approach			East Approach			South Approach			West Approach			
	RT	TH	LT	RT	TH	LT	RT	TH	LT	RT	TH	LT	
Existing Conditions	120	147	38	152	648	58	33	302	131	61	482	131	2303
Project Trips	0	0	0	0	-3	0	3	-3	0	0	1	0	-2
Existing Plus Project Conditions	120	147	38	152	645	58	36	299	131	61	483	131	2301
2025													
2025 No Project Background	120	150	38	156	884	93	126	302	131	63	749	132	2944
2025 No Project Drive Access	0	0	0	0	1	0	10	0	0	0	4	0	15
2025 No Project Conditions	120	150	38	156	885	93	136	302	131	63	753	132	2959
2025 Project Background	120	150	38	156	867	93	124	299	131	63	745	132	2918
2025 No Project Drive Access	0	0	0	0	-1	0	-10	0	0	0	-4	0	-15
2025 Project Drive Access	0	0	0	0	1	1	17	0	0	0	6	0	25
Change in Bkgrd (car-->BART)	0	0	0	0	-17	0	-2	-3	0	0	-4	0	-26
2025 Net Project Trips	0	0	0	0	-17	1	5	-3	0	0	-2	0	-16
2025 Project Conditions	120	150	38	156	868	94	141	299	131	63	751	132	2943
2035													
2035 No Project Background	120	153	39	199	854	85	155	302	132	67	860	146	3112
2035 No Project Drive Access	0	0	0	0	1	0	15	1	0	0	8	0	25
2035 No Project Conditions	120	153	39	199	855	85	170	303	132	67	868	146	3137
2035 Project Background	120	153	39	199	846	85	154	301	132	67	854	146	3096
2035 No Project Drive Access	0	0	0	0	-1	0	-15	-1	0	0	-8	0	-25
2035 Project Drive Access	0	0	0	0	2	1	22	0	0	0	11	0	36
Change in Bkgrd (car-->BART)	0	0	0	0	-8	0	-1	-1	0	0	-6	0	-16
2035 Net Project Trips	0	0	0	0	-7	1	6	-2	0	0	-3	0	-5
2035 Project Conditions	120	153	39	199	848	86	176	301	132	67	865	146	3132

Intersection Number: 36
 Traffix Node #: 3653
 Model Node #: 8400
 Intersection Name: Lincoln Ave and San Carlos St
 Peak Hour: AM

Date of Analysis: 06/15/15
 Count Date: 11/06/13

Scenario:	Movements												Total:
	North Approach			East Approach			South Approach			West Approach			
	RT	TH	LT	RT	TH	LT	RT	TH	LT	RT	TH	LT	
Existing Conditions	22	48	13	16	717	60	141	205	398	109	390	9	2128
Project Trips	0	0	0	0	-1	0	0	-2	0	0	3	0	0
Existing Plus Project Conditions	22	48	13	16	716	60	141	203	398	109	393	9	2128
2025													
2025 No Project Background	22	66	24	21	1084	126	230	205	398	121	745	9	3051
2025 No Project Drive Access	0	0	0	0	1	0	2	0	0	0	14	0	17
2025 No Project Conditions	22	66	24	21	1085	126	232	205	398	121	759	9	3068
2025 Project Background	22	66	24	21	1070	126	229	202	394	121	740	9	3024
2025 No Project Drive Access	0	0	0	0	-1	0	-2	0	0	0	-14	0	-17
2025 Project Drive Access	0	0	0	0	2	0	5	0	0	0	23	0	30
Change in Bkgrd (car-->BART)	0	0	0	0	-14	0	-1	-3	-4	0	-5	0	-27
2025 Net Project Trips	0	0	0	0	-13	0	2	-3	-4	0	4	0	-14
2025 Project Conditions	22	66	24	21	1072	126	234	202	394	121	763	9	3054
2035													
2035 No Project Background	22	72	29	31	1090	139	220	220	398	109	887	13	3230
2035 No Project Drive Access	0	0	0	0	1	0	3	0	0	0	23	0	27
2035 No Project Conditions	22	72	29	31	1091	139	223	220	398	109	910	13	3257
2035 Project Background	22	72	29	31	1082	139	218	219	397	109	880	13	3211
2035 No Project Drive Access	0	0	0	0	-1	0	-3	0	0	0	-23	0	-27
2035 Project Drive Access	0	0	0	0	3	1	6	0	0	0	34	0	44
Change in Bkgrd (car-->BART)	0	0	0	0	-8	0	-2	-1	-1	0	-7	0	-19
2035 Net Project Trips	0	0	0	0	-6	1	1	-1	-1	0	4	0	-2
2035 Project Conditions	22	72	29	31	1085	140	224	219	397	109	914	13	3255

Intersection Number: 37
 Traffix Node #: 3077
 Model Node #: 8674
 Intersection Name: Bird Ave and San Carlos St *
 Peak Hour: AM

Date of Analysis: 06/15/15
 Count Date: 10/07/14

Scenario:	Movements												Total:
	North Approach			East Approach			South Approach			West Approach			
	RT	TH	LT	RT	TH	LT	RT	TH	LT	RT	TH	LT	
Existing Conditions	52	394	43	53	357	89	131	1199	366	124	307	137	3252
Project Trips	0	5	0	1	-1	-1	-2	3	-1	0	-1	5	8
Existing Plus Project Conditions	52	399	43	54	356	88	129	1202	365	124	306	142	3260
2025													
2025 No Project Background	106	575	57	190	743	124	174	1288	366	248	496	224	4591
2025 No Project Drive Access	1	8	0	2	0	0	1	24	0	0	0	16	52
2025 No Project Conditions	107	583	57	192	743	124	175	1312	366	248	496	240	4643
2025 Project Background	106	570	56	186	734	121	168	1265	359	246	494	223	4528
2025 No Project Drive Access	-1	-8	0	-2	0	0	-1	-24	0	0	0	-16	-52
2025 Project Drive Access	3	18	0	5	0	0	0	38	0	0	0	28	92
Change in Bkgrd (car-->BART)	0	-5	-1	-4	-9	-3	-6	-23	-7	-2	-2	-1	-63
2025 Net Project Trips	2	5	-1	-1	-9	-3	-7	-9	-7	-2	-2	11	-23
2025 Project Conditions	109	588	56	191	734	121	168	1303	359	246	494	251	4620
2035													
2035 No Project Background	135	635	87	215	796	120	131	1475	366	249	620	250	5079
2035 No Project Drive Access	2	12	0	4	0	0	0	37	0	0	0	28	83
2035 No Project Conditions	137	647	87	219	796	120	131	1512	366	249	620	278	5162
2035 Project Background	135	627	86	205	791	118	127	1436	363	247	617	249	5001
2035 No Project Drive Access	-2	-12	0	-4	0	0	0	-37	0	0	0	-28	-83
2035 Project Drive Access	4	24	0	6	0	0	0	52	0	0	1	40	127
Change in Bkgrd (car-->BART)	0	-8	-1	-10	-5	-2	-4	-39	-3	-2	-3	-1	-78
2035 Net Project Trips	2	4	-1	-8	-5	-2	-4	-24	-3	-2	-2	11	-34
2035 Project Conditions	139	651	86	211	791	118	127	1488	363	247	618	289	5128

Intersection Number: 38
 Traffix Node #: 3266
 Model Node #: 8677
 Intersection Name: Bird Ave and Auzerais Ave
 Peak Hour: AM

Date of Analysis: 06/15/15
 Count Date: 10/07/14

Scenario:	Movements												Total:
	North Approach			East Approach			South Approach			West Approach			
	RT	TH	LT	RT	TH	LT	RT	TH	LT	RT	TH	LT	
Existing Conditions	40	570	54	26	62	64	109	1594	309	175	75	36	3114
Project Trips	0	4	0	0	0	0	0	1	0	0	0	0	5
Existing Plus Project Conditions	40	574	54	26	62	64	109	1595	309	175	75	36	3119
2025													
2025 No Project Background	40	905	59	114	94	137	109	1600	374	192	88	42	3754
2025 No Project Drive Access	0	8	0	0	0	0	0	25	0	0	0	0	33
2025 No Project Conditions	40	913	59	114	94	137	109	1625	374	192	88	42	3787
2025 Project Background	40	896	59	113	94	136	109	1566	371	192	88	42	3706
2025 No Project Drive Access	0	-8	0	0	0	0	0	-25	0	0	0	0	-33
2025 Project Drive Access	0	18	0	2	0	0	0	36	0	0	0	0	56
Change in Bkgrd (car-->BART)	0	-9	0	-1	0	-1	0	-34	-3	0	0	0	-48
2025 Net Project Trips	0	1	0	1	0	-1	0	-23	-3	0	0	0	-25
2025 Project Conditions	40	914	59	115	94	136	109	1602	371	192	88	42	3762
2035													
2035 No Project Background	40	969	54	213	106	131	109	1594	386	209	95	49	3955
2035 No Project Drive Access	0	13	0	1	0	0	0	36	0	0	0	0	50
2035 No Project Conditions	40	982	54	214	106	131	109	1630	386	209	95	49	4005
2035 Project Background	40	957	54	209	106	130	109	1552	383	208	95	49	3892
2035 No Project Drive Access	0	-13	0	-1	0	0	0	-36	0	0	0	0	-50
2035 Project Drive Access	0	24	0	3	0	0	0	49	0	0	0	0	76
Change in Bkgrd (car-->BART)	0	-12	0	-4	0	-1	0	-42	-3	-1	0	0	-63
2035 Net Project Trips	0	-1	0	-2	0	-1	0	-29	-3	-1	0	0	-37
2035 Project Conditions	40	981	54	212	106	130	109	1601	383	208	95	49	3968

Intersection Number: 39
 Traffix Node #: 3690
 Model Node #: 8404
 Intersection Name: Meridian Ave and Parkmoor Ave
 Peak Hour: AM

Date of Analysis: 06/15/15
 Count Date: 10/07/14

Scenario:	Movements												Total:
	North Approach			East Approach			South Approach			West Approach			
	RT	TH	LT	RT	TH	LT	RT	TH	LT	RT	TH	LT	
Existing Conditions	293	390	35	76	557	89	277	1205	236	35	4	8	3205
Project Trips	0	0	0	0	0	0	0	0	0	0	0	0	0
Existing Plus Project Conditions	293	390	35	76	557	89	277	1205	236	35	4	8	3205
2025													
2025 No Project Background	473	449	64	139	557	89	277	1318	236	35	4	8	3649
2025 No Project Drive Access	0	0	0	0	0	0	0	2	0	0	0	0	2
2025 No Project Conditions	473	449	64	139	557	89	277	1320	236	35	4	8	3651
2025 Project Background	470	449	64	138	551	89	277	1311	236	35	4	8	3632
2025 No Project Drive Access	0	0	0	0	0	0	0	-2	0	0	0	0	-2
2025 Project Drive Access	1	0	0	0	0	0	0	4	0	0	0	0	5
Change in Bkgrd (car->BART)	-3	0	0	-1	-6	0	0	-7	0	0	0	0	-17
2025 Net Project Trips	-2	0	0	-1	-6	0	0	-5	0	0	0	0	-14
2025 Project Conditions	471	449	64	138	551	89	277	1315	236	35	4	8	3637
2035													
2035 No Project Background	473	524	105	143	557	90	277	1422	236	35	4	8	3874
2035 No Project Drive Access	0	0	0	0	0	0	0	6	0	0	0	0	6
2035 No Project Conditions	473	524	105	143	557	90	277	1428	236	35	4	8	3880
2035 Project Background	471	524	105	143	556	90	277	1419	236	35	4	8	3868
2035 No Project Drive Access	0	0	0	0	0	0	0	-6	0	0	0	0	-6
2035 Project Drive Access	1	1	0	0	0	0	0	7	0	0	0	0	9
Change in Bkgrd (car->BART)	-2	0	0	0	-1	0	0	-3	0	0	0	0	-6
2035 Net Project Trips	-1	1	0	0	-1	0	0	-2	0	0	0	0	-3
2035 Project Conditions	472	525	105	143	556	90	277	1426	236	35	4	8	3877

Intersection Number: 40
 Traffix Node #: 3651
 Model Node #: 8398
 Intersection Name: Lincoln Ave and Parkmoor Ave
 Peak Hour: AM

Date of Analysis: 06/15/15
 Count Date: 10/07/14

Scenario:	Movements												Total:
	North Approach			East Approach			South Approach			West Approach			
	RT	TH	LT	RT	TH	LT	RT	TH	LT	RT	TH	LT	
Existing Conditions	68	216	0	2	4	1	12	957	345	91	11	105	1812
Project Trips	0	0	0	0	0	0	0	-3	0	0	0	0	-3
Existing Plus Project Conditions	68	216	0	2	4	1	12	954	345	91	11	105	1809
2025													
2025 No Project Background	68	243	0	2	4	1	12	957	409	116	11	113	1936
2025 No Project Drive Access	0	0	0	0	0	0	0	1	0	0	0	0	1
2025 No Project Conditions	68	243	0	2	4	1	12	958	409	116	11	113	1937
2025 Project Background	68	243	0	2	4	1	12	949	403	116	11	113	1922
2025 No Project Drive Access	0	0	0	0	0	0	0	-1	0	0	0	0	-1
2025 Project Drive Access	0	0	0	0	0	0	0	4	0	0	0	0	4
Change in Bkgrd (car->BART)	0	0	0	0	0	0	0	-8	-6	0	0	0	-14
2025 Net Project Trips	0	0	0	0	0	0	0	-5	-6	0	0	0	-11
2025 Project Conditions	68	243	0	2	4	1	12	953	403	116	11	113	1926
2035													
2035 No Project Background	68	249	0	2	4	1	12	957	391	145	11	148	1988
2035 No Project Drive Access	0	0	0	0	0	0	0	2	0	0	0	1	3
2035 No Project Conditions	68	249	0	2	4	1	12	959	391	145	11	149	1991
2035 Project Background	68	249	0	2	4	1	12	953	390	145	11	148	1983
2035 No Project Drive Access	0	0	0	0	0	0	0	-2	0	0	0	-1	-3
2035 Project Drive Access	0	0	0	0	0	0	0	6	0	0	0	2	8
Change in Bkgrd (car->BART)	0	0	0	0	0	0	0	-4	-1	0	0	0	-5
2035 Net Project Trips	0	0	0	0	0	0	0	0	-1	0	0	1	0
2035 Project Conditions	68	249	0	2	4	1	12	959	390	145	11	150	1991

Intersection Number: 41
 Traffix Node #: 3032
 Model Node #: 8682
 Intersection Name: Bird Ave and I-280 [N] *
 Peak Hour: AM

Date of Analysis: 06/15/15
 Count Date: 10/07/14

Scenario:	Movements												Total:
	North Approach			East Approach			South Approach			West Approach			
	RT	TH	LT	RT	TH	LT	RT	TH	LT	RT	TH	LT	
Existing Conditions	197	535	0	559	153	205	0	1254	249	0	0	0	3152
Project Trips	6	-1	0	-7	0	0	0	8	0	0	0	0	6
Existing Plus Project Conditions	203	534	0	552	153	205	0	1262	249	0	0	0	3158
2025													
2025 No Project Background	360	799	0	559	415	205	0	1446	255	0	0	0	4039
2025 No Project Drive Access	2	5	0	9	0	0	0	16	0	0	0	0	32
2025 No Project Conditions	362	804	0	568	415	205	0	1462	255	0	0	0	4071
2025 Project Background	356	792	0	535	411	204	0	1433	253	0	0	0	3984
2025 No Project Drive Access	-2	-5	0	-9	0	0	0	-16	0	0	0	0	-32
2025 Project Drive Access	9	9	0	9	0	0	0	27	0	0	0	0	54
Change in Bkgrd (car-->BART)	-4	-7	0	-24	-4	-1	0	-13	-2	0	0	0	-55
2025 Net Project Trips	3	-3	0	-24	-4	-1	0	-2	-2	0	0	0	-33
2025 Project Conditions	365	801	0	544	411	204	0	1460	253	0	0	0	4038
2035													
2035 No Project Background	320	911	0	559	351	205	0	1441	365	0	0	0	4152
2035 No Project Drive Access	3	10	0	15	0	1	0	21	0	0	0	0	50
2035 No Project Conditions	323	921	0	574	351	206	0	1462	365	0	0	0	4202
2035 Project Background	317	900	0	522	349	203	0	1431	364	0	0	0	4086
2035 No Project Drive Access	-3	-10	0	-15	0	-1	0	-21	0	0	0	0	-50
2035 Project Drive Access	11	14	0	14	0	0	0	35	0	0	0	0	74
Change in Bkgrd (car-->BART)	-3	-11	0	-37	-2	-2	0	-10	-1	0	0	0	-66
2035 Net Project Trips	5	-7	0	-38	-2	-3	0	4	-1	0	0	0	-42
2035 Project Conditions	328	914	0	536	349	203	0	1466	364	0	0	0	4160

Intersection Number: 42
 Traffix Node #: 3033
 Model Node #: 8437
 Intersection Name: Bird Ave and I-280 [S] *
 Peak Hour: AM

Date of Analysis: 06/15/15
 Count Date: 10/07/14

Scenario:	Movements												Total:
	North Approach			East Approach			South Approach			West Approach			
	RT	TH	LT	RT	TH	LT	RT	TH	LT	RT	TH	LT	
Existing Conditions	0	491	345	0	0	0	380	1280	0	131	3	329	2959
Project Trips	0	2	-2	0	0	0	-1	1	0	0	0	6	6
Existing Plus Project Conditions	0	493	343	0	0	0	379	1281	0	131	3	335	2965
2025													
2025 No Project Background	0	585	493	0	0	0	416	1454	0	182	3	356	3489
2025 No Project Drive Access	0	2	4	0	0	0	10	7	0	0	0	8	31
2025 No Project Conditions	0	587	497	0	0	0	426	1461	0	182	3	364	3520
2025 Project Background	0	582	487	0	0	0	411	1444	0	181	3	349	3457
2025 No Project Drive Access	0	-2	-4	0	0	0	-10	-7	0	0	0	-8	-31
2025 Project Drive Access	0	4	4	0	0	0	3	13	0	0	0	14	38
Change in Bkgrd (car-->BART)	0	-3	-6	0	0	0	-5	-10	0	-1	0	-7	-32
2025 Net Project Trips	0	-1	-6	0	0	0	-12	-4	0	-1	0	-1	-25
2025 Project Conditions	0	586	491	0	0	0	414	1457	0	181	3	363	3495
2035													
2035 No Project Background	0	642	567	0	0	0	410	1517	0	201	3	393	3733
2035 No Project Drive Access	0	3	7	0	0	0	12	12	0	0	0	9	43
2035 No Project Conditions	0	645	574	0	0	0	422	1529	0	201	3	402	3776
2035 Project Background	0	639	557	0	0	0	406	1511	0	201	3	389	3706
2035 No Project Drive Access	0	-3	-7	0	0	0	-12	-12	0	0	0	-9	-43
2035 Project Drive Access	0	8	6	0	0	0	2	19	0	0	0	15	50
Change in Bkgrd (car-->BART)	0	-3	-10	0	0	0	-4	-6	0	0	0	-4	-27
2035 Net Project Trips	0	2	-11	0	0	0	-14	1	0	0	0	2	-20
2035 Project Conditions	0	647	563	0	0	0	408	1530	0	201	3	404	3756

Intersection Number: 43
 Traffic Node #: 3553
 Model Node #: 8359
 Intersection Name: SW Expressway and Fruitdale Ave
 Peak Hour: AM

Date of Analysis: 06/15/15
 Count Date: 10/07/14

Scenario:	Movements												Total:
	North Approach			East Approach			South Approach			West Approach			
	RT	TH	LT	RT	TH	LT	RT	TH	LT	RT	TH	LT	
Existing Conditions	430	490	114	56	311	59	162	897	23	1	194	137	2874
Project Trips	-1	0	0	0	0	0	0	8	0	0	0	-1	6
Existing Plus Project Conditions	429	490	114	56	311	59	162	905	23	1	194	136	2880
2025													
2025 No Project Background	430	628	115	83	434	79	277	908	24	9	283	238	3508
2025 No Project Drive Access	1	3	0	0	0	0	2	14	0	0	0	4	24
2025 No Project Conditions	431	631	115	83	434	79	279	922	24	9	283	242	3532
2025 Project Background	425	620	115	83	433	79	277	899	24	9	283	235	3482
2025 No Project Drive Access	-1	-3	0	0	0	0	-2	-14	0	0	0	-4	-24
2025 Project Drive Access	1	5	0	0	0	0	3	25	0	0	0	5	39
Change in Bkgrd (car-->BART)	-5	-8	0	0	-1	0	0	-9	0	0	0	-3	-26
2025 Net Project Trips	-5	-6	0	0	-1	0	1	2	0	0	0	-2	-11
2025 Project Conditions	426	625	115	83	433	79	280	924	24	9	283	240	3521
2035													
2035 No Project Background	430	630	114	87	438	187	379	897	24	3	360	238	3787
2035 No Project Drive Access	1	5	0	0	0	0	4	21	0	0	1	6	38
2035 No Project Conditions	431	635	114	87	438	187	383	918	24	3	361	244	3825
2035 Project Background	426	623	114	87	438	186	378	890	24	3	360	235	3764
2035 No Project Drive Access	-1	-5	0	0	0	0	-4	-21	0	0	-1	-6	-38
2035 Project Drive Access	1	7	0	0	0	1	5	30	0	0	1	6	51
Change in Bkgrd (car-->BART)	-4	-7	0	0	0	-1	-1	-7	0	0	0	-3	-23
2035 Net Project Trips	-4	-5	0	0	0	0	0	2	0	0	0	-3	-10
2035 Project Conditions	427	630	114	87	438	187	383	920	24	3	361	241	3815

Intersection Number: 44
 Traffic Node #: 3552
 Model Node #: 8378
 Intersection Name: Meridian Ave and Fruitdale Ave
 Peak Hour: AM

Date of Analysis: 06/15/15
 Count Date: 10/07/14

Scenario:	Movements												Total:
	North Approach			East Approach			South Approach			West Approach			
	RT	TH	LT	RT	TH	LT	RT	TH	LT	RT	TH	LT	
Existing Conditions	120	502	55	182	74	171	49	1869	204	203	79	208	3716
Project Trips	0	0	0	0	0	1	0	1	0	0	0	0	2
Existing Plus Project Conditions	120	502	55	182	74	172	49	1870	204	203	79	208	3718
2025													
2025 No Project Background	121	553	55	182	77	180	59	1869	370	263	82	350	4161
2025 No Project Drive Access	0	0	0	0	0	0	0	6	0	0	0	2	8
2025 No Project Conditions	121	553	55	182	77	180	59	1875	370	263	82	352	4169
2025 Project Background	121	551	55	181	77	180	59	1857	369	263	82	349	4144
2025 No Project Drive Access	0	0	0	0	0	0	0	-6	0	0	0	-2	-8
2025 Project Drive Access	0	0	0	0	0	1	0	6	0	0	0	3	10
Change in Bkgrd (car-->BART)	0	-2	0	-1	0	0	0	-12	-1	0	0	-1	-17
2025 Net Project Trips	0	-2	0	-1	0	1	0	-12	-1	0	0	0	-15
2025 Project Conditions	121	551	55	181	77	181	59	1863	369	263	82	352	4154
2035													
2035 No Project Background	192	640	55	182	142	174	62	1869	350	314	114	442	4536
2035 No Project Drive Access	0	0	0	0	0	1	0	7	0	0	1	5	14
2035 No Project Conditions	192	640	55	182	142	175	62	1876	350	314	115	447	4550
2035 Project Background	192	638	55	182	141	174	62	1866	350	314	114	441	4529
2035 No Project Drive Access	0	0	0	0	0	-1	0	-7	0	0	-1	-5	-14
2035 Project Drive Access	1	0	0	0	0	1	0	10	0	0	1	6	19
Change in Bkgrd (car-->BART)	0	-2	0	0	-1	0	0	-3	0	0	0	-1	-7
2035 Net Project Trips	1	-2	0	0	-1	0	0	0	0	0	0	0	-2
2035 Project Conditions	193	638	55	182	141	175	62	1876	350	314	115	447	4548

Intersection Number: 45
 Trafix Node #: 7
 Model Node #: 6461
 Intersection Name: Lafayette St and Reed St
 Peak Hour: AM

Date of Analysis: 06/15/15
 Count Date: 2013

Scenario:	Movements												Total:
	North Approach			East Approach			South Approach			West Approach			
	RT	TH	LT	RT	TH	LT	RT	TH	LT	RT	TH	LT	
Existing Conditions	20	409	19	35	4	25	73	1606	0	4	0	4	2199
Project Trips	0	0	0	0	0	0	0	-2	0	0	0	0	-2
Existing Plus Project Conditions	20	409	19	35	4	25	73	1604	0	4	0	4	2197
2025													
2025 No Project Background	20	553	24	68	4	27	118	1706	0	4	0	4	2528
2025 No Project Drive Access	0	2	0	0	0	0	1	1	0	0	0	0	4
2025 No Project Conditions	20	555	24	68	4	27	119	1707	0	4	0	4	2532
2025 Project Background	20	551	24	67	4	27	114	1694	0	4	0	4	2509
2025 No Project Drive Access	0	-2	0	0	0	0	-1	-1	0	0	0	0	-4
2025 Project Drive Access	0	2	0	0	0	0	7	0	0	0	0	0	9
Change in Bkgrd (car-->BART)	0	-2	0	-1	0	0	-4	-12	0	0	0	0	-19
2025 Net Project Trips	0	-2	0	-1	0	0	2	-13	0	0	0	0	-14
2025 Project Conditions	20	553	24	67	4	27	121	1694	0	4	0	4	2518
2025 Santa Clara West Option													
2025 SC West No Project Background	20	553	24	68	4	27	118	1706	0	4	0	4	2528
2025 SC West No Project Drive Access	0	2	0	0	0	0	1	1	0	0	0	0	4
2025 SC West No Project Conditions	20	555	24	68	4	27	119	1707	0	4	0	4	2532
2025 SC West Project Background	20	551	24	67	4	27	114	1694	0	4	0	4	2509
2025 SC West No Project Drive Access	0	-2	0	0	0	0	-1	-1	0	0	0	0	-4
2025 SC West Project Drive Access	0	3	0	0	0	0	0	0	0	0	0	0	3
Change in Bkgrd (car-->BART)	0	-2	0	-1	0	0	-4	-12	0	0	0	0	-19
2025 SC West Net Project Trips	0	-1	0	-1	0	0	-5	-13	0	0	0	0	-20
2025 SC West Project Conditions	20	554	24	67	4	27	114	1694	0	4	0	4	2512
2035													
2035 No Project Background	20	683	24	123	4	26	146	1699	0	4	0	4	2733
2035 No Project Drive Access	0	9	0	0	0	0	1	2	0	0	0	0	12
2035 No Project Conditions	20	692	24	123	4	26	147	1701	0	4	0	4	2745
2035 Project Background	20	680	24	122	4	26	142	1694	0	4	0	4	2720
2035 No Project Drive Access	0	-9	0	0	0	0	-1	-2	0	0	0	0	-12
2035 Project Drive Access	0	10	1	0	0	0	15	1	0	0	0	0	27
Change in Bkgrd (car-->BART)	0	-3	0	-1	0	0	-4	-5	0	0	0	0	-13
2035 Net Project Trips	0	-2	1	-1	0	0	10	-6	0	0	0	0	2
2035 Project Conditions	20	690	25	122	4	26	157	1695	0	4	0	4	2747
2035 Santa Clara West Option													
2035 SC West No Project Background	20	683	24	123	4	26	146	1699	0	4	0	4	2733
2035 SC West No Project Drive Access	0	9	0	0	0	0	1	2	0	0	0	0	12
2035 SC West No Project Conditions	20	692	24	123	4	26	147	1701	0	4	0	4	2745
2035 SC West Project Background	20	680	24	122	4	26	142	1694	0	4	0	4	2720
2035 SC West No Project Drive Access	0	-9	0	0	0	0	-1	-2	0	0	0	0	-12
2035 SC West Project Drive Access	0	13	0	0	0	0	0	1	0	0	0	0	14
Change in Bkgrd (car-->BART)	0	-3	0	-1	0	0	-4	-5	0	0	0	0	-13
2035 SC West Net Project Trips	0	1	0	-1	0	0	-5	-6	0	0	0	0	-11
2035 SC West Project Conditions	20	693	24	122	4	26	142	1695	0	4	0	4	2734

Intersection Number: 46
 Traffic Node #: 175
 Model Node #: 6460
 Intersection Name: De La Cruz Blvd and Reed St
 Peak Hour: AM

Date of Analysis: 06/15/15
 Count Date: 10/08/14

Scenario:	Movements												Total:
	North Approach			East Approach			South Approach			West Approach			
	RT	TH	LT	RT	TH	LT	RT	TH	LT	RT	TH	LT	
Existing Conditions	50	437	7	6	3	31	33	1919	122	54	22	35	2719
Project Trips	0	-11	-1	0	0	0	-2	-9	0	2	0	-2	-23
Existing Plus Project Conditions	50	426	6	6	3	31	31	1910	122	56	22	33	2696
2025													
2025 No Project Background	50	711	11	6	3	34	33	2106	157	110	29	35	3285
2025 No Project Drive Access	0	11	0	0	0	0	0	5	0	0	0	1	17
2025 No Project Conditions	50	722	11	6	3	34	33	2111	157	110	29	36	3302
2025 Project Background	50	693	10	6	3	34	29	2077	156	106	29	34	3227
2025 No Project Drive Access	0	-11	0	0	0	0	0	-5	0	0	0	-1	-17
2025 Project Drive Access	0	10	0	0	0	0	0	2	0	8	0	0	20
Change in Bkgrd (car-->BART)	0	-18	-1	0	0	0	-4	-29	-1	-4	0	-1	-58
2025 Net Project Trips	0	-19	-1	0	0	0	-4	-32	-1	4	0	-2	-55
2025 Project Conditions	50	703	10	6	3	34	29	2079	156	114	29	34	3247
2025 Santa Clara West Option													
2025 SC West No Project Background	50	711	11	6	3	34	33	2106	157	110	29	35	3285
2025 SC West No Project Drive Access	0	11	0	0	0	0	0	5	0	0	0	1	17
2025 SC West No Project Conditions	50	722	11	6	3	34	33	2111	157	110	29	36	3302
2025 SC West Project Background	50	693	10	6	3	34	29	2077	156	106	29	34	3227
2025 SC West No Project Drive Access	0	-11	0	0	0	0	0	-5	0	0	0	-1	-17
2025 SC West Project Drive Access	0	10	0	0	0	0	0	2	0	0	0	0	12
Change in Bkgrd (car-->BART)	0	-18	-1	0	0	0	-4	-29	-1	-4	0	-1	-58
2025 SC West Net Project Trips	0	-19	-1	0	0	0	-4	-32	-1	-4	0	-2	-63
2025 SC West Project Conditions	50	703	10	6	3	34	29	2079	156	106	29	34	3239
2035													
2035 No Project Background	51	884	12	6	3	36	33	2161	211	128	38	35	3598
2035 No Project Drive Access	0	14	0	0	0	0	0	8	0	0	0	1	23
2035 No Project Conditions	51	898	12	6	3	36	33	2169	211	128	38	36	3621
2035 Project Background	51	861	11	6	3	35	30	2143	210	124	38	34	3546
2035 No Project Drive Access	0	-14	0	0	0	0	0	-8	0	0	0	-1	-23
2035 Project Drive Access	0	14	0	0	0	0	0	3	0	15	0	0	32
Change in Bkgrd (car-->BART)	0	-23	-1	0	0	-1	-3	-18	-1	-4	0	-1	-52
2035 Net Project Trips	0	-23	-1	0	0	-1	-3	-23	-1	11	0	-2	-43
2035 Project Conditions	51	875	11	6	3	35	30	2146	210	139	38	34	3578
2035 Santa Clara West Option													
2035 SC West No Project Background	51	884	12	6	3	36	33	2161	211	128	38	35	3598
2035 SC West No Project Drive Access	0	14	0	0	0	0	0	8	0	0	0	1	23
2035 SC West No Project Conditions	51	898	12	6	3	36	33	2169	211	128	38	36	3621
2035 SC West Project Background	51	861	11	6	3	35	30	2143	210	124	38	34	3546
2035 SC West No Project Drive Access	0	-14	0	0	0	0	0	-8	0	0	0	-1	-23
2035 SC West Project Drive Access	0	11	0	0	0	0	0	3	0	0	0	0	14
Change in Bkgrd (car-->BART)	0	-23	-1	0	0	-1	-3	-18	-1	-4	0	-1	-52
2035 SC West Net Project Trips	0	-26	-1	0	0	-1	-3	-23	-1	-4	0	-2	-61
2035 SC West Project Conditions	51	872	11	6	3	35	30	2146	210	124	38	34	3560

Intersection Number: 47
 Traffic Node #: 5416
 Model Node #: 8900
 Intersection Name: San Tomas Expwy and El Camino Real *
 Peak Hour: AM

Date of Analysis: 06/15/15
 Count Date: 10/08/14

Scenario:	Movements												Total:
	North Approach			East Approach			South Approach			West Approach			
	RT	TH	LT	RT	TH	LT	RT	TH	LT	RT	TH	LT	
Existing Conditions	372	1020	75	410	755	163	96	2779	173	127	657	263	6890
Project Trips	1	-2	0	0	-3	0	1	-4	0	0	-2	1	-8
Existing Plus Project Conditions	373	1018	75	410	752	163	97	2775	173	127	655	264	6882
2025													
2025 No Project Background	445	1160	90	529	1026	163	96	2779	210	127	882	263	7770
2025 No Project Drive Access	1	4	0	1	0	0	0	19	0	0	0	7	32
2025 No Project Conditions	446	1164	90	530	1026	163	96	2798	210	127	882	270	7802
2025 Project Background	443	1153	90	528	1014	161	96	2770	209	127	878	261	7730
2025 No Project Drive Access	-1	-4	0	-1	0	0	0	-19	0	0	0	-7	-32
2025 Project Drive Access	1	2	0	0	0	0	0	10	0	0	0	6	19
Change in Bkgrd (car-->BART)	-2	-7	0	-1	-12	-2	0	-9	-1	0	-4	-2	-40
2025 Net Project Trips	-2	-9	0	-2	-12	-2	0	-18	-1	0	-4	-3	-53
2025 Project Conditions	444	1155	90	528	1014	161	96	2780	209	127	878	267	7749
2025 Santa Clara West Option													
2025 SC West No Project Background	445	1160	90	529	1026	163	96	2779	210	127	882	263	7770
2025 SC West No Project Drive Access	1	4	0	1	0	0	0	19	0	0	0	7	32
2025 SC West No Project Conditions	446	1164	90	530	1026	163	96	2798	210	127	882	270	7802
2025 SC West Project Background	443	1153	90	528	1014	161	96	2770	209	127	878	261	7730
2025 SC West No Project Drive Access	-1	-4	0	-1	0	0	0	-19	0	0	0	-7	-32
2025 SC West Project Drive Access	1	2	0	0	0	0	0	10	0	0	0	6	19
Change in Bkgrd (car-->BART)	-2	-7	0	-1	-12	-2	0	-9	-1	0	-4	-2	-40
2025 SC West Net Project Trips	-2	-9	0	-2	-12	-2	0	-18	-1	0	-4	-3	-53
2025 SC West Project Conditions	444	1155	90	528	1014	161	96	2780	209	127	878	267	7749
2035													
2035 No Project Background	410	1378	96	604	1090	163	96	2779	243	127	943	263	8192
2035 No Project Drive Access	1	6	0	1	0	0	0	28	0	0	1	9	46
2035 No Project Conditions	411	1384	96	605	1090	163	96	2807	243	127	944	272	8238
2035 Project Background	408	1373	96	602	1084	163	96	2774	243	127	938	261	8165
2035 No Project Drive Access	-1	-6	0	-1	0	0	0	-28	0	0	-1	-9	-46
2035 Project Drive Access	1	1	0	0	0	0	1	11	0	0	1	7	22
Change in Bkgrd (car-->BART)	-2	-5	0	-2	-6	0	0	-5	0	0	-5	-2	-27
2035 Net Project Trips	-2	-10	0	-3	-6	0	1	-22	0	0	-5	-4	-51
2035 Project Conditions	409	1374	96	602	1084	163	97	2785	243	127	939	268	8187
2035 Santa Clara West Option													
2035 SC West No Project Background	410	1378	96	604	1090	163	96	2779	243	127	943	263	8192
2035 SC West No Project Drive Access	1	6	0	1	0	0	0	28	0	0	1	9	46
2035 SC West No Project Conditions	411	1384	96	605	1090	163	96	2807	243	127	944	272	8238
2035 SC West Project Background	408	1373	96	602	1084	163	96	2774	243	127	938	261	8165
2035 SC West No Project Drive Access	-1	-6	0	-1	0	0	0	-28	0	0	-1	-9	-46
2035 SC West Project Drive Access	1	1	0	0	0	0	1	12	0	0	1	7	23
Change in Bkgrd (car-->BART)	-2	-5	0	-2	-6	0	0	-5	0	0	-5	-2	-27
2035 SC West Net Project Trips	-2	-10	0	-3	-6	0	1	-21	0	0	-5	-4	-50
2035 SC West Project Conditions	409	1374	96	602	1084	163	97	2786	243	127	939	268	8188

Intersection Number: 48
 Traffic Node #: 1205
 Model Node #: 8889
 Intersection Name: Scott Blvd and El Camino Real *
 Peak Hour: AM

Date of Analysis: 06/15/15
 Count Date: 10/08/14

Scenario:	Movements												Total:
	North Approach			East Approach			South Approach			West Approach			
	RT	TH	LT	RT	TH	LT	RT	TH	LT	RT	TH	LT	
Existing Conditions	92	218	87	96	672	129	118	750	147	68	420	102	2899
Project Trips	0	0	0	0	-3	0	3	-1	0	0	-2	0	-3
Existing Plus Project Conditions	92	218	87	96	669	129	121	749	147	68	418	102	2896
2025													
2025 No Project Background	92	381	94	141	855	181	118	1013	213	111	599	112	3910
2025 No Project Drive Access	0	0	0	0	0	0	1	1	0	0	1	0	3
2025 No Project Conditions	92	381	94	141	855	181	119	1014	213	111	600	112	3913
2025 Project Background	92	381	94	140	843	179	117	1008	212	111	594	112	3883
2025 No Project Drive Access	0	0	0	0	0	0	-1	-1	0	0	-1	0	-3
2025 Project Drive Access	0	0	0	0	1	1	3	0	0	0	3	0	8
Change in Bkgrd (car-->BART)	0	0	0	-1	-12	-2	-1	-5	-1	0	-5	0	-27
2025 Net Project Trips	0	0	0	-1	-11	-1	1	-6	-1	0	-3	0	-22
2025 Project Conditions	92	381	94	140	844	180	120	1008	212	111	597	112	3891
2025 Santa Clara West Option													
2025 SC West No Project Background	92	381	94	141	855	181	118	1013	213	111	599	112	3910
2025 SC West No Project Drive Access	0	0	0	0	0	0	1	1	0	0	1	0	3
2025 SC West No Project Conditions	92	381	94	141	855	181	119	1014	213	111	600	112	3913
2025 SC West Project Background	92	381	94	140	843	179	117	1008	212	111	594	112	3883
2025 SC West No Project Drive Access	0	0	0	0	0	0	-1	-1	0	0	-1	0	-3
2025 SC West Project Drive Access	0	0	0	0	1	1	4	0	0	0	3	0	9
Change in Bkgrd (car-->BART)	0	0	0	-1	-12	-2	-1	-5	-1	0	-5	0	-27
2025 SC West Net Project Trips	0	0	0	-1	-11	-1	2	-6	-1	0	-3	0	-21
2025 SC West Project Conditions	92	381	94	140	844	180	121	1008	212	111	597	112	3892
2035													
2035 No Project Background	92	426	102	141	933	228	118	1012	234	104	648	155	4193
2035 No Project Drive Access	0	0	1	0	1	0	2	2	0	0	2	1	9
2035 No Project Conditions	92	426	103	141	934	228	120	1014	234	104	650	156	4202
2035 Project Background	92	425	102	141	927	226	117	1011	233	104	641	155	4174
2035 No Project Drive Access	0	0	-1	0	-1	0	-2	-2	0	0	-2	-1	-9
2035 Project Drive Access	0	0	1	0	1	1	11	0	0	0	6	0	20
Change in Bkgrd (car-->BART)	0	-1	0	0	-6	-2	-1	-1	-1	0	-7	0	-19
2035 Net Project Trips	0	-1	0	0	-6	-1	8	-3	-1	0	-3	-1	-8
2035 Project Conditions	92	425	103	141	928	227	128	1011	233	104	647	155	4194
2035 Santa Clara West Option													
2035 SC West No Project Background	92	426	102	141	933	228	118	1012	234	104	648	155	4193
2035 SC West No Project Drive Access	0	0	1	0	1	0	2	2	0	0	2	1	9
2035 SC West No Project Conditions	92	426	103	141	934	228	120	1014	234	104	650	156	4202
2035 SC West Project Background	92	425	102	141	927	226	117	1011	233	104	641	155	4174
2035 SC West No Project Drive Access	0	0	-1	0	-1	0	-2	-2	0	0	-2	-1	-9
2035 SC West Project Drive Access	0	0	1	0	1	1	8	0	0	0	7	0	18
Change in Bkgrd (car-->BART)	0	-1	0	0	-6	-2	-1	-1	-1	0	-7	0	-19
2035 SC West Net Project Trips	0	-1	0	0	-6	-1	5	-3	-1	0	-2	-1	-10
2035 SC West Project Conditions	92	425	103	141	928	227	125	1011	233	104	648	155	4192

Intersection Number: 49
 Traffix Node #: 1204
 Model Node #: 8834
 Intersection Name: Monroe St and El Camino Real *
 Peak Hour: AM

Date of Analysis: 06/15/15
 Count Date: 10/08/14

Scenario:	Movements												Total:
	North Approach			East Approach			South Approach			West Approach			
	RT	TH	LT	RT	TH	LT	RT	TH	LT	RT	TH	LT	
Existing Conditions	46	163	118	211	790	40	33	371	71	43	648	48	2582
Project Trips	0	0	1	-4	-2	0	1	0	0	0	6	0	2
Existing Plus Project Conditions	46	163	119	207	788	40	34	371	71	43	654	48	2584
2025													
2025 No Project Background	59	163	144	252	977	42	33	387	74	43	865	60	3099
2025 No Project Drive Access	0	0	1	0	1	0	0	0	0	0	5	0	7
2025 No Project Conditions	59	163	145	252	978	42	33	387	74	43	870	60	3106
2025 Project Background	58	163	141	243	964	42	33	387	74	43	856	60	3064
2025 No Project Drive Access	0	0	-1	0	-1	0	0	0	0	0	-5	0	-7
2025 Project Drive Access	0	0	5	1	2	0	2	0	0	0	15	0	25
Change in Bkgrd (car-->BART)	-1	0	-3	-9	-13	0	0	0	0	0	-9	0	-35
2025 Net Project Trips	-1	0	1	-8	-12	0	2	0	0	0	1	0	-17
2025 Project Conditions	58	163	146	244	966	42	35	387	74	43	871	60	3089
2025 Santa Clara West Option													
2025 SC West No Project Background	59	163	144	252	977	42	33	387	74	43	865	60	3099
2025 SC West No Project Drive Access	0	0	1	0	1	0	0	0	0	0	5	0	7
2025 SC West No Project Conditions	59	163	145	252	978	42	33	387	74	43	870	60	3106
2025 SC West Project Background	58	163	141	243	964	42	33	387	74	43	856	60	3064
2025 SC West No Project Drive Access	0	0	-1	0	-1	0	0	0	0	0	-5	0	-7
2025 SC West Project Drive Access	0	0	7	1	2	0	1	0	0	0	12	0	23
Change in Bkgrd (car-->BART)	-1	0	-3	-9	-13	0	0	0	0	0	-9	0	-35
2025 SC West Net Project Trips	-1	0	3	-8	-12	0	1	0	0	0	-2	0	-19
2025 SC West Project Conditions	58	163	148	244	966	42	34	387	74	43	868	60	3087
2035													
2035 No Project Background	65	163	175	256	1034	44	53	404	93	43	921	54	3305
2035 No Project Drive Access	0	0	4	1	1	0	1	0	0	0	7	0	14
2035 No Project Conditions	65	163	179	257	1035	44	54	404	93	43	928	54	3319
2035 Project Background	65	163	171	248	1026	44	53	404	93	43	910	54	3274
2035 No Project Drive Access	0	0	-4	-1	-1	0	-1	0	0	0	-7	0	-14
2035 Project Drive Access	0	0	9	2	4	0	3	0	0	0	32	1	51
Change in Bkgrd (car-->BART)	0	0	-4	-8	-8	0	0	0	0	0	-11	0	-31
2035 Net Project Trips	0	0	1	-7	-5	0	2	0	0	0	14	1	6
2035 Project Conditions	65	163	180	250	1030	44	56	404	93	43	942	55	3325
2035 Santa Clara West Option													
2035 SC West No Project Background	65	163	175	256	1034	44	53	404	93	43	921	54	3305
2035 SC West No Project Drive Access	0	0	4	1	1	0	1	0	0	0	7	0	14
2035 SC West No Project Conditions	65	163	179	257	1035	44	54	404	93	43	928	54	3319
2035 SC West Project Background	65	163	171	248	1026	44	53	404	93	43	910	54	3274
2035 SC West No Project Drive Access	0	0	-4	-1	-1	0	-1	0	0	0	-7	0	-14
2035 SC West Project Drive Access	0	0	12	2	4	0	1	0	0	0	21	0	40
Change in Bkgrd (car-->BART)	0	0	-4	-8	-8	0	0	0	0	0	-11	0	-31
2035 SC West Net Project Trips	0	0	4	-7	-5	0	0	0	0	0	3	0	-5
2035 SC West Project Conditions	65	163	183	250	1030	44	54	404	93	43	931	54	3314

Intersection Number: 50
 Traffix Node #: 1202
 Model Node #: 8835
 Intersection Name: Lafayette St and El Camino Real *
 Peak Hour: AM

Date of Analysis: 06/15/15
 Count Date: 10/08/14

Scenario:	Movements												Total:
	North Approach			East Approach			South Approach			West Approach			
	RT	TH	LT	RT	TH	LT	RT	TH	LT	RT	TH	LT	
Existing Conditions	153	246	88	480	833	9	96	942	132	119	401	264	3763
Project Trips	0	0	1	-1	-6	0	5	-1	0	0	9	0	7
Existing Plus Project Conditions	153	246	89	479	827	9	101	941	132	119	410	264	3770
2025													
2025 No Project Background	167	357	128	552	1013	10	96	969	165	126	600	299	4482
2025 No Project Drive Access	0	0	5	1	1	0	1	0	0	0	6	0	14
2025 No Project Conditions	167	357	133	553	1014	10	97	969	165	126	606	299	4496
2025 Project Background	167	355	125	545	993	10	95	963	164	126	587	299	4429
2025 No Project Drive Access	0	0	-5	-1	-1	0	-1	0	0	0	-6	0	-14
2025 Project Drive Access	0	0	6	2	3	0	6	1	0	0	22	1	41
Change in Bkgrd (car-->BART)	0	-2	-3	-7	-20	0	-1	-6	-1	0	-13	0	-53
2025 Net Project Trips	0	-2	-2	-6	-18	0	4	-5	-1	0	3	1	-26
2025 Project Conditions	167	355	131	547	996	10	101	964	164	126	609	300	4470
2025 Santa Clara West Option													
2025 SC West No Project Background	167	357	128	552	1013	10	96	969	165	126	600	299	4482
2025 SC West No Project Drive Access	0	0	5	1	1	0	1	0	0	0	6	0	14
2025 SC West No Project Conditions	167	357	133	553	1014	10	97	969	165	126	606	299	4496
2025 SC West Project Background	167	355	125	545	993	10	95	963	164	126	587	299	4429
2025 SC West No Project Drive Access	0	0	-5	-1	-1	0	-1	0	0	0	-6	0	-14
2025 SC West Project Drive Access	0	0	10	1	3	0	0	0	0	0	20	0	34
Change in Bkgrd (car-->BART)	0	-2	-3	-7	-20	0	-1	-6	-1	0	-13	0	-53
2025 SC West Net Project Trips	0	-2	2	-7	-18	0	-2	-6	-1	0	1	0	-33
2025 SC West Project Conditions	167	355	135	546	996	10	95	963	164	126	607	299	4463
2035													
2035 No Project Background	185	410	207	494	1011	12	96	1002	215	141	630	362	4765
2035 No Project Drive Access	0	0	12	1	2	0	1	0	0	0	11	0	27
2035 No Project Conditions	185	410	219	495	1013	12	97	1002	215	141	641	362	4792
2035 Project Background	185	408	202	491	995	12	95	999	214	141	615	361	4718
2035 No Project Drive Access	0	0	-12	-1	-2	0	-1	0	0	0	-11	0	-27
2035 Project Drive Access	0	0	16	4	6	0	6	2	0	0	42	3	79
Change in Bkgrd (car-->BART)	0	-2	-5	-3	-16	0	-1	-3	-1	0	-15	-1	-47
2035 Net Project Trips	0	-2	-1	0	-12	0	4	-1	-1	0	16	2	5
2035 Project Conditions	185	408	218	495	1001	12	101	1001	214	141	657	364	4797
2035 Santa Clara West Option													
2035 SC West No Project Background	185	410	207	494	1011	12	96	1002	215	141	630	362	4765
2035 SC West No Project Drive Access	0	0	12	1	2	0	1	0	0	0	11	0	27
2035 SC West No Project Conditions	185	410	219	495	1013	12	97	1002	215	141	641	362	4792
2035 SC West Project Background	185	408	202	491	995	12	95	999	214	141	615	361	4718
2035 SC West No Project Drive Access	0	0	-12	-1	-2	0	-1	0	0	0	-11	0	-27
2035 SC West Project Drive Access	0	0	24	3	6	1	0	0	0	0	35	0	69
Change in Bkgrd (car-->BART)	0	-2	-5	-3	-16	0	-1	-3	-1	0	-15	-1	-47
2035 SC West Net Project Trips	0	-2	7	-1	-12	1	-2	-3	-1	0	9	-1	-5
2035 SC West Project Conditions	185	408	226	494	1001	13	95	999	214	141	650	361	4787

Intersection Number: 51
 Traffic Node #: 106
 Model Node #: 8796
 Intersection Name: El Camino Real and Benton St
 Peak Hour: AM

Date of Analysis: 06/15/15
 Count Date: 10/08/14

Scenario:	Movements												Total:
	North Approach			East Approach			South Approach			West Approach			
	RT	TH	LT	RT	TH	LT	RT	TH	LT	RT	TH	LT	
Existing Conditions	19	391	71	39	19	3	9	1194	92	128	37	22	2024
Project Trips	0	-3	1	3	2	0	0	4	-9	0	2	0	0
Existing Plus Project Conditions	19	388	72	42	21	3	9	1198	83	128	39	22	2024
2025													
2025 No Project Background	19	518	71	39	19	3	9	1440	92	160	37	22	2429
2025 No Project Drive Access	0	0	20	3	2	0	0	0	0	0	17	0	42
2025 No Project Conditions	19	518	91	42	21	3	9	1440	92	160	54	22	2471
2025 Project Background	19	512	71	39	19	3	9	1425	83	158	37	22	2397
2025 No Project Drive Access	0	0	-20	-3	-2	0	0	0	0	0	-17	0	-42
2025 Project Drive Access	0	0	21	7	5	0	0	13	0	0	20	0	66
Change in Bkgrd (car-->BART)	0	-6	0	0	0	0	0	-15	-9	-2	0	0	-32
2025 Net Project Trips	0	-6	1	4	3	0	0	-2	-9	-2	3	0	-8
2025 Project Conditions	19	512	92	46	24	3	9	1438	83	158	57	22	2463
2025 Santa Clara West Option													
2025 SC West No Project Background	19	518	71	39	19	3	9	1440	92	160	37	22	2429
2025 SC West No Project Drive Access	0	0	20	3	2	0	0	0	0	0	17	0	42
2025 SC West No Project Conditions	19	518	91	42	21	3	9	1440	92	160	54	22	2471
2025 SC West Project Background	19	512	71	39	19	3	9	1425	83	158	37	22	2397
2025 SC West No Project Drive Access	0	0	-20	-3	-2	0	0	0	0	0	-17	0	-42
2025 SC West Project Drive Access	0	0	47	8	5	0	0	0	0	0	36	0	96
Change in Bkgrd (car-->BART)	0	-6	0	0	0	0	0	-15	-9	-2	0	0	-32
2025 SC West Net Project Trips	0	-6	27	5	3	0	0	-15	-9	-2	19	0	22
2025 SC West Project Conditions	19	512	118	47	24	3	9	1425	83	158	73	22	2493
2035													
2035 No Project Background	19	705	71	39	19	3	9	1575	112	183	37	22	2794
2035 No Project Drive Access	0	0	39	7	4	0	0	0	0	0	27	0	77
2035 No Project Conditions	19	705	110	46	23	3	9	1575	112	183	64	22	2871
2035 Project Background	19	694	71	39	19	3	9	1564	101	178	37	22	2756
2035 No Project Drive Access	0	0	-39	-7	-4	0	0	0	0	0	-27	0	-77
2035 Project Drive Access	0	1	40	12	10	0	0	22	0	0	30	0	115
Change in Bkgrd (car-->BART)	0	-11	0	0	0	0	0	-11	-11	-5	0	0	-38
2035 Net Project Trips	0	-10	1	5	6	0	0	11	-11	-5	3	0	0
2035 Project Conditions	19	695	111	51	29	3	9	1586	101	178	67	22	2871
2035 Santa Clara West Option													
2035 SC West No Project Background	19	705	71	39	19	3	9	1575	112	183	37	22	2794
2035 SC West No Project Drive Access	0	0	39	7	4	0	0	0	0	0	27	0	77
2035 SC West No Project Conditions	19	705	110	46	23	3	9	1575	112	183	64	22	2871
2035 SC West Project Background	19	694	71	39	19	3	9	1564	101	178	37	22	2756
2035 SC West No Project Drive Access	0	0	-39	-7	-4	0	0	0	0	0	-27	0	-77
2035 SC West Project Drive Access	0	0	86	14	11	0	0	0	0	0	66	0	177
Change in Bkgrd (car-->BART)	0	-11	0	0	0	0	0	-11	-11	-5	0	0	-38
2035 SC West Net Project Trips	0	-11	47	7	7	0	0	-11	-11	-5	39	0	62
2035 SC West Project Conditions	19	694	157	53	30	3	9	1564	101	178	103	22	2933

Intersection Number: 52
 Traffix Node #: 1012
 Model Node #: 60622
 Intersection Name: El Camino Real and Railroad Ave
 Peak Hour: AM

Date of Analysis: 06/15/15
 Count Date: 10/08/14

Scenario:	Movements												Total:
	North Approach			East Approach			South Approach			West Approach			
	RT	TH	LT	RT	TH	LT	RT	TH	LT	RT	TH	LT	
Existing Conditions	90	372	55	57	10	38	52	1228	175	21	0	11	2109
Project Trips	-2	-1	0	0	0	2	1	-3	-11	-2	0	-1	-17
Existing Plus Project Conditions	88	371	55	57	10	40	53	1225	164	19	0	10	2092
2025													
2025 No Project Background	104	515	55	57	10	38	52	1470	175	26	0	14	2516
2025 No Project Drive Access	0	0	0	0	0	2	13	0	0	0	0	0	15
2025 No Project Conditions	104	515	55	57	10	40	65	1470	175	26	0	14	2531
2025 Project Background	101	511	55	57	10	38	52	1447	164	22	0	13	2470
2025 No Project Drive Access	0	0	0	0	0	-2	-13	0	0	0	0	0	-15
2025 Project Drive Access	0	0	0	0	0	4	13	13	0	0	0	0	30
Change in Bkgrd (car-->BART)	-3	-4	0	0	0	0	0	-23	-11	-4	0	-1	-46
2025 Net Project Trips	-3	-4	0	0	0	2	0	-10	-11	-4	0	-1	-31
2025 Project Conditions	101	511	55	57	10	42	65	1460	164	22	0	13	2500
2025 Santa Clara West Option													
2025 SC West No Project Background	104	515	55	57	10	38	52	1470	175	26	0	14	2516
2025 SC West No Project Drive Access	0	0	0	0	0	2	13	0	0	0	0	0	15
2025 SC West No Project Conditions	104	515	55	57	10	40	65	1470	175	26	0	14	2531
2025 SC West Project Background	101	511	55	57	10	38	52	1447	164	22	0	13	2470
2025 SC West No Project Drive Access	0	0	0	0	0	-2	-13	0	0	0	0	0	-15
2025 SC West Project Drive Access	0	0	0	0	0	4	33	0	0	0	0	0	37
Change in Bkgrd (car-->BART)	-3	-4	0	0	0	0	0	-23	-11	-4	0	-1	-46
2025 SC West Net Project Trips	-3	-4	0	0	0	2	20	-23	-11	-4	0	-1	-24
2025 SC West Project Conditions	101	511	55	57	10	42	85	1447	164	22	0	13	2507
2035													
2035 No Project Background	119	711	55	57	10	38	52	1620	175	27	0	19	2883
2035 No Project Drive Access	0	0	0	0	0	5	31	0	0	0	0	0	36
2035 No Project Conditions	119	711	55	57	10	43	83	1620	175	27	0	19	2919
2035 Project Background	114	700	55	57	10	38	52	1599	162	22	0	18	2827
2035 No Project Drive Access	0	0	0	0	0	-5	-31	0	0	0	0	0	-36
2035 Project Drive Access	0	1	0	0	0	9	30	22	0	0	0	0	62
Change in Bkgrd (car-->BART)	-5	-11	0	0	0	0	0	-21	-13	-5	0	-1	-56
2035 Net Project Trips	-5	-10	0	0	0	4	-1	1	-13	-5	0	-1	-30
2035 Project Conditions	114	701	55	57	10	47	82	1621	162	22	0	18	2889
2035 Santa Clara West Option													
2035 SC West No Project Background	119	711	55	57	10	38	52	1620	175	27	0	19	2883
2035 SC West No Project Drive Access	0	0	0	0	0	5	31	0	0	0	0	0	36
2035 SC West No Project Conditions	119	711	55	57	10	43	83	1620	175	27	0	19	2919
2035 SC West Project Background	114	700	55	57	10	38	52	1599	162	22	0	18	2827
2035 SC West No Project Drive Access	0	0	0	0	0	-5	-31	0	0	0	0	0	-36
2035 SC West Project Drive Access	0	0	0	0	0	10	64	0	0	0	0	0	74
Change in Bkgrd (car-->BART)	-5	-11	0	0	0	0	0	-21	-13	-5	0	-1	-56
2035 SC West Net Project Trips	-5	-11	0	0	0	5	33	-21	-13	-5	0	-1	-18
2035 SC West Project Conditions	114	700	55	57	10	48	116	1599	162	22	0	18	2901

Intersection Number: 53
 Traffic Node #: 1213
 Model Node #: 8799
 Intersection Name: El Camino Real and The Alameda *
 Peak Hour: AM

Date of Analysis: 06/15/15
 Count Date: 10/08/14

Scenario:	Movements												Total:
	North Approach			East Approach			South Approach			West Approach			
	RT	TH	LT	RT	TH	LT	RT	TH	LT	RT	TH	LT	
Existing Conditions	49	418	10	3	1	1	18	1458	176	108	6	105	2353
Project Trips	1	-5	0	0	0	0	0	-27	-10	-8	0	2	-47
Existing Plus Project Conditions	50	413	10	3	1	1	18	1431	166	100	6	107	2306
2025													
2025 No Project Background	49	570	10	3	1	1	18	1593	176	206	6	200	2833
2025 No Project Drive Access	0	1	0	0	0	0	0	11	0	1	0	1	14
2025 No Project Conditions	49	571	10	3	1	1	18	1604	176	207	6	201	2847
2025 Project Background	49	560	10	3	1	1	18	1551	165	195	6	199	2758
2025 No Project Drive Access	0	-1	0	0	0	0	0	-11	0	-1	0	-1	-14
2025 Project Drive Access	1	1	0	0	0	0	0	14	0	0	0	4	20
Change in Bkgrd (car-->BART)	0	-10	0	0	0	0	0	-42	-11	-11	0	-1	-75
2025 Net Project Trips	1	-10	0	0	0	0	0	-39	-11	-12	0	2	-69
2025 Project Conditions	50	561	10	3	1	1	18	1565	165	195	6	203	2778
2025 Santa Clara West Option													
2025 SC West No Project Background	49	570	10	3	1	1	18	1593	176	206	6	200	2833
2025 SC West No Project Drive Access	0	1	0	0	0	0	0	11	0	1	0	1	14
2025 SC West No Project Conditions	49	571	10	3	1	1	18	1604	176	207	6	201	2847
2025 SC West Project Background	49	560	10	3	1	1	18	1551	165	195	6	199	2758
2025 SC West No Project Drive Access	0	-1	0	0	0	0	0	-11	0	-1	0	-1	-14
2025 SC West Project Drive Access	1	2	0	0	0	0	0	16	0	0	0	8	27
Change in Bkgrd (car-->BART)	0	-10	0	0	0	0	0	-42	-11	-11	0	-1	-75
2025 SC West Net Project Trips	1	-9	0	0	0	0	0	-37	-11	-12	0	6	-62
2025 SC West Project Conditions	50	562	10	3	1	1	18	1567	165	195	6	207	2785
2035													
2035 No Project Background	49	773	10	3	1	1	18	1648	176	242	6	260	3187
2035 No Project Drive Access	0	4	0	0	0	0	0	24	0	1	0	6	35
2035 No Project Conditions	49	777	10	3	1	1	18	1672	176	243	6	266	3222
2035 Project Background	49	754	10	3	1	1	18	1608	168	225	6	257	3100
2035 No Project Drive Access	0	-4	0	0	0	0	0	-24	0	-1	0	-6	-35
2035 Project Drive Access	1	4	0	0	0	0	0	27	0	0	0	10	42
Change in Bkgrd (car-->BART)	0	-19	0	0	0	0	0	-40	-8	-17	0	-3	-87
2035 Net Project Trips	1	-19	0	0	0	0	0	-37	-8	-18	0	7	-80
2035 Project Conditions	50	758	10	3	1	1	18	1635	168	225	6	267	3142
2035 Santa Clara West Option													
2035 SC West No Project Background	49	773	10	3	1	1	18	1648	176	242	6	260	3187
2035 SC West No Project Drive Access	0	4	0	0	0	0	0	24	0	1	0	6	35
2035 SC West No Project Conditions	49	777	10	3	1	1	18	1672	176	243	6	266	3222
2035 SC West Project Background	49	754	10	3	1	1	18	1608	168	225	6	257	3100
2035 SC West No Project Drive Access	0	-4	0	0	0	0	0	-24	0	-1	0	-6	-35
2035 SC West Project Drive Access	2	5	0	0	0	0	0	33	0	0	0	16	56
Change in Bkgrd (car-->BART)	0	-19	0	0	0	0	0	-40	-8	-17	0	-3	-87
2035 SC West Net Project Trips	2	-18	0	0	0	0	0	-31	-8	-18	0	7	-66
2035 SC West Project Conditions	51	759	10	3	1	1	18	1641	168	225	6	273	3156

Intersection Number: 54
 Traffix Node #: 107
 Model Node #: 8838
 Intersection Name: Lafayette St and Benton St
 Peak Hour: AM

Date of Analysis: 06/15/15
 Count Date: 10/08/14

Scenario:	Movements												Total:
	North Approach			East Approach			South Approach			West Approach			
	RT	TH	LT	RT	TH	LT	RT	TH	LT	RT	TH	LT	
Existing Conditions	28	371	7	7	59	19	171	1113	19	50	282	33	2159
Project Trips	0	-1	0	0	1	1	0	5	0	0	1	1	8
Existing Plus Project Conditions	28	370	7	7	60	20	171	1118	19	50	283	34	2167
2025													
2025 No Project Background	43	371	9	9	65	24	171	1191	19	58	310	74	2344
2025 No Project Drive Access	0	0	0	0	2	0	10	1	0	0	7	0	20
2025 No Project Conditions	43	371	9	9	67	24	181	1192	19	58	317	74	2364
2025 Project Background	42	368	9	9	65	24	170	1180	19	57	310	73	2326
2025 No Project Drive Access	0	0	0	0	-2	0	-10	-1	0	0	-7	0	-20
2025 Project Drive Access	0	0	0	0	3	1	11	10	0	0	8	2	35
Change in Bkgrd (car-->BART)	-1	-3	0	0	0	0	-1	-11	0	-1	0	-1	-18
2025 Net Project Trips	-1	-3	0	0	1	1	0	-2	0	-1	1	1	-3
2025 Project Conditions	42	368	9	9	68	25	181	1190	19	57	318	75	2361
2025 Santa Clara West Option													
2025 SC West No Project Background	43	371	9	9	65	24	171	1191	19	58	310	74	2344
2025 SC West No Project Drive Access	0	0	0	0	2	0	10	1	0	0	7	0	20
2025 SC West No Project Conditions	43	371	9	9	67	24	181	1192	19	58	317	74	2364
2025 SC West Project Background	42	368	9	9	65	24	170	1180	19	57	310	73	2326
2025 SC West No Project Drive Access	0	0	0	0	-2	0	-10	-1	0	0	-7	0	-20
2025 SC West Project Drive Access	0	0	0	0	3	1	18	0	0	0	14	0	36
Change in Bkgrd (car-->BART)	-1	-3	0	0	0	0	-1	-11	0	-1	0	-1	-18
2025 SC West Net Project Trips	-1	-3	0	0	1	1	7	-12	0	-1	7	-1	-2
2025 SC West Project Conditions	42	368	9	9	68	25	188	1180	19	57	324	73	2362
2035													
2035 No Project Background	45	400	10	9	73	32	171	1221	19	68	321	79	2448
2035 No Project Drive Access	0	0	0	0	3	1	15	1	0	0	10	0	30
2035 No Project Conditions	45	400	10	9	76	33	186	1222	19	68	331	79	2478
2035 Project Background	44	397	10	9	73	32	168	1215	19	65	321	78	2431
2035 No Project Drive Access	0	0	0	0	-3	-1	-15	-1	0	0	-10	0	-30
2035 Project Drive Access	0	1	0	0	7	2	16	17	0	0	11	6	60
Change in Bkgrd (car-->BART)	-1	-3	0	0	0	0	-3	-6	0	-3	0	-1	-17
2035 Net Project Trips	-1	-2	0	0	4	1	-2	10	0	-3	1	5	13
2035 Project Conditions	44	398	10	9	80	34	184	1232	19	65	332	84	2491
2035 Santa Clara West Option													
2035 SC West No Project Background	45	400	10	9	73	32	171	1221	19	68	321	79	2448
2035 SC West No Project Drive Access	0	0	0	0	3	1	15	1	0	0	10	0	30
2035 SC West No Project Conditions	45	400	10	9	76	33	186	1222	19	68	331	79	2478
2035 SC West Project Background	44	397	10	9	73	32	168	1215	19	65	321	78	2431
2035 SC West No Project Drive Access	0	0	0	0	-3	-1	-15	-1	0	0	-10	0	-30
2035 SC West Project Drive Access	0	0	0	0	8	3	32	0	0	0	27	0	70
Change in Bkgrd (car-->BART)	-1	-3	0	0	0	0	-3	-6	0	-3	0	-1	-17
2035 SC West Net Project Trips	-1	-3	0	0	5	2	14	-7	0	-3	17	-1	23
2035 SC West Project Conditions	44	397	10	9	81	35	200	1215	19	65	348	78	2501

Intersection Number: 55
 Traffix Node #: 9
 Model Node #: 6462
 Intersection Name: Coleman Ave and Brokaw Rd
 Peak Hour: AM

Date of Analysis: 06/15/15
 Count Date: 10/08/14

Scenario:	Movements												Total:
	North Approach			East Approach			South Approach			West Approach			
	RT	TH	LT	RT	TH	LT	RT	TH	LT	RT	TH	LT	
Existing Conditions	52	470	17	30	7	43	388	2060	140	72	24	131	3434
Project Trips	37	-19	0	0	0	0	0	-16	-1	0	0	1	2
Existing Plus Project Conditions	89	451	17	30	7	43	388	2044	139	72	24	132	3436
2025													
2025 No Project Background	61	1054	22	31	7	43	388	2248	153	75	24	131	4237
2025 No Project Drive Access	0	1	0	0	0	0	0	1	0	0	0	0	2
2025 No Project Conditions	61	1055	22	31	7	43	388	2249	153	75	24	131	4239
2025 Project Background	60	1027	22	31	7	43	388	2201	150	75	24	131	4159
2025 No Project Drive Access	0	-1	0	0	0	0	0	-1	0	0	0	0	-2
2025 Project Drive Access	54	0	0	0	0	0	0	1	8	1	0	2	66
Change in Bkgrd (car-->BART)	-1	-27	0	0	0	0	0	-47	-3	0	0	0	-78
2025 Net Project Trips	53	-28	0	0	0	0	0	-47	5	1	0	2	-14
2025 Project Conditions	114	1027	22	31	7	43	388	2202	158	76	24	133	4225
2025 Santa Clara West Option													
2025 SC West No Project Background	61	1054	22	31	7	43	388	2248	153	75	24	131	4237
2025 SC West No Project Drive Access	0	1	0	0	0	0	0	1	0	0	0	0	2
2025 SC West No Project Conditions	61	1055	22	31	7	43	388	2249	153	75	24	131	4239
2025 SC West Project Background	60	1027	22	31	7	43	388	2201	150	75	24	131	4159
2025 SC West No Project Drive Access	0	-1	0	0	0	0	0	-1	0	0	0	0	-2
2025 SC West Project Drive Access	0	0	0	0	0	0	0	6	1	1	0	0	8
Change in Bkgrd (car-->BART)	-1	-27	0	0	0	0	0	-47	-3	0	0	0	-78
2025 SC West Net Project Trips	-1	-28	0	0	0	0	0	-42	-2	1	0	0	-72
2025 SC West Project Conditions	60	1027	22	31	7	43	388	2207	151	76	24	131	4167
2035													
2035 No Project Background	74	1223	21	31	7	44	390	2283	156	77	24	134	4464
2035 No Project Drive Access	0	1	0	0	0	0	0	6	0	0	0	0	7
2035 No Project Conditions	74	1224	21	31	7	44	390	2289	156	77	24	134	4471
2035 Project Background	73	1191	21	31	7	44	390	2249	153	77	24	134	4394
2035 No Project Drive Access	0	-1	0	0	0	0	0	-6	0	0	0	0	-7
2035 Project Drive Access	101	1	0	0	0	0	0	5	17	3	0	3	130
Change in Bkgrd (car-->BART)	-1	-32	0	0	0	0	0	-34	-3	0	0	0	-70
2035 Net Project Trips	100	-32	0	0	0	0	0	-35	14	3	0	3	53
2035 Project Conditions	174	1192	21	31	7	44	390	2254	170	80	24	137	4524
2035 Santa Clara West Option													
2035 SC West No Project Background	74	1223	21	31	7	44	390	2283	156	77	24	134	4464
2035 SC West No Project Drive Access	0	1	0	0	0	0	0	6	0	0	0	0	7
2035 SC West No Project Conditions	74	1224	21	31	7	44	390	2289	156	77	24	134	4471
2035 SC West Project Background	73	1191	21	31	7	44	390	2249	153	77	24	134	4394
2035 SC West No Project Drive Access	0	-1	0	0	0	0	0	-6	0	0	0	0	-7
2035 SC West Project Drive Access	0	1	0	0	0	0	0	13	2	2	0	0	18
Change in Bkgrd (car-->BART)	-1	-32	0	0	0	0	0	-34	-3	0	0	0	-70
2035 SC West Net Project Trips	-1	-32	0	0	0	0	0	-27	-1	2	0	0	-59
2035 SC West Project Conditions	73	1192	21	31	7	44	390	2262	155	79	24	134	4412

Intersection Number: 56
 Traffix Node #: 3411
 Model Node #: 60625
 Intersection Name: Coleman Ave and Aviation Ave
 Peak Hour: AM

Date of Analysis: 06/15/15
 Count Date: 10/08/14

Scenario:	Movements												Total:
	North Approach			East Approach			South Approach			West Approach			
	RT	TH	LT	RT	TH	LT	RT	TH	LT	RT	TH	LT	
Existing Conditions	4	596	8	5	1	19	53	2690	25	8	1	0	3410
Project Trips	0	-20	0	0	0	0	0	-17	0	0	0	0	-37
Existing Plus Project Conditions	4	576	8	5	1	19	53	2673	25	8	1	0	3373
2025													
2025 No Project Background	4	1185	8	5	1	19	53	2895	25	8	1	0	4204
2025 No Project Drive Access	0	1	0	0	0	0	0	1	0	0	0	0	2
2025 No Project Conditions	4	1186	8	5	1	19	53	2896	25	8	1	0	4206
2025 Project Background	4	1157	8	5	1	19	53	2842	25	8	1	0	4123
2025 No Project Drive Access	0	-1	0	0	0	0	0	-1	0	0	0	0	-2
2025 Project Drive Access	0	1	0	0	0	0	0	9	0	0	0	0	10
Change in Bkgrd (car-->BART)	0	-28	0	0	0	0	0	-53	0	0	0	0	-81
2025 Net Project Trips	0	-28	0	0	0	0	0	-45	0	0	0	0	-73
2025 Project Conditions	4	1158	8	5	1	19	53	2851	25	8	1	0	4133
2025 Santa Clara West Option													
2025 SC West No Project Background	4	1185	8	5	1	19	53	2895	25	8	1	0	4204
2025 SC West No Project Drive Access	0	1	0	0	0	0	0	1	0	0	0	0	2
2025 SC West No Project Conditions	4	1186	8	5	1	19	53	2896	25	8	1	0	4206
2025 SC West Project Background	4	1157	8	5	1	19	53	2842	25	8	1	0	4123
2025 SC West No Project Drive Access	0	-1	0	0	0	0	0	-1	0	0	0	0	-2
2025 SC West Project Drive Access	0	1	0	0	0	0	0	7	0	0	0	0	8
Change in Bkgrd (car-->BART)	0	-28	0	0	0	0	0	-53	0	0	0	0	-81
2025 SC West Net Project Trips	0	-28	0	0	0	0	0	-47	0	0	0	0	-75
2025 SC West Project Conditions	4	1158	8	5	1	19	53	2849	25	8	1	0	4131
2035													
2035 No Project Background	4	1355	8	5	1	19	53	2931	25	8	1	0	4410
2035 No Project Drive Access	0	1	0	0	0	0	0	6	0	0	0	0	7
2035 No Project Conditions	4	1356	8	5	1	19	53	2937	25	8	1	0	4417
2035 Project Background	4	1323	8	5	1	19	53	2894	25	8	1	0	4341
2035 No Project Drive Access	0	-1	0	0	0	0	0	-6	0	0	0	0	-7
2035 Project Drive Access	0	3	0	0	0	0	0	22	0	0	0	0	25
Change in Bkgrd (car-->BART)	0	-32	0	0	0	0	0	-37	0	0	0	0	-69
2035 Net Project Trips	0	-30	0	0	0	0	0	-27	0	0	0	0	-51
2035 Project Conditions	4	1326	8	5	1	19	53	2916	25	8	1	0	4366
2035 Santa Clara West Option													
2035 SC West No Project Background	4	1355	8	5	1	19	53	2931	25	8	1	0	4410
2035 SC West No Project Drive Access	0	1	0	0	0	0	0	6	0	0	0	0	7
2035 SC West No Project Conditions	4	1356	8	5	1	19	53	2937	25	8	1	0	4417
2035 SC West Project Background	4	1323	8	5	1	19	53	2894	25	8	1	0	4341
2035 SC West No Project Drive Access	0	-1	0	0	0	0	0	-6	0	0	0	0	-7
2035 SC West Project Drive Access	0	3	0	0	0	0	0	16	0	0	0	0	19
Change in Bkgrd (car-->BART)	0	-32	0	0	0	0	0	-37	0	0	0	0	-69
2035 SC West Net Project Trips	0	-30	0	0	0	0	0	-27	0	0	0	0	-57
2035 SC West Project Conditions	4	1326	8	5	1	19	53	2910	25	8	1	0	4360

Intersection Number: 57
 Traffic Node #: 4047
 Model Node #: 4076
 Intersection Name: Coleman Ave and Newhall Dr
 Peak Hour: AM

Date of Analysis: 06/15/15
 Count Date: 10/08/14

Scenario:	Movements												Total:
	North Approach			East Approach			South Approach			West Approach			
	RT	TH	LT	RT	TH	LT	RT	TH	LT	RT	TH	LT	
Existing Conditions	73	552	1	0	0	0	0	2566	266	202	0	115	3775
Project Trips	0	-19	0	0	0	0	0	-18	0	-1	0	0	-38
Existing Plus Project Conditions	73	533	1	0	0	0	0	2548	266	201	0	115	3737
2025													
2025 No Project Background	73	1011	1	0	0	0	0	2690	492	367	0	115	4749
2025 No Project Drive Access	0	0	0	0	0	0	0	1	0	0	0	0	1
2025 No Project Conditions	73	1011	1	0	0	0	0	2691	492	367	0	115	4750
2025 Project Background	73	985	1	0	0	0	0	2639	482	361	0	115	4656
2025 No Project Drive Access	0	0	0	0	0	0	0	-1	0	0	0	0	-1
2025 Project Drive Access	0	0	0	0	0	0	0	3	0	0	0	0	3
Change in Bkgrd (car-->BART)	0	-26	0	0	0	0	0	-51	-10	-6	0	0	-93
2025 Net Project Trips	0	-26	0	0	0	0	0	-49	-10	-6	0	0	-91
2025 Project Conditions	73	985	1	0	0	0	0	2642	482	361	0	115	4659
2025 Santa Clara West Option													
2025 SC West No Project Background	73	1011	1	0	0	0	0	2690	492	367	0	115	4749
2025 SC West No Project Drive Access	0	0	0	0	0	0	0	1	0	0	0	0	1
2025 SC West No Project Conditions	73	1011	1	0	0	0	0	2691	492	367	0	115	4750
2025 SC West Project Background	73	985	1	0	0	0	0	2639	482	361	0	115	4656
2025 SC West No Project Drive Access	0	0	0	0	0	0	0	-1	0	0	0	0	-1
2025 SC West Project Drive Access	0	0	0	0	0	0	0	1	0	0	0	0	1
Change in Bkgrd (car-->BART)	0	-26	0	0	0	0	0	-51	-10	-6	0	0	-93
2025 SC West Net Project Trips	0	-26	0	0	0	0	0	-51	-10	-6	0	0	-93
2025 SC West Project Conditions	73	985	1	0	0	0	0	2640	482	361	0	115	4657
2035													
2035 No Project Background	73	1075	1	0	0	0	0	2657	691	502	0	115	5114
2035 No Project Drive Access	0	1	0	0	0	0	0	4	0	1	0	0	6
2035 No Project Conditions	73	1076	1	0	0	0	0	2661	691	503	0	115	5120
2035 Project Background	73	1045	1	0	0	0	0	2620	680	487	0	115	5021
2035 No Project Drive Access	0	-1	0	0	0	0	0	-4	0	-1	0	0	-6
2035 Project Drive Access	0	1	0	0	0	0	0	7	0	0	0	0	8
Change in Bkgrd (car-->BART)	0	-30	0	0	0	0	0	-37	-11	-15	0	0	-93
2035 Net Project Trips	0	-30	0	0	0	0	0	-34	-11	-16	0	0	-91
2035 Project Conditions	73	1046	1	0	0	0	0	2627	680	487	0	115	5029
2035 Santa Clara West Option													
2035 SC West No Project Background	73	1075	1	0	0	0	0	2657	691	502	0	115	5114
2035 SC West No Project Drive Access	0	1	0	0	0	0	0	4	0	1	0	0	6
2035 SC West No Project Conditions	73	1076	1	0	0	0	0	2661	691	503	0	115	5120
2035 SC West Project Background	73	1045	1	0	0	0	0	2620	680	487	0	115	5021
2035 SC West No Project Drive Access	0	-1	0	0	0	0	0	-4	0	-1	0	0	-6
2035 SC West Project Drive Access	0	0	0	0	0	0	0	2	0	0	0	0	2
Change in Bkgrd (car-->BART)	0	-30	0	0	0	0	0	-37	-11	-15	0	0	-93
2035 SC West Net Project Trips	0	-31	0	0	0	0	0	-39	-11	-16	0	0	-97
2035 SC West Project Conditions	73	1045	1	0	0	0	0	2622	680	487	0	115	5023

Intersection Number: 58
 Traffix Node #: 5444
 Model Node #: 6470
 Intersection Name: Lafayette St and Lewis St
 Peak Hour: AM

Date of Analysis: 06/15/15
 Count Date: 10/08/14

Scenario:	Movements												Total:
	North Approach			East Approach			South Approach			West Approach			
	RT	TH	LT	RT	TH	LT	RT	TH	LT	RT	TH	LT	
Existing Conditions	5	391	0	97	63	121	0	1069	5	0	0	0	1751
Project Trips	0	0	0	0	1	-1	0	3	0	0	0	0	3
Existing Plus Project Conditions	5	391	0	97	64	120	0	1072	5	0	0	0	1754
2025													
2025 No Project Background	9	506	0	115	97	121	0	1071	5	0	0	0	1924
2025 No Project Drive Access	0	0	0	0	0	0	0	1	0	0	0	0	1
2025 No Project Conditions	9	506	0	115	97	121	0	1072	5	0	0	0	1925
2025 Project Background	9	504	0	115	96	117	0	1061	5	0	0	0	1907
2025 No Project Drive Access	0	0	0	0	0	0	0	-1	0	0	0	0	-1
2025 Project Drive Access	0	0	0	0	0	0	0	7	0	0	0	0	7
Change in Bkgrd (car-->BART)	0	-2	0	0	-1	-4	0	-10	0	0	0	0	-17
2025 Net Project Trips	0	-2	0	0	-1	-4	0	-4	0	0	0	0	-11
2025 Project Conditions	9	504	0	115	96	117	0	1068	5	0	0	0	1914
2025 Santa Clara West Option													
2025 SC West No Project Background	9	506	0	115	97	121	0	1071	5	0	0	0	1924
2025 SC West No Project Drive Access	0	0	0	0	0	0	0	1	0	0	0	0	1
2025 SC West No Project Conditions	9	506	0	115	97	121	0	1072	5	0	0	0	1925
2025 SC West Project Background	9	504	0	115	96	117	0	1061	5	0	0	0	1907
2025 SC West No Project Drive Access	0	0	0	0	0	0	0	-1	0	0	0	0	-1
2025 SC West Project Drive Access	0	0	0	0	0	0	0	0	0	0	0	0	0
Change in Bkgrd (car-->BART)	0	-2	0	0	-1	-4	0	-10	0	0	0	0	-17
2025 SC West Net Project Trips	0	-2	0	0	-1	-4	0	-11	0	0	0	0	-18
2025 SC West Project Conditions	9	504	0	115	96	117	0	1061	5	0	0	0	1907
2035													
2035 No Project Background	12	573	0	142	128	121	0	1083	6	0	0	0	2065
2035 No Project Drive Access	0	0	0	0	0	0	0	1	0	0	0	0	1
2035 No Project Conditions	12	573	0	142	128	121	0	1084	6	0	0	0	2066
2035 Project Background	12	571	0	141	127	118	0	1079	6	0	0	0	2054
2035 No Project Drive Access	0	0	0	0	0	0	0	-1	0	0	0	0	-1
2035 Project Drive Access	0	0	0	0	1	1	0	8	0	0	0	0	10
Change in Bkgrd (car-->BART)	0	-2	0	-1	-1	-3	0	-4	0	0	0	0	-11
2035 Net Project Trips	0	-2	0	-1	0	-2	0	3	0	0	0	0	-2
2035 Project Conditions	12	571	0	141	128	119	0	1087	6	0	0	0	2064
2035 Santa Clara West Option													
2035 SC West No Project Background	12	573	0	142	128	121	0	1083	6	0	0	0	2065
2035 SC West No Project Drive Access	0	0	0	0	0	0	0	1	0	0	0	0	1
2035 SC West No Project Conditions	12	573	0	142	128	121	0	1084	6	0	0	0	2066
2035 SC West Project Background	12	571	0	141	127	118	0	1079	6	0	0	0	2054
2035 SC West No Project Drive Access	0	0	0	0	0	0	0	-1	0	0	0	0	-1
2035 SC West Project Drive Access	1	0	0	0	0	0	0	0	0	0	0	0	1
Change in Bkgrd (car-->BART)	0	-2	0	-1	-1	-3	0	-4	0	0	0	0	-11
2035 SC West Net Project Trips	1	-2	0	-1	-1	-3	0	-5	0	0	0	0	-11
2035 SC West Project Conditions	13	571	0	141	127	118	0	1079	6	0	0	0	2055

Intersection Number: 59
 Traffic Node #: 1008
 Model Node #: 7197
 Intersection Name: Lafayette St and Harrison St
 Peak Hour: AM

Date of Analysis: 06/15/15
 Count Date: 10/08/14

Scenario:	Movements												Total:
	North Approach			East Approach			South Approach			West Approach			
	RT	TH	LT	RT	TH	LT	RT	TH	LT	RT	TH	LT	
Existing Conditions	0	405	78	8	1	4	61	1088	2	14	23	3	1687
Project Trips	0	-2	0	0	0	0	0	5	0	0	0	0	3
Existing Plus Project Conditions	0	403	78	8	1	4	61	1093	2	14	23	3	1690
2025													
2025 No Project Background	0	405	91	8	1	19	169	1102	2	14	30	3	1844
2025 No Project Drive Access	0	0	0	0	0	0	0	1	0	0	0	0	1
2025 No Project Conditions	0	405	91	8	1	19	169	1103	2	14	30	3	1845
2025 Project Background	0	400	91	8	1	19	166	1093	2	14	30	2	1826
2025 No Project Drive Access	0	0	0	0	0	0	0	-1	0	0	0	0	-1
2025 Project Drive Access	0	0	0	0	0	0	6	6	0	0	1	1	14
Change in Bkgrd (car-->BART)	0	-5	0	0	0	0	-3	-9	0	0	0	-1	-18
2025 Net Project Trips	0	-5	0	0	0	0	3	-4	0	0	1	0	-5
2025 Project Conditions	0	400	91	8	1	19	172	1099	2	14	31	3	1840
2025 Santa Clara West Option													
2025 SC West No Project Background	0	405	91	8	1	19	169	1102	2	14	30	3	1844
2025 SC West No Project Drive Access	0	0	0	0	0	0	0	1	0	0	0	0	1
2025 SC West No Project Conditions	0	405	91	8	1	19	169	1103	2	14	30	3	1845
2025 SC West Project Background	0	400	91	8	1	19	166	1093	2	14	30	2	1826
2025 SC West No Project Drive Access	0	0	0	0	0	0	0	-1	0	0	0	0	-1
2025 SC West Project Drive Access	0	0	0	0	0	0	0	0	0	0	2	0	2
Change in Bkgrd (car-->BART)	0	-5	0	0	0	0	-3	-9	0	0	0	-1	-18
2025 SC West Net Project Trips	0	-5	0	0	0	0	-3	-10	0	0	2	-1	-17
2025 SC West Project Conditions	0	400	91	8	1	19	166	1093	2	14	32	2	1828
2035													
2035 No Project Background	0	429	106	8	1	30	185	1120	2	14	31	3	1929
2035 No Project Drive Access	0	0	0	0	0	0	0	1	0	0	1	0	2
2035 No Project Conditions	0	429	106	8	1	30	185	1121	2	14	32	3	1931
2035 Project Background	0	424	106	8	1	30	182	1116	2	14	31	3	1917
2035 No Project Drive Access	0	0	0	0	0	0	0	-1	0	0	-1	0	-2
2035 Project Drive Access	0	1	0	0	0	0	16	7	0	0	3	1	28
Change in Bkgrd (car-->BART)	0	-5	0	0	0	0	-3	-4	0	0	0	0	-12
2035 Net Project Trips	0	-4	0	0	0	0	13	2	0	0	2	1	14
2035 Project Conditions	0	425	106	8	1	30	198	1123	2	14	34	4	1945
2035 Santa Clara West Option													
2035 SC West No Project Background	0	429	106	8	1	30	185	1120	2	14	31	3	1929
2035 SC West No Project Drive Access	0	0	0	0	0	0	0	1	0	0	1	0	2
2035 SC West No Project Conditions	0	429	106	8	1	30	185	1121	2	14	32	3	1931
2035 SC West Project Background	0	424	106	8	1	30	182	1116	2	14	31	3	1917
2035 SC West No Project Drive Access	0	0	0	0	0	0	0	-1	0	0	-1	0	-2
2035 SC West Project Drive Access	0	0	0	0	0	0	0	0	0	0	4	0	4
Change in Bkgrd (car-->BART)	0	-5	0	0	0	0	-3	-4	0	0	0	0	-12
2035 SC West Net Project Trips	0	-5	0	0	0	0	-3	-5	0	0	3	0	-10
2035 SC West Project Conditions	0	424	106	8	1	30	182	1116	2	14	35	3	1921

Intersection Number: 60
 Traffic Node #: 5335
 Model Node #: 4798
 Intersection Name: De La Cruz Blvd and Central Expressway *
 Peak Hour: AM

Date of Analysis: 06/15/15
 Count Date: 10/08/14

Scenario:	Movements												Total:
	North Approach			East Approach			South Approach			West Approach			
	RT	TH	LT	RT	TH	LT	RT	TH	LT	RT	TH	LT	
Existing Conditions	1815	621	0	0	0	0	0	1129	1055	137	0	1054	5811
Project Trips	-4	-8	0	0	0	0	0	-6	-2	-2	0	-7	-29
Existing Plus Project Conditions	1811	613	0	0	0	0	0	1123	1053	135	0	1047	5782
2025													
2025 No Project Background	1881	621	0	0	0	0	0	1129	1326	484	0	1540	6981
2025 No Project Drive Access	0	9	0	0	0	0	0	6	0	3	0	5	23
2025 No Project Conditions	1881	630	0	0	0	0	0	1135	1326	487	0	1545	7004
2025 Project Background	1860	607	0	0	0	0	0	1121	1311	480	0	1531	6910
2025 No Project Drive Access	0	-9	0	0	0	0	0	-6	0	-3	0	-5	-23
2025 Project Drive Access	0	6	0	0	0	0	0	1	0	3	0	4	14
Change in Bkgrd (car-->BART)	-21	-14	0	0	0	0	0	-8	-15	-4	0	-9	-71
2025 Net Project Trips	-21	-17	0	0	0	0	0	-13	-15	-4	0	-10	-80
2025 Project Conditions	1860	613	0	0	0	0	0	1122	1311	483	0	1535	6924
2025 Santa Clara West Option													
2025 SC West No Project Background	1881	621	0	0	0	0	0	1129	1326	484	0	1540	6981
2025 SC West No Project Drive Access	0	9	0	0	0	0	0	6	0	3	0	5	23
2025 SC West No Project Conditions	1881	630	0	0	0	0	0	1135	1326	487	0	1545	7004
2025 SC West Project Background	1860	607	0	0	0	0	0	1121	1311	480	0	1531	6910
2025 SC West No Project Drive Access	0	-9	0	0	0	0	0	-6	0	-3	0	-5	-23
2025 SC West Project Drive Access	0	6	0	0	0	0	0	1	0	2	0	5	14
Change in Bkgrd (car-->BART)	-21	-14	0	0	0	0	0	-8	-15	-4	0	-9	-71
2025 SC West Net Project Trips	-21	-17	0	0	0	0	0	-13	-15	-5	0	-9	-80
2025 SC West Project Conditions	1860	613	0	0	0	0	0	1122	1311	482	0	1536	6924
2035													
2035 No Project Background	1834	621	0	0	0	0	0	1129	1407	591	0	1614	7196
2035 No Project Drive Access	0	12	0	0	0	0	0	8	1	1	0	9	31
2035 No Project Conditions	1834	633	0	0	0	0	0	1137	1408	592	0	1623	7227
2035 Project Background	1829	607	0	0	0	0	0	1121	1398	585	0	1605	7145
2035 No Project Drive Access	0	-12	0	0	0	0	0	-8	-1	-1	0	-9	-31
2035 Project Drive Access	0	12	0	0	0	0	0	3	0	1	0	6	22
Change in Bkgrd (car-->BART)	-5	-14	0	0	0	0	0	-8	-9	-6	0	-9	-51
2035 Net Project Trips	-5	-14	0	0	0	0	0	-13	-10	-6	0	-12	-60
2035 Project Conditions	1829	619	0	0	0	0	0	1124	1398	586	0	1611	7167
2035 Santa Clara West Option													
2035 SC West No Project Background	1834	621	0	0	0	0	0	1129	1407	591	0	1614	7196
2035 SC West No Project Drive Access	0	12	0	0	0	0	0	8	1	1	0	9	31
2035 SC West No Project Conditions	1834	633	0	0	0	0	0	1137	1408	592	0	1623	7227
2035 SC West Project Background	1829	607	0	0	0	0	0	1121	1398	585	0	1605	7145
2035 SC West No Project Drive Access	0	-12	0	0	0	0	0	-8	-1	-1	0	-9	-31
2035 SC West Project Drive Access	0	10	0	0	0	0	0	3	0	0	0	5	18
Change in Bkgrd (car-->BART)	-5	-14	0	0	0	0	0	-8	-9	-6	0	-9	-51
2035 SC West Net Project Trips	-5	-16	0	0	0	0	0	-13	-10	-7	0	-13	-64
2035 SC West Project Conditions	1829	617	0	0	0	0	0	1124	1398	585	0	1610	7163

Intersection Number: 61
 Trafix Node #: 6
 Model Node #: 6450
 Intersection Name: De La Cruz Blvd and Martin Ave
 Peak Hour: AM

Date of Analysis: 06/15/15
 Count Date: 10/08/14

Scenario:	Movements												Total:
	North Approach			East Approach			South Approach			West Approach			
	RT	TH	LT	RT	TH	LT	RT	TH	LT	RT	TH	LT	
Existing Conditions	169	458	65	207	113	11	8	1831	334	80	0	113	3389
Project Trips	0	-9	0	0	0	0	0	-8	-1	-2	0	0	-20
Existing Plus Project Conditions	169	449	65	207	113	11	8	1823	333	78	0	113	3369
2025													
2025 No Project Background	169	685	65	208	113	11	8	1970	368	134	0	113	3844
2025 No Project Drive Access	0	11	0	0	0	0	0	7	0	0	0	0	18
2025 No Project Conditions	169	696	65	208	113	11	8	1977	368	134	0	113	3862
2025 Project Background	168	670	65	208	113	11	8	1946	362	130	0	113	3794
2025 No Project Drive Access	0	-11	0	0	0	0	0	-7	0	0	0	0	-18
2025 Project Drive Access	0	10	0	0	0	0	0	2	0	0	0	0	12
Change in Bkgrd (car-->BART)	-1	-15	0	0	0	0	0	-24	-6	-4	0	0	-50
2025 Net Project Trips	-1	-16	0	0	0	0	0	-29	-6	-4	0	0	-56
2025 Project Conditions	168	680	65	208	113	11	8	1948	362	130	0	113	3806
2025 Santa Clara West Option													
2025 SC West No Project Background	169	685	65	208	113	11	8	1970	368	134	0	113	3844
2025 SC West No Project Drive Access	0	11	0	0	0	0	0	7	0	0	0	0	18
2025 SC West No Project Conditions	169	696	65	208	113	11	8	1977	368	134	0	113	3862
2025 SC West Project Background	168	670	65	208	113	11	8	1946	362	130	0	113	3794
2025 SC West No Project Drive Access	0	-11	0	0	0	0	0	-7	0	0	0	0	-18
2025 SC West Project Drive Access	0	10	0	0	0	0	0	2	0	0	0	0	12
Change in Bkgrd (car-->BART)	-1	-15	0	0	0	0	0	-24	-6	-4	0	0	-50
2025 SC West Net Project Trips	-1	-16	0	0	0	0	0	-29	-6	-4	0	0	-56
2025 SC West Project Conditions	168	680	65	208	113	11	8	1948	362	130	0	113	3806
2035													
2035 No Project Background	169	838	65	207	113	11	8	2005	392	157	0	113	4078
2035 No Project Drive Access	0	14	0	0	0	0	0	9	0	0	0	0	23
2035 No Project Conditions	169	852	65	207	113	11	8	2014	392	157	0	113	4101
2035 Project Background	168	819	65	207	113	11	8	1988	390	152	0	113	4034
2035 No Project Drive Access	0	-14	0	0	0	0	0	-9	0	0	0	0	-23
2035 Project Drive Access	0	13	0	0	0	0	0	3	0	1	0	0	17
Change in Bkgrd (car-->BART)	-1	-19	0	0	0	0	0	-17	-2	-5	0	0	-44
2035 Net Project Trips	-1	-20	0	0	0	0	0	-23	-2	-4	0	0	-50
2035 Project Conditions	168	832	65	207	113	11	8	1991	390	153	0	113	4051
2035 Santa Clara West Option													
2035 SC West No Project Background	169	838	65	207	113	11	8	2005	392	157	0	113	4078
2035 SC West No Project Drive Access	0	14	0	0	0	0	0	9	0	0	0	0	23
2035 SC West No Project Conditions	169	852	65	207	113	11	8	2014	392	157	0	113	4101
2035 SC West Project Background	168	819	65	207	113	11	8	1988	390	152	0	113	4034
2035 SC West No Project Drive Access	0	-14	0	0	0	0	0	-9	0	0	0	0	-23
2035 SC West Project Drive Access	0	11	0	0	0	0	0	3	0	0	0	0	14
Change in Bkgrd (car-->BART)	-1	-19	0	0	0	0	0	-17	-2	-5	0	0	-44
2035 SC West Net Project Trips	-1	-22	0	0	0	0	0	-23	-2	-5	0	0	-53
2035 SC West Project Conditions	168	830	65	207	113	11	8	1991	390	152	0	113	4048

Intersection Number: 63
 Traffix Node #: 3789
 Model Node #: 6858
 Intersection Name: 21st St and Santa Clara St
 Peak Hour: AM

Date of Analysis: 06/15/15
 Count Date: 10/09/14

Scenario:	Movements												Total:
	North Approach			East Approach			South Approach			West Approach			
	RT	TH	LT	RT	TH	LT	RT	TH	LT	RT	TH	LT	
Existing Conditions	7	1	6	10	634	5	27	3	76	9	369	5	1152
Project Trips	0	0	0	0	-28	0	0	0	0	0	30	-1	1
Existing Plus Project Conditions	7	1	6	10	606	5	27	3	76	9	399	4	1153
2025													
2025 No Project Background	15	1	8	10	636	5	27	3	76	9	407	6	1203
2025 No Project Drive Access	0	0	0	0	8	0	0	0	0	0	1	0	9
2025 No Project Conditions	15	1	8	10	644	5	27	3	76	9	408	6	1212
2025 Project Background	15	1	8	10	594	5	27	3	76	9	403	5	1156
2025 No Project Drive Access	0	0	0	0	-8	0	0	0	0	0	-1	0	-9
2025 Project Drive Access	0	0	0	0	6	0	0	0	0	0	32	0	38
Change in Bkgrd (car-->BART)	0	0	0	0	-42	0	0	0	0	0	-4	-1	-47
2025 Net Project Trips	0	0	0	0	-44	0	0	0	0	0	27	-1	-18
2025 Project Conditions	15	1	8	10	600	5	27	3	76	9	435	5	1194
2035													
2035 No Project Background	25	1	16	10	634	5	35	3	76	9	454	21	1289
2035 No Project Drive Access	0	0	0	0	13	0	0	0	0	0	1	0	14
2035 No Project Conditions	25	1	16	10	647	5	35	3	76	9	455	21	1303
2035 Project Background	24	1	16	10	583	5	34	3	76	9	447	19	1227
2035 No Project Drive Access	0	0	0	0	-13	0	0	0	0	0	-1	0	-14
2035 Project Drive Access	0	0	0	0	10	0	1	0	0	0	56	0	67
Change in Bkgrd (car-->BART)	-1	0	0	0	-51	0	-1	0	0	0	-7	-2	-62
2035 Net Project Trips	-1	0	0	0	-54	0	0	0	0	0	48	-2	-9
2035 Project Conditions	24	1	16	10	593	5	35	3	76	9	503	19	1294

Intersection Number: 64
 Traffix Node #: 4022
 Model Node #: 8526
 Intersection Name: 26th St and Santa Clara St
 Peak Hour: AM

Date of Analysis: 06/15/15
 Count Date: 10/09/14

Scenario:	Movements												Total:
	North Approach			East Approach			South Approach			West Approach			
	RT	TH	LT	RT	TH	LT	RT	TH	LT	RT	TH	LT	
Existing Conditions	26	58	40	37	587	22	67	80	12	9	415	16	1369
Project Trips	0	0	0	0	-9	0	0	0	0	0	63	0	54
Existing Plus Project Conditions	26	58	40	37	578	22	67	80	12	9	478	16	1423
2025													
2025 No Project Background	26	58	40	37	587	22	67	80	12	9	472	16	1426
2025 No Project Drive Access	0	0	0	0	2	0	0	0	0	0	1	0	3
2025 No Project Conditions	26	58	40	37	589	22	67	80	12	9	473	16	1429
2025 Project Background	26	58	40	37	565	22	67	80	12	9	468	16	1400
2025 No Project Drive Access	0	0	0	0	-2	0	0	0	0	0	-1	0	-3
2025 Project Drive Access	0	0	0	0	4	0	0	0	0	0	81	0	85
Change in Bkgrd (car-->BART)	0	0	0	0	-22	0	0	0	0	0	-4	0	-26
2025 Net Project Trips	0	0	0	0	-20	0	0	0	0	0	76	0	56
2025 Project Conditions	26	58	40	37	569	22	67	80	12	9	549	16	1485
2035													
2035 No Project Background	26	58	40	37	587	22	67	80	12	9	515	16	1469
2035 No Project Drive Access	0	0	0	0	2	0	0	0	0	0	5	0	7
2035 No Project Conditions	26	58	40	37	589	22	67	80	12	9	520	16	1476
2035 Project Background	26	58	40	37	566	22	67	80	12	9	509	16	1442
2035 No Project Drive Access	0	0	0	0	-2	0	0	0	0	0	-5	0	-7
2035 Project Drive Access	0	0	0	0	6	0	0	0	0	0	123	0	129
Change in Bkgrd (car-->BART)	0	0	0	0	-21	0	0	0	0	0	-6	0	-27
2035 Net Project Trips	0	0	0	0	-17	0	0	0	0	0	112	0	95
2035 Project Conditions	26	58	40	37	572	22	67	80	12	9	632	16	1571

Intersection Number: 1
 Traffix Node #: 3612
 Model Node #: 4028
 Intersection Name: 21st St and Julian St
 Peak Hour: PM

Date of Analysis: 06/15/15
 Count Date: 10/09/14

Scenario:	Movements												Total:
	North Approach			East Approach			South Approach			West Approach			
	RT	TH	LT	RT	TH	LT	RT	TH	LT	RT	TH	LT	
Existing Conditions	20	0	393	158	406	0	0	0	0	0	597	8	1582
Project Trips	0	0	-1	0	1	0	0	0	0	0	-10	0	-10
Existing Plus Project Conditions	20	0	392	158	407	0	0	0	0	0	587	8	1572
2025													
2025 No Project Background	20	0	393	177	406	0	0	0	0	0	688	9	1693
2025 No Project Drive Access	0	0	1	0	1	0	0	0	0	0	2	0	4
2025 No Project Conditions	20	0	394	177	407	0	0	0	0	0	690	9	1697
2025 Project Background	20	0	393	176	394	0	0	0	0	0	668	9	1660
2025 No Project Drive Access	0	0	-1	0	-1	0	0	0	0	0	-2	0	-4
2025 Project Drive Access	0	0	0	1	30	0	0	0	0	0	9	0	40
Change in Bkgrd (car-->BART)	0	0	0	-1	-12	0	0	0	0	0	-20	0	-33
2025 Net Project Trips	0	0	-1	0	17	0	0	0	0	0	-13	0	3
2025 Project Conditions	20	0	393	177	424	0	0	0	0	0	677	9	1700
2035													
2035 No Project Background	20	0	393	254	436	0	0	0	0	0	692	8	1803
2035 No Project Drive Access	0	0	0	0	0	0	0	0	0	0	3	0	3
2035 No Project Conditions	20	0	393	254	436	0	0	0	0	0	695	8	1806
2035 Project Background	20	0	392	251	420	0	0	0	0	0	665	8	1756
2035 No Project Drive Access	0	0	0	0	0	0	0	0	0	0	-3	0	-3
2035 Project Drive Access	0	0	1	3	35	0	0	0	0	0	12	0	51
Change in Bkgrd (car-->BART)	0	0	-1	-3	-16	0	0	0	0	0	-27	0	-47
2035 Net Project Trips	0	0	0	0	19	0	0	0	0	0	-18	0	1
2035 Project Conditions	20	0	393	254	455	0	0	0	0	0	677	8	1807

Intersection Number: 2
 Traffix Node #: 3613
 Model Node #: 8525
 Intersection Name: 24th St and Julian St
 Peak Hour: PM

Date of Analysis: 06/15/15
 Count Date: 10/09/14

Scenario:	Movements												Total:
	North Approach			East Approach			South Approach			West Approach			
	RT	TH	LT	RT	TH	LT	RT	TH	LT	RT	TH	LT	
Existing Conditions	0	0	0	0	443	179	155	0	118	239	757	0	1891
Project Trips	0	0	0	0	2	-3	-10	0	-1	-1	-10	0	-23
Existing Plus Project Conditions	0	0	0	0	445	176	145	0	117	238	747	0	1868
2025													
2025 No Project Background	0	0	0	0	443	250	155	0	173	292	757	0	2070
2025 No Project Drive Access	0	0	0	0	1	4	1	0	0	1	2	0	9
2025 No Project Conditions	0	0	0	0	444	254	156	0	173	293	759	0	2079
2025 Project Background	0	0	0	0	432	243	144	0	171	291	739	0	2020
2025 No Project Drive Access	0	0	0	0	-1	-4	-1	0	0	-1	-2	0	-9
2025 Project Drive Access	0	0	0	0	31	0	2	0	0	0	9	0	42
Change in Bkgrd (car-->BART)	0	0	0	0	-11	-7	-11	0	-2	-1	-18	0	-50
2025 Net Project Trips	0	0	0	0	19	-11	-10	0	-2	-2	-11	0	-17
2025 Project Conditions	0	0	0	0	463	243	146	0	171	291	748	0	2062
2035													
2035 No Project Background	0	0	0	0	474	254	155	0	214	284	757	0	2138
2035 No Project Drive Access	0	0	0	0	1	2	2	0	0	0	3	0	8
2035 No Project Conditions	0	0	0	0	475	256	157	0	214	284	760	0	2146
2035 Project Background	0	0	0	0	458	248	138	0	210	283	731	0	2068
2035 No Project Drive Access	0	0	0	0	-1	-2	-2	0	0	0	-3	0	-8
2035 Project Drive Access	0	0	0	0	39	1	6	0	0	0	12	0	58
Change in Bkgrd (car-->BART)	0	0	0	0	-16	-6	-17	0	-4	-1	-26	0	-70
2035 Net Project Trips	0	0	0	0	22	-7	-13	0	-4	-1	-17	0	-20
2035 Project Conditions	0	0	0	0	497	249	144	0	210	283	743	0	2126

Intersection Number: 3
 Traffic Node #: 4005
 Model Node #: 6443
 Intersection Name: 28th St and Julian St
 Peak Hour: PM

Date of Analysis: 06/15/15
 Count Date: 04/09/15

Scenario:	Movements												Total:
	North Approach			East Approach			South Approach			West Approach			
	RT	TH	LT	RT	TH	LT	RT	TH	LT	RT	TH	LT	
Existing Conditions	0	20	121	93	640	31	57	20	21	34	907	5	1949
Project Trips	0	0	-1	-1	-16	3	63	0	14	3	-21	-1	43
Existing Plus Project Conditions	0	20	120	92	624	34	120	20	35	37	886	4	1992
2025													
2025 No Project Background	9	20	121	99	704	105	57	22	26	34	907	10	2114
2025 No Project Drive Access	0	0	0	0	5	1	0	0	0	0	4	0	10
2025 No Project Conditions	9	20	121	99	709	106	57	22	26	34	911	10	2124
2025 Project Background	8	20	120	98	681	99	57	22	26	34	881	9	2055
2025 No Project Drive Access	0	0	0	0	-5	-1	0	0	0	0	-4	0	-10
2025 Project Drive Access	0	0	0	0	0	17	75	0	33	9	2	0	136
Change in Bkgrd (car->BART)	-1	0	-1	-1	-23	-6	0	0	0	0	-26	-1	-59
2025 Net Project Trips	-1	0	-1	-1	-28	10	75	0	33	9	-28	-1	67
2025 Project Conditions	8	20	120	98	681	116	132	22	59	43	883	9	2191
2035													
2035 No Project Background	16	20	121	102	783	159	66	22	34	34	907	18	2282
2035 No Project Drive Access	0	0	0	0	5	4	0	0	0	0	6	0	15
2035 No Project Conditions	16	20	121	102	788	163	66	22	34	34	913	18	2297
2035 Project Background	15	20	120	100	756	150	66	22	34	34	869	17	2203
2035 No Project Drive Access	0	0	0	0	-5	-4	0	0	0	0	-6	0	-15
2035 Project Drive Access	0	0	0	0	0	19	120	0	43	17	2	0	201
Change in Bkgrd (car->BART)	-1	0	-1	-2	-27	-9	0	0	0	0	-38	-1	-79
2035 Net Project Trips	-1	0	-1	-2	-32	6	120	0	43	17	-42	-1	107
2035 Project Conditions	15	20	120	100	756	169	186	22	77	51	871	17	2404

Intersection Number: 4
 Traffic Node #: 3210
 Model Node #: 60610
 Intersection Name: US-101 SB and Julian St
 Peak Hour: PM

Date of Analysis: 06/15/15
 Count Date: 10/09/14

Scenario:	Movements												Total:
	North Approach			East Approach			South Approach			West Approach			
	RT	TH	LT	RT	TH	LT	RT	TH	LT	RT	TH	LT	
Existing Conditions	0	0	0	0	756	591	396	0	53	540	646	0	2982
Project Trips	0	0	0	0	-7	0	-4	0	-6	56	-15	0	24
Existing Plus Project Conditions	0	0	0	0	749	591	392	0	47	596	631	0	3006
2025													
2025 No Project Background	0	0	0	0	861	1051	396	0	91	540	734	0	3673
2025 No Project Drive Access	0	0	0	0	7	19	0	0	0	0	5	0	31
2025 No Project Conditions	0	0	0	0	868	1070	396	0	91	540	739	0	3704
2025 Project Background	0	0	0	0	840	1041	396	0	80	537	709	0	3603
2025 No Project Drive Access	0	0	0	0	-7	-19	0	0	0	0	-5	0	-31
2025 Project Drive Access	0	0	0	0	17	0	0	0	0	66	11	0	94
Change in Bkgrd (car->BART)	0	0	0	0	-21	-10	0	0	-11	-3	-25	0	-70
2025 Net Project Trips	0	0	0	0	-11	-29	0	0	-11	63	-19	0	-7
2025 Project Conditions	0	0	0	0	857	1041	396	0	80	603	720	0	3697
2035													
2035 No Project Background	0	0	0	0	981	924	396	0	108	540	673	0	3622
2035 No Project Drive Access	0	0	0	0	8	12	0	0	0	0	5	0	25
2035 No Project Conditions	0	0	0	0	989	936	396	0	108	540	678	0	3647
2035 Project Background	0	0	0	0	953	918	396	0	99	537	636	0	3539
2035 No Project Drive Access	0	0	0	0	-8	-12	0	0	0	0	-5	0	-25
2035 Project Drive Access	0	0	0	0	19	0	0	0	0	103	19	0	141
Change in Bkgrd (car->BART)	0	0	0	0	-28	-6	0	0	-9	-3	-37	0	-83
2035 Net Project Trips	0	0	0	0	-17	-18	0	0	-9	100	-23	0	33
2035 Project Conditions	0	0	0	0	972	918	396	0	99	640	655	0	3680

Intersection Number: 5
 Traffix Node #: 3211
 Model Node #: 60613
 Intersection Name: US-101 NB and McKee Rd
 Peak Hour: PM

Date of Analysis: 06/15/15
 Count Date: 10/09/14

Scenario:	Movements												Total:
	North Approach			East Approach			South Approach			West Approach			
	RT	TH	LT	RT	TH	LT	RT	TH	LT	RT	TH	LT	
Existing Conditions	0	0	0	334	1006	0	573	0	310	0	1013	96	3332
Project Trips	0	0	0	-5	-13	0	0	0	6	0	-14	-5	-31
Existing Plus Project Conditions	0	0	0	329	993	0	573	0	316	0	999	91	3301
2025													
2025 No Project Background	0	0	0	334	1006	0	672	0	310	0	1478	96	3896
2025 No Project Drive Access	0	0	0	0	6	0	5	0	0	0	4	0	15
2025 No Project Conditions	0	0	0	334	1012	0	677	0	310	0	1482	96	3911
2025 Project Background	0	0	0	330	994	0	668	0	310	0	1449	93	3844
2025 No Project Drive Access	0	0	0	0	-6	0	-5	0	0	0	-4	0	-15
2025 Project Drive Access	0	0	0	0	2	0	1	0	2	0	10	2	17
Change in Bkgrd (car->BART)	0	0	0	-4	-12	0	-4	0	0	0	-29	-3	-52
2025 Net Project Trips	0	0	0	-4	-16	0	-8	0	2	0	-23	-1	-50
2025 Project Conditions	0	0	0	330	996	0	669	0	312	0	1459	95	3861
2035													
2035 No Project Background	0	0	0	334	1006	0	779	0	310	0	1508	96	4033
2035 No Project Drive Access	0	0	0	0	5	0	23	0	0	0	6	0	34
2035 No Project Conditions	0	0	0	334	1011	0	802	0	310	0	1514	96	4067
2035 Project Background	0	0	0	331	989	0	766	0	310	0	1467	94	3957
2035 No Project Drive Access	0	0	0	0	-5	0	-23	0	0	0	-6	0	-34
2035 Project Drive Access	0	0	0	0	5	0	2	0	3	0	17	2	29
Change in Bkgrd (car->BART)	0	0	0	-3	-17	0	-13	0	0	0	-41	-2	-76
2035 Net Project Trips	0	0	0	-3	-17	0	-34	0	3	0	-30	0	-81
2035 Project Conditions	0	0	0	331	994	0	768	0	313	0	1484	96	3986

Intersection Number: 6
 Traffix Node #: 3625
 Model Node #: 8730
 Intersection Name: King Rd and McKee Rd
 Peak Hour: PM

Date of Analysis: 06/15/15
 Count Date: 10/08/14

Scenario:	Movements												Total:
	North Approach			East Approach			South Approach			West Approach			
	RT	TH	LT	RT	TH	LT	RT	TH	LT	RT	TH	LT	
Existing Conditions	358	500	120	111	788	117	98	202	95	123	805	330	3647
Project Trips	-1	12	3	1	-13	-1	0	9	0	0	-14	1	-3
Existing Plus Project Conditions	357	512	123	112	775	116	98	211	95	123	791	331	3644
2025													
2025 No Project Background	358	657	120	114	788	219	107	272	103	294	1185	436	4653
2025 No Project Drive Access	7	167	4	1	0	0	0	21	0	0	2	7	209
2025 No Project Conditions	365	824	124	115	788	219	107	293	103	294	1187	443	4862
2025 Project Background	355	650	119	114	776	218	107	271	103	292	1163	429	4597
2025 No Project Drive Access	-7	-167	-4	-1	0	0	0	-21	0	0	-2	-7	-209
2025 Project Drive Access	1	25	3	1	1	0	0	8	0	2	7	1	49
Change in Bkgrd (car->BART)	-3	-7	-1	0	-12	-1	0	-1	0	-2	-22	-7	-56
2025 Net Project Trips	-9	-149	-2	0	-11	-1	0	-14	0	0	-17	-13	-216
2025 Project Conditions	356	675	122	115	777	218	107	279	103	294	1170	430	4646
2035													
2035 No Project Background	358	751	120	115	788	207	181	453	112	261	1199	580	5125
2035 No Project Drive Access	6	186	4	1	0	0	0	42	0	0	2	27	268
2035 No Project Conditions	364	937	124	116	788	207	181	495	112	261	1201	607	5393
2035 Project Background	354	743	119	115	773	206	181	449	112	260	1175	555	5042
2035 No Project Drive Access	-6	-186	-4	-1	0	0	0	-42	0	0	-2	-27	-268
2035 Project Drive Access	0	27	4	1	2	0	0	10	1	4	9	1	59
Change in Bkgrd (car->BART)	-4	-8	-1	0	-15	-1	0	-4	0	-1	-24	-25	-83
2035 Net Project Trips	-10	-167	-1	0	-13	-1	0	-36	1	3	-17	-51	-292
2035 Project Conditions	354	770	123	116	775	206	181	459	113	264	1184	556	5101

Intersection Number: 7
 Traffic Node #: 3783
 Model Node #: 4710
 Intersection Name: 17th St and Santa Clara St
 Peak Hour: PM

Date of Analysis: 06/15/15
 Count Date: 10/09/14

Scenario:	Movements												Total:
	North Approach			East Approach			South Approach			West Approach			
	RT	TH	LT	RT	TH	LT	RT	TH	LT	RT	TH	LT	
Existing Conditions	3	54	143	38	346	5	22	27	9	17	916	16	1596
Project Trips	0	0	0	0	-2	1	0	0	0	0	-14	0	-15
Existing Plus Project Conditions	3	54	143	38	344	6	22	27	9	17	902	16	1581
2025													
2025 No Project Background	5	54	143	50	486	5	22	33	14	17	916	20	1765
2025 No Project Drive Access	0	1	0	0	0	0	0	0	0	0	5	0	6
2025 No Project Conditions	5	55	143	50	486	5	22	33	14	17	921	20	1771
2025 Project Background	5	54	143	50	481	5	22	33	14	17	896	20	1740
2025 No Project Drive Access	0	-1	0	0	0	0	0	0	0	0	-5	0	-6
2025 Project Drive Access	0	0	0	0	4	1	0	0	0	0	8	0	13
Change in Bkgrd (car-->BART)	0	0	0	0	-5	0	0	0	0	0	-20	0	-25
2025 Net Project Trips	0	-1	0	0	-1	1	0	0	0	0	-17	0	-18
2025 Project Conditions	5	54	143	50	485	6	22	33	14	17	904	20	1753
2035													
2035 No Project Background	6	54	161	64	585	12	22	42	20	43	916	18	1943
2035 No Project Drive Access	0	1	0	0	1	0	0	0	0	1	8	0	11
2035 No Project Conditions	6	55	161	64	586	12	22	42	20	44	924	18	1954
2035 Project Background	6	54	160	64	576	12	22	42	20	41	881	18	1896
2035 No Project Drive Access	0	-1	0	0	-1	0	0	0	0	-1	-8	0	-11
2035 Project Drive Access	0	0	0	0	25	2	1	0	0	1	13	0	42
Change in Bkgrd (car-->BART)	0	0	-1	0	-9	0	0	0	0	-2	-35	0	-47
2035 Net Project Trips	0	-1	-1	0	15	2	1	0	0	-2	-30	0	-16
2035 Project Conditions	6	54	160	64	601	14	23	42	20	42	894	18	1938

Intersection Number: 8
 Traffic Node #: 3790
 Model Node #: 8524
 Intersection Name: 24th St and Santa Clara St
 Peak Hour: PM

Date of Analysis: 06/15/15
 Count Date: 11/05/13

Scenario:	Movements												Total:
	North Approach			East Approach			South Approach			West Approach			
	RT	TH	LT	RT	TH	LT	RT	TH	LT	RT	TH	LT	
Existing Conditions	42	254	40	36	389	140	102	123	44	123	883	68	2244
Project Trips	0	-4	0	0	1	12	8	-2	-1	-3	-2	-7	2
Existing Plus Project Conditions	42	250	40	36	390	152	110	121	43	120	881	61	2246
2025													
2025 No Project Background	60	256	115	64	462	149	103	123	65	130	883	68	2478
2025 No Project Drive Access	0	5	0	0	0	0	0	1	0	1	2	1	10
2025 No Project Conditions	60	261	115	64	462	149	103	124	65	131	885	69	2488
2025 Project Background	59	250	114	64	461	149	103	120	64	126	875	60	2445
2025 No Project Drive Access	0	-5	0	0	0	0	0	-1	0	-1	-2	-1	-10
2025 Project Drive Access	0	0	0	0	6	25	15	1	0	1	7	1	56
Change in Bkgrd (car-->BART)	-1	-6	-1	0	-1	0	0	-3	-1	-4	-8	-8	-33
2025 Net Project Trips	-1	-11	-1	0	5	25	15	-3	-1	-4	-3	-8	13
2025 Project Conditions	59	250	114	64	467	174	118	121	64	127	882	61	2501
2035													
2035 No Project Background	72	254	102	74	519	158	102	163	90	169	883	80	2666
2035 No Project Drive Access	0	2	0	0	0	1	0	1	0	2	4	1	11
2035 No Project Conditions	72	256	102	74	519	159	102	164	90	171	887	81	2677
2035 Project Background	71	248	101	74	516	158	102	157	88	163	869	66	2613
2035 No Project Drive Access	0	-2	0	0	0	-1	0	-1	0	-2	-4	-1	-11
2035 Project Drive Access	0	0	0	0	27	30	14	3	0	2	9	2	87
Change in Bkgrd (car-->BART)	-1	-6	-1	0	-3	0	0	-6	-2	-6	-14	-14	-53
2035 Net Project Trips	-1	-8	-1	0	24	29	14	-4	-2	-6	-9	-13	23
2035 Project Conditions	71	248	101	74	543	188	116	160	88	165	878	68	2700

Intersection Number: 9
 Traffix Node #: 3788
 Model Node #: 6586
 Intersection Name: 28th St and Santa Clara St
 Peak Hour: PM

Date of Analysis: 06/15/15
 Count Date: 10/09/14

Scenario:	Movements												Total:
	North Approach			East Approach			South Approach			West Approach			
	RT	TH	LT	RT	TH	LT	RT	TH	LT	RT	TH	LT	
Existing Conditions	19	61	74	65	513	143	141	36	23	40	863	18	1996
Project Trips	13	1	78	21	0	0	-2	1	0	0	-6	10	116
Existing Plus Project Conditions	32	62	152	86	513	143	139	37	23	40	857	28	2112
2025													
2025 No Project Background	19	143	74	74	635	143	151	36	24	65	863	18	2245
2025 No Project Drive Access	0	1	0	0	0	0	0	0	0	0	2	0	3
2025 No Project Conditions	19	144	74	74	635	143	151	36	24	65	865	18	2248
2025 Project Background	19	137	73	74	632	143	149	36	24	65	852	18	2222
2025 No Project Drive Access	0	-1	0	0	0	0	0	0	0	0	-2	0	-3
2025 Project Drive Access	31	10	174	34	0	0	0	2	0	0	2	18	271
Change in Bkgrd (car-->BART)	0	-6	-1	0	-3	0	-2	0	0	0	-11	0	-23
2025 Net Project Trips	31	3	173	34	-3	0	-2	2	0	0	-11	18	245
2025 Project Conditions	50	147	247	108	632	143	149	38	24	65	854	36	2493
2035													
2035 No Project Background	38	195	74	77	691	143	143	48	24	51	863	19	2366
2035 No Project Drive Access	1	3	0	0	0	0	0	0	0	0	4	0	8
2035 No Project Conditions	39	198	74	77	691	143	143	48	24	51	867	19	2374
2035 Project Background	38	187	73	77	687	143	141	48	24	51	844	19	2332
2035 No Project Drive Access	-1	-3	0	0	0	0	0	0	0	0	-4	0	-8
2035 Project Drive Access	57	28	170	39	0	0	0	5	0	0	4	20	323
Change in Bkgrd (car-->BART)	0	-8	-1	0	-4	0	-2	0	0	0	-19	0	-34
2035 Net Project Trips	56	17	169	39	-4	0	-2	5	0	0	-19	20	281
2035 Project Conditions	95	215	243	116	687	143	141	53	24	51	848	39	2655

Intersection Number: 10
 Traffix Node #: 3023
 Model Node #: 8517
 Intersection Name: US-101 SB and Santa Clara St *
 Peak Hour: PM

Date of Analysis: 06/15/15
 Count Date: 09/09/14

Scenario:	Movements												Total:
	North Approach			East Approach			South Approach			West Approach			
	RT	TH	LT	RT	TH	LT	RT	TH	LT	RT	TH	LT	
Existing Conditions	200	4	247	0	630	453	0	0	0	492	696	0	2722
Project Trips	0	0	-2	0	21	-1	0	0	0	73	-3	0	88
Existing Plus Project Conditions	200	4	245	0	651	452	0	0	0	565	693	0	2810
2025													
2025 No Project Background	200	4	417	0	761	697	0	0	0	492	738	0	3309
2025 No Project Drive Access	0	0	0	0	0	86	0	0	0	0	2	0	88
2025 No Project Conditions	200	4	417	0	761	783	0	0	0	492	740	0	3397
2025 Project Background	199	4	411	0	758	691	0	0	0	485	730	0	3278
2025 No Project Drive Access	0	0	0	0	0	-86	0	0	0	0	-2	0	-88
2025 Project Drive Access	0	0	6	0	34	0	0	0	0	171	6	0	217
Change in Bkgrd (car-->BART)	-1	0	-6	0	-3	-6	0	0	0	-7	-8	0	-31
2025 Net Project Trips	-1	0	0	0	31	-92	0	0	0	164	-4	0	98
2025 Project Conditions	199	4	417	0	792	691	0	0	0	656	736	0	3495
2035													
2035 No Project Background	204	4	520	0	813	802	0	0	0	492	910	0	3745
2035 No Project Drive Access	0	0	0	0	0	99	0	0	0	0	5	0	104
2035 No Project Conditions	204	4	520	0	813	901	0	0	0	492	915	0	3849
2035 Project Background	203	4	514	0	809	796	0	0	0	489	892	0	3707
2035 No Project Drive Access	0	0	0	0	0	-99	0	0	0	0	-5	0	-104
2035 Project Drive Access	0	0	8	0	39	2	0	0	0	162	11	0	222
Change in Bkgrd (car-->BART)	-1	0	-6	0	-4	-6	0	0	0	-3	-18	0	-38
2035 Net Project Trips	-1	0	2	0	35	-103	0	0	0	159	-12	0	80
2035 Project Conditions	203	4	522	0	848	798	0	0	0	651	903	0	3929

Intersection Number: 11
 Traffix Node #: 3016
 Model Node #: 8514
 Intersection Name: US-101 NB and Santa Clara St *
 Peak Hour: PM

Date of Analysis: 06/15/15
 Count Date: 09/09/14

Scenario:	Movements												Total:
	North Approach			East Approach			South Approach			West Approach			
	RT	TH	LT	RT	TH	LT	RT	TH	LT	RT	TH	LT	
Existing Conditions	0	0	0	240	803	0	373	2	320	0	854	125	2717
Project Trips	0	0	0	0	0	0	0	0	21	0	-3	-2	16
Existing Plus Project Conditions	0	0	0	240	803	0	373	2	341	0	851	123	2733
2025													
2025 No Project Background	0	0	0	240	1107	0	401	2	387	0	973	216	3326
2025 No Project Drive Access	0	0	0	0	86	0	2	0	0	0	2	1	91
2025 No Project Conditions	0	0	0	240	1193	0	403	2	387	0	975	217	3417
2025 Project Background	0	0	0	240	1100	0	401	2	387	0	963	213	3306
2025 No Project Drive Access	0	0	0	0	-86	0	-2	0	0	0	-2	-1	-91
2025 Project Drive Access	0	0	0	0	1	0	0	0	32	0	11	1	45
Change in Bkgrd (car-->BART)	0	0	0	0	-7	0	0	0	0	0	-10	-3	-20
2025 Net Project Trips	0	0	0	0	-92	0	-2	0	32	0	-1	-3	-66
2025 Project Conditions	0	0	0	240	1101	0	401	2	419	0	974	214	3351
2035													
2035 No Project Background	0	0	0	240	1233	0	551	2	421	0	1098	365	3910
2035 No Project Drive Access	0	0	0	0	99	0	10	0	0	0	4	1	114
2035 No Project Conditions	0	0	0	240	1332	0	561	2	421	0	1102	366	4024
2035 Project Background	0	0	0	240	1224	0	550	2	420	0	1086	353	3875
2035 No Project Drive Access	0	0	0	0	-99	0	-10	0	0	0	-4	-1	-114
2035 Project Drive Access	0	0	0	0	5	0	0	0	37	0	18	1	61
Change in Bkgrd (car-->BART)	0	0	0	0	-9	0	-1	0	-1	0	-12	-12	-35
2035 Net Project Trips	0	0	0	0	-103	0	-11	0	36	0	2	-12	-88
2035 Project Conditions	0	0	0	240	1229	0	550	2	457	0	1104	354	3936

Intersection Number: 12
 Traffix Node #: 3762
 Model Node #: 8523
 Intersection Name: 24th St and San Antonio St
 Peak Hour: PM

Date of Analysis: 06/15/15
 Count Date: 10/09/14

Scenario:	Movements												Total:
	North Approach			East Approach			South Approach			West Approach			
	RT	TH	LT	RT	TH	LT	RT	TH	LT	RT	TH	LT	
Existing Conditions	20	329	20	29	80	87	102	270	41	38	143	7	1166
Project Trips	1	6	0	0	0	0	0	5	0	0	0	0	12
Existing Plus Project Conditions	21	335	20	29	80	87	102	275	41	38	143	7	1178
2025													
2025 No Project Background	32	329	55	29	81	90	128	291	41	38	143	7	1264
2025 No Project Drive Access	1	5	0	0	0	0	0	1	0	0	0	0	7
2025 No Project Conditions	33	334	55	29	81	90	128	292	41	38	143	7	1271
2025 Project Background	29	322	55	29	81	90	128	288	41	38	143	7	1251
2025 No Project Drive Access	-1	-5	0	0	0	0	0	-1	0	0	0	0	-7
2025 Project Drive Access	1	24	0	0	0	0	0	14	0	0	0	1	40
Change in Bkgrd (car-->BART)	-3	-7	0	0	0	0	0	-3	0	0	0	0	-13
2025 Net Project Trips	-3	12	0	0	0	0	0	10	0	0	0	1	20
2025 Project Conditions	30	346	55	29	81	90	128	302	41	38	143	8	1291
2035													
2035 No Project Background	31	329	92	29	85	96	127	353	43	38	181	12	1416
2035 No Project Drive Access	1	4	0	0	0	0	1	2	0	0	0	0	8
2035 No Project Conditions	32	333	92	29	85	96	128	355	43	38	181	12	1424
2035 Project Background	30	321	91	29	85	96	127	347	43	38	180	9	1396
2035 No Project Drive Access	-1	-4	0	0	0	0	-1	-2	0	0	0	0	-8
2035 Project Drive Access	3	26	0	0	0	0	0	17	0	0	1	1	48
Change in Bkgrd (car-->BART)	-1	-8	-1	0	0	0	0	-6	0	0	-1	-3	-20
2035 Net Project Trips	1	14	-1	0	0	0	-1	9	0	0	0	-2	20
2035 Project Conditions	33	347	91	29	85	96	127	364	43	38	181	10	1444

Intersection Number: 13
 Traffic Node #: 3832
 Model Node #: 8521
 Intersection Name: 24th St and E William St
 Peak Hour: PM

Date of Analysis: 06/15/15
 Count Date: 10/09/14

Scenario:	Movements												Total:
	North Approach			East Approach			South Approach			West Approach			
	RT	TH	LT	RT	TH	LT	RT	TH	LT	RT	TH	LT	
Existing Conditions	25	425	7	3	17	30	69	364	121	192	35	40	1328
Project Trips	0	8	-4	-1	0	-1	-1	7	0	0	0	0	8
Existing Plus Project Conditions	25	433	3	2	17	29	68	371	121	192	35	40	1336
2025													
2025 No Project Background	26	425	7	23	28	39	78	392	122	194	43	40	1417
2025 No Project Drive Access	0	4	1	0	0	0	0	1	0	0	0	0	6
2025 No Project Conditions	26	429	8	23	28	39	78	393	122	194	43	40	1423
2025 Project Background	26	421	4	22	28	36	76	390	122	194	43	40	1402
2025 No Project Drive Access	0	-4	-1	0	0	0	0	-1	0	0	0	0	-6
2025 Project Drive Access	0	23	1	0	0	0	0	14	0	0	0	0	38
Change in Bkgrd (car-->BART)	0	-4	-3	-1	0	-3	-2	-2	0	0	0	0	-15
2025 Net Project Trips	0	15	-3	-1	0	-3	-2	11	0	0	0	0	17
2025 Project Conditions	26	444	5	22	28	36	76	404	122	194	43	40	1440
2035													
2035 No Project Background	25	425	7	50	32	56	82	429	121	204	66	40	1537
2035 No Project Drive Access	0	2	1	0	0	0	0	2	0	0	0	0	5
2035 No Project Conditions	25	427	8	50	32	56	82	431	121	204	66	40	1542
2035 Project Background	25	422	2	47	32	54	80	426	121	204	65	40	1518
2035 No Project Drive Access	0	-2	-1	0	0	0	0	-2	0	0	0	0	-5
2035 Project Drive Access	0	25	1	0	0	0	0	16	0	0	0	0	42
Change in Bkgrd (car-->BART)	0	-3	-5	-3	0	-2	-2	-3	0	0	-1	0	-19
2035 Net Project Trips	0	20	-5	-3	0	-2	-2	11	0	0	-1	0	18
2035 Project Conditions	25	447	3	47	32	54	80	442	121	204	65	40	1560

Intersection Number: 14
 Traffic Node #: 3036
 Model Node #: 60617
 Intersection Name: McLaughlin Ave and I-280 SB *
 Peak Hour: PM

Date of Analysis: 06/15/15
 Count Date: 09/24/14

Scenario:	Movements												Total:
	North Approach			East Approach			South Approach			West Approach			
	RT	TH	LT	RT	TH	LT	RT	TH	LT	RT	TH	LT	
Existing Conditions	0	557	0	0	0	0	0	783	0	546	0	273	2159
Project Trips	0	4	0	0	0	0	0	6	0	-2	0	0	8
Existing Plus Project Conditions	0	561	0	0	0	0	0	789	0	544	0	273	2167
2025													
2025 No Project Background	0	580	0	0	0	0	0	841	0	546	0	273	2240
2025 No Project Drive Access	0	2	0	0	0	0	0	2	0	4	0	0	8
2025 No Project Conditions	0	582	0	0	0	0	0	843	0	550	0	273	2248
2025 Project Background	0	579	0	0	0	0	0	836	0	539	0	272	2226
2025 No Project Drive Access	0	-2	0	0	0	0	0	-2	0	-4	0	0	-8
2025 Project Drive Access	0	16	0	0	0	0	0	14	0	4	0	1	35
Change in Bkgrd (car-->BART)	0	-1	0	0	0	0	0	-5	0	-7	0	-1	-14
2025 Net Project Trips	0	13	0	0	0	0	0	7	0	-7	0	0	13
2025 Project Conditions	0	595	0	0	0	0	0	850	0	543	0	273	2261
2035													
2035 No Project Background	0	580	0	0	0	0	0	916	0	546	0	273	2315
2035 No Project Drive Access	0	1	0	0	0	0	0	3	0	5	0	0	9
2035 No Project Conditions	0	581	0	0	0	0	0	919	0	551	0	273	2324
2035 Project Background	0	579	0	0	0	0	0	911	0	537	0	270	2297
2035 No Project Drive Access	0	-1	0	0	0	0	0	-3	0	-5	0	0	-9
2035 Project Drive Access	0	16	0	0	0	0	0	15	0	5	0	2	38
Change in Bkgrd (car-->BART)	0	-1	0	0	0	0	0	-5	0	-9	0	-3	-18
2035 Net Project Trips	0	14	0	0	0	0	0	7	0	-9	0	-1	11
2035 Project Conditions	0	595	0	0	0	0	0	926	0	542	0	272	2335

Intersection Number: 15
 Traffic Node #: 3683
 Model Node #: 7968
 Intersection Name: McLaughlin Ave and Story Rd
 Peak Hour: PM

Date of Analysis: 06/15/15
 Count Date: 10/09/14

Scenario:	Movements												Total:
	North Approach			East Approach			South Approach			West Approach			
	RT	TH	LT	RT	TH	LT	RT	TH	LT	RT	TH	LT	
Existing Conditions	224	669	249	214	970	494	201	284	122	101	1112	284	4924
Project Trips	1	0	1	0	1	1	-4	4	0	0	-1	2	5
Existing Plus Project Conditions	225	669	250	214	971	495	197	288	122	101	1111	286	4929
2025													
2025 No Project Background	290	681	249	221	1051	496	261	323	137	101	1432	294	5536
2025 No Project Drive Access	1	5	0	0	2	11	4	1	0	0	7	0	31
2025 No Project Conditions	291	686	249	221	1053	507	265	324	137	101	1439	294	5567
2025 Project Background	290	676	245	221	1050	490	258	320	137	101	1422	293	5503
2025 No Project Drive Access	-1	-5	0	0	-2	-11	-4	-1	0	0	-7	0	-31
2025 Project Drive Access	4	11	4	0	2	6	0	7	0	0	0	7	41
Change in Bkgrd (car-->BART)	0	-5	-4	0	-1	-6	-3	-3	0	0	-10	-1	-33
2025 Net Project Trips	3	1	0	0	-1	-11	-7	3	0	0	-17	6	-23
2025 Project Conditions	294	687	249	221	1052	496	258	327	137	101	1422	300	5544
2035													
2035 No Project Background	272	669	249	222	1114	494	286	359	149	129	1561	333	5837
2035 No Project Drive Access	0	5	1	0	4	13	5	2	0	1	10	1	42
2035 No Project Conditions	272	674	250	222	1118	507	291	361	149	130	1571	334	5879
2035 Project Background	272	664	245	222	1112	488	283	356	149	128	1553	331	5803
2035 No Project Drive Access	0	-5	-1	0	-4	-13	-5	-2	0	-1	-10	-1	-42
2035 Project Drive Access	5	12	3	0	3	11	0	9	0	1	1	6	51
Change in Bkgrd (car-->BART)	0	-5	-4	0	-2	-6	-3	-3	0	-1	-8	-2	-34
2035 Net Project Trips	5	2	-2	0	-3	-8	-8	4	0	-1	-17	3	-25
2035 Project Conditions	277	676	248	222	1115	499	283	365	149	129	1554	337	5854

Intersection Number: 16
 Traffic Node #: 3058
 Model Node #: 4148
 Intersection Name: The Alameda and Taylor St *
 Peak Hour: PM

Date of Analysis: 06/15/15
 Count Date: 09/30/14

Scenario:	Movements												Total:
	North Approach			East Approach			South Approach			West Approach			
	RT	TH	LT	RT	TH	LT	RT	TH	LT	RT	TH	LT	
Existing Conditions	70	1124	297	166	413	114	35	540	150	79	432	88	3508
Project Trips	0	-7	-8	-1	1	0	0	-6	0	3	0	0	-18
Existing Plus Project Conditions	70	1117	289	165	414	114	35	534	150	82	432	88	3490
2025													
2025 No Project Background	95	1124	348	199	590	126	35	640	211	193	638	97	4296
2025 No Project Drive Access	0	1	0	0	0	0	0	1	1	0	0	0	3
2025 No Project Conditions	95	1125	348	199	590	126	35	641	212	193	638	97	4299
2025 Project Background	95	1110	335	196	588	126	35	624	210	192	634	97	4242
2025 No Project Drive Access	0	-1	0	0	0	0	0	-1	-1	0	0	0	-3
2025 Project Drive Access	0	1	0	1	6	0	0	2	6	7	1	0	24
Change in Bkgrd (car-->BART)	0	-14	-13	-3	-2	0	0	-16	-1	-1	-4	0	-54
2025 Net Project Trips	0	-14	-13	-2	4	0	0	-15	4	6	-3	0	-33
2025 Project Conditions	95	1111	335	197	594	126	35	626	216	199	635	97	4266
2035													
2035 No Project Background	94	1152	354	304	666	149	43	784	250	229	809	96	4930
2035 No Project Drive Access	0	1	0	0	0	0	0	1	2	0	1	0	5
2035 No Project Conditions	94	1153	354	304	666	149	43	785	252	229	810	96	4935
2035 Project Background	94	1136	345	298	663	148	43	763	249	228	805	96	4868
2035 No Project Drive Access	0	-1	0	0	0	0	0	-1	-2	0	-1	0	-5
2035 Project Drive Access	0	2	0	1	7	0	0	3	10	9	1	0	33
Change in Bkgrd (car-->BART)	0	-16	-9	-6	-3	-1	0	-21	-1	-1	-4	0	-62
2035 Net Project Trips	0	-15	-9	-5	4	-1	0	-19	7	8	-4	0	-34
2035 Project Conditions	94	1138	345	299	670	148	43	766	259	237	806	96	4901

Intersection Number: 17
 Traffix Node #: 3608
 Model Node #: 8592
 Intersection Name: Stockton Ave and Julian St
 Peak Hour: PM

Date of Analysis: 06/15/15
 Count Date: 10/07/14

Scenario:	Movements												Total:
	North Approach			East Approach			South Approach			West Approach			
	RT	TH	LT	RT	TH	LT	RT	TH	LT	RT	TH	LT	
Existing Conditions	68	312	235	147	158	68	88	161	16	30	248	25	1556
Project Trips	0	-2	-1	-1	-1	0	0	-1	-1	-1	-2	0	-10
Existing Plus Project Conditions	68	310	234	146	157	68	88	160	15	29	246	25	1546
2025													
2025 No Project Background	73	312	249	147	158	68	88	243	25	30	266	25	1684
2025 No Project Drive Access	0	0	0	0	0	0	0	1	0	0	0	0	1
2025 No Project Conditions	73	312	249	147	158	68	88	244	25	30	266	25	1685
2025 Project Background	73	306	246	147	157	68	88	236	25	30	265	25	1666
2025 No Project Drive Access	0	0	0	0	0	0	0	-1	0	0	0	0	-1
2025 Project Drive Access	0	0	0	0	1	1	0	2	0	0	0	0	4
Change in Bkgrd (car-->BART)	0	-6	-3	0	-1	0	0	-7	0	0	-1	0	-18
2025 Net Project Trips	0	-6	-3	0	0	1	0	-6	0	0	-1	0	-15
2025 Project Conditions	73	306	246	147	158	69	88	238	25	30	265	25	1670
2035													
2035 No Project Background	80	315	312	147	182	104	102	263	27	50	254	25	1861
2035 No Project Drive Access	0	1	0	0	1	0	0	4	1	0	0	0	7
2035 No Project Conditions	80	316	312	147	183	104	102	267	28	50	254	25	1868
2035 Project Background	80	307	308	146	181	103	102	250	26	50	253	25	1831
2035 No Project Drive Access	0	-1	0	0	-1	0	0	-4	-1	0	0	0	-7
2035 Project Drive Access	0	1	0	0	1	1	0	4	1	0	0	0	8
Change in Bkgrd (car-->BART)	0	-8	-4	-1	-1	-1	0	-13	-1	0	-1	0	-30
2035 Net Project Trips	0	-8	-4	-1	-1	0	0	-13	-1	0	-1	0	-29
2035 Project Conditions	80	308	308	146	182	104	102	254	27	50	253	25	1839

Intersection Number: 18
 Traffix Node #: 3606
 Model Node #: 4027
 Intersection Name: Montgomery St and Julian St
 Peak Hour: PM

Date of Analysis: 06/15/15
 Count Date: 10/07/14

Scenario:	Movements												Total:
	North Approach			East Approach			South Approach			West Approach			
	RT	TH	LT	RT	TH	LT	RT	TH	LT	RT	TH	LT	
Existing Conditions	36	3	59	27	316	18	25	5	15	24	543	16	1087
Project Trips	0	0	0	0	-1	0	0	0	0	0	-3	0	-4
Existing Plus Project Conditions	36	3	59	27	315	18	25	5	15	24	540	16	1083
2025													
2025 No Project Background	36	29	88	27	316	18	25	6	15	26	640	16	1242
2025 No Project Drive Access	0	0	0	0	0	0	0	0	0	0	0	0	0
2025 No Project Conditions	36	29	88	27	316	18	25	6	15	26	640	16	1242
2025 Project Background	36	29	88	27	314	18	25	6	15	26	634	16	1234
2025 No Project Drive Access	0	0	0	0	0	0	0	0	0	0	0	0	0
2025 Project Drive Access	0	0	0	0	1	0	0	0	0	0	0	0	1
Change in Bkgrd (car-->BART)	0	0	0	0	-2	0	0	0	0	0	-6	0	-8
2025 Net Project Trips	0	0	0	0	-1	0	0	0	0	0	-6	0	-7
2025 Project Conditions	36	29	88	27	315	18	25	6	15	26	634	16	1235
2035													
2035 No Project Background	36	28	96	27	371	20	42	8	50	33	687	16	1414
2035 No Project Drive Access	0	0	0	0	1	0	0	0	0	0	0	0	1
2035 No Project Conditions	36	28	96	27	372	20	42	8	50	33	687	16	1415
2035 Project Background	36	28	96	27	368	20	42	8	49	33	682	16	1405
2035 No Project Drive Access	0	0	0	0	-1	0	0	0	0	0	0	0	-1
2035 Project Drive Access	0	0	0	0	1	0	0	0	0	0	0	0	1
Change in Bkgrd (car-->BART)	0	0	0	0	-3	0	0	0	-1	0	-5	0	-9
2035 Net Project Trips	0	0	0	0	-3	0	0	0	-1	0	-5	0	-9
2035 Project Conditions	36	28	96	27	369	20	42	8	49	33	682	16	1406

Intersection Number: 19
 Traffic Node #: 3263
 Model Node #: 7570
 Intersection Name: Autumn St and Julian St
 Peak Hour: PM

Date of Analysis: 06/15/15
 Count Date: 10/07/14

Scenario:	Movements												Total:
	North Approach			East Approach			South Approach			West Approach			
	RT	TH	LT	RT	TH	LT	RT	TH	LT	RT	TH	LT	
Existing Conditions	26	20	69	30	317	74	63	9	25	15	574	11	1233
Project Trips	0	0	-1	0	-1	-1	-4	0	0	0	-3	0	-10
Existing Plus Project Conditions	26	20	68	30	316	73	59	9	25	15	571	11	1223
2025													
2025 No Project Background	27	154	433	377	317	249	173	207	25	15	692	20	2689
2025 No Project Drive Access	0	0	0	0	0	4	11	1	0	0	0	0	16
2025 No Project Conditions	27	154	433	377	317	253	184	208	25	15	692	20	2705
2025 Project Background	27	152	425	367	315	244	165	204	25	15	686	20	2645
2025 No Project Drive Access	0	0	0	0	0	-4	-11	-1	0	0	0	0	-16
2025 Project Drive Access	0	0	0	0	1	2	11	1	0	0	0	0	15
Change in Bkgrd (car->BART)	0	-2	-8	-10	-2	-5	-8	-3	0	0	-6	0	-44
2025 Net Project Trips	0	-2	-8	-10	-1	-7	-8	-3	0	0	-6	0	-45
2025 Project Conditions	27	152	425	367	316	246	176	205	25	15	686	20	2660
2035													
2035 No Project Background	28	134	448	282	373	308	257	280	25	15	759	25	2934
2035 No Project Drive Access	0	0	0	0	1	4	15	1	0	0	0	0	21
2035 No Project Conditions	28	134	448	282	374	312	272	281	25	15	759	25	2955
2035 Project Background	28	132	440	270	370	300	242	273	25	15	753	25	2873
2035 No Project Drive Access	0	0	0	0	-1	-4	-15	-1	0	0	0	0	-21
2035 Project Drive Access	0	0	0	0	1	2	14	1	0	0	0	0	18
Change in Bkgrd (car->BART)	0	-2	-8	-12	-3	-8	-15	-7	0	0	-6	0	-61
2035 Net Project Trips	0	-2	-8	-12	-3	-10	-16	-7	0	0	-6	0	-64
2035 Project Conditions	28	132	440	270	371	302	256	274	25	15	753	25	2891

Intersection Number: 20
 Traffic Node #: 3014
 Model Node #: 8697
 Intersection Name: SR-87 [W] and Julian St *
 Peak Hour: PM

Date of Analysis: 06/15/15
 Count Date: 09/23/14

Scenario:	Movements												Total:
	North Approach			East Approach			South Approach			West Approach			
	RT	TH	LT	RT	TH	LT	RT	TH	LT	RT	TH	LT	
Existing Conditions	88	88	127	0	418	210	0	0	0	40	970	0	1941
Project Trips	-1	-4	-5	0	-1	0	0	0	0	-1	-9	0	-21
Existing Plus Project Conditions	87	84	122	0	417	210	0	0	0	39	961	0	1920
2025													
2025 No Project Background	155	88	127	0	758	212	0	0	0	332	1178	0	2850
2025 No Project Drive Access	2	0	1	0	2	0	0	0	0	0	11	0	16
2025 No Project Conditions	157	88	128	0	760	212	0	0	0	332	1189	0	2866
2025 Project Background	150	82	121	0	747	212	0	0	0	328	1161	0	2801
2025 No Project Drive Access	-2	0	-1	0	-2	0	0	0	0	0	-11	0	-16
2025 Project Drive Access	1	0	0	0	3	0	0	0	0	0	11	0	15
Change in Bkgrd (car->BART)	-5	-6	-6	0	-11	0	0	0	0	-4	-17	0	-49
2025 Net Project Trips	-6	-6	-7	0	-10	0	0	0	0	-4	-17	0	-50
2025 Project Conditions	151	82	121	0	750	212	0	0	0	328	1172	0	2816
2035													
2035 No Project Background	220	228	127	0	725	220	0	0	0	319	1331	0	3170
2035 No Project Drive Access	3	0	0	0	2	0	0	0	0	0	15	0	20
2035 No Project Conditions	223	228	127	0	727	220	0	0	0	319	1346	0	3190
2035 Project Background	213	222	125	0	711	220	0	0	0	313	1308	0	3112
2035 No Project Drive Access	-3	0	0	0	-2	0	0	0	0	0	-15	0	-20
2035 Project Drive Access	1	0	0	0	3	0	0	0	0	0	14	0	18
Change in Bkgrd (car->BART)	-7	-6	-2	0	-14	0	0	0	0	-6	-23	0	-58
2035 Net Project Trips	-9	-6	-2	0	-13	0	0	0	0	-6	-24	0	-60
2035 Project Conditions	214	222	125	0	714	220	0	0	0	313	1322	0	3130

Intersection Number: 21
 Traffix Node #: 3013
 Model Node #: 8683
 Intersection Name: SR-87 [E] and Julian St *
 Peak Hour: PM

Date of Analysis: 06/15/15
 Count Date: 09/23/14

Scenario:	Movements												Total:
	North Approach			East Approach			South Approach			West Approach			
	RT	TH	LT	RT	TH	LT	RT	TH	LT	RT	TH	LT	
Existing Conditions	324	0	205	141	1048	0	51	330	444	0	383	103	3029
Project Trips	-2	0	0	-4	-2	0	0	-33	0	0	-6	-2	-49
Existing Plus Project Conditions	322	0	205	137	1046	0	51	297	444	0	377	101	2980
2025													
2025 No Project Background	480	0	334	207	1048	0	63	330	592	0	409	103	3566
2025 No Project Drive Access	0	0	0	0	2	0	1	0	0	0	6	3	12
2025 No Project Conditions	480	0	334	207	1050	0	64	330	592	0	415	106	3578
2025 Project Background	473	0	332	203	1045	0	62	312	585	0	400	101	3513
2025 No Project Drive Access	0	0	0	0	-2	0	-1	0	0	0	-6	-3	-12
2025 Project Drive Access	3	0	0	1	3	0	0	0	0	0	6	3	16
Change in Bkgrd (car-->BART)	-7	0	-2	-4	-3	0	-1	-18	-7	0	-9	-2	-53
2025 Net Project Trips	-4	0	-2	-3	-2	0	-2	-18	-7	0	-9	-2	-49
2025 Project Conditions	476	0	332	204	1048	0	62	312	585	0	406	104	3529
2035													
2035 No Project Background	610	0	258	211	1089	0	109	330	620	0	401	103	3731
2035 No Project Drive Access	0	0	0	0	3	0	2	1	0	0	6	3	15
2035 No Project Conditions	610	0	258	211	1092	0	111	331	620	0	407	106	3746
2035 Project Background	599	0	256	209	1083	0	105	314	612	0	391	97	3666
2035 No Project Drive Access	0	0	0	0	-3	0	-2	-1	0	0	-6	-3	-15
2035 Project Drive Access	3	0	0	1	5	0	2	0	0	0	6	2	19
Change in Bkgrd (car-->BART)	-11	0	-2	-2	-6	0	-4	-16	-8	0	-10	-6	-65
2035 Net Project Trips	-8	0	-2	-1	-4	0	-4	-17	-8	0	-10	-7	-61
2035 Project Conditions	602	0	256	210	1088	0	107	314	612	0	397	99	3685

Intersection Number: 22
 Traffix Node #: 3227
 Model Node #: 8612
 Intersection Name: The Alameda and Julian St
 Peak Hour: PM

Date of Analysis: 06/15/15
 Count Date: 10/07/14

Scenario:	Movements												Total:
	North Approach			East Approach			South Approach			West Approach			
	RT	TH	LT	RT	TH	LT	RT	TH	LT	RT	TH	LT	
Existing Conditions	0	1042	185	139	0	92	75	595	0	0	0	0	2128
Project Trips	0	-2	-1	-2	0	0	0	-3	0	0	0	0	-8
Existing Plus Project Conditions	0	1040	184	137	0	92	75	592	0	0	0	0	2120
2025													
2025 No Project Background	0	1151	189	139	0	98	99	796	0	0	0	0	2472
2025 No Project Drive Access	0	1	1	0	0	0	0	2	0	0	0	0	4
2025 No Project Conditions	0	1152	190	139	0	98	99	798	0	0	0	0	2476
2025 Project Background	0	1138	186	137	0	98	99	782	0	0	0	0	2440
2025 No Project Drive Access	0	-1	-1	0	0	0	0	-2	0	0	0	0	-4
2025 Project Drive Access	0	9	0	0	0	0	0	9	0	0	0	0	18
Change in Bkgrd (car-->BART)	0	-13	-3	-2	0	0	0	-14	0	0	0	0	-32
2025 Net Project Trips	0	-5	-4	-2	0	0	0	-7	0	0	0	0	-18
2025 Project Conditions	0	1147	186	137	0	98	99	791	0	0	0	0	2458
2035													
2035 No Project Background	0	1296	185	139	0	110	114	999	0	0	0	0	2843
2035 No Project Drive Access	0	1	0	0	0	0	0	3	0	0	0	0	4
2035 No Project Conditions	0	1297	185	139	0	110	114	1002	0	0	0	0	2847
2035 Project Background	0	1279	184	137	0	110	114	979	0	0	0	0	2803
2035 No Project Drive Access	0	-1	0	0	0	0	0	-3	0	0	0	0	-4
2035 Project Drive Access	0	11	0	0	0	0	0	14	0	0	0	0	25
Change in Bkgrd (car-->BART)	0	-17	-1	-2	0	0	0	-20	0	0	0	0	-40
2035 Net Project Trips	0	-7	-1	-2	0	0	0	-9	0	0	0	0	-19
2035 Project Conditions	0	1290	184	137	0	110	114	993	0	0	0	0	2828

Intersection Number: 23
 Traffix Node #: 3059
 Model Node #: 8613
 Intersection Name: Race St and The Alameda *
 Peak Hour: PM

Date of Analysis: 06/15/15
 Count Date: 09/30/14

Scenario:	Movements												Total:
	North Approach			East Approach			South Approach			West Approach			
	RT	TH	LT	RT	TH	LT	RT	TH	LT	RT	TH	LT	
Existing Conditions	2	20	16	0	329	207	108	298	8	455	637	0	2080
Project Trips	0	0	0	0	-3	0	0	-1	0	-1	-1	0	-6
Existing Plus Project Conditions	2	20	16	0	326	207	108	297	8	454	636	0	2074
2025													
2025 No Project Background	2	24	18	0	512	208	108	338	8	491	714	0	2423
2025 No Project Drive Access	0	0	0	0	2	0	0	0	0	0	0	0	2
2025 No Project Conditions	2	24	18	0	514	208	108	338	8	491	714	0	2425
2025 Project Background	2	24	18	0	500	208	108	336	8	490	703	0	2397
2025 No Project Drive Access	0	0	0	0	-2	0	0	0	0	0	0	0	-2
2025 Project Drive Access	0	0	0	0	9	1	0	0	0	0	9	0	19
Change in Bkgrd (car-->BART)	0	0	0	0	-12	0	0	-2	0	-1	-11	0	-26
2025 Net Project Trips	0	0	0	0	-5	1	0	-2	0	-1	-2	0	-9
2025 Project Conditions	2	24	18	0	509	209	108	336	8	490	712	0	2416
2035													
2035 No Project Background	2	51	28	0	689	216	110	368	8	503	863	0	2838
2035 No Project Drive Access	0	0	0	0	3	0	0	0	0	0	1	0	4
2035 No Project Conditions	2	51	28	0	692	216	110	368	8	503	864	0	2842
2035 Project Background	2	51	28	0	671	215	109	367	8	502	847	0	2800
2035 No Project Drive Access	0	0	0	0	-3	0	0	0	0	0	-1	0	-4
2035 Project Drive Access	0	2	0	0	14	2	0	0	0	0	11	0	29
Change in Bkgrd (car-->BART)	0	0	0	0	-18	-1	-1	-1	0	-1	-16	0	-38
2035 Net Project Trips	0	2	0	0	-7	1	-1	-1	0	-1	-6	0	-13
2035 Project Conditions	2	53	28	0	685	217	109	367	8	502	858	0	2829

Intersection Number: 24
 Traffix Node #: 3230
 Model Node #: 6629
 Intersection Name: Stockton Ave and The Alameda
 Peak Hour: PM

Date of Analysis: 06/15/15
 Count Date: 10/07/14

Scenario:	Movements												Total:
	North Approach			East Approach			South Approach			West Approach			
	RT	TH	LT	RT	TH	LT	RT	TH	LT	RT	TH	LT	
Existing Conditions	213	0	168	122	447	0	3	0	2	1	473	134	1563
Project Trips	-2	0	-1	-2	-3	0	0	0	0	0	-1	-1	-10
Existing Plus Project Conditions	211	0	167	120	444	0	3	0	2	1	472	133	1553
2025													
2025 No Project Background	257	0	168	134	569	0	3	0	2	1	510	213	1857
2025 No Project Drive Access	0	0	0	3	3	0	0	0	0	0	1	0	7
2025 No Project Conditions	257	0	168	137	572	0	3	0	2	1	511	213	1864
2025 Project Background	253	0	166	133	558	0	3	0	2	1	500	207	1823
2025 No Project Drive Access	0	0	0	-3	-3	0	0	0	0	0	-1	0	-7
2025 Project Drive Access	1	0	1	3	9	0	0	0	0	0	10	0	24
Change in Bkgrd (car-->BART)	-4	0	-2	-1	-11	0	0	0	0	0	-10	-6	-34
2025 Net Project Trips	-3	0	-1	-1	-5	0	0	0	0	0	-1	-6	-17
2025 Project Conditions	254	0	167	136	567	0	3	0	2	1	510	207	1847
2035													
2035 No Project Background	319	0	168	122	677	0	3	0	2	1	593	261	2146
2035 No Project Drive Access	0	0	1	5	5	0	0	0	0	0	1	0	12
2035 No Project Conditions	319	0	169	127	682	0	3	0	2	1	594	261	2158
2035 Project Background	312	0	165	121	663	0	3	0	2	1	580	249	2096
2035 No Project Drive Access	0	0	-1	-5	-5	0	0	0	0	0	-1	0	-12
2035 Project Drive Access	1	0	2	5	16	0	0	0	0	0	14	0	38
Change in Bkgrd (car-->BART)	-7	0	-3	-1	-14	0	0	0	0	0	-13	-12	-50
2035 Net Project Trips	-6	0	-2	-1	-3	0	0	0	0	0	0	-12	-24
2035 Project Conditions	313	0	167	126	679	0	3	0	2	1	594	249	2134

Intersection Number: 25
 Traffic Node #: 3363
 Model Node #: 6632
 Intersection Name: Cahill St and Santa Clara St
 Peak Hour: PM

Date of Analysis: 06/15/15
 Count Date: 10/07/14

Scenario:	Movements												Total:
	North Approach			East Approach			South Approach			West Approach			
	RT	TH	LT	RT	TH	LT	RT	TH	LT	RT	TH	LT	
Existing Conditions	11	5	5	1	488	104	51	0	74	79	635	0	1453
Project Trips	0	0	0	0	-7	9	-2	0	2	6	-9	0	-1
Existing Plus Project Conditions	11	5	5	1	481	113	49	0	76	85	626	0	1452
2025													
2025 No Project Background	11	5	5	1	625	104	51	0	74	79	635	0	1590
2025 No Project Drive Access	0	0	0	0	2	4	2	0	4	1	0	0	13
2025 No Project Conditions	11	5	5	1	627	108	53	0	78	80	635	0	1603
2025 Project Background	11	5	5	1	614	104	51	0	74	79	622	0	1566
2025 No Project Drive Access	0	0	0	0	-2	-4	-2	0	-4	-1	0	0	-13
2025 Project Drive Access	0	0	0	0	2	13	2	0	10	10	0	0	37
Change in Bkgrd (car-->BART)	0	0	0	0	-11	0	0	0	0	0	-13	0	-24
2025 Net Project Trips	0	0	0	0	-11	9	0	0	6	9	-13	0	0
2025 Project Conditions	11	5	5	1	616	117	53	0	84	89	622	0	1603
2035													
2035 No Project Background	11	5	5	1	722	104	51	0	74	79	710	0	1762
2035 No Project Drive Access	0	0	0	0	3	5	4	0	6	2	1	0	21
2035 No Project Conditions	11	5	5	1	725	109	55	0	80	81	711	0	1783
2035 Project Background	11	5	5	1	706	104	51	0	74	79	694	0	1730
2035 No Project Drive Access	0	0	0	0	-3	-5	-4	0	-6	-2	-1	0	-21
2035 Project Drive Access	0	0	0	0	4	16	4	0	16	15	1	0	56
Change in Bkgrd (car-->BART)	0	0	0	0	-16	0	0	0	0	0	-16	0	-32
2035 Net Project Trips	0	0	0	0	-15	11	0	0	10	13	-16	0	3
2035 Project Conditions	11	5	5	1	710	120	55	0	90	94	695	0	1786

Intersection Number: 26
 Traffic Node #: 3112
 Model Node #: 8588
 Intersection Name: Montgomery St and Santa Clara St *
 Peak Hour: PM

Date of Analysis: 06/15/15
 Count Date: 09/17/14

Scenario:	Movements												Total:
	North Approach			East Approach			South Approach			West Approach			
	RT	TH	LT	RT	TH	LT	RT	TH	LT	RT	TH	LT	
Existing Conditions	0	0	0	0	681	243	0	0	0	242	532	0	1698
Project Trips	0	0	0	0	1	-2	0	0	0	-3	-8	0	-12
Existing Plus Project Conditions	0	0	0	0	682	241	0	0	0	239	524	0	1686
2025													
2025 No Project Background	0	0	0	0	808	48	74	0	7	42	817	0	1796
2025 No Project Drive Access	0	0	0	0	4	2	10	0	2	0	2	0	20
2025 No Project Conditions	0	0	0	0	812	50	84	0	9	42	819	0	1816
2025 Project Background	0	0	0	0	797	44	69	0	7	41	806	0	1764
2025 No Project Drive Access	0	0	0	0	-4	-2	-10	0	-2	0	-2	0	-20
2025 Project Drive Access	0	0	0	0	13	1	9	0	2	0	3	0	28
Change in Bkgrd (car-->BART)	0	0	0	0	-11	-4	-5	0	0	-1	-11	0	-32
2025 Net Project Trips	0	0	0	0	-2	-5	-6	0	0	-1	-10	0	-24
2025 Project Conditions	0	0	0	0	810	45	78	0	9	41	809	0	1792
2035													
2035 No Project Background	0	0	0	0	889	61	46	0	24	41	944	0	2005
2035 No Project Drive Access	0	0	0	0	5	2	15	0	3	0	4	0	29
2035 No Project Conditions	0	0	0	0	894	63	61	0	27	41	948	0	2034
2035 Project Background	0	0	0	0	873	53	41	0	24	40	929	0	1960
2035 No Project Drive Access	0	0	0	0	-5	-2	-15	0	-3	0	-4	0	-29
2035 Project Drive Access	0	0	0	0	17	2	13	0	3	0	4	0	39
Change in Bkgrd (car-->BART)	0	0	0	0	-16	-8	-5	0	0	-1	-15	0	-45
2035 Net Project Trips	0	0	0	0	-4	-8	-7	0	0	-1	-15	0	-35
2035 Project Conditions	0	0	0	0	890	55	54	0	27	40	933	0	1999

Intersection Number: 27
 Traffic Node #: 3066
 Model Node #: 7571
 Intersection Name: Autumn St and Santa Clara St *
 Peak Hour: PM

Date of Analysis: 06/15/15
 Count Date: 09/16/14

Scenario:	Movements												Total:
	North Approach			East Approach			South Approach			West Approach			
	RT	TH	LT	RT	TH	LT	RT	TH	LT	RT	TH	LT	
Existing Conditions	89	0	31	36	678	0	82	43	84	0	516	18	1577
Project Trips	-2	0	0	0	3	0	-2	-1	1	0	-5	-1	-7
Existing Plus Project Conditions	87	0	31	36	681	0	80	42	85	0	511	17	1570
2025													
2025 No Project Background	89	530	66	111	678	243	82	125	116	242	516	93	2891
2025 No Project Drive Access	2	1	0	0	3	1	5	6	0	0	6	6	30
2025 No Project Conditions	91	531	66	111	681	244	87	131	116	242	522	99	2921
2025 Project Background	86	527	65	110	666	241	81	124	116	239	507	89	2851
2025 No Project Drive Access	-2	-1	0	0	-3	-1	-5	-6	0	0	-6	-6	-30
2025 Project Drive Access	1	1	0	0	13	1	4	5	0	0	6	6	37
Change in Bkgrd (car->BART)	-3	-3	-1	-1	-12	-2	-1	-1	0	-3	-9	-4	-40
2025 Net Project Trips	-4	-3	-1	-1	-2	-2	-2	-2	0	-3	-9	-4	-33
2025 Project Conditions	87	528	65	110	679	242	85	129	116	239	513	95	2888
2035													
2035 No Project Background	89	560	103	133	678	243	82	221	163	242	546	92	3152
2035 No Project Drive Access	2	1	0	0	5	1	6	7	0	0	10	9	41
2035 No Project Conditions	91	561	103	133	683	244	88	228	163	242	556	101	3193
2035 Project Background	83	557	102	131	662	241	79	214	162	237	533	88	3089
2035 No Project Drive Access	-2	-1	0	0	-5	-1	-6	-7	0	0	-10	-9	-41
2035 Project Drive Access	1	1	0	0	18	2	6	7	0	0	9	8	52
Change in Bkgrd (car->BART)	-6	-3	-1	-2	-16	-2	-3	-7	-1	-5	-13	-4	-63
2035 Net Project Trips	-7	-3	-1	-2	-3	-1	-3	-7	-1	-5	-14	-5	-52
2035 Project Conditions	84	558	102	131	680	243	85	221	162	237	542	96	3141

Intersection Number: 28
 Traffic Node #: 3015
 Model Node #: 8668
 Intersection Name: SR-87 NB and Santa Clara St *
 Peak Hour: PM

Date of Analysis: 06/15/15
 Count Date: 09/23/14

Scenario:	Movements												Total:
	North Approach			East Approach			South Approach			West Approach			
	RT	TH	LT	RT	TH	LT	RT	TH	LT	RT	TH	LT	
Existing Conditions	0	0	0	0	626	0	570	0	529	0	710	0	2435
Project Trips	0	0	0	0	-5	0	-6	0	8	0	-4	0	-7
Existing Plus Project Conditions	0	0	0	0	621	0	564	0	537	0	706	0	2428
2025													
2025 No Project Background	0	0	0	0	760	0	570	0	596	0	712	0	2638
2025 No Project Drive Access	0	0	0	0	2	0	0	0	2	0	10	0	14
2025 No Project Conditions	0	0	0	0	762	0	570	0	598	0	722	0	2652
2025 Project Background	0	0	0	0	751	0	561	0	590	0	706	0	2608
2025 No Project Drive Access	0	0	0	0	-2	0	0	0	-2	0	-10	0	-14
2025 Project Drive Access	0	0	0	0	2	0	0	0	12	0	9	0	23
Change in Bkgrd (car->BART)	0	0	0	0	-9	0	-9	0	-6	0	-6	0	-30
2025 Net Project Trips	0	0	0	0	-9	0	-9	0	4	0	-7	0	-21
2025 Project Conditions	0	0	0	0	753	0	561	0	602	0	715	0	2631
2035													
2035 No Project Background	0	0	0	0	724	0	570	0	641	0	785	0	2720
2035 No Project Drive Access	0	0	0	0	3	0	0	0	3	0	15	0	21
2035 No Project Conditions	0	0	0	0	727	0	570	0	644	0	800	0	2741
2035 Project Background	0	0	0	0	712	0	562	0	635	0	774	0	2683
2035 No Project Drive Access	0	0	0	0	-3	0	0	0	-3	0	-15	0	-21
2035 Project Drive Access	0	0	0	0	4	0	0	0	16	0	14	0	34
Change in Bkgrd (car->BART)	0	0	0	0	-12	0	-8	0	-6	0	-11	0	-37
2035 Net Project Trips	0	0	0	0	-11	0	-8	0	7	0	-12	0	-24
2035 Project Conditions	0	0	0	0	716	0	562	0	651	0	788	0	2717

Intersection Number: 29
 Traffix Node #: 3710
 Model Node #: 6634
 Intersection Name: Montgomery St and San Fernando St
 Peak Hour: PM

Date of Analysis: 06/15/15
 Count Date: 10/07/14

Scenario:	Movements												Total:
	North Approach			East Approach			South Approach			West Approach			
	RT	TH	LT	RT	TH	LT	RT	TH	LT	RT	TH	LT	
Existing Conditions	4	617	37	0	111	107	0	0	0	136	74	0	1086
Project Trips	-1	-2	-1	0	10	0	0	0	0	14	10	0	30
Existing Plus Project Conditions	3	615	36	0	121	107	0	0	0	150	84	0	1116
2025													
2025 No Project Background	59	10	104	7	111	10	10	10	10	10	74	74	489
2025 No Project Drive Access	0	0	21	2	10	0	0	0	0	0	11	0	44
2025 No Project Conditions	59	10	125	9	121	10	10	10	10	10	85	74	533
2025 Project Background	55	10	103	7	111	10	10	10	10	10	74	69	479
2025 No Project Drive Access	0	0	-21	-2	-10	0	0	0	0	0	-11	0	-44
2025 Project Drive Access	0	0	21	2	29	0	0	0	0	0	40	0	92
Change in Bkgrd (car->BART)	-4	0	-1	0	0	0	0	0	0	0	0	-5	-10
2025 Net Project Trips	-4	0	-1	0	19	0	0	0	0	0	29	-5	38
2025 Project Conditions	55	10	124	9	140	10	10	10	10	10	114	69	571
2035													
2035 No Project Background	85	10	103	24	111	10	10	10	10	10	74	46	503
2035 No Project Drive Access	1	0	30	3	18	0	0	0	0	0	19	0	71
2035 No Project Conditions	86	10	133	27	129	10	10	10	10	10	93	46	574
2035 Project Background	77	10	102	24	111	10	10	10	10	10	74	41	489
2035 No Project Drive Access	-1	0	-30	-3	-18	0	0	0	0	0	-19	0	-71
2035 Project Drive Access	0	0	29	3	42	0	0	0	0	0	57	0	131
Change in Bkgrd (car->BART)	-8	0	-1	0	0	0	0	0	0	0	0	-5	-14
2035 Net Project Trips	-9	0	-2	0	24	0	0	0	0	0	38	-5	46
2035 Project Conditions	77	10	131	27	153	10	10	10	10	10	131	41	620

Intersection Number: 30
 Traffix Node #: 3264
 Model Node #: 6635
 Intersection Name: Autumn St and San Fernando St
 Peak Hour: PM

Date of Analysis: 06/15/15
 Count Date: 10/07/14

Scenario:	Movements												Total:
	North Approach			East Approach			South Approach			West Approach			
	RT	TH	LT	RT	TH	LT	RT	TH	LT	RT	TH	LT	
Existing Conditions	0	0	0	17	115	0	43	170	98	0	98	17	558
Project Trips	0	0	0	0	0	0	0	-3	10	0	10	0	17
Existing Plus Project Conditions	0	0	0	17	115	0	43	167	108	0	108	17	575
2025													
2025 No Project Background	10	1122	51	18	115	50	96	267	98	126	101	43	2097
2025 No Project Drive Access	0	18	5	0	0	0	0	2	12	26	6	0	69
2025 No Project Conditions	10	1140	56	18	115	50	96	269	110	152	107	43	2166
2025 Project Background	10	1113	50	18	115	49	93	265	98	126	101	43	2081
2025 No Project Drive Access	0	-18	-5	0	0	0	0	-2	-12	-26	-6	0	-69
2025 Project Drive Access	0	19	4	0	0	0	0	2	29	49	13	0	116
Change in Bkgrd (car->BART)	0	-9	-1	0	0	-1	-3	-2	0	0	0	0	-16
2025 Net Project Trips	0	-8	-2	0	0	-1	-3	-2	17	23	7	0	31
2025 Project Conditions	10	1132	54	18	115	49	93	267	127	175	114	43	2197
2035													
2035 No Project Background	10	1119	90	35	115	67	145	411	108	126	134	21	2381
2035 No Project Drive Access	0	25	8	0	1	0	0	3	19	37	12	0	105
2035 No Project Conditions	10	1144	98	35	116	67	145	414	127	163	146	21	2486
2035 Project Background	10	1111	89	34	115	66	138	399	108	126	133	21	2350
2035 No Project Drive Access	0	-25	-8	0	-1	0	0	-3	-19	-37	-12	0	-105
2035 Project Drive Access	0	24	8	0	1	0	0	3	44	64	22	0	166
Change in Bkgrd (car->BART)	0	-8	-1	-1	0	-1	-7	-12	0	0	-1	0	-31
2035 Net Project Trips	0	-9	-1	-1	0	-1	-7	-12	25	27	9	0	30
2035 Project Conditions	10	1135	97	34	116	66	138	402	152	190	155	21	2516

Intersection Number: 31
 Traffic Node #: 3985
 Model Node #: 8726
 Intersection Name: Delmas Ave and San Fernando St
 Peak Hour: PM

Date of Analysis: 06/15/15
 Count Date: 10/07/14

Scenario:	Movements												Total:
	North Approach			East Approach			South Approach			West Approach			
	RT	TH	LT	RT	TH	LT	RT	TH	LT	RT	TH	LT	
Existing Conditions	17	130	22	11	143	96	0	0	0	39	108	0	566
Project Trips	0	-3	0	0	0	0	0	0	0	11	0	0	8
Existing Plus Project Conditions	17	127	22	11	143	96	0	0	0	50	108	0	574
2025													
2025 No Project Background	22	130	45	31	154	98	0	0	0	73	158	22	733
2025 No Project Drive Access	0	1	0	0	0	0	0	0	0	6	5	0	12
2025 No Project Conditions	22	131	45	31	154	98	0	0	0	79	163	22	745
2025 Project Background	22	126	44	31	153	98	0	0	0	73	155	22	724
2025 No Project Drive Access	0	-1	0	0	0	0	0	0	0	-6	-5	0	-12
2025 Project Drive Access	0	1	0	0	0	0	0	0	0	13	4	0	18
Change in Bkgrd (car-->BART)	0	-4	-1	0	-1	0	0	0	0	0	-3	0	-9
2025 Net Project Trips	0	-4	-1	0	-1	0	0	0	0	7	-4	0	-3
2025 Project Conditions	22	127	44	31	153	98	0	0	0	86	159	22	742
2035													
2035 No Project Background	27	130	78	28	186	108	0	0	0	99	244	32	932
2035 No Project Drive Access	0	1	0	0	1	0	0	0	0	11	8	0	21
2035 No Project Conditions	27	131	78	28	187	108	0	0	0	110	252	32	953
2035 Project Background	27	127	76	28	184	107	0	0	0	98	236	32	915
2035 No Project Drive Access	0	-1	0	0	-1	0	0	0	0	-11	-8	0	-21
2035 Project Drive Access	0	0	0	0	1	0	0	0	0	22	9	0	32
Change in Bkgrd (car-->BART)	0	-3	-2	0	-2	-1	0	0	0	-1	-8	0	-17
2035 Net Project Trips	0	-4	-2	0	-2	-1	0	0	0	10	-7	0	-6
2035 Project Conditions	27	127	76	28	185	107	0	0	0	120	245	32	947

Intersection Number: 32
 Traffic Node #: 3709
 Model Node #: 8675
 Intersection Name: Montgomery St and Park Ave
 Peak Hour: PM

Date of Analysis: 06/15/15
 Count Date: 10/07/14

Scenario:	Movements												Total:
	North Approach			East Approach			South Approach			West Approach			
	RT	TH	LT	RT	TH	LT	RT	TH	LT	RT	TH	LT	
Existing Conditions	84	894	32	26	149	194	53	236	150	287	201	36	2342
Project Trips	0	8	0	0	0	0	-1	8	0	-1	0	0	14
Existing Plus Project Conditions	84	902	32	26	149	194	52	244	150	286	201	36	2356
2025													
2025 No Project Background	94	1234	51	26	149	227	120	451	152	304	209	46	3063
2025 No Project Drive Access	0	43	0	0	0	0	0	14	0	0	0	0	57
2025 No Project Conditions	94	1277	51	26	149	227	120	465	152	304	209	46	3120
2025 Project Background	94	1216	49	26	149	227	117	445	151	302	209	46	3031
2025 No Project Drive Access	0	-43	0	0	0	0	0	-14	0	0	0	0	-57
2025 Project Drive Access	0	65	0	0	0	0	0	31	0	0	0	0	96
Change in Bkgrd (car-->BART)	0	-18	-2	0	0	0	-3	-6	-1	-2	0	0	-32
2025 Net Project Trips	0	4	-2	0	0	0	-3	11	-1	-2	0	0	7
2025 Project Conditions	94	1281	49	26	149	227	117	476	151	302	209	46	3127
2035													
2035 No Project Background	90	1322	87	29	151	268	151	682	162	377	234	47	3600
2035 No Project Drive Access	0	60	0	0	0	0	0	22	0	0	0	0	82
2035 No Project Conditions	90	1382	87	29	151	268	151	704	162	377	234	47	3682
2035 Project Background	90	1282	80	29	151	267	147	670	161	376	234	47	3534
2035 No Project Drive Access	0	-60	0	0	0	0	0	-22	0	0	0	0	-82
2035 Project Drive Access	0	86	0	0	0	0	0	46	0	0	0	0	132
Change in Bkgrd (car-->BART)	0	-40	-7	0	0	-1	-4	-12	-1	-1	0	0	-66
2035 Net Project Trips	0	-14	-7	0	0	-1	-4	12	-1	-1	0	0	-16
2035 Project Conditions	90	1368	80	29	151	267	147	716	161	376	234	47	3666

Intersection Number: 33
 Trafix Node #: 3445
 Model Node #: 8719
 Intersection Name: Delmas Ave and Park Ave
 Peak Hour: PM

Date of Analysis: 06/15/15
 Count Date: 10/07/14

Scenario:	Movements												Total:
	North Approach			East Approach			South Approach			West Approach			
	RT	TH	LT	RT	TH	LT	RT	TH	LT	RT	TH	LT	
Existing Conditions	23	192	46	0	317	103	77	126	116	60	201	0	1261
Project Trips	0	7	0	0	0	0	0	-2	0	0	-1	0	4
Existing Plus Project Conditions	23	199	46	0	317	103	77	124	116	60	200	0	1265
2025													
2025 No Project Background	23	205	46	0	345	103	77	137	116	118	260	0	1430
2025 No Project Drive Access	0	7	0	0	0	0	0	0	0	0	0	0	7
2025 No Project Conditions	23	212	46	0	345	103	77	137	116	118	260	0	1437
2025 Project Background	23	200	46	0	345	103	76	132	115	118	256	0	1414
2025 No Project Drive Access	0	-7	0	0	0	0	0	0	0	0	0	0	-7
2025 Project Drive Access	0	14	0	0	0	0	0	0	0	0	0	0	14
Change in Bkgrd (car-->BART)	0	-5	0	0	0	0	-1	-5	-1	0	-4	0	-16
2025 Net Project Trips	0	2	0	0	0	0	-1	-5	-1	0	-4	0	-9
2025 Project Conditions	23	214	46	0	345	103	76	132	115	118	256	0	1428
2035													
2035 No Project Background	23	192	47	0	383	103	77	126	116	182	293	0	1542
2035 No Project Drive Access	0	11	0	0	0	0	0	0	0	0	0	0	11
2035 No Project Conditions	23	203	47	0	383	103	77	126	116	182	293	0	1553
2035 Project Background	23	187	46	0	383	103	77	125	116	181	284	0	1525
2035 No Project Drive Access	0	-11	0	0	0	0	0	0	0	0	0	0	-11
2035 Project Drive Access	0	22	0	0	0	0	0	0	0	0	0	0	22
Change in Bkgrd (car-->BART)	0	-5	-1	0	0	0	0	-1	0	-1	-9	0	-17
2035 Net Project Trips	0	6	-1	0	0	0	0	-1	0	-1	-9	0	-6
2035 Project Conditions	23	209	46	0	383	103	77	125	116	181	284	0	1547

Intersection Number: 34
 Trafix Node #: 3693
 Model Node #: 8652
 Intersection Name: Meridian Ave and San Carlos St
 Peak Hour: PM

Date of Analysis: 06/15/15
 Count Date: 10/07/14

Scenario:	Movements												Total:
	North Approach			East Approach			South Approach			West Approach			
	RT	TH	LT	RT	TH	LT	RT	TH	LT	RT	TH	LT	
Existing Conditions	47	468	143	34	497	309	197	264	173	169	894	104	3299
Project Trips	0	0	0	0	0	0	0	0	0	0	0	0	0
Existing Plus Project Conditions	47	468	143	34	497	309	197	264	173	169	894	104	3299
2025													
2025 No Project Background	57	527	143	34	834	387	231	322	188	308	1129	123	4283
2025 No Project Drive Access	0	0	0	0	2	1	0	0	0	0	1	0	4
2025 No Project Conditions	57	527	143	34	836	388	231	322	188	308	1130	123	4287
2025 Project Background	57	526	143	34	829	387	231	321	188	307	1122	122	4267
2025 No Project Drive Access	0	0	0	0	-2	-1	0	0	0	0	-1	0	-4
2025 Project Drive Access	0	0	0	0	5	2	0	0	0	0	1	0	8
Change in Bkgrd (car-->BART)	0	-1	0	0	-5	0	0	-1	0	-1	-7	-1	-16
2025 Net Project Trips	0	-1	0	0	-2	1	0	-1	0	-1	-7	-1	-12
2025 Project Conditions	57	526	143	34	834	389	231	321	188	307	1123	122	4275
2035													
2035 No Project Background	101	630	143	39	990	427	252	335	213	401	1180	141	4852
2035 No Project Drive Access	0	0	0	0	5	4	0	0	0	0	1	0	10
2035 No Project Conditions	101	630	143	39	995	431	252	335	213	401	1181	141	4862
2035 Project Background	100	629	143	39	985	426	252	335	213	401	1176	140	4839
2035 No Project Drive Access	0	0	0	0	-5	-4	0	0	0	0	-1	0	-10
2035 Project Drive Access	0	0	0	0	6	5	0	0	0	0	2	0	13
Change in Bkgrd (car-->BART)	-1	-1	0	0	-5	-1	0	0	0	0	-4	-1	-13
2035 Net Project Trips	-1	-1	0	0	-4	0	0	0	0	0	-3	-1	-10
2035 Project Conditions	100	629	143	39	991	431	252	335	213	401	1178	140	4852

Intersection Number: 35
 Traffic Node #: 3748
 Model Node #: 8399
 Intersection Name: Race St and San Carlos St
 Peak Hour: PM

Date of Analysis: 06/15/15
 Count Date: 10/07/14

Scenario:	Movements												Total:
	North Approach			East Approach			South Approach			West Approach			
	RT	TH	LT	RT	TH	LT	RT	TH	LT	RT	TH	LT	
Existing Conditions	181	266	117	63	456	73	55	148	77	119	991	162	2708
Project Trips	0	0	0	0	0	0	5	0	0	0	0	0	5
Existing Plus Project Conditions	181	266	117	63	456	73	60	148	77	119	991	162	2713
2025													
2025 No Project Background	181	283	117	63	871	99	97	176	77	121	1256	164	3505
2025 No Project Drive Access	0	0	0	0	4	1	2	0	0	0	1	0	8
2025 No Project Conditions	181	283	117	63	875	100	99	176	77	121	1257	164	3513
2025 Project Background	181	283	117	63	866	99	96	175	77	121	1249	164	3491
2025 No Project Drive Access	0	0	0	0	-4	-1	-2	0	0	0	-1	0	-8
2025 Project Drive Access	0	0	0	0	7	1	7	0	0	0	2	0	17
Change in Bkgrd (car->BART)	0	0	0	0	-5	0	-1	-1	0	0	-7	0	-14
2025 Net Project Trips	0	0	0	0	-2	0	4	-1	0	0	-6	0	-5
2025 Project Conditions	181	283	117	63	873	100	103	175	77	121	1251	164	3508
2035													
2035 No Project Background	181	266	117	66	1070	132	160	186	78	182	1258	169	3865
2035 No Project Drive Access	0	0	0	0	7	1	4	0	0	0	1	0	13
2035 No Project Conditions	181	266	117	66	1077	133	164	186	78	182	1259	169	3878
2035 Project Background	181	266	117	66	1065	132	159	186	78	182	1253	169	3854
2035 No Project Drive Access	0	0	0	0	-7	-1	-4	0	0	0	-1	0	-13
2035 Project Drive Access	0	0	0	0	12	2	11	0	0	0	2	0	27
Change in Bkgrd (car->BART)	0	0	0	0	-5	0	-1	0	0	0	-5	0	-11
2035 Net Project Trips	0	0	0	0	0	1	6	0	0	0	-4	0	3
2035 Project Conditions	181	266	117	66	1077	134	170	186	78	182	1255	169	3881

Intersection Number: 36
 Traffic Node #: 3653
 Model Node #: 8400
 Intersection Name: Lincoln Ave and San Carlos St
 Peak Hour: PM

Date of Analysis: 06/15/15
 Count Date: 11/06/13

Scenario:	Movements												Total:
	North Approach			East Approach			South Approach			West Approach			
	RT	TH	LT	RT	TH	LT	RT	TH	LT	RT	TH	LT	
Existing Conditions	23	264	12	18	510	110	100	66	137	291	873	32	2436
Project Trips	0	-1	0	0	0	0	0	0	0	0	3	0	2
Existing Plus Project Conditions	23	263	12	18	510	110	100	66	137	291	876	32	2438
2025													
2025 No Project Background	23	286	19	24	903	216	144	94	186	291	1198	32	3416
2025 No Project Drive Access	0	0	0	0	5	1	0	0	0	0	3	0	9
2025 No Project Conditions	23	286	19	24	908	217	144	94	186	291	1201	32	3425
2025 Project Background	23	285	19	24	898	216	144	93	186	290	1191	32	3401
2025 No Project Drive Access	0	0	0	0	-5	-1	0	0	0	0	-3	0	-9
2025 Project Drive Access	0	0	0	0	8	2	1	0	0	0	10	0	21
Change in Bkgrd (car->BART)	0	-1	0	0	-5	0	0	-1	0	-1	-7	0	-15
2025 Net Project Trips	0	-1	0	0	-2	1	1	-1	0	-1	0	0	-3
2025 Project Conditions	23	285	19	24	906	218	145	93	186	290	1201	32	3422
2035													
2035 No Project Background	23	284	24	31	1085	261	263	120	238	291	1255	32	3907
2035 No Project Drive Access	0	0	0	0	10	4	1	0	0	0	5	0	20
2035 No Project Conditions	23	284	24	31	1095	265	264	120	238	291	1260	32	3927
2035 Project Background	23	283	24	31	1080	260	263	120	238	290	1250	32	3894
2035 No Project Drive Access	0	0	0	0	-10	-4	-1	0	0	0	-5	0	-20
2035 Project Drive Access	0	0	0	0	14	6	4	0	0	0	13	0	37
Change in Bkgrd (car->BART)	0	-1	0	0	-5	-1	0	0	0	-1	-5	0	-13
2035 Net Project Trips	0	-1	0	0	-1	1	3	0	0	-1	3	0	4
2035 Project Conditions	23	283	24	31	1094	266	267	120	238	290	1263	32	3931

Intersection Number: 37
 Traffic Node #: 3077
 Model Node #: 8674
 Intersection Name: Bird Ave and San Carlos St *
 Peak Hour: PM

Date of Analysis: 06/15/15
 Count Date: 09/18/14

Scenario:	Movements												Total:
	North Approach			East Approach			South Approach			West Approach			
	RT	TH	LT	RT	TH	LT	RT	TH	LT	RT	TH	LT	
Existing Conditions	100	1092	84	22	306	205	114	333	176	308	572	91	3403
Project Trips	2	8	-1	0	0	-1	0	3	0	0	-1	4	14
Existing Plus Project Conditions	102	1100	83	22	306	204	114	336	176	308	571	95	3417
2025													
2025 No Project Background	200	1235	233	51	480	205	373	589	274	417	799	91	4947
2025 No Project Drive Access	6	36	1	0	0	0	0	10	1	0	0	3	57
2025 No Project Conditions	206	1271	234	51	480	205	373	599	275	417	799	94	5004
2025 Project Background	200	1219	229	50	478	202	371	581	273	415	794	91	4903
2025 No Project Drive Access	-6	-36	-1	0	0	0	0	-10	-1	0	0	-3	-57
2025 Project Drive Access	10	53	2	0	0	0	0	20	1	0	0	11	97
Change in Bkgrd (car-->BART)	0	-16	-4	-1	-2	-3	-2	-8	-1	-2	-5	0	-44
2025 Net Project Trips	4	1	-3	-1	-2	-3	-2	2	-1	-2	-5	8	-4
2025 Project Conditions	210	1272	231	50	478	202	371	601	274	415	794	102	5000
2035													
2035 No Project Background	262	1269	337	105	630	205	340	719	265	379	915	178	5604
2035 No Project Drive Access	14	43	3	1	0	0	0	15	1	0	0	7	84
2035 No Project Conditions	276	1312	340	106	630	205	340	734	266	379	915	185	5688
2035 Project Background	262	1240	325	104	628	202	338	705	264	378	911	177	5534
2035 No Project Drive Access	-14	-43	-3	-1	0	0	0	-15	-1	0	0	-7	-84
2035 Project Drive Access	21	61	4	1	1	0	0	29	1	0	0	17	135
Change in Bkgrd (car-->BART)	0	-29	-12	-1	-2	-3	-2	-14	-1	-1	-4	-1	-70
2035 Net Project Trips	7	-11	-11	-1	-1	-3	-2	0	-1	-1	-4	9	-19
2035 Project Conditions	283	1301	329	105	629	202	338	734	265	378	911	194	5669

Intersection Number: 38
 Traffic Node #: 3266
 Model Node #: 8677
 Intersection Name: Bird Ave and Auzeais Ave
 Peak Hour: PM

Date of Analysis: 06/15/15
 Count Date: 10/07/14

Scenario:	Movements												Total:
	North Approach			East Approach			South Approach			West Approach			
	RT	TH	LT	RT	TH	LT	RT	TH	LT	RT	TH	LT	
Existing Conditions	51	1585	75	24	61	118	93	474	160	271	115	23	3050
Project Trips	0	5	0	0	0	0	0	2	0	0	0	0	7
Existing Plus Project Conditions	51	1590	75	24	61	118	93	476	160	271	115	23	3057
2025													
2025 No Project Background	53	1726	75	25	65	143	146	1081	183	289	144	27	3957
2025 No Project Drive Access	0	36	0	0	0	0	0	12	0	0	0	0	48
2025 No Project Conditions	53	1762	75	25	65	143	146	1093	183	289	144	27	4005
2025 Project Background	53	1705	75	25	65	143	144	1069	182	288	143	27	3919
2025 No Project Drive Access	0	-36	0	0	0	0	0	-12	0	0	0	0	-48
2025 Project Drive Access	0	53	0	0	0	0	0	21	0	0	0	0	74
Change in Bkgrd (car-->BART)	0	-21	0	0	0	0	-2	-12	-1	-1	-1	0	-38
2025 Net Project Trips	0	-4	0	0	0	0	-2	-3	-1	-1	-1	0	-12
2025 Project Conditions	53	1758	75	25	65	143	144	1090	182	288	143	27	3993
2035													
2035 No Project Background	52	1620	119	35	78	194	194	1164	191	328	152	23	4150
2035 No Project Drive Access	0	43	0	0	0	0	0	17	0	0	0	0	60
2035 No Project Conditions	52	1663	119	35	78	194	194	1181	191	328	152	23	4210
2035 Project Background	52	1587	119	35	78	193	193	1146	190	327	152	23	4095
2035 No Project Drive Access	0	-43	0	0	0	0	0	-17	0	0	0	0	-60
2035 Project Drive Access	0	61	0	0	0	0	0	29	0	0	0	0	90
Change in Bkgrd (car-->BART)	0	-33	0	0	0	-1	-1	-18	-1	-1	0	0	-55
2035 Net Project Trips	0	-15	0	0	0	-1	-1	-6	-1	-1	0	0	-25
2035 Project Conditions	52	1648	119	35	78	193	193	1175	190	327	152	23	4185

Intersection Number: 39
 Traffix Node #: 3690
 Model Node #: 8404
 Intersection Name: Meridian Ave and Parkmoor Ave
 Peak Hour: PM

Date of Analysis: 06/15/15
 Count Date: 10/07/14

Scenario:	Movements												Total:
	North Approach			East Approach			South Approach			West Approach			
	RT	TH	LT	RT	TH	LT	RT	TH	LT	RT	TH	LT	
Existing Conditions	318	864	59	100	423	151	209	627	197	86	27	20	3081
Project Trips	0	0	0	0	0	0	0	0	0	0	0	0	0
Existing Plus Project Conditions	318	864	59	100	423	151	209	627	197	86	27	20	3081
2025													
2025 No Project Background	388	919	191	103	533	155	268	749	202	86	27	20	3641
2025 No Project Drive Access	0	1	0	0	0	0	0	0	0	0	0	0	1
2025 No Project Conditions	388	920	191	103	533	155	268	749	202	86	27	20	3642
2025 Project Background	388	918	191	103	532	155	267	747	202	86	27	20	3636
2025 No Project Drive Access	0	-1	0	0	0	0	0	0	0	0	0	0	-1
2025 Project Drive Access	1	1	0	0	0	0	0	0	0	0	0	0	2
Change in Bkgrd (car-->BART)	0	-1	0	0	-1	0	-1	-2	0	0	0	0	-5
2025 Net Project Trips	1	-1	0	0	-1	0	-1	-2	0	0	0	0	-4
2025 Project Conditions	389	919	191	103	532	155	267	747	202	86	27	20	3638
2035													
2035 No Project Background	443	1032	299	126	550	151	227	841	202	86	27	20	4004
2035 No Project Drive Access	2	2	0	0	0	0	0	0	0	0	0	0	4
2035 No Project Conditions	445	1034	299	126	550	151	227	841	202	86	27	20	4008
2035 Project Background	443	1031	299	126	550	151	227	840	202	86	27	20	4002
2035 No Project Drive Access	-2	-2	0	0	0	0	0	0	0	0	0	0	-4
2035 Project Drive Access	4	3	0	0	0	0	0	1	0	0	0	0	8
Change in Bkgrd (car-->BART)	0	-1	0	0	0	0	0	-1	0	0	0	0	-2
2035 Net Project Trips	2	0	0	0	0	0	0	0	0	0	0	0	2
2035 Project Conditions	447	1034	299	126	550	151	227	841	202	86	27	20	4010

Intersection Number: 40
 Traffix Node #: 3651
 Model Node #: 8398
 Intersection Name: Lincoln Ave and Parkmoor Ave
 Peak Hour: PM

Date of Analysis: 06/15/15
 Count Date: 10/07/14

Scenario:	Movements												Total:
	North Approach			East Approach			South Approach			West Approach			
	RT	TH	LT	RT	TH	LT	RT	TH	LT	RT	TH	LT	
Existing Conditions	40	709	0	8	13	16	7	240	151	256	16	38	1494
Project Trips	0	-1	0	0	0	0	0	0	0	0	0	0	-1
Existing Plus Project Conditions	40	708	0	8	13	16	7	240	151	256	16	38	1493
2025													
2025 No Project Background	40	746	0	8	13	16	7	323	247	418	16	40	1874
2025 No Project Drive Access	0	1	0	0	0	0	0	0	0	0	0	0	1
2025 No Project Conditions	40	747	0	8	13	16	7	323	247	418	16	40	1875
2025 Project Background	40	744	0	8	13	16	7	322	246	415	16	40	1867
2025 No Project Drive Access	0	-1	0	0	0	0	0	0	0	0	0	0	-1
2025 Project Drive Access	0	2	0	0	0	0	0	0	0	0	0	0	2
Change in Bkgrd (car-->BART)	0	-2	0	0	0	0	0	-1	-1	-3	0	0	-7
2025 Net Project Trips	0	-1	0	0	0	0	0	-1	-1	-3	0	0	-6
2025 Project Conditions	40	746	0	8	13	16	7	322	246	415	16	40	1869
2035													
2035 No Project Background	40	787	0	8	13	16	7	402	288	438	16	64	2079
2035 No Project Drive Access	0	1	0	0	0	0	0	0	0	0	0	0	1
2035 No Project Conditions	40	788	0	8	13	16	7	402	288	438	16	64	2080
2035 Project Background	40	785	0	8	13	16	7	402	288	437	16	64	2076
2035 No Project Drive Access	0	-1	0	0	0	0	0	0	0	0	0	0	-1
2035 Project Drive Access	0	2	0	0	0	0	0	0	0	0	0	0	2
Change in Bkgrd (car-->BART)	0	-2	0	0	0	0	0	0	0	-1	0	0	-3
2035 Net Project Trips	0	-1	0	0	0	0	0	0	0	-1	0	0	-2
2035 Project Conditions	40	787	0	8	13	16	7	402	288	437	16	64	2078

Intersection Number: 41
 Traffix Node #: 3032
 Model Node #: 8682
 Intersection Name: Bird Ave and I-280 [N] *
 Peak Hour: PM

Date of Analysis: 06/15/15
 Count Date: 09/24/14

Scenario:	Movements												Total:
	North Approach			East Approach			South Approach			West Approach			
	RT	TH	LT	RT	TH	LT	RT	TH	LT	RT	TH	LT	
Existing Conditions	589	1261	0	235	22	416	0	395	155	0	0	0	3073
Project Trips	10	-5	0	-4	0	-2	0	6	0	0	0	0	5
Existing Plus Project Conditions	599	1256	0	231	22	414	0	401	155	0	0	0	3078
2025													
2025 No Project Background	654	1379	0	463	65	416	0	853	160	0	0	0	3990
2025 No Project Drive Access	13	23	0	8	0	6	0	3	0	0	0	0	53
2025 No Project Conditions	667	1402	0	471	65	422	0	856	160	0	0	0	4043
2025 Project Background	648	1363	0	452	65	412	0	849	159	0	0	0	3948
2025 No Project Drive Access	-13	-23	0	-8	0	-6	0	-3	0	0	0	0	-53
2025 Project Drive Access	25	29	0	8	0	2	0	13	0	0	0	0	77
Change in Bkgrd (car->BART)	-6	-16	0	-11	0	-4	0	-4	-1	0	0	0	-42
2025 Net Project Trips	6	-10	0	-11	0	-8	0	6	-1	0	0	0	-18
2025 Project Conditions	673	1392	0	460	65	414	0	862	159	0	0	0	4025
2035													
2035 No Project Background	589	1430	0	532	125	416	0	923	163	0	0	0	4178
2035 No Project Drive Access	16	27	0	12	0	6	0	6	0	0	0	0	67
2035 No Project Conditions	605	1457	0	544	125	422	0	929	163	0	0	0	4245
2035 Project Background	584	1400	0	515	125	414	0	919	163	0	0	0	4120
2035 No Project Drive Access	-16	-27	0	-12	0	-6	0	-6	0	0	0	0	-67
2035 Project Drive Access	26	35	0	11	0	2	0	18	0	0	0	0	92
Change in Bkgrd (car->BART)	-5	-30	0	-17	0	-2	0	-4	0	0	0	0	-58
2035 Net Project Trips	5	-22	0	-18	0	-6	0	8	0	0	0	0	-33
2035 Project Conditions	610	1435	0	526	125	416	0	937	163	0	0	0	4212

Intersection Number: 42
 Traffix Node #: 3033
 Model Node #: 8437
 Intersection Name: Bird Ave and I-280 [S] *
 Peak Hour: PM

Date of Analysis: 06/15/15
 Count Date: 09/24/14

Scenario:	Movements												Total:
	North Approach			East Approach			South Approach			West Approach			
	RT	TH	LT	RT	TH	LT	RT	TH	LT	RT	TH	LT	
Existing Conditions	0	1159	522	0	0	0	196	413	0	219	6	144	2659
Project Trips	0	0	-6	0	0	0	-2	2	0	0	0	3	-3
Existing Plus Project Conditions	0	1159	516	0	0	0	194	415	0	219	6	147	2656
2025													
2025 No Project Background	0	1159	672	0	0	0	315	515	0	346	6	505	3518
2025 No Project Drive Access	0	13	16	0	0	0	2	2	0	0	0	1	34
2025 No Project Conditions	0	1172	688	0	0	0	317	517	0	346	6	506	3552
2025 Project Background	0	1154	657	0	0	0	313	513	0	344	6	502	3489
2025 No Project Drive Access	0	-13	-16	0	0	0	-2	-2	0	0	0	-1	-34
2025 Project Drive Access	0	14	16	0	0	0	0	6	0	0	0	7	43
Change in Bkgrd (car->BART)	0	-5	-15	0	0	0	-2	-2	0	-2	0	-3	-29
2025 Net Project Trips	0	-4	-15	0	0	0	-4	2	0	-2	0	3	-20
2025 Project Conditions	0	1168	673	0	0	0	313	519	0	344	6	509	3532
2035													
2035 No Project Background	0	1159	700	0	0	0	311	594	0	436	6	499	3705
2035 No Project Drive Access	0	17	17	0	0	0	3	4	0	0	0	2	43
2035 No Project Conditions	0	1176	717	0	0	0	314	598	0	436	6	501	3748
2035 Project Background	0	1155	671	0	0	0	309	593	0	436	6	496	3666
2035 No Project Drive Access	0	-17	-17	0	0	0	-3	-4	0	0	0	-2	-43
2035 Project Drive Access	0	21	16	0	0	0	0	12	0	0	0	6	55
Change in Bkgrd (car->BART)	0	-4	-29	0	0	0	-2	-1	0	0	0	-3	-39
2035 Net Project Trips	0	0	-30	0	0	0	-5	7	0	0	0	1	-27
2035 Project Conditions	0	1176	687	0	0	0	309	605	0	436	6	502	3721

Intersection Number: 43
 Traffic Node #: 3553
 Model Node #: 8359
 Intersection Name: SW Expressway and Fruitdale Ave
 Peak Hour: PM

Date of Analysis: 06/15/15
 Count Date: 10/07/14

Scenario:	Movements												Total:
	North Approach			East Approach			South Approach			West Approach			
	RT	TH	LT	RT	TH	LT	RT	TH	LT	RT	TH	LT	
Existing Conditions	230	615	190	31	157	80	116	550	14	15	454	186	2638
Project Trips	1	7	0	0	0	0	0	1	0	0	0	-1	8
Existing Plus Project Conditions	231	622	190	31	157	80	116	551	14	15	454	185	2646
2025													
2025 No Project Background	230	639	193	31	207	119	187	575	14	15	541	253	3004
2025 No Project Drive Access	5	17	0	0	0	1	0	2	0	0	0	1	26
2025 No Project Conditions	235	656	193	31	207	120	187	577	14	15	541	254	3030
2025 Project Background	226	631	193	31	207	118	187	570	14	15	541	252	2985
2025 No Project Drive Access	-5	-17	0	0	0	-1	0	-2	0	0	0	-1	-26
2025 Project Drive Access	5	25	0	0	0	1	0	7	0	0	0	2	40
Change in Bkgrd (car-->BART)	-4	-8	0	0	0	-1	0	-5	0	0	0	-1	-19
2025 Net Project Trips	-4	0	0	0	0	-1	0	0	0	0	0	0	-5
2025 Project Conditions	231	656	193	31	207	119	187	577	14	15	541	254	3025
2035													
2035 No Project Background	230	627	193	45	258	201	312	625	15	16	609	186	3317
2035 No Project Drive Access	7	24	0	0	1	2	1	5	0	0	0	1	41
2035 No Project Conditions	237	651	193	45	259	203	313	630	15	16	609	187	3358
2035 Project Background	227	622	193	45	258	200	311	619	15	16	609	184	3299
2035 No Project Drive Access	-7	-24	0	0	-1	-2	-1	-5	0	0	0	-1	-41
2035 Project Drive Access	8	30	0	0	0	3	1	9	0	0	0	2	53
Change in Bkgrd (car-->BART)	-3	-5	0	0	0	-1	-1	-6	0	0	0	-2	-18
2035 Net Project Trips	-2	1	0	0	-1	0	-1	-2	0	0	0	-1	-6
2035 Project Conditions	235	652	193	45	258	203	312	628	15	16	609	186	3352

Intersection Number: 44
 Traffic Node #: 3552
 Model Node #: 8378
 Intersection Name: Meridian Ave and Fruitdale Ave
 Peak Hour: PM

Date of Analysis: 06/15/15
 Count Date: 10/07/14

Scenario:	Movements												Total:
	North Approach			East Approach			South Approach			West Approach			
	RT	TH	LT	RT	TH	LT	RT	TH	LT	RT	TH	LT	
Existing Conditions	156	1227	124	141	71	248	62	805	126	454	117	159	3690
Project Trips	0	-1	0	0	0	2	0	1	0	0	0	0	2
Existing Plus Project Conditions	156	1226	124	141	71	250	62	806	126	454	117	159	3692
2025													
2025 No Project Background	156	1354	128	141	131	248	62	922	161	519	117	255	4194
2025 No Project Drive Access	0	0	0	0	1	5	0	2	0	0	0	0	8
2025 No Project Conditions	156	1354	128	141	132	253	62	924	161	519	117	255	4202
2025 Project Background	156	1346	128	141	130	247	62	917	161	519	117	255	4179
2025 No Project Drive Access	0	0	0	0	-1	-5	0	-2	0	0	0	0	-8
2025 Project Drive Access	0	0	0	0	1	4	0	5	0	0	0	1	11
Change in Bkgrd (car-->BART)	0	-8	0	0	-1	-1	0	-5	0	0	0	0	-15
2025 Net Project Trips	0	-8	0	0	-1	-2	0	-2	0	0	0	1	-12
2025 Project Conditions	156	1346	128	141	131	251	62	922	161	519	117	256	4190
2035													
2035 No Project Background	262	1346	124	141	129	248	63	967	198	566	117	400	4561
2035 No Project Drive Access	1	1	0	0	1	5	0	2	0	0	0	1	11
2035 No Project Conditions	263	1347	124	141	130	253	63	969	198	566	117	401	4572
2035 Project Background	261	1344	124	141	129	248	63	966	198	566	117	399	4556
2035 No Project Drive Access	-1	-1	0	0	-1	-5	0	-2	0	0	0	-1	-11
2035 Project Drive Access	2	2	0	0	1	3	0	6	0	0	0	1	15
Change in Bkgrd (car-->BART)	-1	-2	0	0	0	0	0	-1	0	0	0	-1	-5
2035 Net Project Trips	0	-1	0	0	0	-2	0	3	0	0	0	-1	-1
2035 Project Conditions	263	1346	124	141	130	251	63	972	198	566	117	400	4571

Intersection Number: 45
 Traffix Node #: 7
 Model Node #: 6461
 Intersection Name: Lafayette St and Reed St
 Peak Hour: PM

Date of Analysis: 06/15/15
 Count Date: 2013

Scenario:	Movements												Total:
	North Approach			East Approach			South Approach			West Approach			
	RT	TH	LT	RT	TH	LT	RT	TH	LT	RT	TH	LT	
Existing Conditions	9	1631	53	22	3	53	50	443	0	6	4	6	2280
Project Trips	0	-1	-1	0	0	0	0	0	0	0	0	0	-2
Existing Plus Project Conditions	9	1630	52	22	3	53	50	443	0	6	4	6	2278
2025													
2025 No Project Background	9	1829	53	43	3	53	50	603	0	6	4	6	2659
2025 No Project Drive Access	0	1	0	0	0	0	0	0	0	0	0	0	1
2025 No Project Conditions	9	1830	53	43	3	53	50	603	0	6	4	6	2660
2025 Project Background	9	1819	51	43	3	53	50	602	0	6	4	6	2646
2025 No Project Drive Access	0	-1	0	0	0	0	0	0	0	0	0	0	-1
2025 Project Drive Access	0	1	0	0	0	1	0	0	0	0	0	0	2
Change in Bkgrd (car-->BART)	0	-10	-2	0	0	0	0	-1	0	0	0	0	-13
2025 Net Project Trips	0	-10	-2	0	0	1	0	-1	0	0	0	0	-12
2025 Project Conditions	9	1820	51	43	3	54	50	602	0	6	4	6	2648
2025 Santa Clara West Option													
2025 SC West No Project Background	9	1829	53	43	3	53	50	603	0	6	4	6	2659
2025 SC West No Project Drive Access	0	1	0	0	0	0	0	0	0	0	0	0	1
2025 SC West No Project Conditions	9	1830	53	43	3	53	50	603	0	6	4	6	2660
2025 SC West Project Background	9	1819	51	43	3	53	50	602	0	6	4	6	2646
2025 SC West No Project Drive Access	0	-1	0	0	0	0	0	0	0	0	0	0	-1
2025 SC West Project Drive Access	0	1	0	0	0	0	0	0	0	0	0	0	1
Change in Bkgrd (car-->BART)	0	-10	-2	0	0	0	0	-1	0	0	0	0	-13
2025 SC West Net Project Trips	0	-10	-2	0	0	0	0	-1	0	0	0	0	-13
2025 SC West Project Conditions	9	1820	51	43	3	53	50	602	0	6	4	6	2647
2035													
2035 No Project Background	9	1887	53	46	3	77	51	716	0	6	4	6	2858
2035 No Project Drive Access	0	2	0	0	0	1	0	1	0	0	0	0	4
2035 No Project Conditions	9	1889	53	46	3	78	51	717	0	6	4	6	2862
2035 Project Background	9	1882	52	45	3	76	51	715	0	6	4	6	2849
2035 No Project Drive Access	0	-2	0	0	0	-1	0	-1	0	0	0	0	-4
2035 Project Drive Access	0	2	0	1	0	4	0	1	0	0	0	0	8
Change in Bkgrd (car-->BART)	0	-5	-1	-1	0	-1	0	-1	0	0	0	0	-9
2035 Net Project Trips	0	-5	-1	0	0	2	0	-1	0	0	0	0	-5
2035 Project Conditions	9	1884	52	46	3	80	51	716	0	6	4	6	2857
2035 Santa Clara West Option													
2035 SC West No Project Background	9	1887	53	46	3	77	51	716	0	6	4	6	2858
2035 SC West No Project Drive Access	0	2	0	0	0	1	0	1	0	0	0	0	4
2035 SC West No Project Conditions	9	1889	53	46	3	78	51	717	0	6	4	6	2862
2035 SC West Project Background	9	1882	52	45	3	76	51	715	0	6	4	6	2849
2035 SC West No Project Drive Access	0	-2	0	0	0	-1	0	-1	0	0	0	0	-4
2035 SC West Project Drive Access	0	2	0	0	0	0	0	1	0	0	0	0	3
Change in Bkgrd (car-->BART)	0	-5	-1	-1	0	-1	0	-1	0	0	0	0	-9
2035 SC West Net Project Trips	0	-5	-1	-1	0	-2	0	-1	0	0	0	0	-10
2035 SC West Project Conditions	9	1884	52	45	3	76	51	716	0	6	4	6	2852

Intersection Number: 46
 Traffix Node #: 175
 Model Node #: 6460
 Intersection Name: De La Cruz Blvd and Reed St
 Peak Hour: PM

Date of Analysis: 06/15/15
 Count Date: 10/08/14

Scenario:	Movements												Total:
	North Approach			East Approach			South Approach			West Approach			
	RT	TH	LT	RT	TH	LT	RT	TH	LT	RT	TH	LT	
Existing Conditions	33	2440	26	17	5	78	10	398	54	231	10	15	3317
Project Trips	0	-11	0	-1	0	-2	-1	-7	0	-1	0	0	-23
Existing Plus Project Conditions	33	2429	26	16	5	76	9	391	54	230	10	15	3294
2025													
2025 No Project Background	33	2467	26	21	6	78	12	681	83	231	10	15	3663
2025 No Project Drive Access	0	8	0	0	0	0	0	13	0	0	0	0	21
2025 No Project Conditions	33	2475	26	21	6	78	12	694	83	231	10	15	3684
2025 Project Background	33	2448	26	20	6	73	11	668	82	229	10	15	3621
2025 No Project Drive Access	0	-8	0	0	0	0	0	-13	0	0	0	0	-21
2025 Project Drive Access	0	2	0	0	0	0	0	11	1	0	0	0	14
Change in Bkgrd (car-->BART)	0	-19	0	-1	0	-5	-1	-13	-1	-2	0	0	-42
2025 Net Project Trips	0	-25	0	-1	0	-5	-1	-15	0	-2	0	0	-49
2025 Project Conditions	33	2450	26	20	6	73	11	679	83	229	10	15	3635
2025 Santa Clara West Option													
2025 SC West No Project Background	33	2467	26	21	6	78	12	681	83	231	10	15	3663
2025 SC West No Project Drive Access	0	8	0	0	0	0	0	13	0	0	0	0	21
2025 SC West No Project Conditions	33	2475	26	21	6	78	12	694	83	231	10	15	3684
2025 SC West Project Background	33	2448	26	20	6	73	11	668	82	229	10	15	3621
2025 SC West No Project Drive Access	0	-8	0	0	0	0	0	-13	0	0	0	0	-21
2025 SC West Project Drive Access	0	2	0	0	0	0	0	10	0	0	0	0	12
Change in Bkgrd (car-->BART)	0	-19	0	-1	0	-5	-1	-13	-1	-2	0	0	-42
2025 SC West Net Project Trips	0	-25	0	-1	0	-5	-1	-16	-1	-2	0	0	-51
2025 SC West Project Conditions	33	2450	26	20	6	73	11	678	82	229	10	15	3633
2035													
2035 No Project Background	33	2574	26	29	9	78	14	942	110	231	10	15	4071
2035 No Project Drive Access	1	9	0	0	0	0	0	20	0	0	0	0	30
2035 No Project Conditions	34	2583	26	29	9	78	14	962	110	231	10	15	4101
2035 Project Background	33	2560	26	28	9	75	13	926	109	230	10	15	4034
2035 No Project Drive Access	-1	-9	0	0	0	0	0	-20	0	0	0	0	-30
2035 Project Drive Access	0	3	0	0	0	0	0	19	5	0	0	0	27
Change in Bkgrd (car-->BART)	0	-14	0	-1	0	-3	-1	-16	-1	-1	0	0	-37
2035 Net Project Trips	-1	-20	0	-1	0	-3	-1	-17	4	-1	0	0	-40
2035 Project Conditions	33	2563	26	28	9	75	13	945	114	230	10	15	4061
2035 Santa Clara West Option													
2035 SC West No Project Background	33	2574	26	29	9	78	14	942	110	231	10	15	4071
2035 SC West No Project Drive Access	1	9	0	0	0	0	0	20	0	0	0	0	30
2035 SC West No Project Conditions	34	2583	26	29	9	78	14	962	110	231	10	15	4101
2035 SC West Project Background	33	2560	26	28	9	75	13	926	109	230	10	15	4034
2035 SC West No Project Drive Access	-1	-9	0	0	0	0	0	-20	0	0	0	0	-30
2035 SC West Project Drive Access	0	3	0	0	0	0	0	19	0	0	0	0	22
Change in Bkgrd (car-->BART)	0	-14	0	-1	0	-3	-1	-16	-1	-1	0	0	-37
2035 SC West Net Project Trips	-1	-20	0	-1	0	-3	-1	-17	-1	-1	0	0	-45
2035 SC West Project Conditions	33	2563	26	28	9	75	13	945	109	230	10	15	4056

Intersection Number: 47
 Traffix Node #: 5416
 Model Node #: 8900
 Intersection Name: San Tomas Expwy and El Camino Real *
 Peak Hour: PM

Date of Analysis: 06/15/15
 Count Date: 09/23/14

Scenario:	Movements												Total:
	North Approach			East Approach			South Approach			West Approach			
	RT	TH	LT	RT	TH	LT	RT	TH	LT	RT	TH	LT	
Existing Conditions	491	2771	209	155	682	139	187	1054	171	312	1010	283	7464
Project Trips	2	-6	0	0	-2	0	0	0	0	0	-2	1	-7
Existing Plus Project Conditions	493	2765	209	155	680	139	187	1054	171	312	1008	284	7457
2025													
2025 No Project Background	578	2771	217	162	815	139	187	1171	171	312	1169	347	8039
2025 No Project Drive Access	7	32	0	0	0	0	0	7	0	0	0	2	48
2025 No Project Conditions	585	2803	217	162	815	139	187	1178	171	312	1169	349	8087
2025 Project Background	576	2753	217	162	811	139	187	1164	171	312	1163	346	8001
2025 No Project Drive Access	-7	-32	0	0	0	0	0	-7	0	0	0	-2	-48
2025 Project Drive Access	6	9	0	0	0	0	0	2	0	0	0	1	18
Change in Bkgrd (car-->BART)	-2	-18	0	0	-4	0	0	-7	0	0	-6	-1	-38
2025 Net Project Trips	-3	-41	0	0	-4	0	0	-12	0	0	-6	-2	-68
2025 Project Conditions	582	2762	217	162	811	139	187	1166	171	312	1163	347	8019
2025 Santa Clara West Option													
2025 SC West No Project Background	578	2771	217	162	815	139	187	1171	171	312	1169	347	8039
2025 SC West No Project Drive Access	7	32	0	0	0	0	0	7	0	0	0	2	48
2025 SC West No Project Conditions	585	2803	217	162	815	139	187	1178	171	312	1169	349	8087
2025 SC West Project Background	576	2753	217	162	811	139	187	1164	171	312	1163	346	8001
2025 SC West No Project Drive Access	-7	-32	0	0	0	0	0	-7	0	0	0	-2	-48
2025 SC West Project Drive Access	6	9	0	0	0	0	0	2	0	0	0	1	18
Change in Bkgrd (car-->BART)	-2	-18	0	0	-4	0	0	-7	0	0	-6	-1	-38
2025 SC West Net Project Trips	-3	-41	0	0	-4	0	0	-12	0	0	-6	-2	-68
2025 SC West Project Conditions	582	2762	217	162	811	139	187	1166	171	312	1163	347	8019
2035													
2035 No Project Background	568	2771	229	170	888	139	187	1407	171	312	1215	374	8431
2035 No Project Drive Access	8	38	0	0	0	0	0	7	0	0	0	2	55
2035 No Project Conditions	576	2809	229	170	888	139	187	1414	171	312	1215	376	8486
2035 Project Background	567	2767	229	170	883	139	187	1404	171	312	1210	373	8412
2035 No Project Drive Access	-8	-38	0	0	0	0	0	-7	0	0	0	-2	-55
2035 Project Drive Access	7	10	0	0	1	1	0	2	0	0	0	2	23
Change in Bkgrd (car-->BART)	-1	-4	0	0	-5	0	0	-3	0	0	-5	-1	-19
2035 Net Project Trips	-2	-32	0	0	-4	1	0	-8	0	0	-5	-1	-51
2035 Project Conditions	574	2777	229	170	884	140	187	1406	171	312	1210	375	8435
2035 Santa Clara West Option													
2035 SC West No Project Background	568	2771	229	170	888	139	187	1407	171	312	1215	374	8431
2035 SC West No Project Drive Access	8	38	0	0	0	0	0	7	0	0	0	2	55
2035 SC West No Project Conditions	576	2809	229	170	888	139	187	1414	171	312	1215	376	8486
2035 SC West Project Background	567	2767	229	170	883	139	187	1404	171	312	1210	373	8412
2035 SC West No Project Drive Access	-8	-38	0	0	0	0	0	-7	0	0	0	-2	-55
2035 SC West Project Drive Access	7	10	0	0	1	1	0	2	0	0	0	2	23
Change in Bkgrd (car-->BART)	-1	-4	0	0	-5	0	0	-3	0	0	-5	-1	-19
2035 SC West Net Project Trips	-2	-32	0	0	-4	1	0	-8	0	0	-5	-1	-51
2035 SC West Project Conditions	574	2777	229	170	884	140	187	1406	171	312	1210	375	8435

Intersection Number: 48
 Traffic Node #: 1205
 Model Node #: 8889
 Intersection Name: Scott Blvd and El Camino Real *
 Peak Hour: PM

Date of Analysis: 06/15/15
 Count Date: 09/17/14

Scenario:	Movements												Total:
	North Approach			East Approach			South Approach			West Approach			
	RT	TH	LT	RT	TH	LT	RT	TH	LT	RT	TH	LT	
Existing Conditions	193	789	212	85	779	243	65	220	136	82	804	147	3755
Project Trips	0	0	0	0	-2	2	1	0	0	0	-1	0	0
Existing Plus Project Conditions	193	789	212	85	777	245	66	220	136	82	803	147	3755
2025													
2025 No Project Background	197	1223	236	104	867	243	133	384	158	132	848	147	4672
2025 No Project Drive Access	0	1	0	0	1	1	0	0	0	0	0	0	3
2025 No Project Conditions	197	1224	236	104	868	244	133	384	158	132	848	147	4675
2025 Project Background	197	1219	236	104	862	242	132	383	158	132	842	147	4654
2025 No Project Drive Access	0	-1	0	0	-1	-1	0	0	0	0	0	0	-3
2025 Project Drive Access	0	0	0	0	2	4	1	0	0	0	1	0	8
Change in Bkgrd (car-->BART)	0	-4	0	0	-5	-1	-1	-1	0	0	-6	0	-18
2025 Net Project Trips	0	-5	0	0	-4	2	0	-1	0	0	-5	0	-13
2025 Project Conditions	197	1219	236	104	864	246	133	383	158	132	843	147	4662
2025 Santa Clara West Option													
2025 SC West No Project Background	197	1223	236	104	867	243	133	384	158	132	848	147	4672
2025 SC West No Project Drive Access	0	1	0	0	1	1	0	0	0	0	0	0	3
2025 SC West No Project Conditions	197	1224	236	104	868	244	133	384	158	132	848	147	4675
2025 SC West Project Background	197	1219	236	104	862	242	132	383	158	132	842	147	4654
2025 SC West No Project Drive Access	0	-1	0	0	-1	-1	0	0	0	0	0	0	-3
2025 SC West Project Drive Access	0	0	0	0	2	4	1	0	0	0	1	0	8
Change in Bkgrd (car-->BART)	0	-4	0	0	-5	-1	-1	-1	0	0	-6	0	-18
2025 SC West Net Project Trips	0	-5	0	0	-4	2	0	-1	0	0	-5	0	-13
2025 SC West Project Conditions	197	1219	236	104	864	246	133	383	158	132	843	147	4662
2035													
2035 No Project Background	204	1275	280	117	928	243	145	420	168	157	876	147	4960
2035 No Project Drive Access	0	0	0	1	2	1	0	0	0	0	1	0	5
2035 No Project Conditions	204	1275	280	118	930	244	145	420	168	157	877	147	4965
2035 Project Background	204	1274	279	117	922	242	144	420	168	157	871	147	4945
2035 No Project Drive Access	0	0	0	-1	-2	-1	0	0	0	0	-1	0	-5
2035 Project Drive Access	0	0	0	1	6	7	3	0	0	0	1	0	18
Change in Bkgrd (car-->BART)	0	-1	-1	0	-6	-1	-1	0	0	0	-5	0	-15
2035 Net Project Trips	0	-1	-1	0	-2	5	2	0	0	0	-5	0	-2
2035 Project Conditions	204	1274	279	118	928	249	147	420	168	157	872	147	4963
2035 Santa Clara West Option													
2035 SC West No Project Background	204	1275	280	117	928	243	145	420	168	157	876	147	4960
2035 SC West No Project Drive Access	0	0	0	1	2	1	0	0	0	0	1	0	5
2035 SC West No Project Conditions	204	1275	280	118	930	244	145	420	168	157	877	147	4965
2035 SC West Project Background	204	1274	279	117	922	242	144	420	168	157	871	147	4945
2035 SC West No Project Drive Access	0	0	0	-1	-2	-1	0	0	0	0	-1	0	-5
2035 SC West Project Drive Access	0	0	0	1	6	5	2	0	0	0	1	0	15
Change in Bkgrd (car-->BART)	0	-1	-1	0	-6	-1	-1	0	0	0	-5	0	-15
2035 SC West Net Project Trips	0	-1	-1	0	-2	3	1	0	0	0	-5	0	-5
2035 SC West Project Conditions	204	1274	279	118	928	247	146	420	168	157	872	147	4960

Intersection Number: 49
 Traffix Node #: 1204
 Model Node #: 8834
 Intersection Name: Monroe St and El Camino Real *
 Peak Hour: PM

Date of Analysis: 06/15/15
 Count Date: 09/17/14

Scenario:	Movements												Total:
	North Approach			East Approach			South Approach			West Approach			
	RT	TH	LT	RT	TH	LT	RT	TH	LT	RT	TH	LT	
Existing Conditions	238	421	48	57	907	87	64	153	26	85	766	125	2977
Project Trips	0	0	-3	2	1	0	0	0	0	0	-1	0	-1
Existing Plus Project Conditions	238	421	45	59	908	87	64	153	26	85	765	125	2976
2025													
2025 No Project Background	244	431	68	75	991	89	67	157	26	86	874	132	3240
2025 No Project Drive Access	0	0	0	1	3	0	0	0	0	0	1	0	5
2025 No Project Conditions	244	431	68	76	994	89	67	157	26	86	875	132	3245
2025 Project Background	244	431	61	73	984	89	67	157	26	86	867	132	3217
2025 No Project Drive Access	0	0	0	-1	-3	0	0	0	0	0	-1	0	-5
2025 Project Drive Access	0	0	2	6	9	0	0	0	0	0	3	0	20
Change in Bkgrd (car-->BART)	0	0	-7	-2	-7	0	0	0	0	0	-7	0	-23
2025 Net Project Trips	0	0	-5	3	-1	0	0	0	0	0	-5	0	-8
2025 Project Conditions	244	431	63	79	993	89	67	157	26	86	870	132	3237
2025 Santa Clara West Option													
2025 SC West No Project Background	244	431	68	75	991	89	67	157	26	86	874	132	3240
2025 SC West No Project Drive Access	0	0	0	1	3	0	0	0	0	0	1	0	5
2025 SC West No Project Conditions	244	431	68	76	994	89	67	157	26	86	875	132	3245
2025 SC West Project Background	244	431	61	73	984	89	67	157	26	86	867	132	3217
2025 SC West No Project Drive Access	0	0	0	-1	-3	0	0	0	0	0	-1	0	-5
2025 SC West Project Drive Access	0	0	2	6	9	0	0	0	0	0	3	0	20
Change in Bkgrd (car-->BART)	0	0	-7	-2	-7	0	0	0	0	0	-7	0	-23
2025 SC West Net Project Trips	0	0	-5	3	-1	0	0	0	0	0	-5	0	-8
2025 SC West Project Conditions	244	431	63	79	993	89	67	157	26	86	870	132	3237
2035													
2035 No Project Background	240	448	80	97	1073	90	71	157	26	85	907	137	3411
2035 No Project Drive Access	0	0	1	4	5	0	0	0	0	0	2	0	12
2035 No Project Conditions	240	448	81	101	1078	90	71	157	26	85	909	137	3423
2035 Project Background	240	448	73	93	1065	90	71	157	26	85	901	137	3386
2035 No Project Drive Access	0	0	-1	-4	-5	0	0	0	0	0	-2	0	-12
2035 Project Drive Access	0	0	3	10	17	0	1	0	0	0	7	0	38
Change in Bkgrd (car-->BART)	0	0	-7	-4	-8	0	0	0	0	0	-6	0	-25
2035 Net Project Trips	0	0	-5	2	4	0	1	0	0	0	-1	0	1
2035 Project Conditions	240	448	76	103	1082	90	72	157	26	85	908	137	3424
2035 Santa Clara West Option													
2035 SC West No Project Background	240	448	80	97	1073	90	71	157	26	85	907	137	3411
2035 SC West No Project Drive Access	0	0	1	4	5	0	0	0	0	0	2	0	12
2035 SC West No Project Conditions	240	448	81	101	1078	90	71	157	26	85	909	137	3423
2035 SC West Project Background	240	448	73	93	1065	90	71	157	26	85	901	137	3386
2035 SC West No Project Drive Access	0	0	-1	-4	-5	0	0	0	0	0	-2	0	-12
2035 SC West Project Drive Access	0	0	3	11	15	0	0	0	0	0	5	0	34
Change in Bkgrd (car-->BART)	0	0	-7	-4	-8	0	0	0	0	0	-6	0	-25
2035 SC West Net Project Trips	0	0	-5	3	2	0	0	0	0	0	-3	0	-3
2035 SC West Project Conditions	240	448	76	104	1080	90	71	157	26	85	906	137	3420

Intersection Number: 50
 Traffix Node #: 1202
 Model Node #: 8835
 Intersection Name: Lafayette St and El Camino Real *
 Peak Hour: PM

Date of Analysis: 06/15/15
 Count Date: 09/17/14

Scenario:	Movements												Total:
	North Approach			East Approach			South Approach			West Approach			
	RT	TH	LT	RT	TH	LT	RT	TH	LT	RT	TH	LT	
Existing Conditions	168	947	285	37	640	50	194	255	152	195	870	232	4025
Project Trips	0	-1	0	2	3	0	1	0	0	-1	-4	0	0
Existing Plus Project Conditions	168	946	285	39	643	50	195	255	152	194	866	232	4025
2025													
2025 No Project Background	186	993	435	50	716	50	219	416	161	210	986	235	4657
2025 No Project Drive Access	0	0	1	1	5	0	0	0	0	0	1	0	8
2025 No Project Conditions	186	993	436	51	721	50	219	416	161	210	987	235	4665
2025 Project Background	186	988	430	48	706	50	218	415	161	209	972	235	4618
2025 No Project Drive Access	0	0	-1	-1	-5	0	0	0	0	0	-1	0	-8
2025 Project Drive Access	0	0	2	6	16	0	1	0	0	0	6	0	31
Change in Bkgrd (car-->BART)	0	-5	-5	-2	-10	0	-1	-1	0	-1	-14	0	-39
2025 Net Project Trips	0	-5	-4	3	1	0	0	-1	0	-1	-9	0	-16
2025 Project Conditions	186	988	432	54	722	50	219	415	161	209	978	235	4649
2025 Santa Clara West Option													
2025 SC West No Project Background	186	993	435	50	716	50	219	416	161	210	986	235	4657
2025 SC West No Project Drive Access	0	0	1	1	5	0	0	0	0	0	1	0	8
2025 SC West No Project Conditions	186	993	436	51	721	50	219	416	161	210	987	235	4665
2025 SC West Project Background	186	988	430	48	706	50	218	415	161	209	972	235	4618
2025 SC West No Project Drive Access	0	0	-1	-1	-5	0	0	0	0	0	-1	0	-8
2025 SC West Project Drive Access	0	0	2	6	16	0	0	0	0	0	5	0	29
Change in Bkgrd (car-->BART)	0	-5	-5	-2	-10	0	-1	-1	0	-1	-14	0	-39
2025 SC West Net Project Trips	0	-5	-4	3	1	0	-1	-1	0	-1	-10	0	-18
2025 SC West Project Conditions	186	988	432	54	722	50	218	415	161	209	977	235	4647
2035													
2035 No Project Background	210	1034	460	83	788	50	243	498	171	235	1001	240	5013
2035 No Project Drive Access	0	0	2	4	8	0	0	0	0	0	3	0	17
2035 No Project Conditions	210	1034	462	87	796	50	243	498	171	235	1004	240	5030
2035 Project Background	210	1032	456	79	776	50	242	497	171	234	988	240	4975
2035 No Project Drive Access	0	0	-2	-4	-8	0	0	0	0	0	-3	0	-17
2035 Project Drive Access	1	1	6	9	26	0	2	0	0	0	10	0	55
Change in Bkgrd (car-->BART)	0	-2	-4	-4	-12	0	-1	-1	0	-1	-13	0	-38
2035 Net Project Trips	1	-1	0	1	6	0	1	-1	0	-1	-6	0	0
2035 Project Conditions	211	1033	462	88	802	50	244	497	171	234	998	240	5030
2035 Santa Clara West Option													
2035 SC West No Project Background	210	1034	460	83	788	50	243	498	171	235	1001	240	5013
2035 SC West No Project Drive Access	0	0	2	4	8	0	0	0	0	0	3	0	17
2035 SC West No Project Conditions	210	1034	462	87	796	50	243	498	171	235	1004	240	5030
2035 SC West Project Background	210	1032	456	79	776	50	242	497	171	234	988	240	4975
2035 SC West No Project Drive Access	0	0	-2	-4	-8	0	0	0	0	0	-3	0	-17
2035 SC West Project Drive Access	0	0	5	11	26	0	0	0	0	0	9	0	51
Change in Bkgrd (car-->BART)	0	-2	-4	-4	-12	0	-1	-1	0	-1	-13	0	-38
2035 SC West Net Project Trips	0	-2	-1	3	6	0	-1	-1	0	-1	-7	0	-4
2035 SC West Project Conditions	210	1032	461	90	802	50	242	497	171	234	997	240	5026

Intersection Number: 51
 Traffic Node #: 106
 Model Node #: 8796
 Intersection Name: El Camino Real and Benton St
 Peak Hour: PM

Date of Analysis: 06/15/15
 Count Date: 10/08/14

Scenario:	Movements												Total:
	North Approach			East Approach			South Approach			West Approach			
	RT	TH	LT	RT	TH	LT	RT	TH	LT	RT	TH	LT	
Existing Conditions	29	1231	76	48	33	19	6	542	145	190	26	40	2385
Project Trips	0	1	4	3	2	0	0	0	-1	-4	3	0	8
Existing Plus Project Conditions	29	1232	80	51	35	19	6	542	144	186	29	40	2393
2025													
2025 No Project Background	29	1476	76	48	33	19	6	615	190	194	26	40	2752
2025 No Project Drive Access	0	0	5	17	13	0	0	0	0	0	5	0	40
2025 No Project Conditions	29	1476	81	65	46	19	6	615	190	194	31	40	2792
2025 Project Background	29	1464	76	48	33	19	6	612	187	189	26	40	2729
2025 No Project Drive Access	0	0	-5	-17	-13	0	0	0	0	0	-5	0	-40
2025 Project Drive Access	0	9	8	20	16	0	0	1	0	0	7	0	61
Change in Bkgrd (car-->BART)	0	-12	0	0	0	0	0	-3	-3	-5	0	0	-23
2025 Net Project Trips	0	-3	3	3	3	0	0	-2	-3	-5	2	0	-2
2025 Project Conditions	29	1473	84	68	49	19	6	613	187	189	33	40	2790
2025 Santa Clara West Option													
2025 SC West No Project Background	29	1476	76	48	33	19	6	615	190	194	26	40	2752
2025 SC West No Project Drive Access	0	0	5	17	13	0	0	0	0	0	5	0	40
2025 SC West No Project Conditions	29	1476	81	65	46	19	6	615	190	194	31	40	2792
2025 SC West Project Background	29	1464	76	48	33	19	6	612	187	189	26	40	2729
2025 SC West No Project Drive Access	0	0	-5	-17	-13	0	0	0	0	0	-5	0	-40
2025 SC West Project Drive Access	0	0	10	40	28	0	0	0	0	0	9	0	87
Change in Bkgrd (car-->BART)	0	-12	0	0	0	0	0	-3	-3	-5	0	0	-23
2025 SC West Net Project Trips	0	-12	5	23	15	0	0	-3	-3	-5	4	0	24
2025 SC West Project Conditions	29	1464	86	88	61	19	6	612	187	189	35	40	2816
2035													
2035 No Project Background	29	1595	76	48	33	19	6	882	218	199	26	40	3171
2035 No Project Drive Access	0	1	9	32	22	0	0	0	0	0	7	0	71
2035 No Project Conditions	29	1596	85	80	55	19	6	882	218	199	33	40	3242
2035 Project Background	29	1583	76	48	33	19	6	877	213	193	26	40	3143
2035 No Project Drive Access	0	-1	-9	-32	-22	0	0	0	0	0	-7	0	-71
2035 Project Drive Access	0	14	14	34	26	0	0	2	0	0	13	0	103
Change in Bkgrd (car-->BART)	0	-12	0	0	0	0	0	-5	-5	-6	0	0	-28
2035 Net Project Trips	0	1	5	2	4	0	0	-3	-5	-6	6	0	4
2035 Project Conditions	29	1597	90	82	59	19	6	879	213	193	39	40	3246
2035 Santa Clara West Option													
2035 SC West No Project Background	29	1595	76	48	33	19	6	882	218	199	26	40	3171
2035 SC West No Project Drive Access	0	1	9	32	22	0	0	0	0	0	7	0	71
2035 SC West No Project Conditions	29	1596	85	80	55	19	6	882	218	199	33	40	3242
2035 SC West Project Background	29	1583	76	48	33	19	6	877	213	193	26	40	3143
2035 SC West No Project Drive Access	0	-1	-9	-32	-22	0	0	0	0	0	-7	0	-71
2035 SC West Project Drive Access	0	0	18	70	56	0	0	0	0	0	17	0	161
Change in Bkgrd (car-->BART)	0	-12	0	0	0	0	0	-5	-5	-6	0	0	-28
2035 SC West Net Project Trips	0	-13	9	38	34	0	0	-5	-5	-6	10	0	62
2035 SC West Project Conditions	29	1583	94	118	89	19	6	877	213	193	43	40	3304

Intersection Number: 52
 Traffic Node #: 1012
 Model Node #: 60622
 Intersection Name: El Camino Real and Railroad Ave
 Peak Hour: PM

Date of Analysis: 06/15/15
 Count Date: 10/08/14

Scenario:	Movements												Total:
	North Approach			East Approach			South Approach			West Approach			
	RT	TH	LT	RT	TH	LT	RT	TH	LT	RT	TH	LT	
Existing Conditions	113	1085	51	36	4	58	24	580	143	146	3	59	2302
Project Trips	-1	-3	0	0	0	2	2	0	-3	-4	0	0	-7
Existing Plus Project Conditions	112	1082	51	36	4	60	26	580	140	142	3	59	2295
2025													
2025 No Project Background	113	1336	51	36	4	58	24	687	145	146	3	69	2672
2025 No Project Drive Access	0	0	0	0	0	11	2	0	0	0	0	0	13
2025 No Project Conditions	113	1336	51	36	4	69	26	687	145	146	3	69	2685
2025 Project Background	113	1320	51	36	4	58	24	683	142	142	3	68	2644
2025 No Project Drive Access	0	0	0	0	0	-11	-2	0	0	0	0	0	-13
2025 Project Drive Access	0	9	0	0	0	12	5	1	0	0	0	0	27
Change in Bkgrd (car-->BART)	0	-16	0	0	0	0	0	-4	-3	-4	0	-1	-28
2025 Net Project Trips	0	-7	0	0	0	1	3	-3	-3	-4	0	-1	-14
2025 Project Conditions	113	1329	51	36	4	70	29	684	142	142	3	68	2671
2025 Santa Clara West Option													
2025 SC West No Project Background	113	1336	51	36	4	58	24	687	145	146	3	69	2672
2025 SC West No Project Drive Access	0	0	0	0	0	11	2	0	0	0	0	0	13
2025 SC West No Project Conditions	113	1336	51	36	4	69	26	687	145	146	3	69	2685
2025 SC West Project Background	113	1320	51	36	4	58	24	683	142	142	3	68	2644
2025 SC West No Project Drive Access	0	0	0	0	0	-11	-2	0	0	0	0	0	-13
2025 SC West Project Drive Access	0	0	0	0	0	29	7	0	0	0	0	0	36
Change in Bkgrd (car-->BART)	0	-16	0	0	0	0	0	-4	-3	-4	0	-1	-28
2025 SC West Net Project Trips	0	-16	0	0	0	18	5	-4	-3	-4	0	-1	-5
2025 SC West Project Conditions	113	1320	51	36	4	87	31	683	142	142	3	68	2680
2035													
2035 No Project Background	114	1456	51	36	4	58	24	974	145	146	3	79	3090
2035 No Project Drive Access	0	1	0	0	0	27	8	0	0	0	0	0	36
2035 No Project Conditions	114	1457	51	36	4	85	32	974	145	146	3	79	3126
2035 Project Background	114	1440	51	36	4	58	24	965	141	141	3	77	3054
2035 No Project Drive Access	0	-1	0	0	0	-27	-8	0	0	0	0	0	-36
2035 Project Drive Access	0	14	0	0	0	29	12	2	0	0	0	0	57
Change in Bkgrd (car-->BART)	0	-16	0	0	0	0	0	-9	-4	-5	0	-2	-36
2035 Net Project Trips	0	-3	0	0	0	2	4	-7	-4	-5	0	-2	-15
2035 Project Conditions	114	1454	51	36	4	87	36	967	141	141	3	77	3111
2035 Santa Clara West Option													
2035 SC West No Project Background	114	1456	51	36	4	58	24	974	145	146	3	79	3090
2035 SC West No Project Drive Access	0	1	0	0	0	27	8	0	0	0	0	0	36
2035 SC West No Project Conditions	114	1457	51	36	4	85	32	974	145	146	3	79	3126
2035 SC West Project Background	114	1440	51	36	4	58	24	965	141	141	3	77	3054
2035 SC West No Project Drive Access	0	-1	0	0	0	-27	-8	0	0	0	0	0	-36
2035 SC West Project Drive Access	0	0	0	0	0	53	15	0	0	0	0	0	68
Change in Bkgrd (car-->BART)	0	-16	0	0	0	0	0	-9	-4	-5	0	-2	-36
2035 SC West Net Project Trips	0	-17	0	0	0	26	7	-9	-4	-5	0	-2	-4
2035 SC West Project Conditions	114	1440	51	36	4	111	39	965	141	141	3	77	3122

Intersection Number: 53
 Traffix Node #: 1213
 Model Node #: 8799
 Intersection Name: El Camino Real and The Alameda *
 Peak Hour: PM

Date of Analysis: 06/15/15
 Count Date: 09/17/14

Scenario:	Movements												Total:
	North Approach			East Approach			South Approach			West Approach			
	RT	TH	LT	RT	TH	LT	RT	TH	LT	RT	TH	LT	
Existing Conditions	155	1454	7	8	8	29	23	645	242	281	3	123	2978
Project Trips	2	-18	0	0	0	0	0	-6	-4	-6	0	1	-31
Existing Plus Project Conditions	157	1436	7	8	8	29	23	639	238	275	3	124	2947
2025													
2025 No Project Background	157	1661	7	8	8	29	23	759	288	281	3	123	3347
2025 No Project Drive Access	1	10	0	0	0	0	0	2	0	0	0	0	13
2025 No Project Conditions	158	1671	7	8	8	29	23	761	288	281	3	123	3360
2025 Project Background	157	1632	7	8	8	29	23	748	282	272	3	123	3292
2025 No Project Drive Access	-1	-10	0	0	0	0	0	-2	0	0	0	0	-13
2025 Project Drive Access	2	12	0	0	0	0	0	2	0	0	0	1	17
Change in Bkgrd (car-->BART)	0	-29	0	0	0	0	0	-11	-6	-9	0	0	-55
2025 Net Project Trips	1	-27	0	0	0	0	0	-11	-6	-9	0	1	-51
2025 Project Conditions	159	1644	7	8	8	29	23	750	282	272	3	124	3309
2025 Santa Clara West Option													
2025 SC West No Project Background	157	1661	7	8	8	29	23	759	288	281	3	123	3347
2025 SC West No Project Drive Access	1	10	0	0	0	0	0	2	0	0	0	0	13
2025 SC West No Project Conditions	158	1671	7	8	8	29	23	761	288	281	3	123	3360
2025 SC West Project Background	157	1632	7	8	8	29	23	748	282	272	3	123	3292
2025 SC West No Project Drive Access	-1	-10	0	0	0	0	0	-2	0	0	0	0	-13
2025 SC West Project Drive Access	6	15	0	0	0	0	0	2	0	0	0	1	24
Change in Bkgrd (car-->BART)	0	-29	0	0	0	0	0	-11	-6	-9	0	0	-55
2025 SC West Net Project Trips	5	-24	0	0	0	0	0	-11	-6	-9	0	1	-44
2025 SC West Project Conditions	163	1647	7	8	8	29	23	750	282	272	3	124	3316
2035													
2035 No Project Background	165	1755	7	8	8	29	23	1059	306	281	3	123	3767
2035 No Project Drive Access	1	24	0	0	0	0	0	7	0	0	0	0	32
2035 No Project Conditions	166	1779	7	8	8	29	23	1066	306	281	3	123	3799
2035 Project Background	165	1723	7	8	8	29	23	1040	297	272	3	123	3698
2035 No Project Drive Access	-1	-24	0	0	0	0	0	-7	0	0	0	0	-32
2035 Project Drive Access	2	29	0	0	0	0	0	7	0	0	0	2	40
Change in Bkgrd (car-->BART)	0	-32	0	0	0	0	0	-19	-9	-9	0	0	-69
2035 Net Project Trips	1	-27	0	0	0	0	0	-19	-9	-9	0	2	-61
2035 Project Conditions	167	1752	7	8	8	29	23	1047	297	272	3	125	3738
2035 Santa Clara West Option													
2035 SC West No Project Background	165	1755	7	8	8	29	23	1059	306	281	3	123	3767
2035 SC West No Project Drive Access	1	24	0	0	0	0	0	7	0	0	0	0	32
2035 SC West No Project Conditions	166	1779	7	8	8	29	23	1066	306	281	3	123	3799
2035 SC West Project Background	165	1723	7	8	8	29	23	1040	297	272	3	123	3698
2035 SC West No Project Drive Access	-1	-24	0	0	0	0	0	-7	0	0	0	0	-32
2035 SC West Project Drive Access	9	33	0	0	0	0	0	8	0	0	0	2	52
Change in Bkgrd (car-->BART)	0	-32	0	0	0	0	0	-19	-9	-9	0	0	-69
2035 SC West Net Project Trips	8	-23	0	0	0	0	0	-18	-9	-9	0	2	-49
2035 SC West Project Conditions	174	1756	7	8	8	29	23	1048	297	272	3	125	3750

Intersection Number: 54
 Traffic Node #: 107
 Model Node #: 8838
 Intersection Name: Lafayette St and Benton St
 Peak Hour: PM

Date of Analysis: 06/15/15
 Count Date: 10/08/14

Scenario:	Movements												Total:
	North Approach			East Approach			South Approach			West Approach			
	RT	TH	LT	RT	TH	LT	RT	TH	LT	RT	TH	LT	
Existing Conditions	55	1420	16	8	149	59	75	387	1	73	201	41	2485
Project Trips	1	3	0	0	1	1	2	0	0	0	1	0	9
Existing Plus Project Conditions	56	1423	16	8	150	60	77	387	1	73	202	41	2494
2025													
2025 No Project Background	60	1420	17	9	149	63	75	611	2	73	201	44	2724
2025 No Project Drive Access	0	0	0	0	11	1	4	0	0	0	0	0	16
2025 No Project Conditions	60	1420	17	9	160	64	79	611	2	73	201	44	2740
2025 Project Background	60	1412	17	9	149	63	75	609	2	73	201	43	2713
2025 No Project Drive Access	0	0	0	0	-11	-1	-4	0	0	0	0	0	-16
2025 Project Drive Access	1	8	0	0	12	2	6	1	0	0	1	0	31
Change in Bkgrd (car-->BART)	0	-8	0	0	0	0	0	-2	0	0	0	-1	-11
2025 Net Project Trips	1	0	0	0	1	1	2	-1	0	0	1	-1	4
2025 Project Conditions	61	1420	17	9	161	65	81	610	2	73	202	43	2744
2025 Santa Clara West Option													
2025 SC West No Project Background	60	1420	17	9	149	63	75	611	2	73	201	44	2724
2025 SC West No Project Drive Access	0	0	0	0	11	1	4	0	0	0	0	0	16
2025 SC West No Project Conditions	60	1420	17	9	160	64	79	611	2	73	201	44	2740
2025 SC West Project Background	60	1412	17	9	149	63	75	609	2	73	201	43	2713
2025 SC West No Project Drive Access	0	0	0	0	-11	-1	-4	0	0	0	0	0	-16
2025 SC West Project Drive Access	0	0	0	0	18	7	7	0	0	0	1	0	33
Change in Bkgrd (car-->BART)	0	-8	0	0	0	0	0	-2	0	0	0	-1	-11
2025 SC West Net Project Trips	0	-8	0	0	7	6	3	-2	0	0	1	-1	6
2025 SC West Project Conditions	60	1412	17	9	167	70	82	609	2	73	202	43	2746
2035													
2035 No Project Background	73	1450	19	10	149	73	75	721	9	73	201	47	2900
2035 No Project Drive Access	0	1	0	0	16	5	6	0	0	0	0	0	28
2035 No Project Conditions	73	1451	19	10	165	78	81	721	9	73	201	47	2928
2035 Project Background	73	1444	19	10	149	72	75	718	8	73	201	46	2888
2035 No Project Drive Access	0	-1	0	0	-16	-5	-6	0	0	0	0	0	-28
2035 Project Drive Access	1	12	0	0	20	4	11	2	0	0	1	0	51
Change in Bkgrd (car-->BART)	0	-6	0	0	0	-1	0	-3	-1	0	0	-1	-12
2035 Net Project Trips	1	5	0	0	4	-2	5	-1	-1	0	1	-1	11
2035 Project Conditions	74	1456	19	10	169	76	86	720	8	73	202	46	2939
2035 Santa Clara West Option													
2035 SC West No Project Background	73	1450	19	10	149	73	75	721	9	73	201	47	2900
2035 SC West No Project Drive Access	0	1	0	0	16	5	6	0	0	0	0	0	28
2035 SC West No Project Conditions	73	1451	19	10	165	78	81	721	9	73	201	47	2928
2035 SC West Project Background	73	1444	19	10	149	72	75	718	8	73	201	46	2888
2035 SC West No Project Drive Access	0	-1	0	0	-16	-5	-6	0	0	0	0	0	-28
2035 SC West Project Drive Access	0	0	0	0	39	12	14	0	0	0	2	0	67
Change in Bkgrd (car-->BART)	0	-6	0	0	0	-1	0	-3	-1	0	0	-1	-12
2035 SC West Net Project Trips	0	-7	0	0	23	6	8	-3	-1	0	2	-1	27
2035 SC West Project Conditions	73	1444	19	10	188	84	89	718	8	73	203	46	2955

Intersection Number: 55
 Traffix Node #: 9
 Model Node #: 6462
 Intersection Name: Coleman Ave and Brokaw Rd
 Peak Hour: PM

Date of Analysis: 06/15/15
 Count Date: 10/08/14

Scenario:	Movements												Total:
	North Approach			East Approach			South Approach			West Approach			
	RT	TH	LT	RT	TH	LT	RT	TH	LT	RT	TH	LT	
Existing Conditions	55	1875	7	23	28	362	44	555	197	305	7	203	3661
Project Trips	3	-17	0	0	0	0	0	-17	-1	0	0	27	-5
Existing Plus Project Conditions	58	1858	7	23	28	362	44	538	196	305	7	230	3656
2025													
2025 No Project Background	59	1946	9	24	29	362	44	876	202	316	7	216	4090
2025 No Project Drive Access	0	1	0	0	0	0	0	1	0	0	0	0	2
2025 No Project Conditions	59	1947	9	24	29	362	44	877	202	316	7	216	4092
2025 Project Background	59	1916	9	24	29	362	44	854	201	313	7	215	4033
2025 No Project Drive Access	0	-1	0	0	0	0	0	-1	0	0	0	0	-2
2025 Project Drive Access	5	1	0	0	0	0	0	0	2	8	0	41	57
Change in Bkgrd (car-->BART)	0	-30	0	0	0	0	0	-22	-1	-3	0	-1	-57
2025 Net Project Trips	5	-30	0	0	0	0	0	-23	1	5	0	40	-2
2025 Project Conditions	64	1917	9	24	29	362	44	854	203	321	7	256	4090
2025 Santa Clara West Option													
2025 SC West No Project Background	59	1946	9	24	29	362	44	876	202	316	7	216	4090
2025 SC West No Project Drive Access	0	1	0	0	0	0	0	1	0	0	0	0	2
2025 SC West No Project Conditions	59	1947	9	24	29	362	44	877	202	316	7	216	4092
2025 SC West Project Background	59	1916	9	24	29	362	44	854	201	313	7	215	4033
2025 SC West No Project Drive Access	0	-1	0	0	0	0	0	-1	0	0	0	0	-2
2025 SC West Project Drive Access	0	4	0	0	0	0	0	1	1	1	0	0	7
Change in Bkgrd (car-->BART)	0	-30	0	0	0	0	0	-22	-1	-3	0	-1	-57
2025 SC West Net Project Trips	0	-27	0	0	0	0	0	-22	0	-2	0	-1	-52
2025 SC West Project Conditions	59	1920	9	24	29	362	44	855	202	314	7	215	4040
2035													
2035 No Project Background	63	1993	10	26	29	362	46	1014	208	317	7	234	4309
2035 No Project Drive Access	0	3	0	0	0	0	0	1	0	0	0	0	4
2035 No Project Conditions	63	1996	10	26	29	362	46	1015	208	317	7	234	4313
2035 Project Background	63	1969	10	26	29	362	46	987	207	314	7	233	4253
2035 No Project Drive Access	0	-3	0	0	0	0	0	-1	0	0	0	0	-4
2035 Project Drive Access	9	2	0	0	0	0	0	1	5	16	0	78	111
Change in Bkgrd (car-->BART)	0	-24	0	0	0	0	0	-27	-1	-3	0	-1	-56
2035 Net Project Trips	9	-25	0	0	0	0	0	-27	4	13	0	77	51
2035 Project Conditions	72	1971	10	26	29	362	46	988	212	330	7	311	4364
2035 Santa Clara West Option													
2035 SC West No Project Background	63	1993	10	26	29	362	46	1014	208	317	7	234	4309
2035 SC West No Project Drive Access	0	3	0	0	0	0	0	1	0	0	0	0	4
2035 SC West No Project Conditions	63	1996	10	26	29	362	46	1015	208	317	7	234	4313
2035 SC West Project Background	63	1969	10	26	29	362	46	987	207	314	7	233	4253
2035 SC West No Project Drive Access	0	-3	0	0	0	0	0	-1	0	0	0	0	-4
2035 SC West Project Drive Access	0	11	0	0	0	0	0	2	3	2	0	0	18
Change in Bkgrd (car-->BART)	0	-24	0	0	0	0	0	-27	-1	-3	0	-1	-56
2035 SC West Net Project Trips	0	-16	0	0	0	0	0	-26	2	-1	0	-1	-42
2035 SC West Project Conditions	63	1980	10	26	29	362	46	989	210	316	7	233	4271

Intersection Number: 56
 Traffix Node #: 3411
 Model Node #: 60625
 Intersection Name: Coleman Ave and Aviation Ave
 Peak Hour: PM

Date of Analysis: 06/15/15
 Count Date: 10/08/14

Scenario:	Movements												Total:
	North Approach			East Approach			South Approach			West Approach			
	RT	TH	LT	RT	TH	LT	RT	TH	LT	RT	TH	LT	
Existing Conditions	0	2721	5	7	0	45	26	795	16	10	0	1	3626
Project Trips	0	-17	0	0	0	0	0	-18	0	0	0	0	-35
Existing Plus Project Conditions	0	2704	5	7	0	45	26	777	16	10	0	1	3591
2025													
2025 No Project Background	0	2804	5	7	0	45	26	1123	16	10	0	1	4037
2025 No Project Drive Access	0	1	0	0	0	0	0	1	0	0	0	0	2
2025 No Project Conditions	0	2805	5	7	0	45	26	1124	16	10	0	1	4039
2025 Project Background	0	2770	5	7	0	45	26	1100	16	10	0	1	3980
2025 No Project Drive Access	0	-1	0	0	0	0	0	-1	0	0	0	0	-2
2025 Project Drive Access	0	9	0	0	0	0	0	2	0	0	0	0	11
Change in Bkgrd (car-->BART)	0	-34	0	0	0	0	0	-23	0	0	0	0	-57
2025 Net Project Trips	0	-26	0	0	0	0	0	-22	0	0	0	0	-48
2025 Project Conditions	0	2779	5	7	0	45	26	1102	16	10	0	1	3991
2025 Santa Clara West Option													
2025 SC West No Project Background	0	2804	5	7	0	45	26	1123	16	10	0	1	4037
2025 SC West No Project Drive Access	0	1	0	0	0	0	0	1	0	0	0	0	2
2025 SC West No Project Conditions	0	2805	5	7	0	45	26	1124	16	10	0	1	4039
2025 SC West Project Background	0	2770	5	7	0	45	26	1100	16	10	0	1	3980
2025 SC West No Project Drive Access	0	-1	0	0	0	0	0	-1	0	0	0	0	-2
2025 SC West Project Drive Access	0	6	0	0	0	0	0	2	0	0	0	0	8
Change in Bkgrd (car-->BART)	0	-34	0	0	0	0	0	-23	0	0	0	0	-57
2025 SC West Net Project Trips	0	-29	0	0	0	0	0	-22	0	0	0	0	-51
2025 SC West Project Conditions	0	2776	5	7	0	45	26	1102	16	10	0	1	3988
2035													
2035 No Project Background	0	2853	5	7	0	45	26	1267	16	10	0	1	4230
2035 No Project Drive Access	0	3	0	0	0	0	0	1	0	0	0	0	4
2035 No Project Conditions	0	2856	5	7	0	45	26	1268	16	10	0	1	4234
2035 Project Background	0	2825	5	7	0	45	26	1239	16	10	0	1	4174
2035 No Project Drive Access	0	-3	0	0	0	0	0	-1	0	0	0	0	-4
2035 Project Drive Access	0	18	0	0	0	0	0	5	0	0	0	0	23
Change in Bkgrd (car-->BART)	0	-28	0	0	0	0	0	-28	0	0	0	0	-56
2035 Net Project Trips	0	-13	0	0	0	0	0	-24	0	0	0	0	-37
2035 Project Conditions	0	2843	5	7	0	45	26	1244	16	10	0	1	4197
2035 Santa Clara West Option													
2035 SC West No Project Background	0	2853	5	7	0	45	26	1267	16	10	0	1	4230
2035 SC West No Project Drive Access	0	3	0	0	0	0	0	1	0	0	0	0	4
2035 SC West No Project Conditions	0	2856	5	7	0	45	26	1268	16	10	0	1	4234
2035 SC West Project Background	0	2825	5	7	0	45	26	1239	16	10	0	1	4174
2035 SC West No Project Drive Access	0	-3	0	0	0	0	0	-1	0	0	0	0	-4
2035 SC West Project Drive Access	0	14	0	0	0	0	0	5	0	0	0	0	19
Change in Bkgrd (car-->BART)	0	-28	0	0	0	0	0	-28	0	0	0	0	-56
2035 SC West Net Project Trips	0	-17	0	0	0	0	0	-24	0	0	0	0	-41
2035 SC West Project Conditions	0	2839	5	7	0	45	26	1244	16	10	0	1	4193

Intersection Number: 57
 Traffic Node #: 4047
 Model Node #: 4076
 Intersection Name: Coleman Ave and Newhall Dr
 Peak Hour: PM

Date of Analysis: 06/15/15
 Count Date: 10/08/14

Scenario:	Movements												Total:
	North Approach			East Approach			South Approach			West Approach			
	RT	TH	LT	RT	TH	LT	RT	TH	LT	RT	TH	LT	
Existing Conditions	182	2578	0	0	0	0	0	729	335	362	0	73	4259
Project Trips	0	-17	0	0	0	0	0	-18	-1	-1	0	0	-37
Existing Plus Project Conditions	182	2561	0	0	0	0	0	711	334	361	0	73	4222
2025													
2025 No Project Background	182	2581	0	0	0	0	0	952	548	665	0	73	5001
2025 No Project Drive Access	0	1	0	0	0	0	0	1	0	0	0	0	2
2025 No Project Conditions	182	2582	0	0	0	0	0	953	548	665	0	73	5003
2025 Project Background	182	2549	0	0	0	0	0	930	543	653	0	73	4930
2025 No Project Drive Access	0	-1	0	0	0	0	0	-1	0	0	0	0	-2
2025 Project Drive Access	0	4	0	0	0	0	0	1	0	0	0	0	5
Change in Bkgrd (car->BART)	0	-32	0	0	0	0	0	-22	-5	-12	0	0	-71
2025 Net Project Trips	0	-29	0	0	0	0	0	-22	-5	-12	0	0	-68
2025 Project Conditions	182	2553	0	0	0	0	0	931	543	653	0	73	4935
2025 Santa Clara West Option													
2025 SC West No Project Background	182	2581	0	0	0	0	0	952	548	665	0	73	5001
2025 SC West No Project Drive Access	0	1	0	0	0	0	0	1	0	0	0	0	2
2025 SC West No Project Conditions	182	2582	0	0	0	0	0	953	548	665	0	73	5003
2025 SC West Project Background	182	2549	0	0	0	0	0	930	543	653	0	73	4930
2025 SC West No Project Drive Access	0	-1	0	0	0	0	0	-1	0	0	0	0	-2
2025 SC West Project Drive Access	0	1	0	0	0	0	0	0	0	0	0	0	1
Change in Bkgrd (car->BART)	0	-32	0	0	0	0	0	-22	-5	-12	0	0	-71
2025 SC West Net Project Trips	0	-32	0	0	0	0	0	-23	-5	-12	0	0	-72
2025 SC West Project Conditions	182	2550	0	0	0	0	0	930	543	653	0	73	4931
2035													
2035 No Project Background	182	2610	0	0	0	0	0	959	732	836	0	73	5392
2035 No Project Drive Access	0	2	0	0	0	0	0	1	1	0	0	0	4
2035 No Project Conditions	182	2612	0	0	0	0	0	960	733	836	0	73	5396
2035 Project Background	182	2582	0	0	0	0	0	933	721	823	0	73	5314
2035 No Project Drive Access	0	-2	0	0	0	0	0	-1	-1	0	0	0	-4
2035 Project Drive Access	0	7	0	0	0	0	0	1	1	0	0	0	9
Change in Bkgrd (car->BART)	0	-28	0	0	0	0	0	-26	-11	-13	0	0	-78
2035 Net Project Trips	0	-23	0	0	0	0	0	-26	-11	-13	0	0	-73
2035 Project Conditions	182	2589	0	0	0	0	0	934	722	823	0	73	5323
2035 Santa Clara West Option													
2035 SC West No Project Background	182	2610	0	0	0	0	0	959	732	836	0	73	5392
2035 SC West No Project Drive Access	0	2	0	0	0	0	0	1	1	0	0	0	4
2035 SC West No Project Conditions	182	2612	0	0	0	0	0	960	733	836	0	73	5396
2035 SC West Project Background	182	2582	0	0	0	0	0	933	721	823	0	73	5314
2035 SC West No Project Drive Access	0	-2	0	0	0	0	0	-1	-1	0	0	0	-4
2035 SC West Project Drive Access	0	2	0	0	0	0	0	1	1	0	0	0	4
Change in Bkgrd (car->BART)	0	-28	0	0	0	0	0	-26	-11	-13	0	0	-78
2035 SC West Net Project Trips	0	-28	0	0	0	0	0	-26	-11	-13	0	0	-78
2035 SC West Project Conditions	182	2584	0	0	0	0	0	934	722	823	0	73	5318

Intersection Number: 58
 Traffix Node #: 5444
 Model Node #: 6470
 Intersection Name: Lafayette St and Lewis St
 Peak Hour: PM

Date of Analysis: 06/15/15
 Count Date: 10/08/14

Scenario:	Movements												Total:
	North Approach			East Approach			South Approach			West Approach			
	RT	TH	LT	RT	TH	LT	RT	TH	LT	RT	TH	LT	
Existing Conditions	22	1146	0	267	270	518	0	380	3	0	0	0	2606
Project Trips	0	-1	0	0	3	5	0	0	0	0	0	0	7
Existing Plus Project Conditions	22	1145	0	267	273	523	0	380	3	0	0	0	2613
2025													
2025 No Project Background	22	1206	0	281	358	518	0	562	5	0	0	0	2952
2025 No Project Drive Access	0	0	0	0	5	0	0	0	0	0	0	0	5
2025 No Project Conditions	22	1206	0	281	363	518	0	562	5	0	0	0	2957
2025 Project Background	22	1201	0	281	354	516	0	560	5	0	0	0	2939
2025 No Project Drive Access	0	0	0	0	-5	0	0	0	0	0	0	0	-5
2025 Project Drive Access	0	0	0	0	9	9	0	1	0	0	0	0	19
Change in Bkgrd (car-->BART)	0	-5	0	0	-4	-2	0	-2	0	0	0	0	-13
2025 Net Project Trips	0	-5	0	0	0	7	0	-1	0	0	0	0	1
2025 Project Conditions	22	1201	0	281	363	525	0	561	5	0	0	0	2958
2025 Santa Clara West Option													
2025 SC West No Project Background	22	1206	0	281	358	518	0	562	5	0	0	0	2952
2025 SC West No Project Drive Access	0	0	0	0	5	0	0	0	0	0	0	0	5
2025 SC West No Project Conditions	22	1206	0	281	363	518	0	562	5	0	0	0	2957
2025 SC West Project Background	22	1201	0	281	354	516	0	560	5	0	0	0	2939
2025 SC West No Project Drive Access	0	0	0	0	-5	0	0	0	0	0	0	0	-5
2025 SC West Project Drive Access	0	0	0	0	4	0	0	0	0	0	0	0	4
Change in Bkgrd (car-->BART)	0	-5	0	0	-4	-2	0	-2	0	0	0	0	-13
2025 SC West Net Project Trips	0	-5	0	0	-5	-2	0	-2	0	0	0	0	-14
2025 SC West Project Conditions	22	1201	0	281	358	516	0	560	5	0	0	0	2943
2035													
2035 No Project Background	22	1275	0	300	365	518	0	659	7	0	0	0	3146
2035 No Project Drive Access	0	0	0	0	6	0	0	0	0	0	0	0	6
2035 No Project Conditions	22	1275	0	300	371	518	0	659	7	0	0	0	3152
2035 Project Background	22	1272	0	300	362	517	0	656	7	0	0	0	3136
2035 No Project Drive Access	0	0	0	0	-6	0	0	0	0	0	0	0	-6
2035 Project Drive Access	0	1	0	0	22	13	0	2	0	0	0	0	38
Change in Bkgrd (car-->BART)	0	-3	0	0	-3	-1	0	-3	0	0	0	0	-10
2035 Net Project Trips	0	-2	0	0	13	12	0	-1	0	0	0	0	22
2035 Project Conditions	22	1273	0	300	384	530	0	658	7	0	0	0	3174
2035 Santa Clara West Option													
2035 SC West No Project Background	22	1275	0	300	365	518	0	659	7	0	0	0	3146
2035 SC West No Project Drive Access	0	0	0	0	6	0	0	0	0	0	0	0	6
2035 SC West No Project Conditions	22	1275	0	300	371	518	0	659	7	0	0	0	3152
2035 SC West Project Background	22	1272	0	300	362	517	0	656	7	0	0	0	3136
2035 SC West No Project Drive Access	0	0	0	0	-6	0	0	0	0	0	0	0	-6
2035 SC West Project Drive Access	0	0	0	0	5	0	0	0	0	0	0	0	5
Change in Bkgrd (car-->BART)	0	-3	0	0	-3	-1	0	-3	0	0	0	0	-10
2035 SC West Net Project Trips	0	-3	0	0	-4	-1	0	-3	0	0	0	0	-11
2035 SC West Project Conditions	22	1272	0	300	367	517	0	656	7	0	0	0	3141

Intersection Number: 59
 Traffix Node #: 1008
 Model Node #: 7197
 Intersection Name: Lafayette St and Harrison St
 Peak Hour: PM

Date of Analysis: 06/15/15
 Count Date: 10/08/14

Scenario:	Movements												Total:
	North Approach			East Approach			South Approach			West Approach			
	RT	TH	LT	RT	TH	LT	RT	TH	LT	RT	TH	LT	
Existing Conditions	1	1519	145	7	4	4	40	372	4	9	20	3	2128
Project Trips	0	4	0	0	0	0	0	0	0	0	0	0	4
Existing Plus Project Conditions	1	1523	145	7	4	4	40	372	4	9	20	3	2132
2025													
2025 No Project Background	1	1519	165	7	4	41	85	556	4	9	20	3	2414
2025 No Project Drive Access	0	1	0	0	0	0	0	0	0	0	0	0	1
2025 No Project Conditions	1	1520	165	7	4	41	85	556	4	9	20	3	2415
2025 Project Background	1	1511	165	7	4	41	84	554	4	9	20	3	2403
2025 No Project Drive Access	0	-1	0	0	0	0	0	0	0	0	0	0	-1
2025 Project Drive Access	0	9	0	0	0	0	0	1	0	0	0	0	10
Change in Bkgrd (car-->BART)	0	-8	0	0	0	0	-1	-2	0	0	0	0	-11
2025 Net Project Trips	0	0	0	0	0	0	-1	-1	0	0	0	0	-2
2025 Project Conditions	1	1520	165	7	4	41	84	555	4	9	20	3	2413
2025 Santa Clara West Option													
2025 SC West No Project Background	1	1519	165	7	4	41	85	556	4	9	20	3	2414
2025 SC West No Project Drive Access	0	1	0	0	0	0	0	0	0	0	0	0	1
2025 SC West No Project Conditions	1	1520	165	7	4	41	85	556	4	9	20	3	2415
2025 SC West Project Background	1	1511	165	7	4	41	84	554	4	9	20	3	2403
2025 SC West No Project Drive Access	0	-1	0	0	0	0	0	0	0	0	0	0	-1
2025 SC West Project Drive Access	0	0	0	0	0	0	0	0	0	0	0	0	0
Change in Bkgrd (car-->BART)	0	-8	0	0	0	0	-1	-2	0	0	0	0	-11
2025 SC West Net Project Trips	0	-9	0	0	0	0	-1	-2	0	0	0	0	-12
2025 SC West Project Conditions	1	1511	165	7	4	41	84	554	4	9	20	3	2403
2035													
2035 No Project Background	1	1519	185	7	4	79	99	654	4	9	21	4	2586
2035 No Project Drive Access	0	1	0	0	0	0	0	0	0	0	0	0	1
2035 No Project Conditions	1	1520	185	7	4	79	99	654	4	9	21	4	2587
2035 Project Background	1	1514	185	7	4	78	98	651	4	9	21	4	2576
2035 No Project Drive Access	0	-1	0	0	0	0	0	0	0	0	0	0	-1
2035 Project Drive Access	0	13	0	0	0	0	0	2	0	0	1	0	16
Change in Bkgrd (car-->BART)	0	-5	0	0	0	-1	-1	-3	0	0	0	0	-10
2035 Net Project Trips	0	7	0	0	0	-1	-1	-1	0	0	1	0	5
2035 Project Conditions	1	1527	185	7	4	78	98	653	4	9	22	4	2592
2035 Santa Clara West Option													
2035 SC West No Project Background	1	1519	185	7	4	79	99	654	4	9	21	4	2586
2035 SC West No Project Drive Access	0	1	0	0	0	0	0	0	0	0	0	0	1
2035 SC West No Project Conditions	1	1520	185	7	4	79	99	654	4	9	21	4	2587
2035 SC West Project Background	1	1514	185	7	4	78	98	651	4	9	21	4	2576
2035 SC West No Project Drive Access	0	-1	0	0	0	0	0	0	0	0	0	0	-1
2035 SC West Project Drive Access	0	0	0	0	0	0	0	0	0	0	1	0	1
Change in Bkgrd (car-->BART)	0	-5	0	0	0	-1	-1	-3	0	0	0	0	-10
2035 SC West Net Project Trips	0	-6	0	0	0	-1	-1	-3	0	0	1	0	-10
2035 SC West Project Conditions	1	1514	185	7	4	78	98	651	4	9	22	4	2577

Intersection Number: 60
 Traffic Node #: 5335
 Model Node #: 4798
 Intersection Name: De La Cruz Blvd and Central Expressway *
 Peak Hour: PM

Date of Analysis: 06/15/15
 Count Date: 10/02/14

Scenario:	Movements												Total:
	North Approach			East Approach			South Approach			West Approach			
	RT	TH	LT	RT	TH	LT	RT	TH	LT	RT	TH	LT	
Existing Conditions	817	1092	0	0	0	0	0	657	182	1026	0	2083	5857
Project Trips	-2	-5	0	0	0	0	0	-5	-2	-4	0	-2	-20
Existing Plus Project Conditions	815	1087	0	0	0	0	0	652	180	1022	0	2081	5837
2025													
2025 No Project Background	1013	1092	0	0	0	0	0	657	530	1222	0	2501	7015
2025 No Project Drive Access	5	9	0	0	0	0	0	10	4	0	0	2	30
2025 No Project Conditions	1018	1101	0	0	0	0	0	667	534	1222	0	2503	7045
2025 Project Background	1005	1084	0	0	0	0	0	645	525	1214	0	2484	6957
2025 No Project Drive Access	-5	-9	0	0	0	0	0	-10	-4	0	0	-2	-30
2025 Project Drive Access	3	1	0	0	0	0	0	8	4	0	0	1	17
Change in Bkgrd (car-->BART)	-8	-8	0	0	0	0	0	-12	-5	-8	0	-17	-58
2025 Net Project Trips	-10	-16	0	0	0	0	0	-14	-5	-8	0	-18	-71
2025 Project Conditions	1008	1085	0	0	0	0	0	653	529	1214	0	2485	6974
2025 Santa Clara West Option													
2025 SC West No Project Background	1013	1092	0	0	0	0	0	657	530	1222	0	2501	7015
2025 SC West No Project Drive Access	5	9	0	0	0	0	0	10	4	0	0	2	30
2025 SC West No Project Conditions	1018	1101	0	0	0	0	0	667	534	1222	0	2503	7045
2025 SC West Project Background	1005	1084	0	0	0	0	0	645	525	1214	0	2484	6957
2025 SC West No Project Drive Access	-5	-9	0	0	0	0	0	-10	-4	0	0	-2	-30
2025 SC West Project Drive Access	4	1	0	0	0	0	0	8	3	0	0	1	17
Change in Bkgrd (car-->BART)	-8	-8	0	0	0	0	0	-12	-5	-8	0	-17	-58
2025 SC West Net Project Trips	-9	-16	0	0	0	0	0	-14	-6	-8	0	-18	-71
2025 SC West Project Conditions	1009	1085	0	0	0	0	0	653	528	1214	0	2485	6974
2035													
2035 No Project Background	1078	1092	0	0	0	0	0	657	747	1377	0	2518	7469
2035 No Project Drive Access	12	9	0	0	0	0	0	14	6	0	0	3	44
2035 No Project Conditions	1090	1101	0	0	0	0	0	671	753	1377	0	2521	7513
2035 Project Background	1073	1086	0	0	0	0	0	648	742	1370	0	2511	7430
2035 No Project Drive Access	-12	-9	0	0	0	0	0	-14	-6	0	0	-3	-44
2035 Project Drive Access	8	3	0	0	0	0	0	13	6	0	0	2	32
Change in Bkgrd (car-->BART)	-5	-6	0	0	0	0	0	-9	-5	-7	0	-7	-39
2035 Net Project Trips	-9	-12	0	0	0	0	0	-10	-5	-7	0	-8	-51
2035 Project Conditions	1081	1089	0	0	0	0	0	661	748	1370	0	2513	7462
2035 Santa Clara West Option													
2035 SC West No Project Background	1078	1092	0	0	0	0	0	657	747	1377	0	2518	7469
2035 SC West No Project Drive Access	12	9	0	0	0	0	0	14	6	0	0	3	44
2035 SC West No Project Conditions	1090	1101	0	0	0	0	0	671	753	1377	0	2521	7513
2035 SC West Project Background	1073	1086	0	0	0	0	0	648	742	1370	0	2511	7430
2035 SC West No Project Drive Access	-12	-9	0	0	0	0	0	-14	-6	0	0	-3	-44
2035 SC West Project Drive Access	7	3	0	0	0	0	0	13	6	0	0	2	31
Change in Bkgrd (car-->BART)	-5	-6	0	0	0	0	0	-9	-5	-7	0	-7	-39
2035 SC West Net Project Trips	-10	-12	0	0	0	0	0	-10	-5	-7	0	-8	-52
2035 SC West Project Conditions	1080	1089	0	0	0	0	0	661	748	1370	0	2513	7461

Intersection Number: 61
 Traffix Node #: 6
 Model Node #: 6450
 Intersection Name: De La Cruz Blvd and Martin Ave
 Peak Hour: PM

Date of Analysis: 06/15/15
 Count Date: 10/08/14

Scenario:	Movements												Total:
	North Approach			East Approach			South Approach			West Approach			
	RT	TH	LT	RT	TH	LT	RT	TH	LT	RT	TH	LT	
Existing Conditions	46	1980	138	70	18	14	11	402	56	407	139	151	3432
Project Trips	0	-9	0	0	0	0	0	-6	-1	-1	0	-1	-18
Existing Plus Project Conditions	46	1971	138	70	18	14	11	396	55	406	139	150	3414
2025													
2025 No Project Background	71	1980	139	70	18	14	11	622	112	437	139	151	3764
2025 No Project Drive Access	0	10	0	0	0	0	0	13	0	0	0	0	23
2025 No Project Conditions	71	1990	139	70	18	14	11	635	112	437	139	151	3787
2025 Project Background	71	1964	139	70	18	14	11	609	110	435	139	148	3728
2025 No Project Drive Access	0	-10	0	0	0	0	0	-13	0	0	0	0	-23
2025 Project Drive Access	0	2	0	0	0	0	0	11	0	0	0	0	13
Change in Bkgrd (car-->BART)	0	-16	0	0	0	0	0	-13	-2	-2	0	-3	-36
2025 Net Project Trips	0	-24	0	0	0	0	0	-15	-2	-2	0	-3	-46
2025 Project Conditions	71	1966	139	70	18	14	11	620	110	435	139	148	3741
2025 Santa Clara West Option													
2025 SC West No Project Background	71	1980	139	70	18	14	11	622	112	437	139	151	3764
2025 SC West No Project Drive Access	0	10	0	0	0	0	0	13	0	0	0	0	23
2025 SC West No Project Conditions	71	1990	139	70	18	14	11	635	112	437	139	151	3787
2025 SC West Project Background	71	1964	139	70	18	14	11	609	110	435	139	148	3728
2025 SC West No Project Drive Access	0	-10	0	0	0	0	0	-13	0	0	0	0	-23
2025 SC West Project Drive Access	0	2	0	0	0	0	0	10	0	0	0	0	12
Change in Bkgrd (car-->BART)	0	-16	0	0	0	0	0	-13	-2	-2	0	-3	-36
2025 SC West Net Project Trips	0	-24	0	0	0	0	0	-16	-2	-2	0	-3	-47
2025 SC West Project Conditions	71	1966	139	70	18	14	11	619	110	435	139	148	3740
2035													
2035 No Project Background	46	2072	138	70	18	14	11	861	147	433	139	151	4100
2035 No Project Drive Access	0	11	0	0	0	0	0	20	0	0	0	0	31
2035 No Project Conditions	46	2083	138	70	18	14	11	881	147	433	139	151	4131
2035 Project Background	46	2059	138	70	18	14	11	848	143	431	139	150	4067
2035 No Project Drive Access	0	-11	0	0	0	0	0	-20	0	0	0	0	-31
2035 Project Drive Access	0	3	0	0	0	0	0	19	0	0	0	0	22
Change in Bkgrd (car-->BART)	0	-13	0	0	0	0	0	-13	-4	-2	0	-1	-33
2035 Net Project Trips	0	-21	0	0	0	0	0	-14	-4	-2	0	-1	-42
2035 Project Conditions	46	2062	138	70	18	14	11	867	143	431	139	150	4089
2035 Santa Clara West Option													
2035 SC West No Project Background	46	2072	138	70	18	14	11	861	147	433	139	151	4100
2035 SC West No Project Drive Access	0	11	0	0	0	0	0	20	0	0	0	0	31
2035 SC West No Project Conditions	46	2083	138	70	18	14	11	881	147	433	139	151	4131
2035 SC West Project Background	46	2059	138	70	18	14	11	848	143	431	139	150	4067
2035 SC West No Project Drive Access	0	-11	0	0	0	0	0	-20	0	0	0	0	-31
2035 SC West Project Drive Access	0	3	0	0	0	0	0	19	0	0	0	0	22
Change in Bkgrd (car-->BART)	0	-13	0	0	0	0	0	-13	-4	-2	0	-1	-33
2035 SC West Net Project Trips	0	-21	0	0	0	0	0	-14	-4	-2	0	-1	-42
2035 SC West Project Conditions	46	2062	138	70	18	14	11	867	143	431	139	150	4089

Intersection Number: 63
 Traffic Node #: 3789
 Model Node #: 6858
 Intersection Name: 21st St and Santa Clara St
 Peak Hour: PM

Date of Analysis: 06/15/15
 Count Date: 10/09/14

Scenario:	Movements												Total:
	North Approach			East Approach			South Approach			West Approach			
	RT	TH	LT	RT	TH	LT	RT	TH	LT	RT	TH	LT	
Existing Conditions	20	12	41	35	331	22	25	3	25	64	948	28	1554
Project Trips	0	0	0	0	0	0	0	0	0	0	-12	0	-12
Existing Plus Project Conditions	20	12	41	35	331	22	25	3	25	64	936	28	1542
2025													
2025 No Project Background	50	12	43	35	440	26	25	3	25	64	948	30	1701
2025 No Project Drive Access	0	0	0	0	0	0	0	0	0	0	5	0	5
2025 No Project Conditions	50	12	43	35	440	26	25	3	25	64	953	30	1706
2025 Project Background	49	12	43	35	435	26	25	3	25	64	929	30	1676
2025 No Project Drive Access	0	0	0	0	0	0	0	0	0	0	-5	0	-5
2025 Project Drive Access	0	0	0	0	6	0	0	0	0	0	8	0	14
Change in Bkgrd (car-->BART)	-1	0	0	0	-5	0	0	0	0	0	-19	0	-25
2025 Net Project Trips	-1	0	0	0	1	0	0	0	0	0	-16	0	-16
2025 Project Conditions	49	12	43	35	441	26	25	3	25	64	937	30	1690
2035													
2035 No Project Background	59	12	44	35	539	23	25	4	25	64	948	35	1813
2035 No Project Drive Access	0	0	0	0	1	0	0	0	0	0	7	0	8
2035 No Project Conditions	59	12	44	35	540	23	25	4	25	64	955	35	1821
2035 Project Background	57	12	44	35	532	23	25	4	25	64	913	35	1769
2035 No Project Drive Access	0	0	0	0	-1	0	0	0	0	0	-7	0	-8
2035 Project Drive Access	0	0	0	0	29	0	0	0	0	0	14	0	43
Change in Bkgrd (car-->BART)	-2	0	0	0	-7	0	0	0	0	0	-35	0	-44
2035 Net Project Trips	-2	0	0	0	21	0	0	0	0	0	-28	0	-9
2035 Project Conditions	57	12	44	35	561	23	25	4	25	64	927	35	1812

Intersection Number: 64
 Traffic Node #: 4022
 Model Node #: 8526
 Intersection Name: 26th St and Santa Clara St
 Peak Hour: PM

Date of Analysis: 06/15/15
 Count Date: 10/09/14

Scenario:	Movements												Total:
	North Approach			East Approach			South Approach			West Approach			
	RT	TH	LT	RT	TH	LT	RT	TH	LT	RT	TH	LT	
Existing Conditions	39	52	51	41	467	46	41	16	6	25	847	28	1659
Project Trips	0	0	0	0	13	0	0	0	0	0	4	0	17
Existing Plus Project Conditions	39	52	51	41	480	46	41	16	6	25	851	28	1676
2025													
2025 No Project Background	39	52	51	41	578	46	41	16	6	25	847	28	1770
2025 No Project Drive Access	0	0	0	0	0	0	0	0	0	0	2	0	2
2025 No Project Conditions	39	52	51	41	578	46	41	16	6	25	849	28	1772
2025 Project Background	39	52	51	41	576	46	41	16	6	25	838	28	1759
2025 No Project Drive Access	0	0	0	0	0	0	0	0	0	0	-2	0	-2
2025 Project Drive Access	0	0	0	0	31	0	0	0	0	0	20	0	51
Change in Bkgrd (car-->BART)	0	0	0	0	-2	0	0	0	0	0	-9	0	-11
2025 Net Project Trips	0	0	0	0	29	0	0	0	0	0	9	0	38
2025 Project Conditions	39	52	51	41	607	46	41	16	6	25	858	28	1810
2035													
2035 No Project Background	39	52	51	41	657	46	41	16	6	25	847	28	1849
2035 No Project Drive Access	0	0	0	0	1	0	0	0	0	0	4	0	5
2035 No Project Conditions	39	52	51	41	658	46	41	16	6	25	851	28	1854
2035 Project Background	39	52	51	41	653	46	41	16	6	25	831	28	1829
2035 No Project Drive Access	0	0	0	0	-1	0	0	0	0	0	-4	0	-5
2035 Project Drive Access	0	0	0	0	57	0	0	0	0	0	24	0	81
Change in Bkgrd (car-->BART)	0	0	0	0	-4	0	0	0	0	0	-16	0	-20
2035 Net Project Trips	0	0	0	0	52	0	0	0	0	0	4	0	56
2035 Project Conditions	39	52	51	41	710	46	41	16	6	25	855	28	1910

Appendix E

Level of Service Calculations – Alum Rock/28th Street Station

BART Phase II Extension Project

Level Of Service Computation Report
 2000 HCM Operations (Future Volume Alternative)
 AM - Existing Conditions

Intersection #3016: 101/ALUM ROCK

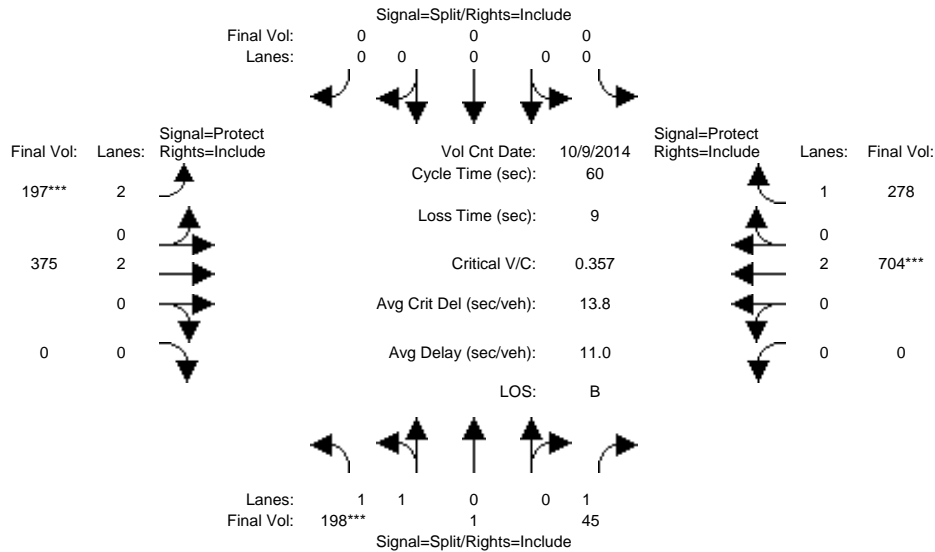

Approach:	North Bound			South Bound			East Bound			West Bound		
	L	T	R	L	T	R	L	T	R	L	T	R
Min. Green:	10	10	10	0	0	0	7	10	0	0	10	10
Y+R:	4.0	4.0	4.0	4.0	4.0	4.0	4.0	4.0	4.0	4.0	4.0	4.0

Volume Module:	>>	Count	Date:	9 Oct 2014	<<							
Base Vol:	198	1	45	0	0	0	197	375	0	0	704	278
Growth Adj:	1.00	1.00	1.00	1.00	1.00	1.00	1.00	1.00	1.00	1.00	1.00	1.00
Initial Bse:	198	1	45	0	0	0	197	375	0	0	704	278
Added Vol:	0	0	0	0	0	0	0	0	0	0	0	0
PasserByVol:	0	0	0	0	0	0	0	0	0	0	0	0
Initial Fut:	198	1	45	0	0	0	197	375	0	0	704	278
User Adj:	1.00	1.00	1.00	1.00	1.00	1.00	1.00	1.00	1.00	1.00	1.00	1.00
PHF Adj:	1.00	1.00	1.00	1.00	1.00	1.00	1.00	1.00	1.00	1.00	1.00	1.00
PHF Volume:	198	1	45	0	0	0	197	375	0	0	704	278
Reduct Vol:	0	0	0	0	0	0	0	0	0	0	0	0
Reduced Vol:	198	1	45	0	0	0	197	375	0	0	704	278
PCE Adj:	1.00	1.00	1.00	1.00	1.00	1.00	1.00	1.00	1.00	1.00	1.00	1.00
MLF Adj:	1.00	1.00	1.00	1.00	1.00	1.00	1.00	1.00	1.00	1.00	1.00	1.00
Final Volume:	198	1	45	0	0	0	197	375	0	0	704	278

Saturation Flow Module:												
Sat/Lane:	1900	1900	1900	1900	1900	1900	1900	1900	1900	1900	1900	1900
Adjustment:	0.93	0.95	0.92	0.92	1.00	0.92	0.83	1.00	0.92	0.92	1.00	0.92
Lanes:	1.99	0.01	1.00	0.00	0.00	0.00	2.00	2.00	0.00	0.00	2.00	1.00
Final Sat.:	3532	18	1750	0	0	0	3150	3800	0	0	3800	1750

Capacity Analysis Module:												
Vol/Sat:	0.06	0.06	0.03	0.00	0.00	0.00	0.06	0.10	0.00	0.00	0.19	0.16
Crit Moves:	****						****			****		
Green Time:	10.0	10.0	10.0	0.0	0.0	0.0	10.3	41.0	0.0	0.0	30.7	30.7
Volume/Cap:	0.34	0.34	0.15	0.00	0.00	0.00	0.36	0.14	0.00	0.00	0.36	0.31
Delay/Veh:	22.4	22.4	21.6	0.0	0.0	0.0	22.3	3.4	0.0	0.0	8.9	8.7
User DelAdj:	1.00	1.00	1.00	1.00	1.00	1.00	1.00	1.00	1.00	1.00	1.00	1.00
AdjDel/Veh:	22.4	22.4	21.6	0.0	0.0	0.0	22.3	3.4	0.0	0.0	8.9	8.7
LOS by Move:	C	C	C	A	A	A	C	A	A	A	A	A
HCM2k95thQ:	4	4	2	0	0	0	4	2	0	0	8	6

Note: Queue reported is the number of cars per lane.

BART Phase II Extension Project

Level Of Service Computation Report
2000 HCM Operations (Future Volume Alternative)
PM - Existing Conditions

Intersection #3016: 101/ALUM ROCK

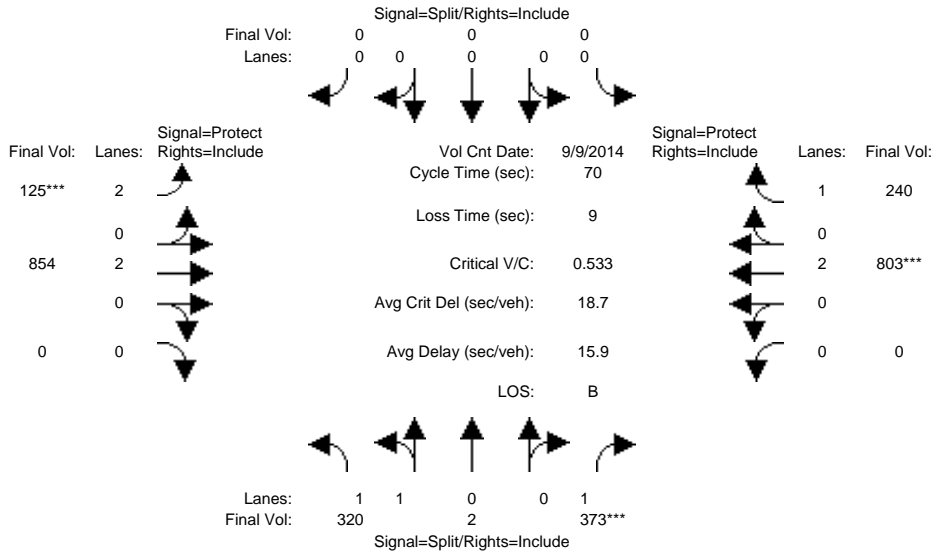

Approach:	North Bound			South Bound			East Bound			West Bound		
	L	T	R	L	T	R	L	T	R	L	T	R
Min. Green:	10	10	10	0	0	0	7	10	0	0	10	10
Y+R:	4.0	4.0	4.0	4.0	4.0	4.0	4.0	4.0	4.0	4.0	4.0	4.0

Volume Module:	>> Count Date: 9 Sep 2014 <<											
Base Vol:	320	2	373	0	0	0	125	854	0	0	803	240
Growth Adj:	1.00	1.00	1.00	1.00	1.00	1.00	1.00	1.00	1.00	1.00	1.00	1.00
Initial Bse:	320	2	373	0	0	0	125	854	0	0	803	240
Added Vol:	0	0	0	0	0	0	0	0	0	0	0	0
PasserByVol:	0	0	0	0	0	0	0	0	0	0	0	0
Initial Fut:	320	2	373	0	0	0	125	854	0	0	803	240
User Adj:	1.00	1.00	1.00	1.00	1.00	1.00	1.00	1.00	1.00	1.00	1.00	1.00
PHF Adj:	1.00	1.00	1.00	1.00	1.00	1.00	1.00	1.00	1.00	1.00	1.00	1.00
PHF Volume:	320	2	373	0	0	0	125	854	0	0	803	240
Reduct Vol:	0	0	0	0	0	0	0	0	0	0	0	0
Reduced Vol:	320	2	373	0	0	0	125	854	0	0	803	240
PCE Adj:	1.00	1.00	1.00	1.00	1.00	1.00	1.00	1.00	1.00	1.00	1.00	1.00
MLF Adj:	1.00	1.00	1.00	1.00	1.00	1.00	1.00	1.00	1.00	1.00	1.00	1.00
FinalVolume:	320	2	373	0	0	0	125	854	0	0	803	240

Saturation Flow Module:												
Sat/Lane:	1900	1900	1900	1900	1900	1900	1900	1900	1900	1900	1900	1900
Adjustment:	0.93	0.95	0.92	0.92	1.00	0.92	0.83	1.00	0.92	0.92	1.00	0.92
Lanes:	1.99	0.01	1.00	0.00	0.00	0.00	2.00	2.00	0.00	0.00	2.00	1.00
Final Sat.:	3528	22	1750	0	0	0	3150	3800	0	0	3800	1750

Capacity Analysis Module:												
Vol/Sat:	0.09	0.09	0.21	0.00	0.00	0.00	0.04	0.22	0.00	0.00	0.21	0.14
Crit Moves:			****				****				****	
Green Time:	27.1	27.1	27.1	0.0	0.0	0.0	7.0	33.9	0.0	0.0	26.9	26.9
Volume/Cap:	0.23	0.23	0.55	0.00	0.00	0.00	0.40	0.46	0.00	0.00	0.55	0.36
Delay/Veh:	14.5	14.5	17.7	0.0	0.0	0.0	30.3	12.2	0.0	0.0	17.3	15.7
User DelAdj:	1.00	1.00	1.00	1.00	1.00	1.00	1.00	1.00	1.00	1.00	1.00	1.00
AdjDel/Veh:	14.5	14.5	17.7	0.0	0.0	0.0	30.3	12.2	0.0	0.0	17.3	15.7
LOS by Move:	B	B	B	A	A	A	C	B	A	A	B	B
HCM2k95thQ:	5	5	14	0	0	0	3	12	0	0	13	8

Note: Queue reported is the number of cars per lane.

BART Phase II Extension Project

Level Of Service Computation Report
 2000 HCM Operations (Future Volume Alternative)
 AM - Existing Conditions

Intersection #3023: 101/SANTA CLARA

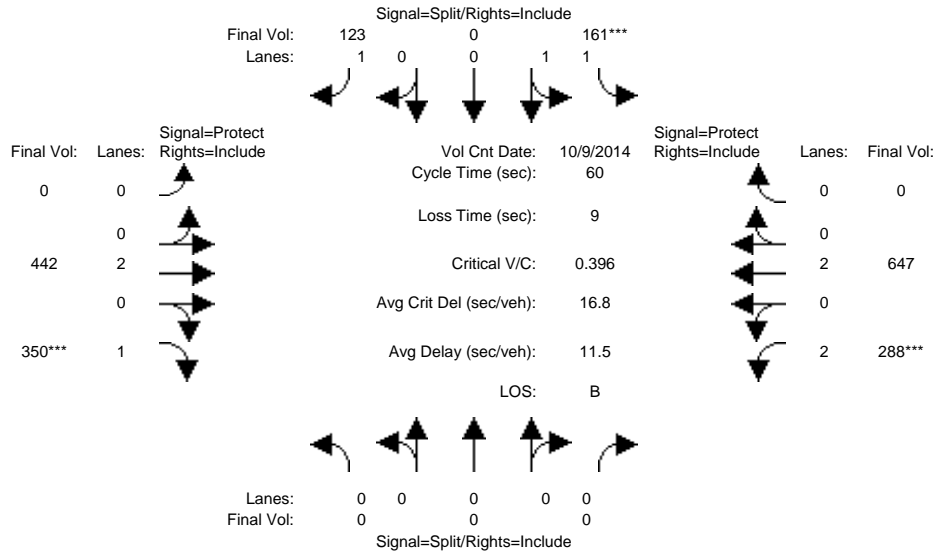

Approach:	North Bound			South Bound			East Bound			West Bound			
	L	T	R	L	T	R	L	T	R	L	T	R	
Min. Green:	0	0	0	10	10	10	0	10	10	7	10	0	
Y+R:	4.0	4.0	4.0	4.0	4.0	4.0	4.0	4.0	4.0	4.0	4.0	4.0	
Volume Module: >> Count Date: 9 Oct 2014 <<													
Base Vol:	0	0	0	161	0	123	0	442	350	288	647	0	
Growth Adj:	1.00	1.00	1.00	1.00	1.00	1.00	1.00	1.00	1.00	1.00	1.00	1.00	
Initial Bse:	0	0	0	161	0	123	0	442	350	288	647	0	
Added Vol:	0	0	0	0	0	0	0	0	0	0	0	0	
PasserByVol:	0	0	0	0	0	0	0	0	0	0	0	0	
Initial Fut:	0	0	0	161	0	123	0	442	350	288	647	0	
User Adj:	1.00	1.00	1.00	1.00	1.00	1.00	1.00	1.00	1.00	1.00	1.00	1.00	
PHF Adj:	1.00	1.00	1.00	1.00	1.00	1.00	1.00	1.00	1.00	1.00	1.00	1.00	
PHF Volume:	0	0	0	161	0	123	0	442	350	288	647	0	
Reduct Vol:	0	0	0	0	0	0	0	0	0	0	0	0	
Reduced Vol:	0	0	0	161	0	123	0	442	350	288	647	0	
PCE Adj:	1.00	1.00	1.00	1.00	1.00	1.00	1.00	1.00	1.00	1.00	1.00	1.00	
MLF Adj:	1.00	1.00	1.00	1.00	1.00	1.00	1.00	1.00	1.00	1.00	1.00	1.00	
Final Volume:	0	0	0	161	0	123	0	442	350	288	647	0	
Saturation Flow Module:													
Sat/Lane:	1900	1900	1900	1900	1900	1900	1900	1900	1900	1900	1900	1900	
Adjustment:	0.92	1.00	0.92	0.93	1.00	0.92	0.92	1.00	0.92	0.83	1.00	0.92	
Lanes:	0.00	0.00	0.00	2.00	0.00	1.00	0.00	2.00	1.00	2.00	2.00	0.00	
Final Sat.:	0	0	0	3550	0	1750	0	3800	1750	3150	3800	0	
Capacity Analysis Module:													
Vol/Sat:	0.00	0.00	0.00	0.05	0.00	0.07	0.00	0.12	0.20	0.09	0.17	0.00	
Crit Moves:				****				****			****		
Green Time:	0.0	0.0	0.0	10.6	0.0	10.6	0.0	27.7	27.7	12.7	40.4	0.0	
Volume/Cap:	0.00	0.00	0.00	0.26	0.00	0.40	0.00	0.25	0.43	0.43	0.25	0.00	
Delay/Veh:	0.0	0.0	0.0	21.5	0.0	22.7	0.0	9.9	11.2	21.0	3.9	0.0	
User DelAdj:	1.00	1.00	1.00	1.00	1.00	1.00	1.00	1.00	1.00	1.00	1.00	1.00	
AdjDel/Veh:	0.0	0.0	0.0	21.5	0.0	22.7	0.0	9.9	11.2	21.0	3.9	0.0	
LOS by Move:	A	A	A	C	A	C	A	A	B	C	A	A	
HCM2k95thQ:	0	0	0	3	0	5	0	5	9	6	5	0	

Note: Queue reported is the number of cars per lane.

BART Phase II Extension Project

Level Of Service Computation Report
2000 HCM Operations (Future Volume Alternative)
PM - Existing Conditions

Intersection #3023: 101/SANTA CLARA

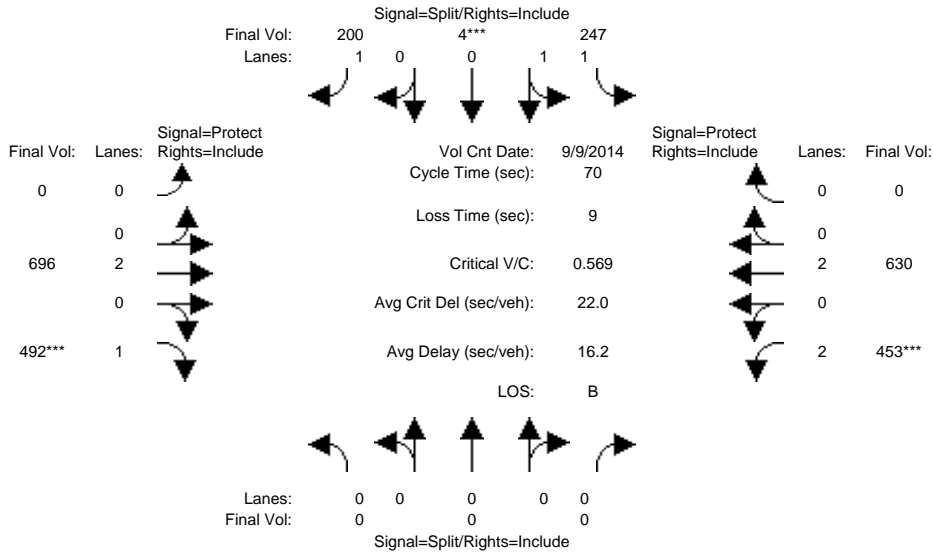

Approach:	North Bound			South Bound			East Bound			West Bound		
	L	T	R	L	T	R	L	T	R	L	T	R
Min. Green:	0	0	0	10	10	10	0	10	10	7	10	0
Y+R:	4.0	4.0	4.0	4.0	4.0	4.0	4.0	4.0	4.0	4.0	4.0	4.0
Volume Module: >> Count Date: 9 Sep 2014 <<												
Base Vol:	0	0	0	247	4	200	0	696	492	453	630	0
Growth Adj:	1.00	1.00	1.00	1.00	1.00	1.00	1.00	1.00	1.00	1.00	1.00	1.00
Initial Bse:	0	0	0	247	4	200	0	696	492	453	630	0
Added Vol:	0	0	0	0	0	0	0	0	0	0	0	0
PasserByVol:	0	0	0	0	0	0	0	0	0	0	0	0
Initial Fut:	0	0	0	247	4	200	0	696	492	453	630	0
User Adj:	1.00	1.00	1.00	1.00	1.00	1.00	1.00	1.00	1.00	1.00	1.00	1.00
PHF Adj:	1.00	1.00	1.00	1.00	1.00	1.00	1.00	1.00	1.00	1.00	1.00	1.00
PHF Volume:	0	0	0	247	4	200	0	696	492	453	630	0
Reduct Vol:	0	0	0	0	0	0	0	0	0	0	0	0
Reduced Vol:	0	0	0	247	4	200	0	696	492	453	630	0
PCE Adj:	1.00	1.00	1.00	1.00	1.00	1.00	1.00	1.00	1.00	1.00	1.00	1.00
MLF Adj:	1.00	1.00	1.00	1.00	1.00	1.00	1.00	1.00	1.00	1.00	1.00	1.00
FinalVolume:	0	0	0	247	4	200	0	696	492	453	630	0
Saturation Flow Module:												
Sat/Lane:	1900	1900	1900	1900	1900	1900	1900	1900	1900	1900	1900	1900
Adjustment:	0.92	1.00	0.92	0.93	0.95	0.92	0.92	1.00	0.92	0.83	1.00	0.92
Lanes:	0.00	0.00	0.00	1.97	0.03	1.00	0.00	2.00	1.00	2.00	2.00	0.00
Final Sat.:	0	0	0	3493	57	1750	0	3800	1750	3150	3800	0
Capacity Analysis Module:												
Vol/Sat:	0.00	0.00	0.00	0.07	0.07	0.11	0.00	0.18	0.28	0.14	0.17	0.00
Crit Moves:				****			****			****		
Green Time:	0.0	0.0	0.0	14.1	14.1	14.1	0.0	31.1	31.1	15.9	46.9	0.0
Volume/Cap:	0.00	0.00	0.00	0.35	0.35	0.57	0.00	0.41	0.63	0.63	0.25	0.00
Delay/Veh:	0.0	0.0	0.0	24.3	24.3	27.4	0.0	13.4	16.8	26.3	4.6	0.0
User DelAdj:	1.00	1.00	1.00	1.00	1.00	1.00	1.00	1.00	1.00	1.00	1.00	1.00
AdjDel/Veh:	0.0	0.0	0.0	24.3	24.3	27.4	0.0	13.4	16.8	26.3	4.6	0.0
LOS by Move:	A	A	A	C	C	C	A	B	B	C	A	A
HCM2k95thQ:	0	0	0	6	6	10	0	10	16	10	5	0

Note: Queue reported is the number of cars per lane.

BART Phase II Extension Project

Level Of Service Computation Report
 2000 HCM Operations (Future Volume Alternative)
 AM - Existing Conditions

Intersection #3036: 280/MCLAUGHLIN

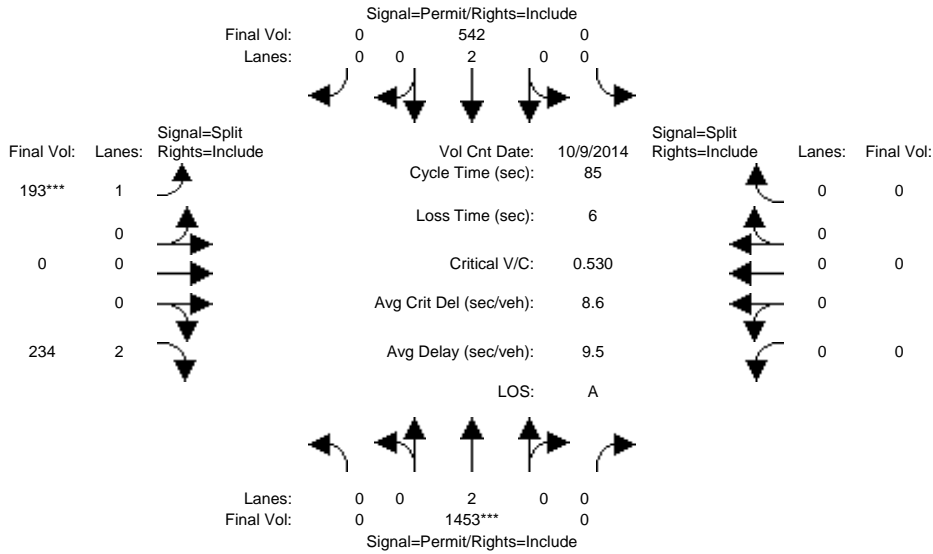

Approach:	North Bound			South Bound			East Bound			West Bound		
	L	T	R	L	T	R	L	T	R	L	T	R
Min. Green:	0	10	0	0	10	0	10	0	10	0	0	0
Y+R:	4.0	4.0	4.0	4.0	4.0	4.0	4.0	4.0	4.0	4.0	4.0	4.0
Volume Module: >> Count Date: 9 Oct 2014 <<												
Base Vol:	0	1453	0	0	542	0	193	0	234	0	0	0
Growth Adj:	1.00	1.00	1.00	1.00	1.00	1.00	1.00	1.00	1.00	1.00	1.00	1.00
Initial Bse:	0	1453	0	0	542	0	193	0	234	0	0	0
Added Vol:	0	0	0	0	0	0	0	0	0	0	0	0
PasserByVol:	0	0	0	0	0	0	0	0	0	0	0	0
Initial Fut:	0	1453	0	0	542	0	193	0	234	0	0	0
User Adj:	1.00	1.00	1.00	1.00	1.00	1.00	1.00	1.00	1.00	1.00	1.00	1.00
PHF Adj:	1.00	1.00	1.00	1.00	1.00	1.00	1.00	1.00	1.00	1.00	1.00	1.00
PHF Volume:	0	1453	0	0	542	0	193	0	234	0	0	0
Reduct Vol:	0	0	0	0	0	0	0	0	0	0	0	0
Reduced Vol:	0	1453	0	0	542	0	193	0	234	0	0	0
PCE Adj:	1.00	1.00	1.00	1.00	1.00	1.00	1.00	1.00	1.00	1.00	1.00	1.00
MLF Adj:	1.00	1.00	1.00	1.00	1.00	1.00	1.00	1.00	1.00	1.00	1.00	1.00
FinalVolume:	0	1453	0	0	542	0	193	0	234	0	0	0
Saturation Flow Module:												
Sat/Lane:	1900	1900	1900	1900	1900	1900	1900	1900	1900	1900	1900	1900
Adjustment:	0.92	1.00	0.92	0.92	1.00	0.92	0.92	1.00	0.83	0.92	1.00	0.92
Lanes:	0.00	2.00	0.00	0.00	2.00	0.00	1.00	0.00	2.00	0.00	0.00	0.00
Final Sat.:	0	3800	0	0	3800	0	1750	0	3150	0	0	0
Capacity Analysis Module:												
Vol/Sat:	0.00	0.38	0.00	0.00	0.14	0.00	0.11	0.00	0.07	0.00	0.00	0.00
Crit Moves:	****			****			****			****		
Green Time:	0.0	61.3	0.0	0.0	61.3	0.0	17.7	0.0	17.7	0.0	0.0	0.0
Volume/Cap:	0.00	0.53	0.00	0.00	0.20	0.00	0.53	0.00	0.36	0.00	0.00	0.00
Delay/Veh:	0.0	5.5	0.0	0.0	3.9	0.0	31.4	0.0	29.1	0.0	0.0	0.0
User DelAdj:	1.00	1.00	1.00	1.00	1.00	1.00	1.00	1.00	1.00	1.00	1.00	1.00
AdjDel/Veh:	0.0	5.5	0.0	0.0	3.9	0.0	31.4	0.0	29.1	0.0	0.0	0.0
LOS by Move:	A	A	A	A	A	A	C	A	C	A	A	A
HCM2k95thQ:	0	16	0	0	5	0	11	0	7	0	0	0

Note: Queue reported is the number of cars per lane.

BART Phase II Extension Project

Level Of Service Computation Report
2000 HCM Operations (Future Volume Alternative)
PM - Existing Conditions

Intersection #3036: 280/MCLAUGHLIN

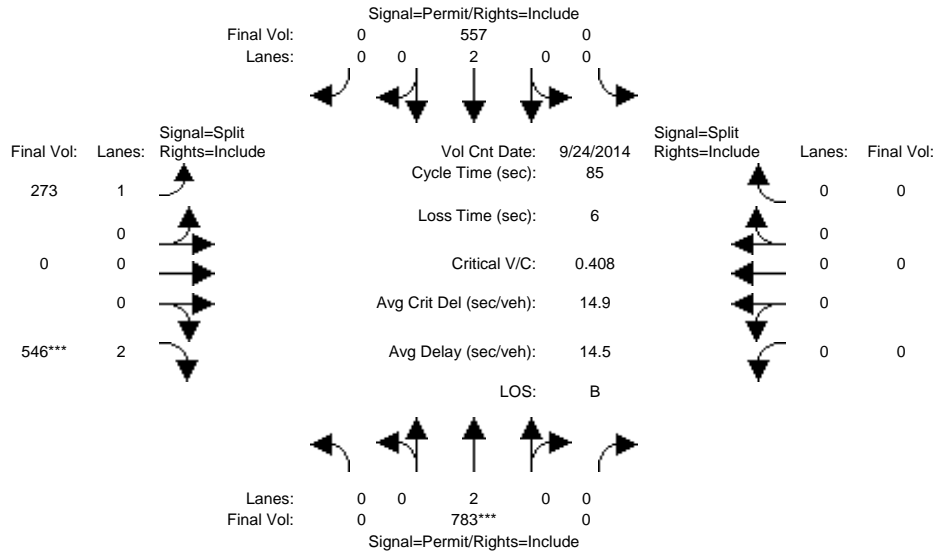

Approach:	North Bound			South Bound			East Bound			West Bound		
Movement:	L	T	R	L	T	R	L	T	R	L	T	R
Min. Green:	0	10	0	0	10	0	10	0	10	0	0	0
Y+R:	4.0	4.0	4.0	4.0	4.0	4.0	4.0	4.0	4.0	4.0	4.0	4.0
Volume Module: >> Count Date: 24 Sep 2014 <<												
Base Vol:	0	783	0	0	557	0	273	0	546	0	0	0
Growth Adj:	1.00	1.00	1.00	1.00	1.00	1.00	1.00	1.00	1.00	1.00	1.00	1.00
Initial Bse:	0	783	0	0	557	0	273	0	546	0	0	0
Added Vol:	0	0	0	0	0	0	0	0	0	0	0	0
PasserByVol:	0	0	0	0	0	0	0	0	0	0	0	0
Initial Fut:	0	783	0	0	557	0	273	0	546	0	0	0
User Adj:	1.00	1.00	1.00	1.00	1.00	1.00	1.00	1.00	1.00	1.00	1.00	1.00
PHF Adj:	1.00	1.00	1.00	1.00	1.00	1.00	1.00	1.00	1.00	1.00	1.00	1.00
PHF Volume:	0	783	0	0	557	0	273	0	546	0	0	0
Reduct Vol:	0	0	0	0	0	0	0	0	0	0	0	0
Reduced Vol:	0	783	0	0	557	0	273	0	546	0	0	0
PCE Adj:	1.00	1.00	1.00	1.00	1.00	1.00	1.00	1.00	1.00	1.00	1.00	1.00
MLF Adj:	1.00	1.00	1.00	1.00	1.00	1.00	1.00	1.00	1.00	1.00	1.00	1.00
FinalVolume:	0	783	0	0	557	0	273	0	546	0	0	0
Saturation Flow Module:												
Sat/Lane:	1900	1900	1900	1900	1900	1900	1900	1900	1900	1900	1900	1900
Adjustment:	0.92	1.00	0.92	0.92	1.00	0.92	0.92	1.00	0.83	0.92	1.00	0.92
Lanes:	0.00	2.00	0.00	0.00	2.00	0.00	1.00	0.00	2.00	0.00	0.00	0.00
Final Sat.:	0	3800	0	0	3800	0	1750	0	3150	0	0	0
Capacity Analysis Module:												
Vol/Sat:	0.00	0.21	0.00	0.00	0.15	0.00	0.16	0.00	0.17	0.00	0.00	0.00
Crit Moves:	****						****					
Green Time:	0.0	42.9	0.0	0.0	42.9	0.0	36.1	0.0	36.1	0.0	0.0	0.0
Volume/Cap:	0.00	0.41	0.00	0.00	0.29	0.00	0.37	0.00	0.41	0.00	0.00	0.00
Delay/Veh:	0.0	13.3	0.0	0.0	12.3	0.0	17.0	0.0	17.2	0.0	0.0	0.0
User DelAdj:	1.00	1.00	1.00	1.00	1.00	1.00	1.00	1.00	1.00	1.00	1.00	1.00
AdjDel/Veh:	0.0	13.3	0.0	0.0	12.3	0.0	17.0	0.0	17.2	0.0	0.0	0.0
LOS by Move:	A	B	A	A	B	A	B	A	B	A	A	A
HCM2k95thQ:	0	12	0	0	8	0	10	0	12	0	0	0

Note: Queue reported is the number of cars per lane.

BART Phase II Extension Project

Level Of Service Computation Report
2000 HCM Operations (Future Volume Alternative)
AM - Existing Conditions

Intersection #3210: 101/JULIAN

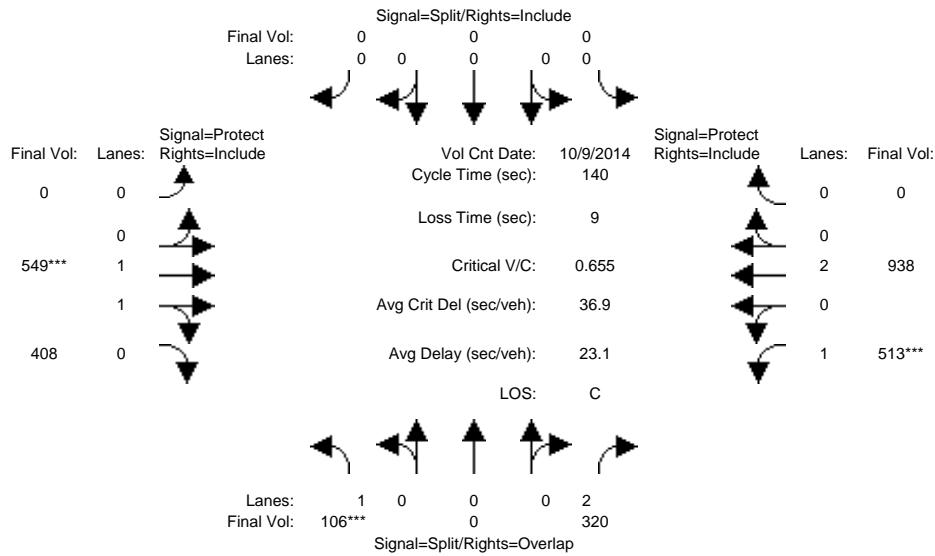

Approach:	North Bound			South Bound			East Bound			West Bound		
	L	T	R	L	T	R	L	T	R	L	T	R
Min. Green:	10	0	10	0	0	0	0	10	10	7	10	0
Y+R:	4.0	4.0	4.0	4.0	4.0	4.0	4.0	4.0	4.0	4.0	4.0	4.0

Volume Module:	>> Count Date: 9 Oct 2014 <<											
Base Vol:	106	0	320	0	0	0	0	549	408	513	938	0
Growth Adj:	1.00	1.00	1.00	1.00	1.00	1.00	1.00	1.00	1.00	1.00	1.00	1.00
Initial Bse:	106	0	320	0	0	0	0	549	408	513	938	0
Added Vol:	0	0	0	0	0	0	0	0	0	0	0	0
PasserByVol:	0	0	0	0	0	0	0	0	0	0	0	0
Initial Fut:	106	0	320	0	0	0	0	549	408	513	938	0
User Adj:	1.00	1.00	1.00	1.00	1.00	1.00	1.00	1.00	1.00	1.00	1.00	1.00
PHF Adj:	1.00	1.00	1.00	1.00	1.00	1.00	1.00	1.00	1.00	1.00	1.00	1.00
PHF Volume:	106	0	320	0	0	0	0	549	408	513	938	0
Reduct Vol:	0	0	0	0	0	0	0	0	0	0	0	0
Reduced Vol:	106	0	320	0	0	0	0	549	408	513	938	0
PCE Adj:	1.00	1.00	1.00	1.00	1.00	1.00	1.00	1.00	1.00	1.00	1.00	1.00
MLF Adj:	1.00	1.00	1.00	1.00	1.00	1.00	1.00	1.00	1.00	1.00	1.00	1.00
FinalVolume:	106	0	320	0	0	0	0	549	408	513	938	0

Saturation Flow Module:												
Sat/Lane:	1900	1900	1900	1900	1900	1900	1900	1900	1900	1900	1900	1900
Adjustment:	0.92	1.00	0.83	0.92	1.00	0.92	0.92	0.99	0.95	0.92	1.00	0.92
Lanes:	1.00	0.00	2.00	0.00	0.00	0.00	0.00	1.12	0.88	1.00	2.00	0.00
Final Sat.:	1750	0	3150	0	0	0	0	2121	1577	1750	3800	0

Capacity Analysis Module:												
Vol/Sat:	0.06	0.00	0.10	0.00	0.00	0.00	0.00	0.26	0.26	0.29	0.25	0.00
Crit Moves:	****							****		****		
Green Time:	13.0	0.0	75.7	0.0	0.0	0.0	0.0	55.3	55.3	62.7	118	0.0
Volume/Cap:	0.65	0.00	0.19	0.00	0.00	0.00	0.00	0.65	0.65	0.65	0.29	0.00
Delay/Veh:	70.7	0.0	16.5	0.0	0.0	0.0	0.0	35.6	35.6	32.2	2.3	0.0
User DelAdj:	1.00	1.00	1.00	1.00	1.00	1.00	1.00	1.00	1.00	1.00	1.00	1.00
AdjDel/Veh:	70.7	0.0	16.5	0.0	0.0	0.0	0.0	35.6	35.6	32.2	2.3	0.0
LOS by Move:	E	A	B	A	A	A	A	D	D	C	A	A
HCM2k95thQ:	11	0	8	0	0	0	0	29	29	32	8	0

Note: Queue reported is the number of cars per lane.

BART Phase II Extension Project

Level Of Service Computation Report
2000 HCM Operations (Future Volume Alternative)
PM - Existing Conditions

Intersection #3210: 101/JULIAN

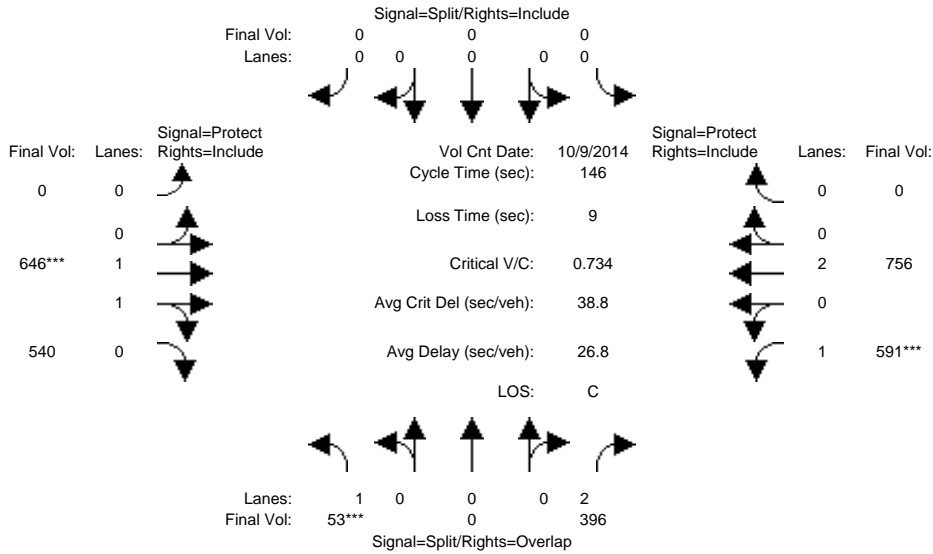

Approach:	North Bound			South Bound			East Bound			West Bound		
	L	T	R	L	T	R	L	T	R	L	T	R
Min. Green:	10	0	10	0	0	0	0	10	10	7	10	0
Y+R:	4.0	4.0	4.0	4.0	4.0	4.0	4.0	4.0	4.0	4.0	4.0	4.0

Volume Module:	>> Count Date: 9 Oct 2014 <<											
Base Vol:	53	0	396	0	0	0	0	646	540	591	756	0
Growth Adj:	1.00	1.00	1.00	1.00	1.00	1.00	1.00	1.00	1.00	1.00	1.00	1.00
Initial Bse:	53	0	396	0	0	0	0	646	540	591	756	0
Added Vol:	0	0	0	0	0	0	0	0	0	0	0	0
PasserByVol:	0	0	0	0	0	0	0	0	0	0	0	0
Initial Fut:	53	0	396	0	0	0	0	646	540	591	756	0
User Adj:	1.00	1.00	1.00	1.00	1.00	1.00	1.00	1.00	1.00	1.00	1.00	1.00
PHF Adj:	1.00	1.00	1.00	1.00	1.00	1.00	1.00	1.00	1.00	1.00	1.00	1.00
PHF Volume:	53	0	396	0	0	0	0	646	540	591	756	0
Reduct Vol:	0	0	0	0	0	0	0	0	0	0	0	0
Reduced Vol:	53	0	396	0	0	0	0	646	540	591	756	0
PCE Adj:	1.00	1.00	1.00	1.00	1.00	1.00	1.00	1.00	1.00	1.00	1.00	1.00
MLF Adj:	1.00	1.00	1.00	1.00	1.00	1.00	1.00	1.00	1.00	1.00	1.00	1.00
FinalVolume:	53	0	396	0	0	0	0	646	540	591	756	0

Saturation Flow Module:												
Sat/Lane:	1900	1900	1900	1900	1900	1900	1900	1900	1900	1900	1900	1900
Adjustment:	0.92	1.00	0.83	0.92	1.00	0.92	0.92	1.00	0.95	0.92	1.00	0.92
Lanes:	1.00	0.00	2.00	0.00	0.00	0.00	0.00	1.06	0.94	1.00	2.00	0.00
Final Sat.:	1750	0	3150	0	0	0	0	2014	1684	1750	3800	0

Capacity Analysis Module:												
Vol/Sat:	0.03	0.00	0.13	0.00	0.00	0.00	0.00	0.32	0.32	0.34	0.20	0.00
Crit Moves:	****							****		****		
Green Time:	10.0	0.0	75.1	0.0	0.0	0.0	0.0	61.9	61.9	65.1	127	0.0
Volume/Cap:	0.44	0.00	0.24	0.00	0.00	0.00	0.00	0.76	0.76	0.76	0.23	0.00
Delay/Veh:	67.9	0.0	19.7	0.0	0.0	0.0	0.0	37.9	37.9	38.1	1.6	0.0
User DelAdj:	1.00	1.00	1.00	1.00	1.00	1.00	1.00	1.00	1.00	1.00	1.00	1.00
AdjDel/Veh:	67.9	0.0	19.7	0.0	0.0	0.0	0.0	37.9	37.9	38.1	1.6	0.0
LOS by Move:	E	A	B	A	A	A	A	D	D	D	A	A
HCM2k95thQ:	6	0	11	0	0	0	0	39	39	41	6	0

Note: Queue reported is the number of cars per lane.

BART Phase II Extension Project

Level Of Service Computation Report
2000 HCM Operations (Future Volume Alternative)
AM - Existing Conditions

Intersection #3211: 101/McKee(E)

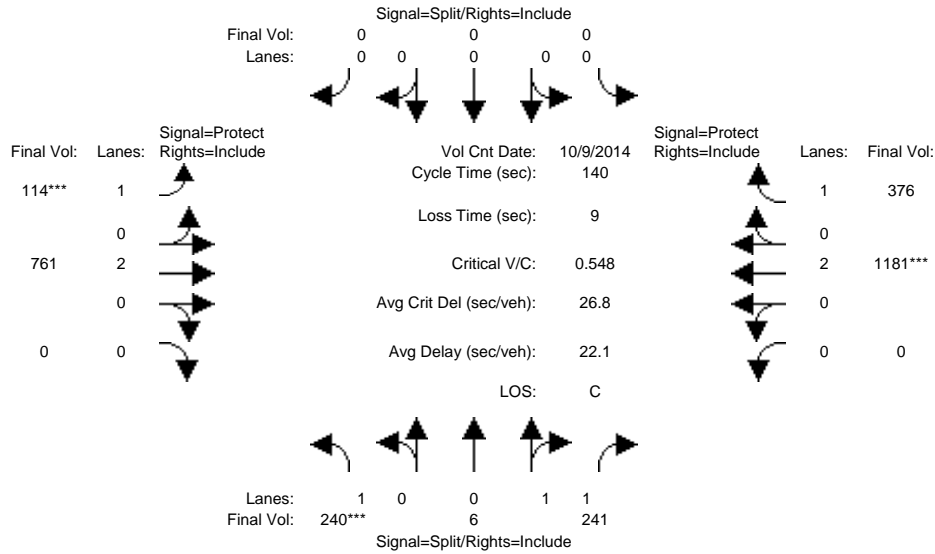

Approach:	North Bound			South Bound			East Bound			West Bound		
	L	T	R	L	T	R	L	T	R	L	T	R
Min. Green:	10	10	10	0	0	0	7	10	0	0	10	10
Y+R:	4.0	4.0	4.0	4.0	4.0	4.0	4.0	4.0	4.0	4.0	4.0	4.0
Volume Module: >> Count Date: 9 Oct 2014 <<												
Base Vol:	240	6	241	0	0	0	114	761	0	0	1181	376
Growth Adj:	1.00	1.00	1.00	1.00	1.00	1.00	1.00	1.00	1.00	1.00	1.00	1.00
Initial Bse:	240	6	241	0	0	0	114	761	0	0	1181	376
Added Vol:	0	0	0	0	0	0	0	0	0	0	0	0
PasserByVol:	0	0	0	0	0	0	0	0	0	0	0	0
Initial Fut:	240	6	241	0	0	0	114	761	0	0	1181	376
User Adj:	1.00	1.00	1.00	1.00	1.00	1.00	1.00	1.00	1.00	1.00	1.00	1.00
PHF Adj:	1.00	1.00	1.00	1.00	1.00	1.00	1.00	1.00	1.00	1.00	1.00	1.00
PHF Volume:	240	6	241	0	0	0	114	761	0	0	1181	376
Reduct Vol:	0	0	0	0	0	0	0	0	0	0	0	0
Reduced Vol:	240	6	241	0	0	0	114	761	0	0	1181	376
PCE Adj:	1.00	1.00	1.00	1.00	1.00	1.00	1.00	1.00	1.00	1.00	1.00	1.00
MLF Adj:	1.00	1.00	1.00	1.00	1.00	1.00	1.00	1.00	1.00	1.00	1.00	1.00
FinalVolume:	240	6	241	0	0	0	114	761	0	0	1181	376
Saturation Flow Module:												
Sat/Lane:	1900	1900	1900	1900	1900	1900	1900	1900	1900	1900	1900	1900
Adjustment:	0.92	0.95	0.95	0.92	1.00	0.92	0.92	1.00	0.92	0.92	1.00	0.92
Lanes:	1.00	0.05	1.95	0.00	0.00	0.00	1.00	2.00	0.00	0.00	2.00	1.00
Final Sat.:	1750	87	3513	0	0	0	1750	3800	0	0	3800	1750
Capacity Analysis Module:												
Vol/Sat:	0.14	0.07	0.07	0.00	0.00	0.00	0.07	0.20	0.00	0.00	0.31	0.21
Crit Moves:	****						****				****	
Green Time:	35.0	35.0	35.0	0.0	0.0	0.0	16.6	96.0	0.0	0.0	79.4	79.4
Volume/Cap:	0.55	0.27	0.27	0.00	0.00	0.00	0.55	0.29	0.00	0.00	0.55	0.38
Delay/Veh:	47.1	42.4	42.4	0.0	0.0	0.0	61.2	8.7	0.0	0.0	19.4	17.0
User DelAdj:	1.00	1.00	1.00	1.00	1.00	1.00	1.00	1.00	1.00	1.00	1.00	1.00
AdjDel/Veh:	47.1	42.4	42.4	0.0	0.0	0.0	61.2	8.7	0.0	0.0	19.4	17.0
LOS by Move:	D	D	D	A	A	A	E	A	A	A	B	B
HCM2k95thQ:	18	9	9	0	0	0	11	12	0	0	27	17

Note: Queue reported is the number of cars per lane.

BART Phase II Extension Project

Level Of Service Computation Report
2000 HCM Operations (Future Volume Alternative)
PM - Existing Conditions

Intersection #3211: 101/McKee(E)

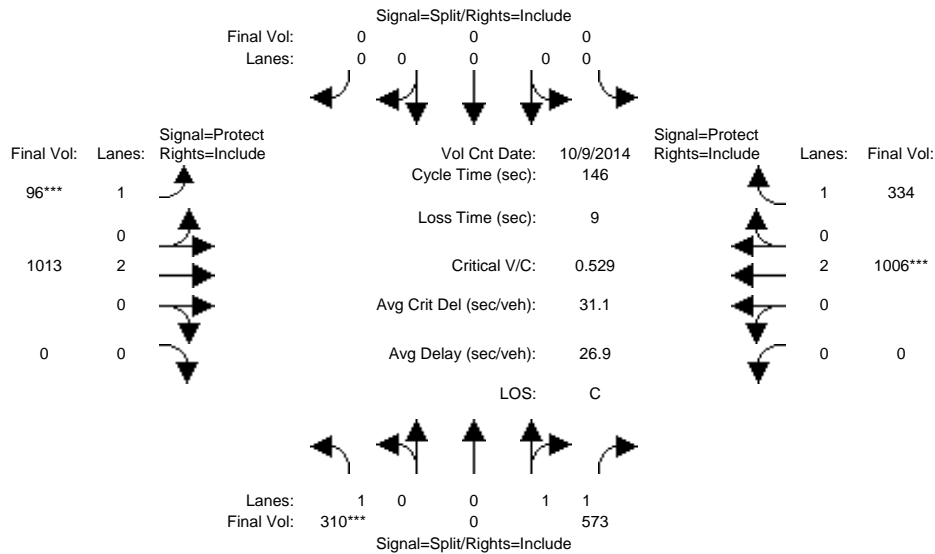

Approach:	North Bound			South Bound			East Bound			West Bound		
	L	T	R	L	T	R	L	T	R	L	T	R
Min. Green:	10	10	10	0	0	0	7	10	0	0	10	10
Y+R:	4.0	4.0	4.0	4.0	4.0	4.0	4.0	4.0	4.0	4.0	4.0	4.0
Volume Module: >> Count Date: 9 Oct 2014 <<												
Base Vol:	310	0	573	0	0	0	96	1013	0	0	1006	334
Growth Adj:	1.00	1.00	1.00	1.00	1.00	1.00	1.00	1.00	1.00	1.00	1.00	1.00
Initial Bse:	310	0	573	0	0	0	96	1013	0	0	1006	334
Added Vol:	0	0	0	0	0	0	0	0	0	0	0	0
PasserByVol:	0	0	0	0	0	0	0	0	0	0	0	0
Initial Fut:	310	0	573	0	0	0	96	1013	0	0	1006	334
User Adj:	1.00	1.00	1.00	1.00	1.00	1.00	1.00	1.00	1.00	1.00	1.00	1.00
PHF Adj:	1.00	1.00	1.00	1.00	1.00	1.00	1.00	1.00	1.00	1.00	1.00	1.00
PHF Volume:	310	0	573	0	0	0	96	1013	0	0	1006	334
Reduct Vol:	0	0	0	0	0	0	0	0	0	0	0	0
Reduced Vol:	310	0	573	0	0	0	96	1013	0	0	1006	334
PCE Adj:	1.00	1.00	1.00	1.00	1.00	1.00	1.00	1.00	1.00	1.00	1.00	1.00
MLF Adj:	1.00	1.00	1.00	1.00	1.00	1.00	1.00	1.00	1.00	1.00	1.00	1.00
FinalVolume:	310	0	573	0	0	0	96	1013	0	0	1006	334
Saturation Flow Module:												
Sat/Lane:	1900	1900	1900	1900	1900	1900	1900	1900	1900	1900	1900	1900
Adjustment:	0.92	1.00	0.95	0.92	1.00	0.92	0.92	1.00	0.92	0.92	1.00	0.92
Lanes:	1.00	0.00	2.00	0.00	0.00	0.00	1.00	2.00	0.00	0.00	2.00	1.00
Final Sat.:	1750	0	3600	0	0	0	1750	3800	0	0	3800	1750
Capacity Analysis Module:												
Vol/Sat:	0.18	0.00	0.16	0.00	0.00	0.00	0.05	0.27	0.00	0.00	0.26	0.19
Crit Moves:	****						****				****	
Green Time:	48.9	0.0	48.9	0.0	0.0	0.0	15.1	88.1	0.0	0.0	73.0	73.0
Volume/Cap:	0.53	0.00	0.48	0.00	0.00	0.00	0.53	0.44	0.00	0.00	0.53	0.38
Delay/Veh:	40.2	0.0	38.7	0.0	0.0	0.0	65.0	15.8	0.0	0.0	25.1	22.8
User DelAdj:	1.00	1.00	1.00	1.00	1.00	1.00	1.00	1.00	1.00	1.00	1.00	1.00
AdjDel/Veh:	40.2	0.0	38.7	0.0	0.0	0.0	65.0	15.8	0.0	0.0	25.1	22.8
LOS by Move:	D	A	D	A	A	A	E	B	A	A	C	C
HCM2k95thQ:	22	0	19	0	0	0	10	22	0	0	26	18

Note: Queue reported is the number of cars per lane.

BART Phase II Extension Project

Level Of Service Computation Report
2000 HCM Operations (Future Volume Alternative)
AM - Existing Conditions

Intersection #3612: JULIAN/21ST

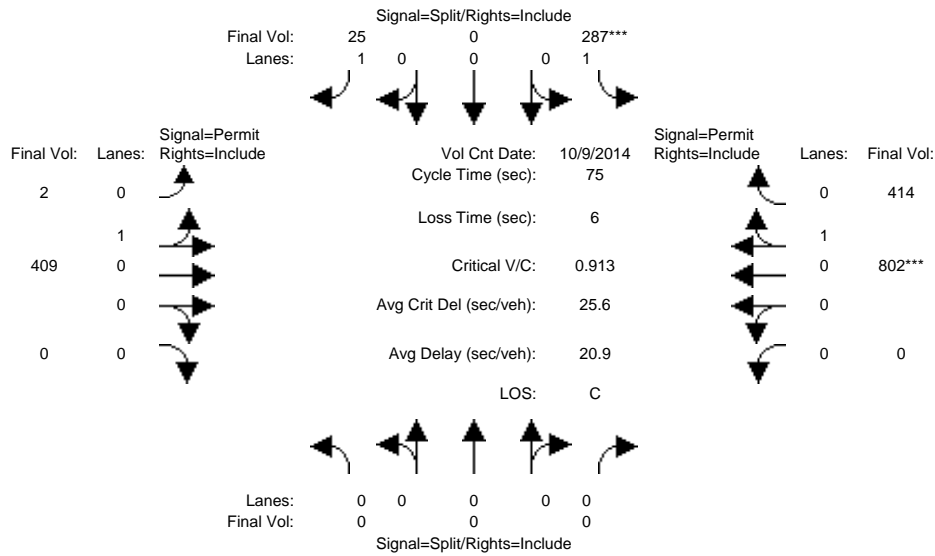

Approach:	North Bound			South Bound			East Bound			West Bound			
	L	T	R	L	T	R	L	T	R	L	T	R	
Min. Green:	0	0	0	10	0	10	10	10	0	0	10	10	
Y+R:	4.0	4.0	4.0	4.0	4.0	4.0	4.0	4.0	4.0	4.0	4.0	4.0	
Volume Module: >> Count Date: 9 Oct 2014 <<													
Base Vol:	0	0	0	287	0	25	2	409	0	0	802	414	
Growth Adj:	1.00	1.00	1.00	1.00	1.00	1.00	1.00	1.00	1.00	1.00	1.00	1.00	
Initial Bse:	0	0	0	287	0	25	2	409	0	0	802	414	
Added Vol:	0	0	0	0	0	0	0	0	0	0	0	0	
PasserByVol:	0	0	0	0	0	0	0	0	0	0	0	0	
Initial Fut:	0	0	0	287	0	25	2	409	0	0	802	414	
User Adj:	1.00	1.00	1.00	1.00	1.00	1.00	1.00	1.00	1.00	1.00	1.00	1.00	
PHF Adj:	1.00	1.00	1.00	1.00	1.00	1.00	1.00	1.00	1.00	1.00	1.00	1.00	
PHF Volume:	0	0	0	287	0	25	2	409	0	0	802	414	
Reduct Vol:	0	0	0	0	0	0	0	0	0	0	0	0	
Reduced Vol:	0	0	0	287	0	25	2	409	0	0	802	414	
PCE Adj:	1.00	1.00	1.00	1.00	1.00	1.00	1.00	1.00	1.00	1.00	1.00	1.00	
MLF Adj:	1.00	1.00	1.00	1.00	1.00	1.00	1.00	1.00	1.00	1.00	1.00	1.00	
FinalVolume:	0	0	0	287	0	25	2	409	0	0	802	414	
Saturation Flow Module:													
Sat/Lane:	1900	1900	1900	1900	1900	1900	1900	1900	1900	1900	1900	1900	
Adjustment:	0.92	1.00	0.92	0.92	1.00	0.92	0.95	0.95	0.92	0.92	0.95	0.95	
Lanes:	0.00	0.00	0.00	1.00	0.00	1.00	0.01	0.99	0.00	0.00	0.66	0.34	
Final Sat.:	0	0	0	1750	0	1750	9	1791	0	0	1187	613	
Capacity Analysis Module:													
Vol/Sat:	0.00	0.00	0.00	0.16	0.00	0.01	0.23	0.23	0.00	0.00	0.68	0.68	
Crit Moves:				****							****		
Green Time:	0.0	0.0	0.0	13.5	0.0	13.5	55.5	55.5	0.0	0.0	55.5	55.5	
Volume/Cap:	0.00	0.00	0.00	0.91	0.00	0.08	0.31	0.31	0.00	0.00	0.91	0.91	
Delay/Veh:	0.0	0.0	0.0	59.6	0.0	25.7	3.4	3.4	0.0	0.0	17.5	17.5	
User DelAdj:	1.00	1.00	1.00	1.00	1.00	1.00	1.00	1.00	1.00	1.00	1.00	1.00	
AdjDel/Veh:	0.0	0.0	0.0	59.6	0.0	25.7	3.4	3.4	0.0	0.0	17.5	17.5	
LOS by Move:	A	A	A	E	A	C	A	A	A	A	B	B	
HCM2k95thQ:	0	0	0	20	0	1	7	7	0	0	44	44	

Note: Queue reported is the number of cars per lane.

BART Phase II Extension Project

Level Of Service Computation Report
2000 HCM Operations (Future Volume Alternative)
PM - Existing Conditions

Intersection #3612: JULIAN/21ST

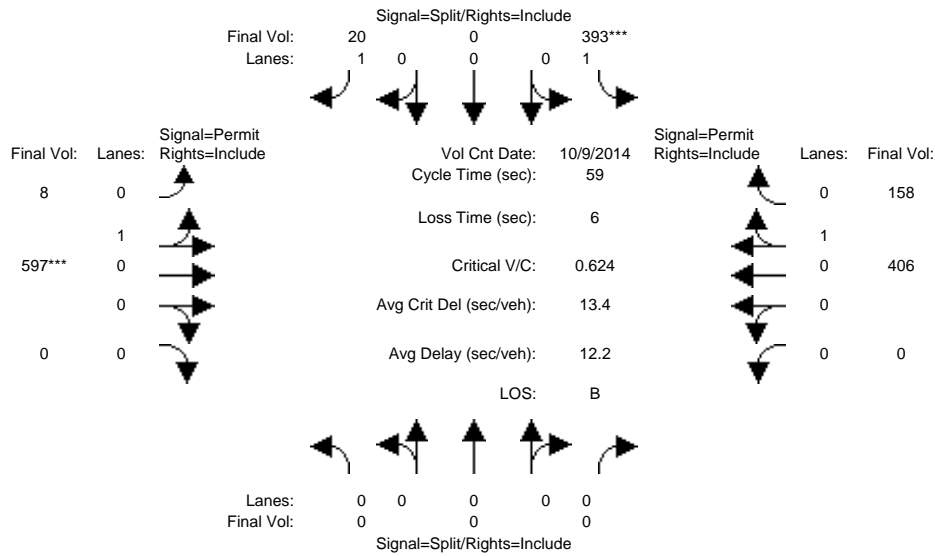

Approach:	North Bound			South Bound			East Bound			West Bound		
	L	T	R	L	T	R	L	T	R	L	T	R
Min. Green:	0	0	0	10	0	10	10	10	0	0	10	10
Y+R:	4.0	4.0	4.0	4.0	4.0	4.0	4.0	4.0	4.0	4.0	4.0	4.0

Volume Module:	>> Count Date: 9 Oct 2014 <<											
Base Vol:	0	0	0	393	0	20	8	597	0	0	406	158
Growth Adj:	1.00	1.00	1.00	1.00	1.00	1.00	1.00	1.00	1.00	1.00	1.00	1.00
Initial Bse:	0	0	0	393	0	20	8	597	0	0	406	158
Added Vol:	0	0	0	0	0	0	0	0	0	0	0	0
PasserByVol:	0	0	0	0	0	0	0	0	0	0	0	0
Initial Fut:	0	0	0	393	0	20	8	597	0	0	406	158
User Adj:	1.00	1.00	1.00	1.00	1.00	1.00	1.00	1.00	1.00	1.00	1.00	1.00
PHF Adj:	1.00	1.00	1.00	1.00	1.00	1.00	1.00	1.00	1.00	1.00	1.00	1.00
PHF Volume:	0	0	0	393	0	20	8	597	0	0	406	158
Reduct Vol:	0	0	0	0	0	0	0	0	0	0	0	0
Reduced Vol:	0	0	0	393	0	20	8	597	0	0	406	158
PCE Adj:	1.00	1.00	1.00	1.00	1.00	1.00	1.00	1.00	1.00	1.00	1.00	1.00
MLF Adj:	1.00	1.00	1.00	1.00	1.00	1.00	1.00	1.00	1.00	1.00	1.00	1.00
FinalVolume:	0	0	0	393	0	20	8	597	0	0	406	158

Saturation Flow Module:												
Sat/Lane:	1900	1900	1900	1900	1900	1900	1900	1900	1900	1900	1900	1900
Adjustment:	0.92	1.00	0.92	0.92	1.00	0.92	0.95	0.95	0.92	0.92	0.95	0.95
Lanes:	0.00	0.00	0.00	1.00	0.00	1.00	0.01	0.99	0.00	0.00	0.72	0.28
Final Sat.:	0	0	0	1750	0	1750	24	1776	0	0	1296	504

Capacity Analysis Module:												
Vol/Sat:	0.00	0.00	0.00	0.22	0.00	0.01	0.34	0.34	0.00	0.00	0.31	0.31
Crit Moves:				****				****				
Green Time:	0.0	0.0	0.0	21.2	0.0	21.2	31.8	31.8	0.0	0.0	31.8	31.8
Volume/Cap:	0.00	0.00	0.00	0.62	0.00	0.03	0.62	0.62	0.00	0.00	0.58	0.58
Delay/Veh:	0.0	0.0	0.0	17.6	0.0	12.3	10.7	10.7	0.0	0.0	10.1	10.1
User DelAdj:	1.00	1.00	1.00	1.00	1.00	1.00	1.00	1.00	1.00	1.00	1.00	1.00
AdjDel/Veh:	0.0	0.0	0.0	17.6	0.0	12.3	10.7	10.7	0.0	0.0	10.1	10.1
LOS by Move:	A	A	A	B	A	B	B	B	A	A	B	B
HCM2k95thQ:	0	0	0	14	0	1	15	15	0	0	14	14

Note: Queue reported is the number of cars per lane.

BART Phase II Extension Project

Level Of Service Computation Report
2000 HCM Operations (Future Volume Alternative)
AM - Existing Conditions

Intersection #3613: JULIAN/24TH

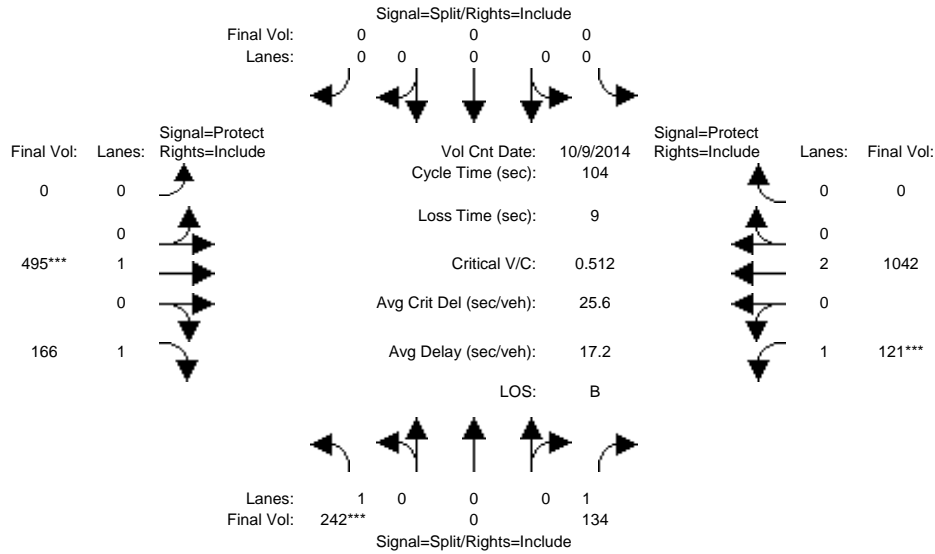

Approach:	North Bound			South Bound			East Bound			West Bound		
	L	T	R	L	T	R	L	T	R	L	T	R
Min. Green:	10	0	10	0	0	0	0	10	10	7	10	0
Y+R:	4.0	4.0	4.0	4.0	4.0	4.0	4.0	4.0	4.0	4.0	4.0	4.0

Volume Module:	>> Count Date: 9 Oct 2014 <<											
Base Vol:	242	0	134	0	0	0	0	495	166	121	1042	0
Growth Adj:	1.00	1.00	1.00	1.00	1.00	1.00	1.00	1.00	1.00	1.00	1.00	1.00
Initial Bse:	242	0	134	0	0	0	0	495	166	121	1042	0
Added Vol:	0	0	0	0	0	0	0	0	0	0	0	0
PasserByVol:	0	0	0	0	0	0	0	0	0	0	0	0
Initial Fut:	242	0	134	0	0	0	0	495	166	121	1042	0
User Adj:	1.00	1.00	1.00	1.00	1.00	1.00	1.00	1.00	1.00	1.00	1.00	1.00
PHF Adj:	1.00	1.00	1.00	1.00	1.00	1.00	1.00	1.00	1.00	1.00	1.00	1.00
PHF Volume:	242	0	134	0	0	0	0	495	166	121	1042	0
Reduct Vol:	0	0	0	0	0	0	0	0	0	0	0	0
Reduced Vol:	242	0	134	0	0	0	0	495	166	121	1042	0
PCE Adj:	1.00	1.00	1.00	1.00	1.00	1.00	1.00	1.00	1.00	1.00	1.00	1.00
MLF Adj:	1.00	1.00	1.00	1.00	1.00	1.00	1.00	1.00	1.00	1.00	1.00	1.00
FinalVolume:	242	0	134	0	0	0	0	495	166	121	1042	0

Saturation Flow Module:												
Sat/Lane:	1900	1900	1900	1900	1900	1900	1900	1900	1900	1900	1900	1900
Adjustment:	0.92	1.00	0.92	0.92	1.00	0.92	0.92	1.00	0.92	0.92	1.00	0.92
Lanes:	1.00	0.00	1.00	0.00	0.00	0.00	0.00	1.00	1.00	1.00	2.00	0.00
Final Sat.:	1750	0	1750	0	0	0	0	1900	1750	1750	3800	0

Capacity Analysis Module:												
Vol/Sat:	0.14	0.00	0.08	0.00	0.00	0.00	0.00	0.26	0.09	0.07	0.27	0.00
Crit Moves:	****							****		****		
Green Time:	28.1	0.0	28.1	0.0	0.0	0.0	0.0	52.9	52.9	14.0	66.9	0.0
Volume/Cap:	0.51	0.00	0.28	0.00	0.00	0.00	0.00	0.51	0.19	0.51	0.43	0.00
Delay/Veh:	33.1	0.0	30.3	0.0	0.0	0.0	0.0	17.5	14.0	43.7	9.2	0.0
User DelAdj:	1.00	1.00	1.00	1.00	1.00	1.00	1.00	1.00	1.00	1.00	1.00	1.00
AdjDel/Veh:	33.1	0.0	30.3	0.0	0.0	0.0	0.0	17.5	14.0	43.7	9.2	0.0
LOS by Move:	C	A	C	A	A	A	A	B	B	D	A	A
HCM2k95thQ:	14	0	7	0	0	0	0	19	6	9	15	0

Note: Queue reported is the number of cars per lane.

BART Phase II Extension Project

Level Of Service Computation Report
2000 HCM Operations (Future Volume Alternative)
PM - Existing Conditions

Intersection #3613: JULIAN/24TH

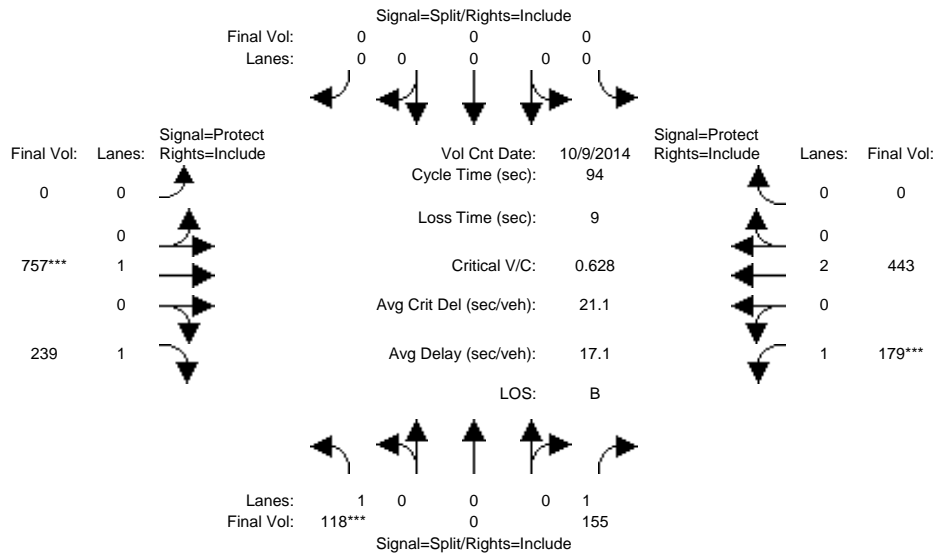

Approach:	North Bound			South Bound			East Bound			West Bound		
	L	T	R	L	T	R	L	T	R	L	T	R
Min. Green:	10	0	10	0	0	0	0	10	10	7	10	0
Y+R:	4.0	4.0	4.0	4.0	4.0	4.0	4.0	4.0	4.0	4.0	4.0	4.0

Volume Module:	>> Count Date: 9 Oct 2014 <<											
Base Vol:	118	0	155	0	0	0	0	757	239	179	443	0
Growth Adj:	1.00	1.00	1.00	1.00	1.00	1.00	1.00	1.00	1.00	1.00	1.00	1.00
Initial Bse:	118	0	155	0	0	0	0	757	239	179	443	0
Added Vol:	0	0	0	0	0	0	0	0	0	0	0	0
PasserByVol:	0	0	0	0	0	0	0	0	0	0	0	0
Initial Fut:	118	0	155	0	0	0	0	757	239	179	443	0
User Adj:	1.00	1.00	1.00	1.00	1.00	1.00	1.00	1.00	1.00	1.00	1.00	1.00
PHF Adj:	1.00	1.00	1.00	1.00	1.00	1.00	1.00	1.00	1.00	1.00	1.00	1.00
PHF Volume:	118	0	155	0	0	0	0	757	239	179	443	0
Reduct Vol:	0	0	0	0	0	0	0	0	0	0	0	0
Reduced Vol:	118	0	155	0	0	0	0	757	239	179	443	0
PCE Adj:	1.00	1.00	1.00	1.00	1.00	1.00	1.00	1.00	1.00	1.00	1.00	1.00
MLF Adj:	1.00	1.00	1.00	1.00	1.00	1.00	1.00	1.00	1.00	1.00	1.00	1.00
FinalVolume:	118	0	155	0	0	0	0	757	239	179	443	0

Saturation Flow Module:												
Sat/Lane:	1900	1900	1900	1900	1900	1900	1900	1900	1900	1900	1900	1900
Adjustment:	0.92	1.00	0.92	0.92	1.00	0.92	0.92	1.00	0.92	0.92	1.00	0.92
Lanes:	1.00	0.00	1.00	0.00	0.00	0.00	0.00	1.00	1.00	1.00	2.00	0.00
Final Sat.:	1750	0	1750	0	0	0	0	1900	1750	1750	3800	0

Capacity Analysis Module:												
Vol/Sat:	0.07	0.00	0.09	0.00	0.00	0.00	0.00	0.40	0.14	0.10	0.12	0.00
Crit Moves:	****							****		****		
Green Time:	12.8	0.0	12.8	0.0	0.0	0.0	0.0	57.5	57.5	14.8	72.2	0.0
Volume/Cap:	0.50	0.00	0.65	0.00	0.00	0.00	0.00	0.65	0.22	0.65	0.15	0.00
Delay/Veh:	39.3	0.0	44.8	0.0	0.0	0.0	0.0	13.1	8.3	42.7	2.9	0.0
User DelAdj:	1.00	1.00	1.00	1.00	1.00	1.00	1.00	1.00	1.00	1.00	1.00	1.00
AdjDel/Veh:	39.3	0.0	44.8	0.0	0.0	0.0	0.0	13.1	8.3	42.7	2.9	0.0
LOS by Move:	D	A	D	A	A	A	A	B	A	D	A	A
HCM2k95thQ:	8	0	11	0	0	0	0	25	6	12	3	0

Note: Queue reported is the number of cars per lane.

BART Phase II Extension Project

Level Of Service Computation Report
2000 HCM Operations (Future Volume Alternative)
AM - Existing Conditions

Intersection #3625: KING/McKEE

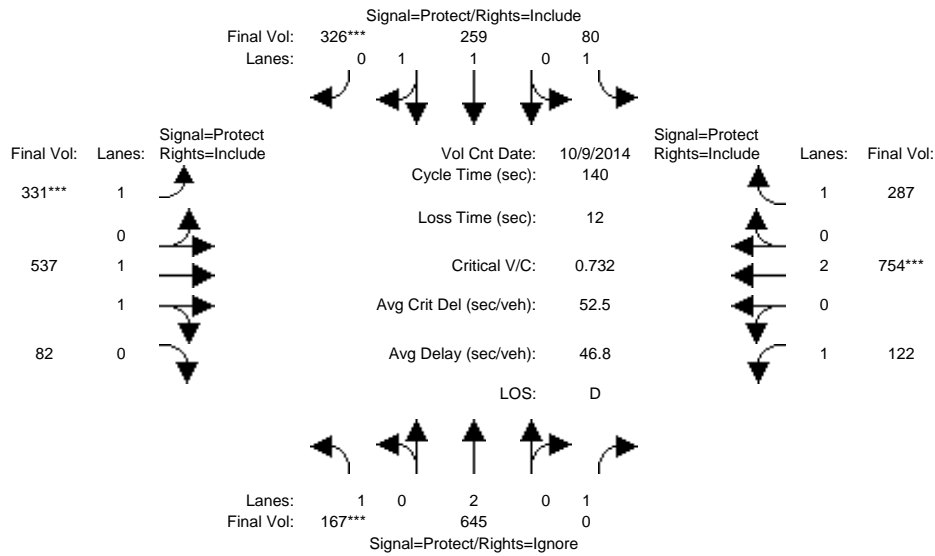

Approach:	North Bound			South Bound			East Bound			West Bound		
	L	T	R	L	T	R	L	T	R	L	T	R
Min. Green:	7	10	10	7	10	10	7	10	10	7	10	10
Y+R:	4.0	4.0	4.0	4.0	4.0	4.0	4.0	4.0	4.0	4.0	4.0	4.0

Volume Module:	>>	Count	Date:	9 Oct 2014	<<							
Base Vol:	167	645	162	80	259	326	331	537	82	122	754	287
Growth Adj:	1.00	1.00	1.00	1.00	1.00	1.00	1.00	1.00	1.00	1.00	1.00	1.00
Initial Bse:	167	645	162	80	259	326	331	537	82	122	754	287
Added Vol:	0	0	0	0	0	0	0	0	0	0	0	0
PasserByVol:	0	0	0	0	0	0	0	0	0	0	0	0
Initial Fut:	167	645	162	80	259	326	331	537	82	122	754	287
User Adj:	1.00	1.00	0.00	1.00	1.00	1.00	1.00	1.00	1.00	1.00	1.00	1.00
PHF Adj:	1.00	1.00	0.00	1.00	1.00	1.00	1.00	1.00	1.00	1.00	1.00	1.00
PHF Volume:	167	645	0	80	259	326	331	537	82	122	754	287
Reduct Vol:	0	0	0	0	0	0	0	0	0	0	0	0
Reduced Vol:	167	645	0	80	259	326	331	537	82	122	754	287
PCE Adj:	1.00	1.00	0.00	1.00	1.00	1.00	1.00	1.00	1.00	1.00	1.00	1.00
MLF Adj:	1.00	1.00	0.00	1.00	1.00	1.00	1.00	1.00	1.00	1.00	1.00	1.00
FinalVolume:	167	645	0	80	259	326	331	537	82	122	754	287

Saturation Flow Module:	North Bound			South Bound			East Bound			West Bound		
Sat/Lane:	1900	1900	1900	1900	1900	1900	1900	1900	1900	1900	1900	1900
Adjustment:	0.92	1.00	0.92	0.92	1.00	0.92	0.92	0.98	0.95	0.92	1.00	0.92
Lanes:	1.00	2.00	1.00	1.00	1.00	1.00	1.00	1.73	0.27	1.00	2.00	1.00
Final Sat.:	1750	3800	1750	1750	1900	1750	1750	3209	490	1750	3800	1750

Capacity Analysis Module:	North Bound			South Bound			East Bound			West Bound		
Vol/Sat:	0.10	0.17	0.00	0.05	0.14	0.19	0.19	0.17	0.17	0.07	0.20	0.16
Crit Moves:	****					****	****				****	
Green Time:	18.3	41.6	0.0	12.3	35.6	35.6	36.2	52.3	52.3	21.8	37.9	37.9
Volume/Cap:	0.73	0.57	0.00	0.52	0.54	0.73	0.73	0.45	0.45	0.45	0.73	0.61
Delay/Veh:	70.0	42.3	0.0	64.3	45.6	51.3	53.5	33.2	33.2	54.8	49.1	46.7
User DelAdj:	1.00	1.00	1.00	1.00	1.00	1.00	1.00	1.00	1.00	1.00	1.00	1.00
AdjDel/Veh:	70.0	42.3	0.0	64.3	45.6	51.3	53.5	33.2	33.2	54.8	49.1	46.7
LOS by Move:	E	D	A	E	D	D	D	C	C	D	D	D
HCM2k95thQ:	15	21	0	7	17	25	25	18	18	10	26	21

Note: Queue reported is the number of cars per lane.

BART Phase II Extension Project

Level Of Service Computation Report
2000 HCM Operations (Future Volume Alternative)
PM - Existing Conditions

Intersection #3625: KING/McKEE

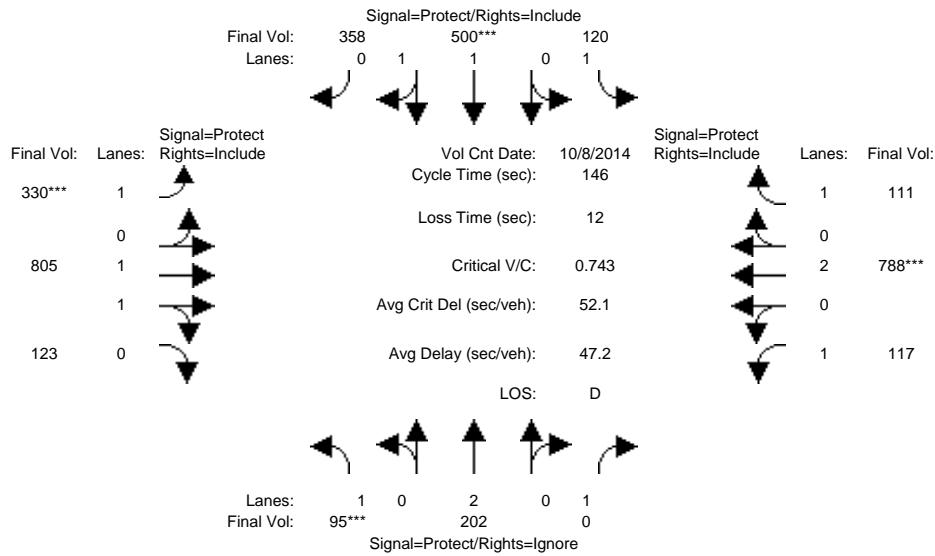

Approach:	North Bound			South Bound			East Bound			West Bound		
	L	T	R	L	T	R	L	T	R	L	T	R
Min. Green:	7	10	10	7	10	10	7	10	10	7	10	10
Y+R:	4.0	4.0	4.0	4.0	4.0	4.0	4.0	4.0	4.0	4.0	4.0	4.0

Volume Module:	>> Count Date: 8 Oct 2014 <<											
Base Vol:	95	202	98	120	500	358	330	805	123	117	788	111
Growth Adj:	1.00	1.00	1.00	1.00	1.00	1.00	1.00	1.00	1.00	1.00	1.00	1.00
Initial Bse:	95	202	98	120	500	358	330	805	123	117	788	111
Added Vol:	0	0	0	0	0	0	0	0	0	0	0	0
PasserByVol:	0	0	0	0	0	0	0	0	0	0	0	0
Initial Fut:	95	202	98	120	500	358	330	805	123	117	788	111
User Adj:	1.00	1.00	0.00	1.00	1.00	1.00	1.00	1.00	1.00	1.00	1.00	1.00
PHF Adj:	1.00	1.00	0.00	1.00	1.00	1.00	1.00	1.00	1.00	1.00	1.00	1.00
PHF Volume:	95	202	0	120	500	358	330	805	123	117	788	111
Reduct Vol:	0	0	0	0	0	0	0	0	0	0	0	0
Reduced Vol:	95	202	0	120	500	358	330	805	123	117	788	111
PCE Adj:	1.00	1.00	0.00	1.00	1.00	1.00	1.00	1.00	1.00	1.00	1.00	1.00
MLF Adj:	1.00	1.00	0.00	1.00	1.00	1.00	1.00	1.00	1.00	1.00	1.00	1.00
FinalVolume:	95	202	0	120	500	358	330	805	123	117	788	111

Saturation Flow Module:												
Sat/Lane:	1900	1900	1900	1900	1900	1900	1900	1900	1900	1900	1900	1900
Adjustment:	0.92	1.00	0.92	0.92	0.99	0.95	0.92	0.98	0.95	0.92	1.00	0.92
Lanes:	1.00	2.00	1.00	1.00	1.14	0.86	1.00	1.73	0.27	1.00	2.00	1.00
Final Sat.:	1750	3800	1750	1750	2155	1543	1750	3209	490	1750	3800	1750

Capacity Analysis Module:												
Vol/Sat:	0.05	0.05	0.00	0.07	0.23	0.23	0.19	0.25	0.25	0.07	0.21	0.06
Crit Moves:	****			****			****			****		
Green Time:	10.7	28.1	0.0	28.1	45.6	45.6	37.0	61.4	61.4	16.4	40.7	40.7
Volume/Cap:	0.74	0.28	0.00	0.36	0.74	0.74	0.74	0.60	0.60	0.60	0.74	0.23
Delay/Veh:	87.1	50.5	0.0	51.7	47.6	47.6	56.8	33.4	33.4	66.6	50.8	40.8
User DelAdj:	1.00	1.00	1.00	1.00	1.00	1.00	1.00	1.00	1.00	1.00	1.00	1.00
AdjDel/Veh:	87.1	50.5	0.0	51.7	47.6	47.6	56.8	33.4	33.4	66.6	50.8	40.8
LOS by Move:	F	D	A	D	D	D	E	C	C	E	D	D
HCM2k95thQ:	9	7	0	10	31	31	26	28	28	11	28	8

Note: Queue reported is the number of cars per lane.

BART Phase II Extension Project

Level Of Service Computation Report
 2000 HCM Operations (Future Volume Alternative)
 AM - Existing Conditions

Intersection #3683: McLAUGHLIN/STORY

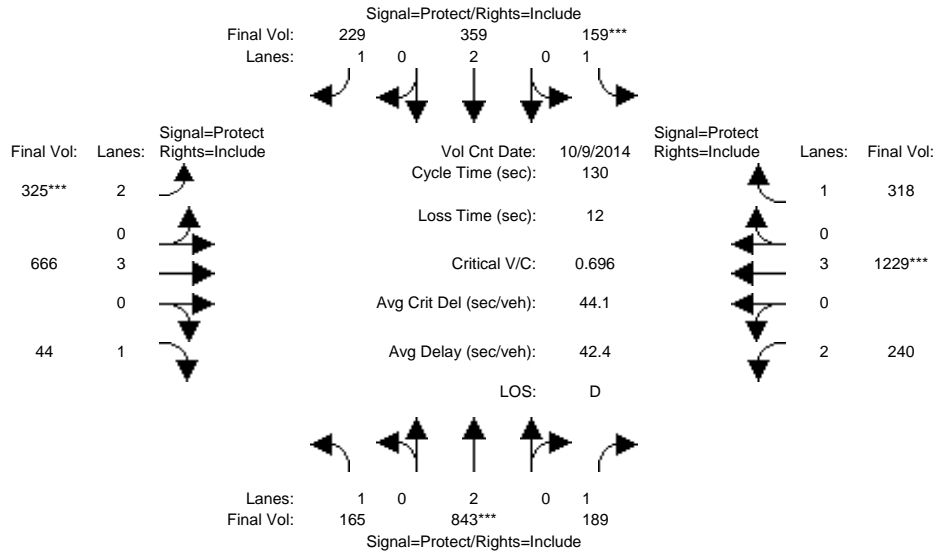

Approach:	North Bound			South Bound			East Bound			West Bound		
	L	T	R	L	T	R	L	T	R	L	T	R
Min. Green:	7	10	10	7	10	10	7	10	10	7	10	10
Y+R:	4.0	4.0	4.0	4.0	4.0	4.0	4.0	4.0	4.0	4.0	4.0	4.0
Volume Module: >> Count Date: 9 Oct 2014 <<												
Base Vol:	165	843	189	159	359	229	325	666	44	240	1229	318
Growth Adj:	1.00	1.00	1.00	1.00	1.00	1.00	1.00	1.00	1.00	1.00	1.00	1.00
Initial Bse:	165	843	189	159	359	229	325	666	44	240	1229	318
Added Vol:	0	0	0	0	0	0	0	0	0	0	0	0
PasserByVol:	0	0	0	0	0	0	0	0	0	0	0	0
Initial Fut:	165	843	189	159	359	229	325	666	44	240	1229	318
User Adj:	1.00	1.00	1.00	1.00	1.00	1.00	1.00	1.00	1.00	1.00	1.00	1.00
PHF Adj:	1.00	1.00	1.00	1.00	1.00	1.00	1.00	1.00	1.00	1.00	1.00	1.00
PHF Volume:	165	843	189	159	359	229	325	666	44	240	1229	318
Reduct Vol:	0	0	0	0	0	0	0	0	0	0	0	0
Reduced Vol:	165	843	189	159	359	229	325	666	44	240	1229	318
PCE Adj:	1.00	1.00	1.00	1.00	1.00	1.00	1.00	1.00	1.00	1.00	1.00	1.00
MLF Adj:	1.00	1.00	1.00	1.00	1.00	1.00	1.00	1.00	1.00	1.00	1.00	1.00
Final Volume:	165	843	189	159	359	229	325	666	44	240	1229	318
Saturation Flow Module:												
Sat/Lane:	1900	1900	1900	1900	1900	1900	1900	1900	1900	1900	1900	1900
Adjustment:	0.92	1.00	0.92	0.92	1.00	0.92	0.83	1.00	0.92	0.83	1.00	0.92
Lanes:	1.00	2.00	1.00	1.00	2.00	1.00	2.00	3.00	1.00	2.00	3.00	1.00
Final Sat.:	1750	3800	1750	1750	3800	1750	3150	5700	1750	3150	5700	1750
Capacity Analysis Module:												
Vol/Sat:	0.09	0.22	0.11	0.09	0.09	0.13	0.10	0.12	0.03	0.08	0.22	0.18
Crit Moves:	****			****			****			****		
Green Time:	24.5	41.5	41.5	17.0	34.0	34.0	19.3	36.1	36.1	23.5	40.3	40.3
Volume/Cap:	0.50	0.70	0.34	0.70	0.36	0.50	0.70	0.42	0.09	0.42	0.70	0.59
Delay/Veh:	48.5	40.5	34.2	63.0	39.4	41.7	57.1	38.6	34.9	47.7	40.7	39.5
User DelAdj:	1.00	1.00	1.00	1.00	1.00	1.00	1.00	1.00	1.00	1.00	1.00	1.00
AdjDel/Veh:	48.5	40.5	34.2	63.0	39.4	41.7	57.1	38.6	34.9	47.7	40.7	39.5
LOS by Move:	D	D	C	E	D	D	E	D	C	D	D	D
HCM2k95thQ:	13	27	12	13	11	15	16	14	3	10	25	21

Note: Queue reported is the number of cars per lane.

BART Phase II Extension Project

Level Of Service Computation Report
 2000 HCM Operations (Future Volume Alternative)
 PM - Existing Conditions

Intersection #3683: McLAUGHLIN/STORY

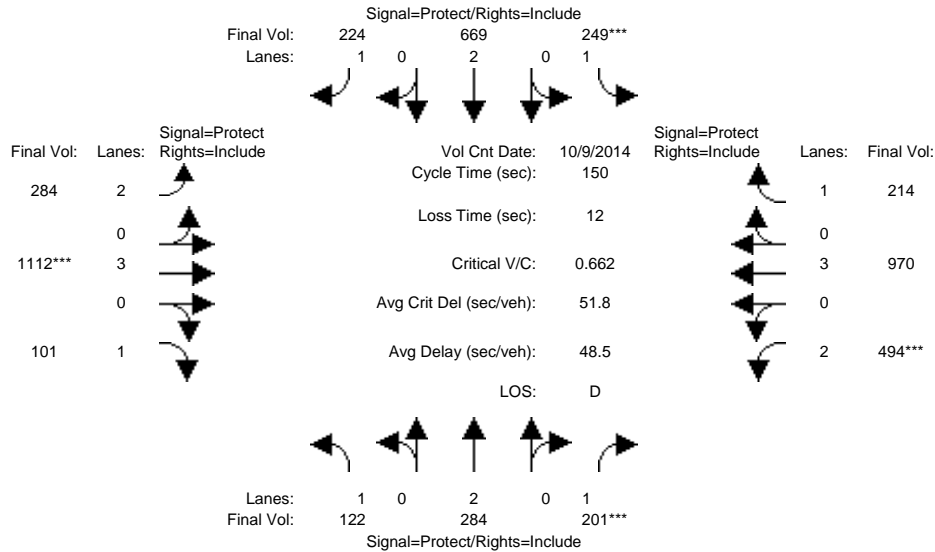

Approach:	North Bound			South Bound			East Bound			West Bound		
	L	T	R	L	T	R	L	T	R	L	T	R
Min. Green:	7	10	10	7	10	10	7	10	10	7	10	10
Y+R:	4.0	4.0	4.0	4.0	4.0	4.0	4.0	4.0	4.0	4.0	4.0	4.0
Volume Module: >> Count Date: 9 Oct 2014 <<												
Base Vol:	122	284	201	249	669	224	284	1112	101	494	970	214
Growth Adj:	1.00	1.00	1.00	1.00	1.00	1.00	1.00	1.00	1.00	1.00	1.00	1.00
Initial Bse:	122	284	201	249	669	224	284	1112	101	494	970	214
Added Vol:	0	0	0	0	0	0	0	0	0	0	0	0
PasserByVol:	0	0	0	0	0	0	0	0	0	0	0	0
Initial Fut:	122	284	201	249	669	224	284	1112	101	494	970	214
User Adj:	1.00	1.00	1.00	1.00	1.00	1.00	1.00	1.00	1.00	1.00	1.00	1.00
PHF Adj:	1.00	1.00	1.00	1.00	1.00	1.00	1.00	1.00	1.00	1.00	1.00	1.00
PHF Volume:	122	284	201	249	669	224	284	1112	101	494	970	214
Reduct Vol:	0	0	0	0	0	0	0	0	0	0	0	0
Reduced Vol:	122	284	201	249	669	224	284	1112	101	494	970	214
PCE Adj:	1.00	1.00	1.00	1.00	1.00	1.00	1.00	1.00	1.00	1.00	1.00	1.00
MLF Adj:	1.00	1.00	1.00	1.00	1.00	1.00	1.00	1.00	1.00	1.00	1.00	1.00
FinalVolume:	122	284	201	249	669	224	284	1112	101	494	970	214
Saturation Flow Module:												
Sat/Lane:	1900	1900	1900	1900	1900	1900	1900	1900	1900	1900	1900	1900
Adjustment:	0.92	1.00	0.92	0.92	1.00	0.92	0.83	1.00	0.92	0.83	1.00	0.92
Lanes:	1.00	2.00	1.00	1.00	2.00	1.00	2.00	3.00	1.00	2.00	3.00	1.00
Final Sat.:	1750	3800	1750	1750	3800	1750	3150	5700	1750	3150	5700	1750
Capacity Analysis Module:												
Vol/Sat:	0.07	0.07	0.11	0.14	0.18	0.13	0.09	0.20	0.06	0.16	0.17	0.12
Crit Moves:			****	****				****		****		
Green Time:	16.5	26.0	26.0	32.2	41.7	41.7	27.6	44.2	44.2	35.5	52.1	52.1
Volume/Cap:	0.63	0.43	0.66	0.66	0.63	0.46	0.49	0.66	0.20	0.66	0.49	0.35
Delay/Veh:	70.5	55.8	63.3	58.3	48.7	45.5	55.5	47.4	39.8	54.0	38.7	36.7
User DelAdj:	1.00	1.00	1.00	1.00	1.00	1.00	1.00	1.00	1.00	1.00	1.00	1.00
AdjDel/Veh:	70.5	55.8	63.3	58.3	48.7	45.5	55.5	47.4	39.8	54.0	38.7	36.7
LOS by Move:	E	E	E	E	D	D	E	D	D	D	D	D
HCM2k95thQ:	13	12	19	21	24	17	14	27	7	22	21	14

Note: Queue reported is the number of cars per lane.

BART Phase II Extension Project

Level Of Service Computation Report
2000 HCM Operations (Future Volume Alternative)
AM - Existing Conditions

Intersection #3762: SAN ANTONIO/24TH

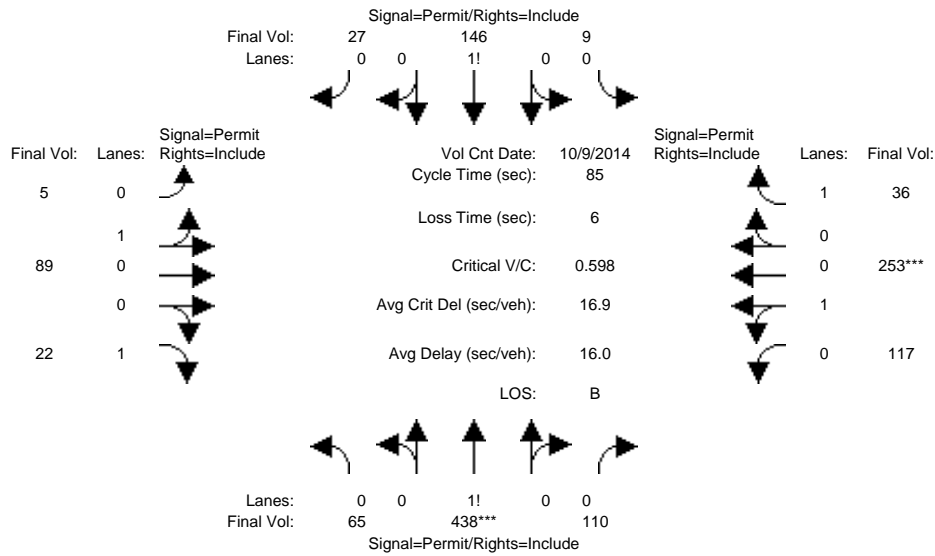

Approach:	North Bound			South Bound			East Bound			West Bound		
	L	T	R	L	T	R	L	T	R	L	T	R
Min. Green:	10	10	10	10	10	10	10	10	10	10	10	10
Y+R:	4.0	4.0	4.0	4.0	4.0	4.0	4.0	4.0	4.0	4.0	4.0	4.0
Volume Module: >> Count Date: 9 Oct 2014 <<												
Base Vol:	65	438	110	9	146	27	5	89	22	117	253	36
Growth Adj:	1.00	1.00	1.00	1.00	1.00	1.00	1.00	1.00	1.00	1.00	1.00	1.00
Initial Bse:	65	438	110	9	146	27	5	89	22	117	253	36
Added Vol:	0	0	0	0	0	0	0	0	0	0	0	0
PasserByVol:	0	0	0	0	0	0	0	0	0	0	0	0
Initial Fut:	65	438	110	9	146	27	5	89	22	117	253	36
User Adj:	1.00	1.00	1.00	1.00	1.00	1.00	1.00	1.00	1.00	1.00	1.00	1.00
PHF Adj:	1.00	1.00	1.00	1.00	1.00	1.00	1.00	1.00	1.00	1.00	1.00	1.00
PHF Volume:	65	438	110	9	146	27	5	89	22	117	253	36
Reduct Vol:	0	0	0	0	0	0	0	0	0	0	0	0
Reduced Vol:	65	438	110	9	146	27	5	89	22	117	253	36
PCE Adj:	1.00	1.00	1.00	1.00	1.00	1.00	1.00	1.00	1.00	1.00	1.00	1.00
MLF Adj:	1.00	1.00	1.00	1.00	1.00	1.00	1.00	1.00	1.00	1.00	1.00	1.00
FinalVolume:	65	438	110	9	146	27	5	89	22	117	253	36
Saturation Flow Module:												
Sat/Lane:	1900	1900	1900	1900	1900	1900	1900	1900	1900	1900	1900	1900
Adjustment:	0.92	0.92	0.92	0.92	0.92	0.92	0.95	0.95	0.92	0.95	0.95	0.92
Lanes:	0.11	0.71	0.18	0.05	0.80	0.15	0.05	0.95	1.00	0.32	0.68	1.00
Final Sat.:	186	1250	314	87	1404	260	96	1704	1750	569	1231	1750
Capacity Analysis Module:												
Vol/Sat:	0.35	0.35	0.35	0.10	0.10	0.10	0.05	0.05	0.01	0.21	0.21	0.02
Crit Moves:	****									****		
Green Time:	49.8	49.8	49.8	49.8	49.8	49.8	29.2	29.2	29.2	29.2	29.2	29.2
Volume/Cap:	0.60	0.60	0.60	0.18	0.18	0.18	0.15	0.15	0.04	0.60	0.60	0.06
Delay/Veh:	12.2	12.2	12.2	8.2	8.2	8.2	19.4	19.4	18.6	24.7	24.7	18.7
User DelAdj:	1.00	1.00	1.00	1.00	1.00	1.00	1.00	1.00	1.00	1.00	1.00	1.00
AdjDel/Veh:	12.2	12.2	12.2	8.2	8.2	8.2	19.4	19.4	18.6	24.7	24.7	18.7
LOS by Move:	B	B	B	A	A	A	B	B	B	C	C	B
HCM2k95thQ:	20	20	20	5	5	5	4	4	1	16	16	1

Note: Queue reported is the number of cars per lane.

BART Phase II Extension Project

Level Of Service Computation Report
2000 HCM Operations (Future Volume Alternative)
PM - Existing Conditions

Intersection #3762: SAN ANTONIO/24TH

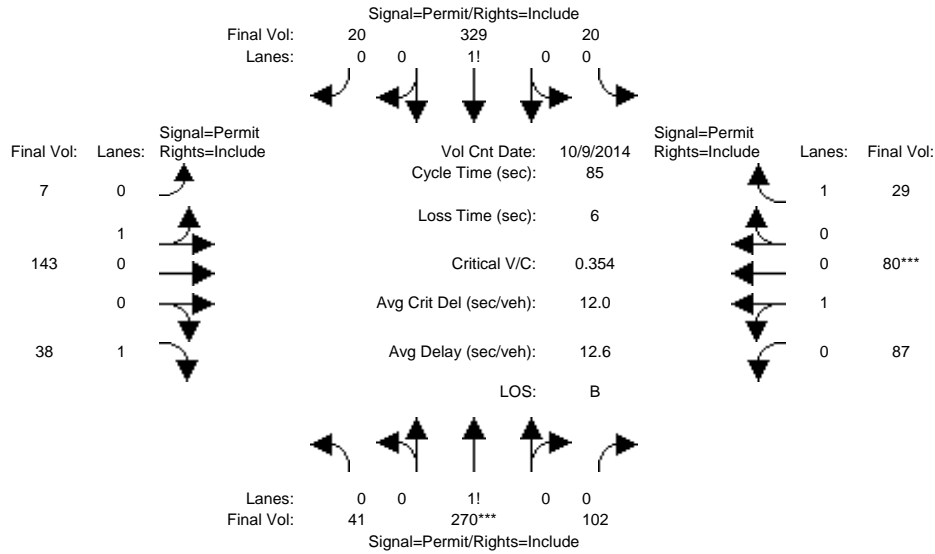

Approach:	North Bound			South Bound			East Bound			West Bound		
	L	T	R	L	T	R	L	T	R	L	T	R
Min. Green:	10	10	10	10	10	10	10	10	10	10	10	10
Y+R:	4.0	4.0	4.0	4.0	4.0	4.0	4.0	4.0	4.0	4.0	4.0	4.0
Volume Module: >> Count Date: 9 Oct 2014 <<												
Base Vol:	41	270	102	20	329	20	7	143	38	87	80	29
Growth Adj:	1.00	1.00	1.00	1.00	1.00	1.00	1.00	1.00	1.00	1.00	1.00	1.00
Initial Bse:	41	270	102	20	329	20	7	143	38	87	80	29
Added Vol:	0	0	0	0	0	0	0	0	0	0	0	0
PasserByVol:	0	0	0	0	0	0	0	0	0	0	0	0
Initial Fut:	41	270	102	20	329	20	7	143	38	87	80	29
User Adj:	1.00	1.00	1.00	1.00	1.00	1.00	1.00	1.00	1.00	1.00	1.00	1.00
PHF Adj:	1.00	1.00	1.00	1.00	1.00	1.00	1.00	1.00	1.00	1.00	1.00	1.00
PHF Volume:	41	270	102	20	329	20	7	143	38	87	80	29
Reduct Vol:	0	0	0	0	0	0	0	0	0	0	0	0
Reduced Vol:	41	270	102	20	329	20	7	143	38	87	80	29
PCE Adj:	1.00	1.00	1.00	1.00	1.00	1.00	1.00	1.00	1.00	1.00	1.00	1.00
MLF Adj:	1.00	1.00	1.00	1.00	1.00	1.00	1.00	1.00	1.00	1.00	1.00	1.00
FinalVolume:	41	270	102	20	329	20	7	143	38	87	80	29
Saturation Flow Module:												
Sat/Lane:	1900	1900	1900	1900	1900	1900	1900	1900	1900	1900	1900	1900
Adjustment:	0.92	0.92	0.92	0.92	0.92	0.92	0.95	0.95	0.92	0.95	0.95	0.92
Lanes:	0.10	0.65	0.25	0.05	0.90	0.05	0.05	0.95	1.00	0.52	0.48	1.00
Final Sat.:	174	1144	432	95	1560	95	84	1716	1750	938	862	1750
Capacity Analysis Module:												
Vol/Sat:	0.24	0.24	0.24	0.21	0.21	0.21	0.08	0.08	0.02	0.09	0.09	0.02
Crit Moves:	****									****		
Green Time:	56.7	56.7	56.7	56.7	56.7	56.7	22.3	22.3	22.3	22.3	22.3	22.3
Volume/Cap:	0.35	0.35	0.35	0.32	0.32	0.32	0.32	0.32	0.08	0.35	0.35	0.06
Delay/Veh:	6.3	6.3	6.3	6.1	6.1	6.1	25.6	25.6	23.7	26.0	26.0	23.6
User DelAdj:	1.00	1.00	1.00	1.00	1.00	1.00	1.00	1.00	1.00	1.00	1.00	1.00
AdjDel/Veh:	6.3	6.3	6.3	6.1	6.1	6.1	25.6	25.6	23.7	26.0	26.0	23.6
LOS by Move:	A	A	A	A	A	A	C	C	C	C	C	C
HCM2k95thQ:	10	10	10	9	9	9	7	7	2	7	7	1

Note: Queue reported is the number of cars per lane.

BART Phase II Extension Project

Level Of Service Computation Report
2000 HCM Operations (Future Volume Alternative)
AM - Existing Conditions

Intersection #3783: SANTA CLARA/17TH

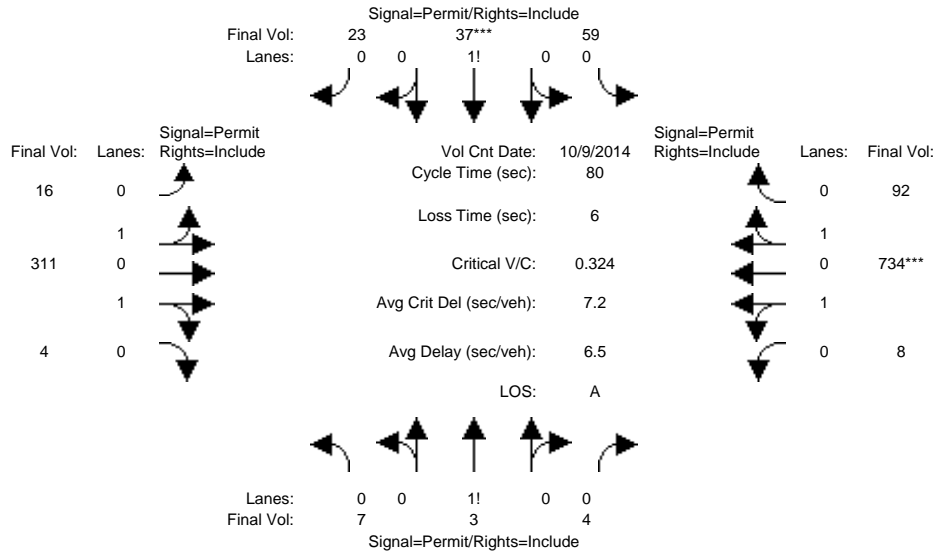

Approach:	North Bound			South Bound			East Bound			West Bound		
	L	T	R	L	T	R	L	T	R	L	T	R
Min. Green:	10	10	10	10	10	10	10	10	10	10	10	10
Y+R:	4.0	4.0	4.0	4.0	4.0	4.0	4.0	4.0	4.0	4.0	4.0	4.0
Volume Module: >> Count Date: 9 Oct 2014 <<												
Base Vol:	7	3	4	59	37	23	16	311	4	8	734	92
Growth Adj:	1.00	1.00	1.00	1.00	1.00	1.00	1.00	1.00	1.00	1.00	1.00	1.00
Initial Bse:	7	3	4	59	37	23	16	311	4	8	734	92
Added Vol:	0	0	0	0	0	0	0	0	0	0	0	0
PasserByVol:	0	0	0	0	0	0	0	0	0	0	0	0
Initial Fut:	7	3	4	59	37	23	16	311	4	8	734	92
User Adj:	1.00	1.00	1.00	1.00	1.00	1.00	1.00	1.00	1.00	1.00	1.00	1.00
PHF Adj:	1.00	1.00	1.00	1.00	1.00	1.00	1.00	1.00	1.00	1.00	1.00	1.00
PHF Volume:	7	3	4	59	37	23	16	311	4	8	734	92
Reduct Vol:	0	0	0	0	0	0	0	0	0	0	0	0
Reduced Vol:	7	3	4	59	37	23	16	311	4	8	734	92
PCE Adj:	1.00	1.00	1.00	1.00	1.00	1.00	1.00	1.00	1.00	1.00	1.00	1.00
MLF Adj:	1.00	1.00	1.00	1.00	1.00	1.00	1.00	1.00	1.00	1.00	1.00	1.00
FinalVolume:	7	3	4	59	37	23	16	311	4	8	734	92
Saturation Flow Module:												
Sat/Lane:	1900	1900	1900	1900	1900	1900	1900	1900	1900	1900	1900	1900
Adjustment:	0.92	0.92	0.92	0.92	0.92	0.92	0.95	0.95	0.95	0.95	0.95	0.95
Lanes:	0.50	0.21	0.29	0.50	0.31	0.19	0.10	1.88	0.02	0.02	1.76	0.22
Final Sat.:	875	375	500	868	544	338	174	3382	44	35	3168	397
Capacity Analysis Module:												
Vol/Sat:	0.01	0.01	0.01	0.07	0.07	0.07	0.09	0.09	0.09	0.23	0.23	0.23
Crit Moves:	****											
Green Time:	16.8	16.8	16.8	16.8	16.8	16.8	57.2	57.2	57.2	57.2	57.2	57.2
Volume/Cap:	0.04	0.04	0.04	0.32	0.32	0.32	0.13	0.13	0.13	0.32	0.32	0.32
Delay/Veh:	25.2	25.2	25.2	27.3	27.3	27.3	3.6	3.6	3.6	4.3	4.3	4.3
User DelAdj:	1.00	1.00	1.00	1.00	1.00	1.00	1.00	1.00	1.00	1.00	1.00	1.00
AdjDel/Veh:	25.2	25.2	25.2	27.3	27.3	27.3	3.6	3.6	3.6	4.3	4.3	4.3
LOS by Move:	C	C	C	C	C	C	A	A	A	A	A	A
HCM2k95thQ:	1	1	1	6	6	6	3	3	3	8	8	8

Note: Queue reported is the number of cars per lane.

BART Phase II Extension Project

Level Of Service Computation Report
2000 HCM Operations (Future Volume Alternative)
PM - Existing Conditions

Intersection #3783: SANTA CLARA/17TH

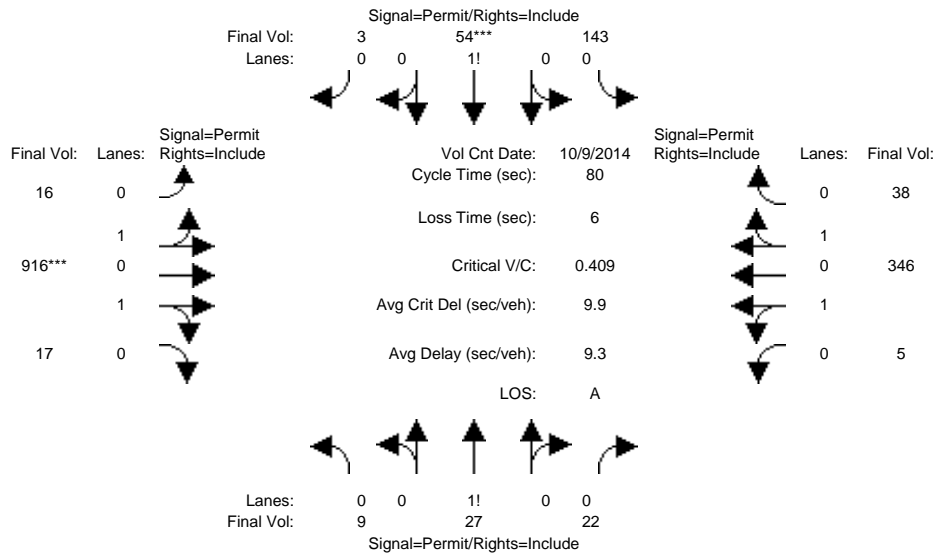

Approach:	North Bound			South Bound			East Bound			West Bound		
	L	T	R	L	T	R	L	T	R	L	T	R
Min. Green:	10	10	10	10	10	10	10	10	10	10	10	10
Y+R:	4.0	4.0	4.0	4.0	4.0	4.0	4.0	4.0	4.0	4.0	4.0	4.0

Volume Module:	>> Count Date: 9 Oct 2014 <<											
Base Vol:	9	27	22	143	54	3	16	916	17	5	346	38
Growth Adj:	1.00	1.00	1.00	1.00	1.00	1.00	1.00	1.00	1.00	1.00	1.00	1.00
Initial Bse:	9	27	22	143	54	3	16	916	17	5	346	38
Added Vol:	0	0	0	0	0	0	0	0	0	0	0	0
PasserByVol:	0	0	0	0	0	0	0	0	0	0	0	0
Initial Fut:	9	27	22	143	54	3	16	916	17	5	346	38
User Adj:	1.00	1.00	1.00	1.00	1.00	1.00	1.00	1.00	1.00	1.00	1.00	1.00
PHF Adj:	1.00	1.00	1.00	1.00	1.00	1.00	1.00	1.00	1.00	1.00	1.00	1.00
PHF Volume:	9	27	22	143	54	3	16	916	17	5	346	38
Reduct Vol:	0	0	0	0	0	0	0	0	0	0	0	0
Reduced Vol:	9	27	22	143	54	3	16	916	17	5	346	38
PCE Adj:	1.00	1.00	1.00	1.00	1.00	1.00	1.00	1.00	1.00	1.00	1.00	1.00
MLF Adj:	1.00	1.00	1.00	1.00	1.00	1.00	1.00	1.00	1.00	1.00	1.00	1.00
FinalVolume:	9	27	22	143	54	3	16	916	17	5	346	38

Saturation Flow Module:												
Sat/Lane:	1900	1900	1900	1900	1900	1900	1900	1900	1900	1900	1900	1900
Adjustment:	0.92	0.92	0.92	0.92	0.92	0.92	0.95	0.95	0.95	0.95	0.95	0.95
Lanes:	0.15	0.47	0.38	0.72	0.27	0.01	0.03	1.93	0.04	0.03	1.78	0.19
Final Sat.:	272	815	664	1251	473	26	61	3475	64	46	3202	352

Capacity Analysis Module:												
Vol/Sat:	0.03	0.03	0.03	0.11	0.11	0.11	0.26	0.26	0.26	0.11	0.11	0.11
Crit Moves:				****			****					
Green Time:	22.4	22.4	22.4	22.4	22.4	22.4	51.6	51.6	51.6	51.6	51.6	51.6
Volume/Cap:	0.12	0.12	0.12	0.41	0.41	0.41	0.41	0.41	0.41	0.17	0.17	0.17
Delay/Veh:	21.6	21.6	21.6	24.0	24.0	24.0	7.0	7.0	7.0	5.7	5.7	5.7
User DelAdj:	1.00	1.00	1.00	1.00	1.00	1.00	1.00	1.00	1.00	1.00	1.00	1.00
AdjDel/Veh:	21.6	21.6	21.6	24.0	24.0	24.0	7.0	7.0	7.0	5.7	5.7	5.7
LOS by Move:	C	C	C	C	C	C	A	A	A	A	A	A
HCM2k95thQ:	2	2	2	9	9	9	12	12	12	4	4	4

Note: Queue reported is the number of cars per lane.

BART Phase II Extension Project

Level Of Service Computation Report
2000 HCM Operations (Future Volume Alternative)
AM - Existing Conditions

Intersection #3788: SANTA CLARA/28TH

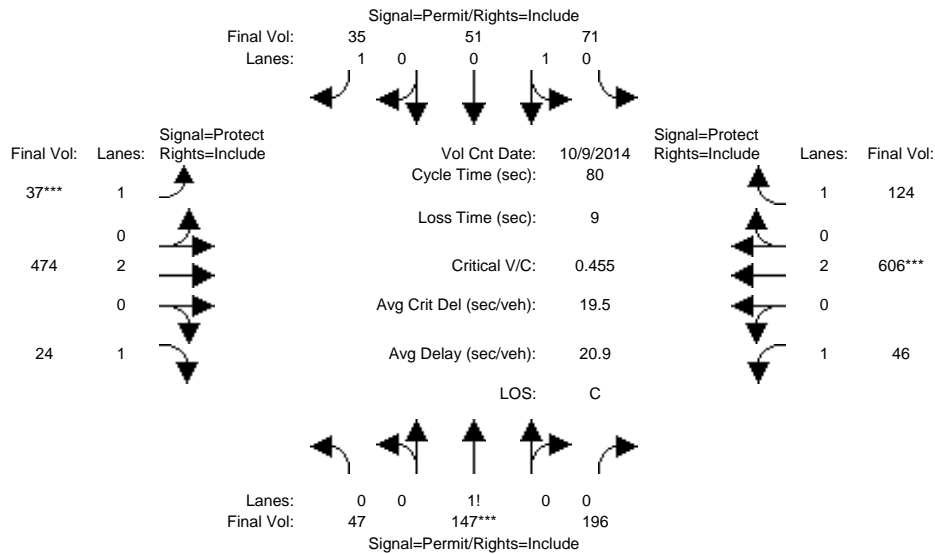

Approach:	North Bound			South Bound			East Bound			West Bound		
	L	T	R	L	T	R	L	T	R	L	T	R
Min. Green:	10	10	10	10	10	10	7	10	10	7	10	10
Y+R:	4.0	4.0	4.0	4.0	4.0	4.0	4.0	4.0	4.0	4.0	4.0	4.0
Volume Module: >> Count Date: 9 Oct 2014 <<												
Base Vol:	47	147	196	71	51	35	37	474	24	46	606	124
Growth Adj:	1.00	1.00	1.00	1.00	1.00	1.00	1.00	1.00	1.00	1.00	1.00	1.00
Initial Bse:	47	147	196	71	51	35	37	474	24	46	606	124
Added Vol:	0	0	0	0	0	0	0	0	0	0	0	0
PasserByVol:	0	0	0	0	0	0	0	0	0	0	0	0
Initial Fut:	47	147	196	71	51	35	37	474	24	46	606	124
User Adj:	1.00	1.00	1.00	1.00	1.00	1.00	1.00	1.00	1.00	1.00	1.00	1.00
PHF Adj:	1.00	1.00	1.00	1.00	1.00	1.00	1.00	1.00	1.00	1.00	1.00	1.00
PHF Volume:	47	147	196	71	51	35	37	474	24	46	606	124
Reduct Vol:	0	0	0	0	0	0	0	0	0	0	0	0
Reduced Vol:	47	147	196	71	51	35	37	474	24	46	606	124
PCE Adj:	1.00	1.00	1.00	1.00	1.00	1.00	1.00	1.00	1.00	1.00	1.00	1.00
MLF Adj:	1.00	1.00	1.00	1.00	1.00	1.00	1.00	1.00	1.00	1.00	1.00	1.00
FinalVolume:	47	147	196	71	51	35	37	474	24	46	606	124
Saturation Flow Module:												
Sat/Lane:	1900	1900	1900	1900	1900	1900	1900	1900	1900	1900	1900	1900
Adjustment:	0.92	0.92	0.92	0.95	0.95	0.92	0.92	1.00	0.92	0.92	1.00	0.92
Lanes:	0.12	0.38	0.50	0.58	0.42	1.00	1.00	2.00	1.00	1.00	2.00	1.00
Final Sat.:	211	660	879	1048	752	1750	1750	3800	1750	1750	3800	1750
Capacity Analysis Module:												
Vol/Sat:	0.22	0.22	0.22	0.07	0.07	0.02	0.02	0.12	0.01	0.03	0.16	0.07
Crit Moves:	****						****			****		
Green Time:	37.3	37.3	37.3	37.3	37.3	37.3	7.0	19.8	19.8	13.9	26.7	26.7
Volume/Cap:	0.48	0.48	0.48	0.15	0.15	0.04	0.24	0.50	0.06	0.15	0.48	0.21
Delay/Veh:	15.1	15.1	15.1	12.3	12.3	11.6	34.8	26.3	23.0	28.3	21.4	19.3
User DelAdj:	1.00	1.00	1.00	1.00	1.00	1.00	1.00	1.00	1.00	1.00	1.00	1.00
AdjDel/Veh:	15.1	15.1	15.1	12.3	12.3	11.6	34.8	26.3	23.0	28.3	21.4	19.3
LOS by Move:	B	B	B	B	B	B	C	C	C	C	C	B
HCM2k95thQ:	13	13	13	4	4	1	2	10	1	2	11	5

Note: Queue reported is the number of cars per lane.

BART Phase II Extension Project

Level Of Service Computation Report
2000 HCM Operations (Future Volume Alternative)
PM - Existing Conditions

Intersection #3788: SANTA CLARA/28TH

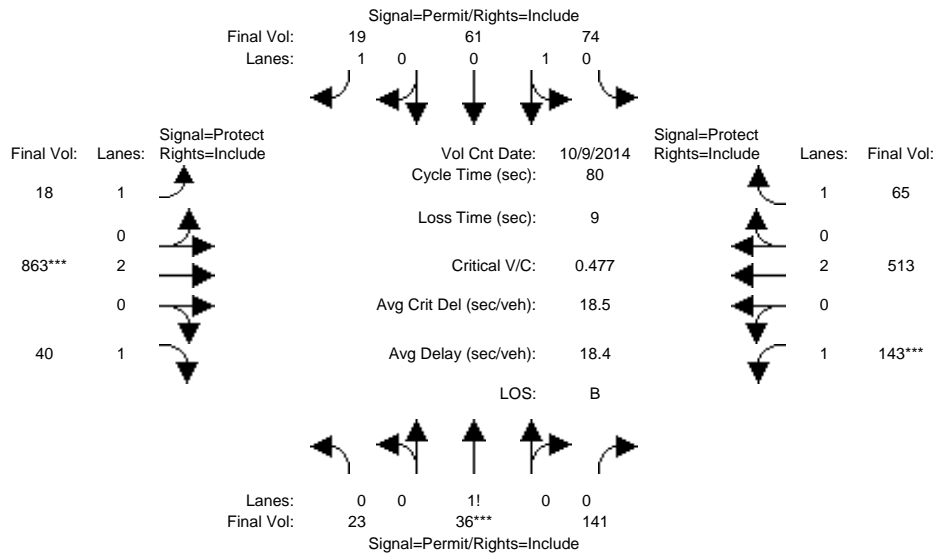

Approach:	North Bound			South Bound			East Bound			West Bound		
	L	T	R	L	T	R	L	T	R	L	T	R
Min. Green:	10	10	10	10	10	10	7	10	10	7	10	10
Y+R:	4.0	4.0	4.0	4.0	4.0	4.0	4.0	4.0	4.0	4.0	4.0	4.0
Volume Module: >> Count Date: 9 Oct 2014 <<												
Base Vol:	23	36	141	74	61	19	18	863	40	143	513	65
Growth Adj:	1.00	1.00	1.00	1.00	1.00	1.00	1.00	1.00	1.00	1.00	1.00	1.00
Initial Bse:	23	36	141	74	61	19	18	863	40	143	513	65
Added Vol:	0	0	0	0	0	0	0	0	0	0	0	0
PasserByVol:	0	0	0	0	0	0	0	0	0	0	0	0
Initial Fut:	23	36	141	74	61	19	18	863	40	143	513	65
User Adj:	1.00	1.00	1.00	1.00	1.00	1.00	1.00	1.00	1.00	1.00	1.00	1.00
PHF Adj:	1.00	1.00	1.00	1.00	1.00	1.00	1.00	1.00	1.00	1.00	1.00	1.00
PHF Volume:	23	36	141	74	61	19	18	863	40	143	513	65
Reduct Vol:	0	0	0	0	0	0	0	0	0	0	0	0
Reduced Vol:	23	36	141	74	61	19	18	863	40	143	513	65
PCE Adj:	1.00	1.00	1.00	1.00	1.00	1.00	1.00	1.00	1.00	1.00	1.00	1.00
MLF Adj:	1.00	1.00	1.00	1.00	1.00	1.00	1.00	1.00	1.00	1.00	1.00	1.00
FinalVolume:	23	36	141	74	61	19	18	863	40	143	513	65
Saturation Flow Module:												
Sat/Lane:	1900	1900	1900	1900	1900	1900	1900	1900	1900	1900	1900	1900
Adjustment:	0.92	0.92	0.92	0.95	0.95	0.92	0.92	1.00	0.92	0.92	1.00	0.92
Lanes:	0.11	0.18	0.71	0.55	0.45	1.00	1.00	2.00	1.00	1.00	2.00	1.00
Final Sat.:	201	315	1234	987	813	1750	1750	3800	1750	1750	3800	1750
Capacity Analysis Module:												
Vol/Sat:	0.11	0.11	0.11	0.08	0.08	0.01	0.01	0.23	0.02	0.08	0.14	0.04
Crit Moves:	****						****			****		
Green Time:	19.2	19.2	19.2	19.2	19.2	19.2	20.4	38.1	38.1	13.7	31.4	31.4
Volume/Cap:	0.48	0.48	0.48	0.31	0.31	0.05	0.04	0.48	0.05	0.48	0.34	0.09
Delay/Veh:	27.0	27.0	27.0	25.4	25.4	23.4	22.5	14.4	11.2	31.1	17.2	15.4
User DelAdj:	1.00	1.00	1.00	1.00	1.00	1.00	1.00	1.00	1.00	1.00	1.00	1.00
AdjDel/Veh:	27.0	27.0	27.0	25.4	25.4	23.4	22.5	14.4	11.2	31.1	17.2	15.4
LOS by Move:	C	C	C	C	C	C	C	B	B	C	B	B
HCM2k95thQ:	9	9	9	6	6	1	1	13	1	7	8	2

Note: Queue reported is the number of cars per lane.

BART Phase II Extension Project

Level Of Service Computation Report
2000 HCM Operations (Future Volume Alternative)
AM - Existing Conditions

Intersection #3789: SANTA CLARA/21ST

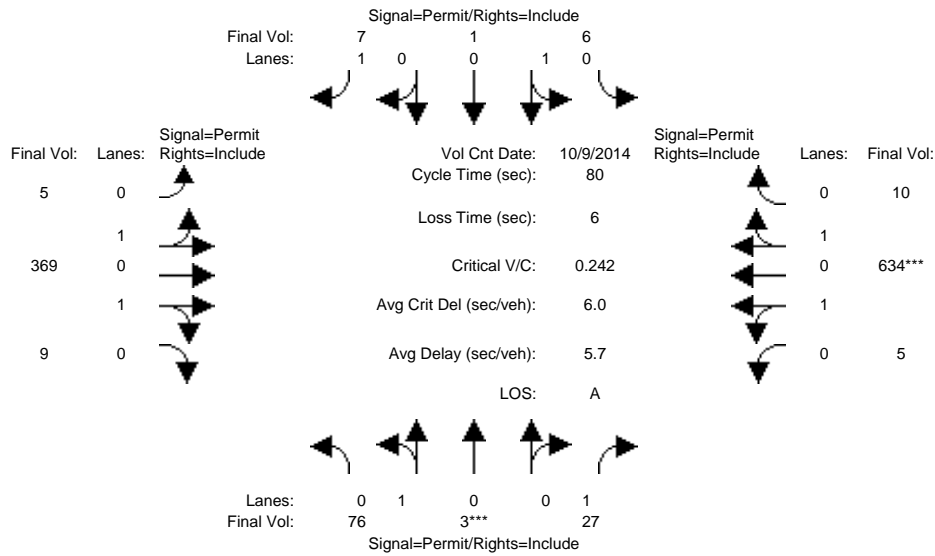

Approach:	North Bound			South Bound			East Bound			West Bound		
	L	T	R	L	T	R	L	T	R	L	T	R
Min. Green:	10	10	10	10	10	10	10	10	10	10	10	10
Y+R:	4.0	4.0	4.0	4.0	4.0	4.0	4.0	4.0	4.0	4.0	4.0	4.0
Volume Module: >> Count Date: 9 Oct 2014 <<												
Base Vol:	76	3	27	6	1	7	5	369	9	5	634	10
Growth Adj:	1.00	1.00	1.00	1.00	1.00	1.00	1.00	1.00	1.00	1.00	1.00	1.00
Initial Bse:	76	3	27	6	1	7	5	369	9	5	634	10
Added Vol:	0	0	0	0	0	0	0	0	0	0	0	0
PasserByVol:	0	0	0	0	0	0	0	0	0	0	0	0
Initial Fut:	76	3	27	6	1	7	5	369	9	5	634	10
User Adj:	1.00	1.00	1.00	1.00	1.00	1.00	1.00	1.00	1.00	1.00	1.00	1.00
PHF Adj:	1.00	1.00	1.00	1.00	1.00	1.00	1.00	1.00	1.00	1.00	1.00	1.00
PHF Volume:	76	3	27	6	1	7	5	369	9	5	634	10
Reduct Vol:	0	0	0	0	0	0	0	0	0	0	0	0
Reduced Vol:	76	3	27	6	1	7	5	369	9	5	634	10
PCE Adj:	1.00	1.00	1.00	1.00	1.00	1.00	1.00	1.00	1.00	1.00	1.00	1.00
MLF Adj:	1.00	1.00	1.00	1.00	1.00	1.00	1.00	1.00	1.00	1.00	1.00	1.00
FinalVolume:	76	3	27	6	1	7	5	369	9	5	634	10
Saturation Flow Module:												
Sat/Lane:	1900	1900	1900	1900	1900	1900	1900	1900	1900	1900	1900	1900
Adjustment:	0.95	0.95	0.92	0.95	0.95	0.92	0.95	0.95	0.95	0.95	0.95	0.95
Lanes:	0.96	0.04	1.00	0.86	0.14	1.00	0.02	1.93	0.05	0.02	1.95	0.03
Final Sat.:	1732	68	1750	1543	257	1750	47	3468	85	28	3517	55
Capacity Analysis Module:												
Vol/Sat:	0.04	0.04	0.02	0.00	0.00	0.00	0.11	0.11	0.11	0.18	0.18	0.18
Crit Moves:	****											
Green Time:	14.5	14.5	14.5	14.5	14.5	14.5	59.5	59.5	59.5	59.5	59.5	59.5
Volume/Cap:	0.24	0.24	0.09	0.02	0.02	0.02	0.14	0.14	0.14	0.24	0.24	0.24
Delay/Veh:	28.4	28.4	27.4	27.0	27.0	27.0	3.0	3.0	3.0	3.2	3.2	3.2
User DelAdj:	1.00	1.00	1.00	1.00	1.00	1.00	1.00	1.00	1.00	1.00	1.00	1.00
AdjDel/Veh:	28.4	28.4	27.4	27.0	27.0	27.0	3.0	3.0	3.0	3.2	3.2	3.2
LOS by Move:	C	C	C	C	C	C	A	A	A	A	A	A
HCM2k95thQ:	4	4	1	0	0	0	3	3	3	5	5	5

Note: Queue reported is the number of cars per lane.

BART Phase II Extension Project

Level Of Service Computation Report
2000 HCM Operations (Future Volume Alternative)
PM - Existing Conditions

Intersection #3789: SANTA CLARA/21ST

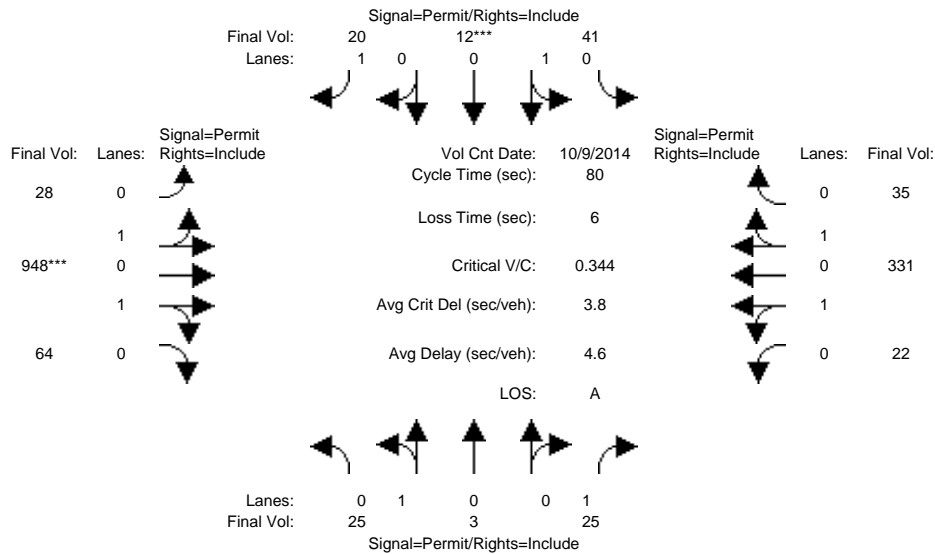

Approach:	North Bound			South Bound			East Bound			West Bound		
	L	T	R	L	T	R	L	T	R	L	T	R
Min. Green:	10	10	10	10	10	10	10	10	10	10	10	10
Y+R:	4.0	4.0	4.0	4.0	4.0	4.0	4.0	4.0	4.0	4.0	4.0	4.0
Volume Module: >> Count Date: 9 Oct 2014 <<												
Base Vol:	25	3	25	41	12	20	28	948	64	22	331	35
Growth Adj:	1.00	1.00	1.00	1.00	1.00	1.00	1.00	1.00	1.00	1.00	1.00	1.00
Initial Bse:	25	3	25	41	12	20	28	948	64	22	331	35
Added Vol:	0	0	0	0	0	0	0	0	0	0	0	0
PasserByVol:	0	0	0	0	0	0	0	0	0	0	0	0
Initial Fut:	25	3	25	41	12	20	28	948	64	22	331	35
User Adj:	1.00	1.00	1.00	1.00	1.00	1.00	1.00	1.00	1.00	1.00	1.00	1.00
PHF Adj:	1.00	1.00	1.00	1.00	1.00	1.00	1.00	1.00	1.00	1.00	1.00	1.00
PHF Volume:	25	3	25	41	12	20	28	948	64	22	331	35
Reduct Vol:	0	0	0	0	0	0	0	0	0	0	0	0
Reduced Vol:	25	3	25	41	12	20	28	948	64	22	331	35
PCE Adj:	1.00	1.00	1.00	1.00	1.00	1.00	1.00	1.00	1.00	1.00	1.00	1.00
MLF Adj:	1.00	1.00	1.00	1.00	1.00	1.00	1.00	1.00	1.00	1.00	1.00	1.00
Final Volume:	25	3	25	41	12	20	28	948	64	22	331	35
Saturation Flow Module:												
Sat/Lane:	1900	1900	1900	1900	1900	1900	1900	1900	1900	1900	1900	1900
Adjustment:	0.95	0.95	0.92	0.95	0.95	0.92	0.95	0.95	0.95	0.95	0.95	0.95
Lanes:	0.89	0.11	1.00	0.77	0.23	1.00	0.05	1.83	0.12	0.11	1.71	0.18
Final Sat.:	1607	193	1750	1392	408	1750	97	3282	222	204	3071	325
Capacity Analysis Module:												
Vol/Sat:	0.02	0.02	0.01	0.03	0.03	0.01	0.29	0.29	0.29	0.11	0.11	0.11
Crit Moves:				****			****					
Green Time:	10.0	10.0	10.0	10.0	10.0	10.0	64.0	64.0	64.0	64.0	64.0	64.0
Volume/Cap:	0.12	0.12	0.11	0.24	0.24	0.09	0.36	0.36	0.36	0.13	0.13	0.13
Delay/Veh:	31.4	31.4	31.3	32.1	32.1	31.2	2.3	2.3	2.3	1.8	1.8	1.8
User DelAdj:	1.00	1.00	1.00	1.00	1.00	1.00	1.00	1.00	1.00	1.00	1.00	1.00
AdjDel/Veh:	31.4	31.4	31.3	32.1	32.1	31.2	2.3	2.3	2.3	1.8	1.8	1.8
LOS by Move:	C	C	C	C	C	C	A	A	A	A	A	A
HCM2k95thQ:	2	2	1	3	3	1	8	8	8	2	2	2

Note: Queue reported is the number of cars per lane.

BART Phase II Extension Project

Level Of Service Computation Report
2000 HCM Operations (Future Volume Alternative)
AM - Existing Conditions

Intersection #3790: SANTA CLARA/24TH

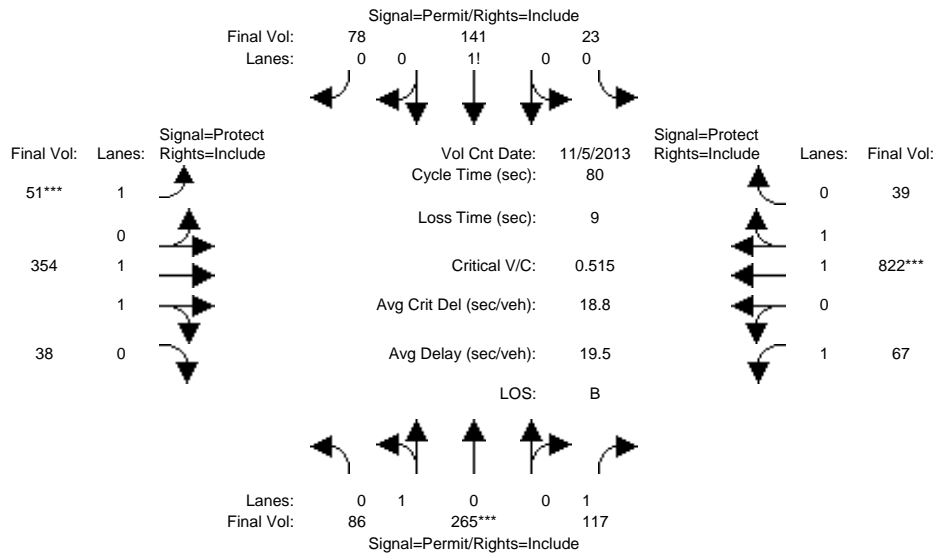

Approach:	North Bound			South Bound			East Bound			West Bound		
	L	T	R	L	T	R	L	T	R	L	T	R
Min. Green:	10	10	10	10	10	10	7	10	10	7	10	10
Y+R:	4.0	4.0	4.0	4.0	4.0	4.0	4.0	4.0	4.0	4.0	4.0	4.0
Volume Module: >> Count Date: 5 Nov 2013 <<												
Base Vol:	86	265	117	23	141	78	51	354	38	67	822	39
Growth Adj:	1.00	1.00	1.00	1.00	1.00	1.00	1.00	1.00	1.00	1.00	1.00	1.00
Initial Bse:	86	265	117	23	141	78	51	354	38	67	822	39
Added Vol:	0	0	0	0	0	0	0	0	0	0	0	0
PasserByVol:	0	0	0	0	0	0	0	0	0	0	0	0
Initial Fut:	86	265	117	23	141	78	51	354	38	67	822	39
User Adj:	1.00	1.00	1.00	1.00	1.00	1.00	1.00	1.00	1.00	1.00	1.00	1.00
PHF Adj:	1.00	1.00	1.00	1.00	1.00	1.00	1.00	1.00	1.00	1.00	1.00	1.00
PHF Volume:	86	265	117	23	141	78	51	354	38	67	822	39
Reduct Vol:	0	0	0	0	0	0	0	0	0	0	0	0
Reduced Vol:	86	265	117	23	141	78	51	354	38	67	822	39
PCE Adj:	1.00	1.00	1.00	1.00	1.00	1.00	1.00	1.00	1.00	1.00	1.00	1.00
MLF Adj:	1.00	1.00	1.00	1.00	1.00	1.00	1.00	1.00	1.00	1.00	1.00	1.00
FinalVolume:	86	265	117	23	141	78	51	354	38	67	822	39
Saturation Flow Module:												
Sat/Lane:	1900	1900	1900	1900	1900	1900	1900	1900	1900	1900	1900	1900
Adjustment:	0.95	0.95	0.92	0.92	0.92	0.92	0.92	0.98	0.95	0.92	0.97	0.95
Lanes:	0.25	0.75	1.00	0.10	0.58	0.32	1.00	1.80	0.20	1.00	1.91	0.09
Final Sat.:	441	1359	1750	166	1020	564	1750	3341	359	1750	3532	168
Capacity Analysis Module:												
Vol/Sat:	0.20	0.20	0.07	0.14	0.14	0.14	0.03	0.11	0.11	0.04	0.23	0.23
Crit Moves:	****						****			****		
Green Time:	29.2	29.2	29.2	29.2	29.2	29.2	7.0	24.6	24.6	17.2	34.8	34.8
Volume/Cap:	0.53	0.53	0.18	0.38	0.38	0.38	0.33	0.34	0.34	0.18	0.53	0.53
Delay/Veh:	20.9	20.9	17.4	19.1	19.1	19.1	35.6	21.6	21.6	25.8	17.0	17.0
User DelAdj:	1.00	1.00	1.00	1.00	1.00	1.00	1.00	1.00	1.00	1.00	1.00	1.00
AdjDel/Veh:	20.9	20.9	17.4	19.1	19.1	19.1	35.6	21.6	21.6	25.8	17.0	17.0
LOS by Move:	C	C	B	B	B	B	D	C	C	C	B	B
HCM2k95thQ:	13	13	4	10	10	10	3	7	7	3	15	15

Note: Queue reported is the number of cars per lane.

BART Phase II Extension Project

Level Of Service Computation Report
2000 HCM Operations (Future Volume Alternative)
PM - Existing Conditions

Intersection #3790: SANTA CLARA/24TH

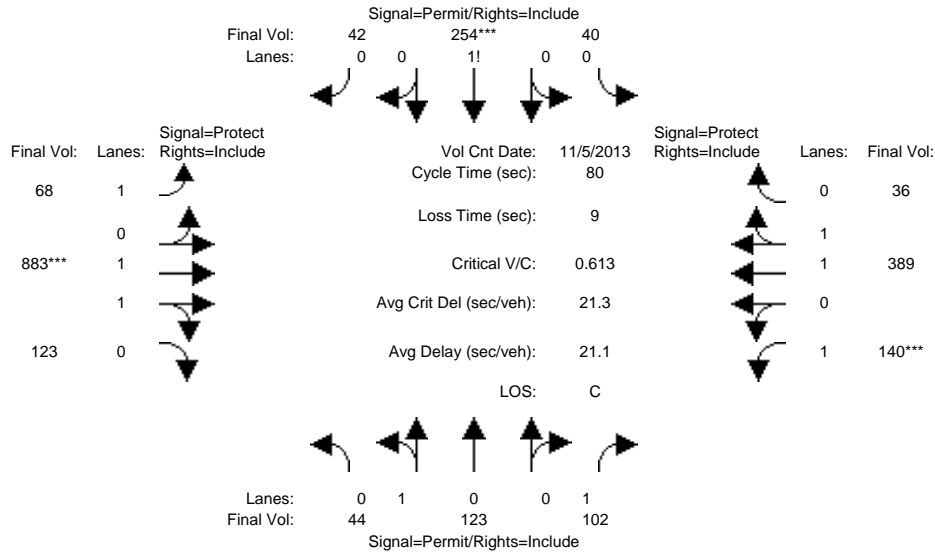

Approach:	North Bound			South Bound			East Bound			West Bound		
	L	T	R	L	T	R	L	T	R	L	T	R
Min. Green:	10	10	10	10	10	10	7	10	10	7	10	10
Y+R:	4.0	4.0	4.0	4.0	4.0	4.0	4.0	4.0	4.0	4.0	4.0	4.0

Volume Module:	>>	Count	Date:	5 Nov 2013	<<							
Base Vol:	44	123	102	40	254	42	68	883	123	140	389	36
Growth Adj:	1.00	1.00	1.00	1.00	1.00	1.00	1.00	1.00	1.00	1.00	1.00	1.00
Initial Bse:	44	123	102	40	254	42	68	883	123	140	389	36
Added Vol:	0	0	0	0	0	0	0	0	0	0	0	0
PasserByVol:	0	0	0	0	0	0	0	0	0	0	0	0
Initial Fut:	44	123	102	40	254	42	68	883	123	140	389	36
User Adj:	1.00	1.00	1.00	1.00	1.00	1.00	1.00	1.00	1.00	1.00	1.00	1.00
PHF Adj:	1.00	1.00	1.00	1.00	1.00	1.00	1.00	1.00	1.00	1.00	1.00	1.00
PHF Volume:	44	123	102	40	254	42	68	883	123	140	389	36
Reduct Vol:	0	0	0	0	0	0	0	0	0	0	0	0
Reduced Vol:	44	123	102	40	254	42	68	883	123	140	389	36
PCE Adj:	1.00	1.00	1.00	1.00	1.00	1.00	1.00	1.00	1.00	1.00	1.00	1.00
MLF Adj:	1.00	1.00	1.00	1.00	1.00	1.00	1.00	1.00	1.00	1.00	1.00	1.00
FinalVolume:	44	123	102	40	254	42	68	883	123	140	389	36

Saturation Flow Module:												
Sat/Lane:	1900	1900	1900	1900	1900	1900	1900	1900	1900	1900	1900	1900
Adjustment:	0.95	0.95	0.92	0.92	0.92	0.92	0.92	0.98	0.95	0.92	0.98	0.95
Lanes:	0.26	0.74	1.00	0.12	0.76	0.12	1.00	1.75	0.25	1.00	1.83	0.17
Final Sat.:	474	1326	1750	208	1323	219	1750	3247	452	1750	3386	313

Capacity Analysis Module:												
Vol/Sat:	0.09	0.09	0.06	0.19	0.19	0.19	0.04	0.27	0.27	0.08	0.11	0.11
Crit Moves:				****	****	****	****	****	****	****	****	****
Green Time:	25.1	25.1	25.1	25.1	25.1	25.1	18.9	35.5	35.5	10.4	27.0	27.0
Volume/Cap:	0.30	0.30	0.19	0.61	0.61	0.61	0.16	0.61	0.61	0.61	0.34	0.34
Delay/Veh:	21.1	21.1	20.2	25.4	25.4	25.4	24.5	17.7	17.7	37.7	20.0	20.0
User DelAdj:	1.00	1.00	1.00	1.00	1.00	1.00	1.00	1.00	1.00	1.00	1.00	1.00
AdjDel/Veh:	21.1	21.1	20.2	25.4	25.4	25.4	24.5	17.7	17.7	37.7	20.0	20.0
LOS by Move:	C	C	C	C	C	C	C	B	B	D	B	B
HCM2k95thQ:	6	6	4	16	16	16	3	18	18	7	8	8

Note: Queue reported is the number of cars per lane.

BART Phase II Extension Project

Level Of Service Computation Report
2000 HCM Operations (Future Volume Alternative)
AM - Existing Conditions

Intersection #3832: 24TH/WILLIAM

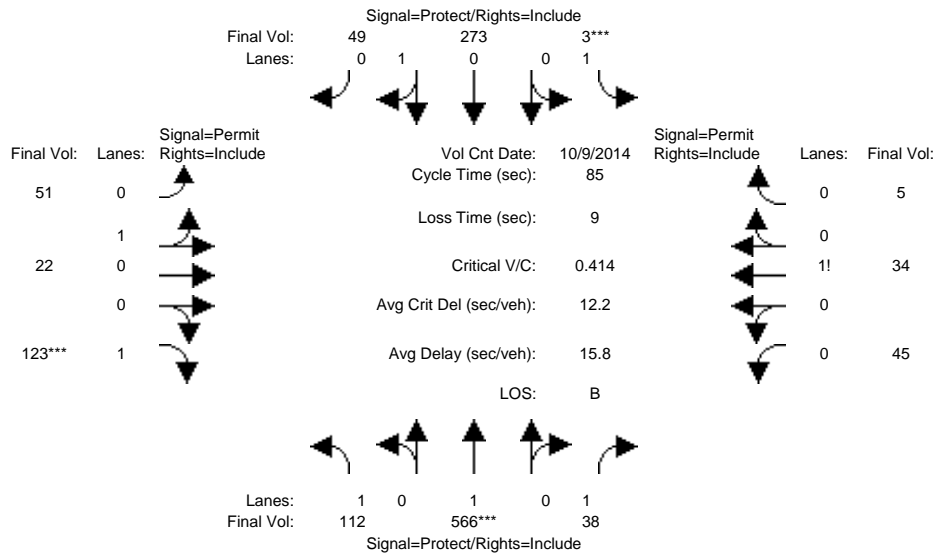

Approach:	North Bound			South Bound			East Bound			West Bound		
	L	T	R	L	T	R	L	T	R	L	T	R
Min. Green:	7	10	10	7	10	10	10	10	10	10	10	10
Y+R:	4.0	4.0	4.0	4.0	4.0	4.0	4.0	4.0	4.0	4.0	4.0	4.0
Volume Module: >> Count Date: 9 Oct 2014 <<												
Base Vol:	112	566	38	3	273	49	51	22	123	45	34	5
Growth Adj:	1.00	1.00	1.00	1.00	1.00	1.00	1.00	1.00	1.00	1.00	1.00	1.00
Initial Bse:	112	566	38	3	273	49	51	22	123	45	34	5
Added Vol:	0	0	0	0	0	0	0	0	0	0	0	0
PasserByVol:	0	0	0	0	0	0	0	0	0	0	0	0
Initial Fut:	112	566	38	3	273	49	51	22	123	45	34	5
User Adj:	1.00	1.00	1.00	1.00	1.00	1.00	1.00	1.00	1.00	1.00	1.00	1.00
PHF Adj:	1.00	1.00	1.00	1.00	1.00	1.00	1.00	1.00	1.00	1.00	1.00	1.00
PHF Volume:	112	566	38	3	273	49	51	22	123	45	34	5
Reduct Vol:	0	0	0	0	0	0	0	0	0	0	0	0
Reduced Vol:	112	566	38	3	273	49	51	22	123	45	34	5
PCE Adj:	1.00	1.00	1.00	1.00	1.00	1.00	1.00	1.00	1.00	1.00	1.00	1.00
MLF Adj:	1.00	1.00	1.00	1.00	1.00	1.00	1.00	1.00	1.00	1.00	1.00	1.00
FinalVolume:	112	566	38	3	273	49	51	22	123	45	34	5
Saturation Flow Module:												
Sat/Lane:	1900	1900	1900	1900	1900	1900	1900	1900	1900	1900	1900	1900
Adjustment:	0.92	1.00	0.92	0.92	0.95	0.95	0.95	0.95	0.92	0.92	0.92	0.92
Lanes:	1.00	1.00	1.00	1.00	0.85	0.15	0.70	0.30	1.00	0.54	0.40	0.06
Final Sat.:	1750	1900	1750	1750	1526	274	1258	542	1750	938	708	104
Capacity Analysis Module:												
Vol/Sat:	0.06	0.30	0.02	0.00	0.18	0.18	0.04	0.04	0.07	0.05	0.05	0.05
Crit Moves:	****			****			****			****		
Green Time:	19.8	55.8	55.8	7.0	43.0	43.0	13.2	13.2	13.2	13.2	13.2	13.2
Volume/Cap:	0.27	0.45	0.03	0.02	0.35	0.35	0.26	0.26	0.45	0.31	0.31	0.31
Delay/Veh:	27.1	7.4	5.1	35.9	12.9	12.9	32.1	32.1	33.8	32.5	32.5	32.5
User DelAdj:	1.00	1.00	1.00	1.00	1.00	1.00	1.00	1.00	1.00	1.00	1.00	1.00
AdjDel/Veh:	27.1	7.4	5.1	35.9	12.9	12.9	32.1	32.1	33.8	32.5	32.5	32.5
LOS by Move:	C	A	A	D	B	B	C	C	C	C	C	C
HCM2k95thQ:	5	14	1	0	10	10	4	4	7	5	5	5

Note: Queue reported is the number of cars per lane.

BART Phase II Extension Project

Level Of Service Computation Report
2000 HCM Operations (Future Volume Alternative)
PM - Existing Conditions

Intersection #3832: 24TH/WILLIAM

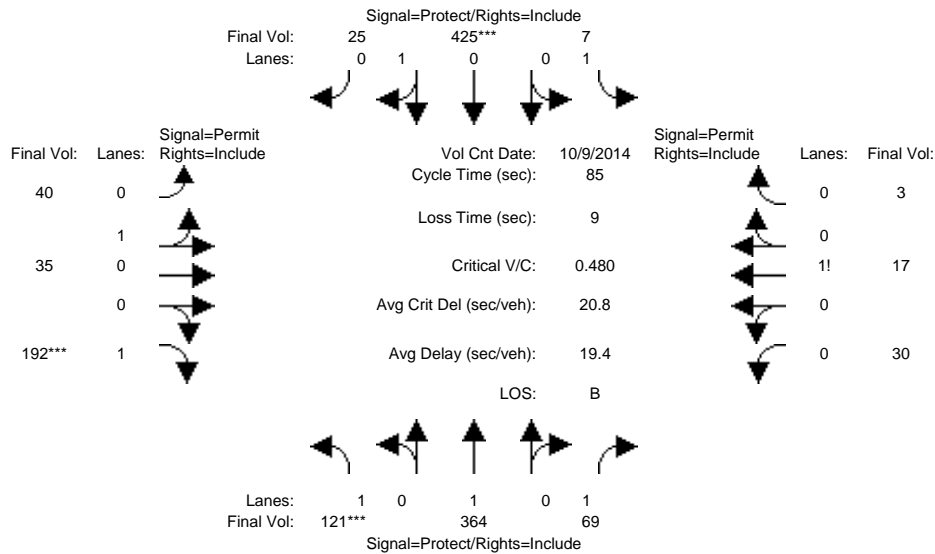

Approach:	North Bound			South Bound			East Bound			West Bound		
Movement:	L	T	R	L	T	R	L	T	R	L	T	R
Min. Green:	7	10	10	7	10	10	10	10	10	10	10	10
Y+R:	4.0	4.0	4.0	4.0	4.0	4.0	4.0	4.0	4.0	4.0	4.0	4.0
Volume Module: >> Count Date: 9 Oct 2014 <<												
Base Vol:	121	364	69	7	425	25	40	35	192	30	17	3
Growth Adj:	1.00	1.00	1.00	1.00	1.00	1.00	1.00	1.00	1.00	1.00	1.00	1.00
Initial Bse:	121	364	69	7	425	25	40	35	192	30	17	3
Added Vol:	0	0	0	0	0	0	0	0	0	0	0	0
PasserByVol:	0	0	0	0	0	0	0	0	0	0	0	0
Initial Fut:	121	364	69	7	425	25	40	35	192	30	17	3
User Adj:	1.00	1.00	1.00	1.00	1.00	1.00	1.00	1.00	1.00	1.00	1.00	1.00
PHF Adj:	1.00	1.00	1.00	1.00	1.00	1.00	1.00	1.00	1.00	1.00	1.00	1.00
PHF Volume:	121	364	69	7	425	25	40	35	192	30	17	3
Reduct Vol:	0	0	0	0	0	0	0	0	0	0	0	0
Reduced Vol:	121	364	69	7	425	25	40	35	192	30	17	3
PCE Adj:	1.00	1.00	1.00	1.00	1.00	1.00	1.00	1.00	1.00	1.00	1.00	1.00
MLF Adj:	1.00	1.00	1.00	1.00	1.00	1.00	1.00	1.00	1.00	1.00	1.00	1.00
FinalVolume:	121	364	69	7	425	25	40	35	192	30	17	3
Saturation Flow Module:												
Sat/Lane:	1900	1900	1900	1900	1900	1900	1900	1900	1900	1900	1900	1900
Adjustment:	0.92	1.00	0.92	0.92	0.95	0.95	0.95	0.95	0.92	0.92	0.92	0.92
Lanes:	1.00	1.00	1.00	1.00	0.94	0.06	0.53	0.47	1.00	0.60	0.34	0.06
Final Sat.:	1750	1900	1750	1750	1700	100	960	840	1750	1050	595	105
Capacity Analysis Module:												
Vol/Sat:	0.07	0.19	0.04	0.00	0.25	0.25	0.04	0.04	0.11	0.03	0.03	0.03
Crit Moves:	****				****				****			
Green Time:	12.3	39.6	39.6	17.0	44.3	44.3	19.4	19.4	19.4	19.4	19.4	19.4
Volume/Cap:	0.48	0.41	0.08	0.02	0.48	0.48	0.18	0.18	0.48	0.12	0.12	0.12
Delay/Veh:	34.9	15.3	12.7	27.3	13.4	13.4	26.6	26.6	29.3	26.2	26.2	26.2
User DelAdj:	1.00	1.00	1.00	1.00	1.00	1.00	1.00	1.00	1.00	1.00	1.00	1.00
AdjDel/Veh:	34.9	15.3	12.7	27.3	13.4	13.4	26.6	26.6	29.3	26.2	26.2	26.2
LOS by Move:	C	B	B	C	B	B	C	C	C	C	C	C
HCM2k95thQ:	6	12	2	0	15	15	4	4	10	2	2	2

Note: Queue reported is the number of cars per lane.

BART Phase II Extension Project

Level Of Service Computation Report
2000 HCM Operations (Future Volume Alternative)
AM - Existing Conditions

Intersection #4005: JULIAN/28TH

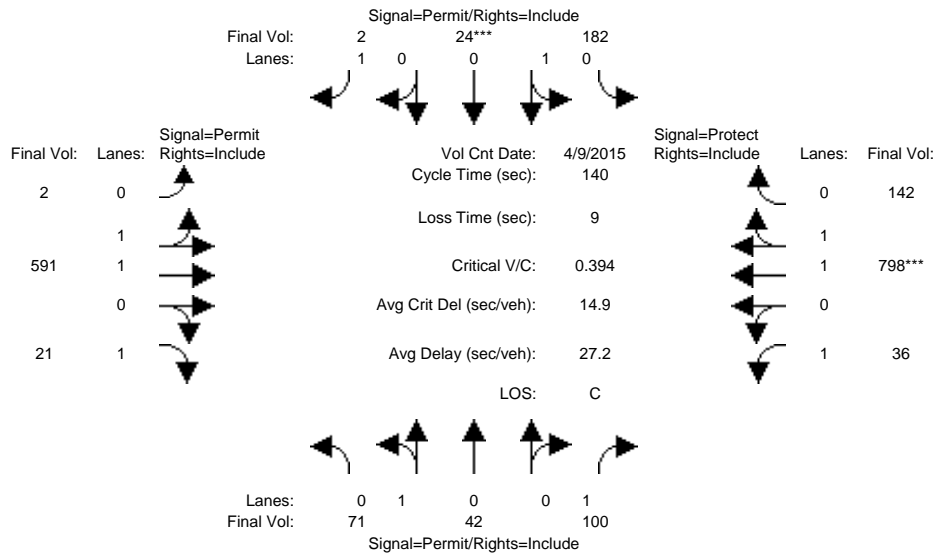

Approach:	North Bound			South Bound			East Bound			West Bound			
Movement:	L	T	R	L	T	R	L	T	R	L	T	R	
Min. Green:	10	10	10	10	10	10	10	10	10	7	10	10	
Y+R:	4.0	4.0	4.0	4.0	4.0	4.0	4.0	4.0	4.0	4.0	4.0	4.0	
Volume Module: >> Count Date: 9 Apr 2015 <<													
Base Vol:	71	42	100	182	24	2	2	591	21	36	798	142	
Growth Adj:	1.00	1.00	1.00	1.00	1.00	1.00	1.00	1.00	1.00	1.00	1.00	1.00	
Initial Bse:	71	42	100	182	24	2	2	591	21	36	798	142	
Added Vol:	0	0	0	0	0	0	0	0	0	0	0	0	
PasserByVol:	0	0	0	0	0	0	0	0	0	0	0	0	
Initial Fut:	71	42	100	182	24	2	2	591	21	36	798	142	
User Adj:	1.00	1.00	1.00	1.00	1.00	1.00	1.00	1.00	1.00	1.00	1.00	1.00	
PHF Adj:	1.00	1.00	1.00	1.00	1.00	1.00	1.00	1.00	1.00	1.00	1.00	1.00	
PHF Volume:	71	42	100	182	24	2	2	591	21	36	798	142	
Reduct Vol:	0	0	0	0	0	0	0	0	0	0	0	0	
Reduced Vol:	71	42	100	182	24	2	2	591	21	36	798	142	
PCE Adj:	1.00	1.00	1.00	1.00	1.00	1.00	1.00	1.00	1.00	1.00	1.00	1.00	
MLF Adj:	1.00	1.00	1.00	1.00	1.00	1.00	1.00	1.00	1.00	1.00	1.00	1.00	
FinalVolume:	71	42	100	182	24	2	2	591	21	36	798	142	
Saturation Flow Module:													
Sat/Lane:	1900	1900	1900	1900	1900	1900	1900	1900	1900	1900	1900	1900	
Adjustment:	0.95	0.95	0.92	0.95	0.95	0.92	0.95	0.97	0.92	0.92	0.98	0.95	
Lanes:	0.63	0.37	1.00	0.88	0.12	1.00	0.01	1.99	1.00	1.00	1.69	0.31	
Final Sat.:	1131	669	1750	1590	210	1750	12	3688	1750	1750	3141	559	
Capacity Analysis Module:													
Vol/Sat:	0.06	0.06	0.06	0.11	0.11	0.00	0.16	0.16	0.01	0.02	0.25	0.25	
Crit Moves:							****						
Green Time:	28.4	28.4	28.4	28.4	28.4	28.4	39.7	39.7	39.7	62.9	103	102.6	
Volume/Cap:	0.31	0.31	0.28	0.57	0.57	0.01	0.57	0.57	0.04	0.05	0.35	0.35	
Delay/Veh:	48.0	48.0	47.7	52.3	52.3	44.6	43.5	43.5	36.4	21.7	6.8	6.8	
User DelAdj:	1.00	1.00	1.00	1.00	1.00	1.00	1.00	1.00	1.00	1.00	1.00	1.00	
AdjDel/Veh:	48.0	48.0	47.7	52.3	52.3	44.6	43.5	43.5	36.4	21.7	6.8	6.8	
LOS by Move:	D	D	D	D	D	D	D	D	D	C	A	A	
HCM2k95thQ:	8	8	7	17	17	0	20	20	1	2	14	14	

Note: Queue reported is the number of cars per lane.

BART Phase II Extension Project

Level Of Service Computation Report
2000 HCM Operations (Future Volume Alternative)
PM - Existing Conditions

Intersection #4005: JULIAN/28TH

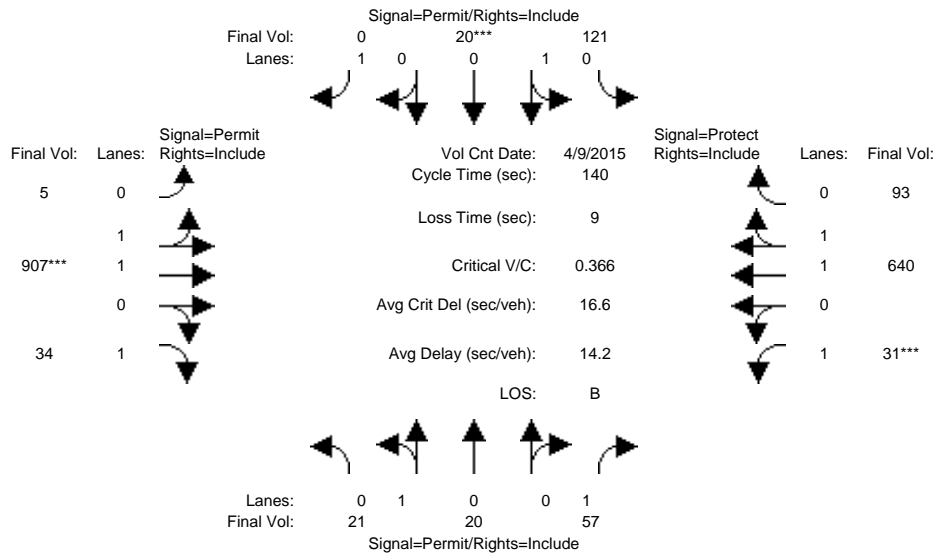

Approach:	North Bound			South Bound			East Bound			West Bound		
	L	T	R	L	T	R	L	T	R	L	T	R
Min. Green:	10	10	10	10	10	10	10	10	10	7	10	10
Y+R:	4.0	4.0	4.0	4.0	4.0	4.0	4.0	4.0	4.0	4.0	4.0	4.0
Volume Module: >> Count Date: 9 Apr 2015 <<												
Base Vol:	21	20	57	121	20	0	5	907	34	31	640	93
Growth Adj:	1.00	1.00	1.00	1.00	1.00	1.00	1.00	1.00	1.00	1.00	1.00	1.00
Initial Bse:	21	20	57	121	20	0	5	907	34	31	640	93
Added Vol:	0	0	0	0	0	0	0	0	0	0	0	0
PasserByVol:	0	0	0	0	0	0	0	0	0	0	0	0
Initial Fut:	21	20	57	121	20	0	5	907	34	31	640	93
User Adj:	1.00	1.00	1.00	1.00	1.00	1.00	1.00	1.00	1.00	1.00	1.00	1.00
PHF Adj:	1.00	1.00	1.00	1.00	1.00	1.00	1.00	1.00	1.00	1.00	1.00	1.00
PHF Volume:	21	20	57	121	20	0	5	907	34	31	640	93
Reduct Vol:	0	0	0	0	0	0	0	0	0	0	0	0
Reduced Vol:	21	20	57	121	20	0	5	907	34	31	640	93
PCE Adj:	1.00	1.00	1.00	1.00	1.00	1.00	1.00	1.00	1.00	1.00	1.00	1.00
MLF Adj:	1.00	1.00	1.00	1.00	1.00	1.00	1.00	1.00	1.00	1.00	1.00	1.00
FinalVolume:	21	20	57	121	20	0	5	907	34	31	640	93
Saturation Flow Module:												
Sat/Lane:	1900	1900	1900	1900	1900	1900	1900	1900	1900	1900	1900	1900
Adjustment:	0.95	0.95	0.92	0.95	0.95	0.92	0.95	0.97	0.92	0.92	0.98	0.95
Lanes:	0.51	0.49	1.00	0.86	0.14	1.00	0.01	1.99	1.00	1.00	1.74	0.26
Final Sat.:	922	878	1750	1545	255	1750	20	3680	1750	1750	3230	469
Capacity Analysis Module:												
Vol/Sat:	0.02	0.02	0.03	0.08	0.08	0.00	0.25	0.25	0.02	0.02	0.20	0.20
Crit Moves:				****			****			****		
Green Time:	29.9	29.9	29.9	29.9	29.9	0.0	94.1	94.1	94.1	7.0	101	101.1
Volume/Cap:	0.11	0.11	0.15	0.37	0.37	0.00	0.37	0.37	0.03	0.35	0.27	0.27
Delay/Veh:	44.4	44.4	44.9	47.6	47.6	0.0	10.1	10.1	7.7	66.8	6.8	6.8
User DelAdj:	1.00	1.00	1.00	1.00	1.00	1.00	1.00	1.00	1.00	1.00	1.00	1.00
AdjDel/Veh:	44.4	44.4	44.9	47.6	47.6	0.0	10.1	10.1	7.7	66.8	6.8	6.8
LOS by Move:	D	D	D	D	D	A	B	B	A	E	A	A
HCM2k95thQ:	3	3	4	11	11	0	16	16	1	3	11	11

Note: Queue reported is the number of cars per lane.

BART Phase II Extension Project

Level Of Service Computation Report
 2000 HCM Operations (Future Volume Alternative)
 AM - Existing Conditions

Intersection #4022: SANTA CLARA/26TH

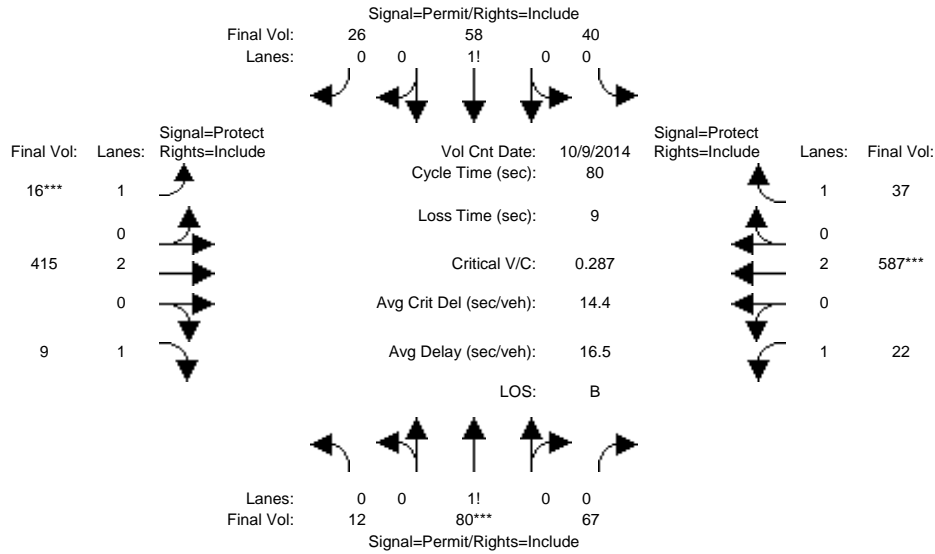

Approach:	North Bound			South Bound			East Bound			West Bound		
	L	T	R	L	T	R	L	T	R	L	T	R
Min. Green:	10	10	10	10	10	10	7	10	10	7	10	10
Y+R:	4.0	4.0	4.0	4.0	4.0	4.0	4.0	4.0	4.0	4.0	4.0	4.0
Volume Module: >> Count Date: 9 Oct 2014 <<												
Base Vol:	12	80	67	40	58	26	16	415	9	22	587	37
Growth Adj:	1.00	1.00	1.00	1.00	1.00	1.00	1.00	1.00	1.00	1.00	1.00	1.00
Initial Bse:	12	80	67	40	58	26	16	415	9	22	587	37
Added Vol:	0	0	0	0	0	0	0	0	0	0	0	0
PasserByVol:	0	0	0	0	0	0	0	0	0	0	0	0
Initial Fut:	12	80	67	40	58	26	16	415	9	22	587	37
User Adj:	1.00	1.00	1.00	1.00	1.00	1.00	1.00	1.00	1.00	1.00	1.00	1.00
PHF Adj:	1.00	1.00	1.00	1.00	1.00	1.00	1.00	1.00	1.00	1.00	1.00	1.00
PHF Volume:	12	80	67	40	58	26	16	415	9	22	587	37
Reduct Vol:	0	0	0	0	0	0	0	0	0	0	0	0
Reduced Vol:	12	80	67	40	58	26	16	415	9	22	587	37
PCE Adj:	1.00	1.00	1.00	1.00	1.00	1.00	1.00	1.00	1.00	1.00	1.00	1.00
MLF Adj:	1.00	1.00	1.00	1.00	1.00	1.00	1.00	1.00	1.00	1.00	1.00	1.00
FinalVolume:	12	80	67	40	58	26	16	415	9	22	587	37
Saturation Flow Module:												
Sat/Lane:	1900	1900	1900	1900	1900	1900	1900	1900	1900	1900	1900	1900
Adjustment:	0.92	0.92	0.92	0.92	0.92	0.92	0.92	1.00	0.92	0.92	1.00	0.92
Lanes:	0.08	0.50	0.42	0.32	0.47	0.21	1.00	2.00	1.00	1.00	2.00	1.00
Final Sat.:	132	881	737	565	819	367	1750	3800	1750	1750	3800	1750
Capacity Analysis Module:												
Vol/Sat:	0.09	0.09	0.09	0.07	0.07	0.07	0.01	0.11	0.01	0.01	0.15	0.02
Crit Moves:	****						****			****		
Green Time:	23.7	23.7	23.7	23.7	23.7	23.7	7.0	27.8	27.8	19.5	40.3	40.3
Volume/Cap:	0.31	0.31	0.31	0.24	0.24	0.24	0.10	0.31	0.01	0.05	0.31	0.04
Delay/Veh:	22.1	22.1	22.1	21.6	21.6	21.6	33.9	19.2	17.1	23.2	11.7	10.1
User DelAdj:	1.00	1.00	1.00	1.00	1.00	1.00	1.00	1.00	1.00	1.00	1.00	1.00
AdjDel/Veh:	22.1	22.1	22.1	21.6	21.6	21.6	33.9	19.2	17.1	23.2	11.7	10.1
LOS by Move:	C	C	C	C	C	C	C	B	B	C	B	B
HCM2k95thQ:	7	7	7	5	5	5	1	7	0	1	8	1

Note: Queue reported is the number of cars per lane.

BART Phase II Extension Project

Level Of Service Computation Report
2000 HCM Operations (Future Volume Alternative)
PM - Existing Conditions

Intersection #4022: SANTA CLARA/26TH

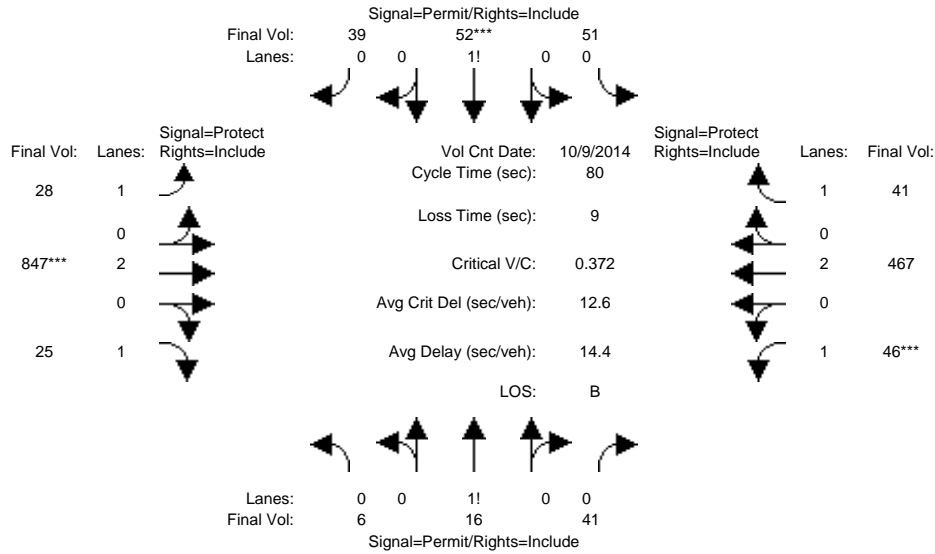

Approach:	North Bound			South Bound			East Bound			West Bound		
	L	T	R	L	T	R	L	T	R	L	T	R
Min. Green:	10	10	10	10	10	10	7	10	10	7	10	10
Y+R:	4.0	4.0	4.0	4.0	4.0	4.0	4.0	4.0	4.0	4.0	4.0	4.0
Volume Module: >> Count Date: 9 Oct 2014 <<												
Base Vol:	6	16	41	51	52	39	28	847	25	46	467	41
Growth Adj:	1.00	1.00	1.00	1.00	1.00	1.00	1.00	1.00	1.00	1.00	1.00	1.00
Initial Bse:	6	16	41	51	52	39	28	847	25	46	467	41
Added Vol:	0	0	0	0	0	0	0	0	0	0	0	0
PasserByVol:	0	0	0	0	0	0	0	0	0	0	0	0
Initial Fut:	6	16	41	51	52	39	28	847	25	46	467	41
User Adj:	1.00	1.00	1.00	1.00	1.00	1.00	1.00	1.00	1.00	1.00	1.00	1.00
PHF Adj:	1.00	1.00	1.00	1.00	1.00	1.00	1.00	1.00	1.00	1.00	1.00	1.00
PHF Volume:	6	16	41	51	52	39	28	847	25	46	467	41
Reduct Vol:	0	0	0	0	0	0	0	0	0	0	0	0
Reduced Vol:	6	16	41	51	52	39	28	847	25	46	467	41
PCE Adj:	1.00	1.00	1.00	1.00	1.00	1.00	1.00	1.00	1.00	1.00	1.00	1.00
MLF Adj:	1.00	1.00	1.00	1.00	1.00	1.00	1.00	1.00	1.00	1.00	1.00	1.00
FinalVolume:	6	16	41	51	52	39	28	847	25	46	467	41
Saturation Flow Module:												
Sat/Lane:	1900	1900	1900	1900	1900	1900	1900	1900	1900	1900	1900	1900
Adjustment:	0.92	0.92	0.92	0.92	0.92	0.92	0.92	1.00	0.92	0.92	1.00	0.92
Lanes:	0.10	0.25	0.65	0.36	0.37	0.27	1.00	2.00	1.00	1.00	2.00	1.00
Final Sat.:	167	444	1139	629	641	481	1750	3800	1750	1750	3800	1750
Capacity Analysis Module:												
Vol/Sat:	0.04	0.04	0.04	0.08	0.08	0.08	0.02	0.22	0.01	0.03	0.12	0.02
Crit Moves:				****			****			****		
Green Time:	17.1	17.1	17.1	17.1	17.1	17.1	22.2	46.9	46.9	7.0	31.7	31.7
Volume/Cap:	0.17	0.17	0.17	0.38	0.38	0.38	0.06	0.38	0.02	0.30	0.31	0.06
Delay/Veh:	25.9	25.9	25.9	27.6	27.6	27.6	21.3	8.9	6.9	35.3	16.7	15.0
User DelAdj:	1.00	1.00	1.00	1.00	1.00	1.00	1.00	1.00	1.00	1.00	1.00	1.00
AdjDel/Veh:	25.9	25.9	25.9	27.6	27.6	27.6	21.3	8.9	6.9	35.3	16.7	15.0
LOS by Move:	C	C	C	C	C	C	C	A	A	D	B	B
HCM2k95thQ:	3	3	3	7	7	7	1	11	1	2	8	1

Note: Queue reported is the number of cars per lane.

BART Phase II Extension Project

Level Of Service Computation Report
 2000 HCM Operations (Future Volume Alternative)
 AM - 2025 No Project Conditions

Intersection #3016: 101/ALUM ROCK

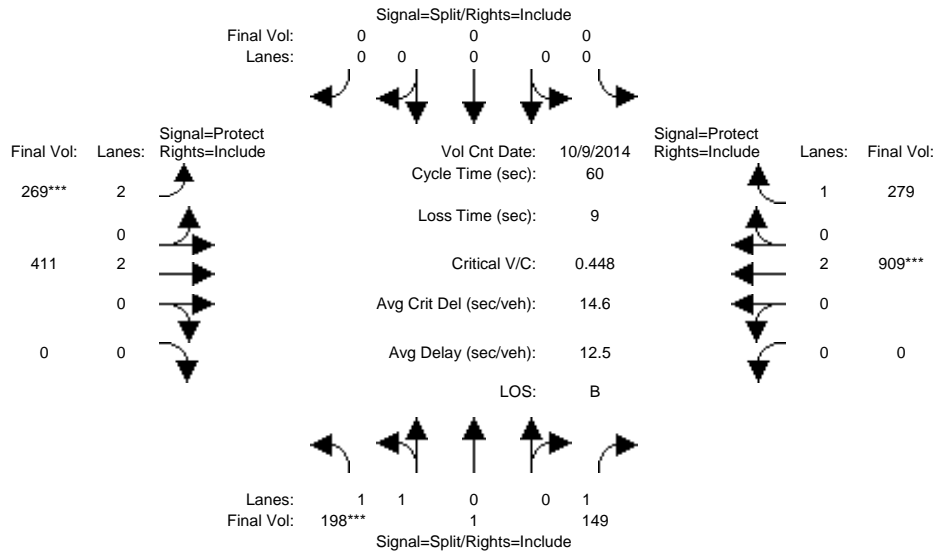

Approach:	North Bound			South Bound			East Bound			West Bound		
	L	T	R	L	T	R	L	T	R	L	T	R
Min. Green:	10	10	10	0	0	0	7	10	0	0	10	10
Y+R:	4.0	4.0	4.0	4.0	4.0	4.0	4.0	4.0	4.0	4.0	4.0	4.0

Volume Module:	>>	Count	Date:	9 Oct 2014	<<												
Base Vol:	198	1	149	0	0	0	269	411	0	0	909	279					
Growth Adj:	1.00	1.00	1.00	1.00	1.00	1.00	1.00	1.00	1.00	1.00	1.00	1.00					
Initial Bse:	198	1	149	0	0	0	269	411	0	0	909	279					
Added Vol:	0	0	0	0	0	0	0	0	0	0	0	0					
PasserByVol:	0	0	0	0	0	0	0	0	0	0	0	0					
Initial Fut:	198	1	149	0	0	0	269	411	0	0	909	279					
User Adj:	1.00	1.00	1.00	1.00	1.00	1.00	1.00	1.00	1.00	1.00	1.00	1.00					
PHF Adj:	1.00	1.00	1.00	1.00	1.00	1.00	1.00	1.00	1.00	1.00	1.00	1.00					
PHF Volume:	198	1	149	0	0	0	269	411	0	0	909	279					
Reduct Vol:	0	0	0	0	0	0	0	0	0	0	0	0					
Reduced Vol:	198	1	149	0	0	0	269	411	0	0	909	279					
PCE Adj:	1.00	1.00	1.00	1.00	1.00	1.00	1.00	1.00	1.00	1.00	1.00	1.00					
MLF Adj:	1.00	1.00	1.00	1.00	1.00	1.00	1.00	1.00	1.00	1.00	1.00	1.00					
Final Volume:	198	1	149	0	0	0	269	411	0	0	909	279					

Saturation Flow Module:												
Sat/Lane:	1900	1900	1900	1900	1900	1900	1900	1900	1900	1900	1900	1900
Adjustment:	0.93	0.95	0.92	0.92	1.00	0.92	0.83	1.00	0.92	0.92	1.00	0.92
Lanes:	1.99	0.01	1.00	0.00	0.00	0.00	2.00	2.00	0.00	0.00	2.00	1.00
Final Sat.:	3532	18	1750	0	0	0	3150	3800	0	0	3800	1750

Capacity Analysis Module:												
Vol/Sat:	0.06	0.06	0.09	0.00	0.00	0.00	0.09	0.11	0.00	0.00	0.24	0.16
Crit Moves:	****						****				****	
Green Time:	11.4	11.4	11.4	0.0	0.0	0.0	10.4	39.6	0.0	0.0	29.2	29.2
Volume/Cap:	0.29	0.29	0.45	0.00	0.00	0.00	0.49	0.16	0.00	0.00	0.49	0.33
Delay/Veh:	21.1	21.1	22.5	0.0	0.0	0.0	23.1	3.9	0.0	0.0	10.6	9.6
User DelAdj:	1.00	1.00	1.00	1.00	1.00	1.00	1.00	1.00	1.00	1.00	1.00	1.00
AdjDel/Veh:	21.1	21.1	22.5	0.0	0.0	0.0	23.1	3.9	0.0	0.0	10.6	9.6
LOS by Move:	C	C	C	A	A	A	C	A	A	A	B	A
HCM2k95thQ:	4	4	6	0	0	0	5	3	0	0	11	7

Note: Queue reported is the number of cars per lane.

BART Phase II Extension Project

Level Of Service Computation Report
2000 HCM Operations (Future Volume Alternative)
PM - 2025 No Project Conditions

Intersection #3016: 101/ALUM ROCK

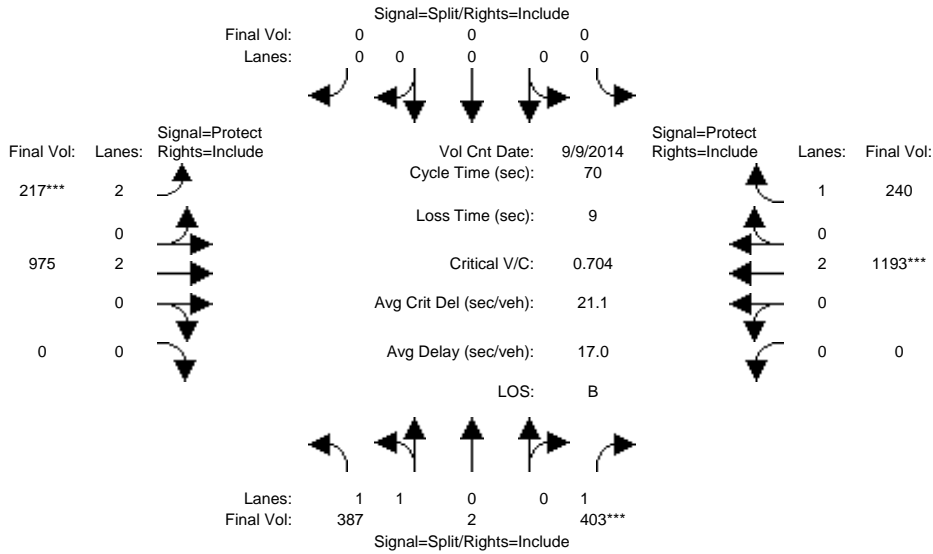

Approach:	North Bound			South Bound			East Bound			West Bound		
	L	T	R	L	T	R	L	T	R	L	T	R
Min. Green:	10	10	10	0	0	0	7	10	0	0	10	10
Y+R:	4.0	4.0	4.0	4.0	4.0	4.0	4.0	4.0	4.0	4.0	4.0	4.0
Volume Module: >> Count Date: 9 Sep 2014 <<												
Base Vol:	387	2	403	0	0	0	217	975	0	0	1193	240
Growth Adj:	1.00	1.00	1.00	1.00	1.00	1.00	1.00	1.00	1.00	1.00	1.00	1.00
Initial Bse:	387	2	403	0	0	0	217	975	0	0	1193	240
Added Vol:	0	0	0	0	0	0	0	0	0	0	0	0
PasserByVol:	0	0	0	0	0	0	0	0	0	0	0	0
Initial Fut:	387	2	403	0	0	0	217	975	0	0	1193	240
User Adj:	1.00	1.00	1.00	1.00	1.00	1.00	1.00	1.00	1.00	1.00	1.00	1.00
PHF Adj:	1.00	1.00	1.00	1.00	1.00	1.00	1.00	1.00	1.00	1.00	1.00	1.00
PHF Volume:	387	2	403	0	0	0	217	975	0	0	1193	240
Reduct Vol:	0	0	0	0	0	0	0	0	0	0	0	0
Reduced Vol:	387	2	403	0	0	0	217	975	0	0	1193	240
PCE Adj:	1.00	1.00	1.00	1.00	1.00	1.00	1.00	1.00	1.00	1.00	1.00	1.00
MLF Adj:	1.00	1.00	1.00	1.00	1.00	1.00	1.00	1.00	1.00	1.00	1.00	1.00
FinalVolume:	387	2	403	0	0	0	217	975	0	0	1193	240
Saturation Flow Module:												
Sat/Lane:	1900	1900	1900	1900	1900	1900	1900	1900	1900	1900	1900	1900
Adjustment:	0.93	0.95	0.92	0.92	1.00	0.92	0.83	1.00	0.92	0.92	1.00	0.92
Lanes:	1.99	0.01	1.00	0.00	0.00	0.00	2.00	2.00	0.00	0.00	2.00	1.00
Final Sat.:	3532	18	1750	0	0	0	3150	3800	0	0	3800	1750
Capacity Analysis Module:												
Vol/Sat:	0.11	0.11	0.23	0.00	0.00	0.00	0.07	0.26	0.00	0.00	0.31	0.14
Crit Moves:			****				****				****	
Green Time:	22.8	22.8	22.8	0.0	0.0	0.0	7.0	38.2	0.0	0.0	31.2	31.2
Volume/Cap:	0.34	0.34	0.71	0.00	0.00	0.00	0.69	0.47	0.00	0.00	0.71	0.31
Delay/Veh:	18.0	18.0	24.6	0.0	0.0	0.0	36.8	9.9	0.0	0.0	17.1	12.7
User DelAdj:	1.00	1.00	1.00	1.00	1.00	1.00	1.00	1.00	1.00	1.00	1.00	1.00
AdjDel/Veh:	18.0	18.0	24.6	0.0	0.0	0.0	36.8	9.9	0.0	0.0	17.1	12.7
LOS by Move:	B	B	C	A	A	A	D	A	A	A	B	B
HCM2k95thQ:	7	7	18	0	0	0	6	12	0	0	19	7

Note: Queue reported is the number of cars per lane.

BART Phase II Extension Project

Level Of Service Computation Report
 2000 HCM Operations (Future Volume Alternative)
 AM - 2025 No Project Conditions

Intersection #3023: 101/SANTA CLARA

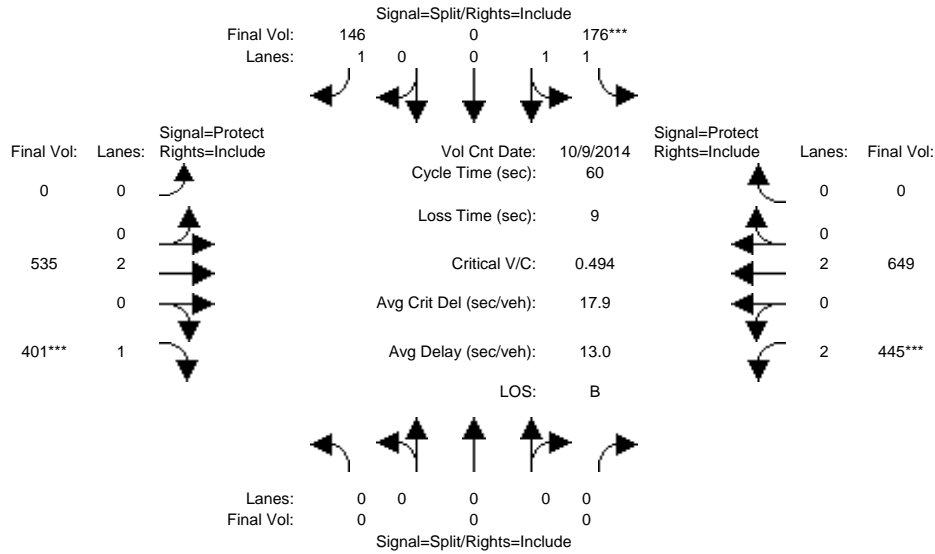

Approach:	North Bound			South Bound			East Bound			West Bound		
	L	T	R	L	T	R	L	T	R	L	T	R
Min. Green:	0	0	0	10	10	10	0	10	10	7	10	0
Y+R:	4.0	4.0	4.0	4.0	4.0	4.0	4.0	4.0	4.0	4.0	4.0	4.0
Volume Module: >> Count Date: 9 Oct 2014 <<												
Base Vol:	0	0	0	176	0	146	0	535	401	445	649	0
Growth Adj:	1.00	1.00	1.00	1.00	1.00	1.00	1.00	1.00	1.00	1.00	1.00	1.00
Initial Bse:	0	0	0	176	0	146	0	535	401	445	649	0
Added Vol:	0	0	0	0	0	0	0	0	0	0	0	0
PasserByVol:	0	0	0	0	0	0	0	0	0	0	0	0
Initial Fut:	0	0	0	176	0	146	0	535	401	445	649	0
User Adj:	1.00	1.00	1.00	1.00	1.00	1.00	1.00	1.00	1.00	1.00	1.00	1.00
PHF Adj:	1.00	1.00	1.00	1.00	1.00	1.00	1.00	1.00	1.00	1.00	1.00	1.00
PHF Volume:	0	0	0	176	0	146	0	535	401	445	649	0
Reduct Vol:	0	0	0	0	0	0	0	0	0	0	0	0
Reduced Vol:	0	0	0	176	0	146	0	535	401	445	649	0
PCE Adj:	1.00	1.00	1.00	1.00	1.00	1.00	1.00	1.00	1.00	1.00	1.00	1.00
MLF Adj:	1.00	1.00	1.00	1.00	1.00	1.00	1.00	1.00	1.00	1.00	1.00	1.00
FinalVolume:	0	0	0	176	0	146	0	535	401	445	649	0
Saturation Flow Module:												
Sat/Lane:	1900	1900	1900	1900	1900	1900	1900	1900	1900	1900	1900	1900
Adjustment:	0.92	1.00	0.92	0.93	1.00	0.92	0.92	1.00	0.92	0.83	1.00	0.92
Lanes:	0.00	0.00	0.00	2.00	0.00	1.00	0.00	2.00	1.00	2.00	2.00	0.00
Final Sat.:	0	0	0	3550	0	1750	0	3800	1750	3150	3800	0
Capacity Analysis Module:												
Vol/Sat:	0.00	0.00	0.00	0.05	0.00	0.08	0.00	0.14	0.23	0.14	0.17	0.00
Crit Moves:				****				****			****	
Green Time:	0.0	0.0	0.0	10.1	0.0	10.1	0.0	25.3	25.3	15.6	40.9	0.0
Volume/Cap:	0.00	0.00	0.00	0.29	0.00	0.49	0.00	0.33	0.54	0.54	0.25	0.00
Delay/Veh:	0.0	0.0	0.0	22.1	0.0	23.9	0.0	11.8	13.9	19.9	3.7	0.0
User DelAdj:	1.00	1.00	1.00	1.00	1.00	1.00	1.00	1.00	1.00	1.00	1.00	1.00
AdjDel/Veh:	0.0	0.0	0.0	22.1	0.0	23.9	0.0	11.8	13.9	19.9	3.7	0.0
LOS by Move:	A	A	A	C	A	C	A	B	B	B	A	A
HCM2k95thQ:	0	0	0	4	0	7	0	6	11	8	5	0

Note: Queue reported is the number of cars per lane.

BART Phase II Extension Project

Level Of Service Computation Report
2000 HCM Operations (Future Volume Alternative)
PM - 2025 No Project Conditions

Intersection #3023: 101/SANTA CLARA

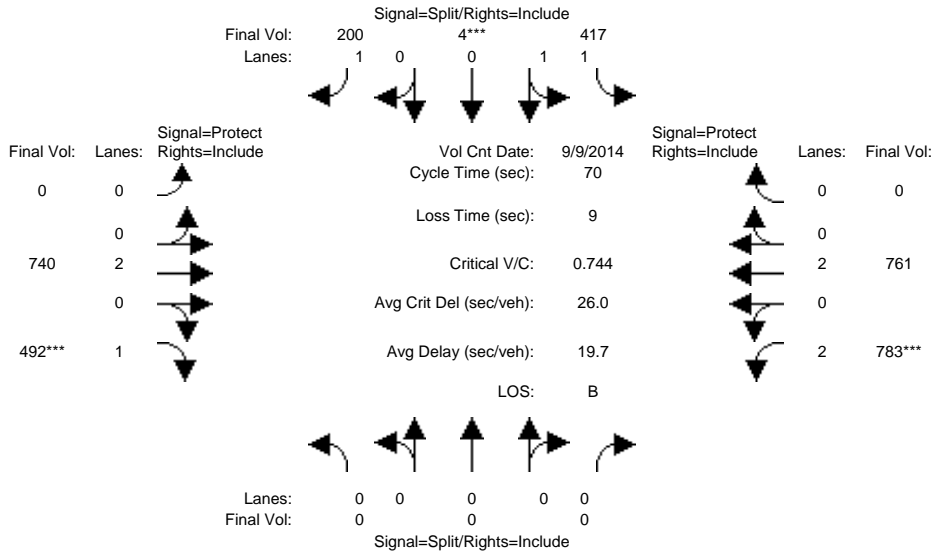

Approach:	North Bound			South Bound			East Bound			West Bound		
Movement:	L	T	R	L	T	R	L	T	R	L	T	R
Min. Green:	0	0	0	10	10	10	0	10	10	7	10	0
Y+R:	4.0	4.0	4.0	4.0	4.0	4.0	4.0	4.0	4.0	4.0	4.0	4.0
Volume Module: >> Count Date: 9 Sep 2014 <<												
Base Vol:	0	0	0	417	4	200	0	740	492	783	761	0
Growth Adj:	1.00	1.00	1.00	1.00	1.00	1.00	1.00	1.00	1.00	1.00	1.00	1.00
Initial Bse:	0	0	0	417	4	200	0	740	492	783	761	0
Added Vol:	0	0	0	0	0	0	0	0	0	0	0	0
PasserByVol:	0	0	0	0	0	0	0	0	0	0	0	0
Initial Fut:	0	0	0	417	4	200	0	740	492	783	761	0
User Adj:	1.00	1.00	1.00	1.00	1.00	1.00	1.00	1.00	1.00	1.00	1.00	1.00
PHF Adj:	1.00	1.00	1.00	1.00	1.00	1.00	1.00	1.00	1.00	1.00	1.00	1.00
PHF Volume:	0	0	0	417	4	200	0	740	492	783	761	0
Reduct Vol:	0	0	0	0	0	0	0	0	0	0	0	0
Reduced Vol:	0	0	0	417	4	200	0	740	492	783	761	0
PCE Adj:	1.00	1.00	1.00	1.00	1.00	1.00	1.00	1.00	1.00	1.00	1.00	1.00
MLF Adj:	1.00	1.00	1.00	1.00	1.00	1.00	1.00	1.00	1.00	1.00	1.00	1.00
FinalVolume:	0	0	0	417	4	200	0	740	492	783	761	0
Saturation Flow Module:												
Sat/Lane:	1900	1900	1900	1900	1900	1900	1900	1900	1900	1900	1900	1900
Adjustment:	0.92	1.00	0.92	0.93	0.95	0.92	0.92	1.00	0.92	0.83	1.00	0.92
Lanes:	0.00	0.00	0.00	1.98	0.02	1.00	0.00	2.00	1.00	2.00	2.00	0.00
Final Sat.:	0	0	0	3516	34	1750	0	3800	1750	3150	3800	0
Capacity Analysis Module:												
Vol/Sat:	0.00	0.00	0.00	0.12	0.12	0.11	0.00	0.19	0.28	0.25	0.20	0.00
Crit Moves:				****			****			****		
Green Time:	0.0	0.0	0.0	11.2	11.2	11.2	0.0	26.5	26.5	23.4	49.8	0.0
Volume/Cap:	0.00	0.00	0.00	0.74	0.74	0.72	0.00	0.52	0.74	0.74	0.28	0.00
Delay/Veh:	0.0	0.0	0.0	33.4	33.4	36.6	0.0	17.1	23.4	23.6	3.7	0.0
User DelAdj:	1.00	1.00	1.00	1.00	1.00	1.00	1.00	1.00	1.00	1.00	1.00	1.00
AdjDel/Veh:	0.0	0.0	0.0	33.4	33.4	36.6	0.0	17.1	23.4	23.6	3.7	0.0
LOS by Move:	A	A	A	C	C	D	A	B	C	C	A	A
HCM2k95thQ:	0	0	0	13	13	12	0	12	19	17	6	0

Note: Queue reported is the number of cars per lane.

BART Phase II Extension Project

Level Of Service Computation Report
 2000 HCM Operations (Future Volume Alternative)
 AM - 2025 No Project Conditions

Intersection #3036: 280/MCLAUGHLIN

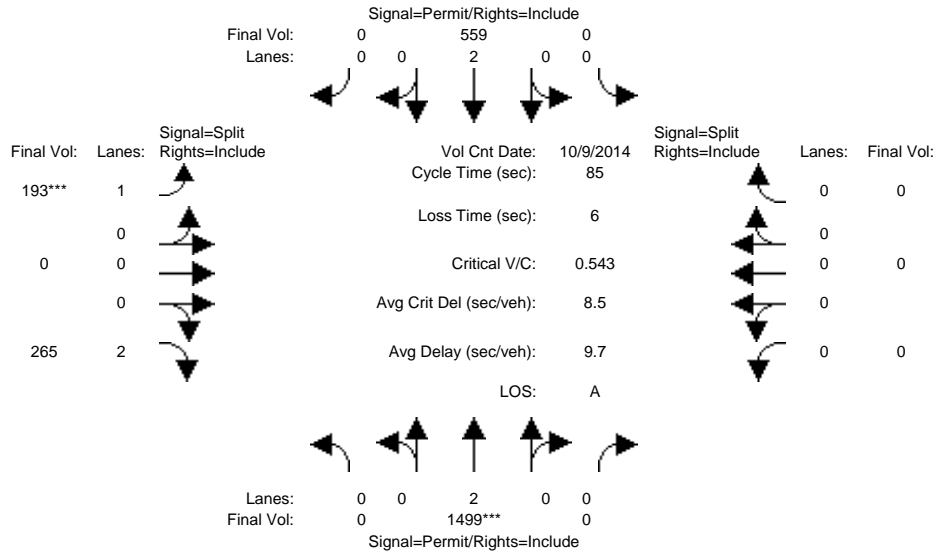

Approach:	North Bound			South Bound			East Bound			West Bound		
Movement:	L	T	R	L	T	R	L	T	R	L	T	R
Min. Green:	0	10	0	0	10	0	10	0	10	0	0	0
Y+R:	4.0	4.0	4.0	4.0	4.0	4.0	4.0	4.0	4.0	4.0	4.0	4.0
Volume Module: >> Count Date: 9 Oct 2014 <<												
Base Vol:	0	1499	0	0	559	0	193	0	265	0	0	0
Growth Adj:	1.00	1.00	1.00	1.00	1.00	1.00	1.00	1.00	1.00	1.00	1.00	1.00
Initial Bse:	0	1499	0	0	559	0	193	0	265	0	0	0
Added Vol:	0	0	0	0	0	0	0	0	0	0	0	0
PasserByVol:	0	0	0	0	0	0	0	0	0	0	0	0
Initial Fut:	0	1499	0	0	559	0	193	0	265	0	0	0
User Adj:	1.00	1.00	1.00	1.00	1.00	1.00	1.00	1.00	1.00	1.00	1.00	1.00
PHF Adj:	1.00	1.00	1.00	1.00	1.00	1.00	1.00	1.00	1.00	1.00	1.00	1.00
PHF Volume:	0	1499	0	0	559	0	193	0	265	0	0	0
Reduct Vol:	0	0	0	0	0	0	0	0	0	0	0	0
Reduced Vol:	0	1499	0	0	559	0	193	0	265	0	0	0
PCE Adj:	1.00	1.00	1.00	1.00	1.00	1.00	1.00	1.00	1.00	1.00	1.00	1.00
MLF Adj:	1.00	1.00	1.00	1.00	1.00	1.00	1.00	1.00	1.00	1.00	1.00	1.00
FinalVolume:	0	1499	0	0	559	0	193	0	265	0	0	0
Saturation Flow Module:												
Sat/Lane:	1900	1900	1900	1900	1900	1900	1900	1900	1900	1900	1900	1900
Adjustment:	0.92	1.00	0.92	0.92	1.00	0.92	0.92	1.00	0.83	0.92	1.00	0.92
Lanes:	0.00	2.00	0.00	0.00	2.00	0.00	1.00	0.00	2.00	0.00	0.00	0.00
Final Sat.:	0	3800	0	0	3800	0	1750	0	3150	0	0	0
Capacity Analysis Module:												
Vol/Sat:	0.00	0.39	0.00	0.00	0.15	0.00	0.11	0.00	0.08	0.00	0.00	0.00
Crit Moves:	****			****			****			****		
Green Time:	0.0	61.7	0.0	0.0	61.7	0.0	17.3	0.0	17.3	0.0	0.0	0.0
Volume/Cap:	0.00	0.54	0.00	0.00	0.20	0.00	0.54	0.00	0.41	0.00	0.00	0.00
Delay/Veh:	0.0	5.5	0.0	0.0	3.8	0.0	32.1	0.0	29.9	0.0	0.0	0.0
User DelAdj:	1.00	1.00	1.00	1.00	1.00	1.00	1.00	1.00	1.00	1.00	1.00	1.00
AdjDel/Veh:	0.0	5.5	0.0	0.0	3.8	0.0	32.1	0.0	29.9	0.0	0.0	0.0
LOS by Move:	A	A	A	A	A	A	C	A	C	A	A	A
HCM2k95thQ:	0	17	0	0	5	0	11	0	8	0	0	0

Note: Queue reported is the number of cars per lane.

BART Phase II Extension Project

Level Of Service Computation Report
 2000 HCM Operations (Future Volume Alternative)
 PM - 2025 No Project Conditions

Intersection #3036: 280/MCLAUGHLIN

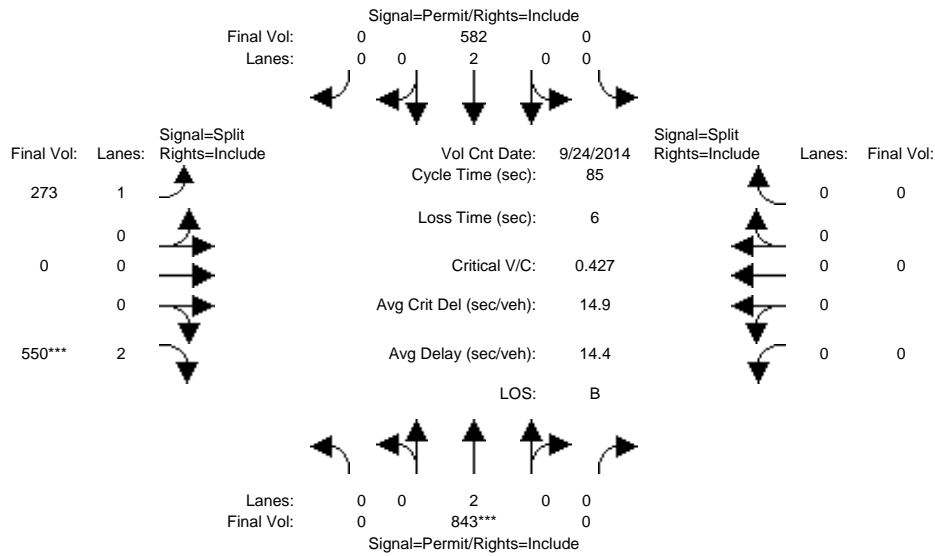

Approach:	North Bound			South Bound			East Bound			West Bound		
	L	T	R	L	T	R	L	T	R	L	T	R
Min. Green:	0	10	0	0	10	0	10	0	10	0	0	0
Y+R:	4.0	4.0	4.0	4.0	4.0	4.0	4.0	4.0	4.0	4.0	4.0	4.0
Volume Module: >> Count Date: 24 Sep 2014 <<												
Base Vol:	0	843	0	0	582	0	273	0	550	0	0	0
Growth Adj:	1.00	1.00	1.00	1.00	1.00	1.00	1.00	1.00	1.00	1.00	1.00	1.00
Initial Bse:	0	843	0	0	582	0	273	0	550	0	0	0
Added Vol:	0	0	0	0	0	0	0	0	0	0	0	0
PasserByVol:	0	0	0	0	0	0	0	0	0	0	0	0
Initial Fut:	0	843	0	0	582	0	273	0	550	0	0	0
User Adj:	1.00	1.00	1.00	1.00	1.00	1.00	1.00	1.00	1.00	1.00	1.00	1.00
PHF Adj:	1.00	1.00	1.00	1.00	1.00	1.00	1.00	1.00	1.00	1.00	1.00	1.00
PHF Volume:	0	843	0	0	582	0	273	0	550	0	0	0
Reduct Vol:	0	0	0	0	0	0	0	0	0	0	0	0
Reduced Vol:	0	843	0	0	582	0	273	0	550	0	0	0
PCE Adj:	1.00	1.00	1.00	1.00	1.00	1.00	1.00	1.00	1.00	1.00	1.00	1.00
MLF Adj:	1.00	1.00	1.00	1.00	1.00	1.00	1.00	1.00	1.00	1.00	1.00	1.00
FinalVolume:	0	843	0	0	582	0	273	0	550	0	0	0
Saturation Flow Module:												
Sat/Lane:	1900	1900	1900	1900	1900	1900	1900	1900	1900	1900	1900	1900
Adjustment:	0.92	1.00	0.92	0.92	1.00	0.92	0.92	1.00	0.83	0.92	1.00	0.92
Lanes:	0.00	2.00	0.00	0.00	2.00	0.00	1.00	0.00	2.00	0.00	0.00	0.00
Final Sat.:	0	3800	0	0	3800	0	1750	0	3150	0	0	0
Capacity Analysis Module:												
Vol/Sat:	0.00	0.22	0.00	0.00	0.15	0.00	0.16	0.00	0.17	0.00	0.00	0.00
Crit Moves:	****						****					
Green Time:	0.0	44.2	0.0	0.0	44.2	0.0	34.8	0.0	34.8	0.0	0.0	0.0
Volume/Cap:	0.00	0.43	0.00	0.00	0.29	0.00	0.38	0.00	0.43	0.00	0.00	0.00
Delay/Veh:	0.0	12.7	0.0	0.0	11.6	0.0	17.9	0.0	18.2	0.0	0.0	0.0
User DelAdj:	1.00	1.00	1.00	1.00	1.00	1.00	1.00	1.00	1.00	1.00	1.00	1.00
AdjDel/Veh:	0.0	12.7	0.0	0.0	11.6	0.0	17.9	0.0	18.2	0.0	0.0	0.0
LOS by Move:	A	B	A	A	B	A	B	A	B	A	A	A
HCM2k95thQ:	0	13	0	0	8	0	11	0	12	0	0	0

Note: Queue reported is the number of cars per lane.

BART Phase II Extension Project

Level Of Service Computation Report
 2000 HCM Operations (Future Volume Alternative)
 AM - 2025 No Project Conditions

Intersection #3210: 101/JULIAN

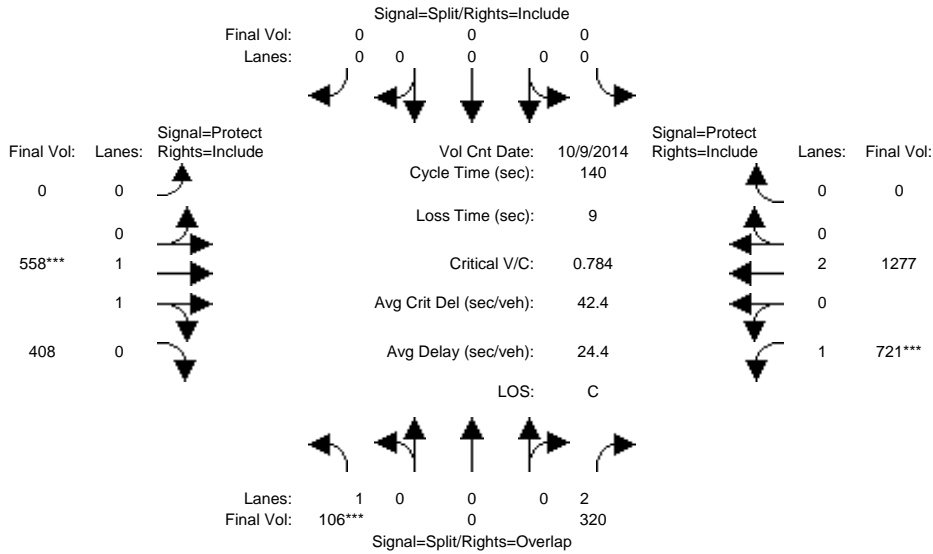

Approach:	North Bound			South Bound			East Bound			West Bound		
Movement:	L	T	R	L	T	R	L	T	R	L	T	R
Min. Green:	10	0	10	0	0	0	0	10	10	7	10	0
Y+R:	4.0	4.0	4.0	4.0	4.0	4.0	4.0	4.0	4.0	4.0	4.0	4.0
Volume Module: >> Count Date: 9 Oct 2014 <<												
Base Vol:	106	0	320	0	0	0	0	558	408	721	1277	0
Growth Adj:	1.00	1.00	1.00	1.00	1.00	1.00	1.00	1.00	1.00	1.00	1.00	1.00
Initial Bse:	106	0	320	0	0	0	0	558	408	721	1277	0
Added Vol:	0	0	0	0	0	0	0	0	0	0	0	0
PasserByVol:	0	0	0	0	0	0	0	0	0	0	0	0
Initial Fut:	106	0	320	0	0	0	0	558	408	721	1277	0
User Adj:	1.00	1.00	1.00	1.00	1.00	1.00	1.00	1.00	1.00	1.00	1.00	1.00
PHF Adj:	1.00	1.00	1.00	1.00	1.00	1.00	1.00	1.00	1.00	1.00	1.00	1.00
PHF Volume:	106	0	320	0	0	0	0	558	408	721	1277	0
Reduct Vol:	0	0	0	0	0	0	0	0	0	0	0	0
Reduced Vol:	106	0	320	0	0	0	0	558	408	721	1277	0
PCE Adj:	1.00	1.00	1.00	1.00	1.00	1.00	1.00	1.00	1.00	1.00	1.00	1.00
MLF Adj:	1.00	1.00	1.00	1.00	1.00	1.00	1.00	1.00	1.00	1.00	1.00	1.00
FinalVolume:	106	0	320	0	0	0	0	558	408	721	1277	0
Saturation Flow Module:												
Sat/Lane:	1900	1900	1900	1900	1900	1900	1900	1900	1900	1900	1900	1900
Adjustment:	0.92	1.00	0.83	0.92	1.00	0.92	0.92	0.99	0.95	0.92	1.00	0.92
Lanes:	1.00	0.00	2.00	0.00	0.00	0.00	0.00	1.13	0.87	1.00	2.00	0.00
Final Sat.:	1750	0	3150	0	0	0	0	2136	1562	1750	3800	0
Capacity Analysis Module:												
Vol/Sat:	0.06	0.00	0.10	0.00	0.00	0.00	0.00	0.26	0.26	0.41	0.34	0.00
Crit Moves:	****							****		****		
Green Time:	10.8	0.0	84.4	0.0	0.0	0.0	0.0	46.6	46.6	73.6	120	0.0
Volume/Cap:	0.78	0.00	0.17	0.00	0.00	0.00	0.00	0.78	0.78	0.78	0.39	0.00
Delay/Veh:	88.7	0.0	12.3	0.0	0.0	0.0	0.0	45.5	45.5	31.3	2.2	0.0
User DelAdj:	1.00	1.00	1.00	1.00	1.00	1.00	1.00	1.00	1.00	1.00	1.00	1.00
AdjDel/Veh:	88.7	0.0	12.3	0.0	0.0	0.0	0.0	45.5	45.5	31.3	2.2	0.0
LOS by Move:	F	A	B	A	A	A	A	D	D	C	A	A
HCM2k95thQ:	13	0	7	0	0	0	0	33	33	45	11	0

Note: Queue reported is the number of cars per lane.

BART Phase II Extension Project

Level Of Service Computation Report
 2000 HCM Operations (Future Volume Alternative)
 PM - 2025 No Project Conditions

Intersection #3210: 101/JULIAN

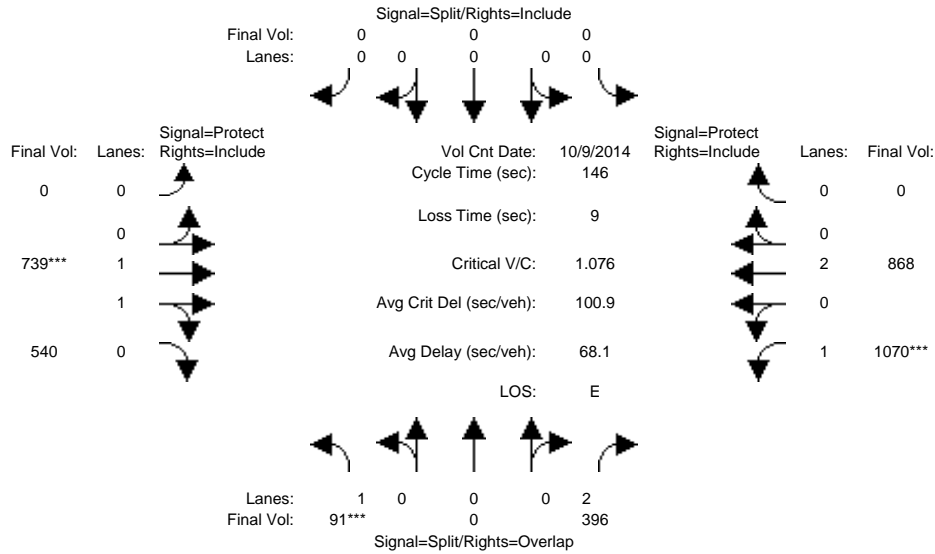

Approach:	North Bound			South Bound			East Bound			West Bound		
Movement:	L	T	R	L	T	R	L	T	R	L	T	R
Min. Green:	10	0	10	0	0	0	0	10	10	7	10	0
Y+R:	4.0	4.0	4.0	4.0	4.0	4.0	4.0	4.0	4.0	4.0	4.0	4.0
Volume Module: >> Count Date: 9 Oct 2014 <<												
Base Vol:	91	0	396	0	0	0	0	739	540	1070	868	0
Growth Adj:	1.00	1.00	1.00	1.00	1.00	1.00	1.00	1.00	1.00	1.00	1.00	1.00
Initial Bse:	91	0	396	0	0	0	0	739	540	1070	868	0
Added Vol:	0	0	0	0	0	0	0	0	0	0	0	0
PasserByVol:	0	0	0	0	0	0	0	0	0	0	0	0
Initial Fut:	91	0	396	0	0	0	0	739	540	1070	868	0
User Adj:	1.00	1.00	1.00	1.00	1.00	1.00	1.00	1.00	1.00	1.00	1.00	1.00
PHF Adj:	1.00	1.00	1.00	1.00	1.00	1.00	1.00	1.00	1.00	1.00	1.00	1.00
PHF Volume:	91	0	396	0	0	0	0	739	540	1070	868	0
Reduct Vol:	0	0	0	0	0	0	0	0	0	0	0	0
Reduced Vol:	91	0	396	0	0	0	0	739	540	1070	868	0
PCE Adj:	1.00	1.00	1.00	1.00	1.00	1.00	1.00	1.00	1.00	1.00	1.00	1.00
MLF Adj:	1.00	1.00	1.00	1.00	1.00	1.00	1.00	1.00	1.00	1.00	1.00	1.00
FinalVolume:	91	0	396	0	0	0	0	739	540	1070	868	0
Saturation Flow Module:												
Sat/Lane:	1900	1900	1900	1900	1900	1900	1900	1900	1900	1900	1900	1900
Adjustment:	0.92	1.00	0.83	0.92	1.00	0.92	0.92	0.99	0.95	0.92	1.00	0.92
Lanes:	1.00	0.00	2.00	0.00	0.00	0.00	0.00	1.13	0.87	1.00	2.00	0.00
Final Sat.:	1750	0	3150	0	0	0	0	2137	1561	1750	3800	0
Capacity Analysis Module:												
Vol/Sat:	0.05	0.00	0.13	0.00	0.00	0.00	0.00	0.35	0.35	0.61	0.23	0.00
Crit Moves:	****							****		****		
Green Time:	10.0	0.0	91.1	0.0	0.0	0.0	0.0	45.9	45.9	81.1	127	0.0
Volume/Cap:	0.76	0.00	0.20	0.00	0.00	0.00	0.00	1.10	1.10	1.10	0.26	0.00
Delay/Veh:	90.9	0.0	11.9	0.0	0.0	0.0	0.0	108	108.4	92.8	1.6	0.0
User DelAdj:	1.00	1.00	1.00	1.00	1.00	1.00	1.00	1.00	1.00	1.00	1.00	1.00
AdjDel/Veh:	90.9	0.0	11.9	0.0	0.0	0.0	0.0	108	108.4	92.8	1.6	0.0
LOS by Move:	F	A	B	A	A	A	A	F	F	F	A	A
HCM2k95thQ:	12	0	9	0	0	0	0	60	60	102	7	0

Note: Queue reported is the number of cars per lane.

BART Phase II Extension Project

Level Of Service Computation Report
 2000 HCM Operations (Future Volume Alternative)
 AM - 2025 No Project Conditions

Intersection #3211: 101/McKee(E)

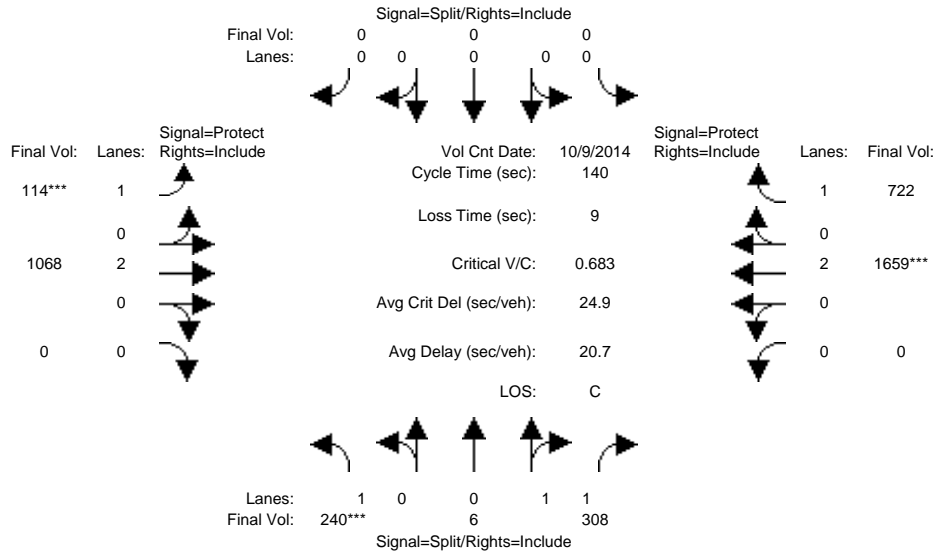

Approach:	North Bound			South Bound			East Bound			West Bound		
	L	T	R	L	T	R	L	T	R	L	T	R
Min. Green:	10	10	10	0	0	0	7	10	0	0	10	10
Y+R:	4.0	4.0	4.0	4.0	4.0	4.0	4.0	4.0	4.0	4.0	4.0	4.0
Volume Module: >> Count Date: 9 Oct 2014 <<												
Base Vol:	240	6	308	0	0	0	114	1068	0	0	1659	722
Growth Adj:	1.00	1.00	1.00	1.00	1.00	1.00	1.00	1.00	1.00	1.00	1.00	1.00
Initial Bse:	240	6	308	0	0	0	114	1068	0	0	1659	722
Added Vol:	0	0	0	0	0	0	0	0	0	0	0	0
PasserByVol:	0	0	0	0	0	0	0	0	0	0	0	0
Initial Fut:	240	6	308	0	0	0	114	1068	0	0	1659	722
User Adj:	1.00	1.00	1.00	1.00	1.00	1.00	1.00	1.00	1.00	1.00	1.00	1.00
PHF Adj:	1.00	1.00	1.00	1.00	1.00	1.00	1.00	1.00	1.00	1.00	1.00	1.00
PHF Volume:	240	6	308	0	0	0	114	1068	0	0	1659	722
Reduct Vol:	0	0	0	0	0	0	0	0	0	0	0	0
Reduced Vol:	240	6	308	0	0	0	114	1068	0	0	1659	722
PCE Adj:	1.00	1.00	1.00	1.00	1.00	1.00	1.00	1.00	1.00	1.00	1.00	1.00
MLF Adj:	1.00	1.00	1.00	1.00	1.00	1.00	1.00	1.00	1.00	1.00	1.00	1.00
FinalVolume:	240	6	308	0	0	0	114	1068	0	0	1659	722
Saturation Flow Module:												
Sat/Lane:	1900	1900	1900	1900	1900	1900	1900	1900	1900	1900	1900	1900
Adjustment:	0.92	0.95	0.95	0.92	1.00	0.92	0.92	1.00	0.92	0.92	1.00	0.92
Lanes:	1.00	0.04	1.96	0.00	0.00	0.00	1.00	2.00	0.00	0.00	2.00	1.00
Final Sat.:	1750	69	3531	0	0	0	1750	3800	0	0	3800	1750
Capacity Analysis Module:												
Vol/Sat:	0.14	0.09	0.09	0.00	0.00	0.00	0.07	0.28	0.00	0.00	0.44	0.41
Crit Moves:	****						****				****	
Green Time:	28.1	28.1	28.1	0.0	0.0	0.0	13.4	103	0.0	0.0	89.5	89.5
Volume/Cap:	0.68	0.43	0.43	0.00	0.00	0.00	0.68	0.38	0.00	0.00	0.68	0.65
Delay/Veh:	57.2	49.4	49.4	0.0	0.0	0.0	72.3	6.9	0.0	0.0	17.0	16.8
User DelAdj:	1.00	1.00	1.00	1.00	1.00	1.00	1.00	1.00	1.00	1.00	1.00	1.00
AdjDel/Veh:	57.2	49.4	49.4	0.0	0.0	0.0	72.3	6.9	0.0	0.0	17.0	16.8
LOS by Move:	E	D	D	A	A	A	E	A	A	A	B	B
HCM2k95thQ:	21	12	12	0	0	0	12	16	0	0	38	35

Note: Queue reported is the number of cars per lane.

BART Phase II Extension Project

Level Of Service Computation Report
 2000 HCM Operations (Future Volume Alternative)
 PM - 2025 No Project Conditions

Intersection #3211: 101/McKee(E)

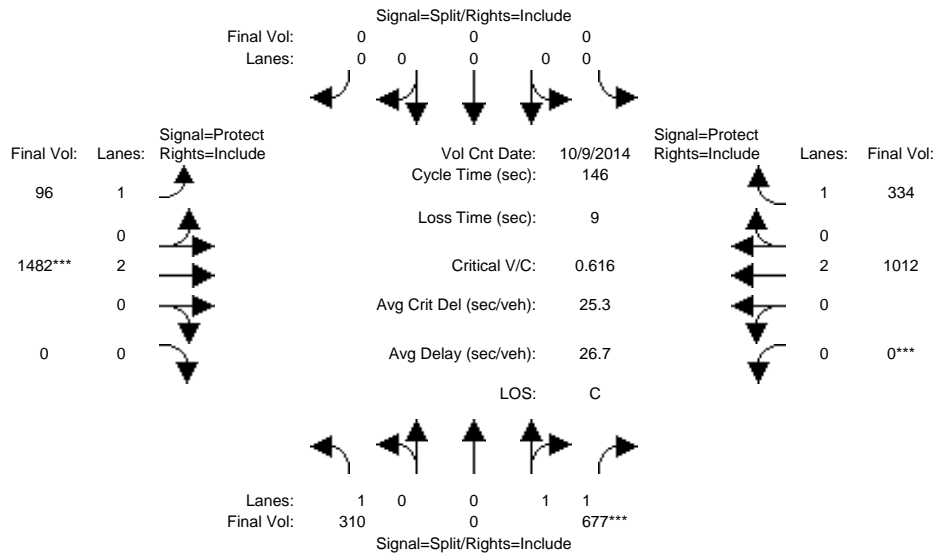

Approach:	North Bound			South Bound			East Bound			West Bound		
Movement:	L	T	R	L	T	R	L	T	R	L	T	R
Min. Green:	10	10	10	0	0	0	7	10	0	0	10	10
Y+R:	4.0	4.0	4.0	4.0	4.0	4.0	4.0	4.0	4.0	4.0	4.0	4.0
Volume Module: >> Count Date: 9 Oct 2014 <<												
Base Vol:	310	0	677	0	0	0	96	1482	0	0	1012	334
Growth Adj:	1.00	1.00	1.00	1.00	1.00	1.00	1.00	1.00	1.00	1.00	1.00	1.00
Initial Bse:	310	0	677	0	0	0	96	1482	0	0	1012	334
Added Vol:	0	0	0	0	0	0	0	0	0	0	0	0
PasserByVol:	0	0	0	0	0	0	0	0	0	0	0	0
Initial Fut:	310	0	677	0	0	0	96	1482	0	0	1012	334
User Adj:	1.00	1.00	1.00	1.00	1.00	1.00	1.00	1.00	1.00	1.00	1.00	1.00
PHF Adj:	1.00	1.00	1.00	1.00	1.00	1.00	1.00	1.00	1.00	1.00	1.00	1.00
PHF Volume:	310	0	677	0	0	0	96	1482	0	0	1012	334
Reduct Vol:	0	0	0	0	0	0	0	0	0	0	0	0
Reduced Vol:	310	0	677	0	0	0	96	1482	0	0	1012	334
PCE Adj:	1.00	1.00	1.00	1.00	1.00	1.00	1.00	1.00	1.00	1.00	1.00	1.00
MLF Adj:	1.00	1.00	1.00	1.00	1.00	1.00	1.00	1.00	1.00	1.00	1.00	1.00
FinalVolume:	310	0	677	0	0	0	96	1482	0	0	1012	334
Saturation Flow Module:												
Sat/Lane:	1900	1900	1900	1900	1900	1900	1900	1900	1900	1900	1900	1900
Adjustment:	0.92	1.00	0.95	0.92	1.00	0.92	0.92	1.00	0.92	0.92	1.00	0.92
Lanes:	1.00	0.00	2.00	0.00	0.00	0.00	1.00	2.00	0.00	0.00	2.00	1.00
Final Sat.:	1750	0	3600	0	0	0	1750	3800	0	0	3800	1750
Capacity Analysis Module:												
Vol/Sat:	0.18	0.00	0.19	0.00	0.00	0.00	0.05	0.39	0.00	0.00	0.27	0.19
Crit Moves:			****					****			****	
Green Time:	44.6	0.0	44.6	0.0	0.0	0.0	15.8	92.4	0.0	0.0	76.6	76.6
Volume/Cap:	0.58	0.00	0.62	0.00	0.00	0.00	0.51	0.62	0.00	0.00	0.51	0.36
Delay/Veh:	44.4	0.0	44.5	0.0	0.0	0.0	63.7	16.6	0.0	0.0	22.7	20.6
User DelAdj:	1.00	1.00	1.00	1.00	1.00	1.00	1.00	1.00	1.00	1.00	1.00	1.00
AdjDel/Veh:	44.4	0.0	44.5	0.0	0.0	0.0	63.7	16.6	0.0	0.0	22.7	20.6
LOS by Move:	D	A	D	A	A	A	E	B	A	A	C	C
HCM2k95thQ:	23	0	25	0	0	0	10	33	0	0	25	17

Note: Queue reported is the number of cars per lane.

BART Phase II Extension Project

Level Of Service Computation Report
 2000 HCM Operations (Future Volume Alternative)
 AM - 2025 No Project Conditions

Intersection #3612: JULIAN/21ST

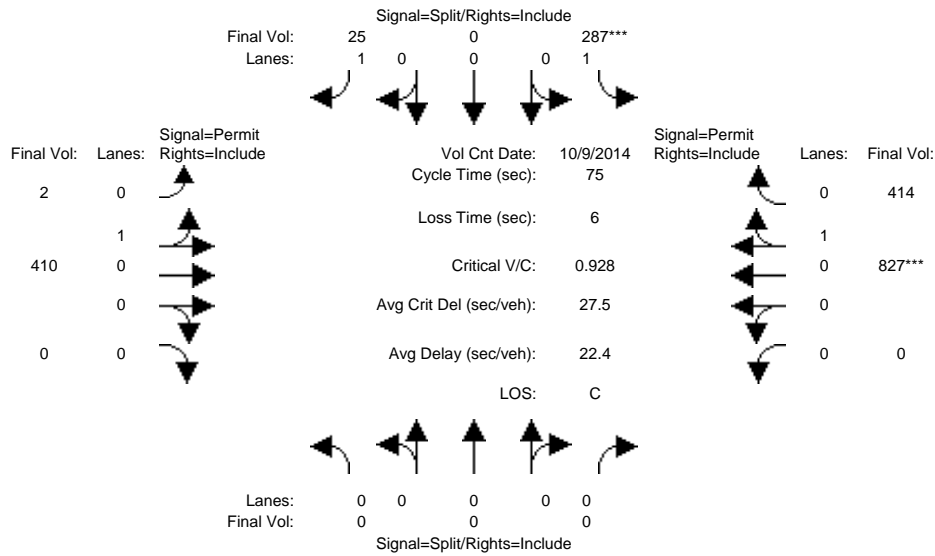

Approach:	North Bound			South Bound			East Bound			West Bound		
	L	T	R	L	T	R	L	T	R	L	T	R
Min. Green:	0	0	0	10	0	10	10	10	0	0	10	10
Y+R:	4.0	4.0	4.0	4.0	4.0	4.0	4.0	4.0	4.0	4.0	4.0	4.0

Volume Module:	>> Count Date: 9 Oct 2014 <<											
Base Vol:	0	0	0	287	0	25	2	410	0	0	827	414
Growth Adj:	1.00	1.00	1.00	1.00	1.00	1.00	1.00	1.00	1.00	1.00	1.00	1.00
Initial Bse:	0	0	0	287	0	25	2	410	0	0	827	414
Added Vol:	0	0	0	0	0	0	0	0	0	0	0	0
PasserByVol:	0	0	0	0	0	0	0	0	0	0	0	0
Initial Fut:	0	0	0	287	0	25	2	410	0	0	827	414
User Adj:	1.00	1.00	1.00	1.00	1.00	1.00	1.00	1.00	1.00	1.00	1.00	1.00
PHF Adj:	1.00	1.00	1.00	1.00	1.00	1.00	1.00	1.00	1.00	1.00	1.00	1.00
PHF Volume:	0	0	0	287	0	25	2	410	0	0	827	414
Reduct Vol:	0	0	0	0	0	0	0	0	0	0	0	0
Reduced Vol:	0	0	0	287	0	25	2	410	0	0	827	414
PCE Adj:	1.00	1.00	1.00	1.00	1.00	1.00	1.00	1.00	1.00	1.00	1.00	1.00
MLF Adj:	1.00	1.00	1.00	1.00	1.00	1.00	1.00	1.00	1.00	1.00	1.00	1.00
FinalVolume:	0	0	0	287	0	25	2	410	0	0	827	414

Saturation Flow Module:												
Sat/Lane:	1900	1900	1900	1900	1900	1900	1900	1900	1900	1900	1900	1900
Adjustment:	0.92	1.00	0.92	0.92	1.00	0.92	0.95	0.95	0.92	0.92	0.95	0.95
Lanes:	0.00	0.00	0.00	1.00	0.00	1.00	0.01	0.99	0.00	0.00	0.67	0.33
Final Sat.:	0	0	0	1750	0	1750	9	1791	0	0	1200	600

Capacity Analysis Module:													
Vol/Sat:	0.00	0.00	0.00	0.16	0.00	0.01	0.23	0.23	0.00	0.00	0.69	0.69	
Crit Moves:				****							****		
Green Time:	0.0	0.0	0.0	13.3	0.0	13.3	55.7	55.7	0.0	0.0	55.7	55.7	
Volume/Cap:	0.00	0.00	0.00	0.93	0.00	0.08	0.31	0.31	0.00	0.00	0.93	0.93	
Delay/Veh:	0.0	0.0	0.0	63.2	0.0	25.9	3.3	3.3	0.0	0.0	19.3	19.3	
User DelAdj:	1.00	1.00	1.00	1.00	1.00	1.00	1.00	1.00	1.00	1.00	1.00	1.00	
AdjDel/Veh:	0.0	0.0	0.0	63.2	0.0	25.9	3.3	3.3	0.0	0.0	19.3	19.3	
LOS by Move:	A	A	A	E	A	C	A	A	A	A	B	B	
HCM2k95thQ:	0	0	0	21	0	1	7	7	0	0	46	46	

Note: Queue reported is the number of cars per lane.

BART Phase II Extension Project

Level Of Service Computation Report
 2000 HCM Operations (Future Volume Alternative)
 PM - 2025 No Project Conditions

Intersection #3612: JULIAN/21ST

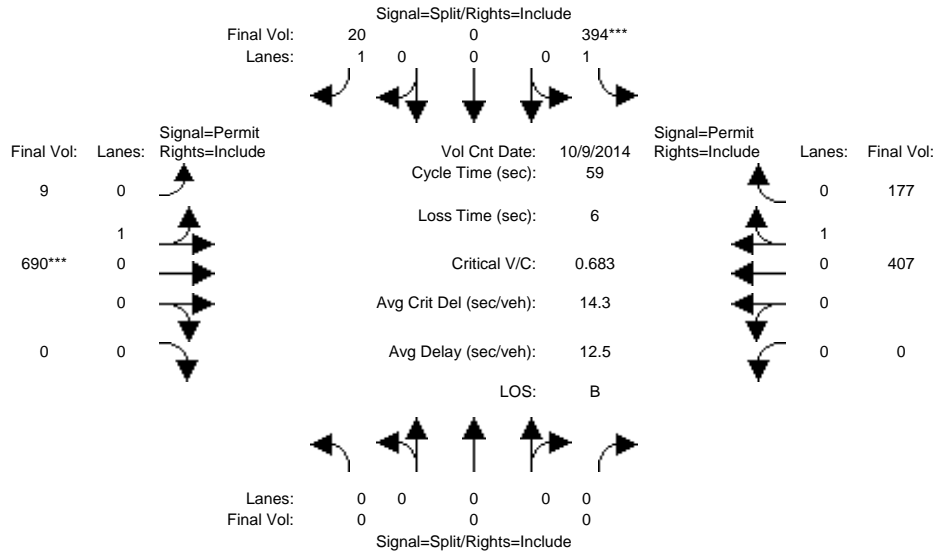

Approach:	North Bound			South Bound			East Bound			West Bound			
	L	T	R	L	T	R	L	T	R	L	T	R	
Min. Green:	0	0	0	10	0	10	10	10	0	0	10	10	
Y+R:	4.0	4.0	4.0	4.0	4.0	4.0	4.0	4.0	4.0	4.0	4.0	4.0	
Volume Module: >> Count Date: 9 Oct 2014 <<													
Base Vol:	0	0	0	394	0	20	9	690	0	0	407	177	
Growth Adj:	1.00	1.00	1.00	1.00	1.00	1.00	1.00	1.00	1.00	1.00	1.00	1.00	
Initial Bse:	0	0	0	394	0	20	9	690	0	0	407	177	
Added Vol:	0	0	0	0	0	0	0	0	0	0	0	0	
PasserByVol:	0	0	0	0	0	0	0	0	0	0	0	0	
Initial Fut:	0	0	0	394	0	20	9	690	0	0	407	177	
User Adj:	1.00	1.00	1.00	1.00	1.00	1.00	1.00	1.00	1.00	1.00	1.00	1.00	
PHF Adj:	1.00	1.00	1.00	1.00	1.00	1.00	1.00	1.00	1.00	1.00	1.00	1.00	
PHF Volume:	0	0	0	394	0	20	9	690	0	0	407	177	
Reduct Vol:	0	0	0	0	0	0	0	0	0	0	0	0	
Reduced Vol:	0	0	0	394	0	20	9	690	0	0	407	177	
PCE Adj:	1.00	1.00	1.00	1.00	1.00	1.00	1.00	1.00	1.00	1.00	1.00	1.00	
MLF Adj:	1.00	1.00	1.00	1.00	1.00	1.00	1.00	1.00	1.00	1.00	1.00	1.00	
FinalVolume:	0	0	0	394	0	20	9	690	0	0	407	177	
Saturation Flow Module:													
Sat/Lane:	1900	1900	1900	1900	1900	1900	1900	1900	1900	1900	1900	1900	
Adjustment:	0.92	1.00	0.92	0.92	1.00	0.92	0.95	0.95	0.92	0.92	0.95	0.95	
Lanes:	0.00	0.00	0.00	1.00	0.00	1.00	0.01	0.99	0.00	0.00	0.70	0.30	
Final Sat.:	0	0	0	1750	0	1750	23	1777	0	0	1254	546	
Capacity Analysis Module:													
Vol/Sat:	0.00	0.00	0.00	0.23	0.00	0.01	0.39	0.39	0.00	0.00	0.32	0.32	
Crit Moves:				****							****		
Green Time:	0.0	0.0	0.0	19.5	0.0	19.5	33.5	33.5	0.0	0.0	33.5	33.5	
Volume/Cap:	0.00	0.00	0.00	0.68	0.00	0.03	0.68	0.68	0.00	0.00	0.57	0.57	
Delay/Veh:	0.0	0.0	0.0	20.5	0.0	13.4	10.9	10.9	0.0	0.0	8.9	8.9	
User DelAdj:	1.00	1.00	1.00	1.00	1.00	1.00	1.00	1.00	1.00	1.00	1.00	1.00	
AdjDel/Veh:	0.0	0.0	0.0	20.5	0.0	13.4	10.9	10.9	0.0	0.0	8.9	8.9	
LOS by Move:	A	A	A	C	A	B	B	B	A	A	A	A	
HCM2k95thQ:	0	0	0	15	0	1	18	18	0	0	14	14	

Note: Queue reported is the number of cars per lane.

BART Phase II Extension Project

Level Of Service Computation Report
 2000 HCM Operations (Future Volume Alternative)
 AM - 2025 No Project Conditions

Intersection #3613: JULIAN/24TH

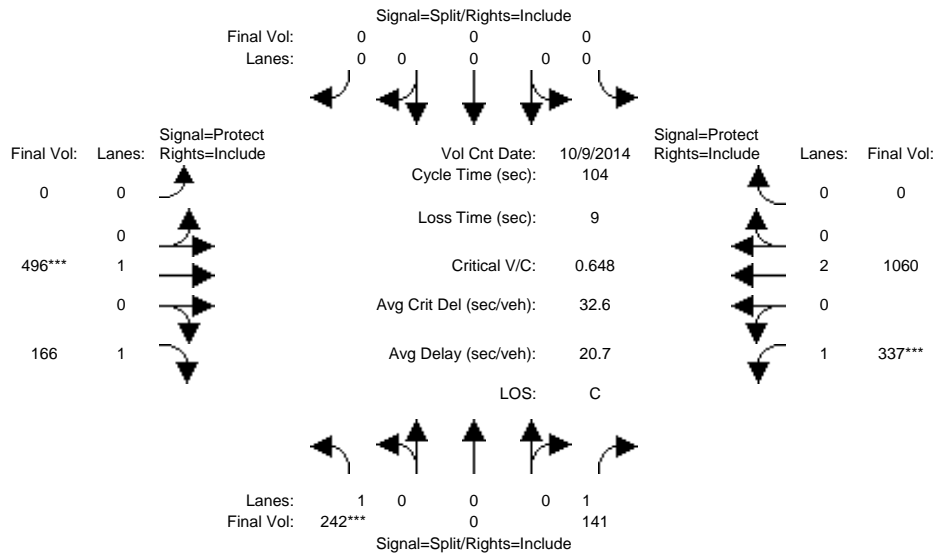

Approach:	North Bound			South Bound			East Bound			West Bound		
	L	T	R	L	T	R	L	T	R	L	T	R
Min. Green:	10	0	10	0	0	0	0	10	10	7	10	0
Y+R:	4.0	4.0	4.0	4.0	4.0	4.0	4.0	4.0	4.0	4.0	4.0	4.0

Volume Module:	>> Count Date: 9 Oct 2014 <<											
Base Vol:	242	0	141	0	0	0	0	496	166	337	1060	0
Growth Adj:	1.00	1.00	1.00	1.00	1.00	1.00	1.00	1.00	1.00	1.00	1.00	1.00
Initial Bse:	242	0	141	0	0	0	0	496	166	337	1060	0
Added Vol:	0	0	0	0	0	0	0	0	0	0	0	0
PasserByVol:	0	0	0	0	0	0	0	0	0	0	0	0
Initial Fut:	242	0	141	0	0	0	0	496	166	337	1060	0
User Adj:	1.00	1.00	1.00	1.00	1.00	1.00	1.00	1.00	1.00	1.00	1.00	1.00
PHF Adj:	1.00	1.00	1.00	1.00	1.00	1.00	1.00	1.00	1.00	1.00	1.00	1.00
PHF Volume:	242	0	141	0	0	0	0	496	166	337	1060	0
Reduct Vol:	0	0	0	0	0	0	0	0	0	0	0	0
Reduced Vol:	242	0	141	0	0	0	0	496	166	337	1060	0
PCE Adj:	1.00	1.00	1.00	1.00	1.00	1.00	1.00	1.00	1.00	1.00	1.00	1.00
MLF Adj:	1.00	1.00	1.00	1.00	1.00	1.00	1.00	1.00	1.00	1.00	1.00	1.00
FinalVolume:	242	0	141	0	0	0	0	496	166	337	1060	0

Saturation Flow Module:												
Sat/Lane:	1900	1900	1900	1900	1900	1900	1900	1900	1900	1900	1900	1900
Adjustment:	0.92	1.00	0.92	0.92	1.00	0.92	0.92	1.00	0.92	0.92	1.00	0.92
Lanes:	1.00	0.00	1.00	0.00	0.00	0.00	0.00	1.00	1.00	1.00	2.00	0.00
Final Sat.:	1750	0	1750	0	0	0	0	1900	1750	1750	3800	0

Capacity Analysis Module:												
Vol/Sat:	0.14	0.00	0.08	0.00	0.00	0.00	0.00	0.26	0.09	0.19	0.28	0.00
Crit Moves:	****							****		****		
Green Time:	22.2	0.0	22.2	0.0	0.0	0.0	0.0	41.9	41.9	30.9	72.8	0.0
Volume/Cap:	0.65	0.00	0.38	0.00	0.00	0.00	0.00	0.65	0.24	0.65	0.40	0.00
Delay/Veh:	41.3	0.0	35.6	0.0	0.0	0.0	0.0	27.0	20.7	34.7	6.6	0.0
User DelAdj:	1.00	1.00	1.00	1.00	1.00	1.00	1.00	1.00	1.00	1.00	1.00	1.00
AdjDel/Veh:	41.3	0.0	35.6	0.0	0.0	0.0	0.0	27.0	20.7	34.7	6.6	0.0
LOS by Move:	D	A	D	A	A	A	A	C	C	C	A	A
HCM2k95thQ:	16	0	9	0	0	0	0	23	7	20	13	0

Note: Queue reported is the number of cars per lane.

BART Phase II Extension Project

Level Of Service Computation Report
 2000 HCM Operations (Future Volume Alternative)
 PM - 2025 No Project Conditions

Intersection #3613: JULIAN/24TH

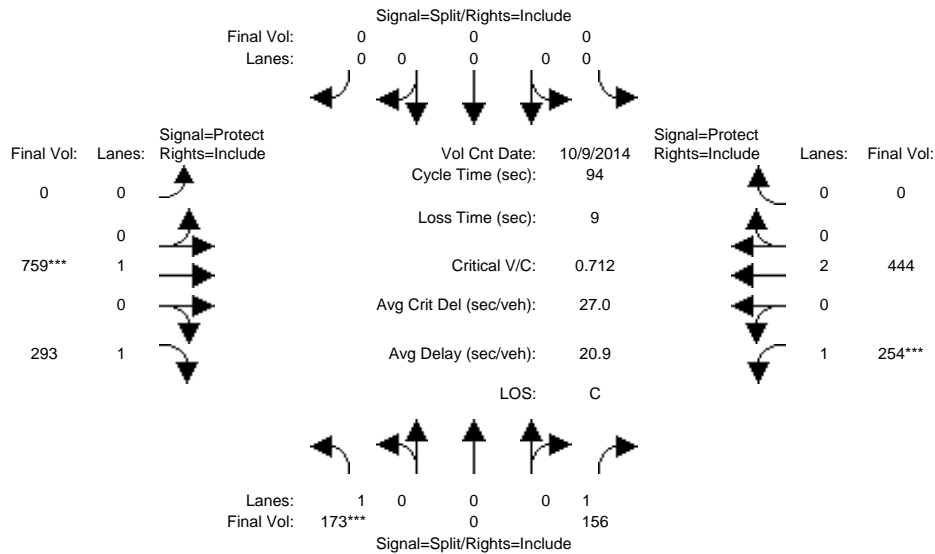

Approach:	North Bound			South Bound			East Bound			West Bound		
	L	T	R	L	T	R	L	T	R	L	T	R
Min. Green:	10	0	10	0	0	0	0	10	10	7	10	0
Y+R:	4.0	4.0	4.0	4.0	4.0	4.0	4.0	4.0	4.0	4.0	4.0	4.0

Volume Module: >> Count Date: 9 Oct 2014 <<

Base Vol:	173	0	156	0	0	0	0	759	293	254	444	0
Growth Adj:	1.00	1.00	1.00	1.00	1.00	1.00	1.00	1.00	1.00	1.00	1.00	1.00
Initial Bse:	173	0	156	0	0	0	0	759	293	254	444	0
Added Vol:	0	0	0	0	0	0	0	0	0	0	0	0
PasserByVol:	0	0	0	0	0	0	0	0	0	0	0	0
Initial Fut:	173	0	156	0	0	0	0	759	293	254	444	0
User Adj:	1.00	1.00	1.00	1.00	1.00	1.00	1.00	1.00	1.00	1.00	1.00	1.00
PHF Adj:	1.00	1.00	1.00	1.00	1.00	1.00	1.00	1.00	1.00	1.00	1.00	1.00
PHF Volume:	173	0	156	0	0	0	0	759	293	254	444	0
Reduct Vol:	0	0	0	0	0	0	0	0	0	0	0	0
Reduced Vol:	173	0	156	0	0	0	0	759	293	254	444	0
PCE Adj:	1.00	1.00	1.00	1.00	1.00	1.00	1.00	1.00	1.00	1.00	1.00	1.00
MLF Adj:	1.00	1.00	1.00	1.00	1.00	1.00	1.00	1.00	1.00	1.00	1.00	1.00
FinalVolume:	173	0	156	0	0	0	0	759	293	254	444	0

Saturation Flow Module:

Sat/Lane:	1900	1900	1900	1900	1900	1900	1900	1900	1900	1900	1900	1900
Adjustment:	0.92	1.00	0.92	0.92	1.00	0.92	0.92	1.00	0.92	0.92	1.00	0.92
Lanes:	1.00	0.00	1.00	0.00	0.00	0.00	0.00	1.00	1.00	1.00	2.00	0.00
Final Sat.:	1750	0	1750	0	0	0	0	1900	1750	1750	3800	0

Capacity Analysis Module:

Vol/Sat:	0.10	0.00	0.09	0.00	0.00	0.00	0.00	0.40	0.17	0.15	0.12	0.00
Crit Moves:	****							****		****		
Green Time:	13.1	0.0	13.1	0.0	0.0	0.0	0.0	52.8	52.8	19.2	71.9	0.0
Volume/Cap:	0.71	0.00	0.64	0.00	0.00	0.00	0.00	0.71	0.30	0.71	0.15	0.00
Delay/Veh:	48.1	0.0	44.0	0.0	0.0	0.0	0.0	17.3	11.0	41.4	3.0	0.0
User DelAdj:	1.00	1.00	1.00	1.00	1.00	1.00	1.00	1.00	1.00	1.00	1.00	1.00
AdjDel/Veh:	48.1	0.0	44.0	0.0	0.0	0.0	0.0	17.3	11.0	41.4	3.0	0.0
LOS by Move:	D	A	D	A	A	A	A	B	B	D	A	A
HCM2k95thQ:	13	0	11	0	0	0	0	27	9	17	4	0

Note: Queue reported is the number of cars per lane.

BART Phase II Extension Project

Level Of Service Computation Report
 2000 HCM Operations (Future Volume Alternative)
 AM - 2025 No Project Conditions

Intersection #3625: KING/McKEE

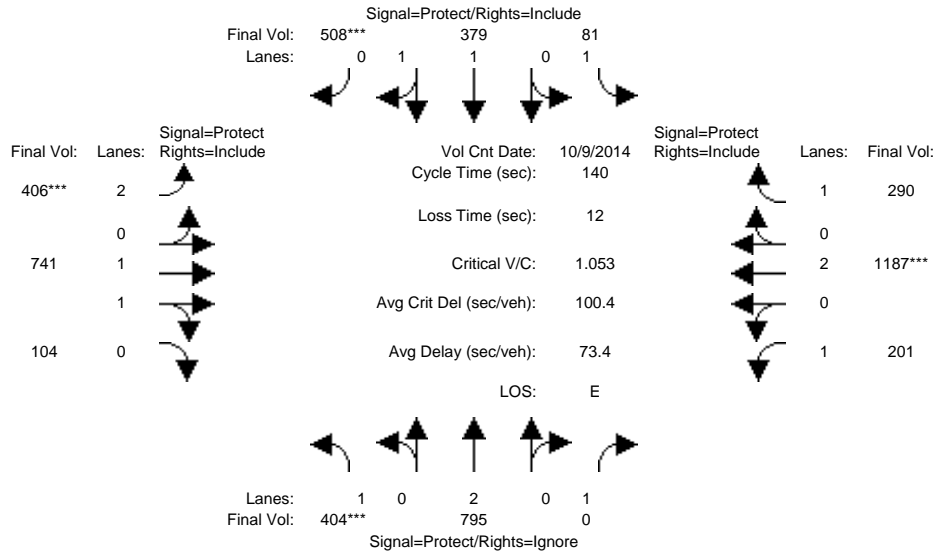

Approach:	North Bound			South Bound			East Bound			West Bound		
	L	T	R	L	T	R	L	T	R	L	T	R
Min. Green:	7	10	10	7	10	10	7	10	10	7	10	10
Y+R:	4.0	4.0	4.0	4.0	4.0	4.0	4.0	4.0	4.0	4.0	4.0	4.0
Volume Module: >> Count Date: 9 Oct 2014 <<												
Base Vol:	404	795	169	81	379	508	406	741	104	201	1187	290
Growth Adj:	1.00	1.00	1.00	1.00	1.00	1.00	1.00	1.00	1.00	1.00	1.00	1.00
Initial Bse:	404	795	169	81	379	508	406	741	104	201	1187	290
Added Vol:	0	0	0	0	0	0	0	0	0	0	0	0
PasserByVol:	0	0	0	0	0	0	0	0	0	0	0	0
Initial Fut:	404	795	169	81	379	508	406	741	104	201	1187	290
User Adj:	1.00	1.00	0.00	1.00	1.00	1.00	1.00	1.00	1.00	1.00	1.00	1.00
PHF Adj:	1.00	1.00	0.00	1.00	1.00	1.00	1.00	1.00	1.00	1.00	1.00	1.00
PHF Volume:	404	795	0	81	379	508	406	741	104	201	1187	290
Reduct Vol:	0	0	0	0	0	0	0	0	0	0	0	0
Reduced Vol:	404	795	0	81	379	508	406	741	104	201	1187	290
PCE Adj:	1.00	1.00	0.00	1.00	1.00	1.00	1.00	1.00	1.00	1.00	1.00	1.00
MLF Adj:	1.00	1.00	0.00	1.00	1.00	1.00	1.00	1.00	1.00	1.00	1.00	1.00
Final Volume:	404	795	0	81	379	508	406	741	104	201	1187	290
Saturation Flow Module:												
Sat/Lane:	1900	1900	1900	1900	1900	1900	1900	1900	1900	1900	1900	1900
Adjustment:	0.92	1.00	0.92	0.92	1.00	0.92	0.83	0.98	0.95	0.92	1.00	0.92
Lanes:	1.00	2.00	1.00	1.00	1.00	1.00	2.00	1.75	0.25	1.00	2.00	1.00
Final Sat.:	1750	3800	1750	1750	1900	1750	3150	3244	455	1750	3800	1750
Capacity Analysis Module:												
Vol/Sat:	0.23	0.21	0.00	0.05	0.20	0.29	0.13	0.23	0.23	0.11	0.31	0.17
Crit Moves:	****					****	****				****	
Green Time:	30.7	55.9	0.0	13.4	38.6	38.6	17.1	39.1	39.1	19.6	41.5	41.5
Volume/Cap:	1.05	0.52	0.00	0.48	0.72	1.05	1.05	0.82	0.82	0.82	1.05	0.56
Delay/Veh:	115.1	32.2	0.0	62.3	48.0	96.5	121.8	52.4	52.4	77.5	91.0	42.9
User DelAdj:	1.00	1.00	1.00	1.00	1.00	1.00	1.00	1.00	1.00	1.00	1.00	1.00
AdjDel/Veh:	115.1	32.2	0.0	62.3	48.0	96.5	121.8	52.4	52.4	77.5	91.0	42.9
LOS by Move:	F	C	A	E	D	F	F	D	D	E	F	D
HCM2k95thQ:	40	23	0	7	26	48	24	31	31	18	51	20

Note: Queue reported is the number of cars per lane.

BART Phase II Extension Project

Level Of Service Computation Report
 2000 HCM Operations (Future Volume Alternative)
 PM - 2025 No Project Conditions

Intersection #3625: KING/McKEE

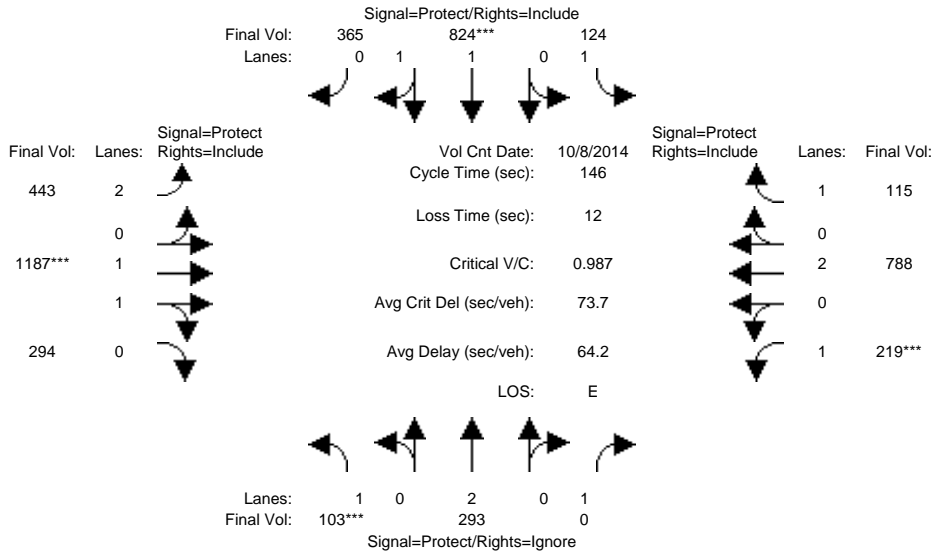

Approach:	North Bound			South Bound			East Bound			West Bound		
	L	T	R	L	T	R	L	T	R	L	T	R
Min. Green:	7	10	10	7	10	10	7	10	10	7	10	10
Y+R:	4.0	4.0	4.0	4.0	4.0	4.0	4.0	4.0	4.0	4.0	4.0	4.0

Volume Module: >> Count Date: 8 Oct 2014 <<

Base Vol:	103	293	107	124	824	365	443	1187	294	219	788	115
Growth Adj:	1.00	1.00	1.00	1.00	1.00	1.00	1.00	1.00	1.00	1.00	1.00	1.00
Initial Bse:	103	293	107	124	824	365	443	1187	294	219	788	115
Added Vol:	0	0	0	0	0	0	0	0	0	0	0	0
PasserByVol:	0	0	0	0	0	0	0	0	0	0	0	0
Initial Fut:	103	293	107	124	824	365	443	1187	294	219	788	115
User Adj:	1.00	1.00	0.00	1.00	1.00	1.00	1.00	1.00	1.00	1.00	1.00	1.00
PHF Adj:	1.00	1.00	0.00	1.00	1.00	1.00	1.00	1.00	1.00	1.00	1.00	1.00
PHF Volume:	103	293	0	124	824	365	443	1187	294	219	788	115
Reduct Vol:	0	0	0	0	0	0	0	0	0	0	0	0
Reduced Vol:	103	293	0	124	824	365	443	1187	294	219	788	115
PCE Adj:	1.00	1.00	0.00	1.00	1.00	1.00	1.00	1.00	1.00	1.00	1.00	1.00
MLF Adj:	1.00	1.00	0.00	1.00	1.00	1.00	1.00	1.00	1.00	1.00	1.00	1.00
FinalVolume:	103	293	0	124	824	365	443	1187	294	219	788	115

Saturation Flow Module:

Sat/Lane:	1900	1900	1900	1900	1900	1900	1900	1900	1900	1900	1900	1900
Adjustment:	0.92	1.00	0.92	0.92	0.99	0.95	0.83	0.98	0.95	0.92	1.00	0.92
Lanes:	1.00	2.00	1.00	1.00	1.37	0.63	2.00	1.59	0.41	1.00	2.00	1.00
Final Sat.:	1750	3800	1750	1750	2563	1135	3150	2965	734	1750	3800	1750

Capacity Analysis Module:

Vol/Sat:	0.06	0.08	0.00	0.07	0.32	0.32	0.14	0.40	0.40	0.13	0.21	0.07
Crit Moves:	****			****			****			****		
Green Time:	8.7	29.3	0.0	26.9	47.6	47.6	31.4	59.2	59.2	18.5	46.3	46.3
Volume/Cap:	0.99	0.38	0.00	0.38	0.99	0.99	0.65	0.99	0.99	0.99	0.65	0.21
Delay/Veh:	152.3	50.8	0.0	53.0	71.6	71.6	54.6	63.1	63.1	120.1	44.2	36.6
User DelAdj:	1.00	1.00	1.00	1.00	1.00	1.00	1.00	1.00	1.00	1.00	1.00	1.00
AdjDel/Veh:	152.3	50.8	0.0	53.0	71.6	71.6	54.6	63.1	63.1	120.1	44.2	36.6
LOS by Move:	F	D	A	D	E	E	D	E	E	F	D	D
HCM2k95thQ:	12	11	0	10	50	50	20	61	61	23	26	8

Note: Queue reported is the number of cars per lane.

BART Phase II Extension Project

Level Of Service Computation Report
2000 HCM Operations (Future Volume Alternative)
AM - 2025 No Project Conditions

Intersection #3683: McLAUGHLIN/STORY

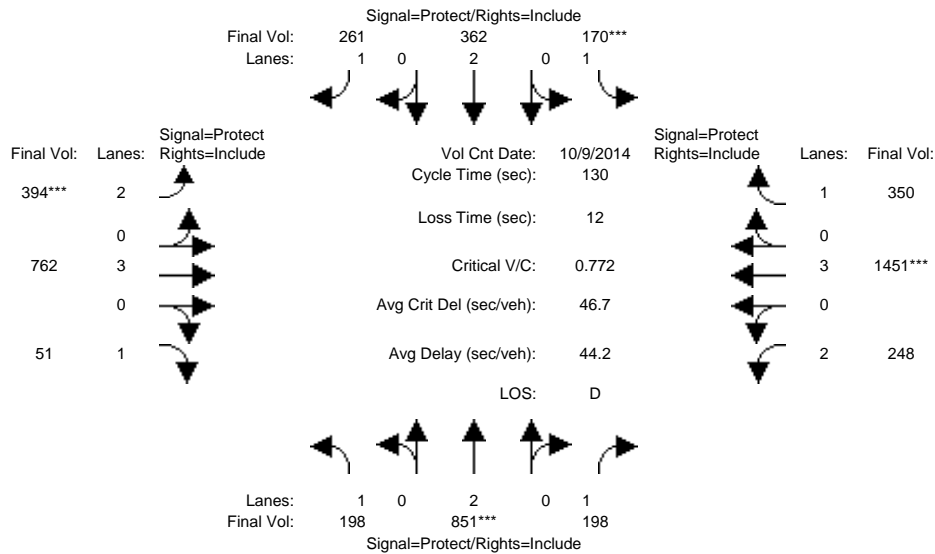

Approach:	North Bound			South Bound			East Bound			West Bound		
	L	T	R	L	T	R	L	T	R	L	T	R
Min. Green:	7	10	10	7	10	10	7	10	10	7	10	10
Y+R:	4.0	4.0	4.0	4.0	4.0	4.0	4.0	4.0	4.0	4.0	4.0	4.0
Volume Module: >> Count Date: 9 Oct 2014 <<												
Base Vol:	198	851	198	170	362	261	394	762	51	248	1451	350
Growth Adj:	1.00	1.00	1.00	1.00	1.00	1.00	1.00	1.00	1.00	1.00	1.00	1.00
Initial Bse:	198	851	198	170	362	261	394	762	51	248	1451	350
Added Vol:	0	0	0	0	0	0	0	0	0	0	0	0
PasserByVol:	0	0	0	0	0	0	0	0	0	0	0	0
Initial Fut:	198	851	198	170	362	261	394	762	51	248	1451	350
User Adj:	1.00	1.00	1.00	1.00	1.00	1.00	1.00	1.00	1.00	1.00	1.00	1.00
PHF Adj:	1.00	1.00	1.00	1.00	1.00	1.00	1.00	1.00	1.00	1.00	1.00	1.00
PHF Volume:	198	851	198	170	362	261	394	762	51	248	1451	350
Reduct Vol:	0	0	0	0	0	0	0	0	0	0	0	0
Reduced Vol:	198	851	198	170	362	261	394	762	51	248	1451	350
PCE Adj:	1.00	1.00	1.00	1.00	1.00	1.00	1.00	1.00	1.00	1.00	1.00	1.00
MLF Adj:	1.00	1.00	1.00	1.00	1.00	1.00	1.00	1.00	1.00	1.00	1.00	1.00
FinalVolume:	198	851	198	170	362	261	394	762	51	248	1451	350
Saturation Flow Module:												
Sat/Lane:	1900	1900	1900	1900	1900	1900	1900	1900	1900	1900	1900	1900
Adjustment:	0.92	1.00	0.92	0.92	1.00	0.92	0.83	1.00	0.92	0.83	1.00	0.92
Lanes:	1.00	2.00	1.00	1.00	2.00	1.00	2.00	3.00	1.00	2.00	3.00	1.00
Final Sat.:	1750	3800	1750	1750	3800	1750	3150	5700	1750	3150	5700	1750
Capacity Analysis Module:												
Vol/Sat:	0.11	0.22	0.11	0.10	0.10	0.15	0.13	0.13	0.03	0.08	0.25	0.20
Crit Moves:	****			****			****			****		
Green Time:	23.3	37.7	37.7	16.4	30.7	30.7	21.1	40.2	40.2	23.7	42.9	42.9
Volume/Cap:	0.63	0.77	0.39	0.77	0.40	0.63	0.77	0.43	0.09	0.43	0.77	0.61
Delay/Veh:	53.4	45.6	37.4	70.4	42.2	47.7	59.3	35.9	32.0	47.7	41.2	38.4
User DelAdj:	1.00	1.00	1.00	1.00	1.00	1.00	1.00	1.00	1.00	1.00	1.00	1.00
AdjDel/Veh:	53.4	45.6	37.4	70.4	42.2	47.7	59.3	35.9	32.0	47.7	41.2	38.4
LOS by Move:	D	D	D	E	D	D	E	D	C	D	D	D
HCM2k95thQ:	16	29	13	14	11	19	20	15	3	10	30	22

Note: Queue reported is the number of cars per lane.

BART Phase II Extension Project

Level Of Service Computation Report
2000 HCM Operations (Future Volume Alternative)
PM - 2025 No Project Conditions

Intersection #3683: McLAUGHLIN/STORY

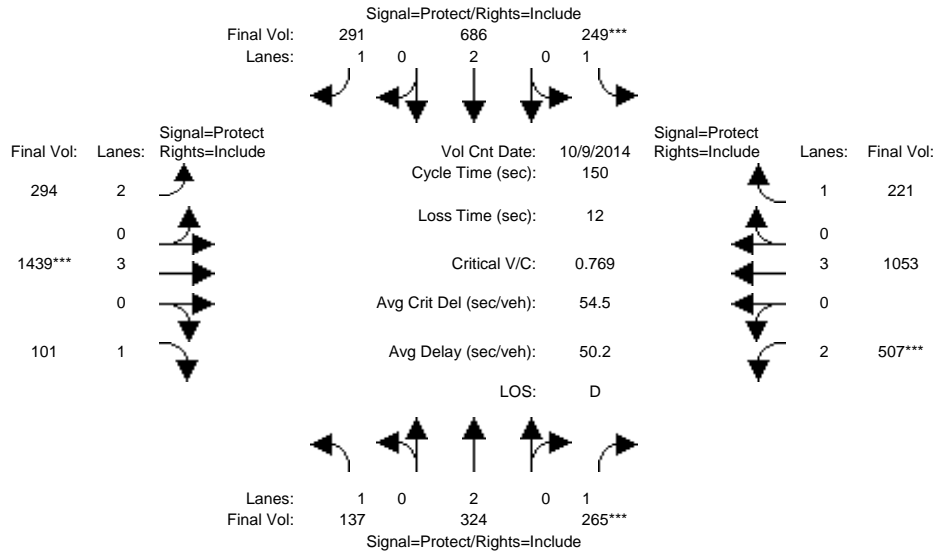

Approach:	North Bound			South Bound			East Bound			West Bound		
Movement:	L	T	R	L	T	R	L	T	R	L	T	R
Min. Green:	7	10	10	7	10	10	7	10	10	7	10	10
Y+R:	4.0	4.0	4.0	4.0	4.0	4.0	4.0	4.0	4.0	4.0	4.0	4.0
Volume Module: >> Count Date: 9 Oct 2014 <<												
Base Vol:	137	324	265	249	686	291	294	1439	101	507	1053	221
Growth Adj:	1.00	1.00	1.00	1.00	1.00	1.00	1.00	1.00	1.00	1.00	1.00	1.00
Initial Bse:	137	324	265	249	686	291	294	1439	101	507	1053	221
Added Vol:	0	0	0	0	0	0	0	0	0	0	0	0
PasserByVol:	0	0	0	0	0	0	0	0	0	0	0	0
Initial Fut:	137	324	265	249	686	291	294	1439	101	507	1053	221
User Adj:	1.00	1.00	1.00	1.00	1.00	1.00	1.00	1.00	1.00	1.00	1.00	1.00
PHF Adj:	1.00	1.00	1.00	1.00	1.00	1.00	1.00	1.00	1.00	1.00	1.00	1.00
PHF Volume:	137	324	265	249	686	291	294	1439	101	507	1053	221
Reduct Vol:	0	0	0	0	0	0	0	0	0	0	0	0
Reduced Vol:	137	324	265	249	686	291	294	1439	101	507	1053	221
PCE Adj:	1.00	1.00	1.00	1.00	1.00	1.00	1.00	1.00	1.00	1.00	1.00	1.00
MLF Adj:	1.00	1.00	1.00	1.00	1.00	1.00	1.00	1.00	1.00	1.00	1.00	1.00
FinalVolume:	137	324	265	249	686	291	294	1439	101	507	1053	221
Saturation Flow Module:												
Sat/Lane:	1900	1900	1900	1900	1900	1900	1900	1900	1900	1900	1900	1900
Adjustment:	0.92	1.00	0.92	0.92	1.00	0.92	0.83	1.00	0.92	0.83	1.00	0.92
Lanes:	1.00	2.00	1.00	1.00	2.00	1.00	2.00	3.00	1.00	2.00	3.00	1.00
Final Sat.:	1750	3800	1750	1750	3800	1750	3150	5700	1750	3150	5700	1750
Capacity Analysis Module:												
Vol/Sat:	0.08	0.09	0.15	0.14	0.18	0.17	0.09	0.25	0.06	0.16	0.18	0.13
Crit Moves:			****	****				****		****		
Green Time:	17.3	29.6	29.6	27.8	40.0	40.0	27.1	49.3	49.3	31.4	53.6	53.6
Volume/Cap:	0.68	0.43	0.77	0.77	0.68	0.62	0.52	0.77	0.18	0.77	0.52	0.35
Delay/Veh:	72.5	53.3	67.0	68.7	51.1	51.0	56.4	47.2	36.0	61.3	38.2	35.8
User DelAdj:	1.00	1.00	1.00	1.00	1.00	1.00	1.00	1.00	1.00	1.00	1.00	1.00
AdjDel/Veh:	72.5	53.3	67.0	68.7	51.1	51.0	56.4	47.2	36.0	61.3	38.2	35.8
LOS by Move:	E	D	E	E	D	D	E	D	D	E	D	D
HCM2k95thQ:	15	13	25	22	25	23	15	35	7	24	22	15

Note: Queue reported is the number of cars per lane.

BART Phase II Extension Project

Level Of Service Computation Report
2000 HCM Operations (Future Volume Alternative)
AM - 2025 No Project Conditions

Intersection #3762: SAN ANTONIO/24TH

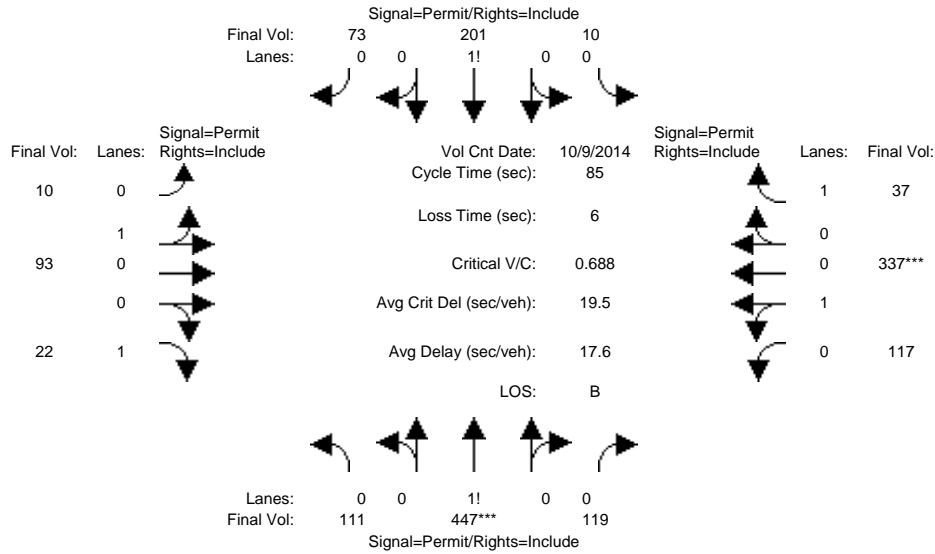

Approach:	North Bound			South Bound			East Bound			West Bound		
	L	T	R	L	T	R	L	T	R	L	T	R
Min. Green:	10	10	10	10	10	10	10	10	10	10	10	10
Y+R:	4.0	4.0	4.0	4.0	4.0	4.0	4.0	4.0	4.0	4.0	4.0	4.0
Volume Module: >> Count Date: 9 Oct 2014 <<												
Base Vol:	111	447	119	10	201	73	10	93	22	117	337	37
Growth Adj:	1.00	1.00	1.00	1.00	1.00	1.00	1.00	1.00	1.00	1.00	1.00	1.00
Initial Bse:	111	447	119	10	201	73	10	93	22	117	337	37
Added Vol:	0	0	0	0	0	0	0	0	0	0	0	0
PasserByVol:	0	0	0	0	0	0	0	0	0	0	0	0
Initial Fut:	111	447	119	10	201	73	10	93	22	117	337	37
User Adj:	1.00	1.00	1.00	1.00	1.00	1.00	1.00	1.00	1.00	1.00	1.00	1.00
PHF Adj:	1.00	1.00	1.00	1.00	1.00	1.00	1.00	1.00	1.00	1.00	1.00	1.00
PHF Volume:	111	447	119	10	201	73	10	93	22	117	337	37
Reduct Vol:	0	0	0	0	0	0	0	0	0	0	0	0
Reduced Vol:	111	447	119	10	201	73	10	93	22	117	337	37
PCE Adj:	1.00	1.00	1.00	1.00	1.00	1.00	1.00	1.00	1.00	1.00	1.00	1.00
MLF Adj:	1.00	1.00	1.00	1.00	1.00	1.00	1.00	1.00	1.00	1.00	1.00	1.00
FinalVolume:	111	447	119	10	201	73	10	93	22	117	337	37
Saturation Flow Module:												
Sat/Lane:	1900	1900	1900	1900	1900	1900	1900	1900	1900	1900	1900	1900
Adjustment:	0.92	0.92	0.92	0.92	0.92	0.92	0.95	0.95	0.92	0.95	0.95	0.92
Lanes:	0.16	0.66	0.18	0.03	0.71	0.26	0.10	0.90	1.00	0.26	0.74	1.00
Final Sat.:	287	1155	308	62	1239	450	175	1625	1750	464	1336	1750
Capacity Analysis Module:												
Vol/Sat:	0.39	0.39	0.39	0.16	0.16	0.16	0.06	0.06	0.01	0.25	0.25	0.02
Crit Moves:	****											
Green Time:	47.8	47.8	47.8	47.8	47.8	47.8	31.2	31.2	31.2	31.2	31.2	31.2
Volume/Cap:	0.69	0.69	0.69	0.29	0.29	0.29	0.16	0.16	0.03	0.69	0.69	0.06
Delay/Veh:	15.3	15.3	15.3	9.9	9.9	9.9	18.2	18.2	17.3	25.8	25.8	17.4
User DelAdj:	1.00	1.00	1.00	1.00	1.00	1.00	1.00	1.00	1.00	1.00	1.00	1.00
AdjDel/Veh:	15.3	15.3	15.3	9.9	9.9	9.9	18.2	18.2	17.3	25.8	25.8	17.4
LOS by Move:	B	B	B	A	A	A	B	B	B	C	C	B
HCM2k95thQ:	24	24	24	8	8	8	4	4	1	20	20	1

Note: Queue reported is the number of cars per lane.

BART Phase II Extension Project

Level Of Service Computation Report
 2000 HCM Operations (Future Volume Alternative)
 PM - 2025 No Project Conditions

Intersection #3762: SAN ANTONIO/24TH

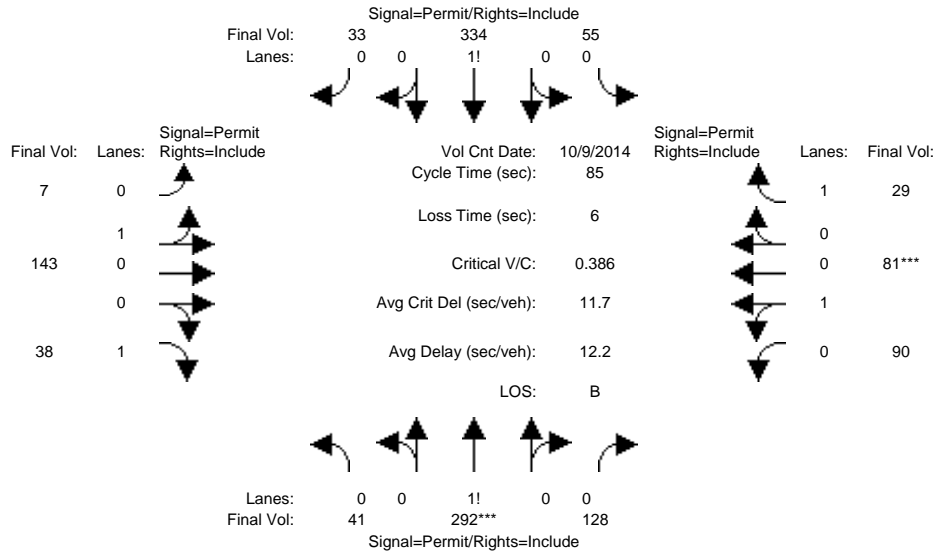

Approach:	North Bound			South Bound			East Bound			West Bound		
	L	T	R	L	T	R	L	T	R	L	T	R
Min. Green:	10	10	10	10	10	10	10	10	10	10	10	10
Y+R:	4.0	4.0	4.0	4.0	4.0	4.0	4.0	4.0	4.0	4.0	4.0	4.0
Volume Module: >> Count Date: 9 Oct 2014 <<												
Base Vol:	41	292	128	55	334	33	7	143	38	90	81	29
Growth Adj:	1.00	1.00	1.00	1.00	1.00	1.00	1.00	1.00	1.00	1.00	1.00	1.00
Initial Bse:	41	292	128	55	334	33	7	143	38	90	81	29
Added Vol:	0	0	0	0	0	0	0	0	0	0	0	0
PasserByVol:	0	0	0	0	0	0	0	0	0	0	0	0
Initial Fut:	41	292	128	55	334	33	7	143	38	90	81	29
User Adj:	1.00	1.00	1.00	1.00	1.00	1.00	1.00	1.00	1.00	1.00	1.00	1.00
PHF Adj:	1.00	1.00	1.00	1.00	1.00	1.00	1.00	1.00	1.00	1.00	1.00	1.00
PHF Volume:	41	292	128	55	334	33	7	143	38	90	81	29
Reduct Vol:	0	0	0	0	0	0	0	0	0	0	0	0
Reduced Vol:	41	292	128	55	334	33	7	143	38	90	81	29
PCE Adj:	1.00	1.00	1.00	1.00	1.00	1.00	1.00	1.00	1.00	1.00	1.00	1.00
MLF Adj:	1.00	1.00	1.00	1.00	1.00	1.00	1.00	1.00	1.00	1.00	1.00	1.00
FinalVolume:	41	292	128	55	334	33	7	143	38	90	81	29
Saturation Flow Module:												
Sat/Lane:	1900	1900	1900	1900	1900	1900	1900	1900	1900	1900	1900	1900
Adjustment:	0.92	0.92	0.92	0.92	0.92	0.92	0.95	0.95	0.92	0.95	0.95	0.92
Lanes:	0.09	0.63	0.28	0.13	0.79	0.08	0.05	0.95	1.00	0.53	0.47	1.00
Final Sat.:	156	1108	486	228	1385	137	84	1716	1750	947	853	1750
Capacity Analysis Module:												
Vol/Sat:	0.26	0.26	0.26	0.24	0.24	0.24	0.08	0.08	0.02	0.10	0.10	0.02
Crit Moves:	****									****		
Green Time:	58.1	58.1	58.1	58.1	58.1	58.1	20.9	20.9	20.9	20.9	20.9	20.9
Volume/Cap:	0.39	0.39	0.39	0.35	0.35	0.35	0.34	0.34	0.09	0.39	0.39	0.07
Delay/Veh:	6.0	6.0	6.0	5.8	5.8	5.8	26.8	26.8	24.8	27.2	27.2	24.6
User DelAdj:	1.00	1.00	1.00	1.00	1.00	1.00	1.00	1.00	1.00	1.00	1.00	1.00
AdjDel/Veh:	6.0	6.0	6.0	5.8	5.8	5.8	26.8	26.8	24.8	27.2	27.2	24.6
LOS by Move:	A	A	A	A	A	A	C	C	C	C	C	C
HCM2k95thQ:	11	11	11	10	10	10	7	7	2	8	8	1

Note: Queue reported is the number of cars per lane.

BART Phase II Extension Project

Level Of Service Computation Report
2000 HCM Operations (Future Volume Alternative)
AM - 2025 No Project Conditions

Intersection #3783: SANTA CLARA/17TH

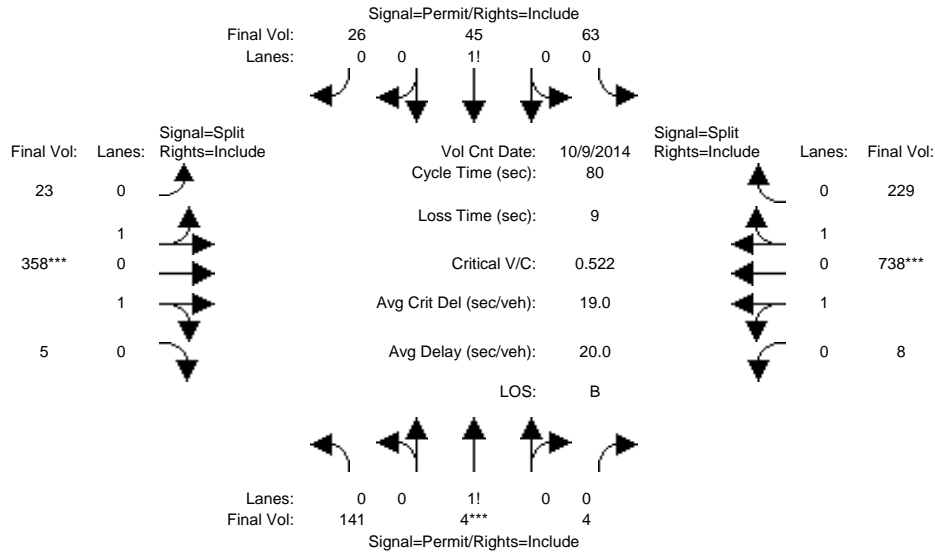

Approach:	North Bound			South Bound			East Bound			West Bound		
	L	T	R	L	T	R	L	T	R	L	T	R
Min. Green:	10	10	10	10	10	10	10	10	10	10	10	10
Y+R:	4.0	4.0	4.0	4.0	4.0	4.0	4.0	4.0	4.0	4.0	4.0	4.0
Volume Module: >> Count Date: 9 Oct 2014 <<												
Base Vol:	141	4	4	63	45	26	23	358	5	8	738	229
Growth Adj:	1.00	1.00	1.00	1.00	1.00	1.00	1.00	1.00	1.00	1.00	1.00	1.00
Initial Bse:	141	4	4	63	45	26	23	358	5	8	738	229
Added Vol:	0	0	0	0	0	0	0	0	0	0	0	0
PasserByVol:	0	0	0	0	0	0	0	0	0	0	0	0
Initial Fut:	141	4	4	63	45	26	23	358	5	8	738	229
User Adj:	1.00	1.00	1.00	1.00	1.00	1.00	1.00	1.00	1.00	1.00	1.00	1.00
PHF Adj:	1.00	1.00	1.00	1.00	1.00	1.00	1.00	1.00	1.00	1.00	1.00	1.00
PHF Volume:	141	4	4	63	45	26	23	358	5	8	738	229
Reduct Vol:	0	0	0	0	0	0	0	0	0	0	0	0
Reduced Vol:	141	4	4	63	45	26	23	358	5	8	738	229
PCE Adj:	1.00	1.00	1.00	1.00	1.00	1.00	1.00	1.00	1.00	1.00	1.00	1.00
MLF Adj:	1.00	1.00	1.00	1.00	1.00	1.00	1.00	1.00	1.00	1.00	1.00	1.00
FinalVolume:	141	4	4	63	45	26	23	358	5	8	738	229
Saturation Flow Module:												
Sat/Lane:	1900	1900	1900	1900	1900	1900	1900	1900	1900	1900	1900	1900
Adjustment:	0.92	0.92	0.92	0.92	0.92	0.92	0.95	0.95	0.95	0.95	0.95	0.95
Lanes:	0.94	0.03	0.03	0.47	0.34	0.19	0.12	1.85	0.03	0.02	1.51	0.47
Final Sat.:	1656	47	47	823	588	340	215	3339	47	30	2725	846
Capacity Analysis Module:												
Vol/Sat:	0.09	0.09	0.09	0.08	0.08	0.08	0.11	0.11	0.11	0.27	0.27	0.27
Crit Moves:	****						****			****		
Green Time:	13.1	13.1	13.1	13.1	13.1	13.1	16.4	16.4	16.4	41.5	41.5	41.5
Volume/Cap:	0.52	0.52	0.52	0.47	0.47	0.47	0.52	0.52	0.52	0.52	0.52	0.52
Delay/Veh:	32.4	32.4	32.4	31.6	31.6	31.6	29.0	29.0	29.0	13.0	13.0	13.0
User DelAdj:	1.00	1.00	1.00	1.00	1.00	1.00	1.00	1.00	1.00	1.00	1.00	1.00
AdjDel/Veh:	32.4	32.4	32.4	31.6	31.6	31.6	29.0	29.0	29.0	13.0	13.0	13.0
LOS by Move:	C	C	C	C	C	C	C	C	C	B	B	B
HCM2k95thQ:	9	9	9	8	8	8	10	10	10	15	15	15

Note: Queue reported is the number of cars per lane.

BART Phase II Extension Project

Level Of Service Computation Report
 2000 HCM Operations (Future Volume Alternative)
 PM - 2025 No Project Conditions

Intersection #3783: SANTA CLARA/17TH

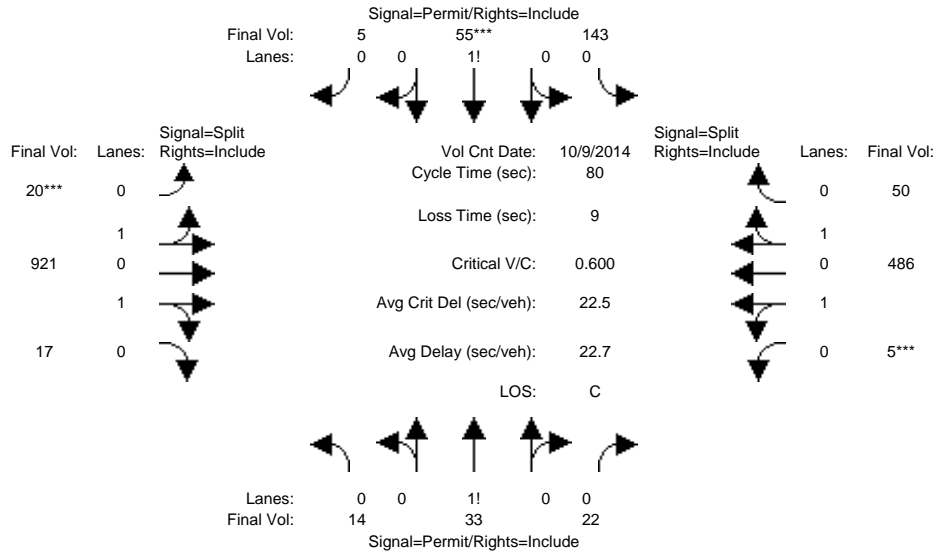

Approach:	North Bound			South Bound			East Bound			West Bound		
	L	T	R	L	T	R	L	T	R	L	T	R
Min. Green:	10	10	10	10	10	10	10	10	10	10	10	10
Y+R:	4.0	4.0	4.0	4.0	4.0	4.0	4.0	4.0	4.0	4.0	4.0	4.0

Volume Module:	>> Count Date: 9 Oct 2014 <<											
Base Vol:	14	33	22	143	55	5	20	921	17	5	486	50
Growth Adj:	1.00	1.00	1.00	1.00	1.00	1.00	1.00	1.00	1.00	1.00	1.00	1.00
Initial Bse:	14	33	22	143	55	5	20	921	17	5	486	50
Added Vol:	0	0	0	0	0	0	0	0	0	0	0	0
PasserByVol:	0	0	0	0	0	0	0	0	0	0	0	0
Initial Fut:	14	33	22	143	55	5	20	921	17	5	486	50
User Adj:	1.00	1.00	1.00	1.00	1.00	1.00	1.00	1.00	1.00	1.00	1.00	1.00
PHF Adj:	1.00	1.00	1.00	1.00	1.00	1.00	1.00	1.00	1.00	1.00	1.00	1.00
PHF Volume:	14	33	22	143	55	5	20	921	17	5	486	50
Reduct Vol:	0	0	0	0	0	0	0	0	0	0	0	0
Reduced Vol:	14	33	22	143	55	5	20	921	17	5	486	50
PCE Adj:	1.00	1.00	1.00	1.00	1.00	1.00	1.00	1.00	1.00	1.00	1.00	1.00
MLF Adj:	1.00	1.00	1.00	1.00	1.00	1.00	1.00	1.00	1.00	1.00	1.00	1.00
FinalVolume:	14	33	22	143	55	5	20	921	17	5	486	50

Saturation Flow Module:												
Sat/Lane:	1900	1900	1900	1900	1900	1900	1900	1900	1900	1900	1900	1900
Adjustment:	0.92	0.92	0.92	0.92	0.92	0.92	0.95	0.95	0.95	0.95	0.95	0.95
Lanes:	0.20	0.48	0.32	0.71	0.27	0.02	0.04	1.92	0.04	0.02	1.80	0.18
Final Sat.:	355	837	558	1233	474	43	75	3461	64	33	3234	333

Capacity Analysis Module:												
Vol/Sat:	0.04	0.04	0.04	0.12	0.12	0.12	0.27	0.27	0.27	0.15	0.15	0.15
Crit Moves:				****	****	****	****	****	****	****	****	****
Green Time:	15.5	15.5	15.5	15.5	15.5	15.5	35.5	35.5	35.5	20.0	20.0	20.0
Volume/Cap:	0.20	0.20	0.20	0.60	0.60	0.60	0.60	0.60	0.60	0.60	0.60	0.60
Delay/Veh:	27.4	27.4	27.4	32.4	32.4	32.4	17.5	17.5	17.5	27.6	27.6	27.6
User DelAdj:	1.00	1.00	1.00	1.00	1.00	1.00	1.00	1.00	1.00	1.00	1.00	1.00
AdjDel/Veh:	27.4	27.4	27.4	32.4	32.4	32.4	17.5	17.5	17.5	27.6	27.6	27.6
LOS by Move:	C	C	C	C	C	C	B	B	B	C	C	C
HCM2k95thQ:	3	3	3	11	11	11	18	18	18	12	12	12

Note: Queue reported is the number of cars per lane.

BART Phase II Extension Project

Level Of Service Computation Report
 2000 HCM Operations (Future Volume Alternative)
 AM - 2025 No Project Conditions

Intersection #3788: SANTA CLARA/28TH

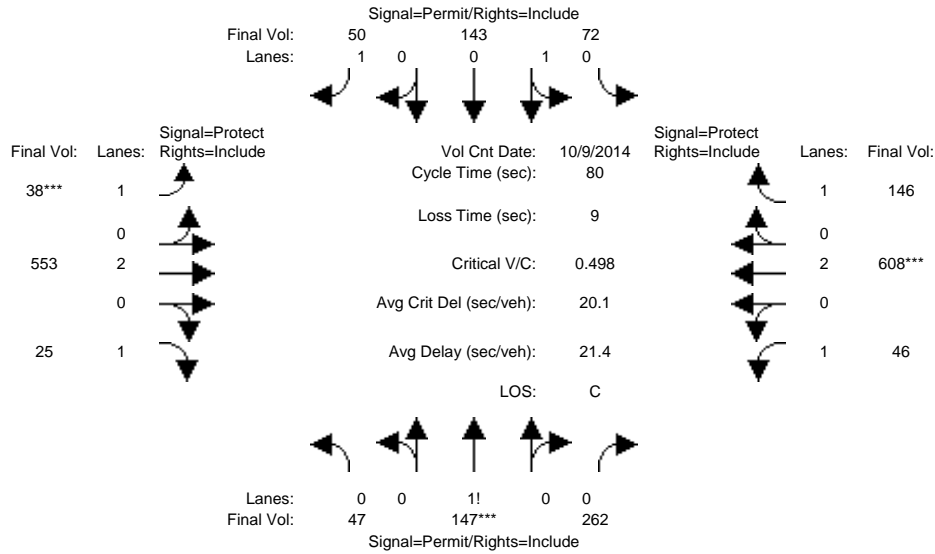

Approach:	North Bound			South Bound			East Bound			West Bound		
	L	T	R	L	T	R	L	T	R	L	T	R
Min. Green:	10	10	10	10	10	10	7	10	10	7	10	10
Y+R:	4.0	4.0	4.0	4.0	4.0	4.0	4.0	4.0	4.0	4.0	4.0	4.0
Volume Module: >> Count Date: 9 Oct 2014 <<												
Base Vol:	47	147	262	72	143	50	38	553	25	46	608	146
Growth Adj:	1.00	1.00	1.00	1.00	1.00	1.00	1.00	1.00	1.00	1.00	1.00	1.00
Initial Bse:	47	147	262	72	143	50	38	553	25	46	608	146
Added Vol:	0	0	0	0	0	0	0	0	0	0	0	0
PasserByVol:	0	0	0	0	0	0	0	0	0	0	0	0
Initial Fut:	47	147	262	72	143	50	38	553	25	46	608	146
User Adj:	1.00	1.00	1.00	1.00	1.00	1.00	1.00	1.00	1.00	1.00	1.00	1.00
PHF Adj:	1.00	1.00	1.00	1.00	1.00	1.00	1.00	1.00	1.00	1.00	1.00	1.00
PHF Volume:	47	147	262	72	143	50	38	553	25	46	608	146
Reduct Vol:	0	0	0	0	0	0	0	0	0	0	0	0
Reduced Vol:	47	147	262	72	143	50	38	553	25	46	608	146
PCE Adj:	1.00	1.00	1.00	1.00	1.00	1.00	1.00	1.00	1.00	1.00	1.00	1.00
MLF Adj:	1.00	1.00	1.00	1.00	1.00	1.00	1.00	1.00	1.00	1.00	1.00	1.00
FinalVolume:	47	147	262	72	143	50	38	553	25	46	608	146
Saturation Flow Module:												
Sat/Lane:	1900	1900	1900	1900	1900	1900	1900	1900	1900	1900	1900	1900
Adjustment:	0.92	0.92	0.92	0.95	0.95	0.92	0.92	1.00	0.92	0.92	1.00	0.92
Lanes:	0.10	0.32	0.58	0.33	0.67	1.00	1.00	2.00	1.00	1.00	2.00	1.00
Final Sat.:	180	564	1005	603	1197	1750	1750	3800	1750	1750	3800	1750
Capacity Analysis Module:												
Vol/Sat:	0.26	0.26	0.26	0.12	0.12	0.03	0.02	0.15	0.01	0.03	0.16	0.08
Crit Moves:	****						****			****		
Green Time:	39.7	39.7	39.7	39.7	39.7	39.7	7.0	19.6	19.6	11.8	24.3	24.3
Volume/Cap:	0.53	0.53	0.53	0.24	0.24	0.06	0.25	0.59	0.06	0.18	0.53	0.27
Delay/Veh:	14.4	14.4	14.4	11.7	11.7	10.5	34.9	27.8	23.2	30.2	23.5	21.4
User DelAdj:	1.00	1.00	1.00	1.00	1.00	1.00	1.00	1.00	1.00	1.00	1.00	1.00
AdjDel/Veh:	14.4	14.4	14.4	11.7	11.7	10.5	34.9	27.8	23.2	30.2	23.5	21.4
LOS by Move:	B	B	B	B	B	B	C	C	C	C	C	C
HCM2k95thQ:	15	15	15	6	6	1	2	12	1	2	12	6

Note: Queue reported is the number of cars per lane.

BART Phase II Extension Project

Level Of Service Computation Report
2000 HCM Operations (Future Volume Alternative)
PM - 2025 No Project Conditions

Intersection #3788: SANTA CLARA/28TH

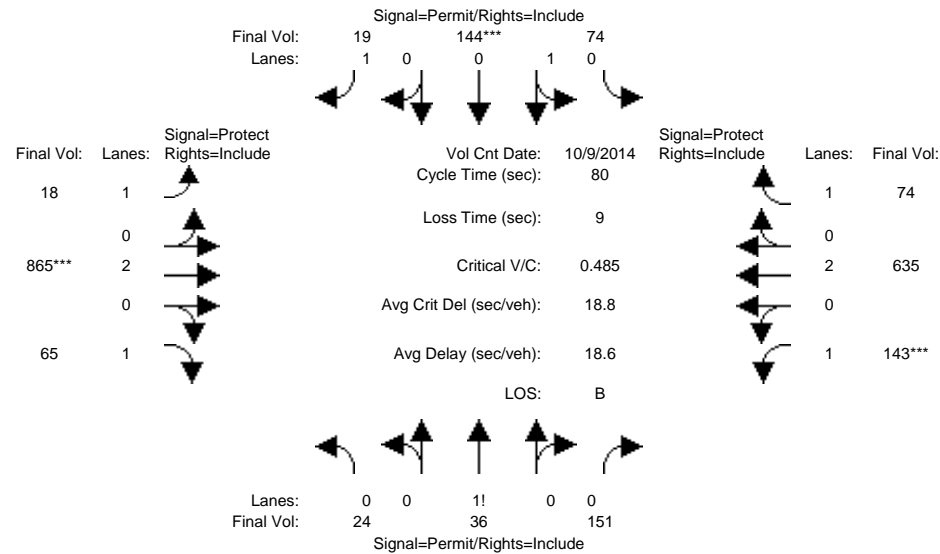

Approach:	North Bound			South Bound			East Bound			West Bound		
	L	T	R	L	T	R	L	T	R	L	T	R
Min. Green:	10	10	10	10	10	10	7	10	10	7	10	10
Y+R:	4.0	4.0	4.0	4.0	4.0	4.0	4.0	4.0	4.0	4.0	4.0	4.0
Volume Module: >> Count Date: 9 Oct 2014 <<												
Base Vol:	24	36	151	74	144	19	18	865	65	143	635	74
Growth Adj:	1.00	1.00	1.00	1.00	1.00	1.00	1.00	1.00	1.00	1.00	1.00	1.00
Initial Bse:	24	36	151	74	144	19	18	865	65	143	635	74
Added Vol:	0	0	0	0	0	0	0	0	0	0	0	0
PasserByVol:	0	0	0	0	0	0	0	0	0	0	0	0
Initial Fut:	24	36	151	74	144	19	18	865	65	143	635	74
User Adj:	1.00	1.00	1.00	1.00	1.00	1.00	1.00	1.00	1.00	1.00	1.00	1.00
PHF Adj:	1.00	1.00	1.00	1.00	1.00	1.00	1.00	1.00	1.00	1.00	1.00	1.00
PHF Volume:	24	36	151	74	144	19	18	865	65	143	635	74
Reduct Vol:	0	0	0	0	0	0	0	0	0	0	0	0
Reduced Vol:	24	36	151	74	144	19	18	865	65	143	635	74
PCE Adj:	1.00	1.00	1.00	1.00	1.00	1.00	1.00	1.00	1.00	1.00	1.00	1.00
MLF Adj:	1.00	1.00	1.00	1.00	1.00	1.00	1.00	1.00	1.00	1.00	1.00	1.00
FinalVolume:	24	36	151	74	144	19	18	865	65	143	635	74
Saturation Flow Module:												
Sat/Lane:	1900	1900	1900	1900	1900	1900	1900	1900	1900	1900	1900	1900
Adjustment:	0.92	0.92	0.92	0.95	0.95	0.92	0.92	1.00	0.92	0.92	1.00	0.92
Lanes:	0.11	0.17	0.72	0.34	0.66	1.00	1.00	2.00	1.00	1.00	2.00	1.00
Final Sat.:	199	299	1252	611	1189	1750	1750	3800	1750	1750	3800	1750
Capacity Analysis Module:												
Vol/Sat:	0.12	0.12	0.12	0.12	0.12	0.01	0.01	0.23	0.04	0.08	0.17	0.04
Crit Moves:				****			****			****		
Green Time:	20.0	20.0	20.0	20.0	20.0	20.0	17.5	37.5	37.5	13.5	33.5	33.5
Volume/Cap:	0.48	0.48	0.48	0.49	0.49	0.04	0.05	0.49	0.08	0.49	0.40	0.10
Delay/Veh:	26.4	26.4	26.4	26.4	26.4	22.8	24.7	14.8	11.7	31.4	16.4	14.2
User DelAdj:	1.00	1.00	1.00	1.00	1.00	1.00	1.00	1.00	1.00	1.00	1.00	1.00
AdjDel/Veh:	26.4	26.4	26.4	26.4	26.4	22.8	24.7	14.8	11.7	31.4	16.4	14.2
LOS by Move:	C	C	C	C	C	C	C	B	B	C	B	B
HCM2k95thQ:	9	9	9	10	10	1	1	14	2	7	10	2

Note: Queue reported is the number of cars per lane.

BART Phase II Extension Project

Level Of Service Computation Report
 2000 HCM Operations (Future Volume Alternative)
 AM - 2025 No Project Conditions

Intersection #3789: SANTA CLARA/21ST

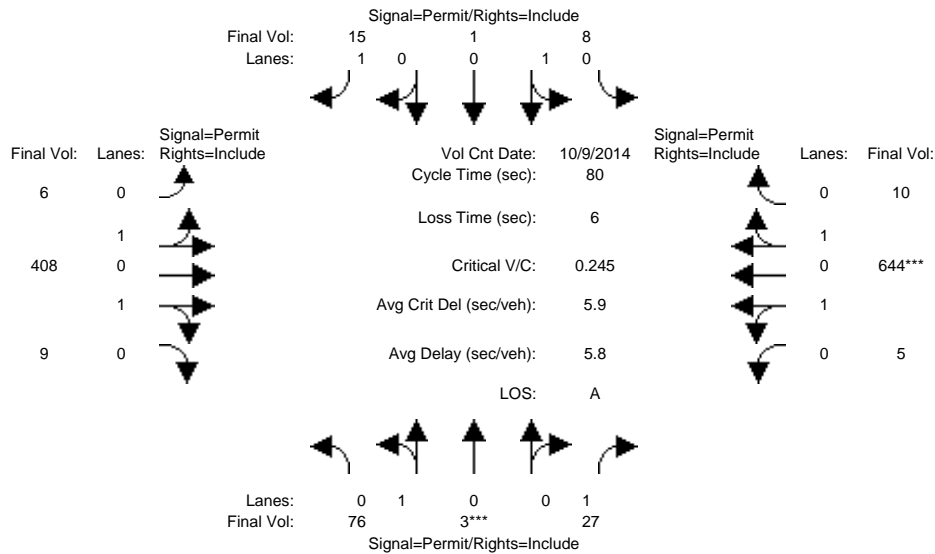

Approach:	North Bound			South Bound			East Bound			West Bound		
Movement:	L	T	R	L	T	R	L	T	R	L	T	R
Min. Green:	10	10	10	10	10	10	10	10	10	10	10	10
Y+R:	4.0	4.0	4.0	4.0	4.0	4.0	4.0	4.0	4.0	4.0	4.0	4.0
Volume Module: >> Count Date: 9 Oct 2014 <<												
Base Vol:	76	3	27	8	1	15	6	408	9	5	644	10
Growth Adj:	1.00	1.00	1.00	1.00	1.00	1.00	1.00	1.00	1.00	1.00	1.00	1.00
Initial Bse:	76	3	27	8	1	15	6	408	9	5	644	10
Added Vol:	0	0	0	0	0	0	0	0	0	0	0	0
PasserByVol:	0	0	0	0	0	0	0	0	0	0	0	0
Initial Fut:	76	3	27	8	1	15	6	408	9	5	644	10
User Adj:	1.00	1.00	1.00	1.00	1.00	1.00	1.00	1.00	1.00	1.00	1.00	1.00
PHF Adj:	1.00	1.00	1.00	1.00	1.00	1.00	1.00	1.00	1.00	1.00	1.00	1.00
PHF Volume:	76	3	27	8	1	15	6	408	9	5	644	10
Reduct Vol:	0	0	0	0	0	0	0	0	0	0	0	0
Reduced Vol:	76	3	27	8	1	15	6	408	9	5	644	10
PCE Adj:	1.00	1.00	1.00	1.00	1.00	1.00	1.00	1.00	1.00	1.00	1.00	1.00
MLF Adj:	1.00	1.00	1.00	1.00	1.00	1.00	1.00	1.00	1.00	1.00	1.00	1.00
FinalVolume:	76	3	27	8	1	15	6	408	9	5	644	10
Saturation Flow Module:												
Sat/Lane:	1900	1900	1900	1900	1900	1900	1900	1900	1900	1900	1900	1900
Adjustment:	0.95	0.95	0.92	0.95	0.95	0.92	0.95	0.95	0.95	0.95	0.95	0.95
Lanes:	0.96	0.04	1.00	0.89	0.11	1.00	0.03	1.93	0.04	0.02	1.95	0.03
Final Sat.:	1732	68	1750	1600	200	1750	51	3472	77	27	3518	55
Capacity Analysis Module:												
Vol/Sat:	0.04	0.04	0.02	0.01	0.01	0.01	0.12	0.12	0.12	0.18	0.18	0.18
Crit Moves:	****									****		
Green Time:	14.3	14.3	14.3	14.3	14.3	14.3	59.7	59.7	59.7	59.7	59.7	59.7
Volume/Cap:	0.25	0.25	0.09	0.03	0.03	0.05	0.16	0.16	0.16	0.25	0.25	0.25
Delay/Veh:	28.6	28.6	27.5	27.1	27.1	27.3	2.9	2.9	2.9	3.2	3.2	3.2
User DelAdj:	1.00	1.00	1.00	1.00	1.00	1.00	1.00	1.00	1.00	1.00	1.00	1.00
AdjDel/Veh:	28.6	28.6	27.5	27.1	27.1	27.3	2.9	2.9	2.9	3.2	3.2	3.2
LOS by Move:	C	C	C	C	C	C	A	A	A	A	A	A
HCM2k95thQ:	4	4	1	0	0	1	3	3	3	5	5	5

Note: Queue reported is the number of cars per lane.

BART Phase II Extension Project

Level Of Service Computation Report
2000 HCM Operations (Future Volume Alternative)
PM - 2025 No Project Conditions

Intersection #3789: SANTA CLARA/21ST

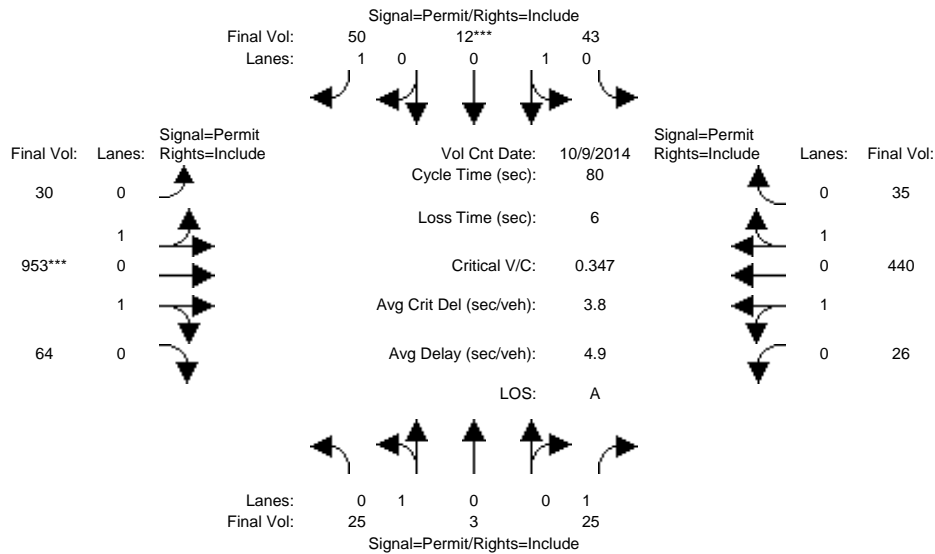

Approach:	North Bound			South Bound			East Bound			West Bound		
Movement:	L	T	R	L	T	R	L	T	R	L	T	R
Min. Green:	10	10	10	10	10	10	10	10	10	10	10	10
Y+R:	4.0	4.0	4.0	4.0	4.0	4.0	4.0	4.0	4.0	4.0	4.0	4.0
Volume Module: >> Count Date: 9 Oct 2014 <<												
Base Vol:	25	3	25	43	12	50	30	953	64	26	440	35
Growth Adj:	1.00	1.00	1.00	1.00	1.00	1.00	1.00	1.00	1.00	1.00	1.00	1.00
Initial Bse:	25	3	25	43	12	50	30	953	64	26	440	35
Added Vol:	0	0	0	0	0	0	0	0	0	0	0	0
PasserByVol:	0	0	0	0	0	0	0	0	0	0	0	0
Initial Fut:	25	3	25	43	12	50	30	953	64	26	440	35
User Adj:	1.00	1.00	1.00	1.00	1.00	1.00	1.00	1.00	1.00	1.00	1.00	1.00
PHF Adj:	1.00	1.00	1.00	1.00	1.00	1.00	1.00	1.00	1.00	1.00	1.00	1.00
PHF Volume:	25	3	25	43	12	50	30	953	64	26	440	35
Reduct Vol:	0	0	0	0	0	0	0	0	0	0	0	0
Reduced Vol:	25	3	25	43	12	50	30	953	64	26	440	35
PCE Adj:	1.00	1.00	1.00	1.00	1.00	1.00	1.00	1.00	1.00	1.00	1.00	1.00
MLF Adj:	1.00	1.00	1.00	1.00	1.00	1.00	1.00	1.00	1.00	1.00	1.00	1.00
FinalVolume:	25	3	25	43	12	50	30	953	64	26	440	35
Saturation Flow Module:												
Sat/Lane:	1900	1900	1900	1900	1900	1900	1900	1900	1900	1900	1900	1900
Adjustment:	0.95	0.95	0.92	0.95	0.95	0.92	0.95	0.95	0.95	0.95	0.95	0.95
Lanes:	0.89	0.11	1.00	0.78	0.22	1.00	0.06	1.82	0.12	0.10	1.76	0.14
Final Sat.:	1607	193	1750	1407	393	1750	103	3277	220	187	3162	251
Capacity Analysis Module:												
Vol/Sat:	0.02	0.02	0.01	0.03	0.03	0.03	0.29	0.29	0.29	0.14	0.14	0.14
Crit Moves:				****			****					
Green Time:	10.0	10.0	10.0	10.0	10.0	10.0	64.0	64.0	64.0	64.0	64.0	64.0
Volume/Cap:	0.12	0.12	0.11	0.24	0.24	0.23	0.36	0.36	0.36	0.17	0.17	0.17
Delay/Veh:	31.4	31.4	31.3	32.2	32.2	32.1	2.3	2.3	2.3	1.9	1.9	1.9
User DelAdj:	1.00	1.00	1.00	1.00	1.00	1.00	1.00	1.00	1.00	1.00	1.00	1.00
AdjDel/Veh:	31.4	31.4	31.3	32.2	32.2	32.1	2.3	2.3	2.3	1.9	1.9	1.9
LOS by Move:	C	C	C	C	C	C	A	A	A	A	A	A
HCM2k95thQ:	2	2	1	3	3	3	8	8	8	3	3	3

Note: Queue reported is the number of cars per lane.

BART Phase II Extension Project

Level Of Service Computation Report
 2000 HCM Operations (Future Volume Alternative)
 AM - 2025 No Project Conditions

Intersection #3790: SANTA CLARA/24TH

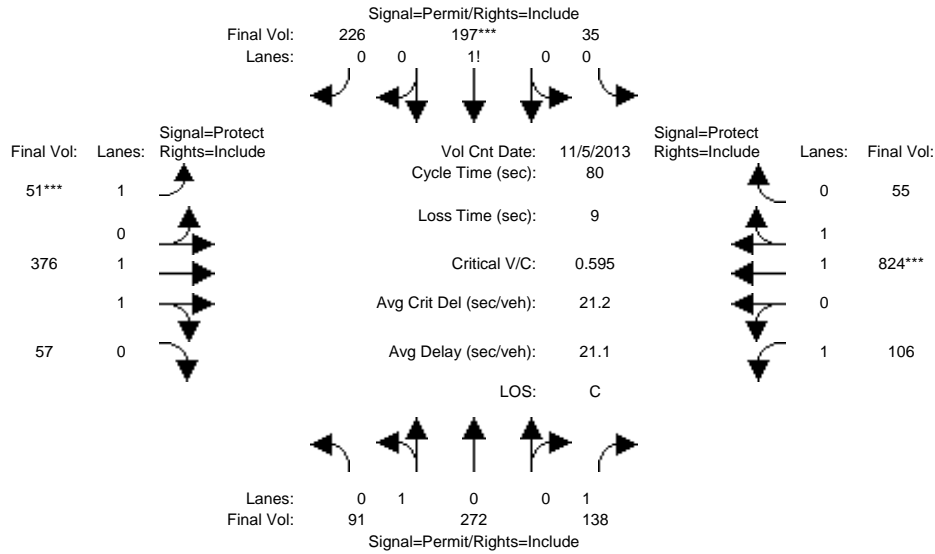

Approach:	North Bound			South Bound			East Bound			West Bound		
Movement:	L	T	R	L	T	R	L	T	R	L	T	R
Min. Green:	10	10	10	10	10	10	7	10	10	7	10	10
Y+R:	4.0	4.0	4.0	4.0	4.0	4.0	4.0	4.0	4.0	4.0	4.0	4.0
Volume Module: >> Count Date: 5 Nov 2013 <<												
Base Vol:	91	272	138	35	197	226	51	376	57	106	824	55
Growth Adj:	1.00	1.00	1.00	1.00	1.00	1.00	1.00	1.00	1.00	1.00	1.00	1.00
Initial Bse:	91	272	138	35	197	226	51	376	57	106	824	55
Added Vol:	0	0	0	0	0	0	0	0	0	0	0	0
PasserByVol:	0	0	0	0	0	0	0	0	0	0	0	0
Initial Fut:	91	272	138	35	197	226	51	376	57	106	824	55
User Adj:	1.00	1.00	1.00	1.00	1.00	1.00	1.00	1.00	1.00	1.00	1.00	1.00
PHF Adj:	1.00	1.00	1.00	1.00	1.00	1.00	1.00	1.00	1.00	1.00	1.00	1.00
PHF Volume:	91	272	138	35	197	226	51	376	57	106	824	55
Reduct Vol:	0	0	0	0	0	0	0	0	0	0	0	0
Reduced Vol:	91	272	138	35	197	226	51	376	57	106	824	55
PCE Adj:	1.00	1.00	1.00	1.00	1.00	1.00	1.00	1.00	1.00	1.00	1.00	1.00
MLF Adj:	1.00	1.00	1.00	1.00	1.00	1.00	1.00	1.00	1.00	1.00	1.00	1.00
FinalVolume:	91	272	138	35	197	226	51	376	57	106	824	55
Saturation Flow Module:												
Sat/Lane:	1900	1900	1900	1900	1900	1900	1900	1900	1900	1900	1900	1900
Adjustment:	0.95	0.95	0.92	0.92	0.92	0.92	0.92	0.98	0.95	0.92	0.98	0.95
Lanes:	0.25	0.75	1.00	0.08	0.43	0.49	1.00	1.73	0.27	1.00	1.87	0.13
Final Sat.:	451	1349	1750	134	753	864	1750	3213	487	1750	3468	232
Capacity Analysis Module:												
Vol/Sat:	0.20	0.20	0.08	0.26	0.26	0.26	0.03	0.12	0.12	0.06	0.24	0.24
Crit Moves:				****			****			****		
Green Time:	33.5	33.5	33.5	33.5	33.5	33.5	7.0	22.0	22.0	15.4	30.5	30.5
Volume/Cap:	0.48	0.48	0.19	0.62	0.62	0.62	0.33	0.42	0.42	0.31	0.62	0.62
Delay/Veh:	17.4	17.4	14.8	20.0	20.0	20.0	35.6	24.1	24.1	28.3	21.0	21.0
User DelAdj:	1.00	1.00	1.00	1.00	1.00	1.00	1.00	1.00	1.00	1.00	1.00	1.00
AdjDel/Veh:	17.4	17.4	14.8	20.0	20.0	20.0	35.6	24.1	24.1	28.3	21.0	21.0
LOS by Move:	B	B	B	B	B	B	D	C	C	C	C	C
HCM2k95thQ:	13	13	5	19	19	19	3	9	9	5	17	17

Note: Queue reported is the number of cars per lane.

BART Phase II Extension Project

Level Of Service Computation Report
 2000 HCM Operations (Future Volume Alternative)
 PM - 2025 No Project Conditions

Intersection #3790: SANTA CLARA/24TH

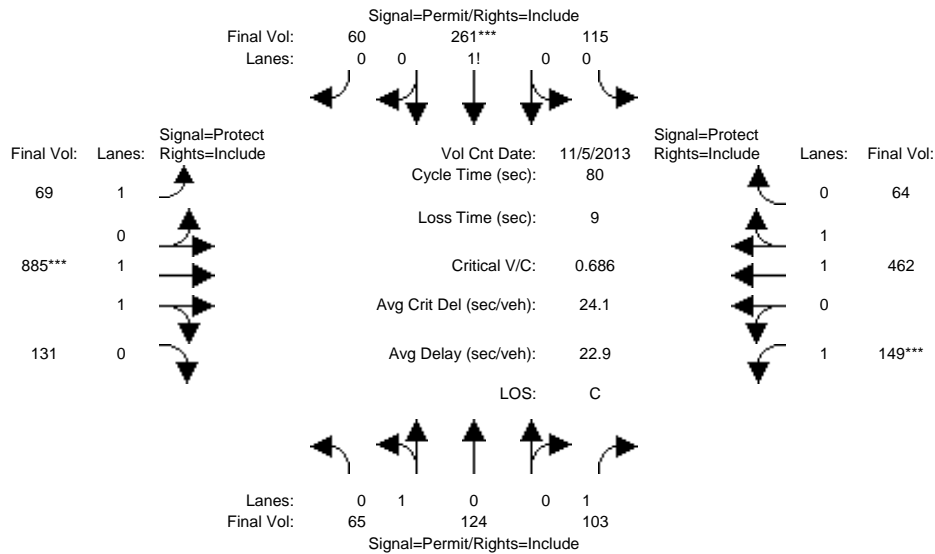

Approach:	North Bound			South Bound			East Bound			West Bound		
	L	T	R	L	T	R	L	T	R	L	T	R
Min. Green:	10	10	10	10	10	10	7	10	10	7	10	10
Y+R:	4.0	4.0	4.0	4.0	4.0	4.0	4.0	4.0	4.0	4.0	4.0	4.0

Volume Module:	>> Count Date: 5 Nov 2013 <<											
Base Vol:	65	124	103	115	261	60	69	885	131	149	462	64
Growth Adj:	1.00	1.00	1.00	1.00	1.00	1.00	1.00	1.00	1.00	1.00	1.00	1.00
Initial Bse:	65	124	103	115	261	60	69	885	131	149	462	64
Added Vol:	0	0	0	0	0	0	0	0	0	0	0	0
PasserByVol:	0	0	0	0	0	0	0	0	0	0	0	0
Initial Fut:	65	124	103	115	261	60	69	885	131	149	462	64
User Adj:	1.00	1.00	1.00	1.00	1.00	1.00	1.00	1.00	1.00	1.00	1.00	1.00
PHF Adj:	1.00	1.00	1.00	1.00	1.00	1.00	1.00	1.00	1.00	1.00	1.00	1.00
PHF Volume:	65	124	103	115	261	60	69	885	131	149	462	64
Reduct Vol:	0	0	0	0	0	0	0	0	0	0	0	0
Reduced Vol:	65	124	103	115	261	60	69	885	131	149	462	64
PCE Adj:	1.00	1.00	1.00	1.00	1.00	1.00	1.00	1.00	1.00	1.00	1.00	1.00
MLF Adj:	1.00	1.00	1.00	1.00	1.00	1.00	1.00	1.00	1.00	1.00	1.00	1.00
FinalVolume:	65	124	103	115	261	60	69	885	131	149	462	64

Saturation Flow Module:												
Sat/Lane:	1900	1900	1900	1900	1900	1900	1900	1900	1900	1900	1900	1900
Adjustment:	0.95	0.95	0.92	0.92	0.92	0.92	0.92	0.98	0.95	0.92	0.98	0.95
Lanes:	0.34	0.66	1.00	0.26	0.60	0.14	1.00	1.73	0.27	1.00	1.75	0.25
Final Sat.:	619	1181	1750	462	1048	241	1750	3223	477	1750	3249	450

Capacity Analysis Module:												
Vol/Sat:	0.11	0.11	0.06	0.25	0.25	0.25	0.04	0.27	0.27	0.09	0.14	0.14
Crit Moves:				****	****	****	****	****	****	****	****	****
Green Time:	29.1	29.1	29.1	29.1	29.1	29.1	16.0	32.0	32.0	9.9	26.0	26.0
Volume/Cap:	0.29	0.29	0.16	0.69	0.69	0.69	0.20	0.69	0.69	0.69	0.44	0.44
Delay/Veh:	18.4	18.4	17.4	24.7	24.7	24.7	26.9	21.2	21.2	42.4	21.5	21.5
User DelAdj:	1.00	1.00	1.00	1.00	1.00	1.00	1.00	1.00	1.00	1.00	1.00	1.00
AdjDel/Veh:	18.4	18.4	17.4	24.7	24.7	24.7	26.9	21.2	21.2	42.4	21.5	21.5
LOS by Move:	B	B	B	C	C	C	C	C	C	D	C	C
HCM2k95thQ:	7	7	4	20	20	20	3	20	20	8	10	10

Note: Queue reported is the number of cars per lane.

BART Phase II Extension Project

Level Of Service Computation Report
2000 HCM Operations (Future Volume Alternative)
AM - 2025 No Project Conditions

Intersection #3832: 24TH/WILLIAM

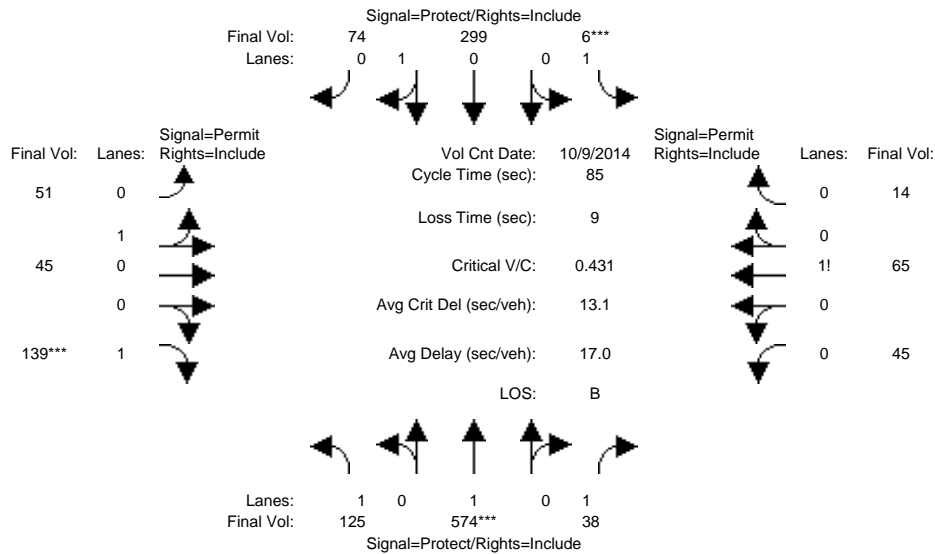

Approach:	North Bound			South Bound			East Bound			West Bound		
	L	T	R	L	T	R	L	T	R	L	T	R
Min. Green:	7	10	10	7	10	10	10	10	10	10	10	10
Y+R:	4.0	4.0	4.0	4.0	4.0	4.0	4.0	4.0	4.0	4.0	4.0	4.0
Volume Module: >> Count Date: 9 Oct 2014 <<												
Base Vol:	125	574	38	6	299	74	51	45	139	45	65	14
Growth Adj:	1.00	1.00	1.00	1.00	1.00	1.00	1.00	1.00	1.00	1.00	1.00	1.00
Initial Bse:	125	574	38	6	299	74	51	45	139	45	65	14
Added Vol:	0	0	0	0	0	0	0	0	0	0	0	0
PasserByVol:	0	0	0	0	0	0	0	0	0	0	0	0
Initial Fut:	125	574	38	6	299	74	51	45	139	45	65	14
User Adj:	1.00	1.00	1.00	1.00	1.00	1.00	1.00	1.00	1.00	1.00	1.00	1.00
PHF Adj:	1.00	1.00	1.00	1.00	1.00	1.00	1.00	1.00	1.00	1.00	1.00	1.00
PHF Volume:	125	574	38	6	299	74	51	45	139	45	65	14
Reduct Vol:	0	0	0	0	0	0	0	0	0	0	0	0
Reduced Vol:	125	574	38	6	299	74	51	45	139	45	65	14
PCE Adj:	1.00	1.00	1.00	1.00	1.00	1.00	1.00	1.00	1.00	1.00	1.00	1.00
MLF Adj:	1.00	1.00	1.00	1.00	1.00	1.00	1.00	1.00	1.00	1.00	1.00	1.00
Final Volume:	125	574	38	6	299	74	51	45	139	45	65	14
Saturation Flow Module:												
Sat/Lane:	1900	1900	1900	1900	1900	1900	1900	1900	1900	1900	1900	1900
Adjustment:	0.92	1.00	0.92	0.92	0.95	0.95	0.95	0.95	0.92	0.92	0.92	0.92
Lanes:	1.00	1.00	1.00	1.00	0.80	0.20	0.53	0.47	1.00	0.36	0.53	0.11
Final Sat.:	1750	1900	1750	1750	1443	357	956	844	1750	635	917	198
Capacity Analysis Module:												
Vol/Sat:	0.07	0.30	0.02	0.00	0.21	0.21	0.05	0.05	0.08	0.07	0.07	0.07
Crit Moves:	****			****			****			****		
Green Time:	17.5	54.6	54.6	7.0	44.1	44.1	14.4	14.4	14.4	14.4	14.4	14.4
Volume/Cap:	0.35	0.47	0.03	0.04	0.40	0.40	0.32	0.32	0.47	0.42	0.42	0.42
Delay/Veh:	29.4	8.1	5.6	36.0	12.7	12.7	31.6	31.6	33.1	32.6	32.6	32.6
User DelAdj:	1.00	1.00	1.00	1.00	1.00	1.00	1.00	1.00	1.00	1.00	1.00	1.00
AdjDel/Veh:	29.4	8.1	5.6	36.0	12.7	12.7	31.6	31.6	33.1	32.6	32.6	32.6
LOS by Move:	C	A	A	D	B	B	C	C	C	C	C	C
HCM2k95thQ:	6	14	1	0	12	12	5	5	8	7	7	7

Note: Queue reported is the number of cars per lane.

BART Phase II Extension Project

Level Of Service Computation Report
 2000 HCM Operations (Future Volume Alternative)
 PM - 2025 No Project Conditions

Intersection #3832: 24TH/WILLIAM

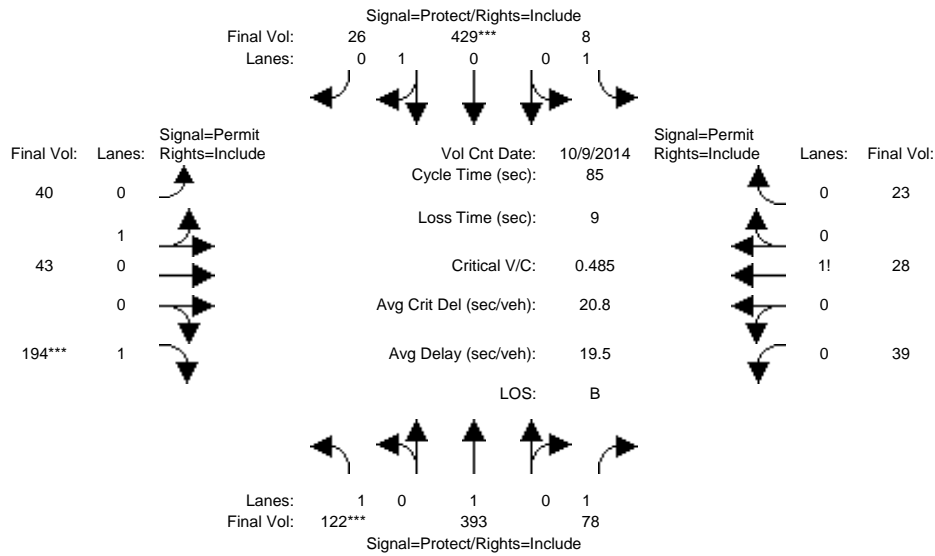

Approach:	North Bound			South Bound			East Bound			West Bound		
Movement:	L	T	R	L	T	R	L	T	R	L	T	R
Min. Green:	7	10	10	7	10	10	10	10	10	10	10	10
Y+R:	4.0	4.0	4.0	4.0	4.0	4.0	4.0	4.0	4.0	4.0	4.0	4.0
Volume Module: >> Count Date: 9 Oct 2014 <<												
Base Vol:	122	393	78	8	429	26	40	43	194	39	28	23
Growth Adj:	1.00	1.00	1.00	1.00	1.00	1.00	1.00	1.00	1.00	1.00	1.00	1.00
Initial Bse:	122	393	78	8	429	26	40	43	194	39	28	23
Added Vol:	0	0	0	0	0	0	0	0	0	0	0	0
PasserByVol:	0	0	0	0	0	0	0	0	0	0	0	0
Initial Fut:	122	393	78	8	429	26	40	43	194	39	28	23
User Adj:	1.00	1.00	1.00	1.00	1.00	1.00	1.00	1.00	1.00	1.00	1.00	1.00
PHF Adj:	1.00	1.00	1.00	1.00	1.00	1.00	1.00	1.00	1.00	1.00	1.00	1.00
PHF Volume:	122	393	78	8	429	26	40	43	194	39	28	23
Reduct Vol:	0	0	0	0	0	0	0	0	0	0	0	0
Reduced Vol:	122	393	78	8	429	26	40	43	194	39	28	23
PCE Adj:	1.00	1.00	1.00	1.00	1.00	1.00	1.00	1.00	1.00	1.00	1.00	1.00
MLF Adj:	1.00	1.00	1.00	1.00	1.00	1.00	1.00	1.00	1.00	1.00	1.00	1.00
Final Volume:	122	393	78	8	429	26	40	43	194	39	28	23
Saturation Flow Module:												
Sat/Lane:	1900	1900	1900	1900	1900	1900	1900	1900	1900	1900	1900	1900
Adjustment:	0.92	1.00	0.92	0.92	0.95	0.95	0.95	0.95	0.92	0.92	0.92	0.92
Lanes:	1.00	1.00	1.00	1.00	0.94	0.06	0.48	0.52	1.00	0.43	0.31	0.26
Final Sat.:	1750	1900	1750	1750	1697	103	867	933	1750	758	544	447
Capacity Analysis Module:												
Vol/Sat:	0.07	0.21	0.04	0.00	0.25	0.25	0.05	0.05	0.11	0.05	0.05	0.05
Crit Moves:	****				****				****			
Green Time:	12.2	40.5	40.5	16.1	44.3	44.3	19.4	19.4	19.4	19.4	19.4	19.4
Volume/Cap:	0.48	0.43	0.09	0.02	0.48	0.48	0.20	0.20	0.48	0.22	0.22	0.22
Delay/Veh:	35.0	15.1	12.3	28.1	13.4	13.4	26.7	26.7	29.4	26.9	26.9	26.9
User DelAdj:	1.00	1.00	1.00	1.00	1.00	1.00	1.00	1.00	1.00	1.00	1.00	1.00
AdjDel/Veh:	35.0	15.1	12.3	28.1	13.4	13.4	26.7	26.7	29.4	26.9	26.9	26.9
LOS by Move:	C	B	B	C	B	B	C	C	C	C	C	C
HCM2k95thQ:	6	13	2	0	15	15	4	4	10	4	4	4

Note: Queue reported is the number of cars per lane.

BART Phase II Extension Project

Level Of Service Computation Report
 2000 HCM Operations (Future Volume Alternative)
 AM - 2025 No Project Conditions

Intersection #4005: JULIAN/28TH

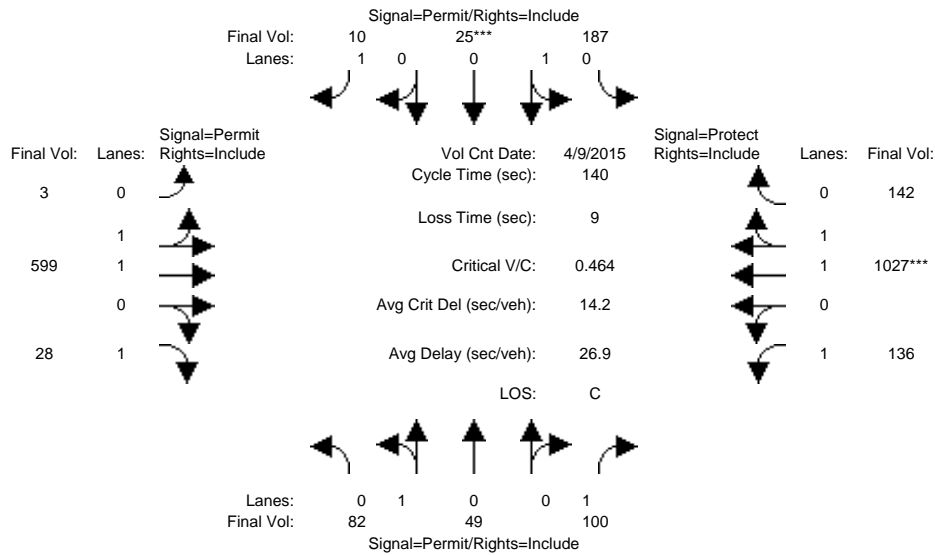

Approach:	North Bound			South Bound			East Bound			West Bound			
	L	T	R	L	T	R	L	T	R	L	T	R	
Min. Green:	10	10	10	10	10	10	10	10	10	7	10	10	
Y+R:	4.0	4.0	4.0	4.0	4.0	4.0	4.0	4.0	4.0	4.0	4.0	4.0	
Volume Module: >> Count Date: 9 Apr 2015 <<													
Base Vol:	82	49	100	187	25	10	3	599	28	136	1027	142	
Growth Adj:	1.00	1.00	1.00	1.00	1.00	1.00	1.00	1.00	1.00	1.00	1.00	1.00	
Initial Bse:	82	49	100	187	25	10	3	599	28	136	1027	142	
Added Vol:	0	0	0	0	0	0	0	0	0	0	0	0	
PasserByVol:	0	0	0	0	0	0	0	0	0	0	0	0	
Initial Fut:	82	49	100	187	25	10	3	599	28	136	1027	142	
User Adj:	1.00	1.00	1.00	1.00	1.00	1.00	1.00	1.00	1.00	1.00	1.00	1.00	
PHF Adj:	1.00	1.00	1.00	1.00	1.00	1.00	1.00	1.00	1.00	1.00	1.00	1.00	
PHF Volume:	82	49	100	187	25	10	3	599	28	136	1027	142	
Reduct Vol:	0	0	0	0	0	0	0	0	0	0	0	0	
Reduced Vol:	82	49	100	187	25	10	3	599	28	136	1027	142	
PCE Adj:	1.00	1.00	1.00	1.00	1.00	1.00	1.00	1.00	1.00	1.00	1.00	1.00	
MLF Adj:	1.00	1.00	1.00	1.00	1.00	1.00	1.00	1.00	1.00	1.00	1.00	1.00	
FinalVolume:	82	49	100	187	25	10	3	599	28	136	1027	142	
Saturation Flow Module:													
Sat/Lane:	1900	1900	1900	1900	1900	1900	1900	1900	1900	1900	1900	1900	
Adjustment:	0.95	0.95	0.92	0.95	0.95	0.92	0.95	0.97	0.92	0.92	0.98	0.95	
Lanes:	0.63	0.37	1.00	0.88	0.12	1.00	0.01	1.99	1.00	1.00	1.75	0.25	
Final Sat.:	1127	673	1750	1588	212	1750	18	3682	1750	1750	3250	449	
Capacity Analysis Module:													
Vol/Sat:	0.07	0.07	0.06	0.12	0.12	0.01	0.16	0.16	0.02	0.08	0.32	0.32	
Crit Moves:							****						
Green Time:	25.9	25.9	25.9	25.9	25.9	25.9	35.7	35.7	35.7	69.4	105	105.1	
Volume/Cap:	0.39	0.39	0.31	0.64	0.64	0.03	0.64	0.64	0.06	0.16	0.42	0.42	
Delay/Veh:	50.9	50.9	49.9	56.8	56.8	46.8	47.8	47.8	39.5	19.4	6.5	6.5	
User DelAdj:	1.00	1.00	1.00	1.00	1.00	1.00	1.00	1.00	1.00	1.00	1.00	1.00	
AdjDel/Veh:	50.9	50.9	49.9	56.8	56.8	46.8	47.8	47.8	39.5	19.4	6.5	6.5	
LOS by Move:	D	D	D	E	E	D	D	D	D	B	A	A	
HCM2k95thQ:	10	10	8	18	18	1	21	21	2	7	17	17	

Note: Queue reported is the number of cars per lane.

BART Phase II Extension Project

Level Of Service Computation Report
2000 HCM Operations (Future Volume Alternative)
PM - 2025 No Project Conditions

Intersection #4005: JULIAN/28TH

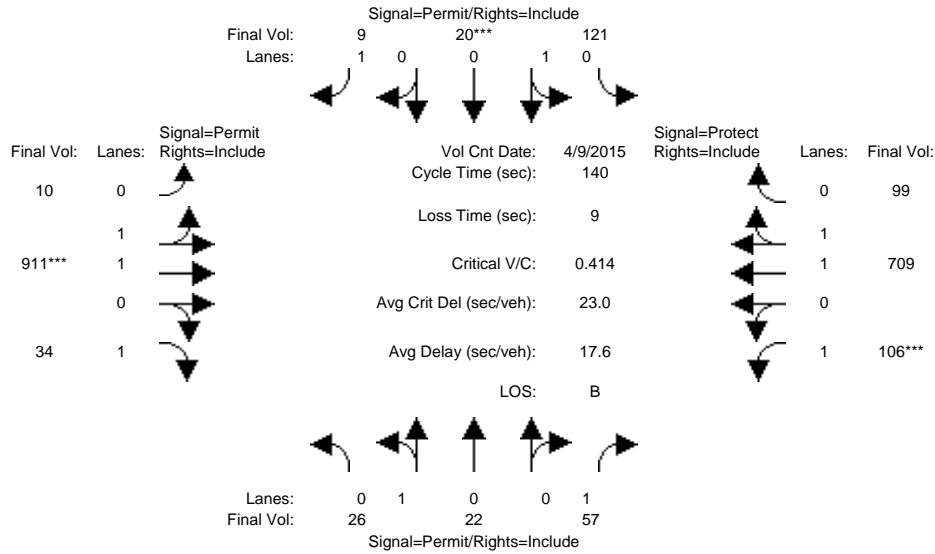

Approach:	North Bound			South Bound			East Bound			West Bound		
	L	T	R	L	T	R	L	T	R	L	T	R
Min. Green:	10	10	10	10	10	10	10	10	10	7	10	10
Y+R:	4.0	4.0	4.0	4.0	4.0	4.0	4.0	4.0	4.0	4.0	4.0	4.0
Volume Module: >> Count Date: 9 Apr 2015 <<												
Base Vol:	26	22	57	121	20	9	10	911	34	106	709	99
Growth Adj:	1.00	1.00	1.00	1.00	1.00	1.00	1.00	1.00	1.00	1.00	1.00	1.00
Initial Bse:	26	22	57	121	20	9	10	911	34	106	709	99
Added Vol:	0	0	0	0	0	0	0	0	0	0	0	0
PasserByVol:	0	0	0	0	0	0	0	0	0	0	0	0
Initial Fut:	26	22	57	121	20	9	10	911	34	106	709	99
User Adj:	1.00	1.00	1.00	1.00	1.00	1.00	1.00	1.00	1.00	1.00	1.00	1.00
PHF Adj:	1.00	1.00	1.00	1.00	1.00	1.00	1.00	1.00	1.00	1.00	1.00	1.00
PHF Volume:	26	22	57	121	20	9	10	911	34	106	709	99
Reduct Vol:	0	0	0	0	0	0	0	0	0	0	0	0
Reduced Vol:	26	22	57	121	20	9	10	911	34	106	709	99
PCE Adj:	1.00	1.00	1.00	1.00	1.00	1.00	1.00	1.00	1.00	1.00	1.00	1.00
MLF Adj:	1.00	1.00	1.00	1.00	1.00	1.00	1.00	1.00	1.00	1.00	1.00	1.00
FinalVolume:	26	22	57	121	20	9	10	911	34	106	709	99
Saturation Flow Module:												
Sat/Lane:	1900	1900	1900	1900	1900	1900	1900	1900	1900	1900	1900	1900
Adjustment:	0.95	0.95	0.92	0.95	0.95	0.92	0.95	0.97	0.92	0.92	0.98	0.95
Lanes:	0.54	0.46	1.00	0.86	0.14	1.00	0.02	1.98	1.00	1.00	1.75	0.25
Final Sat.:	975	825	1750	1545	255	1750	40	3660	1750	1750	3246	453
Capacity Analysis Module:												
Vol/Sat:	0.03	0.03	0.03	0.08	0.08	0.01	0.25	0.25	0.02	0.06	0.22	0.22
Crit Moves:				****			****			****		
Green Time:	26.5	26.5	26.5	26.5	26.5	26.5	84.1	84.1	84.1	20.5	105	104.5
Volume/Cap:	0.14	0.14	0.17	0.41	0.41	0.03	0.41	0.41	0.03	0.41	0.29	0.29
Delay/Veh:	47.5	47.5	47.8	50.8	50.8	46.3	15.0	15.0	11.4	55.4	5.8	5.8
User DelAdj:	1.00	1.00	1.00	1.00	1.00	1.00	1.00	1.00	1.00	1.00	1.00	1.00
AdjDel/Veh:	47.5	47.5	47.8	50.8	50.8	46.3	15.0	15.0	11.4	55.4	5.8	5.8
LOS by Move:	D	D	D	D	D	D	B	B	B	E	A	A
HCM2k95thQ:	4	4	4	11	11	1	19	19	1	9	11	11

Note: Queue reported is the number of cars per lane.

BART Phase II Extension Project

Level Of Service Computation Report
2000 HCM Operations (Future Volume Alternative)
AM - 2025 No Project Conditions

Intersection #4022: SANTA CLARA/26TH

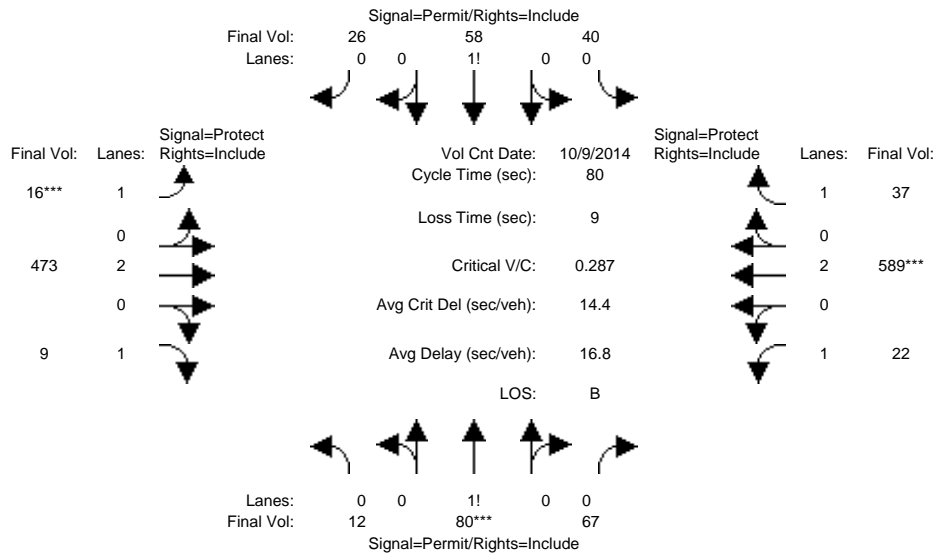

Approach:	North Bound			South Bound			East Bound			West Bound		
Movement:	L	T	R	L	T	R	L	T	R	L	T	R
Min. Green:	10	10	10	10	10	10	7	10	10	7	10	10
Y+R:	4.0	4.0	4.0	4.0	4.0	4.0	4.0	4.0	4.0	4.0	4.0	4.0
Volume Module: >> Count Date: 9 Oct 2014 <<												
Base Vol:	12	80	67	40	58	26	16	473	9	22	589	37
Growth Adj:	1.00	1.00	1.00	1.00	1.00	1.00	1.00	1.00	1.00	1.00	1.00	1.00
Initial Bse:	12	80	67	40	58	26	16	473	9	22	589	37
Added Vol:	0	0	0	0	0	0	0	0	0	0	0	0
PasserByVol:	0	0	0	0	0	0	0	0	0	0	0	0
Initial Fut:	12	80	67	40	58	26	16	473	9	22	589	37
User Adj:	1.00	1.00	1.00	1.00	1.00	1.00	1.00	1.00	1.00	1.00	1.00	1.00
PHF Adj:	1.00	1.00	1.00	1.00	1.00	1.00	1.00	1.00	1.00	1.00	1.00	1.00
PHF Volume:	12	80	67	40	58	26	16	473	9	22	589	37
Reduct Vol:	0	0	0	0	0	0	0	0	0	0	0	0
Reduced Vol:	12	80	67	40	58	26	16	473	9	22	589	37
PCE Adj:	1.00	1.00	1.00	1.00	1.00	1.00	1.00	1.00	1.00	1.00	1.00	1.00
MLF Adj:	1.00	1.00	1.00	1.00	1.00	1.00	1.00	1.00	1.00	1.00	1.00	1.00
FinalVolume:	12	80	67	40	58	26	16	473	9	22	589	37
Saturation Flow Module:												
Sat/Lane:	1900	1900	1900	1900	1900	1900	1900	1900	1900	1900	1900	1900
Adjustment:	0.92	0.92	0.92	0.92	0.92	0.92	0.92	1.00	0.92	0.92	1.00	0.92
Lanes:	0.08	0.50	0.42	0.32	0.47	0.21	1.00	2.00	1.00	1.00	2.00	1.00
Final Sat.:	132	881	737	565	819	367	1750	3800	1750	1750	3800	1750
Capacity Analysis Module:												
Vol/Sat:	0.09	0.09	0.09	0.07	0.07	0.07	0.01	0.12	0.01	0.01	0.16	0.02
Crit Moves:	****			****			****			****		
Green Time:	23.7	23.7	23.7	23.7	23.7	23.7	7.0	27.9	27.9	19.5	40.3	40.3
Volume/Cap:	0.31	0.31	0.31	0.24	0.24	0.24	0.10	0.36	0.01	0.05	0.31	0.04
Delay/Veh:	22.2	22.2	22.2	21.6	21.6	21.6	33.9	19.6	17.1	23.2	11.7	10.1
User DelAdj:	1.00	1.00	1.00	1.00	1.00	1.00	1.00	1.00	1.00	1.00	1.00	1.00
AdjDel/Veh:	22.2	22.2	22.2	21.6	21.6	21.6	33.9	19.6	17.1	23.2	11.7	10.1
LOS by Move:	C	C	C	C	C	C	C	B	B	C	B	B
HCM2k95thQ:	7	7	7	5	5	5	1	8	0	1	8	1

Note: Queue reported is the number of cars per lane.

BART Phase II Extension Project

Level Of Service Computation Report
 2000 HCM Operations (Future Volume Alternative)
 PM - 2025 No Project Conditions

Intersection #4022: SANTA CLARA/26TH

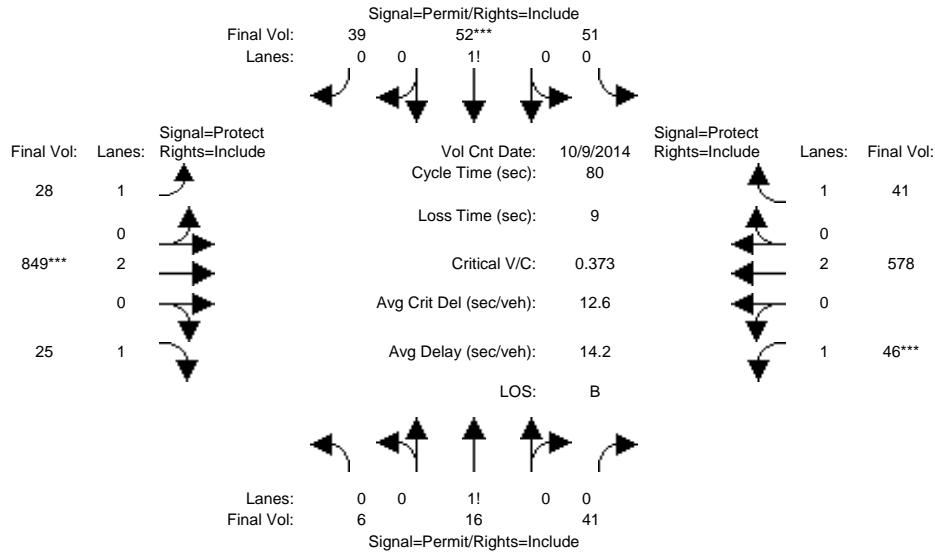

Approach:	North Bound			South Bound			East Bound			West Bound		
	L	T	R	L	T	R	L	T	R	L	T	R
Min. Green:	10	10	10	10	10	10	7	10	10	7	10	10
Y+R:	4.0	4.0	4.0	4.0	4.0	4.0	4.0	4.0	4.0	4.0	4.0	4.0
Volume Module: >> Count Date: 9 Oct 2014 <<												
Base Vol:	6	16	41	51	52	39	28	849	25	46	578	41
Growth Adj:	1.00	1.00	1.00	1.00	1.00	1.00	1.00	1.00	1.00	1.00	1.00	1.00
Initial Bse:	6	16	41	51	52	39	28	849	25	46	578	41
Added Vol:	0	0	0	0	0	0	0	0	0	0	0	0
PasserByVol:	0	0	0	0	0	0	0	0	0	0	0	0
Initial Fut:	6	16	41	51	52	39	28	849	25	46	578	41
User Adj:	1.00	1.00	1.00	1.00	1.00	1.00	1.00	1.00	1.00	1.00	1.00	1.00
PHF Adj:	1.00	1.00	1.00	1.00	1.00	1.00	1.00	1.00	1.00	1.00	1.00	1.00
PHF Volume:	6	16	41	51	52	39	28	849	25	46	578	41
Reduct Vol:	0	0	0	0	0	0	0	0	0	0	0	0
Reduced Vol:	6	16	41	51	52	39	28	849	25	46	578	41
PCE Adj:	1.00	1.00	1.00	1.00	1.00	1.00	1.00	1.00	1.00	1.00	1.00	1.00
MLF Adj:	1.00	1.00	1.00	1.00	1.00	1.00	1.00	1.00	1.00	1.00	1.00	1.00
FinalVolume:	6	16	41	51	52	39	28	849	25	46	578	41
Saturation Flow Module:												
Sat/Lane:	1900	1900	1900	1900	1900	1900	1900	1900	1900	1900	1900	1900
Adjustment:	0.92	0.92	0.92	0.92	0.92	0.92	0.92	1.00	0.92	0.92	1.00	0.92
Lanes:	0.10	0.25	0.65	0.36	0.37	0.27	1.00	2.00	1.00	1.00	2.00	1.00
Final Sat.:	167	444	1139	629	641	481	1750	3800	1750	1750	3800	1750
Capacity Analysis Module:												
Vol/Sat:	0.04	0.04	0.04	0.08	0.08	0.08	0.02	0.22	0.01	0.03	0.15	0.02
Crit Moves:				****			****			****		
Green Time:	17.1	17.1	17.1	17.1	17.1	17.1	19.7	46.9	46.9	7.0	34.2	34.2
Volume/Cap:	0.17	0.17	0.17	0.38	0.38	0.38	0.06	0.38	0.02	0.30	0.36	0.05
Delay/Veh:	25.9	25.9	25.9	27.6	27.6	27.6	23.2	8.9	6.9	35.3	15.6	13.4
User DelAdj:	1.00	1.00	1.00	1.00	1.00	1.00	1.00	1.00	1.00	1.00	1.00	1.00
AdjDel/Veh:	25.9	25.9	25.9	27.6	27.6	27.6	23.2	8.9	6.9	35.3	15.6	13.4
LOS by Move:	C	C	C	C	C	C	C	A	A	D	B	B
HCM2k95thQ:	3	3	3	7	7	7	1	11	1	2	9	1

Note: Queue reported is the number of cars per lane.

BART Phase II Extension Project

Level Of Service Computation Report
 2000 HCM Operations (Future Volume Alternative)
 AM - 2025 Project Conditions

Intersection #3016: 101/ALUM ROCK

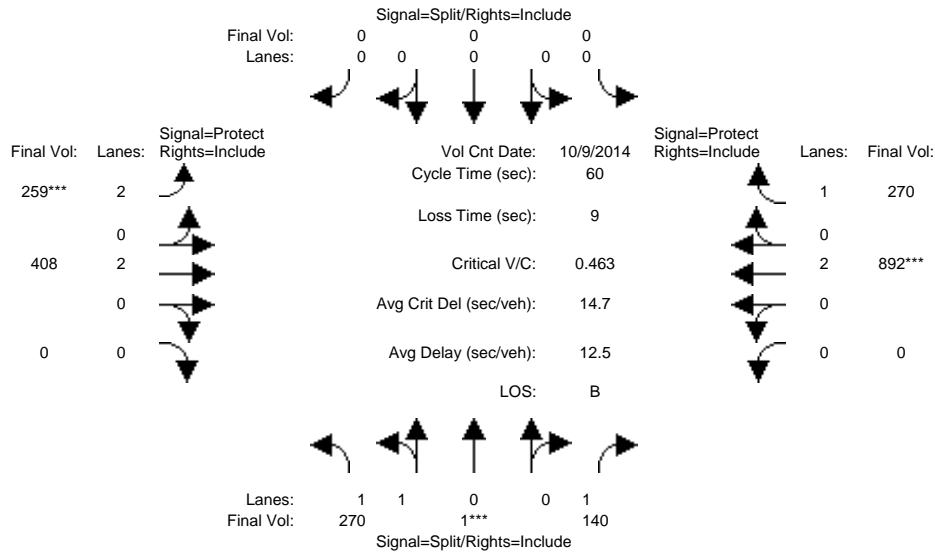

Approach:	North Bound			South Bound			East Bound			West Bound		
	L	T	R	L	T	R	L	T	R	L	T	R
Min. Green:	10	10	10	0	0	0	7	10	0	0	10	10
Y+R:	4.0	4.0	4.0	4.0	4.0	4.0	4.0	4.0	4.0	4.0	4.0	4.0

Volume Module:	>>	Count	Date:	9 Oct 2014	<<												
Base Vol:	270	1	140	0	0	0	259	408	0	0	892	270					
Growth Adj:	1.00	1.00	1.00	1.00	1.00	1.00	1.00	1.00	1.00	1.00	1.00	1.00					
Initial Bse:	270	1	140	0	0	0	259	408	0	0	892	270					
Added Vol:	0	0	0	0	0	0	0	0	0	0	0	0					
PasserByVol:	0	0	0	0	0	0	0	0	0	0	0	0					
Initial Fut:	270	1	140	0	0	0	259	408	0	0	892	270					
User Adj:	1.00	1.00	1.00	1.00	1.00	1.00	1.00	1.00	1.00	1.00	1.00	1.00					
PHF Adj:	1.00	1.00	1.00	1.00	1.00	1.00	1.00	1.00	1.00	1.00	1.00	1.00					
PHF Volume:	270	1	140	0	0	0	259	408	0	0	892	270					
Reduct Vol:	0	0	0	0	0	0	0	0	0	0	0	0					
Reduced Vol:	270	1	140	0	0	0	259	408	0	0	892	270					
PCE Adj:	1.00	1.00	1.00	1.00	1.00	1.00	1.00	1.00	1.00	1.00	1.00	1.00					
MLF Adj:	1.00	1.00	1.00	1.00	1.00	1.00	1.00	1.00	1.00	1.00	1.00	1.00					
Final Volume:	270	1	140	0	0	0	259	408	0	0	892	270					

Saturation Flow Module:												
Sat/Lane:	1900	1900	1900	1900	1900	1900	1900	1900	1900	1900	1900	1900
Adjustment:	0.93	0.95	0.92	0.92	1.00	0.92	0.83	1.00	0.92	0.92	1.00	0.92
Lanes:	1.99	0.01	1.00	0.00	0.00	0.00	2.00	2.00	0.00	0.00	2.00	1.00
Final Sat.:	3537	13	1750	0	0	0	3150	3800	0	0	3800	1750

Capacity Analysis Module:												
Vol/Sat:	0.08	0.08	0.08	0.00	0.00	0.00	0.08	0.11	0.00	0.00	0.23	0.15
Crit Moves:	****						****			****		
Green Time:	10.4	10.4	10.4	0.0	0.0	0.0	10.5	40.6	0.0	0.0	30.1	30.1
Volume/Cap:	0.44	0.44	0.46	0.00	0.00	0.00	0.47	0.16	0.00	0.00	0.47	0.31
Delay/Veh:	22.7	22.7	23.4	0.0	0.0	0.0	22.8	3.5	0.0	0.0	9.9	9.0
User DelAdj:	1.00	1.00	1.00	1.00	1.00	1.00	1.00	1.00	1.00	1.00	1.00	1.00
AdjDel/Veh:	22.7	22.7	23.4	0.0	0.0	0.0	22.8	3.5	0.0	0.0	9.9	9.0
LOS by Move:	C	C	C	A	A	A	C	A	A	A	A	A
HCM2k95thQ:	6	6	6	0	0	0	5	3	0	0	10	6

Note: Queue reported is the number of cars per lane.

BART Phase II Extension Project

Level Of Service Computation Report
2000 HCM Operations (Future Volume Alternative)
PM - 2025 Project Conditions

Intersection #3016: 101/ALUM ROCK

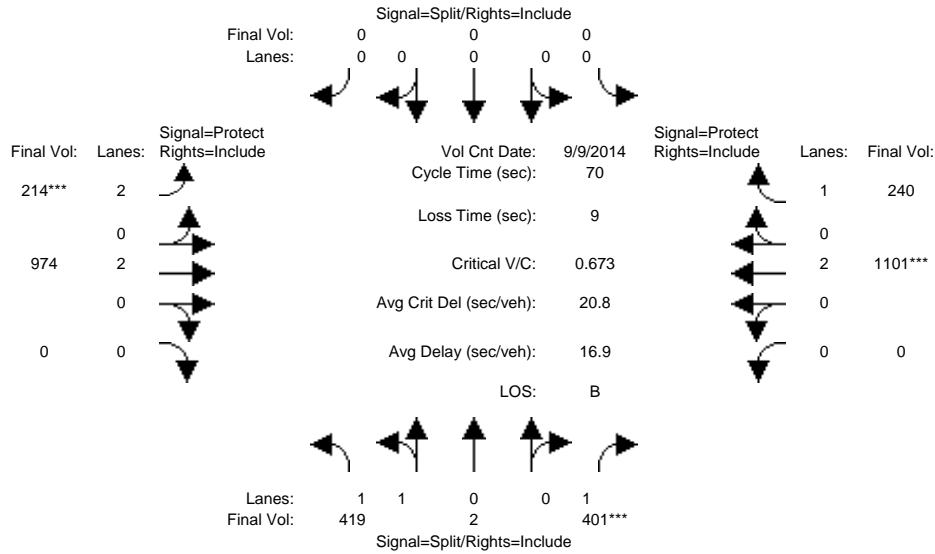

Approach:	North Bound			South Bound			East Bound			West Bound		
	L	T	R	L	T	R	L	T	R	L	T	R
Min. Green:	10	10	10	0	0	0	7	10	0	0	10	10
Y+R:	4.0	4.0	4.0	4.0	4.0	4.0	4.0	4.0	4.0	4.0	4.0	4.0

Volume Module:	>> Count Date: 9 Sep 2014 <<											
Base Vol:	419	2	401	0	0	0	214	974	0	0	1101	240
Growth Adj:	1.00	1.00	1.00	1.00	1.00	1.00	1.00	1.00	1.00	1.00	1.00	1.00
Initial Bse:	419	2	401	0	0	0	214	974	0	0	1101	240
Added Vol:	0	0	0	0	0	0	0	0	0	0	0	0
PasserByVol:	0	0	0	0	0	0	0	0	0	0	0	0
Initial Fut:	419	2	401	0	0	0	214	974	0	0	1101	240
User Adj:	1.00	1.00	1.00	1.00	1.00	1.00	1.00	1.00	1.00	1.00	1.00	1.00
PHF Adj:	1.00	1.00	1.00	1.00	1.00	1.00	1.00	1.00	1.00	1.00	1.00	1.00
PHF Volume:	419	2	401	0	0	0	214	974	0	0	1101	240
Reduct Vol:	0	0	0	0	0	0	0	0	0	0	0	0
Reduced Vol:	419	2	401	0	0	0	214	974	0	0	1101	240
PCE Adj:	1.00	1.00	1.00	1.00	1.00	1.00	1.00	1.00	1.00	1.00	1.00	1.00
MLF Adj:	1.00	1.00	1.00	1.00	1.00	1.00	1.00	1.00	1.00	1.00	1.00	1.00
FinalVolume:	419	2	401	0	0	0	214	974	0	0	1101	240

Saturation Flow Module:												
Sat/Lane:	1900	1900	1900	1900	1900	1900	1900	1900	1900	1900	1900	1900
Adjustment:	0.93	0.95	0.92	0.92	1.00	0.92	0.83	1.00	0.92	0.92	1.00	0.92
Lanes:	1.99	0.01	1.00	0.00	0.00	0.00	2.00	2.00	0.00	0.00	2.00	1.00
Final Sat.:	3533	17	1750	0	0	0	3150	3800	0	0	3800	1750

Capacity Analysis Module:												
Vol/Sat:	0.12	0.12	0.23	0.00	0.00	0.00	0.07	0.26	0.00	0.00	0.29	0.14
Crit Moves:			****				****				****	
Green Time:	23.8	23.8	23.8	0.0	0.0	0.0	7.1	37.2	0.0	0.0	30.1	30.1
Volume/Cap:	0.35	0.35	0.67	0.00	0.00	0.00	0.67	0.48	0.00	0.00	0.67	0.32
Delay/Veh:	17.5	17.5	22.8	0.0	0.0	0.0	36.0	10.5	0.0	0.0	17.1	13.4
User DelAdj:	1.00	1.00	1.00	1.00	1.00	1.00	1.00	1.00	1.00	1.00	1.00	1.00
AdjDel/Veh:	17.5	17.5	22.8	0.0	0.0	0.0	36.0	10.5	0.0	0.0	17.1	13.4
LOS by Move:	B	B	C	A	A	A	D	B	A	A	B	B
HCM2k95thQ:	8	8	17	0	0	0	6	12	0	0	18	7

Note: Queue reported is the number of cars per lane.

BART Phase II Extension Project

Level Of Service Computation Report
2000 HCM Operations (Future Volume Alternative)
AM - 2025 Project Conditions

Intersection #3023: 101/SANTA CLARA

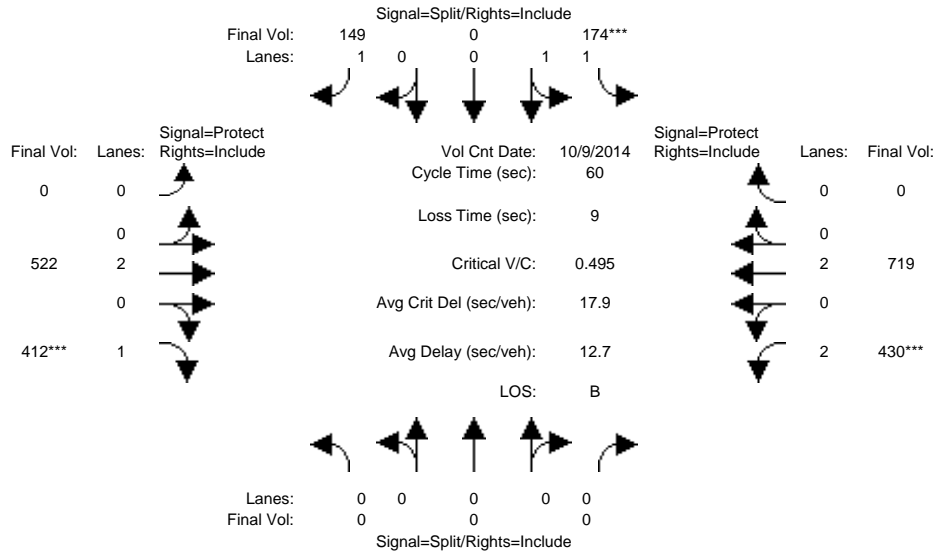

Approach:	North Bound			South Bound			East Bound			West Bound			
	L	T	R	L	T	R	L	T	R	L	T	R	
Min. Green:	0	0	0	10	10	10	0	10	10	7	10	0	
Y+R:	4.0	4.0	4.0	4.0	4.0	4.0	4.0	4.0	4.0	4.0	4.0	4.0	
Volume Module: >> Count Date: 9 Oct 2014 <<													
Base Vol:	0	0	0	174	0	149	0	522	412	430	719	0	
Growth Adj:	1.00	1.00	1.00	1.00	1.00	1.00	1.00	1.00	1.00	1.00	1.00	1.00	
Initial Bse:	0	0	0	174	0	149	0	522	412	430	719	0	
Added Vol:	0	0	0	0	0	0	0	0	0	0	0	0	
PasserByVol:	0	0	0	0	0	0	0	0	0	0	0	0	
Initial Fut:	0	0	0	174	0	149	0	522	412	430	719	0	
User Adj:	1.00	1.00	1.00	1.00	1.00	1.00	1.00	1.00	1.00	1.00	1.00	1.00	
PHF Adj:	1.00	1.00	1.00	1.00	1.00	1.00	1.00	1.00	1.00	1.00	1.00	1.00	
PHF Volume:	0	0	0	174	0	149	0	522	412	430	719	0	
Reduct Vol:	0	0	0	0	0	0	0	0	0	0	0	0	
Reduced Vol:	0	0	0	174	0	149	0	522	412	430	719	0	
PCE Adj:	1.00	1.00	1.00	1.00	1.00	1.00	1.00	1.00	1.00	1.00	1.00	1.00	
MLF Adj:	1.00	1.00	1.00	1.00	1.00	1.00	1.00	1.00	1.00	1.00	1.00	1.00	
FinalVolume:	0	0	0	174	0	149	0	522	412	430	719	0	
Saturation Flow Module:													
Sat/Lane:	1900	1900	1900	1900	1900	1900	1900	1900	1900	1900	1900	1900	
Adjustment:	0.92	1.00	0.92	0.93	1.00	0.92	0.92	1.00	0.92	0.83	1.00	0.92	
Lanes:	0.00	0.00	0.00	2.00	0.00	1.00	0.00	2.00	1.00	2.00	2.00	0.00	
Final Sat.:	0	0	0	3550	0	1750	0	3800	1750	3150	3800	0	
Capacity Analysis Module:													
Vol/Sat:	0.00	0.00	0.00	0.05	0.00	0.09	0.00	0.14	0.24	0.14	0.19	0.00	
Crit Moves:				****							****		
Green Time:	0.0	0.0	0.0	10.3	0.0	10.3	0.0	25.8	25.8	14.9	40.7	0.0	
Volume/Cap:	0.00	0.00	0.00	0.29	0.00	0.50	0.00	0.32	0.55	0.55	0.28	0.00	
Delay/Veh:	0.0	0.0	0.0	21.9	0.0	23.8	0.0	11.4	13.6	20.4	3.9	0.0	
User DelAdj:	1.00	1.00	1.00	1.00	1.00	1.00	1.00	1.00	1.00	1.00	1.00	1.00	
AdjDel/Veh:	0.0	0.0	0.0	21.9	0.0	23.8	0.0	11.4	13.6	20.4	3.9	0.0	
LOS by Move:	A	A	A	C	A	C	A	B	B	C	A	A	
HCM2k95thQ:	0	0	0	4	0	7	0	6	12	8	5	0	

Note: Queue reported is the number of cars per lane.

BART Phase II Extension Project

Level Of Service Computation Report
 2000 HCM Operations (Future Volume Alternative)
 PM - 2025 Project Conditions

Intersection #3023: 101/SANTA CLARA

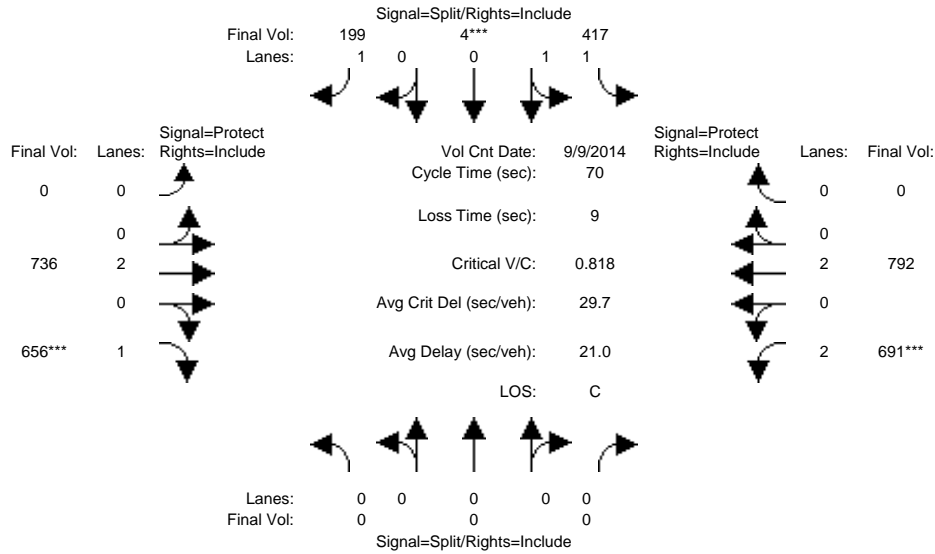

Approach:	North Bound			South Bound			East Bound			West Bound		
	L	T	R	L	T	R	L	T	R	L	T	R
Min. Green:	0	0	0	10	10	10	0	10	10	7	10	0
Y+R:	4.0	4.0	4.0	4.0	4.0	4.0	4.0	4.0	4.0	4.0	4.0	4.0
Volume Module: >> Count Date: 9 Sep 2014 <<												
Base Vol:	0	0	0	417	4	199	0	736	656	691	792	0
Growth Adj:	1.00	1.00	1.00	1.00	1.00	1.00	1.00	1.00	1.00	1.00	1.00	1.00
Initial Bse:	0	0	0	417	4	199	0	736	656	691	792	0
Added Vol:	0	0	0	0	0	0	0	0	0	0	0	0
PasserByVol:	0	0	0	0	0	0	0	0	0	0	0	0
Initial Fut:	0	0	0	417	4	199	0	736	656	691	792	0
User Adj:	1.00	1.00	1.00	1.00	1.00	1.00	1.00	1.00	1.00	1.00	1.00	1.00
PHF Adj:	1.00	1.00	1.00	1.00	1.00	1.00	1.00	1.00	1.00	1.00	1.00	1.00
PHF Volume:	0	0	0	417	4	199	0	736	656	691	792	0
Reduct Vol:	0	0	0	0	0	0	0	0	0	0	0	0
Reduced Vol:	0	0	0	417	4	199	0	736	656	691	792	0
PCE Adj:	1.00	1.00	1.00	1.00	1.00	1.00	1.00	1.00	1.00	1.00	1.00	1.00
MLF Adj:	1.00	1.00	1.00	1.00	1.00	1.00	1.00	1.00	1.00	1.00	1.00	1.00
FinalVolume:	0	0	0	417	4	199	0	736	656	691	792	0
Saturation Flow Module:												
Sat/Lane:	1900	1900	1900	1900	1900	1900	1900	1900	1900	1900	1900	1900
Adjustment:	0.92	1.00	0.92	0.93	0.95	0.92	0.92	1.00	0.92	0.83	1.00	0.92
Lanes:	0.00	0.00	0.00	1.98	0.02	1.00	0.00	2.00	1.00	2.00	2.00	0.00
Final Sat.:	0	0	0	3516	34	1750	0	3800	1750	3150	3800	0
Capacity Analysis Module:												
Vol/Sat:	0.00	0.00	0.00	0.12	0.12	0.11	0.00	0.19	0.37	0.22	0.21	0.00
Crit Moves:				****			****			****		
Green Time:	0.0	0.0	0.0	10.1	10.1	10.1	0.0	32.1	32.1	18.8	50.9	0.0
Volume/Cap:	0.00	0.00	0.00	0.82	0.82	0.78	0.00	0.42	0.82	0.82	0.29	0.00
Delay/Veh:	0.0	0.0	0.0	39.0	39.0	43.6	0.0	12.9	23.0	30.3	3.4	0.0
User DelAdj:	1.00	1.00	1.00	1.00	1.00	1.00	1.00	1.00	1.00	1.00	1.00	1.00
AdjDel/Veh:	0.0	0.0	0.0	39.0	39.0	43.6	0.0	12.9	23.0	30.3	3.4	0.0
LOS by Move:	A	A	A	D	D	D	A	B	C	C	A	A
HCM2k95thQ:	0	0	0	14	14	13	0	10	24	16	6	0

Note: Queue reported is the number of cars per lane.

BART Phase II Extension Project

Level Of Service Computation Report
 2000 HCM Operations (Future Volume Alternative)
 AM - 2025 Project Conditions

Intersection #3036: 280/MCLAUGHLIN

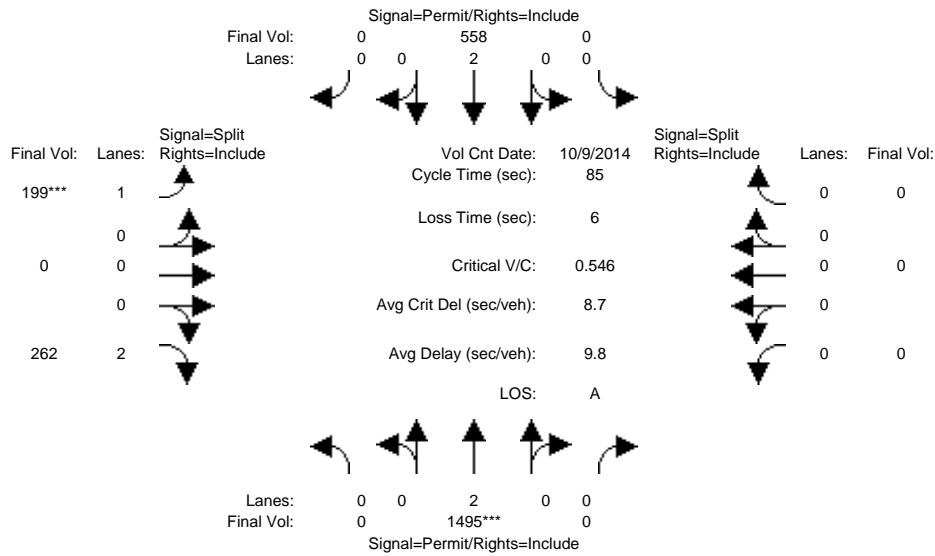

Approach:	North Bound			South Bound			East Bound			West Bound		
Movement:	L	T	R	L	T	R	L	T	R	L	T	R
Min. Green:	0	10	0	0	10	0	10	0	10	0	0	0
Y+R:	4.0	4.0	4.0	4.0	4.0	4.0	4.0	4.0	4.0	4.0	4.0	4.0
Volume Module: >> Count Date: 9 Oct 2014 <<												
Base Vol:	0	1495	0	0	558	0	199	0	262	0	0	0
Growth Adj:	1.00	1.00	1.00	1.00	1.00	1.00	1.00	1.00	1.00	1.00	1.00	1.00
Initial Bse:	0	1495	0	0	558	0	199	0	262	0	0	0
Added Vol:	0	0	0	0	0	0	0	0	0	0	0	0
PasserByVol:	0	0	0	0	0	0	0	0	0	0	0	0
Initial Fut:	0	1495	0	0	558	0	199	0	262	0	0	0
User Adj:	1.00	1.00	1.00	1.00	1.00	1.00	1.00	1.00	1.00	1.00	1.00	1.00
PHF Adj:	1.00	1.00	1.00	1.00	1.00	1.00	1.00	1.00	1.00	1.00	1.00	1.00
PHF Volume:	0	1495	0	0	558	0	199	0	262	0	0	0
Reduct Vol:	0	0	0	0	0	0	0	0	0	0	0	0
Reduced Vol:	0	1495	0	0	558	0	199	0	262	0	0	0
PCE Adj:	1.00	1.00	1.00	1.00	1.00	1.00	1.00	1.00	1.00	1.00	1.00	1.00
MLF Adj:	1.00	1.00	1.00	1.00	1.00	1.00	1.00	1.00	1.00	1.00	1.00	1.00
FinalVolume:	0	1495	0	0	558	0	199	0	262	0	0	0
Saturation Flow Module:												
Sat/Lane:	1900	1900	1900	1900	1900	1900	1900	1900	1900	1900	1900	1900
Adjustment:	0.92	1.00	0.92	0.92	1.00	0.92	0.92	1.00	0.83	0.92	1.00	0.92
Lanes:	0.00	2.00	0.00	0.00	2.00	0.00	1.00	0.00	2.00	0.00	0.00	0.00
Final Sat.:	0	3800	0	0	3800	0	1750	0	3150	0	0	0
Capacity Analysis Module:												
Vol/Sat:	0.00	0.39	0.00	0.00	0.15	0.00	0.11	0.00	0.08	0.00	0.00	0.00
Crit Moves:	****			****			****			****		
Green Time:	0.0	61.3	0.0	0.0	61.3	0.0	17.7	0.0	17.7	0.0	0.0	0.0
Volume/Cap:	0.00	0.55	0.00	0.00	0.20	0.00	0.55	0.00	0.40	0.00	0.00	0.00
Delay/Veh:	0.0	5.7	0.0	0.0	3.9	0.0	31.8	0.0	29.4	0.0	0.0	0.0
User DelAdj:	1.00	1.00	1.00	1.00	1.00	1.00	1.00	1.00	1.00	1.00	1.00	1.00
AdjDel/Veh:	0.0	5.7	0.0	0.0	3.9	0.0	31.8	0.0	29.4	0.0	0.0	0.0
LOS by Move:	A	A	A	A	A	A	C	A	C	A	A	A
HCM2k95thQ:	0	17	0	0	5	0	11	0	8	0	0	0

Note: Queue reported is the number of cars per lane.

BART Phase II Extension Project

Level Of Service Computation Report
2000 HCM Operations (Future Volume Alternative)
PM - 2025 Project Conditions

Intersection #3036: 280/MCLAUGHLIN

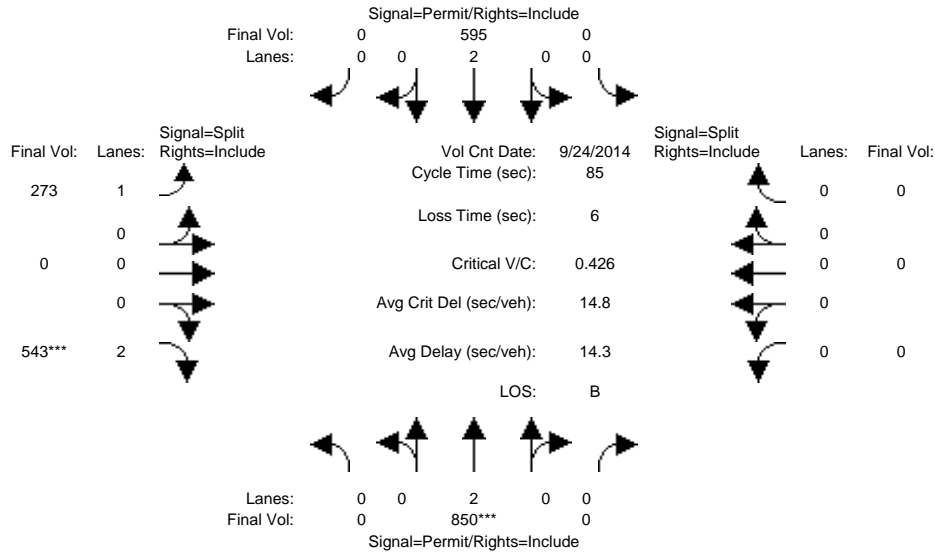

Approach:	North Bound			South Bound			East Bound			West Bound		
Movement:	L	T	R	L	T	R	L	T	R	L	T	R
Min. Green:	0	10	0	0	10	0	10	0	10	0	0	0
Y+R:	4.0	4.0	4.0	4.0	4.0	4.0	4.0	4.0	4.0	4.0	4.0	4.0
Volume Module: >> Count Date: 24 Sep 2014 <<												
Base Vol:	0	850	0	0	595	0	273	0	543	0	0	0
Growth Adj:	1.00	1.00	1.00	1.00	1.00	1.00	1.00	1.00	1.00	1.00	1.00	1.00
Initial Bse:	0	850	0	0	595	0	273	0	543	0	0	0
Added Vol:	0	0	0	0	0	0	0	0	0	0	0	0
PasserByVol:	0	0	0	0	0	0	0	0	0	0	0	0
Initial Fut:	0	850	0	0	595	0	273	0	543	0	0	0
User Adj:	1.00	1.00	1.00	1.00	1.00	1.00	1.00	1.00	1.00	1.00	1.00	1.00
PHF Adj:	1.00	1.00	1.00	1.00	1.00	1.00	1.00	1.00	1.00	1.00	1.00	1.00
PHF Volume:	0	850	0	0	595	0	273	0	543	0	0	0
Reduct Vol:	0	0	0	0	0	0	0	0	0	0	0	0
Reduced Vol:	0	850	0	0	595	0	273	0	543	0	0	0
PCE Adj:	1.00	1.00	1.00	1.00	1.00	1.00	1.00	1.00	1.00	1.00	1.00	1.00
MLF Adj:	1.00	1.00	1.00	1.00	1.00	1.00	1.00	1.00	1.00	1.00	1.00	1.00
FinalVolume:	0	850	0	0	595	0	273	0	543	0	0	0
Saturation Flow Module:												
Sat/Lane:	1900	1900	1900	1900	1900	1900	1900	1900	1900	1900	1900	1900
Adjustment:	0.92	1.00	0.92	0.92	1.00	0.92	0.92	1.00	0.83	0.92	1.00	0.92
Lanes:	0.00	2.00	0.00	0.00	2.00	0.00	1.00	0.00	2.00	0.00	0.00	0.00
Final Sat.:	0	3800	0	0	3800	0	1750	0	3150	0	0	0
Capacity Analysis Module:												
Vol/Sat:	0.00	0.22	0.00	0.00	0.16	0.00	0.16	0.00	0.17	0.00	0.00	0.00
Crit Moves:	****						****					
Green Time:	0.0	44.6	0.0	0.0	44.6	0.0	34.4	0.0	34.4	0.0	0.0	0.0
Volume/Cap:	0.00	0.43	0.00	0.00	0.30	0.00	0.39	0.00	0.43	0.00	0.00	0.00
Delay/Veh:	0.0	12.5	0.0	0.0	11.5	0.0	18.2	0.0	18.4	0.0	0.0	0.0
User DelAdj:	1.00	1.00	1.00	1.00	1.00	1.00	1.00	1.00	1.00	1.00	1.00	1.00
AdjDel/Veh:	0.0	12.5	0.0	0.0	11.5	0.0	18.2	0.0	18.4	0.0	0.0	0.0
LOS by Move:	A	B	A	A	B	A	B	A	B	A	A	A
HCM2k95thQ:	0	13	0	0	9	0	11	0	12	0	0	0

Note: Queue reported is the number of cars per lane.

BART Phase II Extension Project

Level Of Service Computation Report
2000 HCM Operations (Future Volume Alternative)
AM - 2025 Project Conditions

Intersection #3210: 101/JULIAN

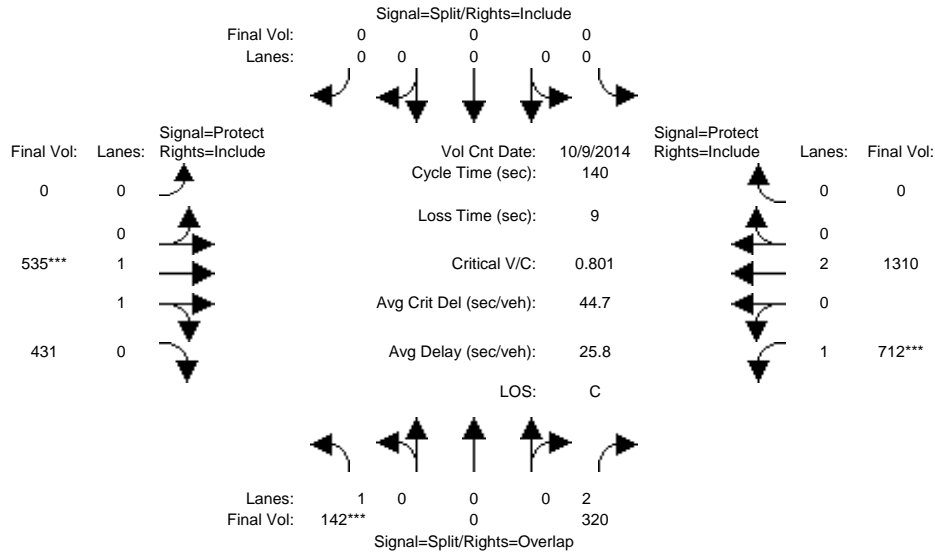

Approach:	North Bound			South Bound			East Bound			West Bound		
	L	T	R	L	T	R	L	T	R	L	T	R
Min. Green:	10	0	10	0	0	0	0	10	10	7	10	0
Y+R:	4.0	4.0	4.0	4.0	4.0	4.0	4.0	4.0	4.0	4.0	4.0	4.0

Volume Module:	>> Count Date: 9 Oct 2014 <<											
Base Vol:	142	0	320	0	0	0	0	535	431	712	1310	0
Growth Adj:	1.00	1.00	1.00	1.00	1.00	1.00	1.00	1.00	1.00	1.00	1.00	1.00
Initial Bse:	142	0	320	0	0	0	0	535	431	712	1310	0
Added Vol:	0	0	0	0	0	0	0	0	0	0	0	0
PasserByVol:	0	0	0	0	0	0	0	0	0	0	0	0
Initial Fut:	142	0	320	0	0	0	0	535	431	712	1310	0
User Adj:	1.00	1.00	1.00	1.00	1.00	1.00	1.00	1.00	1.00	1.00	1.00	1.00
PHF Adj:	1.00	1.00	1.00	1.00	1.00	1.00	1.00	1.00	1.00	1.00	1.00	1.00
PHF Volume:	142	0	320	0	0	0	0	535	431	712	1310	0
Reduct Vol:	0	0	0	0	0	0	0	0	0	0	0	0
Reduced Vol:	142	0	320	0	0	0	0	535	431	712	1310	0
PCE Adj:	1.00	1.00	1.00	1.00	1.00	1.00	1.00	1.00	1.00	1.00	1.00	1.00
MLF Adj:	1.00	1.00	1.00	1.00	1.00	1.00	1.00	1.00	1.00	1.00	1.00	1.00
FinalVolume:	142	0	320	0	0	0	0	535	431	712	1310	0

Saturation Flow Module:												
Sat/Lane:	1900	1900	1900	1900	1900	1900	1900	1900	1900	1900	1900	1900
Adjustment:	0.92	1.00	0.83	0.92	1.00	0.92	0.92	0.99	0.95	0.92	1.00	0.92
Lanes:	1.00	0.00	2.00	0.00	0.00	0.00	0.00	1.08	0.92	1.00	2.00	0.00
Final Sat.:	1750	0	3150	0	0	0	0	2048	1650	1750	3800	0

Capacity Analysis Module:												
Vol/Sat:	0.08	0.00	0.10	0.00	0.00	0.00	0.00	0.26	0.26	0.41	0.34	0.00
Crit Moves:	****							****		****		
Green Time:	14.2	0.0	85.3	0.0	0.0	0.0	0.0	45.7	45.7	71.1	117	0.0
Volume/Cap:	0.80	0.00	0.17	0.00	0.00	0.00	0.00	0.80	0.80	0.80	0.41	0.00
Delay/Veh:	83.8	0.0	11.9	0.0	0.0	0.0	0.0	46.9	46.9	33.8	3.0	0.0
User DelAdj:	1.00	1.00	1.00	1.00	1.00	1.00	1.00	1.00	1.00	1.00	1.00	1.00
AdjDel/Veh:	83.8	0.0	11.9	0.0	0.0	0.0	0.0	46.9	46.9	33.8	3.0	0.0
LOS by Move:	F	A	B	A	A	A	A	D	D	C	A	A
HCM2k95thQ:	16	0	7	0	0	0	0	34	34	46	14	0

Note: Queue reported is the number of cars per lane.

BART Phase II Extension Project

Level Of Service Computation Report
2000 HCM Operations (Future Volume Alternative)
PM - 2025 Project Conditions

Intersection #3210: 101/JULIAN

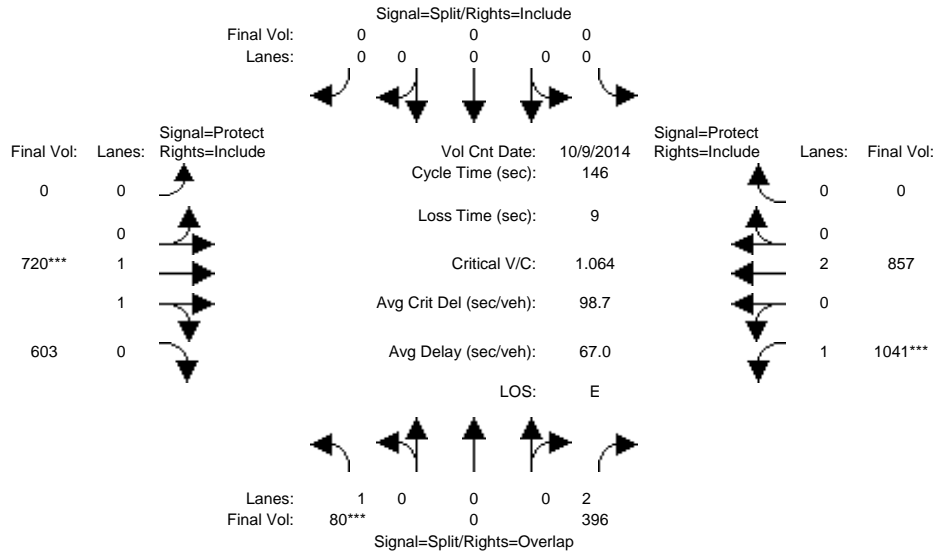

Approach:	North Bound			South Bound			East Bound			West Bound		
	L	T	R	L	T	R	L	T	R	L	T	R
Min. Green:	10	0	10	0	0	0	0	10	10	7	10	0
Y+R:	4.0	4.0	4.0	4.0	4.0	4.0	4.0	4.0	4.0	4.0	4.0	4.0
Volume Module: >> Count Date: 9 Oct 2014 <<												
Base Vol:	80	0	396	0	0	0	0	720	603	1041	857	0
Growth Adj:	1.00	1.00	1.00	1.00	1.00	1.00	1.00	1.00	1.00	1.00	1.00	1.00
Initial Bse:	80	0	396	0	0	0	0	720	603	1041	857	0
Added Vol:	0	0	0	0	0	0	0	0	0	0	0	0
PasserByVol:	0	0	0	0	0	0	0	0	0	0	0	0
Initial Fut:	80	0	396	0	0	0	0	720	603	1041	857	0
User Adj:	1.00	1.00	1.00	1.00	1.00	1.00	1.00	1.00	1.00	1.00	1.00	1.00
PHF Adj:	1.00	1.00	1.00	1.00	1.00	1.00	1.00	1.00	1.00	1.00	1.00	1.00
PHF Volume:	80	0	396	0	0	0	0	720	603	1041	857	0
Reduct Vol:	0	0	0	0	0	0	0	0	0	0	0	0
Reduced Vol:	80	0	396	0	0	0	0	720	603	1041	857	0
PCE Adj:	1.00	1.00	1.00	1.00	1.00	1.00	1.00	1.00	1.00	1.00	1.00	1.00
MLF Adj:	1.00	1.00	1.00	1.00	1.00	1.00	1.00	1.00	1.00	1.00	1.00	1.00
FinalVolume:	80	0	396	0	0	0	0	720	603	1041	857	0
Saturation Flow Module:												
Sat/Lane:	1900	1900	1900	1900	1900	1900	1900	1900	1900	1900	1900	1900
Adjustment:	0.92	1.00	0.83	0.92	1.00	0.92	0.92	1.00	0.95	0.92	1.00	0.92
Lanes:	1.00	0.00	2.00	0.00	0.00	0.00	0.00	1.06	0.94	1.00	2.00	0.00
Final Sat.:	1750	0	3150	0	0	0	0	2012	1685	1750	3800	0
Capacity Analysis Module:												
Vol/Sat:	0.05	0.00	0.13	0.00	0.00	0.00	0.00	0.36	0.36	0.59	0.23	0.00
Crit Moves:	****							****		****		
Green Time:	10.0	0.0	89.3	0.0	0.0	0.0	0.0	47.7	47.7	79.3	127	0.0
Volume/Cap:	0.67	0.00	0.21	0.00	0.00	0.00	0.00	1.10	1.10	1.10	0.26	0.00
Delay/Veh:	79.9	0.0	12.6	0.0	0.0	0.0	0.0	105	105.1	92.1	1.6	0.0
User DelAdj:	1.00	1.00	1.00	1.00	1.00	1.00	1.00	1.00	1.00	1.00	1.00	1.00
AdjDel/Veh:	79.9	0.0	12.6	0.0	0.0	0.0	0.0	105	105.1	92.1	1.6	0.0
LOS by Move:	E	A	B	A	A	A	A	F	F	F	A	A
HCM2k95thQ:	10	0	9	0	0	0	0	62	62	99	7	0

Note: Queue reported is the number of cars per lane.

BART Phase II Extension Project

Level Of Service Computation Report
2000 HCM Operations (Future Volume Alternative)
AM - 2025 Project Conditions

Intersection #3211: 101/McKee(E)

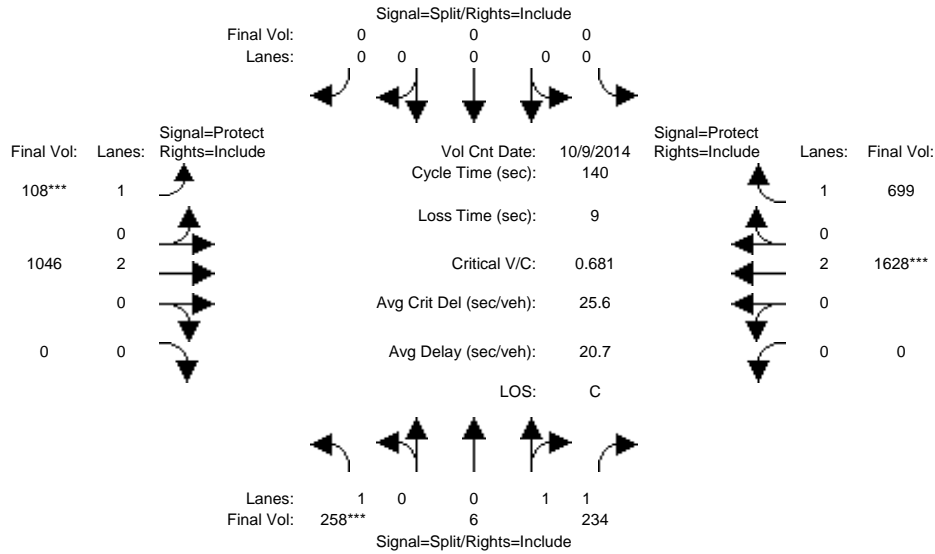

Approach:	North Bound			South Bound			East Bound			West Bound		
	L	T	R	L	T	R	L	T	R	L	T	R
Min. Green:	10	10	10	0	0	0	7	10	0	0	10	10
Y+R:	4.0	4.0	4.0	4.0	4.0	4.0	4.0	4.0	4.0	4.0	4.0	4.0

Volume Module:	>> Count Date: 9 Oct 2014 <<											
Base Vol:	258	6	234	0	0	0	108	1046	0	0	1628	699
Growth Adj:	1.00	1.00	1.00	1.00	1.00	1.00	1.00	1.00	1.00	1.00	1.00	1.00
Initial Bse:	258	6	234	0	0	0	108	1046	0	0	1628	699
Added Vol:	0	0	0	0	0	0	0	0	0	0	0	0
PasserByVol:	0	0	0	0	0	0	0	0	0	0	0	0
Initial Fut:	258	6	234	0	0	0	108	1046	0	0	1628	699
User Adj:	1.00	1.00	1.00	1.00	1.00	1.00	1.00	1.00	1.00	1.00	1.00	1.00
PHF Adj:	1.00	1.00	1.00	1.00	1.00	1.00	1.00	1.00	1.00	1.00	1.00	1.00
PHF Volume:	258	6	234	0	0	0	108	1046	0	0	1628	699
Reduct Vol:	0	0	0	0	0	0	0	0	0	0	0	0
Reduced Vol:	258	6	234	0	0	0	108	1046	0	0	1628	699
PCE Adj:	1.00	1.00	1.00	1.00	1.00	1.00	1.00	1.00	1.00	1.00	1.00	1.00
MLF Adj:	1.00	1.00	1.00	1.00	1.00	1.00	1.00	1.00	1.00	1.00	1.00	1.00
FinalVolume:	258	6	234	0	0	0	108	1046	0	0	1628	699

Saturation Flow Module:												
Sat/Lane:	1900	1900	1900	1900	1900	1900	1900	1900	1900	1900	1900	1900
Adjustment:	0.92	0.95	0.95	0.92	1.00	0.92	0.92	1.00	0.92	0.92	1.00	0.92
Lanes:	1.00	0.05	1.95	0.00	0.00	0.00	1.00	2.00	0.00	0.00	2.00	1.00
Final Sat.:	1750	90	3510	0	0	0	1750	3800	0	0	3800	1750

Capacity Analysis Module:												
Vol/Sat:	0.15	0.07	0.07	0.00	0.00	0.00	0.06	0.28	0.00	0.00	0.43	0.40
Crit Moves:	****						****				****	
Green Time:	30.3	30.3	30.3	0.0	0.0	0.0	12.7	101	0.0	0.0	88.0	88.0
Volume/Cap:	0.68	0.31	0.31	0.00	0.00	0.00	0.68	0.38	0.00	0.00	0.68	0.64
Delay/Veh:	55.4	46.3	46.3	0.0	0.0	0.0	73.2	7.7	0.0	0.0	17.7	17.3
User DelAdj:	1.00	1.00	1.00	1.00	1.00	1.00	1.00	1.00	1.00	1.00	1.00	1.00
AdjDel/Veh:	55.4	46.3	46.3	0.0	0.0	0.0	73.2	7.7	0.0	0.0	17.7	17.3
LOS by Move:	E	D	D	A	A	A	E	A	A	A	B	B
HCM2k95thQ:	22	9	9	0	0	0	12	16	0	0	38	34

Note: Queue reported is the number of cars per lane.

BART Phase II Extension Project

Level Of Service Computation Report
2000 HCM Operations (Future Volume Alternative)
PM - 2025 Project Conditions

Intersection #3211: 101/McKee(E)

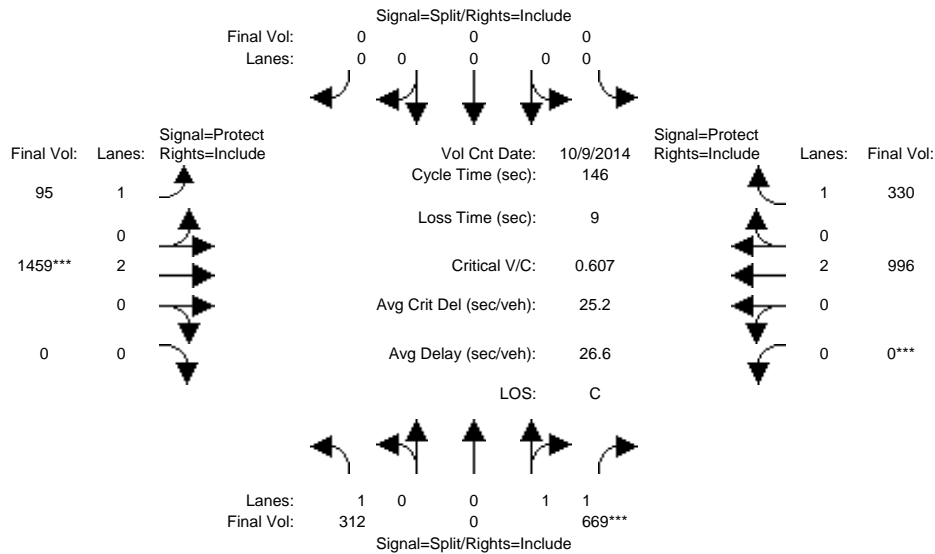

Approach:	North Bound			South Bound			East Bound			West Bound		
Movement:	L	T	R	L	T	R	L	T	R	L	T	R
Min. Green:	10	10	10	0	0	0	7	10	0	0	10	10
Y+R:	4.0	4.0	4.0	4.0	4.0	4.0	4.0	4.0	4.0	4.0	4.0	4.0
Volume Module: >> Count Date: 9 Oct 2014 <<												
Base Vol:	312	0	669	0	0	0	95	1459	0	0	996	330
Growth Adj:	1.00	1.00	1.00	1.00	1.00	1.00	1.00	1.00	1.00	1.00	1.00	1.00
Initial Bse:	312	0	669	0	0	0	95	1459	0	0	996	330
Added Vol:	0	0	0	0	0	0	0	0	0	0	0	0
PasserByVol:	0	0	0	0	0	0	0	0	0	0	0	0
Initial Fut:	312	0	669	0	0	0	95	1459	0	0	996	330
User Adj:	1.00	1.00	1.00	1.00	1.00	1.00	1.00	1.00	1.00	1.00	1.00	1.00
PHF Adj:	1.00	1.00	1.00	1.00	1.00	1.00	1.00	1.00	1.00	1.00	1.00	1.00
PHF Volume:	312	0	669	0	0	0	95	1459	0	0	996	330
Reduct Vol:	0	0	0	0	0	0	0	0	0	0	0	0
Reduced Vol:	312	0	669	0	0	0	95	1459	0	0	996	330
PCE Adj:	1.00	1.00	1.00	1.00	1.00	1.00	1.00	1.00	1.00	1.00	1.00	1.00
MLF Adj:	1.00	1.00	1.00	1.00	1.00	1.00	1.00	1.00	1.00	1.00	1.00	1.00
FinalVolume:	312	0	669	0	0	0	95	1459	0	0	996	330
Saturation Flow Module:												
Sat/Lane:	1900	1900	1900	1900	1900	1900	1900	1900	1900	1900	1900	1900
Adjustment:	0.92	1.00	0.95	0.92	1.00	0.92	0.92	1.00	0.92	0.92	1.00	0.92
Lanes:	1.00	0.00	2.00	0.00	0.00	0.00	1.00	2.00	0.00	0.00	2.00	1.00
Final Sat.:	1750	0	3600	0	0	0	1750	3800	0	0	3800	1750
Capacity Analysis Module:												
Vol/Sat:	0.18	0.00	0.19	0.00	0.00	0.00	0.05	0.38	0.00	0.00	0.26	0.19
Crit Moves:			****					****			****	
Green Time:	44.7	0.0	44.7	0.0	0.0	0.0	15.8	92.3	0.0	0.0	76.5	76.5
Volume/Cap:	0.58	0.00	0.61	0.00	0.00	0.00	0.50	0.61	0.00	0.00	0.50	0.36
Delay/Veh:	44.4	0.0	44.2	0.0	0.0	0.0	63.4	16.5	0.0	0.0	22.6	20.6
User DelAdj:	1.00	1.00	1.00	1.00	1.00	1.00	1.00	1.00	1.00	1.00	1.00	1.00
AdjDel/Veh:	44.4	0.0	44.2	0.0	0.0	0.0	63.4	16.5	0.0	0.0	22.6	20.6
LOS by Move:	D	A	D	A	A	A	E	B	A	A	C	C
HCM2k95thQ:	23	0	24	0	0	0	10	33	0	0	25	17

Note: Queue reported is the number of cars per lane.

BART Phase II Extension Project

Level Of Service Computation Report
2000 HCM Operations (Future Volume Alternative)
AM - 2025 Project Conditions

Intersection #3612: JULIAN/21ST

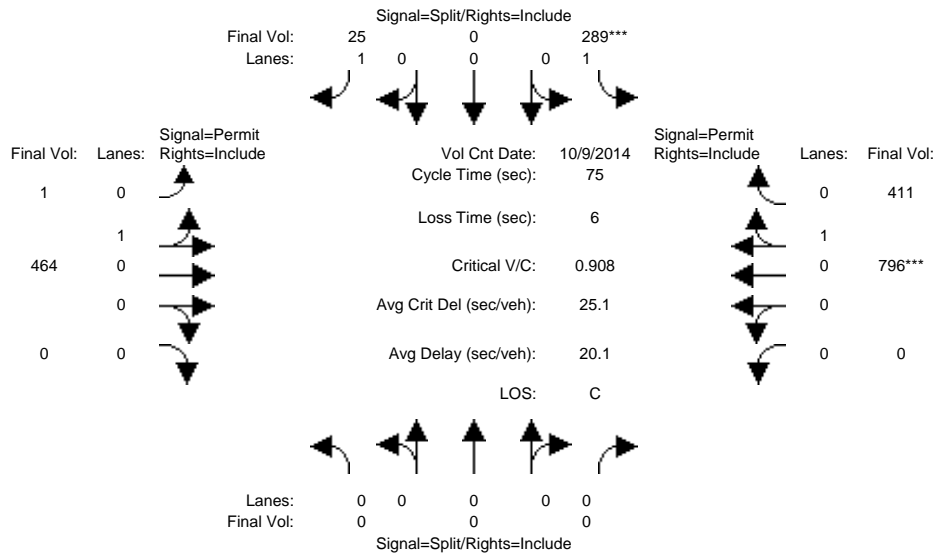

Approach:	North Bound			South Bound			East Bound			West Bound			
	L	T	R	L	T	R	L	T	R	L	T	R	
Min. Green:	0	0	0	10	0	10	10	10	0	0	10	10	
Y+R:	4.0	4.0	4.0	4.0	4.0	4.0	4.0	4.0	4.0	4.0	4.0	4.0	
Volume Module: >> Count Date: 9 Oct 2014 <<													
Base Vol:	0	0	0	289	0	25	1	464	0	0	796	411	
Growth Adj:	1.00	1.00	1.00	1.00	1.00	1.00	1.00	1.00	1.00	1.00	1.00	1.00	
Initial Bse:	0	0	0	289	0	25	1	464	0	0	796	411	
Added Vol:	0	0	0	0	0	0	0	0	0	0	0	0	
PasserByVol:	0	0	0	0	0	0	0	0	0	0	0	0	
Initial Fut:	0	0	0	289	0	25	1	464	0	0	796	411	
User Adj:	1.00	1.00	1.00	1.00	1.00	1.00	1.00	1.00	1.00	1.00	1.00	1.00	
PHF Adj:	1.00	1.00	1.00	1.00	1.00	1.00	1.00	1.00	1.00	1.00	1.00	1.00	
PHF Volume:	0	0	0	289	0	25	1	464	0	0	796	411	
Reduct Vol:	0	0	0	0	0	0	0	0	0	0	0	0	
Reduced Vol:	0	0	0	289	0	25	1	464	0	0	796	411	
PCE Adj:	1.00	1.00	1.00	1.00	1.00	1.00	1.00	1.00	1.00	1.00	1.00	1.00	
MLF Adj:	1.00	1.00	1.00	1.00	1.00	1.00	1.00	1.00	1.00	1.00	1.00	1.00	
FinalVolume:	0	0	0	289	0	25	1	464	0	0	796	411	
Saturation Flow Module:													
Sat/Lane:	1900	1900	1900	1900	1900	1900	1900	1900	1900	1900	1900	1900	
Adjustment:	0.92	1.00	0.92	0.92	1.00	0.92	0.95	0.95	0.92	0.92	0.95	0.95	
Lanes:	0.00	0.00	0.00	1.00	0.00	1.00	0.01	0.99	0.00	0.00	0.66	0.34	
Final Sat.:	0	0	0	1750	0	1750	4	1796	0	0	1187	613	
Capacity Analysis Module:													
Vol/Sat:	0.00	0.00	0.00	0.17	0.00	0.01	0.26	0.26	0.00	0.00	0.67	0.67	
Crit Moves:				****							****		
Green Time:	0.0	0.0	0.0	13.6	0.0	13.6	55.4	55.4	0.0	0.0	55.4	55.4	
Volume/Cap:	0.00	0.00	0.00	0.91	0.00	0.08	0.35	0.35	0.00	0.00	0.91	0.91	
Delay/Veh:	0.0	0.0	0.0	58.4	0.0	25.6	3.6	3.6	0.0	0.0	17.1	17.1	
User DelAdj:	1.00	1.00	1.00	1.00	1.00	1.00	1.00	1.00	1.00	1.00	1.00	1.00	
AdjDel/Veh:	0.0	0.0	0.0	58.4	0.0	25.6	3.6	3.6	0.0	0.0	17.1	17.1	
LOS by Move:	A	A	A	E	A	C	A	A	A	A	B	B	
HCM2k95thQ:	0	0	0	20	0	1	8	8	0	0	43	43	

Note: Queue reported is the number of cars per lane.

BART Phase II Extension Project

Level Of Service Computation Report
2000 HCM Operations (Future Volume Alternative)
PM - 2025 Project Conditions

Intersection #3612: JULIAN/21ST

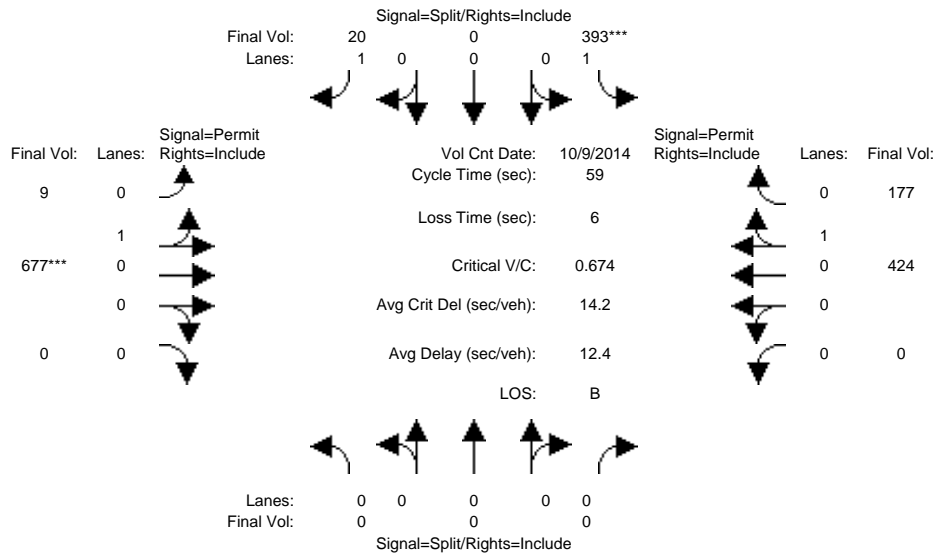

Approach:	North Bound			South Bound			East Bound			West Bound		
	L	T	R	L	T	R	L	T	R	L	T	R
Min. Green:	0	0	0	10	0	10	10	10	0	0	10	10
Y+R:	4.0	4.0	4.0	4.0	4.0	4.0	4.0	4.0	4.0	4.0	4.0	4.0
Volume Module: >> Count Date: 9 Oct 2014 <<												
Base Vol:	0	0	0	393	0	20	9	677	0	0	424	177
Growth Adj:	1.00	1.00	1.00	1.00	1.00	1.00	1.00	1.00	1.00	1.00	1.00	1.00
Initial Bse:	0	0	0	393	0	20	9	677	0	0	424	177
Added Vol:	0	0	0	0	0	0	0	0	0	0	0	0
PasserByVol:	0	0	0	0	0	0	0	0	0	0	0	0
Initial Fut:	0	0	0	393	0	20	9	677	0	0	424	177
User Adj:	1.00	1.00	1.00	1.00	1.00	1.00	1.00	1.00	1.00	1.00	1.00	1.00
PHF Adj:	1.00	1.00	1.00	1.00	1.00	1.00	1.00	1.00	1.00	1.00	1.00	1.00
PHF Volume:	0	0	0	393	0	20	9	677	0	0	424	177
Reduct Vol:	0	0	0	0	0	0	0	0	0	0	0	0
Reduced Vol:	0	0	0	393	0	20	9	677	0	0	424	177
PCE Adj:	1.00	1.00	1.00	1.00	1.00	1.00	1.00	1.00	1.00	1.00	1.00	1.00
MLF Adj:	1.00	1.00	1.00	1.00	1.00	1.00	1.00	1.00	1.00	1.00	1.00	1.00
FinalVolume:	0	0	0	393	0	20	9	677	0	0	424	177
Saturation Flow Module:												
Sat/Lane:	1900	1900	1900	1900	1900	1900	1900	1900	1900	1900	1900	1900
Adjustment:	0.92	1.00	0.92	0.92	1.00	0.92	0.95	0.95	0.92	0.92	0.95	0.95
Lanes:	0.00	0.00	0.00	1.00	0.00	1.00	0.01	0.99	0.00	0.00	0.71	0.29
Final Sat.:	0	0	0	1750	0	1750	24	1776	0	0	1270	530
Capacity Analysis Module:												
Vol/Sat:	0.00	0.00	0.00	0.22	0.00	0.01	0.38	0.38	0.00	0.00	0.33	0.33
Crit Moves:				****				****				
Green Time:	0.0	0.0	0.0	19.7	0.0	19.7	33.3	33.3	0.0	0.0	33.3	33.3
Volume/Cap:	0.00	0.00	0.00	0.67	0.00	0.03	0.67	0.67	0.00	0.00	0.59	0.59
Delay/Veh:	0.0	0.0	0.0	20.0	0.0	13.3	10.8	10.8	0.0	0.0	9.3	9.3
User DelAdj:	1.00	1.00	1.00	1.00	1.00	1.00	1.00	1.00	1.00	1.00	1.00	1.00
AdjDel/Veh:	0.0	0.0	0.0	20.0	0.0	13.3	10.8	10.8	0.0	0.0	9.3	9.3
LOS by Move:	A	A	A	C	A	B	B	B	A	A	A	A
HCM2k95thQ:	0	0	0	15	0	1	18	18	0	0	14	14

Note: Queue reported is the number of cars per lane.

BART Phase II Extension Project

Level Of Service Computation Report
2000 HCM Operations (Future Volume Alternative)
AM - 2025 Project Conditions

Intersection #3613: JULIAN/24TH

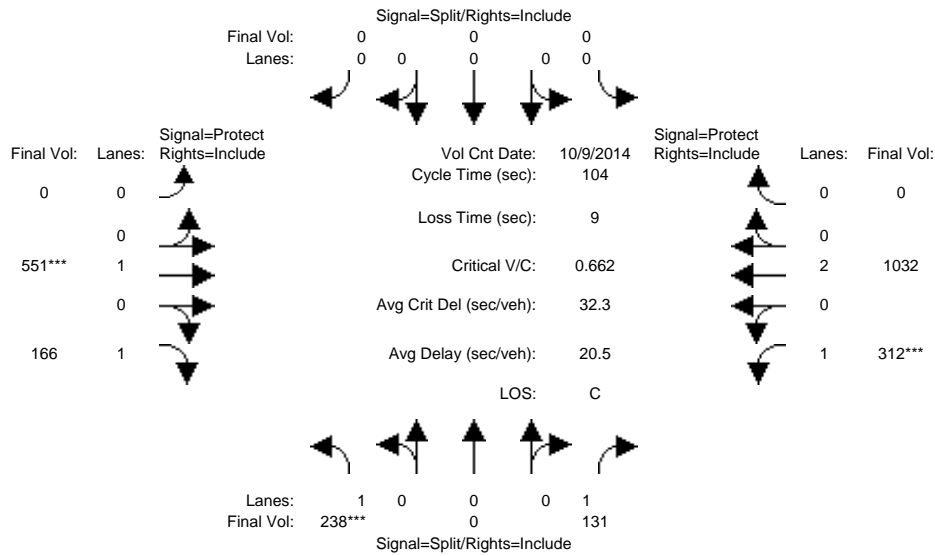

Approach:	North Bound			South Bound			East Bound			West Bound		
	L	T	R	L	T	R	L	T	R	L	T	R
Min. Green:	10	0	10	0	0	0	0	10	10	7	10	0
Y+R:	4.0	4.0	4.0	4.0	4.0	4.0	4.0	4.0	4.0	4.0	4.0	4.0

Volume Module:	>> Count Date: 9 Oct 2014 <<											
Base Vol:	238	0	131	0	0	0	0	551	166	312	1032	0
Growth Adj:	1.00	1.00	1.00	1.00	1.00	1.00	1.00	1.00	1.00	1.00	1.00	1.00
Initial Bse:	238	0	131	0	0	0	0	551	166	312	1032	0
Added Vol:	0	0	0	0	0	0	0	0	0	0	0	0
PasserByVol:	0	0	0	0	0	0	0	0	0	0	0	0
Initial Fut:	238	0	131	0	0	0	0	551	166	312	1032	0
User Adj:	1.00	1.00	1.00	1.00	1.00	1.00	1.00	1.00	1.00	1.00	1.00	1.00
PHF Adj:	1.00	1.00	1.00	1.00	1.00	1.00	1.00	1.00	1.00	1.00	1.00	1.00
PHF Volume:	238	0	131	0	0	0	0	551	166	312	1032	0
Reduct Vol:	0	0	0	0	0	0	0	0	0	0	0	0
Reduced Vol:	238	0	131	0	0	0	0	551	166	312	1032	0
PCE Adj:	1.00	1.00	1.00	1.00	1.00	1.00	1.00	1.00	1.00	1.00	1.00	1.00
MLF Adj:	1.00	1.00	1.00	1.00	1.00	1.00	1.00	1.00	1.00	1.00	1.00	1.00
FinalVolume:	238	0	131	0	0	0	0	551	166	312	1032	0

Saturation Flow Module:												
Sat/Lane:	1900	1900	1900	1900	1900	1900	1900	1900	1900	1900	1900	1900
Adjustment:	0.92	1.00	0.92	0.92	1.00	0.92	0.92	1.00	0.92	0.92	1.00	0.92
Lanes:	1.00	0.00	1.00	0.00	0.00	0.00	0.00	1.00	1.00	1.00	2.00	0.00
Final Sat.:	1750	0	1750	0	0	0	0	1900	1750	1750	3800	0

Capacity Analysis Module:												
Vol/Sat:	0.14	0.00	0.07	0.00	0.00	0.00	0.00	0.29	0.09	0.18	0.27	0.00
Crit Moves:	****							****		****		
Green Time:	21.4	0.0	21.4	0.0	0.0	0.0	0.0	45.6	45.6	28.0	73.6	0.0
Volume/Cap:	0.66	0.00	0.36	0.00	0.00	0.00	0.00	0.66	0.22	0.66	0.38	0.00
Delay/Veh:	42.5	0.0	36.1	0.0	0.0	0.0	0.0	25.1	18.3	37.3	6.2	0.0
User DelAdj:	1.00	1.00	1.00	1.00	1.00	1.00	1.00	1.00	1.00	1.00	1.00	1.00
AdjDel/Veh:	42.5	0.0	36.1	0.0	0.0	0.0	0.0	25.1	18.3	37.3	6.2	0.0
LOS by Move:	D	A	D	A	A	A	A	C	B	D	A	A
HCM2k95thQ:	16	0	8	0	0	0	0	25	7	19	13	0

Note: Queue reported is the number of cars per lane.

BART Phase II Extension Project

Level Of Service Computation Report
2000 HCM Operations (Future Volume Alternative)
PM - 2025 Project Conditions

Intersection #3613: JULIAN/24TH

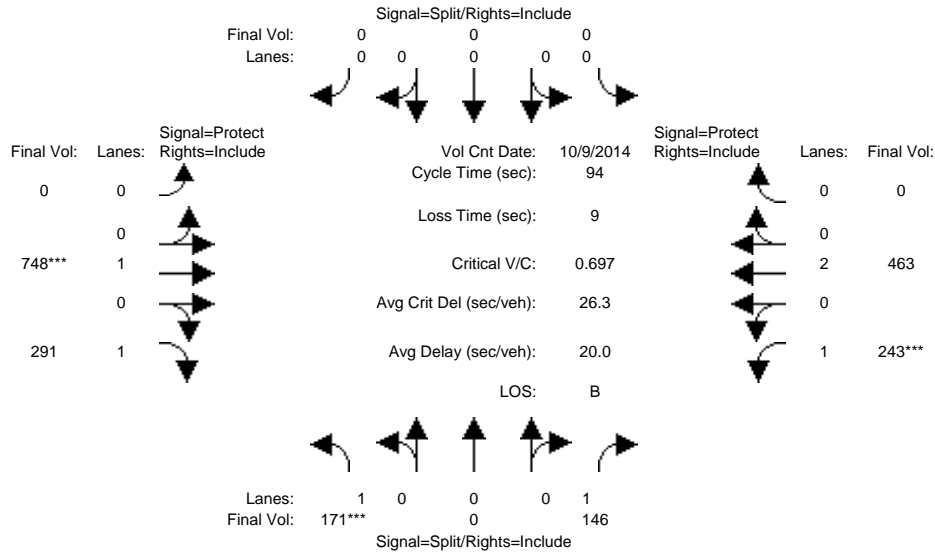

Approach:	North Bound			South Bound			East Bound			West Bound		
	L	T	R	L	T	R	L	T	R	L	T	R
Min. Green:	10	0	10	0	0	0	0	10	10	7	10	0
Y+R:	4.0	4.0	4.0	4.0	4.0	4.0	4.0	4.0	4.0	4.0	4.0	4.0
Volume Module: >> Count Date: 9 Oct 2014 <<												
Base Vol:	171	0	146	0	0	0	0	748	291	243	463	0
Growth Adj:	1.00	1.00	1.00	1.00	1.00	1.00	1.00	1.00	1.00	1.00	1.00	1.00
Initial Bse:	171	0	146	0	0	0	0	748	291	243	463	0
Added Vol:	0	0	0	0	0	0	0	0	0	0	0	0
PasserByVol:	0	0	0	0	0	0	0	0	0	0	0	0
Initial Fut:	171	0	146	0	0	0	0	748	291	243	463	0
User Adj:	1.00	1.00	1.00	1.00	1.00	1.00	1.00	1.00	1.00	1.00	1.00	1.00
PHF Adj:	1.00	1.00	1.00	1.00	1.00	1.00	1.00	1.00	1.00	1.00	1.00	1.00
PHF Volume:	171	0	146	0	0	0	0	748	291	243	463	0
Reduct Vol:	0	0	0	0	0	0	0	0	0	0	0	0
Reduced Vol:	171	0	146	0	0	0	0	748	291	243	463	0
PCE Adj:	1.00	1.00	1.00	1.00	1.00	1.00	1.00	1.00	1.00	1.00	1.00	1.00
MLF Adj:	1.00	1.00	1.00	1.00	1.00	1.00	1.00	1.00	1.00	1.00	1.00	1.00
FinalVolume:	171	0	146	0	0	0	0	748	291	243	463	0
Saturation Flow Module:												
Sat/Lane:	1900	1900	1900	1900	1900	1900	1900	1900	1900	1900	1900	1900
Adjustment:	0.92	1.00	0.92	0.92	1.00	0.92	0.92	1.00	0.92	0.92	1.00	0.92
Lanes:	1.00	0.00	1.00	0.00	0.00	0.00	0.00	1.00	1.00	1.00	2.00	0.00
Final Sat.:	1750	0	1750	0	0	0	0	1900	1750	1750	3800	0
Capacity Analysis Module:												
Vol/Sat:	0.10	0.00	0.08	0.00	0.00	0.00	0.00	0.39	0.17	0.14	0.12	0.00
Crit Moves:	****							****		****		
Green Time:	13.2	0.0	13.2	0.0	0.0	0.0	0.0	53.1	53.1	18.7	71.8	0.0
Volume/Cap:	0.70	0.00	0.60	0.00	0.00	0.00	0.00	0.70	0.29	0.70	0.16	0.00
Delay/Veh:	47.0	0.0	41.8	0.0	0.0	0.0	0.0	16.7	10.8	41.1	3.0	0.0
User DelAdj:	1.00	1.00	1.00	1.00	1.00	1.00	1.00	1.00	1.00	1.00	1.00	1.00
AdjDel/Veh:	47.0	0.0	41.8	0.0	0.0	0.0	0.0	16.7	10.8	41.1	3.0	0.0
LOS by Move:	D	A	D	A	A	A	A	B	B	D	A	A
HCM2k95thQ:	13	0	10	0	0	0	0	27	9	16	4	0

Note: Queue reported is the number of cars per lane.

BART Phase II Extension Project

Level Of Service Computation Report
2000 HCM Operations (Future Volume Alternative)
AM - 2025 Project Conditions

Intersection #3625: KING/McKEE

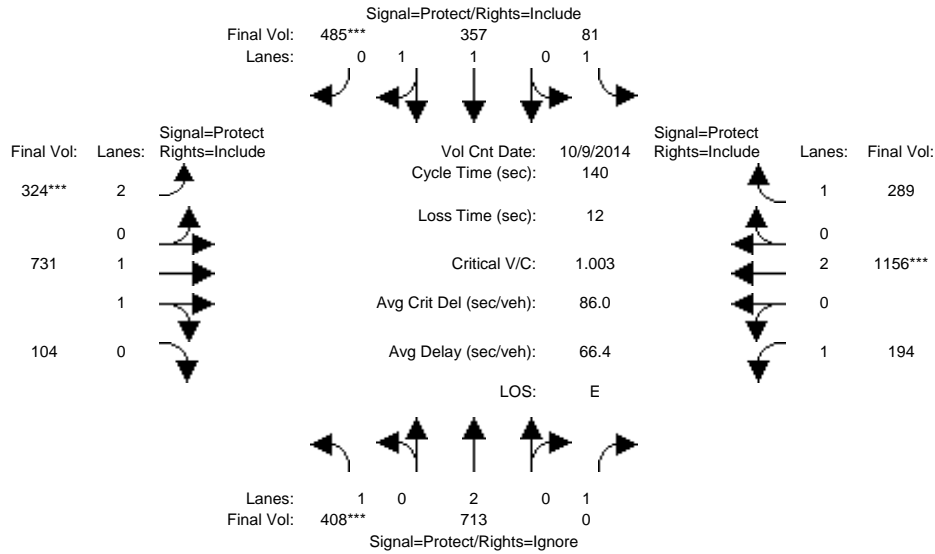

Approach:	North Bound			South Bound			East Bound			West Bound		
	L	T	R	L	T	R	L	T	R	L	T	R
Min. Green:	7	10	10	7	10	10	7	10	10	7	10	10
Y+R:	4.0	4.0	4.0	4.0	4.0	4.0	4.0	4.0	4.0	4.0	4.0	4.0

Volume Module:	Count Date: 9 Oct 2014											
Base Vol:	408	713	169	81	357	485	324	731	104	194	1156	289
Growth Adj:	1.00	1.00	1.00	1.00	1.00	1.00	1.00	1.00	1.00	1.00	1.00	1.00
Initial Bse:	408	713	169	81	357	485	324	731	104	194	1156	289
Added Vol:	0	0	0	0	0	0	0	0	0	0	0	0
PasserByVol:	0	0	0	0	0	0	0	0	0	0	0	0
Initial Fut:	408	713	169	81	357	485	324	731	104	194	1156	289
User Adj:	1.00	1.00	0.00	1.00	1.00	1.00	1.00	1.00	1.00	1.00	1.00	1.00
PHF Adj:	1.00	1.00	0.00	1.00	1.00	1.00	1.00	1.00	1.00	1.00	1.00	1.00
PHF Volume:	408	713	0	81	357	485	324	731	104	194	1156	289
Reduct Vol:	0	0	0	0	0	0	0	0	0	0	0	0
Reduced Vol:	408	713	0	81	357	485	324	731	104	194	1156	289
PCE Adj:	1.00	1.00	0.00	1.00	1.00	1.00	1.00	1.00	1.00	1.00	1.00	1.00
MLF Adj:	1.00	1.00	0.00	1.00	1.00	1.00	1.00	1.00	1.00	1.00	1.00	1.00
Final Volume:	408	713	0	81	357	485	324	731	104	194	1156	289

Saturation Flow Module:	Sat/Lane: 1900											
Adjustment:	0.92	1.00	0.92	0.92	1.00	0.92	0.83	0.98	0.95	0.92	1.00	0.92
Lanes:	1.00	2.00	1.00	1.00	1.00	1.00	2.00	1.74	0.26	1.00	2.00	1.00
Final Sat.:	1750	3800	1750	1750	1900	1750	3150	3239	461	1750	3800	1750

Capacity Analysis Module:	Vol/Sat: 0.23 0.19 0.00 0.05 0.19 0.28 0.10 0.23 0.23 0.11 0.30 0.17											
Crit Moves:	****					****	****				****	
Green Time:	32.5	56.2	0.0	15.0	38.7	38.7	14.4	38.1	38.1	18.7	42.4	42.4
Volume/Cap:	1.00	0.47	0.00	0.43	0.68	1.00	1.00	0.83	0.83	0.83	1.00	0.54
Delay/Veh:	99.2	31.1	0.0	60.1	46.7	82.5	113.8	53.8	53.8	80.4	76.1	41.9
User DelAdj:	1.00	1.00	1.00	1.00	1.00	1.00	1.00	1.00	1.00	1.00	1.00	1.00
AdjDel/Veh:	99.2	31.1	0.0	60.1	46.7	82.5	113.8	53.8	53.8	80.4	76.1	41.9
LOS by Move:	F	C	A	E	D	F	F	D	D	F	E	D
HCM2k95thQ:	38	20	0	7	24	44	19	31	31	18	48	20

Note: Queue reported is the number of cars per lane.

BART Phase II Extension Project

Level Of Service Computation Report
2000 HCM Operations (Future Volume Alternative)
PM - 2025 Project Conditions

Intersection #3625: KING/McKEE

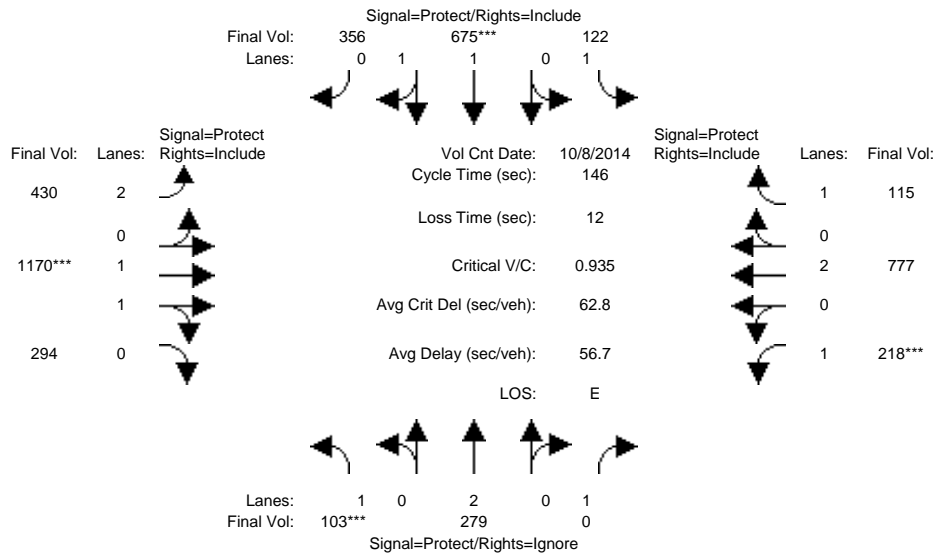

Approach:	North Bound			South Bound			East Bound			West Bound		
	L	T	R	L	T	R	L	T	R	L	T	R
Min. Green:	7	10	10	7	10	10	7	10	10	7	10	10
Y+R:	4.0	4.0	4.0	4.0	4.0	4.0	4.0	4.0	4.0	4.0	4.0	4.0
Volume Module: >> Count Date: 8 Oct 2014 <<												
Base Vol:	103	279	107	122	675	356	430	1170	294	218	777	115
Growth Adj:	1.00	1.00	1.00	1.00	1.00	1.00	1.00	1.00	1.00	1.00	1.00	1.00
Initial Bse:	103	279	107	122	675	356	430	1170	294	218	777	115
Added Vol:	0	0	0	0	0	0	0	0	0	0	0	0
PasserByVol:	0	0	0	0	0	0	0	0	0	0	0	0
Initial Fut:	103	279	107	122	675	356	430	1170	294	218	777	115
User Adj:	1.00	1.00	0.00	1.00	1.00	1.00	1.00	1.00	1.00	1.00	1.00	1.00
PHF Adj:	1.00	1.00	0.00	1.00	1.00	1.00	1.00	1.00	1.00	1.00	1.00	1.00
PHF Volume:	103	279	0	122	675	356	430	1170	294	218	777	115
Reduct Vol:	0	0	0	0	0	0	0	0	0	0	0	0
Reduced Vol:	103	279	0	122	675	356	430	1170	294	218	777	115
PCE Adj:	1.00	1.00	0.00	1.00	1.00	1.00	1.00	1.00	1.00	1.00	1.00	1.00
MLF Adj:	1.00	1.00	0.00	1.00	1.00	1.00	1.00	1.00	1.00	1.00	1.00	1.00
FinalVolume:	103	279	0	122	675	356	430	1170	294	218	777	115
Saturation Flow Module:												
Sat/Lane:	1900	1900	1900	1900	1900	1900	1900	1900	1900	1900	1900	1900
Adjustment:	0.92	1.00	0.92	0.92	0.99	0.95	0.83	0.98	0.95	0.92	1.00	0.92
Lanes:	1.00	2.00	1.00	1.00	1.29	0.71	2.00	1.59	0.41	1.00	2.00	1.00
Final Sat.:	1750	3800	1750	1750	2421	1277	3150	2956	743	1750	3800	1750
Capacity Analysis Module:												
Vol/Sat:	0.06	0.07	0.00	0.07	0.28	0.28	0.14	0.40	0.40	0.12	0.20	0.07
Crit Moves:	****			****			****			****		
Green Time:	9.2	27.0	0.0	25.7	43.5	43.5	32.5	61.8	61.8	19.5	48.7	48.7
Volume/Cap:	0.93	0.40	0.00	0.40	0.93	0.93	0.61	0.93	0.93	0.93	0.61	0.20
Delay/Veh:	133.2	52.7	0.0	54.1	64.0	64.0	52.7	51.0	51.0	103.9	41.6	34.8
User DelAdj:	1.00	1.00	1.00	1.00	1.00	1.00	1.00	1.00	1.00	1.00	1.00	1.00
AdjDel/Veh:	133.2	52.7	0.0	54.1	64.0	64.0	52.7	51.0	51.0	103.9	41.6	34.8
LOS by Move:	F	D	A	D	E	E	D	D	D	F	D	C
HCM2k95thQ:	12	10	0	10	42	42	19	56	56	22	25	8

Note: Queue reported is the number of cars per lane.

BART Phase II Extension Project

Level Of Service Computation Report
2000 HCM Operations (Future Volume Alternative)
AM - 2025 Project Conditions

Intersection #3683: McLAUGHLIN/STORY

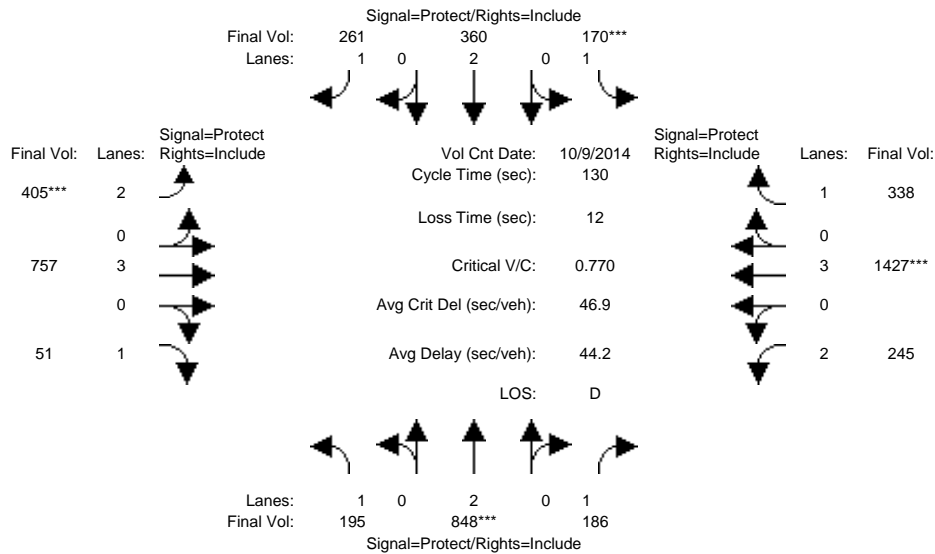

Approach:	North Bound			South Bound			East Bound			West Bound		
Movement:	L	T	R	L	T	R	L	T	R	L	T	R
Min. Green:	7	10	10	7	10	10	7	10	10	7	10	10
Y+R:	4.0	4.0	4.0	4.0	4.0	4.0	4.0	4.0	4.0	4.0	4.0	4.0
Volume Module: >> Count Date: 9 Oct 2014 <<												
Base Vol:	195	848	186	170	360	261	405	757	51	245	1427	338
Growth Adj:	1.00	1.00	1.00	1.00	1.00	1.00	1.00	1.00	1.00	1.00	1.00	1.00
Initial Bse:	195	848	186	170	360	261	405	757	51	245	1427	338
Added Vol:	0	0	0	0	0	0	0	0	0	0	0	0
PasserByVol:	0	0	0	0	0	0	0	0	0	0	0	0
Initial Fut:	195	848	186	170	360	261	405	757	51	245	1427	338
User Adj:	1.00	1.00	1.00	1.00	1.00	1.00	1.00	1.00	1.00	1.00	1.00	1.00
PHF Adj:	1.00	1.00	1.00	1.00	1.00	1.00	1.00	1.00	1.00	1.00	1.00	1.00
PHF Volume:	195	848	186	170	360	261	405	757	51	245	1427	338
Reduct Vol:	0	0	0	0	0	0	0	0	0	0	0	0
Reduced Vol:	195	848	186	170	360	261	405	757	51	245	1427	338
PCE Adj:	1.00	1.00	1.00	1.00	1.00	1.00	1.00	1.00	1.00	1.00	1.00	1.00
MLF Adj:	1.00	1.00	1.00	1.00	1.00	1.00	1.00	1.00	1.00	1.00	1.00	1.00
Final Volume:	195	848	186	170	360	261	405	757	51	245	1427	338
Saturation Flow Module:												
Sat/Lane:	1900	1900	1900	1900	1900	1900	1900	1900	1900	1900	1900	1900
Adjustment:	0.92	1.00	0.92	0.92	1.00	0.92	0.83	1.00	0.92	0.83	1.00	0.92
Lanes:	1.00	2.00	1.00	1.00	2.00	1.00	2.00	3.00	1.00	2.00	3.00	1.00
Final Sat.:	1750	3800	1750	1750	3800	1750	3150	5700	1750	3150	5700	1750
Capacity Analysis Module:												
Vol/Sat:	0.11	0.22	0.11	0.10	0.09	0.15	0.13	0.13	0.03	0.08	0.25	0.19
Crit Moves:	****			****			****			****		
Green Time:	23.1	37.7	37.7	16.4	30.9	30.9	21.7	40.3	40.3	23.6	42.2	42.2
Volume/Cap:	0.63	0.77	0.37	0.77	0.40	0.63	0.77	0.43	0.09	0.43	0.77	0.59
Delay/Veh:	53.5	45.6	37.1	70.2	42.0	47.4	58.6	35.8	31.9	47.7	41.5	38.4
User DelAdj:	1.00	1.00	1.00	1.00	1.00	1.00	1.00	1.00	1.00	1.00	1.00	1.00
AdjDel/Veh:	53.5	45.6	37.1	70.2	42.0	47.4	58.6	35.8	31.9	47.7	41.5	38.4
LOS by Move:	D	D	D	E	D	D	E	D	C	D	D	D
HCM2k95thQ:	16	29	12	14	11	18	20	15	3	10	30	22

Note: Queue reported is the number of cars per lane.

BART Phase II Extension Project

Level Of Service Computation Report
2000 HCM Operations (Future Volume Alternative)
PM - 2025 Project Conditions

Intersection #3683: McLAUGHLIN/STORY

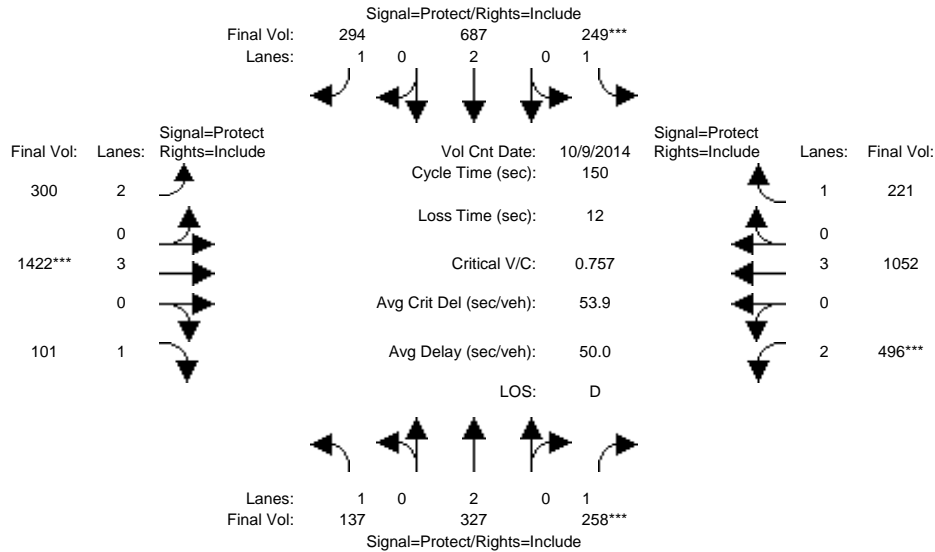

Approach:	North Bound			South Bound			East Bound			West Bound		
Movement:	L	T	R	L	T	R	L	T	R	L	T	R
Min. Green:	7	10	10	7	10	10	7	10	10	7	10	10
Y+R:	4.0	4.0	4.0	4.0	4.0	4.0	4.0	4.0	4.0	4.0	4.0	4.0
Volume Module: >> Count Date: 9 Oct 2014 <<												
Base Vol:	137	327	258	249	687	294	300	1422	101	496	1052	221
Growth Adj:	1.00	1.00	1.00	1.00	1.00	1.00	1.00	1.00	1.00	1.00	1.00	1.00
Initial Bse:	137	327	258	249	687	294	300	1422	101	496	1052	221
Added Vol:	0	0	0	0	0	0	0	0	0	0	0	0
PasserByVol:	0	0	0	0	0	0	0	0	0	0	0	0
Initial Fut:	137	327	258	249	687	294	300	1422	101	496	1052	221
User Adj:	1.00	1.00	1.00	1.00	1.00	1.00	1.00	1.00	1.00	1.00	1.00	1.00
PHF Adj:	1.00	1.00	1.00	1.00	1.00	1.00	1.00	1.00	1.00	1.00	1.00	1.00
PHF Volume:	137	327	258	249	687	294	300	1422	101	496	1052	221
Reduct Vol:	0	0	0	0	0	0	0	0	0	0	0	0
Reduced Vol:	137	327	258	249	687	294	300	1422	101	496	1052	221
PCE Adj:	1.00	1.00	1.00	1.00	1.00	1.00	1.00	1.00	1.00	1.00	1.00	1.00
MLF Adj:	1.00	1.00	1.00	1.00	1.00	1.00	1.00	1.00	1.00	1.00	1.00	1.00
Final Volume:	137	327	258	249	687	294	300	1422	101	496	1052	221
Saturation Flow Module:												
Sat/Lane:	1900	1900	1900	1900	1900	1900	1900	1900	1900	1900	1900	1900
Adjustment:	0.92	1.00	0.92	0.92	1.00	0.92	0.83	1.00	0.92	0.83	1.00	0.92
Lanes:	1.00	2.00	1.00	1.00	2.00	1.00	2.00	3.00	1.00	2.00	3.00	1.00
Final Sat.:	1750	3800	1750	1750	3800	1750	3150	5700	1750	3150	5700	1750
Capacity Analysis Module:												
Vol/Sat:	0.08	0.09	0.15	0.14	0.18	0.17	0.10	0.25	0.06	0.16	0.18	0.13
Crit Moves:			****	****				****		****		
Green Time:	17.3	29.2	29.2	28.2	40.0	40.0	27.4	49.4	49.4	31.2	53.2	53.2
Volume/Cap:	0.68	0.44	0.76	0.76	0.68	0.63	0.52	0.76	0.18	0.76	0.52	0.36
Delay/Veh:	72.5	53.6	66.5	67.4	51.0	51.2	56.2	46.8	35.9	60.9	38.6	36.1
User DelAdj:	1.00	1.00	1.00	1.00	1.00	1.00	1.00	1.00	1.00	1.00	1.00	1.00
AdjDel/Veh:	72.5	53.6	66.5	67.4	51.0	51.2	56.2	46.8	35.9	60.9	38.6	36.1
LOS by Move:	E	D	E	E	D	D	E	D	D	E	D	D
HCM2k95thQ:	15	13	24	22	25	23	15	35	7	24	22	15

Note: Queue reported is the number of cars per lane.

BART Phase II Extension Project

Level Of Service Computation Report
2000 HCM Operations (Future Volume Alternative)
AM - 2025 Project Conditions

Intersection #3762: SAN ANTONIO/24TH

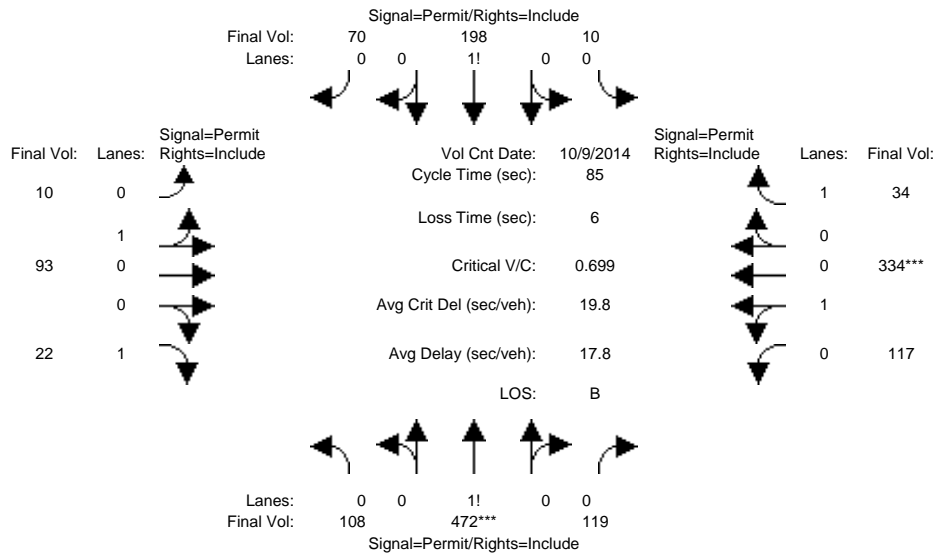

Approach:	North Bound			South Bound			East Bound			West Bound		
Movement:	L	T	R	L	T	R	L	T	R	L	T	R
Min. Green:	10	10	10	10	10	10	10	10	10	10	10	10
Y+R:	4.0	4.0	4.0	4.0	4.0	4.0	4.0	4.0	4.0	4.0	4.0	4.0
Volume Module: >> Count Date: 9 Oct 2014 <<												
Base Vol:	108	472	119	10	198	70	10	93	22	117	334	34
Growth Adj:	1.00	1.00	1.00	1.00	1.00	1.00	1.00	1.00	1.00	1.00	1.00	1.00
Initial Bse:	108	472	119	10	198	70	10	93	22	117	334	34
Added Vol:	0	0	0	0	0	0	0	0	0	0	0	0
PasserByVol:	0	0	0	0	0	0	0	0	0	0	0	0
Initial Fut:	108	472	119	10	198	70	10	93	22	117	334	34
User Adj:	1.00	1.00	1.00	1.00	1.00	1.00	1.00	1.00	1.00	1.00	1.00	1.00
PHF Adj:	1.00	1.00	1.00	1.00	1.00	1.00	1.00	1.00	1.00	1.00	1.00	1.00
PHF Volume:	108	472	119	10	198	70	10	93	22	117	334	34
Reduct Vol:	0	0	0	0	0	0	0	0	0	0	0	0
Reduced Vol:	108	472	119	10	198	70	10	93	22	117	334	34
PCE Adj:	1.00	1.00	1.00	1.00	1.00	1.00	1.00	1.00	1.00	1.00	1.00	1.00
MLF Adj:	1.00	1.00	1.00	1.00	1.00	1.00	1.00	1.00	1.00	1.00	1.00	1.00
FinalVolume:	108	472	119	10	198	70	10	93	22	117	334	34
Saturation Flow Module:												
Sat/Lane:	1900	1900	1900	1900	1900	1900	1900	1900	1900	1900	1900	1900
Adjustment:	0.92	0.92	0.92	0.92	0.92	0.92	0.95	0.95	0.92	0.95	0.95	0.92
Lanes:	0.15	0.68	0.17	0.04	0.71	0.25	0.10	0.90	1.00	0.26	0.74	1.00
Final Sat.:	270	1182	298	63	1246	441	175	1625	1750	467	1333	1750
Capacity Analysis Module:												
Vol/Sat:	0.40	0.40	0.40	0.16	0.16	0.16	0.06	0.06	0.01	0.25	0.25	0.02
Crit Moves:	****											
Green Time:	48.5	48.5	48.5	48.5	48.5	48.5	30.5	30.5	30.5	30.5	30.5	30.5
Volume/Cap:	0.70	0.70	0.70	0.28	0.28	0.28	0.16	0.16	0.04	0.70	0.70	0.05
Delay/Veh:	15.2	15.2	15.2	9.4	9.4	9.4	18.7	18.7	17.7	26.8	26.8	17.9
User DelAdj:	1.00	1.00	1.00	1.00	1.00	1.00	1.00	1.00	1.00	1.00	1.00	1.00
AdjDel/Veh:	15.2	15.2	15.2	9.4	9.4	9.4	18.7	18.7	17.7	26.8	26.8	17.9
LOS by Move:	B	B	B	A	A	A	B	B	B	C	C	B
HCM2k95thQ:	25	25	25	8	8	8	4	4	1	20	20	1

Note: Queue reported is the number of cars per lane.

BART Phase II Extension Project

Level Of Service Computation Report
2000 HCM Operations (Future Volume Alternative)
PM - 2025 Project Conditions

Intersection #3762: SAN ANTONIO/24TH

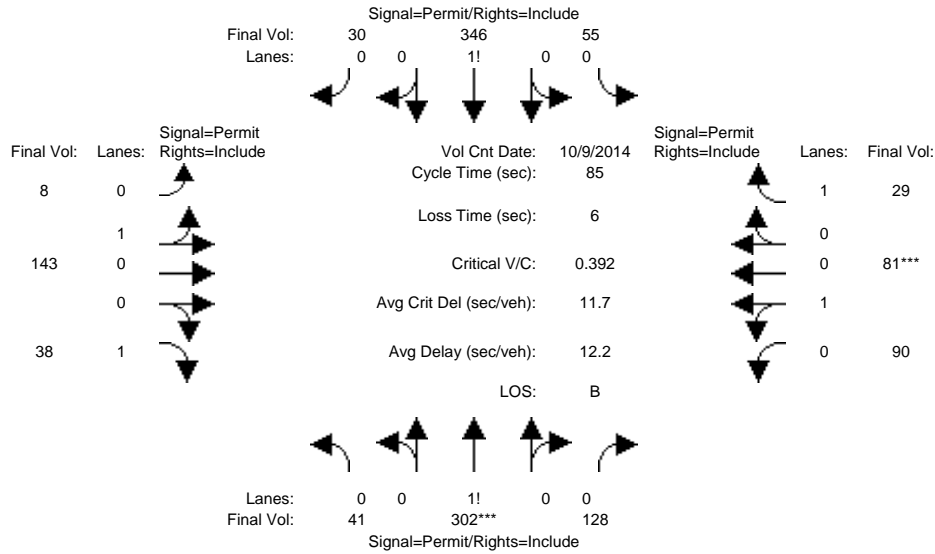

Approach:	North Bound			South Bound			East Bound			West Bound		
	L	T	R	L	T	R	L	T	R	L	T	R
Min. Green:	10	10	10	10	10	10	10	10	10	10	10	10
Y+R:	4.0	4.0	4.0	4.0	4.0	4.0	4.0	4.0	4.0	4.0	4.0	4.0
Volume Module: >> Count Date: 9 Oct 2014 <<												
Base Vol:	41	302	128	55	346	30	8	143	38	90	81	29
Growth Adj:	1.00	1.00	1.00	1.00	1.00	1.00	1.00	1.00	1.00	1.00	1.00	1.00
Initial Bse:	41	302	128	55	346	30	8	143	38	90	81	29
Added Vol:	0	0	0	0	0	0	0	0	0	0	0	0
PasserByVol:	0	0	0	0	0	0	0	0	0	0	0	0
Initial Fut:	41	302	128	55	346	30	8	143	38	90	81	29
User Adj:	1.00	1.00	1.00	1.00	1.00	1.00	1.00	1.00	1.00	1.00	1.00	1.00
PHF Adj:	1.00	1.00	1.00	1.00	1.00	1.00	1.00	1.00	1.00	1.00	1.00	1.00
PHF Volume:	41	302	128	55	346	30	8	143	38	90	81	29
Reduct Vol:	0	0	0	0	0	0	0	0	0	0	0	0
Reduced Vol:	41	302	128	55	346	30	8	143	38	90	81	29
PCE Adj:	1.00	1.00	1.00	1.00	1.00	1.00	1.00	1.00	1.00	1.00	1.00	1.00
MLF Adj:	1.00	1.00	1.00	1.00	1.00	1.00	1.00	1.00	1.00	1.00	1.00	1.00
FinalVolume:	41	302	128	55	346	30	8	143	38	90	81	29
Saturation Flow Module:												
Sat/Lane:	1900	1900	1900	1900	1900	1900	1900	1900	1900	1900	1900	1900
Adjustment:	0.92	0.92	0.92	0.92	0.92	0.92	0.95	0.95	0.92	0.95	0.95	0.92
Lanes:	0.09	0.64	0.27	0.13	0.80	0.07	0.05	0.95	1.00	0.53	0.47	1.00
Final Sat.:	152	1122	476	223	1405	122	95	1705	1750	947	853	1750
Capacity Analysis Module:												
Vol/Sat:	0.27	0.27	0.27	0.25	0.25	0.25	0.08	0.08	0.02	0.10	0.10	0.02
Crit Moves:	****											
Green Time:	58.4	58.4	58.4	58.4	58.4	58.4	20.6	20.6	20.6	20.6	20.6	20.6
Volume/Cap:	0.39	0.39	0.39	0.36	0.36	0.36	0.35	0.35	0.09	0.39	0.39	0.07
Delay/Veh:	5.9	5.9	5.9	5.7	5.7	5.7	27.1	27.1	25.0	27.5	27.5	24.9
User DelAdj:	1.00	1.00	1.00	1.00	1.00	1.00	1.00	1.00	1.00	1.00	1.00	1.00
AdjDel/Veh:	5.9	5.9	5.9	5.7	5.7	5.7	27.1	27.1	25.0	27.5	27.5	24.9
LOS by Move:	A	A	A	A	A	A	C	C	C	C	C	C
HCM2k95thQ:	11	11	11	10	10	10	7	7	2	8	8	1

Note: Queue reported is the number of cars per lane.

BART Phase II Extension Project

Level Of Service Computation Report
2000 HCM Operations (Future Volume Alternative)
AM - 2025 Project Conditions

Intersection #3783: SANTA CLARA/17TH

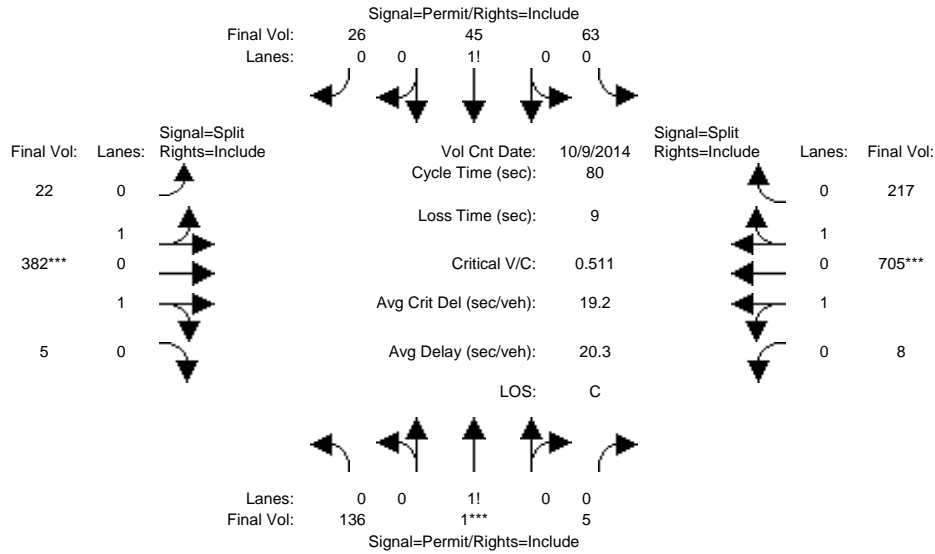

Approach:	North Bound			South Bound			East Bound			West Bound		
	L	T	R	L	T	R	L	T	R	L	T	R
Min. Green:	10	10	10	10	10	10	10	10	10	10	10	10
Y+R:	4.0	4.0	4.0	4.0	4.0	4.0	4.0	4.0	4.0	4.0	4.0	4.0

Volume Module:	>>	Count	Date:	9 Oct 2014	<<							
Base Vol:	136	1	5	63	45	26	22	382	5	8	705	217
Growth Adj:	1.00	1.00	1.00	1.00	1.00	1.00	1.00	1.00	1.00	1.00	1.00	1.00
Initial Bse:	136	1	5	63	45	26	22	382	5	8	705	217
Added Vol:	0	0	0	0	0	0	0	0	0	0	0	0
PasserByVol:	0	0	0	0	0	0	0	0	0	0	0	0
Initial Fut:	136	1	5	63	45	26	22	382	5	8	705	217
User Adj:	1.00	1.00	1.00	1.00	1.00	1.00	1.00	1.00	1.00	1.00	1.00	1.00
PHF Adj:	1.00	1.00	1.00	1.00	1.00	1.00	1.00	1.00	1.00	1.00	1.00	1.00
PHF Volume:	136	1	5	63	45	26	22	382	5	8	705	217
Reduct Vol:	0	0	0	0	0	0	0	0	0	0	0	0
Reduced Vol:	136	1	5	63	45	26	22	382	5	8	705	217
PCE Adj:	1.00	1.00	1.00	1.00	1.00	1.00	1.00	1.00	1.00	1.00	1.00	1.00
MLF Adj:	1.00	1.00	1.00	1.00	1.00	1.00	1.00	1.00	1.00	1.00	1.00	1.00
FinalVolume:	136	1	5	63	45	26	22	382	5	8	705	217

Saturation Flow Module:												
Sat/Lane:	1900	1900	1900	1900	1900	1900	1900	1900	1900	1900	1900	1900
Adjustment:	0.92	0.92	0.92	0.92	0.92	0.92	0.95	0.95	0.95	0.95	0.95	0.95
Lanes:	0.96	0.01	0.03	0.47	0.34	0.19	0.11	1.87	0.02	0.02	1.51	0.47
Final Sat.:	1676	12	62	823	588	340	194	3362	44	31	2729	840

Capacity Analysis Module:												
Vol/Sat:	0.08	0.08	0.08	0.08	0.08	0.08	0.11	0.11	0.11	0.26	0.26	0.26
Crit Moves:	****						****			****		
Green Time:	12.7	12.7	12.7	12.7	12.7	12.7	17.8	17.8	17.8	40.5	40.5	40.5
Volume/Cap:	0.51	0.51	0.51	0.48	0.48	0.48	0.51	0.51	0.51	0.51	0.51	0.51
Delay/Veh:	32.4	32.4	32.4	32.0	32.0	32.0	27.8	27.8	27.8	13.4	13.4	13.4
User DelAdj:	1.00	1.00	1.00	1.00	1.00	1.00	1.00	1.00	1.00	1.00	1.00	1.00
AdjDel/Veh:	32.4	32.4	32.4	32.0	32.0	32.0	27.8	27.8	27.8	13.4	13.4	13.4
LOS by Move:	C	C	C	C	C	C	C	C	C	B	B	B
HCM2k95thQ:	8	8	8	8	8	8	10	10	10	15	15	15

Note: Queue reported is the number of cars per lane.

BART Phase II Extension Project

Level Of Service Computation Report
2000 HCM Operations (Future Volume Alternative)
PM - 2025 Project Conditions

Intersection #3783: SANTA CLARA/17TH

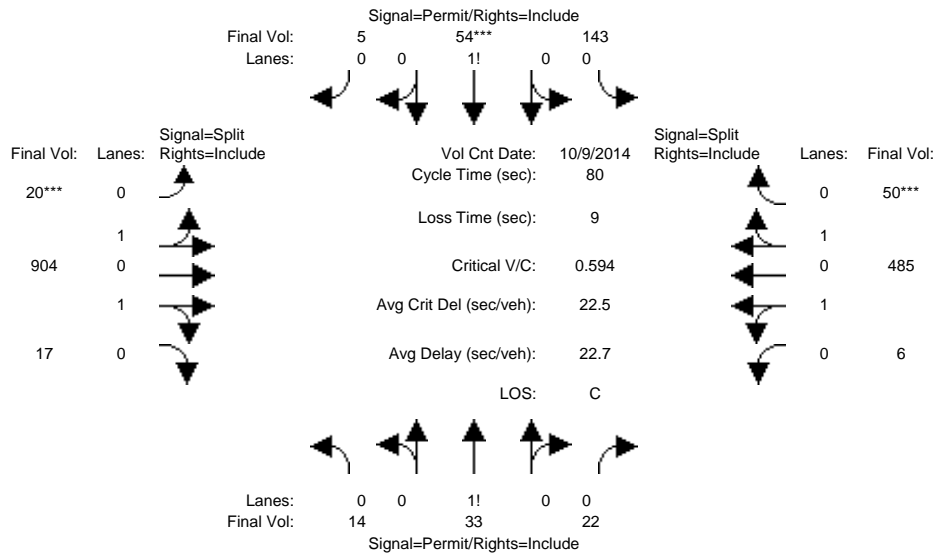

Approach:	North Bound			South Bound			East Bound			West Bound		
	L	T	R	L	T	R	L	T	R	L	T	R
Min. Green:	10	10	10	10	10	10	10	10	10	10	10	10
Y+R:	4.0	4.0	4.0	4.0	4.0	4.0	4.0	4.0	4.0	4.0	4.0	4.0

Volume Module:	>>	Count	Date:	9 Oct 2014	<<							
Base Vol:	14	33	22	143	54	5	20	904	17	6	485	50
Growth Adj:	1.00	1.00	1.00	1.00	1.00	1.00	1.00	1.00	1.00	1.00	1.00	1.00
Initial Bse:	14	33	22	143	54	5	20	904	17	6	485	50
Added Vol:	0	0	0	0	0	0	0	0	0	0	0	0
PasserByVol:	0	0	0	0	0	0	0	0	0	0	0	0
Initial Fut:	14	33	22	143	54	5	20	904	17	6	485	50
User Adj:	1.00	1.00	1.00	1.00	1.00	1.00	1.00	1.00	1.00	1.00	1.00	1.00
PHF Adj:	1.00	1.00	1.00	1.00	1.00	1.00	1.00	1.00	1.00	1.00	1.00	1.00
PHF Volume:	14	33	22	143	54	5	20	904	17	6	485	50
Reduct Vol:	0	0	0	0	0	0	0	0	0	0	0	0
Reduced Vol:	14	33	22	143	54	5	20	904	17	6	485	50
PCE Adj:	1.00	1.00	1.00	1.00	1.00	1.00	1.00	1.00	1.00	1.00	1.00	1.00
MLF Adj:	1.00	1.00	1.00	1.00	1.00	1.00	1.00	1.00	1.00	1.00	1.00	1.00
FinalVolume:	14	33	22	143	54	5	20	904	17	6	485	50

Saturation Flow Module:												
Sat/Lane:	1900	1900	1900	1900	1900	1900	1900	1900	1900	1900	1900	1900
Adjustment:	0.92	0.92	0.92	0.92	0.92	0.92	0.95	0.95	0.95	0.95	0.95	0.95
Lanes:	0.20	0.48	0.32	0.71	0.27	0.02	0.04	1.92	0.04	0.02	1.80	0.18
Final Sat.:	355	837	558	1239	468	43	77	3458	65	40	3227	333

Capacity Analysis Module:												
Vol/Sat:	0.04	0.04	0.04	0.12	0.12	0.12	0.26	0.26	0.26	0.15	0.15	0.15
Crit Moves:				****	****	****	****	****	****	****	****	****
Green Time:	15.5	15.5	15.5	15.5	15.5	15.5	35.2	35.2	35.2	20.2	20.2	20.2
Volume/Cap:	0.20	0.20	0.20	0.59	0.59	0.59	0.59	0.59	0.59	0.59	0.59	0.59
Delay/Veh:	27.3	27.3	27.3	32.2	32.2	32.2	17.6	17.6	17.6	27.3	27.3	27.3
User DelAdj:	1.00	1.00	1.00	1.00	1.00	1.00	1.00	1.00	1.00	1.00	1.00	1.00
AdjDel/Veh:	27.3	27.3	27.3	32.2	32.2	32.2	17.6	17.6	17.6	27.3	27.3	27.3
LOS by Move:	C	C	C	C	C	C	B	B	B	C	C	C
HCM2k95thQ:	3	3	3	11	11	11	18	18	18	12	12	12

Note: Queue reported is the number of cars per lane.

BART Phase II Extension Project

Level Of Service Computation Report
2000 HCM Operations (Future Volume Alternative)
AM - 2025 Project Conditions

Intersection #3788: SANTA CLARA/28TH

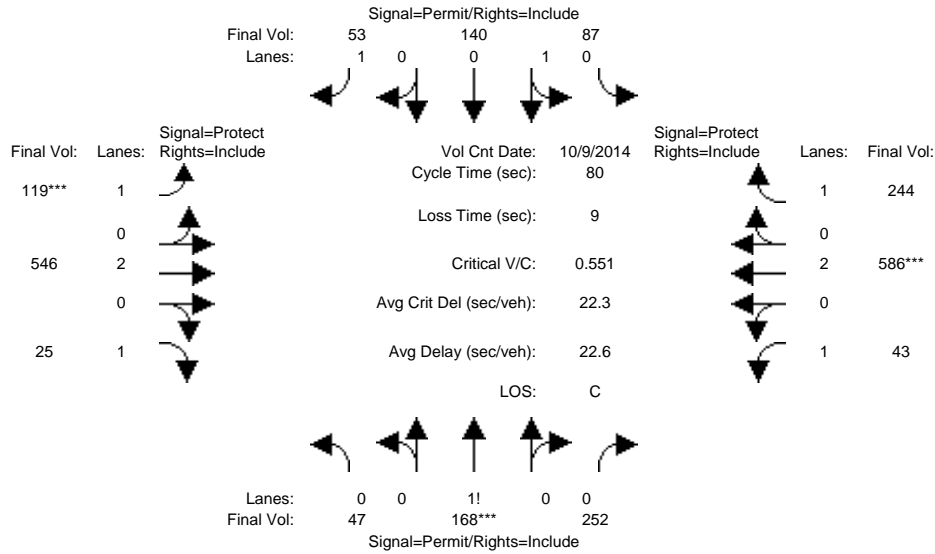

Approach:	North Bound			South Bound			East Bound			West Bound		
	L	T	R	L	T	R	L	T	R	L	T	R
Min. Green:	10	10	10	10	10	10	7	10	10	7	10	10
Y+R:	4.0	4.0	4.0	4.0	4.0	4.0	4.0	4.0	4.0	4.0	4.0	4.0
Volume Module: >> Count Date: 9 Oct 2014 <<												
Base Vol:	47	168	252	87	140	53	119	546	25	43	586	244
Growth Adj:	1.00	1.00	1.00	1.00	1.00	1.00	1.00	1.00	1.00	1.00	1.00	1.00
Initial Bse:	47	168	252	87	140	53	119	546	25	43	586	244
Added Vol:	0	0	0	0	0	0	0	0	0	0	0	0
PasserByVol:	0	0	0	0	0	0	0	0	0	0	0	0
Initial Fut:	47	168	252	87	140	53	119	546	25	43	586	244
User Adj:	1.00	1.00	1.00	1.00	1.00	1.00	1.00	1.00	1.00	1.00	1.00	1.00
PHF Adj:	1.00	1.00	1.00	1.00	1.00	1.00	1.00	1.00	1.00	1.00	1.00	1.00
PHF Volume:	47	168	252	87	140	53	119	546	25	43	586	244
Reduct Vol:	0	0	0	0	0	0	0	0	0	0	0	0
Reduced Vol:	47	168	252	87	140	53	119	546	25	43	586	244
PCE Adj:	1.00	1.00	1.00	1.00	1.00	1.00	1.00	1.00	1.00	1.00	1.00	1.00
MLF Adj:	1.00	1.00	1.00	1.00	1.00	1.00	1.00	1.00	1.00	1.00	1.00	1.00
FinalVolume:	47	168	252	87	140	53	119	546	25	43	586	244
Saturation Flow Module:												
Sat/Lane:	1900	1900	1900	1900	1900	1900	1900	1900	1900	1900	1900	1900
Adjustment:	0.92	0.92	0.92	0.95	0.95	0.92	0.92	1.00	0.92	0.92	1.00	0.92
Lanes:	0.10	0.36	0.54	0.38	0.62	1.00	1.00	2.00	1.00	1.00	2.00	1.00
Final Sat.:	176	630	944	690	1110	1750	1750	3800	1750	1750	3800	1750
Capacity Analysis Module:												
Vol/Sat:	0.27	0.27	0.27	0.13	0.13	0.03	0.07	0.14	0.01	0.02	0.15	0.14
Crit Moves:	****						****			****		
Green Time:	38.7	38.7	38.7	38.7	38.7	38.7	9.9	20.0	20.0	12.2	22.4	22.4
Volume/Cap:	0.55	0.55	0.55	0.26	0.26	0.06	0.55	0.57	0.06	0.16	0.55	0.50
Delay/Veh:	15.3	15.3	15.3	12.3	12.3	11.0	36.0	27.1	22.8	29.7	25.2	24.9
User DelAdj:	1.00	1.00	1.00	1.00	1.00	1.00	1.00	1.00	1.00	1.00	1.00	1.00
AdjDel/Veh:	15.3	15.3	15.3	12.3	12.3	11.0	36.0	27.1	22.8	29.7	25.2	24.9
LOS by Move:	B	B	B	B	B	B	D	C	C	C	C	C
HCM2k95thQ:	16	16	16	7	7	2	6	11	1	2	12	10

Note: Queue reported is the number of cars per lane.

BART Phase II Extension Project

Level Of Service Computation Report
2000 HCM Operations (Future Volume Alternative)
PM - 2025 Project Conditions

Intersection #3788: SANTA CLARA/28TH

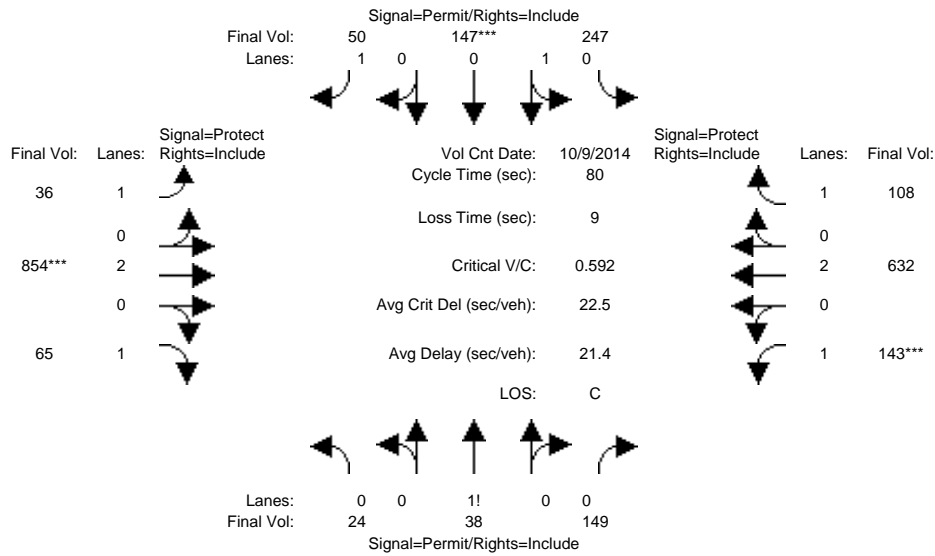

Approach:	North Bound			South Bound			East Bound			West Bound		
	L	T	R	L	T	R	L	T	R	L	T	R
Min. Green:	10	10	10	10	10	10	7	10	10	7	10	10
Y+R:	4.0	4.0	4.0	4.0	4.0	4.0	4.0	4.0	4.0	4.0	4.0	4.0
Volume Module: >> Count Date: 9 Oct 2014 <<												
Base Vol:	24	38	149	247	147	50	36	854	65	143	632	108
Growth Adj:	1.00	1.00	1.00	1.00	1.00	1.00	1.00	1.00	1.00	1.00	1.00	1.00
Initial Bse:	24	38	149	247	147	50	36	854	65	143	632	108
Added Vol:	0	0	0	0	0	0	0	0	0	0	0	0
PasserByVol:	0	0	0	0	0	0	0	0	0	0	0	0
Initial Fut:	24	38	149	247	147	50	36	854	65	143	632	108
User Adj:	1.00	1.00	1.00	1.00	1.00	1.00	1.00	1.00	1.00	1.00	1.00	1.00
PHF Adj:	1.00	1.00	1.00	1.00	1.00	1.00	1.00	1.00	1.00	1.00	1.00	1.00
PHF Volume:	24	38	149	247	147	50	36	854	65	143	632	108
Reduct Vol:	0	0	0	0	0	0	0	0	0	0	0	0
Reduced Vol:	24	38	149	247	147	50	36	854	65	143	632	108
PCE Adj:	1.00	1.00	1.00	1.00	1.00	1.00	1.00	1.00	1.00	1.00	1.00	1.00
MLF Adj:	1.00	1.00	1.00	1.00	1.00	1.00	1.00	1.00	1.00	1.00	1.00	1.00
FinalVolume:	24	38	149	247	147	50	36	854	65	143	632	108
Saturation Flow Module:												
Sat/Lane:	1900	1900	1900	1900	1900	1900	1900	1900	1900	1900	1900	1900
Adjustment:	0.92	0.92	0.92	0.95	0.95	0.92	0.92	1.00	0.92	0.92	1.00	0.92
Lanes:	0.11	0.18	0.71	0.63	0.37	1.00	1.00	2.00	1.00	1.00	2.00	1.00
Final Sat.:	199	315	1236	1128	672	1750	1750	3800	1750	1750	3800	1750
Capacity Analysis Module:												
Vol/Sat:	0.12	0.12	0.12	0.22	0.22	0.03	0.02	0.22	0.04	0.08	0.17	0.06
Crit Moves:				****			****			****		
Green Time:	29.6	29.6	29.6	29.6	29.6	29.6	14.3	30.4	30.4	11.0	27.1	27.1
Volume/Cap:	0.33	0.33	0.33	0.59	0.59	0.08	0.12	0.59	0.10	0.59	0.49	0.18
Delay/Veh:	18.4	18.4	18.4	21.8	21.8	16.4	27.7	20.5	16.1	36.2	21.2	18.8
User DelAdj:	1.00	1.00	1.00	1.00	1.00	1.00	1.00	1.00	1.00	1.00	1.00	1.00
AdjDel/Veh:	18.4	18.4	18.4	21.8	21.8	16.4	27.7	20.5	16.1	36.2	21.2	18.8
LOS by Move:	B	B	B	C	C	B	C	C	B	D	C	B
HCM2k95thQ:	8	8	8	17	17	2	2	16	2	7	12	4

Note: Queue reported is the number of cars per lane.

BART Phase II Extension Project

Level Of Service Computation Report
2000 HCM Operations (Future Volume Alternative)
AM - 2025 Project Conditions

Intersection #3789: SANTA CLARA/21ST

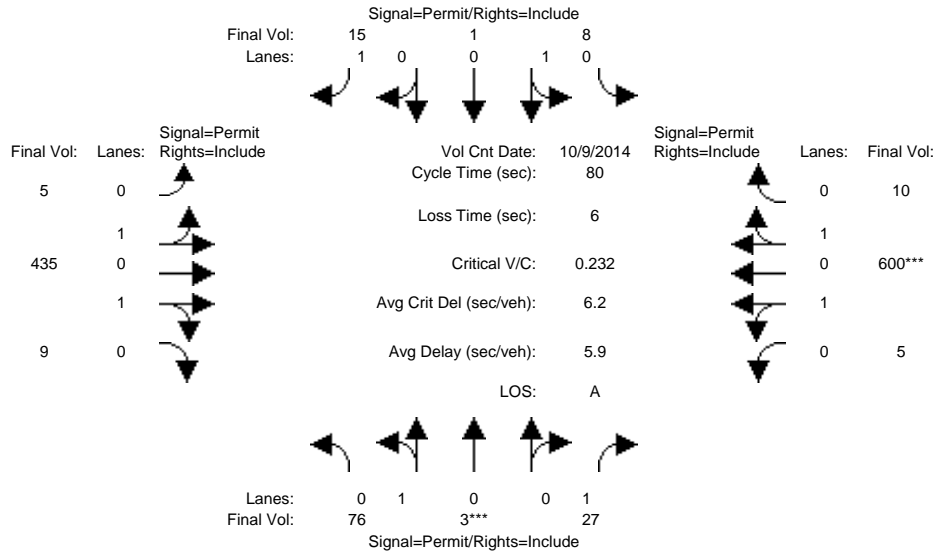

Approach:	North Bound			South Bound			East Bound			West Bound		
Movement:	L	T	R	L	T	R	L	T	R	L	T	R
Min. Green:	10	10	10	10	10	10	10	10	10	10	10	10
Y+R:	4.0	4.0	4.0	4.0	4.0	4.0	4.0	4.0	4.0	4.0	4.0	4.0
Volume Module: >> Count Date: 9 Oct 2014 <<												
Base Vol:	76	3	27	8	1	15	5	435	9	5	600	10
Growth Adj:	1.00	1.00	1.00	1.00	1.00	1.00	1.00	1.00	1.00	1.00	1.00	1.00
Initial Bse:	76	3	27	8	1	15	5	435	9	5	600	10
Added Vol:	0	0	0	0	0	0	0	0	0	0	0	0
PasserByVol:	0	0	0	0	0	0	0	0	0	0	0	0
Initial Fut:	76	3	27	8	1	15	5	435	9	5	600	10
User Adj:	1.00	1.00	1.00	1.00	1.00	1.00	1.00	1.00	1.00	1.00	1.00	1.00
PHF Adj:	1.00	1.00	1.00	1.00	1.00	1.00	1.00	1.00	1.00	1.00	1.00	1.00
PHF Volume:	76	3	27	8	1	15	5	435	9	5	600	10
Reduct Vol:	0	0	0	0	0	0	0	0	0	0	0	0
Reduced Vol:	76	3	27	8	1	15	5	435	9	5	600	10
PCE Adj:	1.00	1.00	1.00	1.00	1.00	1.00	1.00	1.00	1.00	1.00	1.00	1.00
MLF Adj:	1.00	1.00	1.00	1.00	1.00	1.00	1.00	1.00	1.00	1.00	1.00	1.00
FinalVolume:	76	3	27	8	1	15	5	435	9	5	600	10
Saturation Flow Module:												
Sat/Lane:	1900	1900	1900	1900	1900	1900	1900	1900	1900	1900	1900	1900
Adjustment:	0.95	0.95	0.92	0.95	0.95	0.92	0.95	0.95	0.95	0.95	0.95	0.95
Lanes:	0.96	0.04	1.00	0.89	0.11	1.00	0.02	1.94	0.04	0.02	1.95	0.03
Final Sat.:	1732	68	1750	1600	200	1750	40	3488	72	29	3512	59
Capacity Analysis Module:												
Vol/Sat:	0.04	0.04	0.02	0.01	0.01	0.01	0.12	0.12	0.12	0.17	0.17	0.17
Crit Moves:	****											
Green Time:	15.1	15.1	15.1	15.1	15.1	15.1	58.9	58.9	58.9	58.9	58.9	58.9
Volume/Cap:	0.23	0.23	0.08	0.03	0.03	0.05	0.17	0.17	0.17	0.23	0.23	0.23
Delay/Veh:	27.9	27.9	26.8	26.5	26.5	26.6	3.2	3.2	3.2	3.4	3.4	3.4
User DelAdj:	1.00	1.00	1.00	1.00	1.00	1.00	1.00	1.00	1.00	1.00	1.00	1.00
AdjDel/Veh:	27.9	27.9	26.8	26.5	26.5	26.6	3.2	3.2	3.2	3.4	3.4	3.4
LOS by Move:	C	C	C	C	C	C	A	A	A	A	A	A
HCM2k95thQ:	4	4	1	0	0	1	4	4	4	5	5	5

Note: Queue reported is the number of cars per lane.

BART Phase II Extension Project

Level Of Service Computation Report
2000 HCM Operations (Future Volume Alternative)
PM - 2025 Project Conditions

Intersection #3789: SANTA CLARA/21ST

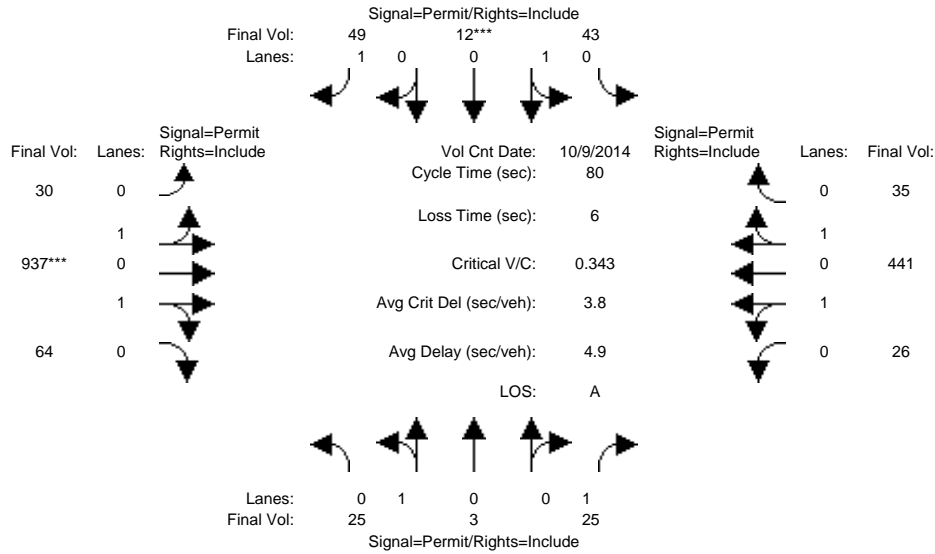

Approach:	North Bound			South Bound			East Bound			West Bound		
	L	T	R	L	T	R	L	T	R	L	T	R
Min. Green:	10	10	10	10	10	10	10	10	10	10	10	10
Y+R:	4.0	4.0	4.0	4.0	4.0	4.0	4.0	4.0	4.0	4.0	4.0	4.0

Volume Module:	>> Count Date: 9 Oct 2014 <<											
Base Vol:	25	3	25	43	12	49	30	937	64	26	441	35
Growth Adj:	1.00	1.00	1.00	1.00	1.00	1.00	1.00	1.00	1.00	1.00	1.00	1.00
Initial Bse:	25	3	25	43	12	49	30	937	64	26	441	35
Added Vol:	0	0	0	0	0	0	0	0	0	0	0	0
PasserByVol:	0	0	0	0	0	0	0	0	0	0	0	0
Initial Fut:	25	3	25	43	12	49	30	937	64	26	441	35
User Adj:	1.00	1.00	1.00	1.00	1.00	1.00	1.00	1.00	1.00	1.00	1.00	1.00
PHF Adj:	1.00	1.00	1.00	1.00	1.00	1.00	1.00	1.00	1.00	1.00	1.00	1.00
PHF Volume:	25	3	25	43	12	49	30	937	64	26	441	35
Reduct Vol:	0	0	0	0	0	0	0	0	0	0	0	0
Reduced Vol:	25	3	25	43	12	49	30	937	64	26	441	35
PCE Adj:	1.00	1.00	1.00	1.00	1.00	1.00	1.00	1.00	1.00	1.00	1.00	1.00
MLF Adj:	1.00	1.00	1.00	1.00	1.00	1.00	1.00	1.00	1.00	1.00	1.00	1.00
FinalVolume:	25	3	25	43	12	49	30	937	64	26	441	35

Saturation Flow Module:												
Sat/Lane:	1900	1900	1900	1900	1900	1900	1900	1900	1900	1900	1900	1900
Adjustment:	0.95	0.95	0.92	0.95	0.95	0.92	0.95	0.95	0.95	0.95	0.95	0.95
Lanes:	0.89	0.11	1.00	0.78	0.22	1.00	0.06	1.82	0.12	0.10	1.76	0.14
Final Sat.:	1607	193	1750	1407	393	1750	105	3272	223	186	3163	251

Capacity Analysis Module:												
Vol/Sat:	0.02	0.02	0.01	0.03	0.03	0.03	0.29	0.29	0.29	0.14	0.14	0.14
Crit Moves:				****	****	****	****	****	****	****	****	****
Green Time:	10.0	10.0	10.0	10.0	10.0	10.0	64.0	64.0	64.0	64.0	64.0	64.0
Volume/Cap:	0.12	0.12	0.11	0.24	0.24	0.22	0.36	0.36	0.36	0.17	0.17	0.17
Delay/Veh:	31.4	31.4	31.3	32.2	32.2	32.0	2.3	2.3	2.3	1.9	1.9	1.9
User DelAdj:	1.00	1.00	1.00	1.00	1.00	1.00	1.00	1.00	1.00	1.00	1.00	1.00
AdjDel/Veh:	31.4	31.4	31.3	32.2	32.2	32.0	2.3	2.3	2.3	1.9	1.9	1.9
LOS by Move:	C	C	C	C	C	C	A	A	A	A	A	A
HCM2k95thQ:	2	2	1	3	3	3	7	7	7	3	3	3

Note: Queue reported is the number of cars per lane.

BART Phase II Extension Project

Level Of Service Computation Report
2000 HCM Operations (Future Volume Alternative)
AM - 2025 Project Conditions

Intersection #3790: SANTA CLARA/24TH

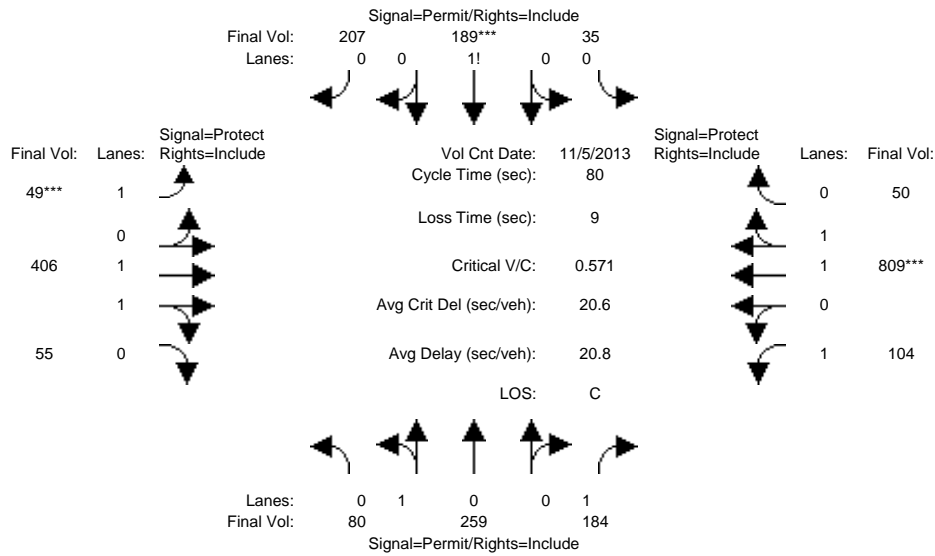

Approach:	North Bound			South Bound			East Bound			West Bound		
	L	T	R	L	T	R	L	T	R	L	T	R
Min. Green:	10	10	10	10	10	10	7	10	10	7	10	10
Y+R:	4.0	4.0	4.0	4.0	4.0	4.0	4.0	4.0	4.0	4.0	4.0	4.0

Volume Module:	>> Count Date: 5 Nov 2013 <<											
Base Vol:	80	259	184	35	189	207	49	406	55	104	809	50
Growth Adj:	1.00	1.00	1.00	1.00	1.00	1.00	1.00	1.00	1.00	1.00	1.00	1.00
Initial Bse:	80	259	184	35	189	207	49	406	55	104	809	50
Added Vol:	0	0	0	0	0	0	0	0	0	0	0	0
PasserByVol:	0	0	0	0	0	0	0	0	0	0	0	0
Initial Fut:	80	259	184	35	189	207	49	406	55	104	809	50
User Adj:	1.00	1.00	1.00	1.00	1.00	1.00	1.00	1.00	1.00	1.00	1.00	1.00
PHF Adj:	1.00	1.00	1.00	1.00	1.00	1.00	1.00	1.00	1.00	1.00	1.00	1.00
PHF Volume:	80	259	184	35	189	207	49	406	55	104	809	50
Reduct Vol:	0	0	0	0	0	0	0	0	0	0	0	0
Reduced Vol:	80	259	184	35	189	207	49	406	55	104	809	50
PCE Adj:	1.00	1.00	1.00	1.00	1.00	1.00	1.00	1.00	1.00	1.00	1.00	1.00
MLF Adj:	1.00	1.00	1.00	1.00	1.00	1.00	1.00	1.00	1.00	1.00	1.00	1.00
FinalVolume:	80	259	184	35	189	207	49	406	55	104	809	50

Saturation Flow Module:												
Sat/Lane:	1900	1900	1900	1900	1900	1900	1900	1900	1900	1900	1900	1900
Adjustment:	0.95	0.95	0.92	0.92	0.92	0.92	0.92	0.98	0.95	0.92	0.98	0.95
Lanes:	0.24	0.76	1.00	0.08	0.44	0.48	1.00	1.75	0.25	1.00	1.88	0.12
Final Sat.:	425	1375	1750	142	767	840	1750	3258	441	1750	3484	215

Capacity Analysis Module:												
Vol/Sat:	0.19	0.19	0.11	0.25	0.25	0.25	0.03	0.12	0.12	0.06	0.23	0.23
Crit Moves:				****	****	****	****	****	****	****	****	****
Green Time:	32.9	32.9	32.9	32.9	32.9	32.9	7.0	22.4	22.4	15.7	31.1	31.1
Volume/Cap:	0.46	0.46	0.26	0.60	0.60	0.60	0.32	0.45	0.45	0.30	0.60	0.60
Delay/Veh:	17.5	17.5	15.7	19.8	19.8	19.8	35.5	24.0	24.0	28.0	20.2	20.2
User DelAdj:	1.00	1.00	1.00	1.00	1.00	1.00	1.00	1.00	1.00	1.00	1.00	1.00
AdjDel/Veh:	17.5	17.5	15.7	19.8	19.8	19.8	35.5	24.0	24.0	28.0	20.2	20.2
LOS by Move:	B	B	B	B	B	B	D	C	C	C	C	C
HCM2k95thQ:	12	12	6	18	18	18	2	9	9	5	16	16

Note: Queue reported is the number of cars per lane.

BART Phase II Extension Project

Level Of Service Computation Report
2000 HCM Operations (Future Volume Alternative)
PM - 2025 Project Conditions

Intersection #3790: SANTA CLARA/24TH

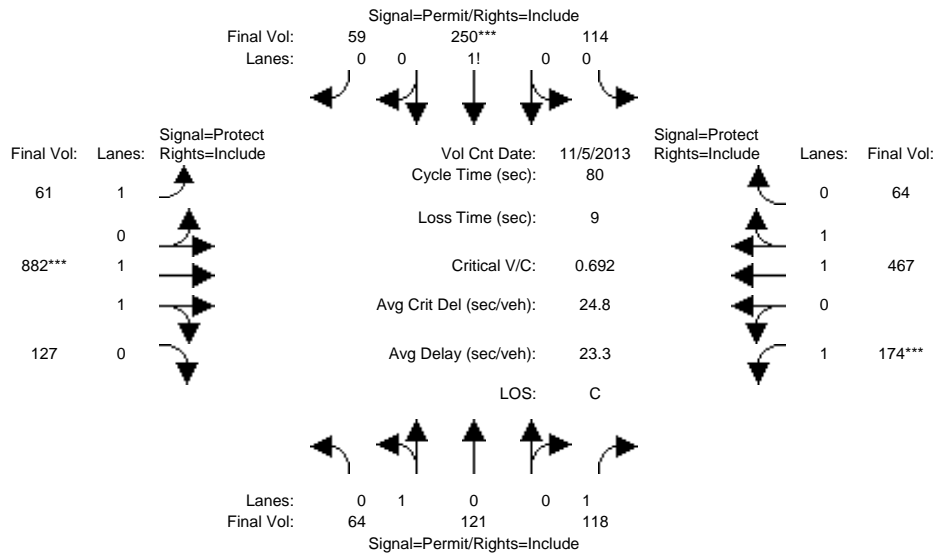

Approach:	North Bound			South Bound			East Bound			West Bound		
	L	T	R	L	T	R	L	T	R	L	T	R
Min. Green:	10	10	10	10	10	10	7	10	10	7	10	10
Y+R:	4.0	4.0	4.0	4.0	4.0	4.0	4.0	4.0	4.0	4.0	4.0	4.0

Volume Module: >> Count Date: 5 Nov 2013 <<

Base Vol:	64	121	118	114	250	59	61	882	127	174	467	64
Growth Adj:	1.00	1.00	1.00	1.00	1.00	1.00	1.00	1.00	1.00	1.00	1.00	1.00
Initial Bse:	64	121	118	114	250	59	61	882	127	174	467	64
Added Vol:	0	0	0	0	0	0	0	0	0	0	0	0
PasserByVol:	0	0	0	0	0	0	0	0	0	0	0	0
Initial Fut:	64	121	118	114	250	59	61	882	127	174	467	64
User Adj:	1.00	1.00	1.00	1.00	1.00	1.00	1.00	1.00	1.00	1.00	1.00	1.00
PHF Adj:	1.00	1.00	1.00	1.00	1.00	1.00	1.00	1.00	1.00	1.00	1.00	1.00
PHF Volume:	64	121	118	114	250	59	61	882	127	174	467	64
Reduct Vol:	0	0	0	0	0	0	0	0	0	0	0	0
Reduced Vol:	64	121	118	114	250	59	61	882	127	174	467	64
PCE Adj:	1.00	1.00	1.00	1.00	1.00	1.00	1.00	1.00	1.00	1.00	1.00	1.00
MLF Adj:	1.00	1.00	1.00	1.00	1.00	1.00	1.00	1.00	1.00	1.00	1.00	1.00
FinalVolume:	64	121	118	114	250	59	61	882	127	174	467	64

Saturation Flow Module:

Sat/Lane:	1900	1900	1900	1900	1900	1900	1900	1900	1900	1900	1900	1900
Adjustment:	0.95	0.95	0.92	0.92	0.92	0.92	0.92	0.98	0.95	0.92	0.98	0.95
Lanes:	0.35	0.65	1.00	0.27	0.59	0.14	1.00	1.74	0.26	1.00	1.75	0.25
Final Sat.:	623	1177	1750	472	1034	244	1750	3234	466	1750	3254	446

Capacity Analysis Module:

Vol/Sat:	0.10	0.10	0.07	0.24	0.24	0.24	0.03	0.27	0.27	0.10	0.14	0.14
Crit Moves:				****	****	****		****	****	****	****	****
Green Time:	28.0	28.0	28.0	28.0	28.0	28.0	16.3	31.5	31.5	11.5	26.7	26.7
Volume/Cap:	0.29	0.29	0.19	0.69	0.69	0.69	0.17	0.69	0.69	0.69	0.43	0.43
Delay/Veh:	19.1	19.1	18.3	25.7	25.7	25.7	26.5	21.6	21.6	40.6	20.9	20.9
User DelAdj:	1.00	1.00	1.00	1.00	1.00	1.00	1.00	1.00	1.00	1.00	1.00	1.00
AdjDel/Veh:	19.1	19.1	18.3	25.7	25.7	25.7	26.5	21.6	21.6	40.6	20.9	20.9
LOS by Move:	B	B	B	C	C	C	C	C	C	D	C	C
HCM2k95thQ:	7	7	4	20	20	20	3	20	20	9	10	10

Note: Queue reported is the number of cars per lane.

BART Phase II Extension Project

Level Of Service Computation Report
2000 HCM Operations (Future Volume Alternative)
AM - 2025 Project Conditions

Intersection #3832: 24TH/WILLIAM

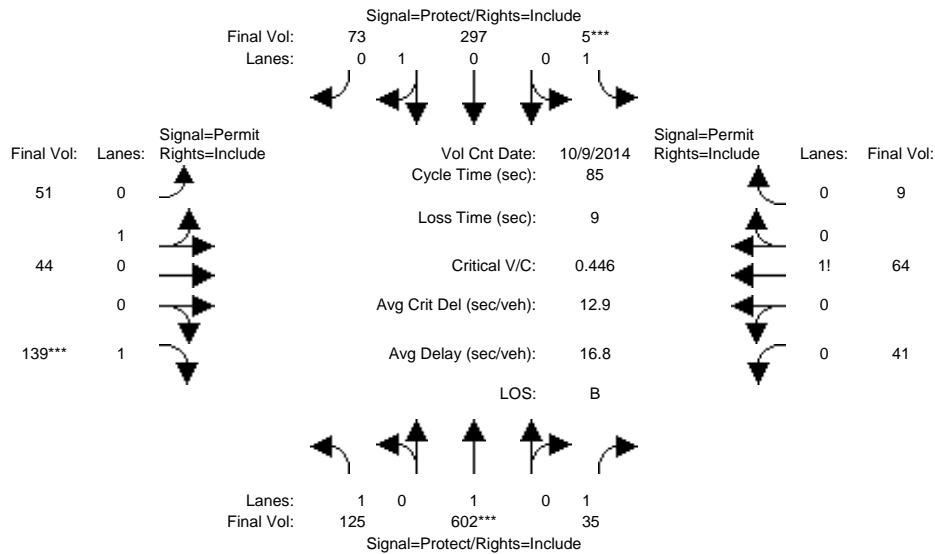

Approach:	North Bound			South Bound			East Bound			West Bound		
Movement:	L	T	R	L	T	R	L	T	R	L	T	R
Min. Green:	7	10	10	7	10	10	10	10	10	10	10	10
Y+R:	4.0	4.0	4.0	4.0	4.0	4.0	4.0	4.0	4.0	4.0	4.0	4.0
Volume Module: >> Count Date: 9 Oct 2014 <<												
Base Vol:	125	602	35	5	297	73	51	44	139	41	64	9
Growth Adj:	1.00	1.00	1.00	1.00	1.00	1.00	1.00	1.00	1.00	1.00	1.00	1.00
Initial Bse:	125	602	35	5	297	73	51	44	139	41	64	9
Added Vol:	0	0	0	0	0	0	0	0	0	0	0	0
PasserByVol:	0	0	0	0	0	0	0	0	0	0	0	0
Initial Fut:	125	602	35	5	297	73	51	44	139	41	64	9
User Adj:	1.00	1.00	1.00	1.00	1.00	1.00	1.00	1.00	1.00	1.00	1.00	1.00
PHF Adj:	1.00	1.00	1.00	1.00	1.00	1.00	1.00	1.00	1.00	1.00	1.00	1.00
PHF Volume:	125	602	35	5	297	73	51	44	139	41	64	9
Reduct Vol:	0	0	0	0	0	0	0	0	0	0	0	0
Reduced Vol:	125	602	35	5	297	73	51	44	139	41	64	9
PCE Adj:	1.00	1.00	1.00	1.00	1.00	1.00	1.00	1.00	1.00	1.00	1.00	1.00
MLF Adj:	1.00	1.00	1.00	1.00	1.00	1.00	1.00	1.00	1.00	1.00	1.00	1.00
Final Volume:	125	602	35	5	297	73	51	44	139	41	64	9
Saturation Flow Module:												
Sat/Lane:	1900	1900	1900	1900	1900	1900	1900	1900	1900	1900	1900	1900
Adjustment:	0.92	1.00	0.92	0.92	0.95	0.95	0.95	0.95	0.92	0.92	0.92	0.92
Lanes:	1.00	1.00	1.00	1.00	0.80	0.20	0.54	0.46	1.00	0.36	0.56	0.08
Final Sat.:	1750	1900	1750	1750	1445	355	966	834	1750	629	982	138
Capacity Analysis Module:												
Vol/Sat:	0.07	0.32	0.02	0.00	0.21	0.21	0.05	0.05	0.08	0.07	0.07	0.07
Crit Moves:	****			****			****			****		
Green Time:	17.8	55.2	55.2	7.0	44.4	44.4	13.8	13.8	13.8	13.8	13.8	13.8
Volume/Cap:	0.34	0.49	0.03	0.03	0.39	0.39	0.32	0.32	0.49	0.40	0.40	0.40
Delay/Veh:	29.2	8.0	5.4	36.0	12.5	12.5	32.1	32.1	33.7	32.8	32.8	32.8
User DelAdj:	1.00	1.00	1.00	1.00	1.00	1.00	1.00	1.00	1.00	1.00	1.00	1.00
AdjDel/Veh:	29.2	8.0	5.4	36.0	12.5	12.5	32.1	32.1	33.7	32.8	32.8	32.8
LOS by Move:	C	A	A	D	B	B	C	C	C	C	C	C
HCM2k95thQ:	6	15	1	0	12	12	5	5	8	7	7	7

Note: Queue reported is the number of cars per lane.

BART Phase II Extension Project

Level Of Service Computation Report
2000 HCM Operations (Future Volume Alternative)
PM - 2025 Project Conditions

Intersection #3832: 24TH/WILLIAM

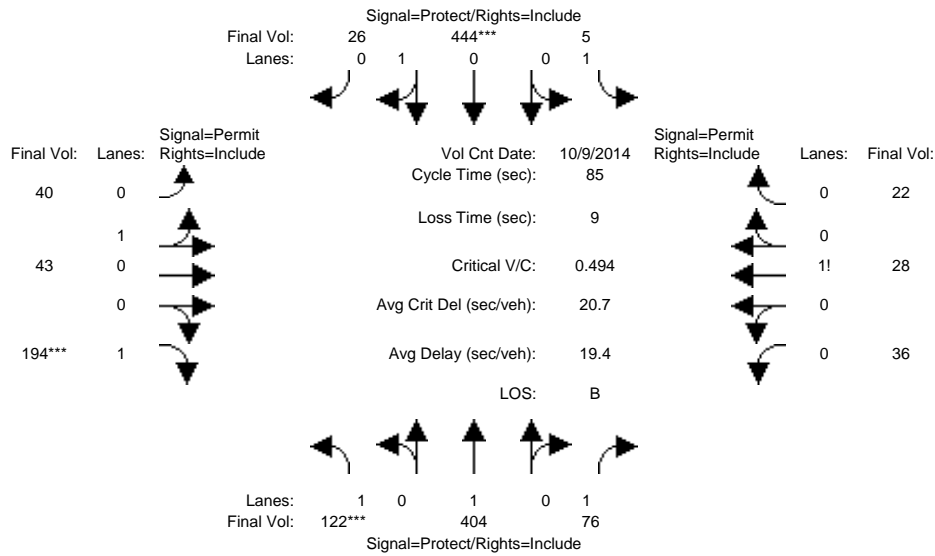

Approach:	North Bound			South Bound			East Bound			West Bound		
	L	T	R	L	T	R	L	T	R	L	T	R
Min. Green:	7	10	10	7	10	10	10	10	10	10	10	10
Y+R:	4.0	4.0	4.0	4.0	4.0	4.0	4.0	4.0	4.0	4.0	4.0	4.0
Volume Module: >> Count Date: 9 Oct 2014 <<												
Base Vol:	122	404	76	5	444	26	40	43	194	36	28	22
Growth Adj:	1.00	1.00	1.00	1.00	1.00	1.00	1.00	1.00	1.00	1.00	1.00	1.00
Initial Bse:	122	404	76	5	444	26	40	43	194	36	28	22
Added Vol:	0	0	0	0	0	0	0	0	0	0	0	0
PasserByVol:	0	0	0	0	0	0	0	0	0	0	0	0
Initial Fut:	122	404	76	5	444	26	40	43	194	36	28	22
User Adj:	1.00	1.00	1.00	1.00	1.00	1.00	1.00	1.00	1.00	1.00	1.00	1.00
PHF Adj:	1.00	1.00	1.00	1.00	1.00	1.00	1.00	1.00	1.00	1.00	1.00	1.00
PHF Volume:	122	404	76	5	444	26	40	43	194	36	28	22
Reduct Vol:	0	0	0	0	0	0	0	0	0	0	0	0
Reduced Vol:	122	404	76	5	444	26	40	43	194	36	28	22
PCE Adj:	1.00	1.00	1.00	1.00	1.00	1.00	1.00	1.00	1.00	1.00	1.00	1.00
MLF Adj:	1.00	1.00	1.00	1.00	1.00	1.00	1.00	1.00	1.00	1.00	1.00	1.00
FinalVolume:	122	404	76	5	444	26	40	43	194	36	28	22
Saturation Flow Module:												
Sat/Lane:	1900	1900	1900	1900	1900	1900	1900	1900	1900	1900	1900	1900
Adjustment:	0.92	1.00	0.92	0.92	0.95	0.95	0.95	0.95	0.92	0.92	0.92	0.92
Lanes:	1.00	1.00	1.00	1.00	0.94	0.06	0.48	0.52	1.00	0.42	0.32	0.26
Final Sat.:	1750	1900	1750	1750	1700	100	867	933	1750	733	570	448
Capacity Analysis Module:												
Vol/Sat:	0.07	0.21	0.04	0.00	0.26	0.26	0.05	0.05	0.11	0.05	0.05	0.05
Crit Moves:	****				****				****			
Green Time:	12.0	41.0	41.0	15.9	44.9	44.9	19.1	19.1	19.1	19.1	19.1	19.1
Volume/Cap:	0.49	0.44	0.09	0.02	0.49	0.49	0.21	0.21	0.49	0.22	0.22	0.22
Delay/Veh:	35.3	14.8	11.9	28.2	13.2	13.2	27.1	27.1	29.7	27.2	27.2	27.2
User DelAdj:	1.00	1.00	1.00	1.00	1.00	1.00	1.00	1.00	1.00	1.00	1.00	1.00
AdjDel/Veh:	35.3	14.8	11.9	28.2	13.2	13.2	27.1	27.1	29.7	27.2	27.2	27.2
LOS by Move:	D	B	B	C	B	B	C	C	C	C	C	C
HCM2k95thQ:	6	13	2	0	15	15	4	4	10	4	4	4

Note: Queue reported is the number of cars per lane.

BART Phase II Extension Project

Level Of Service Computation Report
2000 HCM Operations (Future Volume Alternative)
AM - 2025 Project Conditions

Intersection #4005: JULIAN/28TH

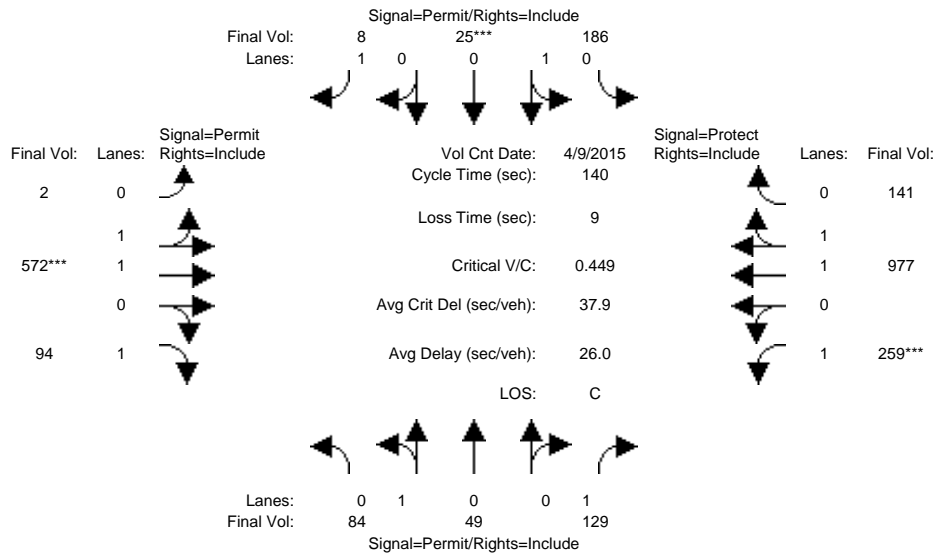

Approach:	North Bound			South Bound			East Bound			West Bound		
Movement:	L	T	R	L	T	R	L	T	R	L	T	R
Min. Green:	10	10	10	10	10	10	10	10	10	7	10	10
Y+R:	4.0	4.0	4.0	4.0	4.0	4.0	4.0	4.0	4.0	4.0	4.0	4.0
Volume Module: >> Count Date: 9 Apr 2015 <<												
Base Vol:	84	49	129	186	25	8	2	572	94	259	977	141
Growth Adj:	1.00	1.00	1.00	1.00	1.00	1.00	1.00	1.00	1.00	1.00	1.00	1.00
Initial Bse:	84	49	129	186	25	8	2	572	94	259	977	141
Added Vol:	0	0	0	0	0	0	0	0	0	0	0	0
PasserByVol:	0	0	0	0	0	0	0	0	0	0	0	0
Initial Fut:	84	49	129	186	25	8	2	572	94	259	977	141
User Adj:	1.00	1.00	1.00	1.00	1.00	1.00	1.00	1.00	1.00	1.00	1.00	1.00
PHF Adj:	1.00	1.00	1.00	1.00	1.00	1.00	1.00	1.00	1.00	1.00	1.00	1.00
PHF Volume:	84	49	129	186	25	8	2	572	94	259	977	141
Reduct Vol:	0	0	0	0	0	0	0	0	0	0	0	0
Reduced Vol:	84	49	129	186	25	8	2	572	94	259	977	141
PCE Adj:	1.00	1.00	1.00	1.00	1.00	1.00	1.00	1.00	1.00	1.00	1.00	1.00
MLF Adj:	1.00	1.00	1.00	1.00	1.00	1.00	1.00	1.00	1.00	1.00	1.00	1.00
Final Volume:	84	49	129	186	25	8	2	572	94	259	977	141
Saturation Flow Module:												
Sat/Lane:	1900	1900	1900	1900	1900	1900	1900	1900	1900	1900	1900	1900
Adjustment:	0.95	0.95	0.92	0.95	0.95	0.92	0.95	0.97	0.92	0.92	0.98	0.95
Lanes:	0.63	0.37	1.00	0.88	0.12	1.00	0.01	1.99	1.00	1.00	1.74	0.26
Final Sat.:	1137	663	1750	1587	213	1750	13	3687	1750	1750	3233	467
Capacity Analysis Module:												
Vol/Sat:	0.07	0.07	0.07	0.12	0.12	0.00	0.16	0.16	0.05	0.15	0.30	0.30
Crit Moves:				****			****			****		
Green Time:	36.5	36.5	36.5	36.5	36.5	36.5	48.3	48.3	48.3	46.1	94.5	94.5
Volume/Cap:	0.28	0.28	0.28	0.45	0.45	0.02	0.45	0.45	0.16	0.45	0.45	0.45
Delay/Veh:	41.6	41.6	41.6	44.0	44.0	38.4	35.8	35.8	31.8	37.5	10.7	10.7
User DelAdj:	1.00	1.00	1.00	1.00	1.00	1.00	1.00	1.00	1.00	1.00	1.00	1.00
AdjDel/Veh:	41.6	41.6	41.6	44.0	44.0	38.4	35.8	35.8	31.8	37.5	10.7	10.7
LOS by Move:	D	D	D	D	D	D	D	D	C	D	B	B
HCM2k95thQ:	9	9	9	15	15	1	18	18	6	17	20	20

Note: Queue reported is the number of cars per lane.

BART Phase II Extension Project

Level Of Service Computation Report
2000 HCM Operations (Future Volume Alternative)
PM - 2025 Project Conditions

Intersection #4005: JULIAN/28TH

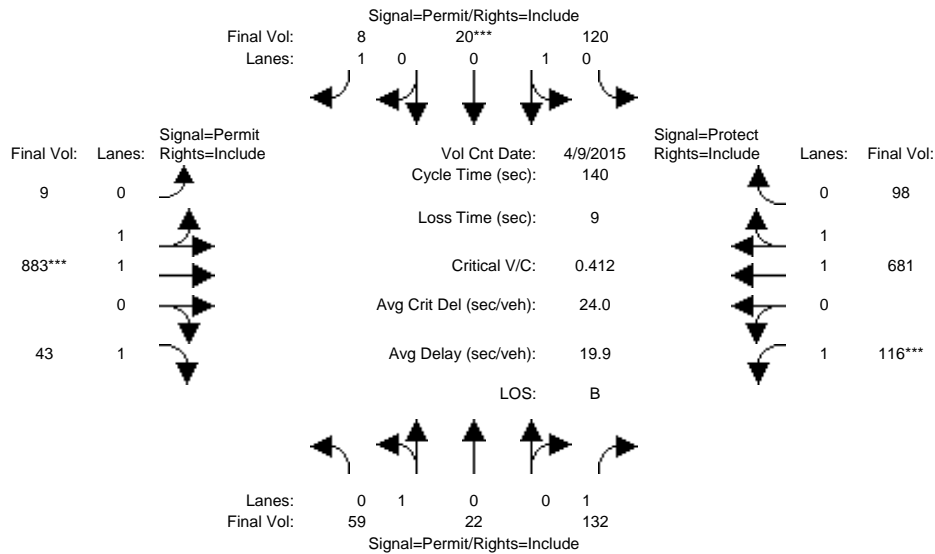

Approach:	North Bound			South Bound			East Bound			West Bound		
	L	T	R	L	T	R	L	T	R	L	T	R
Min. Green:	10	10	10	10	10	10	10	10	10	7	10	10
Y+R:	4.0	4.0	4.0	4.0	4.0	4.0	4.0	4.0	4.0	4.0	4.0	4.0

Volume Module:	>> Count Date: 9 Apr 2015 <<											
Base Vol:	59	22	132	120	20	8	9	883	43	116	681	98
Growth Adj:	1.00	1.00	1.00	1.00	1.00	1.00	1.00	1.00	1.00	1.00	1.00	1.00
Initial Bse:	59	22	132	120	20	8	9	883	43	116	681	98
Added Vol:	0	0	0	0	0	0	0	0	0	0	0	0
PasserByVol:	0	0	0	0	0	0	0	0	0	0	0	0
Initial Fut:	59	22	132	120	20	8	9	883	43	116	681	98
User Adj:	1.00	1.00	1.00	1.00	1.00	1.00	1.00	1.00	1.00	1.00	1.00	1.00
PHF Adj:	1.00	1.00	1.00	1.00	1.00	1.00	1.00	1.00	1.00	1.00	1.00	1.00
PHF Volume:	59	22	132	120	20	8	9	883	43	116	681	98
Reduct Vol:	0	0	0	0	0	0	0	0	0	0	0	0
Reduced Vol:	59	22	132	120	20	8	9	883	43	116	681	98
PCE Adj:	1.00	1.00	1.00	1.00	1.00	1.00	1.00	1.00	1.00	1.00	1.00	1.00
MLF Adj:	1.00	1.00	1.00	1.00	1.00	1.00	1.00	1.00	1.00	1.00	1.00	1.00
FinalVolume:	59	22	132	120	20	8	9	883	43	116	681	98

Saturation Flow Module:												
Sat/Lane:	1900	1900	1900	1900	1900	1900	1900	1900	1900	1900	1900	1900
Adjustment:	0.95	0.95	0.92	0.95	0.95	0.92	0.95	0.97	0.92	0.92	0.98	0.95
Lanes:	0.73	0.27	1.00	0.86	0.14	1.00	0.02	1.98	1.00	1.00	1.74	0.26
Final Sat.:	1311	489	1750	1543	257	1750	37	3663	1750	1750	3234	465

Capacity Analysis Module:												
Vol/Sat:	0.05	0.05	0.08	0.08	0.08	0.00	0.24	0.24	0.02	0.07	0.21	0.21
Crit Moves:					****			****			****	
Green Time:	26.5	26.5	26.5	26.5	26.5	26.5	82.0	82.0	82.0	22.5	105	104.5
Volume/Cap:	0.24	0.24	0.40	0.41	0.41	0.02	0.41	0.41	0.04	0.41	0.28	0.28
Delay/Veh:	48.6	48.6	50.6	50.7	50.7	46.3	16.0	16.0	12.3	53.7	5.7	5.7
User DelAdj:	1.00	1.00	1.00	1.00	1.00	1.00	1.00	1.00	1.00	1.00	1.00	1.00
AdjDel/Veh:	48.6	48.6	50.6	50.7	50.7	46.3	16.0	16.0	12.3	53.7	5.7	5.7
LOS by Move:	D	D	D	D	D	D	B	B	B	D	A	A
HCM2k95thQ:	6	6	10	11	11	1	19	19	2	9	11	11

Note: Queue reported is the number of cars per lane.

BART Phase II Extension Project

Level Of Service Computation Report
2000 HCM Operations (Future Volume Alternative)
AM - 2025 Project Conditions

Intersection #4022: SANTA CLARA/26TH

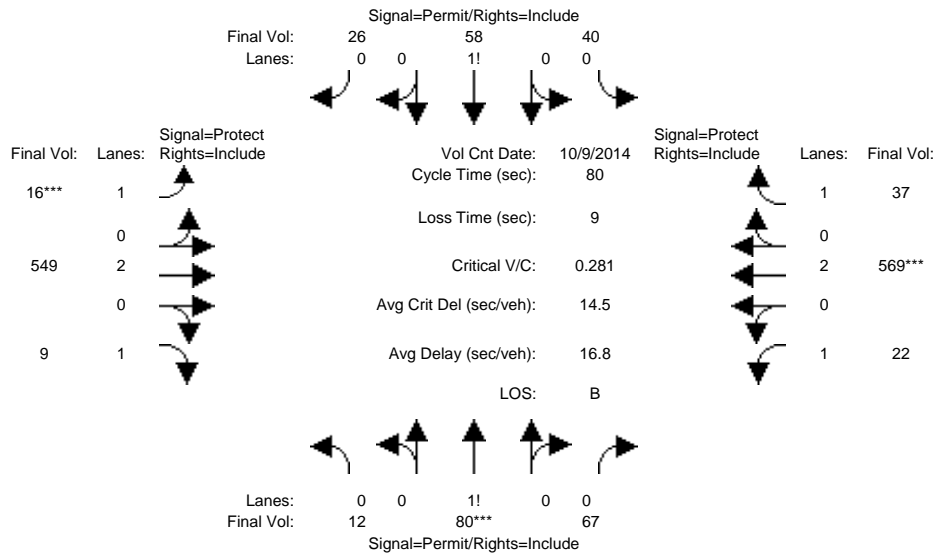

Approach:	North Bound			South Bound			East Bound			West Bound		
	L	T	R	L	T	R	L	T	R	L	T	R
Min. Green:	10	10	10	10	10	10	7	10	10	7	10	10
Y+R:	4.0	4.0	4.0	4.0	4.0	4.0	4.0	4.0	4.0	4.0	4.0	4.0
Volume Module: >> Count Date: 9 Oct 2014 <<												
Base Vol:	12	80	67	40	58	26	16	549	9	22	569	37
Growth Adj:	1.00	1.00	1.00	1.00	1.00	1.00	1.00	1.00	1.00	1.00	1.00	1.00
Initial Bse:	12	80	67	40	58	26	16	549	9	22	569	37
Added Vol:	0	0	0	0	0	0	0	0	0	0	0	0
PasserByVol:	0	0	0	0	0	0	0	0	0	0	0	0
Initial Fut:	12	80	67	40	58	26	16	549	9	22	569	37
User Adj:	1.00	1.00	1.00	1.00	1.00	1.00	1.00	1.00	1.00	1.00	1.00	1.00
PHF Adj:	1.00	1.00	1.00	1.00	1.00	1.00	1.00	1.00	1.00	1.00	1.00	1.00
PHF Volume:	12	80	67	40	58	26	16	549	9	22	569	37
Reduct Vol:	0	0	0	0	0	0	0	0	0	0	0	0
Reduced Vol:	12	80	67	40	58	26	16	549	9	22	569	37
PCE Adj:	1.00	1.00	1.00	1.00	1.00	1.00	1.00	1.00	1.00	1.00	1.00	1.00
MLF Adj:	1.00	1.00	1.00	1.00	1.00	1.00	1.00	1.00	1.00	1.00	1.00	1.00
FinalVolume:	12	80	67	40	58	26	16	549	9	22	569	37
Saturation Flow Module:												
Sat/Lane:	1900	1900	1900	1900	1900	1900	1900	1900	1900	1900	1900	1900
Adjustment:	0.92	0.92	0.92	0.92	0.92	0.92	0.92	1.00	0.92	0.92	1.00	0.92
Lanes:	0.08	0.50	0.42	0.32	0.47	0.21	1.00	2.00	1.00	1.00	2.00	1.00
Final Sat.:	132	881	737	565	819	367	1750	3800	1750	1750	3800	1750
Capacity Analysis Module:												
Vol/Sat:	0.09	0.09	0.09	0.07	0.07	0.07	0.01	0.14	0.01	0.01	0.15	0.02
Crit Moves:	****						****			****		
Green Time:	24.2	24.2	24.2	24.2	24.2	24.2	7.0	29.2	29.2	17.7	39.8	39.8
Volume/Cap:	0.30	0.30	0.30	0.23	0.23	0.23	0.10	0.40	0.01	0.06	0.30	0.04
Delay/Veh:	21.8	21.8	21.8	21.2	21.2	21.2	33.9	19.1	16.2	24.7	12.0	10.3
User DelAdj:	1.00	1.00	1.00	1.00	1.00	1.00	1.00	1.00	1.00	1.00	1.00	1.00
AdjDel/Veh:	21.8	21.8	21.8	21.2	21.2	21.2	33.9	19.1	16.2	24.7	12.0	10.3
LOS by Move:	C	C	C	C	C	C	C	B	B	C	B	B
HCM2k95thQ:	7	7	7	5	5	5	1	10	0	1	8	1

Note: Queue reported is the number of cars per lane.

BART Phase II Extension Project

Level Of Service Computation Report
2000 HCM Operations (Future Volume Alternative)
PM - 2025 Project Conditions

Intersection #4022: SANTA CLARA/26TH

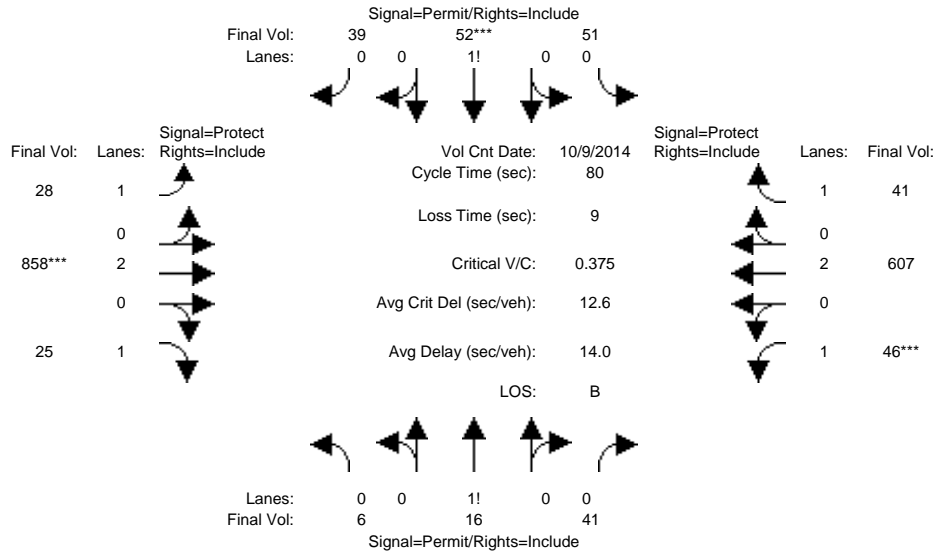

Approach:	North Bound			South Bound			East Bound			West Bound		
	L	T	R	L	T	R	L	T	R	L	T	R
Min. Green:	10	10	10	10	10	10	7	10	10	7	10	10
Y+R:	4.0	4.0	4.0	4.0	4.0	4.0	4.0	4.0	4.0	4.0	4.0	4.0
Volume Module: >> Count Date: 9 Oct 2014 <<												
Base Vol:	6	16	41	51	52	39	28	858	25	46	607	41
Growth Adj:	1.00	1.00	1.00	1.00	1.00	1.00	1.00	1.00	1.00	1.00	1.00	1.00
Initial Bse:	6	16	41	51	52	39	28	858	25	46	607	41
Added Vol:	0	0	0	0	0	0	0	0	0	0	0	0
PasserByVol:	0	0	0	0	0	0	0	0	0	0	0	0
Initial Fut:	6	16	41	51	52	39	28	858	25	46	607	41
User Adj:	1.00	1.00	1.00	1.00	1.00	1.00	1.00	1.00	1.00	1.00	1.00	1.00
PHF Adj:	1.00	1.00	1.00	1.00	1.00	1.00	1.00	1.00	1.00	1.00	1.00	1.00
PHF Volume:	6	16	41	51	52	39	28	858	25	46	607	41
Reduct Vol:	0	0	0	0	0	0	0	0	0	0	0	0
Reduced Vol:	6	16	41	51	52	39	28	858	25	46	607	41
PCE Adj:	1.00	1.00	1.00	1.00	1.00	1.00	1.00	1.00	1.00	1.00	1.00	1.00
MLF Adj:	1.00	1.00	1.00	1.00	1.00	1.00	1.00	1.00	1.00	1.00	1.00	1.00
FinalVolume:	6	16	41	51	52	39	28	858	25	46	607	41
Saturation Flow Module:												
Sat/Lane:	1900	1900	1900	1900	1900	1900	1900	1900	1900	1900	1900	1900
Adjustment:	0.92	0.92	0.92	0.92	0.92	0.92	0.92	1.00	0.92	0.92	1.00	0.92
Lanes:	0.10	0.25	0.65	0.36	0.37	0.27	1.00	2.00	1.00	1.00	2.00	1.00
Final Sat.:	167	444	1139	629	641	481	1750	3800	1750	1750	3800	1750
Capacity Analysis Module:												
Vol/Sat:	0.04	0.04	0.04	0.08	0.08	0.08	0.02	0.23	0.01	0.03	0.16	0.02
Crit Moves:				****			****			****		
Green Time:	16.9	16.9	16.9	16.9	16.9	16.9	19.1	47.1	47.1	7.0	34.9	34.9
Volume/Cap:	0.17	0.17	0.17	0.38	0.38	0.38	0.07	0.38	0.02	0.30	0.37	0.05
Delay/Veh:	26.0	26.0	26.0	27.7	27.7	27.7	23.6	8.9	6.9	35.3	15.2	13.0
User DelAdj:	1.00	1.00	1.00	1.00	1.00	1.00	1.00	1.00	1.00	1.00	1.00	1.00
AdjDel/Veh:	26.0	26.0	26.0	27.7	27.7	27.7	23.6	8.9	6.9	35.3	15.2	13.0
LOS by Move:	C	C	C	C	C	C	C	A	A	D	B	B
HCM2k95thQ:	3	3	3	7	7	7	1	11	1	2	9	1

Note: Queue reported is the number of cars per lane.

BART Phase II Extension Project

Level Of Service Computation Report
 2000 HCM Operations (Future Volume Alternative)
 AM - 2035 No Project Conditions

Intersection #3016: 101/ALUM ROCK

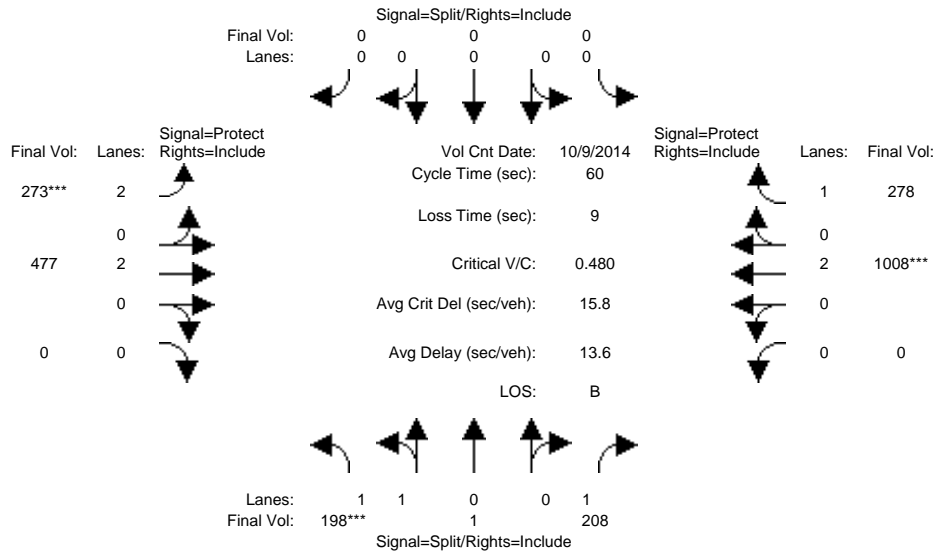

Approach:	North Bound			South Bound			East Bound			West Bound		
	L	T	R	L	T	R	L	T	R	L	T	R
Min. Green:	10	10	10	0	0	0	7	10	0	0	10	10
Y+R:	4.0	4.0	4.0	4.0	4.0	4.0	4.0	4.0	4.0	4.0	4.0	4.0

Volume Module:	>>	Count	Date:	9 Oct 2014	<<												
Base Vol:	198	1	208	0	0	0	273	477	0	0	1008	278					
Growth Adj:	1.00	1.00	1.00	1.00	1.00	1.00	1.00	1.00	1.00	1.00	1.00	1.00					
Initial Bse:	198	1	208	0	0	0	273	477	0	0	1008	278					
Added Vol:	0	0	0	0	0	0	0	0	0	0	0	0					
PasserByVol:	0	0	0	0	0	0	0	0	0	0	0	0					
Initial Fut:	198	1	208	0	0	0	273	477	0	0	1008	278					
User Adj:	1.00	1.00	1.00	1.00	1.00	1.00	1.00	1.00	1.00	1.00	1.00	1.00					
PHF Adj:	1.00	1.00	1.00	1.00	1.00	1.00	1.00	1.00	1.00	1.00	1.00	1.00					
PHF Volume:	198	1	208	0	0	0	273	477	0	0	1008	278					
Reduct Vol:	0	0	0	0	0	0	0	0	0	0	0	0					
Reduced Vol:	198	1	208	0	0	0	273	477	0	0	1008	278					
PCE Adj:	1.00	1.00	1.00	1.00	1.00	1.00	1.00	1.00	1.00	1.00	1.00	1.00					
MLF Adj:	1.00	1.00	1.00	1.00	1.00	1.00	1.00	1.00	1.00	1.00	1.00	1.00					
Final Volume:	198	1	208	0	0	0	273	477	0	0	1008	278					

Saturation Flow Module:												
Sat/Lane:	1900	1900	1900	1900	1900	1900	1900	1900	1900	1900	1900	1900
Adjustment:	0.93	0.95	0.92	0.92	1.00	0.92	0.83	1.00	0.92	0.92	1.00	0.92
Lanes:	1.99	0.01	1.00	0.00	0.00	0.00	2.00	2.00	0.00	0.00	2.00	1.00
Final Sat.:	3532	18	1750	0	0	0	3150	3800	0	0	3800	1750

Capacity Analysis Module:												
Vol/Sat:	0.06	0.06	0.12	0.00	0.00	0.00	0.09	0.13	0.00	0.00	0.27	0.16
Crit Moves:	****						****			****		
Green Time:	14.9	14.9	14.9	0.0	0.0	0.0	8.9	36.1	0.0	0.0	27.2	27.2
Volume/Cap:	0.23	0.23	0.48	0.00	0.00	0.00	0.58	0.21	0.00	0.00	0.58	0.35
Delay/Veh:	18.1	18.1	20.1	0.0	0.0	0.0	25.7	5.5	0.0	0.0	12.7	10.9
User DelAdj:	1.00	1.00	1.00	1.00	1.00	1.00	1.00	1.00	1.00	1.00	1.00	1.00
AdjDel/Veh:	18.1	18.1	20.1	0.0	0.0	0.0	25.7	5.5	0.0	0.0	12.7	10.9
LOS by Move:	B	B	C	A	A	A	C	A	A	A	B	B
HCM2k95thQ:	3	3	8	0	0	0	6	4	0	0	13	7

Note: Queue reported is the number of cars per lane.

BART Phase II Extension Project

Level Of Service Computation Report
 2000 HCM Operations (Future Volume Alternative)
 PM - 2035 No Project Conditions

Intersection #3016: 101/ALUM ROCK

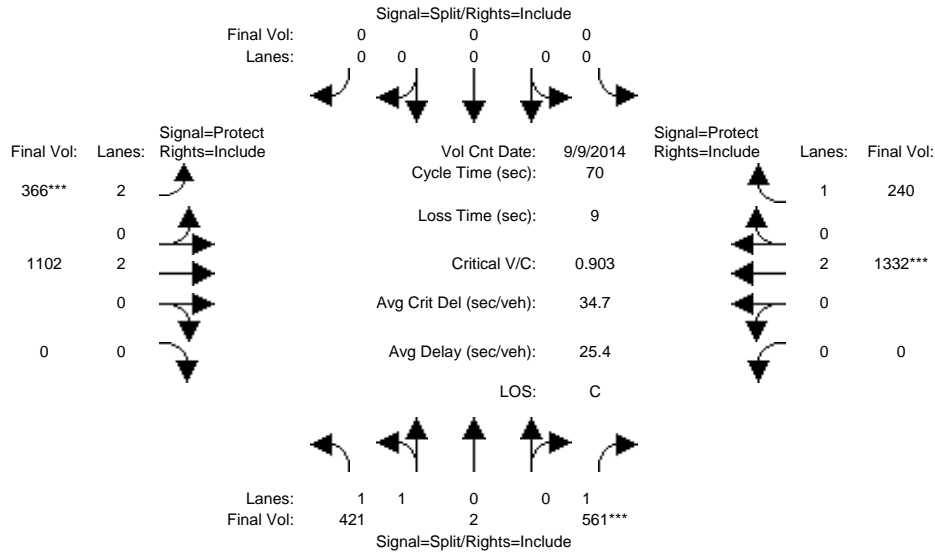

Approach:	North Bound			South Bound			East Bound			West Bound		
	L	T	R	L	T	R	L	T	R	L	T	R
Min. Green:	10	10	10	0	0	0	7	10	0	0	10	10
Y+R:	4.0	4.0	4.0	4.0	4.0	4.0	4.0	4.0	4.0	4.0	4.0	4.0

Volume Module:	>> Count Date: 9 Sep 2014 <<											
Base Vol:	421	2	561	0	0	0	366	1102	0	0	1332	240
Growth Adj:	1.00	1.00	1.00	1.00	1.00	1.00	1.00	1.00	1.00	1.00	1.00	1.00
Initial Bse:	421	2	561	0	0	0	366	1102	0	0	1332	240
Added Vol:	0	0	0	0	0	0	0	0	0	0	0	0
PasserByVol:	0	0	0	0	0	0	0	0	0	0	0	0
Initial Fut:	421	2	561	0	0	0	366	1102	0	0	1332	240
User Adj:	1.00	1.00	1.00	1.00	1.00	1.00	1.00	1.00	1.00	1.00	1.00	1.00
PHF Adj:	1.00	1.00	1.00	1.00	1.00	1.00	1.00	1.00	1.00	1.00	1.00	1.00
PHF Volume:	421	2	561	0	0	0	366	1102	0	0	1332	240
Reduct Vol:	0	0	0	0	0	0	0	0	0	0	0	0
Reduced Vol:	421	2	561	0	0	0	366	1102	0	0	1332	240
PCE Adj:	1.00	1.00	1.00	1.00	1.00	1.00	1.00	1.00	1.00	1.00	1.00	1.00
MLF Adj:	1.00	1.00	1.00	1.00	1.00	1.00	1.00	1.00	1.00	1.00	1.00	1.00
FinalVolume:	421	2	561	0	0	0	366	1102	0	0	1332	240

Saturation Flow Module:												
Sat/Lane:	1900	1900	1900	1900	1900	1900	1900	1900	1900	1900	1900	1900
Adjustment:	0.93	0.95	0.92	0.92	1.00	0.92	0.83	1.00	0.92	0.92	1.00	0.92
Lanes:	1.99	0.01	1.00	0.00	0.00	0.00	2.00	2.00	0.00	0.00	2.00	1.00
Final Sat.:	3533	17	1750	0	0	0	3150	3800	0	0	3800	1750

Capacity Analysis Module:												
Vol/Sat:	0.12	0.12	0.32	0.00	0.00	0.00	0.12	0.29	0.00	0.00	0.35	0.14
Crit Moves:			****				****				****	
Green Time:	24.8	24.8	24.8	0.0	0.0	0.0	9.0	36.2	0.0	0.0	27.2	27.2
Volume/Cap:	0.34	0.34	0.90	0.00	0.00	0.00	0.90	0.56	0.00	0.00	0.90	0.35
Delay/Veh:	16.7	16.7	38.0	0.0	0.0	0.0	53.1	11.9	0.0	0.0	28.3	15.5
User DelAdj:	1.00	1.00	1.00	1.00	1.00	1.00	1.00	1.00	1.00	1.00	1.00	1.00
AdjDel/Veh:	16.7	16.7	38.0	0.0	0.0	0.0	53.1	11.9	0.0	0.0	28.3	15.5
LOS by Move:	B	B	D	A	A	A	D	B	A	A	C	B
HCM2k95thQ:	7	7	29	0	0	0	10	15	0	0	27	8

Note: Queue reported is the number of cars per lane.

BART Phase II Extension Project

Level Of Service Computation Report
 2000 HCM Operations (Future Volume Alternative)
 AM - 2035 No Project Conditions

Intersection #3023: 101/SANTA CLARA

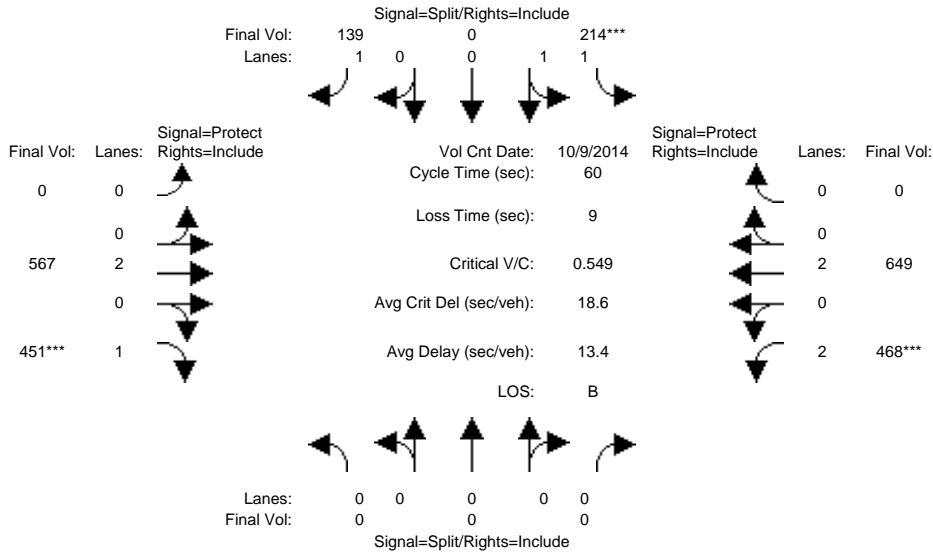

Approach:	North Bound			South Bound			East Bound			West Bound			
	L	T	R	L	T	R	L	T	R	L	T	R	
Min. Green:	0	0	0	10	10	10	0	10	10	7	10	0	
Y+R:	4.0	4.0	4.0	4.0	4.0	4.0	4.0	4.0	4.0	4.0	4.0	4.0	
Volume Module: >> Count Date: 9 Oct 2014 <<													
Base Vol:	0	0	0	214	0	139	0	567	451	468	649	0	
Growth Adj:	1.00	1.00	1.00	1.00	1.00	1.00	1.00	1.00	1.00	1.00	1.00	1.00	
Initial Bse:	0	0	0	214	0	139	0	567	451	468	649	0	
Added Vol:	0	0	0	0	0	0	0	0	0	0	0	0	
PasserByVol:	0	0	0	0	0	0	0	0	0	0	0	0	
Initial Fut:	0	0	0	214	0	139	0	567	451	468	649	0	
User Adj:	1.00	1.00	1.00	1.00	1.00	1.00	1.00	1.00	1.00	1.00	1.00	1.00	
PHF Adj:	1.00	1.00	1.00	1.00	1.00	1.00	1.00	1.00	1.00	1.00	1.00	1.00	
PHF Volume:	0	0	0	214	0	139	0	567	451	468	649	0	
Reduct Vol:	0	0	0	0	0	0	0	0	0	0	0	0	
Reduced Vol:	0	0	0	214	0	139	0	567	451	468	649	0	
PCE Adj:	1.00	1.00	1.00	1.00	1.00	1.00	1.00	1.00	1.00	1.00	1.00	1.00	
MLF Adj:	1.00	1.00	1.00	1.00	1.00	1.00	1.00	1.00	1.00	1.00	1.00	1.00	
FinalVolume:	0	0	0	214	0	139	0	567	451	468	649	0	
Saturation Flow Module:													
Sat/Lane:	1900	1900	1900	1900	1900	1900	1900	1900	1900	1900	1900	1900	
Adjustment:	0.92	1.00	0.92	0.93	1.00	0.92	0.92	1.00	0.92	0.83	1.00	0.92	
Lanes:	0.00	0.00	0.00	2.00	0.00	1.00	0.00	2.00	1.00	2.00	2.00	0.00	
Final Sat.:	0	0	0	3550	0	1750	0	3800	1750	3150	3800	0	
Capacity Analysis Module:													
Vol/Sat:	0.00	0.00	0.00	0.06	0.00	0.08	0.00	0.15	0.26	0.15	0.17	0.00	
Crit Moves:				****							****		
Green Time:	0.0	0.0	0.0	10.0	0.0	10.0	0.0	26.0	26.0	15.0	41.0	0.0	
Volume/Cap:	0.00	0.00	0.00	0.36	0.00	0.48	0.00	0.34	0.59	0.59	0.25	0.00	
Delay/Veh:	0.0	0.0	0.0	22.5	0.0	23.9	0.0	11.4	14.3	21.1	3.7	0.0	
User DelAdj:	1.00	1.00	1.00	1.00	1.00	1.00	1.00	1.00	1.00	1.00	1.00	1.00	
AdjDel/Veh:	0.0	0.0	0.0	22.5	0.0	23.9	0.0	11.4	14.3	21.1	3.7	0.0	
LOS by Move:	A	A	A	C	A	C	A	B	B	C	A	A	
HCM2k95thQ:	0	0	0	5	0	6	0	7	13	9	5	0	

Note: Queue reported is the number of cars per lane.

BART Phase II Extension Project

Level Of Service Computation Report
 2000 HCM Operations (Future Volume Alternative)
 PM - 2035 No Project Conditions

Intersection #3023: 101/SANTA CLARA

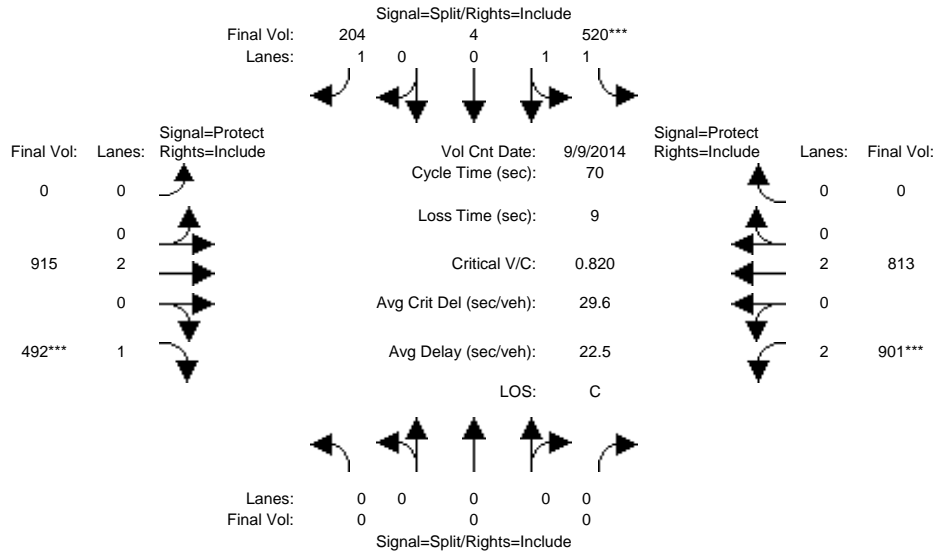

Approach:	North Bound			South Bound			East Bound			West Bound		
	L	T	R	L	T	R	L	T	R	L	T	R
Min. Green:	0	0	0	10	10	10	0	10	10	7	10	0
Y+R:	4.0	4.0	4.0	4.0	4.0	4.0	4.0	4.0	4.0	4.0	4.0	4.0
Volume Module: >> Count Date: 9 Sep 2014 <<												
Base Vol:	0	0	0	520	4	204	0	915	492	901	813	0
Growth Adj:	1.00	1.00	1.00	1.00	1.00	1.00	1.00	1.00	1.00	1.00	1.00	1.00
Initial Bse:	0	0	0	520	4	204	0	915	492	901	813	0
Added Vol:	0	0	0	0	0	0	0	0	0	0	0	0
PasserByVol:	0	0	0	0	0	0	0	0	0	0	0	0
Initial Fut:	0	0	0	520	4	204	0	915	492	901	813	0
User Adj:	1.00	1.00	1.00	1.00	1.00	1.00	1.00	1.00	1.00	1.00	1.00	1.00
PHF Adj:	1.00	1.00	1.00	1.00	1.00	1.00	1.00	1.00	1.00	1.00	1.00	1.00
PHF Volume:	0	0	0	520	4	204	0	915	492	901	813	0
Reduct Vol:	0	0	0	0	0	0	0	0	0	0	0	0
Reduced Vol:	0	0	0	520	4	204	0	915	492	901	813	0
PCE Adj:	1.00	1.00	1.00	1.00	1.00	1.00	1.00	1.00	1.00	1.00	1.00	1.00
MLF Adj:	1.00	1.00	1.00	1.00	1.00	1.00	1.00	1.00	1.00	1.00	1.00	1.00
FinalVolume:	0	0	0	520	4	204	0	915	492	901	813	0
Saturation Flow Module:												
Sat/Lane:	1900	1900	1900	1900	1900	1900	1900	1900	1900	1900	1900	1900
Adjustment:	0.92	1.00	0.92	0.93	0.95	0.92	0.92	1.00	0.92	0.83	1.00	0.92
Lanes:	0.00	0.00	0.00	1.98	0.02	1.00	0.00	2.00	1.00	2.00	2.00	0.00
Final Sat.:	0	0	0	3523	27	1750	0	3800	1750	3150	3800	0
Capacity Analysis Module:												
Vol/Sat:	0.00	0.00	0.00	0.15	0.15	0.12	0.00	0.24	0.28	0.29	0.21	0.00
Crit Moves:				****				****		****		
Green Time:	0.0	0.0	0.0	12.6	12.6	12.6	0.0	24.0	24.0	24.4	48.4	0.0
Volume/Cap:	0.00	0.00	0.00	0.82	0.82	0.65	0.00	0.70	0.82	0.82	0.31	0.00
Delay/Veh:	0.0	0.0	0.0	35.9	35.9	31.3	0.0	21.7	29.8	25.8	4.3	0.0
User DelAdj:	1.00	1.00	1.00	1.00	1.00	1.00	1.00	1.00	1.00	1.00	1.00	1.00
AdjDel/Veh:	0.0	0.0	0.0	35.9	35.9	31.3	0.0	21.7	29.8	25.8	4.3	0.0
LOS by Move:	A	A	A	D	D	C	A	C	C	C	A	A
HCM2k95thQ:	0	0	0	16	16	11	0	16	20	19	6	0

Note: Queue reported is the number of cars per lane.

BART Phase II Extension Project

Level Of Service Computation Report
 2000 HCM Operations (Future Volume Alternative)
 AM - 2035 No Project Conditions

Intersection #3036: 280/MCLAUGHLIN

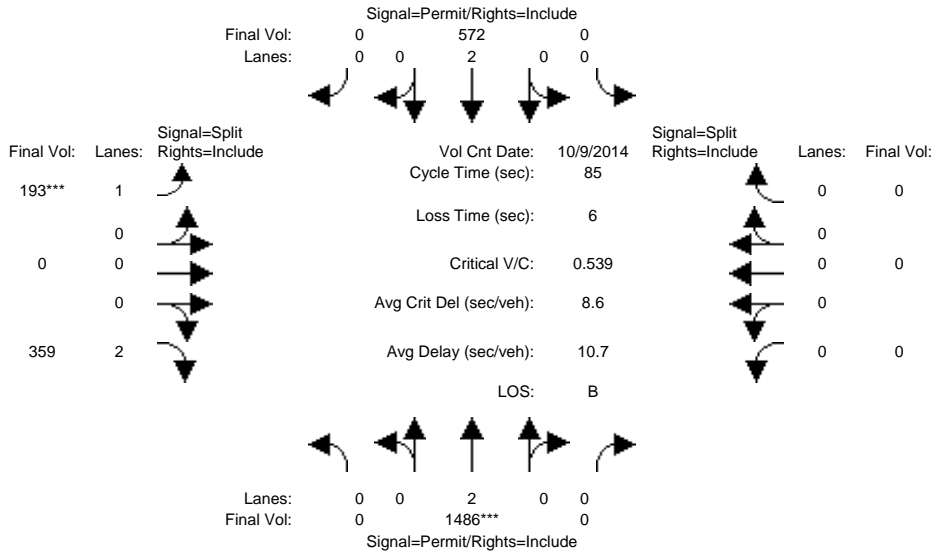

Approach:	North Bound			South Bound			East Bound			West Bound		
	L	T	R	L	T	R	L	T	R	L	T	R
Min. Green:	0	10	0	0	10	0	10	0	10	0	0	0
Y+R:	4.0	4.0	4.0	4.0	4.0	4.0	4.0	4.0	4.0	4.0	4.0	4.0
Volume Module: >> Count Date: 9 Oct 2014 <<												
Base Vol:	0	1486	0	0	572	0	193	0	359	0	0	0
Growth Adj:	1.00	1.00	1.00	1.00	1.00	1.00	1.00	1.00	1.00	1.00	1.00	1.00
Initial Bse:	0	1486	0	0	572	0	193	0	359	0	0	0
Added Vol:	0	0	0	0	0	0	0	0	0	0	0	0
PasserByVol:	0	0	0	0	0	0	0	0	0	0	0	0
Initial Fut:	0	1486	0	0	572	0	193	0	359	0	0	0
User Adj:	1.00	1.00	1.00	1.00	1.00	1.00	1.00	1.00	1.00	1.00	1.00	1.00
PHF Adj:	1.00	1.00	1.00	1.00	1.00	1.00	1.00	1.00	1.00	1.00	1.00	1.00
PHF Volume:	0	1486	0	0	572	0	193	0	359	0	0	0
Reduct Vol:	0	0	0	0	0	0	0	0	0	0	0	0
Reduced Vol:	0	1486	0	0	572	0	193	0	359	0	0	0
PCE Adj:	1.00	1.00	1.00	1.00	1.00	1.00	1.00	1.00	1.00	1.00	1.00	1.00
MLF Adj:	1.00	1.00	1.00	1.00	1.00	1.00	1.00	1.00	1.00	1.00	1.00	1.00
Final Volume:	0	1486	0	0	572	0	193	0	359	0	0	0
Saturation Flow Module:												
Sat/Lane:	1900	1900	1900	1900	1900	1900	1900	1900	1900	1900	1900	1900
Adjustment:	0.92	1.00	0.92	0.92	1.00	0.92	0.92	1.00	0.83	0.92	1.00	0.92
Lanes:	0.00	2.00	0.00	0.00	2.00	0.00	1.00	0.00	2.00	0.00	0.00	0.00
Final Sat.:	0	3800	0	0	3800	0	1750	0	3150	0	0	0
Capacity Analysis Module:												
Vol/Sat:	0.00	0.39	0.00	0.00	0.15	0.00	0.11	0.00	0.11	0.00	0.00	0.00
Crit Moves:	****			****			****			****		
Green Time:	0.0	61.2	0.0	0.0	61.2	0.0	17.8	0.0	17.8	0.0	0.0	0.0
Volume/Cap:	0.00	0.54	0.00	0.00	0.21	0.00	0.53	0.00	0.54	0.00	0.00	0.00
Delay/Veh:	0.0	5.7	0.0	0.0	4.0	0.0	31.2	0.0	30.9	0.0	0.0	0.0
User DelAdj:	1.00	1.00	1.00	1.00	1.00	1.00	1.00	1.00	1.00	1.00	1.00	1.00
AdjDel/Veh:	0.0	5.7	0.0	0.0	4.0	0.0	31.2	0.0	30.9	0.0	0.0	0.0
LOS by Move:	A	A	A	A	A	A	C	A	C	A	A	A
HCM2k95thQ:	0	17	0	0	5	0	11	0	11	0	0	0

Note: Queue reported is the number of cars per lane.

BART Phase II Extension Project

Level Of Service Computation Report
 2000 HCM Operations (Future Volume Alternative)
 PM - 2035 No Project Conditions

Intersection #3036: 280/MCLAUGHLIN

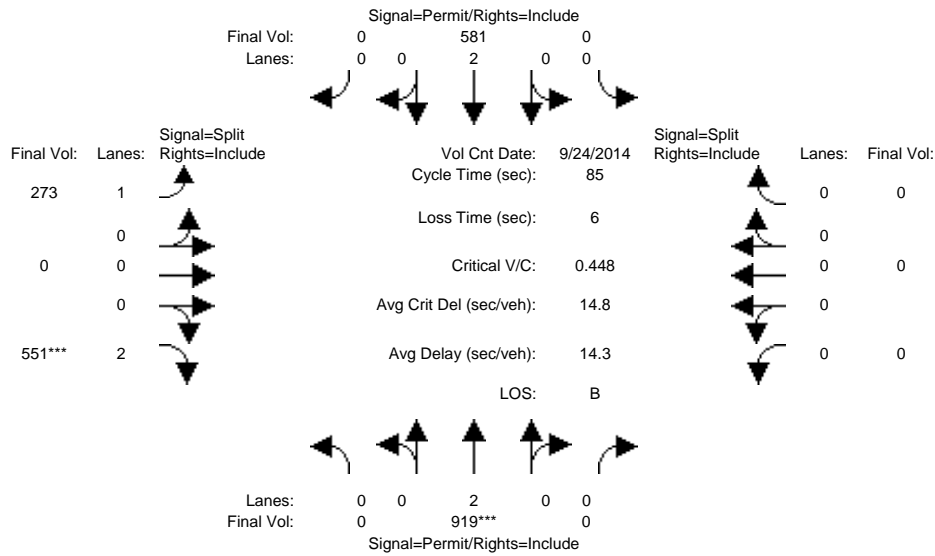

Approach:	North Bound			South Bound			East Bound			West Bound		
Movement:	L	T	R	L	T	R	L	T	R	L	T	R
Min. Green:	0	10	0	0	10	0	10	0	10	0	0	0
Y+R:	4.0	4.0	4.0	4.0	4.0	4.0	4.0	4.0	4.0	4.0	4.0	4.0
Volume Module: >> Count Date: 24 Sep 2014 <<												
Base Vol:	0	919	0	0	581	0	273	0	551	0	0	0
Growth Adj:	1.00	1.00	1.00	1.00	1.00	1.00	1.00	1.00	1.00	1.00	1.00	1.00
Initial Bse:	0	919	0	0	581	0	273	0	551	0	0	0
Added Vol:	0	0	0	0	0	0	0	0	0	0	0	0
PasserByVol:	0	0	0	0	0	0	0	0	0	0	0	0
Initial Fut:	0	919	0	0	581	0	273	0	551	0	0	0
User Adj:	1.00	1.00	1.00	1.00	1.00	1.00	1.00	1.00	1.00	1.00	1.00	1.00
PHF Adj:	1.00	1.00	1.00	1.00	1.00	1.00	1.00	1.00	1.00	1.00	1.00	1.00
PHF Volume:	0	919	0	0	581	0	273	0	551	0	0	0
Reduct Vol:	0	0	0	0	0	0	0	0	0	0	0	0
Reduced Vol:	0	919	0	0	581	0	273	0	551	0	0	0
PCE Adj:	1.00	1.00	1.00	1.00	1.00	1.00	1.00	1.00	1.00	1.00	1.00	1.00
MLF Adj:	1.00	1.00	1.00	1.00	1.00	1.00	1.00	1.00	1.00	1.00	1.00	1.00
FinalVolume:	0	919	0	0	581	0	273	0	551	0	0	0
Saturation Flow Module:												
Sat/Lane:	1900	1900	1900	1900	1900	1900	1900	1900	1900	1900	1900	1900
Adjustment:	0.92	1.00	0.92	0.92	1.00	0.92	0.92	1.00	0.83	0.92	1.00	0.92
Lanes:	0.00	2.00	0.00	0.00	2.00	0.00	1.00	0.00	2.00	0.00	0.00	0.00
Final Sat.:	0	3800	0	0	3800	0	1750	0	3150	0	0	0
Capacity Analysis Module:												
Vol/Sat:	0.00	0.24	0.00	0.00	0.15	0.00	0.16	0.00	0.17	0.00	0.00	0.00
Crit Moves:	****						****					
Green Time:	0.0	45.8	0.0	0.0	45.8	0.0	33.2	0.0	33.2	0.0	0.0	0.0
Volume/Cap:	0.00	0.45	0.00	0.00	0.28	0.00	0.40	0.00	0.45	0.00	0.00	0.00
Delay/Veh:	0.0	12.1	0.0	0.0	10.7	0.0	19.1	0.0	19.4	0.0	0.0	0.0
User DelAdj:	1.00	1.00	1.00	1.00	1.00	1.00	1.00	1.00	1.00	1.00	1.00	1.00
AdjDel/Veh:	0.0	12.1	0.0	0.0	10.7	0.0	19.1	0.0	19.4	0.0	0.0	0.0
LOS by Move:	A	B	A	A	B	A	B	A	B	A	A	A
HCM2k95thQ:	0	14	0	0	8	0	11	0	13	0	0	0

Note: Queue reported is the number of cars per lane.

BART Phase II Extension Project

Level Of Service Computation Report
 2000 HCM Operations (Future Volume Alternative)
 AM - 2035 No Project Conditions

Intersection #3210: 101/JULIAN

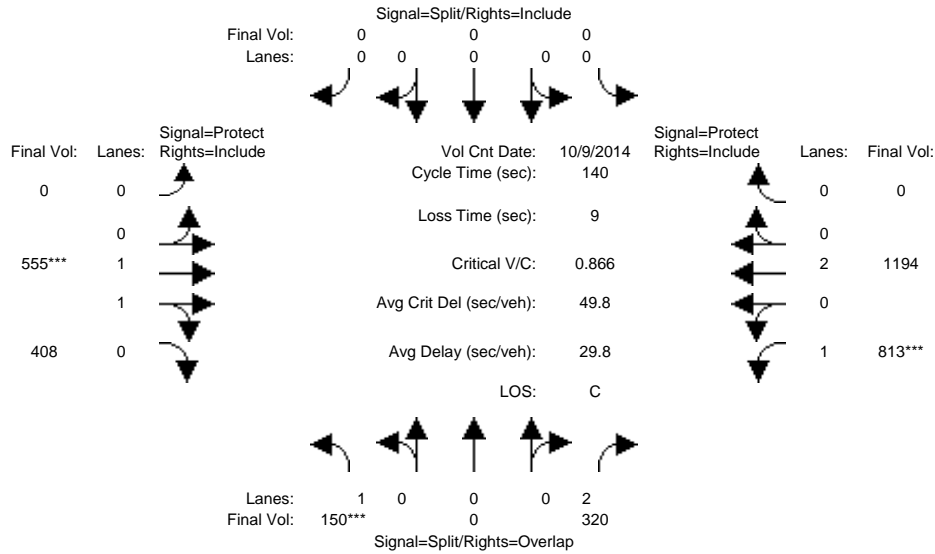

Approach:	North Bound			South Bound			East Bound			West Bound		
	L	T	R	L	T	R	L	T	R	L	T	R
Min. Green:	10	0	10	0	0	0	0	10	10	7	10	0
Y+R:	4.0	4.0	4.0	4.0	4.0	4.0	4.0	4.0	4.0	4.0	4.0	4.0
Volume Module: >> Count Date: 9 Oct 2014 <<												
Base Vol:	150	0	320	0	0	0	0	555	408	813	1194	0
Growth Adj:	1.00	1.00	1.00	1.00	1.00	1.00	1.00	1.00	1.00	1.00	1.00	1.00
Initial Bse:	150	0	320	0	0	0	0	555	408	813	1194	0
Added Vol:	0	0	0	0	0	0	0	0	0	0	0	0
PasserByVol:	0	0	0	0	0	0	0	0	0	0	0	0
Initial Fut:	150	0	320	0	0	0	0	555	408	813	1194	0
User Adj:	1.00	1.00	1.00	1.00	1.00	1.00	1.00	1.00	1.00	1.00	1.00	1.00
PHF Adj:	1.00	1.00	1.00	1.00	1.00	1.00	1.00	1.00	1.00	1.00	1.00	1.00
PHF Volume:	150	0	320	0	0	0	0	555	408	813	1194	0
Reduct Vol:	0	0	0	0	0	0	0	0	0	0	0	0
Reduced Vol:	150	0	320	0	0	0	0	555	408	813	1194	0
PCE Adj:	1.00	1.00	1.00	1.00	1.00	1.00	1.00	1.00	1.00	1.00	1.00	1.00
MLF Adj:	1.00	1.00	1.00	1.00	1.00	1.00	1.00	1.00	1.00	1.00	1.00	1.00
FinalVolume:	150	0	320	0	0	0	0	555	408	813	1194	0
Saturation Flow Module:												
Sat/Lane:	1900	1900	1900	1900	1900	1900	1900	1900	1900	1900	1900	1900
Adjustment:	0.92	1.00	0.83	0.92	1.00	0.92	0.92	0.99	0.95	0.92	1.00	0.92
Lanes:	1.00	0.00	2.00	0.00	0.00	0.00	0.00	1.13	0.87	1.00	2.00	0.00
Final Sat.:	1750	0	3150	0	0	0	0	2131	1567	1750	3800	0
Capacity Analysis Module:												
Vol/Sat:	0.09	0.00	0.10	0.00	0.00	0.00	0.00	0.26	0.26	0.46	0.31	0.00
Crit Moves:	****							****		****		
Green Time:	13.9	0.0	88.9	0.0	0.0	0.0	0.0	42.1	42.1	75.1	117	0.0
Volume/Cap:	0.87	0.00	0.16	0.00	0.00	0.00	0.00	0.87	0.87	0.87	0.38	0.00
Delay/Veh:	96.1	0.0	10.4	0.0	0.0	0.0	0.0	53.7	53.7	36.7	2.8	0.0
User DelAdj:	1.00	1.00	1.00	1.00	1.00	1.00	1.00	1.00	1.00	1.00	1.00	1.00
AdjDel/Veh:	96.1	0.0	10.4	0.0	0.0	0.0	0.0	53.7	53.7	36.7	2.8	0.0
LOS by Move:	F	A	B	A	A	A	A	D	D	D	A	A
HCM2k95thQ:	18	0	6	0	0	0	0	35	35	55	12	0

Note: Queue reported is the number of cars per lane.

BART Phase II Extension Project

Level Of Service Computation Report
2000 HCM Operations (Future Volume Alternative)
PM - 2035 No Project Conditions

Intersection #3210: 101/JULIAN

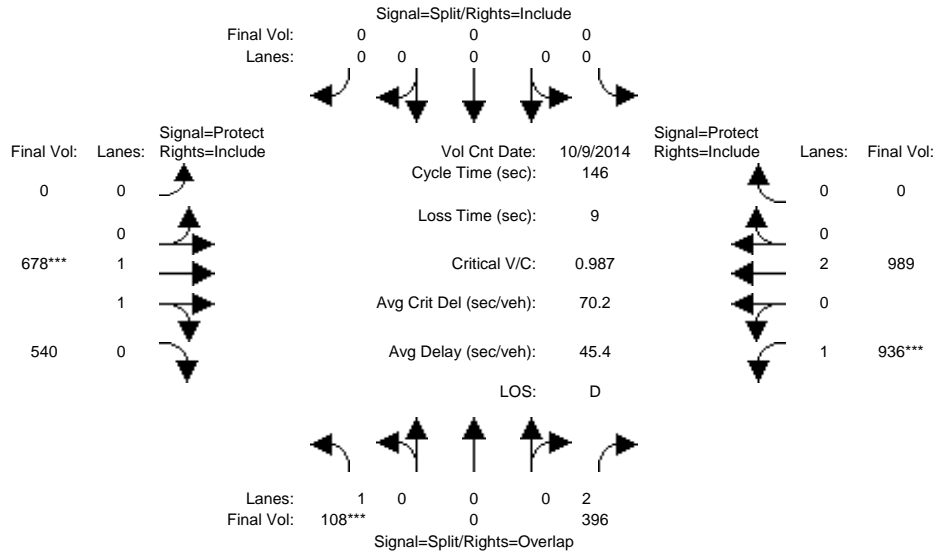

Approach:	North Bound			South Bound			East Bound			West Bound		
	L	T	R	L	T	R	L	T	R	L	T	R
Min. Green:	10	0	10	0	0	0	0	10	10	7	10	0
Y+R:	4.0	4.0	4.0	4.0	4.0	4.0	4.0	4.0	4.0	4.0	4.0	4.0
Volume Module: >> Count Date: 9 Oct 2014 <<												
Base Vol:	108	0	396	0	0	0	0	678	540	936	989	0
Growth Adj:	1.00	1.00	1.00	1.00	1.00	1.00	1.00	1.00	1.00	1.00	1.00	1.00
Initial Bse:	108	0	396	0	0	0	0	678	540	936	989	0
Added Vol:	0	0	0	0	0	0	0	0	0	0	0	0
PasserByVol:	0	0	0	0	0	0	0	0	0	0	0	0
Initial Fut:	108	0	396	0	0	0	0	678	540	936	989	0
User Adj:	1.00	1.00	1.00	1.00	1.00	1.00	1.00	1.00	1.00	1.00	1.00	1.00
PHF Adj:	1.00	1.00	1.00	1.00	1.00	1.00	1.00	1.00	1.00	1.00	1.00	1.00
PHF Volume:	108	0	396	0	0	0	0	678	540	936	989	0
Reduct Vol:	0	0	0	0	0	0	0	0	0	0	0	0
Reduced Vol:	108	0	396	0	0	0	0	678	540	936	989	0
PCE Adj:	1.00	1.00	1.00	1.00	1.00	1.00	1.00	1.00	1.00	1.00	1.00	1.00
MLF Adj:	1.00	1.00	1.00	1.00	1.00	1.00	1.00	1.00	1.00	1.00	1.00	1.00
FinalVolume:	108	0	396	0	0	0	0	678	540	936	989	0
Saturation Flow Module:												
Sat/Lane:	1900	1900	1900	1900	1900	1900	1900	1900	1900	1900	1900	1900
Adjustment:	0.92	1.00	0.83	0.92	1.00	0.92	0.92	0.99	0.95	0.92	1.00	0.92
Lanes:	1.00	0.00	2.00	0.00	0.00	0.00	0.00	1.09	0.91	1.00	2.00	0.00
Final Sat.:	1750	0	3150	0	0	0	0	2058	1639	1750	3800	0
Capacity Analysis Module:												
Vol/Sat:	0.06	0.00	0.13	0.00	0.00	0.00	0.00	0.33	0.33	0.53	0.26	0.00
Crit Moves:	****							****		****		
Green Time:	10.0	0.0	88.6	0.0	0.0	0.0	0.0	48.4	48.4	78.6	127	0.0
Volume/Cap:	0.90	0.00	0.21	0.00	0.00	0.00	0.00	0.99	0.99	0.99	0.30	0.00
Delay/Veh:	120.2	0.0	13.0	0.0	0.0	0.0	0.0	72.7	72.7	61.1	1.7	0.0
User DelAdj:	1.00	1.00	1.00	1.00	1.00	1.00	1.00	1.00	1.00	1.00	1.00	1.00
AdjDel/Veh:	120.2	0.0	13.0	0.0	0.0	0.0	0.0	72.7	72.7	61.1	1.7	0.0
LOS by Move:	F	A	B	A	A	A	A	E	E	E	A	A
HCM2k95thQ:	15	0	9	0	0	0	0	51	51	79	8	0

Note: Queue reported is the number of cars per lane.

BART Phase II Extension Project

Level Of Service Computation Report
 2000 HCM Operations (Future Volume Alternative)
 AM - 2035 No Project Conditions

Intersection #3211: 101/McKee(E)

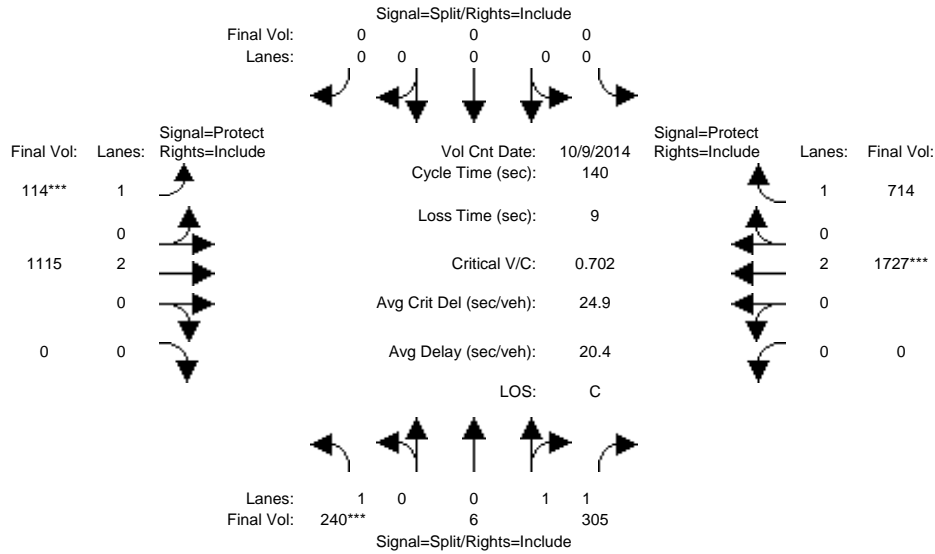

Approach:	North Bound			South Bound			East Bound			West Bound		
Movement:	L	T	R	L	T	R	L	T	R	L	T	R
Min. Green:	10	10	10	0	0	0	7	10	0	0	10	10
Y+R:	4.0	4.0	4.0	4.0	4.0	4.0	4.0	4.0	4.0	4.0	4.0	4.0
Volume Module: >> Count Date: 9 Oct 2014 <<												
Base Vol:	240	6	305	0	0	0	114	1115	0	0	1727	714
Growth Adj:	1.00	1.00	1.00	1.00	1.00	1.00	1.00	1.00	1.00	1.00	1.00	1.00
Initial Bse:	240	6	305	0	0	0	114	1115	0	0	1727	714
Added Vol:	0	0	0	0	0	0	0	0	0	0	0	0
PasserByVol:	0	0	0	0	0	0	0	0	0	0	0	0
Initial Fut:	240	6	305	0	0	0	114	1115	0	0	1727	714
User Adj:	1.00	1.00	1.00	1.00	1.00	1.00	1.00	1.00	1.00	1.00	1.00	1.00
PHF Adj:	1.00	1.00	1.00	1.00	1.00	1.00	1.00	1.00	1.00	1.00	1.00	1.00
PHF Volume:	240	6	305	0	0	0	114	1115	0	0	1727	714
Reduct Vol:	0	0	0	0	0	0	0	0	0	0	0	0
Reduced Vol:	240	6	305	0	0	0	114	1115	0	0	1727	714
PCE Adj:	1.00	1.00	1.00	1.00	1.00	1.00	1.00	1.00	1.00	1.00	1.00	1.00
MLF Adj:	1.00	1.00	1.00	1.00	1.00	1.00	1.00	1.00	1.00	1.00	1.00	1.00
FinalVolume:	240	6	305	0	0	0	114	1115	0	0	1727	714
Saturation Flow Module:												
Sat/Lane:	1900	1900	1900	1900	1900	1900	1900	1900	1900	1900	1900	1900
Adjustment:	0.92	0.95	0.95	0.92	1.00	0.92	0.92	1.00	0.92	0.92	1.00	0.92
Lanes:	1.00	0.04	1.96	0.00	0.00	0.00	1.00	2.00	0.00	0.00	2.00	1.00
Final Sat.:	1750	69	3531	0	0	0	1750	3800	0	0	3800	1750
Capacity Analysis Module:												
Vol/Sat:	0.14	0.09	0.09	0.00	0.00	0.00	0.07	0.29	0.00	0.00	0.45	0.41
Crit Moves:	****						****				****	
Green Time:	27.4	27.4	27.4	0.0	0.0	0.0	13.0	104	0.0	0.0	90.7	90.7
Volume/Cap:	0.70	0.44	0.44	0.00	0.00	0.00	0.70	0.40	0.00	0.00	0.70	0.63
Delay/Veh:	58.9	50.0	50.0	0.0	0.0	0.0	74.5	6.8	0.0	0.0	16.9	15.8
User DelAdj:	1.00	1.00	1.00	1.00	1.00	1.00	1.00	1.00	1.00	1.00	1.00	1.00
AdjDel/Veh:	58.9	50.0	50.0	0.0	0.0	0.0	74.5	6.8	0.0	0.0	16.9	15.8
LOS by Move:	E	D	D	A	A	A	E	A	A	A	B	B
HCM2k95thQ:	21	12	12	0	0	0	12	16	0	0	40	33

Note: Queue reported is the number of cars per lane.

BART Phase II Extension Project

Level Of Service Computation Report
 2000 HCM Operations (Future Volume Alternative)
 PM - 2035 No Project Conditions

Intersection #3211: 101/McKee(E)

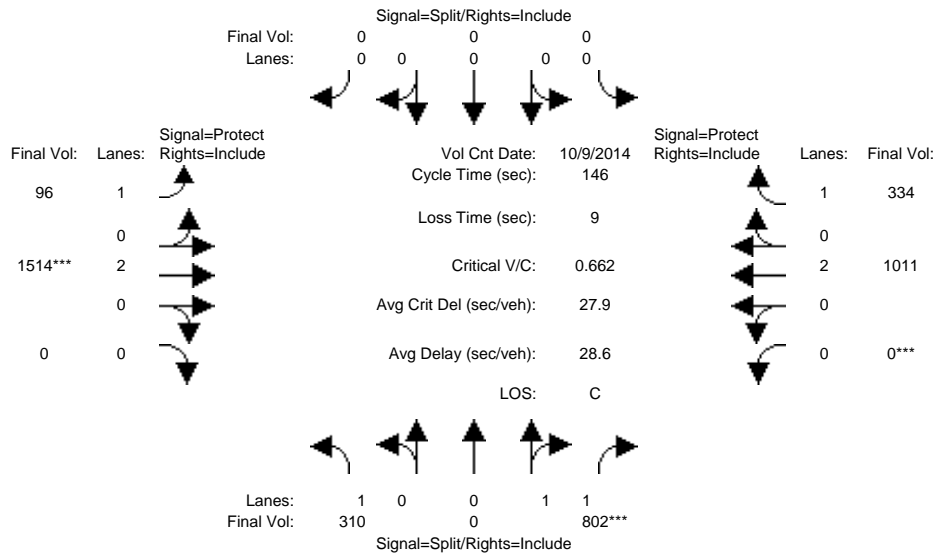

Approach:	North Bound			South Bound			East Bound			West Bound		
	L	T	R	L	T	R	L	T	R	L	T	R
Min. Green:	10	10	10	0	0	0	7	10	0	0	10	10
Y+R:	4.0	4.0	4.0	4.0	4.0	4.0	4.0	4.0	4.0	4.0	4.0	4.0

Volume Module:	>> Count Date: 9 Oct 2014 <<											
Base Vol:	310	0	802	0	0	0	96	1514	0	0	1011	334
Growth Adj:	1.00	1.00	1.00	1.00	1.00	1.00	1.00	1.00	1.00	1.00	1.00	1.00
Initial Bse:	310	0	802	0	0	0	96	1514	0	0	1011	334
Added Vol:	0	0	0	0	0	0	0	0	0	0	0	0
PasserByVol:	0	0	0	0	0	0	0	0	0	0	0	0
Initial Fut:	310	0	802	0	0	0	96	1514	0	0	1011	334
User Adj:	1.00	1.00	1.00	1.00	1.00	1.00	1.00	1.00	1.00	1.00	1.00	1.00
PHF Adj:	1.00	1.00	1.00	1.00	1.00	1.00	1.00	1.00	1.00	1.00	1.00	1.00
PHF Volume:	310	0	802	0	0	0	96	1514	0	0	1011	334
Reduct Vol:	0	0	0	0	0	0	0	0	0	0	0	0
Reduced Vol:	310	0	802	0	0	0	96	1514	0	0	1011	334
PCE Adj:	1.00	1.00	1.00	1.00	1.00	1.00	1.00	1.00	1.00	1.00	1.00	1.00
MLF Adj:	1.00	1.00	1.00	1.00	1.00	1.00	1.00	1.00	1.00	1.00	1.00	1.00
Final Volume:	310	0	802	0	0	0	96	1514	0	0	1011	334

Saturation Flow Module:												
Sat/Lane:	1900	1900	1900	1900	1900	1900	1900	1900	1900	1900	1900	1900
Adjustment:	0.92	1.00	0.95	0.92	1.00	0.92	0.92	1.00	0.92	0.92	1.00	0.92
Lanes:	1.00	0.00	2.00	0.00	0.00	0.00	1.00	2.00	0.00	0.00	2.00	1.00
Final Sat.:	1750	0	3600	0	0	0	1750	3800	0	0	3800	1750

Capacity Analysis Module:												
Vol/Sat:	0.18	0.00	0.22	0.00	0.00	0.00	0.05	0.40	0.00	0.00	0.27	0.19
Crit Moves:			****					****			****	
Green Time:	49.1	0.0	49.1	0.0	0.0	0.0	15.0	87.9	0.0	0.0	72.8	72.8
Volume/Cap:	0.53	0.00	0.66	0.00	0.00	0.00	0.53	0.66	0.00	0.00	0.53	0.38
Delay/Veh:	39.9	0.0	42.7	0.0	0.0	0.0	65.2	20.0	0.0	0.0	25.3	22.9
User DelAdj:	1.00	1.00	1.00	1.00	1.00	1.00	1.00	1.00	1.00	1.00	1.00	1.00
AdjDel/Veh:	39.9	0.0	42.7	0.0	0.0	0.0	65.2	20.0	0.0	0.0	25.3	22.9
LOS by Move:	D	A	D	A	A	A	E	B	A	A	C	C
HCM2k95thQ:	22	0	29	0	0	0	10	37	0	0	26	18

Note: Queue reported is the number of cars per lane.

BART Phase II Extension Project

Level Of Service Computation Report
 2000 HCM Operations (Future Volume Alternative)
 AM - 2035 No Project Conditions

Intersection #3612: JULIAN/21ST

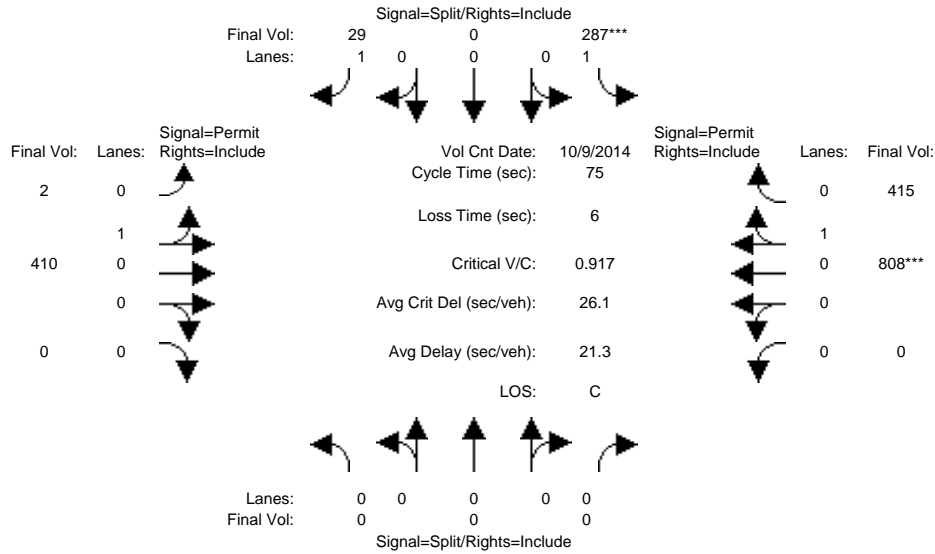

Approach:	North Bound			South Bound			East Bound			West Bound			
	L	T	R	L	T	R	L	T	R	L	T	R	
Min. Green:	0	0	0	10	0	10	10	10	0	0	10	10	
Y+R:	4.0	4.0	4.0	4.0	4.0	4.0	4.0	4.0	4.0	4.0	4.0	4.0	
Volume Module: >> Count Date: 9 Oct 2014 <<													
Base Vol:	0	0	0	287	0	29	2	410	0	0	808	415	
Growth Adj:	1.00	1.00	1.00	1.00	1.00	1.00	1.00	1.00	1.00	1.00	1.00	1.00	
Initial Bse:	0	0	0	287	0	29	2	410	0	0	808	415	
Added Vol:	0	0	0	0	0	0	0	0	0	0	0	0	
PasserByVol:	0	0	0	0	0	0	0	0	0	0	0	0	
Initial Fut:	0	0	0	287	0	29	2	410	0	0	808	415	
User Adj:	1.00	1.00	1.00	1.00	1.00	1.00	1.00	1.00	1.00	1.00	1.00	1.00	
PHF Adj:	1.00	1.00	1.00	1.00	1.00	1.00	1.00	1.00	1.00	1.00	1.00	1.00	
PHF Volume:	0	0	0	287	0	29	2	410	0	0	808	415	
Reduct Vol:	0	0	0	0	0	0	0	0	0	0	0	0	
Reduced Vol:	0	0	0	287	0	29	2	410	0	0	808	415	
PCE Adj:	1.00	1.00	1.00	1.00	1.00	1.00	1.00	1.00	1.00	1.00	1.00	1.00	
MLF Adj:	1.00	1.00	1.00	1.00	1.00	1.00	1.00	1.00	1.00	1.00	1.00	1.00	
FinalVolume:	0	0	0	287	0	29	2	410	0	0	808	415	
Saturation Flow Module:													
Sat/Lane:	1900	1900	1900	1900	1900	1900	1900	1900	1900	1900	1900	1900	
Adjustment:	0.92	1.00	0.92	0.92	1.00	0.92	0.95	0.95	0.92	0.92	0.95	0.95	
Lanes:	0.00	0.00	0.00	1.00	0.00	1.00	0.01	0.99	0.00	0.00	0.66	0.34	
Final Sat.:	0	0	0	1750	0	1750	9	1791	0	0	1189	611	
Capacity Analysis Module:													
Vol/Sat:	0.00	0.00	0.00	0.16	0.00	0.02	0.23	0.23	0.00	0.00	0.68	0.68	
Crit Moves:				****							****		
Green Time:	0.0	0.0	0.0	13.4	0.0	13.4	55.6	55.6	0.0	0.0	55.6	55.6	
Volume/Cap:	0.00	0.00	0.00	0.92	0.00	0.09	0.31	0.31	0.00	0.00	0.92	0.92	
Delay/Veh:	0.0	0.0	0.0	60.6	0.0	25.8	3.4	3.4	0.0	0.0	18.0	18.0	
User DelAdj:	1.00	1.00	1.00	1.00	1.00	1.00	1.00	1.00	1.00	1.00	1.00	1.00	
AdjDel/Veh:	0.0	0.0	0.0	60.6	0.0	25.8	3.4	3.4	0.0	0.0	18.0	18.0	
LOS by Move:	A	A	A	E	A	C	A	A	A	A	B	B	
HCM2k95thQ:	0	0	0	20	0	1	7	7	0	0	44	44	

Note: Queue reported is the number of cars per lane.

BART Phase II Extension Project

Level Of Service Computation Report
 2000 HCM Operations (Future Volume Alternative)
 PM - 2035 No Project Conditions

Intersection #3612: JULIAN/21ST

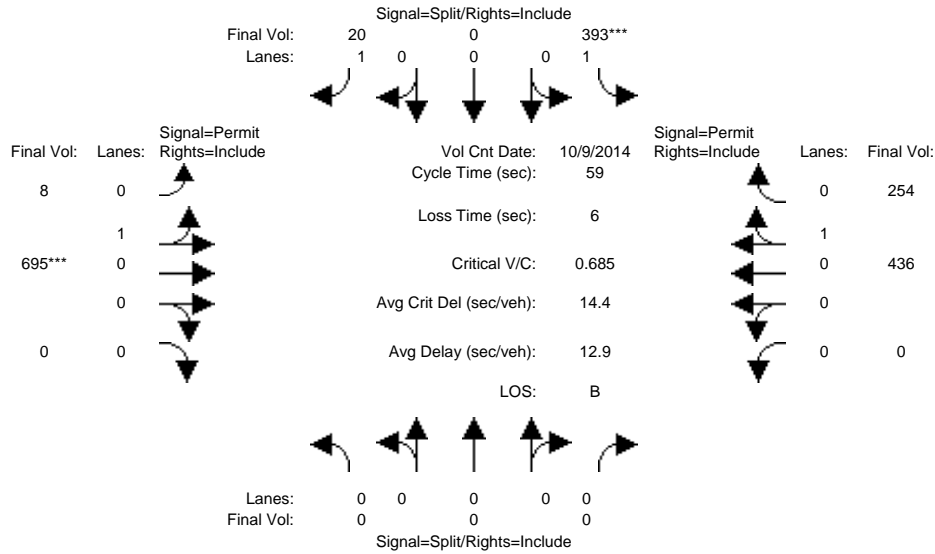

Approach:	North Bound			South Bound			East Bound			West Bound			
	L	T	R	L	T	R	L	T	R	L	T	R	
Min. Green:	0	0	0	10	0	10	10	10	0	0	10	10	
Y+R:	4.0	4.0	4.0	4.0	4.0	4.0	4.0	4.0	4.0	4.0	4.0	4.0	
Volume Module: >> Count Date: 9 Oct 2014 <<													
Base Vol:	0	0	0	393	0	20	8	695	0	0	436	254	
Growth Adj:	1.00	1.00	1.00	1.00	1.00	1.00	1.00	1.00	1.00	1.00	1.00	1.00	
Initial Bse:	0	0	0	393	0	20	8	695	0	0	436	254	
Added Vol:	0	0	0	0	0	0	0	0	0	0	0	0	
PasserByVol:	0	0	0	0	0	0	0	0	0	0	0	0	
Initial Fut:	0	0	0	393	0	20	8	695	0	0	436	254	
User Adj:	1.00	1.00	1.00	1.00	1.00	1.00	1.00	1.00	1.00	1.00	1.00	1.00	
PHF Adj:	1.00	1.00	1.00	1.00	1.00	1.00	1.00	1.00	1.00	1.00	1.00	1.00	
PHF Volume:	0	0	0	393	0	20	8	695	0	0	436	254	
Reduct Vol:	0	0	0	0	0	0	0	0	0	0	0	0	
Reduced Vol:	0	0	0	393	0	20	8	695	0	0	436	254	
PCE Adj:	1.00	1.00	1.00	1.00	1.00	1.00	1.00	1.00	1.00	1.00	1.00	1.00	
MLF Adj:	1.00	1.00	1.00	1.00	1.00	1.00	1.00	1.00	1.00	1.00	1.00	1.00	
FinalVolume:	0	0	0	393	0	20	8	695	0	0	436	254	
Saturation Flow Module:													
Sat/Lane:	1900	1900	1900	1900	1900	1900	1900	1900	1900	1900	1900	1900	
Adjustment:	0.92	1.00	0.92	0.92	1.00	0.92	0.95	0.95	0.92	0.92	0.95	0.95	
Lanes:	0.00	0.00	0.00	1.00	0.00	1.00	0.01	0.99	0.00	0.00	0.63	0.37	
Final Sat.:	0	0	0	1750	0	1750	20	1780	0	0	1137	663	
Capacity Analysis Module:													
Vol/Sat:	0.00	0.00	0.00	0.22	0.00	0.01	0.39	0.39	0.00	0.00	0.38	0.38	
Crit Moves:				****							****		
Green Time:	0.0	0.0	0.0	19.3	0.0	19.3	33.7	33.7	0.0	0.0	33.7	33.7	
Volume/Cap:	0.00	0.00	0.00	0.68	0.00	0.03	0.68	0.68	0.00	0.00	0.67	0.67	
Delay/Veh:	0.0	0.0	0.0	20.6	0.0	13.5	10.9	10.9	0.0	0.0	10.6	10.6	
User DelAdj:	1.00	1.00	1.00	1.00	1.00	1.00	1.00	1.00	1.00	1.00	1.00	1.00	
AdjDel/Veh:	0.0	0.0	0.0	20.6	0.0	13.5	10.9	10.9	0.0	0.0	10.6	10.6	
LOS by Move:	A	A	A	C	A	B	B	B	A	A	B	B	
HCM2k95thQ:	0	0	0	15	0	1	18	18	0	0	17	17	

Note: Queue reported is the number of cars per lane.

BART Phase II Extension Project

Level Of Service Computation Report
 2000 HCM Operations (Future Volume Alternative)
 AM - 2035 No Project Conditions

Intersection #3613: JULIAN/24TH

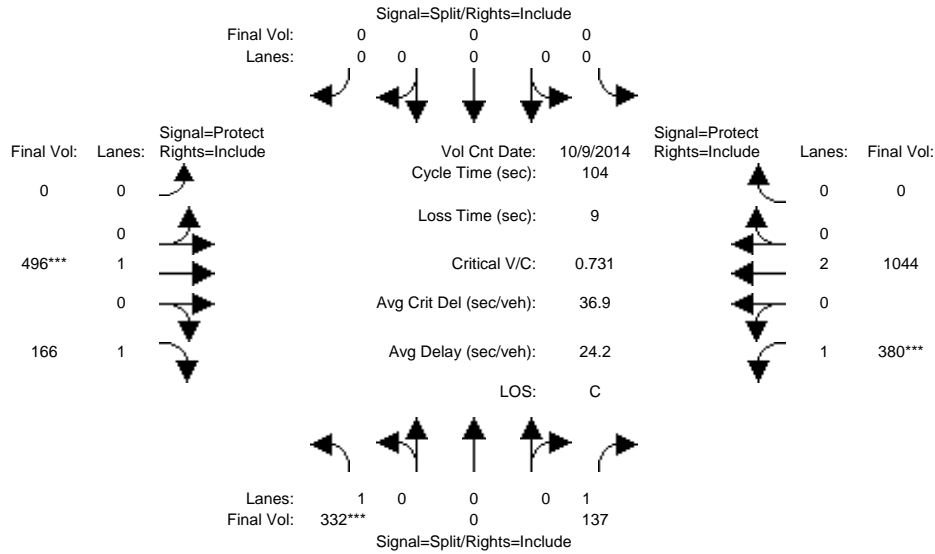

Approach:	North Bound			South Bound			East Bound			West Bound		
	L	T	R	L	T	R	L	T	R	L	T	R
Min. Green:	10	0	10	0	0	0	0	10	10	7	10	0
Y+R:	4.0	4.0	4.0	4.0	4.0	4.0	4.0	4.0	4.0	4.0	4.0	4.0
Volume Module: >> Count Date: 9 Oct 2014 <<												
Base Vol:	332	0	137	0	0	0	0	496	166	380	1044	0
Growth Adj:	1.00	1.00	1.00	1.00	1.00	1.00	1.00	1.00	1.00	1.00	1.00	1.00
Initial Bse:	332	0	137	0	0	0	0	496	166	380	1044	0
Added Vol:	0	0	0	0	0	0	0	0	0	0	0	0
PasserByVol:	0	0	0	0	0	0	0	0	0	0	0	0
Initial Fut:	332	0	137	0	0	0	0	496	166	380	1044	0
User Adj:	1.00	1.00	1.00	1.00	1.00	1.00	1.00	1.00	1.00	1.00	1.00	1.00
PHF Adj:	1.00	1.00	1.00	1.00	1.00	1.00	1.00	1.00	1.00	1.00	1.00	1.00
PHF Volume:	332	0	137	0	0	0	0	496	166	380	1044	0
Reduct Vol:	0	0	0	0	0	0	0	0	0	0	0	0
Reduced Vol:	332	0	137	0	0	0	0	496	166	380	1044	0
PCE Adj:	1.00	1.00	1.00	1.00	1.00	1.00	1.00	1.00	1.00	1.00	1.00	1.00
MLF Adj:	1.00	1.00	1.00	1.00	1.00	1.00	1.00	1.00	1.00	1.00	1.00	1.00
FinalVolume:	332	0	137	0	0	0	0	496	166	380	1044	0
Saturation Flow Module:												
Sat/Lane:	1900	1900	1900	1900	1900	1900	1900	1900	1900	1900	1900	1900
Adjustment:	0.92	1.00	0.92	0.92	1.00	0.92	0.92	1.00	0.92	0.92	1.00	0.92
Lanes:	1.00	0.00	1.00	0.00	0.00	0.00	0.00	1.00	1.00	1.00	2.00	0.00
Final Sat.:	1750	0	1750	0	0	0	0	1900	1750	1750	3800	0
Capacity Analysis Module:												
Vol/Sat:	0.19	0.00	0.08	0.00	0.00	0.00	0.00	0.26	0.09	0.22	0.27	0.00
Crit Moves:	****							****		****		
Green Time:	27.0	0.0	27.0	0.0	0.0	0.0	0.0	37.1	37.1	30.9	68.0	0.0
Volume/Cap:	0.73	0.00	0.30	0.00	0.00	0.00	0.00	0.73	0.27	0.73	0.42	0.00
Delay/Veh:	41.2	0.0	31.3	0.0	0.0	0.0	0.0	33.2	24.0	38.1	8.7	0.0
User DelAdj:	1.00	1.00	1.00	1.00	1.00	1.00	1.00	1.00	1.00	1.00	1.00	1.00
AdjDel/Veh:	41.2	0.0	31.3	0.0	0.0	0.0	0.0	33.2	24.0	38.1	8.7	0.0
LOS by Move:	D	A	C	A	A	A	A	C	C	D	A	A
HCM2k95thQ:	22	0	8	0	0	0	0	25	8	23	15	0

Note: Queue reported is the number of cars per lane.

BART Phase II Extension Project

Level Of Service Computation Report
 2000 HCM Operations (Future Volume Alternative)
 PM - 2035 No Project Conditions

Intersection #3613: JULIAN/24TH

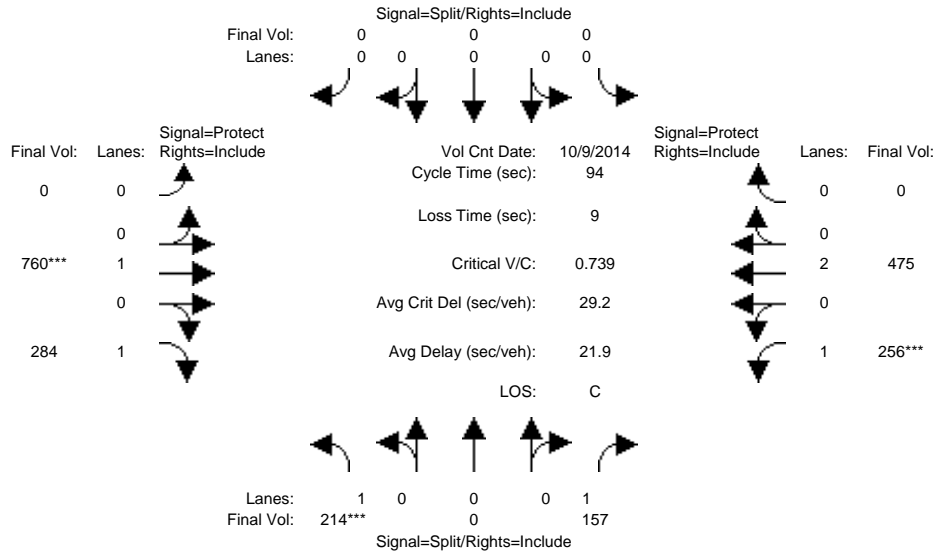

Approach:	North Bound			South Bound			East Bound			West Bound		
	L	T	R	L	T	R	L	T	R	L	T	R
Min. Green:	10	0	10	0	0	0	0	10	10	7	10	0
Y+R:	4.0	4.0	4.0	4.0	4.0	4.0	4.0	4.0	4.0	4.0	4.0	4.0
Volume Module: >> Count Date: 9 Oct 2014 <<												
Base Vol:	214	0	157	0	0	0	0	760	284	256	475	0
Growth Adj:	1.00	1.00	1.00	1.00	1.00	1.00	1.00	1.00	1.00	1.00	1.00	1.00
Initial Bse:	214	0	157	0	0	0	0	760	284	256	475	0
Added Vol:	0	0	0	0	0	0	0	0	0	0	0	0
PasserByVol:	0	0	0	0	0	0	0	0	0	0	0	0
Initial Fut:	214	0	157	0	0	0	0	760	284	256	475	0
User Adj:	1.00	1.00	1.00	1.00	1.00	1.00	1.00	1.00	1.00	1.00	1.00	1.00
PHF Adj:	1.00	1.00	1.00	1.00	1.00	1.00	1.00	1.00	1.00	1.00	1.00	1.00
PHF Volume:	214	0	157	0	0	0	0	760	284	256	475	0
Reduct Vol:	0	0	0	0	0	0	0	0	0	0	0	0
Reduced Vol:	214	0	157	0	0	0	0	760	284	256	475	0
PCE Adj:	1.00	1.00	1.00	1.00	1.00	1.00	1.00	1.00	1.00	1.00	1.00	1.00
MLF Adj:	1.00	1.00	1.00	1.00	1.00	1.00	1.00	1.00	1.00	1.00	1.00	1.00
Final Volume:	214	0	157	0	0	0	0	760	284	256	475	0
Saturation Flow Module:												
Sat/Lane:	1900	1900	1900	1900	1900	1900	1900	1900	1900	1900	1900	1900
Adjustment:	0.92	1.00	0.92	0.92	1.00	0.92	0.92	1.00	0.92	0.92	1.00	0.92
Lanes:	1.00	0.00	1.00	0.00	0.00	0.00	0.00	1.00	1.00	1.00	2.00	0.00
Final Sat.:	1750	0	1750	0	0	0	0	1900	1750	1750	3800	0
Capacity Analysis Module:												
Vol/Sat:	0.12	0.00	0.09	0.00	0.00	0.00	0.00	0.40	0.16	0.15	0.13	0.00
Crit Moves:	****							****		****		
Green Time:	15.5	0.0	15.5	0.0	0.0	0.0	0.0	50.9	50.9	18.6	69.5	0.0
Volume/Cap:	0.74	0.00	0.54	0.00	0.00	0.00	0.00	0.74	0.30	0.74	0.17	0.00
Delay/Veh:	47.0	0.0	38.1	0.0	0.0	0.0	0.0	19.4	12.0	43.6	3.7	0.0
User DelAdj:	1.00	1.00	1.00	1.00	1.00	1.00	1.00	1.00	1.00	1.00	1.00	1.00
AdjDel/Veh:	47.0	0.0	38.1	0.0	0.0	0.0	0.0	19.4	12.0	43.6	3.7	0.0
LOS by Move:	D	A	D	A	A	A	A	B	B	D	A	A
HCM2k95thQ:	15	0	10	0	0	0	0	29	9	17	4	0

Note: Queue reported is the number of cars per lane.

BART Phase II Extension Project

Level Of Service Computation Report
 2000 HCM Operations (Future Volume Alternative)
 AM - 2035 No Project Conditions

Intersection #3625: KING/McKEE

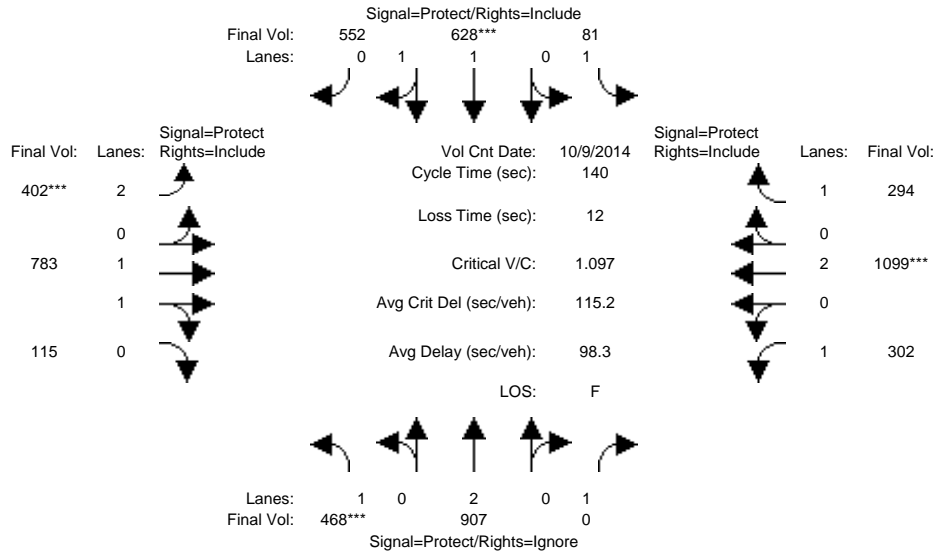

Approach:	North Bound			South Bound			East Bound			West Bound		
	L	T	R	L	T	R	L	T	R	L	T	R
Min. Green:	7	10	10	7	10	10	7	10	10	7	10	10
Y+R:	4.0	4.0	4.0	4.0	4.0	4.0	4.0	4.0	4.0	4.0	4.0	4.0
Volume Module: >> Count Date: 9 Oct 2014 <<												
Base Vol:	468	907	195	81	628	552	402	783	115	302	1099	294
Growth Adj:	1.00	1.00	1.00	1.00	1.00	1.00	1.00	1.00	1.00	1.00	1.00	1.00
Initial Bse:	468	907	195	81	628	552	402	783	115	302	1099	294
Added Vol:	0	0	0	0	0	0	0	0	0	0	0	0
PasserByVol:	0	0	0	0	0	0	0	0	0	0	0	0
Initial Fut:	468	907	195	81	628	552	402	783	115	302	1099	294
User Adj:	1.00	1.00	0.00	1.00	1.00	1.00	1.00	1.00	1.00	1.00	1.00	1.00
PHF Adj:	1.00	1.00	0.00	1.00	1.00	1.00	1.00	1.00	1.00	1.00	1.00	1.00
PHF Volume:	468	907	0	81	628	552	402	783	115	302	1099	294
Reduct Vol:	0	0	0	0	0	0	0	0	0	0	0	0
Reduced Vol:	468	907	0	81	628	552	402	783	115	302	1099	294
PCE Adj:	1.00	1.00	0.00	1.00	1.00	1.00	1.00	1.00	1.00	1.00	1.00	1.00
MLF Adj:	1.00	1.00	0.00	1.00	1.00	1.00	1.00	1.00	1.00	1.00	1.00	1.00
FinalVolume:	468	907	0	81	628	552	402	783	115	302	1099	294
Saturation Flow Module:												
Sat/Lane:	1900	1900	1900	1900	1900	1900	1900	1900	1900	1900	1900	1900
Adjustment:	0.92	1.00	0.92	0.92	1.00	0.95	0.83	0.98	0.95	0.92	1.00	0.92
Lanes:	1.00	2.00	1.00	1.00	1.04	0.96	2.00	1.74	0.26	1.00	2.00	1.00
Final Sat.:	1750	3800	1750	1750	1968	1730	3150	3226	474	1750	3800	1750
Capacity Analysis Module:												
Vol/Sat:	0.27	0.24	0.00	0.05	0.32	0.32	0.13	0.24	0.24	0.17	0.29	0.17
Crit Moves:	****				****		****				****	
Green Time:	34.1	61.9	0.0	13.0	40.7	40.7	16.3	31.1	31.1	22.1	36.9	36.9
Volume/Cap:	1.10	0.54	0.00	0.50	1.10	1.10	1.10	1.09	1.09	1.09	1.10	0.64
Delay/Veh:	125.5	29.0	0.0	62.9	108	107.7	137.7	114	114.5	140.4	110	48.6
User DelAdj:	1.00	1.00	1.00	1.00	1.00	1.00	1.00	1.00	1.00	1.00	1.00	1.00
AdjDel/Veh:	125.5	29.0	0.0	62.9	108	107.7	137.7	114	114.5	140.4	110	48.6
LOS by Move:	F	C	A	E	F	F	F	F	F	F	F	D
HCM2k95thQ:	47	25	0	7	55	55	25	43	43	33	51	22

Note: Queue reported is the number of cars per lane.

BART Phase II Extension Project

Level Of Service Computation Report
 2000 HCM Operations (Future Volume Alternative)
 PM - 2035 No Project Conditions

Intersection #3625: KING/McKEE

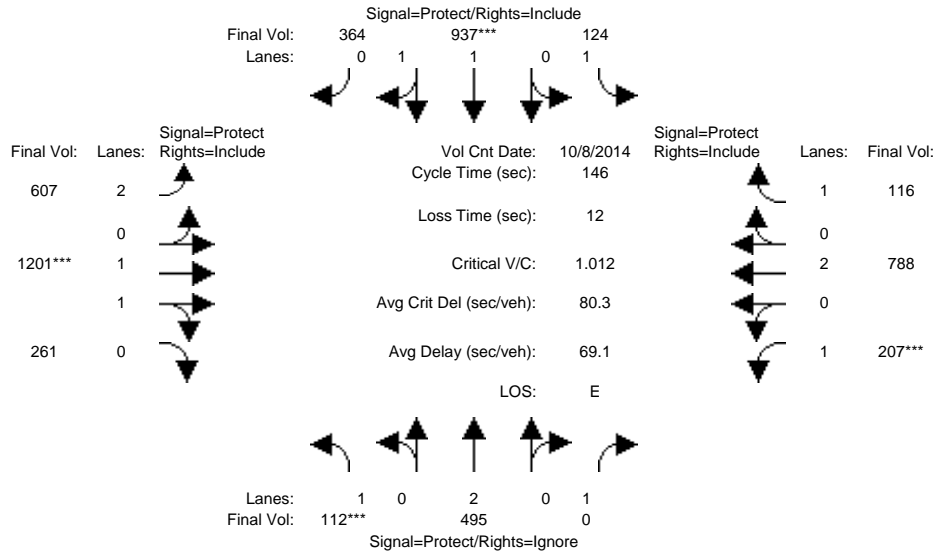

Approach:	North Bound			South Bound			East Bound			West Bound		
	L	T	R	L	T	R	L	T	R	L	T	R
Min. Green:	7	10	10	7	10	10	7	10	10	7	10	10
Y+R:	4.0	4.0	4.0	4.0	4.0	4.0	4.0	4.0	4.0	4.0	4.0	4.0

Volume Module:	>> Count Date: 8 Oct 2014 <<											
Base Vol:	112	495	181	124	937	364	607	1201	261	207	788	116
Growth Adj:	1.00	1.00	1.00	1.00	1.00	1.00	1.00	1.00	1.00	1.00	1.00	1.00
Initial Bse:	112	495	181	124	937	364	607	1201	261	207	788	116
Added Vol:	0	0	0	0	0	0	0	0	0	0	0	0
PasserByVol:	0	0	0	0	0	0	0	0	0	0	0	0
Initial Fut:	112	495	181	124	937	364	607	1201	261	207	788	116
User Adj:	1.00	1.00	0.00	1.00	1.00	1.00	1.00	1.00	1.00	1.00	1.00	1.00
PHF Adj:	1.00	1.00	0.00	1.00	1.00	1.00	1.00	1.00	1.00	1.00	1.00	1.00
PHF Volume:	112	495	0	124	937	364	607	1201	261	207	788	116
Reduct Vol:	0	0	0	0	0	0	0	0	0	0	0	0
Reduced Vol:	112	495	0	124	937	364	607	1201	261	207	788	116
PCE Adj:	1.00	1.00	0.00	1.00	1.00	1.00	1.00	1.00	1.00	1.00	1.00	1.00
MLF Adj:	1.00	1.00	0.00	1.00	1.00	1.00	1.00	1.00	1.00	1.00	1.00	1.00
FinalVolume:	112	495	0	124	937	364	607	1201	261	207	788	116

Saturation Flow Module:												
Sat/Lane:	1900	1900	1900	1900	1900	1900	1900	1900	1900	1900	1900	1900
Adjustment:	0.92	1.00	0.92	0.92	0.98	0.95	0.83	0.98	0.95	0.92	1.00	0.92
Lanes:	1.00	2.00	1.00	1.00	1.43	0.57	2.00	1.63	0.37	1.00	2.00	1.00
Final Sat.:	1750	3800	1750	1750	2664	1035	3150	3039	660	1750	3800	1750

Capacity Analysis Module:												
Vol/Sat:	0.06	0.13	0.00	0.07	0.35	0.35	0.19	0.40	0.40	0.12	0.21	0.07
Crit Moves:	****				****			****		****		
Green Time:	9.2	38.8	0.0	21.1	50.7	50.7	35.7	57.0	57.0	17.1	38.4	38.4
Volume/Cap:	1.01	0.49	0.00	0.49	1.01	1.01	0.79	1.01	1.01	1.01	0.79	0.25
Delay/Veh:	157.3	45.6	0.0	59.0	75.8	75.8	57.1	71.3	71.3	130.7	54.3	42.8
User DelAdj:	1.00	1.00	1.00	1.00	1.00	1.00	1.00	1.00	1.00	1.00	1.00	1.00
AdjDel/Veh:	157.3	45.6	0.0	59.0	75.8	75.8	57.1	71.3	71.3	130.7	54.3	42.8
LOS by Move:	F	D	A	E	E	E	E	E	E	F	D	D
HCM2k95thQ:	13	17	0	11	56	56	28	62	62	23	29	8

Note: Queue reported is the number of cars per lane.

BART Phase II Extension Project

Level Of Service Computation Report
 2000 HCM Operations (Future Volume Alternative)
 AM - 2035 No Project Conditions

Intersection #3683: McLAUGHLIN/STORY

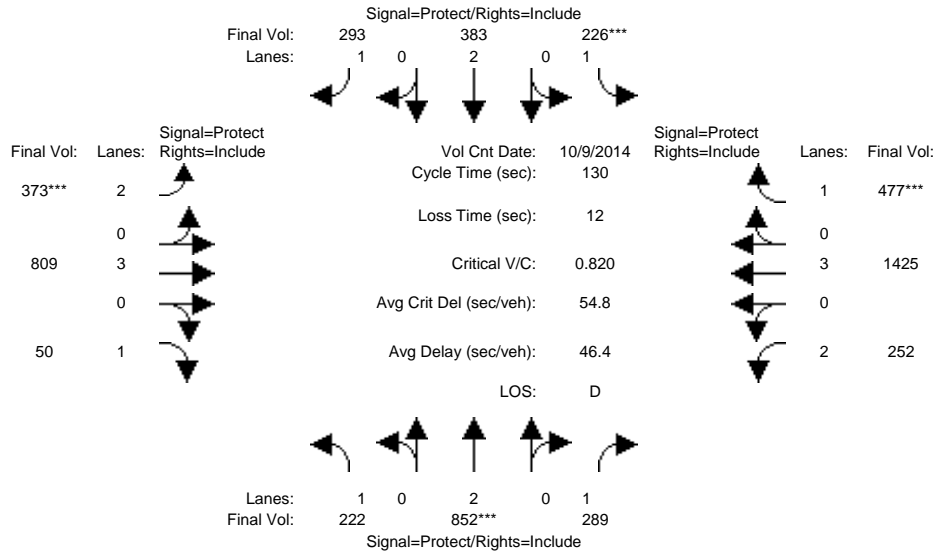

Approach:	North Bound			South Bound			East Bound			West Bound		
	L	T	R	L	T	R	L	T	R	L	T	R
Min. Green:	7	10	10	7	10	10	7	10	10	7	10	10
Y+R:	4.0	4.0	4.0	4.0	4.0	4.0	4.0	4.0	4.0	4.0	4.0	4.0
Volume Module: >> Count Date: 9 Oct 2014 <<												
Base Vol:	222	852	289	226	383	293	373	809	50	252	1425	477
Growth Adj:	1.00	1.00	1.00	1.00	1.00	1.00	1.00	1.00	1.00	1.00	1.00	1.00
Initial Bse:	222	852	289	226	383	293	373	809	50	252	1425	477
Added Vol:	0	0	0	0	0	0	0	0	0	0	0	0
PasserByVol:	0	0	0	0	0	0	0	0	0	0	0	0
Initial Fut:	222	852	289	226	383	293	373	809	50	252	1425	477
User Adj:	1.00	1.00	1.00	1.00	1.00	1.00	1.00	1.00	1.00	1.00	1.00	1.00
PHF Adj:	1.00	1.00	1.00	1.00	1.00	1.00	1.00	1.00	1.00	1.00	1.00	1.00
PHF Volume:	222	852	289	226	383	293	373	809	50	252	1425	477
Reduct Vol:	0	0	0	0	0	0	0	0	0	0	0	0
Reduced Vol:	222	852	289	226	383	293	373	809	50	252	1425	477
PCE Adj:	1.00	1.00	1.00	1.00	1.00	1.00	1.00	1.00	1.00	1.00	1.00	1.00
MLF Adj:	1.00	1.00	1.00	1.00	1.00	1.00	1.00	1.00	1.00	1.00	1.00	1.00
FinalVolume:	222	852	289	226	383	293	373	809	50	252	1425	477
Saturation Flow Module:												
Sat/Lane:	1900	1900	1900	1900	1900	1900	1900	1900	1900	1900	1900	1900
Adjustment:	0.92	1.00	0.92	0.92	1.00	0.92	0.83	1.00	0.92	0.83	1.00	0.92
Lanes:	1.00	2.00	1.00	1.00	2.00	1.00	2.00	3.00	1.00	2.00	3.00	1.00
Final Sat.:	1750	3800	1750	1750	3800	1750	3150	5700	1750	3150	5700	1750
Capacity Analysis Module:												
Vol/Sat:	0.13	0.22	0.17	0.13	0.10	0.17	0.12	0.14	0.03	0.08	0.25	0.27
Crit Moves:	****			****			****			****		
Green Time:	24.1	35.5	35.5	20.5	31.9	31.9	18.8	39.6	39.6	22.3	43.2	43.2
Volume/Cap:	0.68	0.82	0.60	0.82	0.41	0.68	0.82	0.47	0.09	0.47	0.75	0.82
Delay/Veh:	55.2	49.5	43.3	70.4	41.5	49.0	65.2	36.8	32.4	49.1	40.4	48.9
User DelAdj:	1.00	1.00	1.00	1.00	1.00	1.00	1.00	1.00	1.00	1.00	1.00	1.00
AdjDel/Veh:	55.2	49.5	43.3	70.4	41.5	49.0	65.2	36.8	32.4	49.1	40.4	48.9
LOS by Move:	E	D	D	E	D	D	E	D	C	D	D	D
HCM2k95thQ:	18	31	21	19	12	21	20	16	3	10	30	33

Note: Queue reported is the number of cars per lane.

BART Phase II Extension Project

Level Of Service Computation Report
 2000 HCM Operations (Future Volume Alternative)
 PM - 2035 No Project Conditions

Intersection #3683: McLAUGHLIN/STORY

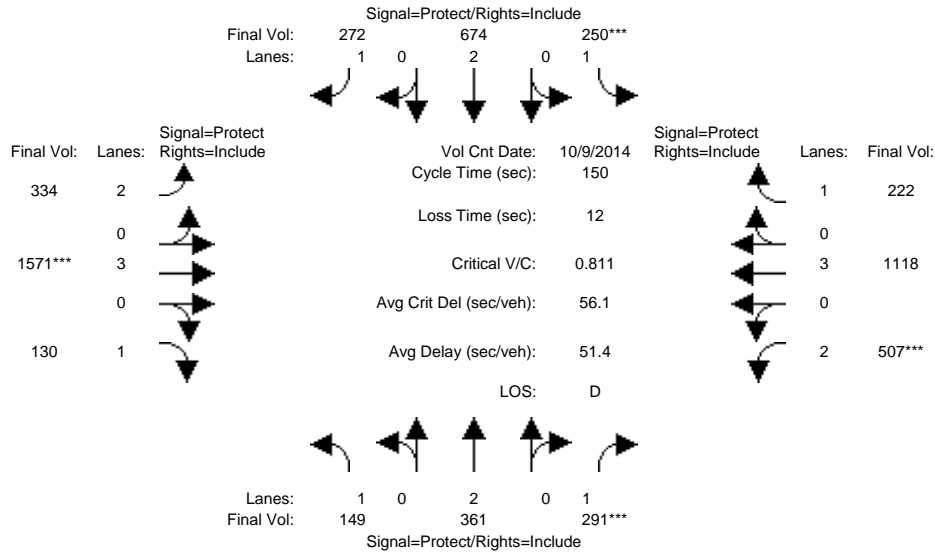

Approach:	North Bound			South Bound			East Bound			West Bound		
	L	T	R	L	T	R	L	T	R	L	T	R
Min. Green:	7	10	10	7	10	10	7	10	10	7	10	10
Y+R:	4.0	4.0	4.0	4.0	4.0	4.0	4.0	4.0	4.0	4.0	4.0	4.0
Volume Module: >> Count Date: 9 Oct 2014 <<												
Base Vol:	149	361	291	250	674	272	334	1571	130	507	1118	222
Growth Adj:	1.00	1.00	1.00	1.00	1.00	1.00	1.00	1.00	1.00	1.00	1.00	1.00
Initial Bse:	149	361	291	250	674	272	334	1571	130	507	1118	222
Added Vol:	0	0	0	0	0	0	0	0	0	0	0	0
PasserByVol:	0	0	0	0	0	0	0	0	0	0	0	0
Initial Fut:	149	361	291	250	674	272	334	1571	130	507	1118	222
User Adj:	1.00	1.00	1.00	1.00	1.00	1.00	1.00	1.00	1.00	1.00	1.00	1.00
PHF Adj:	1.00	1.00	1.00	1.00	1.00	1.00	1.00	1.00	1.00	1.00	1.00	1.00
PHF Volume:	149	361	291	250	674	272	334	1571	130	507	1118	222
Reduct Vol:	0	0	0	0	0	0	0	0	0	0	0	0
Reduced Vol:	149	361	291	250	674	272	334	1571	130	507	1118	222
PCE Adj:	1.00	1.00	1.00	1.00	1.00	1.00	1.00	1.00	1.00	1.00	1.00	1.00
MLF Adj:	1.00	1.00	1.00	1.00	1.00	1.00	1.00	1.00	1.00	1.00	1.00	1.00
Final Volume:	149	361	291	250	674	272	334	1571	130	507	1118	222
Saturation Flow Module:												
Sat/Lane:	1900	1900	1900	1900	1900	1900	1900	1900	1900	1900	1900	1900
Adjustment:	0.92	1.00	0.92	0.92	1.00	0.92	0.83	1.00	0.92	0.83	1.00	0.92
Lanes:	1.00	2.00	1.00	1.00	2.00	1.00	2.00	3.00	1.00	2.00	3.00	1.00
Final Sat.:	1750	3800	1750	1750	3800	1750	3150	5700	1750	3150	5700	1750
Capacity Analysis Module:												
Vol/Sat:	0.09	0.10	0.17	0.14	0.18	0.16	0.11	0.28	0.07	0.16	0.20	0.13
Crit Moves:			****	****				****		****		
Green Time:	18.6	30.8	30.8	26.4	38.7	38.7	28.3	51.0	51.0	29.8	52.4	52.4
Volume/Cap:	0.69	0.46	0.81	0.81	0.69	0.60	0.56	0.81	0.22	0.81	0.56	0.36
Delay/Veh:	71.9	52.8	69.8	74.2	52.3	51.2	56.4	47.8	35.5	65.3	39.8	36.7
User DelAdj:	1.00	1.00	1.00	1.00	1.00	1.00	1.00	1.00	1.00	1.00	1.00	1.00
AdjDel/Veh:	71.9	52.8	69.8	74.2	52.3	51.2	56.4	47.8	35.5	65.3	39.8	36.7
LOS by Move:	E	D	E	E	D	D	E	D	D	E	D	D
HCM2k95thQ:	16	14	28	23	25	21	16	39	9	25	24	15

Note: Queue reported is the number of cars per lane.

BART Phase II Extension Project

Level Of Service Computation Report
 2000 HCM Operations (Future Volume Alternative)
 AM - 2035 No Project Conditions

Intersection #3762: SAN ANTONIO/24TH

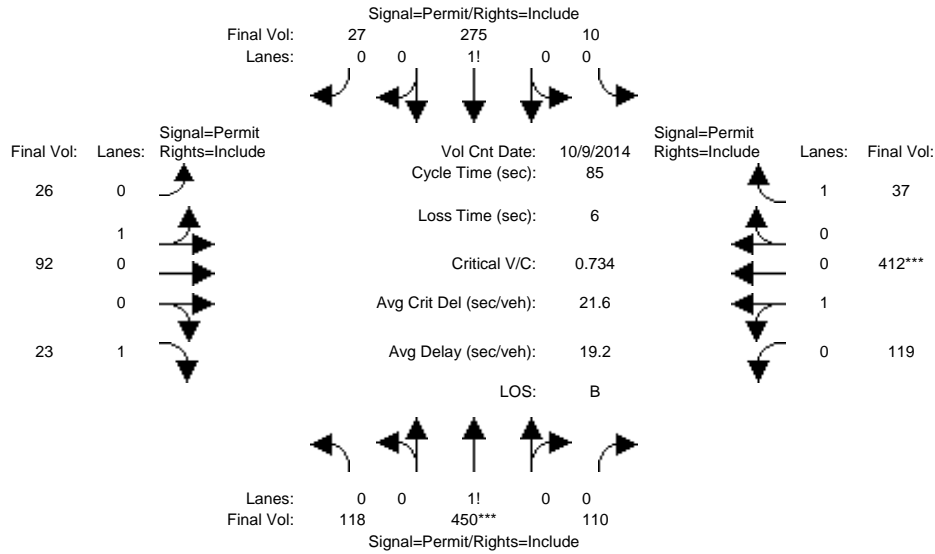

Approach:	North Bound			South Bound			East Bound			West Bound		
Movement:	L	T	R	L	T	R	L	T	R	L	T	R
Min. Green:	10	10	10	10	10	10	10	10	10	10	10	10
Y+R:	4.0	4.0	4.0	4.0	4.0	4.0	4.0	4.0	4.0	4.0	4.0	4.0
Volume Module: >> Count Date: 9 Oct 2014 <<												
Base Vol:	118	450	110	10	275	27	26	92	23	119	412	37
Growth Adj:	1.00	1.00	1.00	1.00	1.00	1.00	1.00	1.00	1.00	1.00	1.00	1.00
Initial Bse:	118	450	110	10	275	27	26	92	23	119	412	37
Added Vol:	0	0	0	0	0	0	0	0	0	0	0	0
PasserByVol:	0	0	0	0	0	0	0	0	0	0	0	0
Initial Fut:	118	450	110	10	275	27	26	92	23	119	412	37
User Adj:	1.00	1.00	1.00	1.00	1.00	1.00	1.00	1.00	1.00	1.00	1.00	1.00
PHF Adj:	1.00	1.00	1.00	1.00	1.00	1.00	1.00	1.00	1.00	1.00	1.00	1.00
PHF Volume:	118	450	110	10	275	27	26	92	23	119	412	37
Reduct Vol:	0	0	0	0	0	0	0	0	0	0	0	0
Reduced Vol:	118	450	110	10	275	27	26	92	23	119	412	37
PCE Adj:	1.00	1.00	1.00	1.00	1.00	1.00	1.00	1.00	1.00	1.00	1.00	1.00
MLF Adj:	1.00	1.00	1.00	1.00	1.00	1.00	1.00	1.00	1.00	1.00	1.00	1.00
FinalVolume:	118	450	110	10	275	27	26	92	23	119	412	37
Saturation Flow Module:												
Sat/Lane:	1900	1900	1900	1900	1900	1900	1900	1900	1900	1900	1900	1900
Adjustment:	0.92	0.92	0.92	0.92	0.92	0.92	0.95	0.95	0.92	0.95	0.95	0.92
Lanes:	0.17	0.67	0.16	0.03	0.88	0.09	0.22	0.78	1.00	0.22	0.78	1.00
Final Sat.:	305	1162	284	56	1542	151	397	1403	1750	403	1397	1750
Capacity Analysis Module:												
Vol/Sat:	0.39	0.39	0.39	0.18	0.18	0.18	0.07	0.07	0.01	0.30	0.30	0.02
Crit Moves:	****											
Green Time:	44.8	44.8	44.8	44.8	44.8	44.8	34.2	34.2	34.2	34.2	34.2	34.2
Volume/Cap:	0.73	0.73	0.73	0.34	0.34	0.34	0.16	0.16	0.03	0.73	0.73	0.05
Delay/Veh:	18.6	18.6	18.6	11.8	11.8	11.8	16.4	16.4	15.4	25.5	25.5	15.6
User DelAdj:	1.00	1.00	1.00	1.00	1.00	1.00	1.00	1.00	1.00	1.00	1.00	1.00
AdjDel/Veh:	18.6	18.6	18.6	11.8	11.8	11.8	16.4	16.4	15.4	25.5	25.5	15.6
LOS by Move:	B	B	B	B	B	B	B	B	B	C	C	B
HCM2k95thQ:	26	26	26	10	10	10	4	4	1	23	23	1

Note: Queue reported is the number of cars per lane.

BART Phase II Extension Project

Level Of Service Computation Report
 2000 HCM Operations (Future Volume Alternative)
 PM - 2035 No Project Conditions

Intersection #3762: SAN ANTONIO/24TH

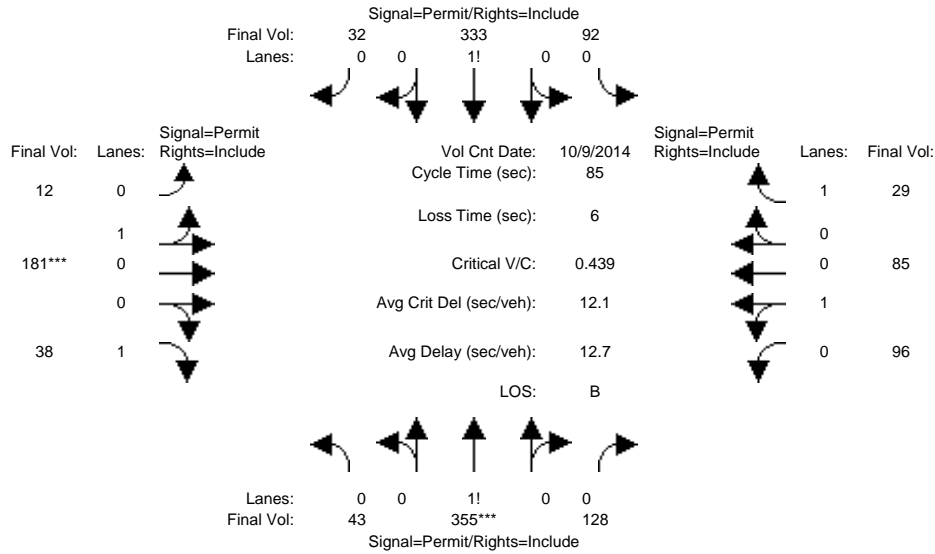

Approach:	North Bound			South Bound			East Bound			West Bound		
	L	T	R	L	T	R	L	T	R	L	T	R
Min. Green:	10	10	10	10	10	10	10	10	10	10	10	10
Y+R:	4.0	4.0	4.0	4.0	4.0	4.0	4.0	4.0	4.0	4.0	4.0	4.0
Volume Module: >> Count Date: 9 Oct 2014 <<												
Base Vol:	43	355	128	92	333	32	12	181	38	96	85	29
Growth Adj:	1.00	1.00	1.00	1.00	1.00	1.00	1.00	1.00	1.00	1.00	1.00	1.00
Initial Bse:	43	355	128	92	333	32	12	181	38	96	85	29
Added Vol:	0	0	0	0	0	0	0	0	0	0	0	0
PasserByVol:	0	0	0	0	0	0	0	0	0	0	0	0
Initial Fut:	43	355	128	92	333	32	12	181	38	96	85	29
User Adj:	1.00	1.00	1.00	1.00	1.00	1.00	1.00	1.00	1.00	1.00	1.00	1.00
PHF Adj:	1.00	1.00	1.00	1.00	1.00	1.00	1.00	1.00	1.00	1.00	1.00	1.00
PHF Volume:	43	355	128	92	333	32	12	181	38	96	85	29
Reduct Vol:	0	0	0	0	0	0	0	0	0	0	0	0
Reduced Vol:	43	355	128	92	333	32	12	181	38	96	85	29
PCE Adj:	1.00	1.00	1.00	1.00	1.00	1.00	1.00	1.00	1.00	1.00	1.00	1.00
MLF Adj:	1.00	1.00	1.00	1.00	1.00	1.00	1.00	1.00	1.00	1.00	1.00	1.00
FinalVolume:	43	355	128	92	333	32	12	181	38	96	85	29
Saturation Flow Module:												
Sat/Lane:	1900	1900	1900	1900	1900	1900	1900	1900	1900	1900	1900	1900
Adjustment:	0.92	0.92	0.92	0.92	0.92	0.92	0.95	0.95	0.92	0.95	0.95	0.92
Lanes:	0.08	0.68	0.24	0.20	0.73	0.07	0.06	0.94	1.00	0.53	0.47	1.00
Final Sat.:	143	1181	426	352	1275	123	112	1688	1750	955	845	1750
Capacity Analysis Module:												
Vol/Sat:	0.30	0.30	0.30	0.26	0.26	0.26	0.11	0.11	0.02	0.10	0.10	0.02
Crit Moves:	****						****					
Green Time:	58.2	58.2	58.2	58.2	58.2	58.2	20.8	20.8	20.8	20.8	20.8	20.8
Volume/Cap:	0.44	0.44	0.44	0.38	0.38	0.38	0.44	0.44	0.09	0.41	0.41	0.07
Delay/Veh:	6.3	6.3	6.3	5.9	5.9	5.9	27.9	27.9	24.9	27.6	27.6	24.7
User DelAdj:	1.00	1.00	1.00	1.00	1.00	1.00	1.00	1.00	1.00	1.00	1.00	1.00
AdjDel/Veh:	6.3	6.3	6.3	5.9	5.9	5.9	27.9	27.9	24.9	27.6	27.6	24.7
LOS by Move:	A	A	A	A	A	A	C	C	C	C	C	C
HCM2k95thQ:	13	13	13	11	11	11	9	9	2	8	8	1

Note: Queue reported is the number of cars per lane.

BART Phase II Extension Project

Level Of Service Computation Report
 2000 HCM Operations (Future Volume Alternative)
 AM - 2035 No Project Conditions

Intersection #3783: SANTA CLARA/17TH

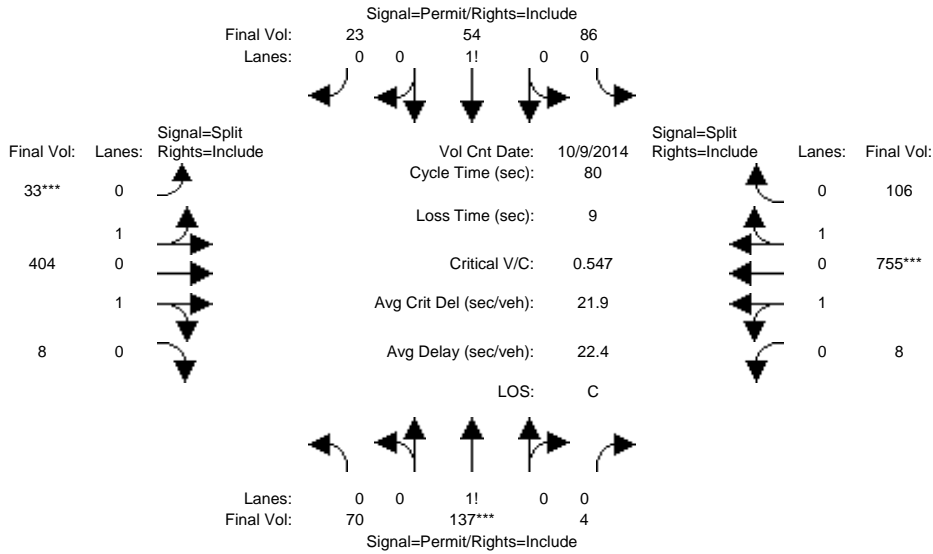

Approach:	North Bound			South Bound			East Bound			West Bound		
	L	T	R	L	T	R	L	T	R	L	T	R
Min. Green:	10	10	10	10	10	10	10	10	10	10	10	10
Y+R:	4.0	4.0	4.0	4.0	4.0	4.0	4.0	4.0	4.0	4.0	4.0	4.0
Volume Module: >> Count Date: 9 Oct 2014 <<												
Base Vol:	70	137	4	86	54	23	33	404	8	8	755	106
Growth Adj:	1.00	1.00	1.00	1.00	1.00	1.00	1.00	1.00	1.00	1.00	1.00	1.00
Initial Bse:	70	137	4	86	54	23	33	404	8	8	755	106
Added Vol:	0	0	0	0	0	0	0	0	0	0	0	0
PasserByVol:	0	0	0	0	0	0	0	0	0	0	0	0
Initial Fut:	70	137	4	86	54	23	33	404	8	8	755	106
User Adj:	1.00	1.00	1.00	1.00	1.00	1.00	1.00	1.00	1.00	1.00	1.00	1.00
PHF Adj:	1.00	1.00	1.00	1.00	1.00	1.00	1.00	1.00	1.00	1.00	1.00	1.00
PHF Volume:	70	137	4	86	54	23	33	404	8	8	755	106
Reduct Vol:	0	0	0	0	0	0	0	0	0	0	0	0
Reduced Vol:	70	137	4	86	54	23	33	404	8	8	755	106
PCE Adj:	1.00	1.00	1.00	1.00	1.00	1.00	1.00	1.00	1.00	1.00	1.00	1.00
MLF Adj:	1.00	1.00	1.00	1.00	1.00	1.00	1.00	1.00	1.00	1.00	1.00	1.00
FinalVolume:	70	137	4	86	54	23	33	404	8	8	755	106
Saturation Flow Module:												
Sat/Lane:	1900	1900	1900	1900	1900	1900	1900	1900	1900	1900	1900	1900
Adjustment:	0.92	0.92	0.92	0.92	0.92	0.92	0.95	0.95	0.95	0.95	0.95	0.95
Lanes:	0.33	0.65	0.02	0.53	0.33	0.14	0.15	1.81	0.04	0.02	1.74	0.24
Final Sat.:	581	1136	33	923	580	247	267	3268	65	33	3128	439
Capacity Analysis Module:												
Vol/Sat:	0.12	0.12	0.12	0.09	0.09	0.09	0.12	0.12	0.12	0.24	0.24	0.24
Crit Moves:	****			****			****			****		
Green Time:	17.6	17.6	17.6	17.6	17.6	17.6	18.1	18.1	18.1	35.3	35.3	35.3
Volume/Cap:	0.55	0.55	0.55	0.42	0.42	0.42	0.55	0.55	0.55	0.55	0.55	0.55
Delay/Veh:	29.3	29.3	29.3	27.6	27.6	27.6	28.1	28.1	28.1	16.9	16.9	16.9
User DelAdj:	1.00	1.00	1.00	1.00	1.00	1.00	1.00	1.00	1.00	1.00	1.00	1.00
AdjDel/Veh:	29.3	29.3	29.3	27.6	27.6	27.6	28.1	28.1	28.1	16.9	16.9	16.9
LOS by Move:	C	C	C	C	C	C	C	C	C	B	B	B
HCM2k95thQ:	11	11	11	8	8	8	11	11	11	15	15	15

Note: Queue reported is the number of cars per lane.

BART Phase II Extension Project

Level Of Service Computation Report
 2000 HCM Operations (Future Volume Alternative)
 PM - 2035 No Project Conditions

Intersection #3783: SANTA CLARA/17TH

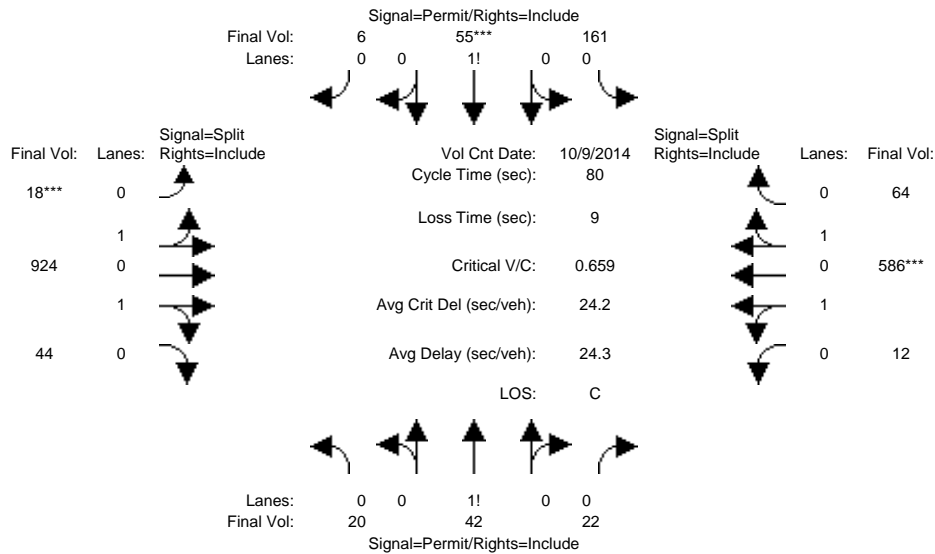

Approach:	North Bound			South Bound			East Bound			West Bound		
Movement:	L	T	R	L	T	R	L	T	R	L	T	R
Min. Green:	10	10	10	10	10	10	10	10	10	10	10	10
Y+R:	4.0	4.0	4.0	4.0	4.0	4.0	4.0	4.0	4.0	4.0	4.0	4.0
Volume Module: >> Count Date: 9 Oct 2014 <<												
Base Vol:	20	42	22	161	55	6	18	924	44	12	586	64
Growth Adj:	1.00	1.00	1.00	1.00	1.00	1.00	1.00	1.00	1.00	1.00	1.00	1.00
Initial Bse:	20	42	22	161	55	6	18	924	44	12	586	64
Added Vol:	0	0	0	0	0	0	0	0	0	0	0	0
PasserByVol:	0	0	0	0	0	0	0	0	0	0	0	0
Initial Fut:	20	42	22	161	55	6	18	924	44	12	586	64
User Adj:	1.00	1.00	1.00	1.00	1.00	1.00	1.00	1.00	1.00	1.00	1.00	1.00
PHF Adj:	1.00	1.00	1.00	1.00	1.00	1.00	1.00	1.00	1.00	1.00	1.00	1.00
PHF Volume:	20	42	22	161	55	6	18	924	44	12	586	64
Reduct Vol:	0	0	0	0	0	0	0	0	0	0	0	0
Reduced Vol:	20	42	22	161	55	6	18	924	44	12	586	64
PCE Adj:	1.00	1.00	1.00	1.00	1.00	1.00	1.00	1.00	1.00	1.00	1.00	1.00
MLF Adj:	1.00	1.00	1.00	1.00	1.00	1.00	1.00	1.00	1.00	1.00	1.00	1.00
FinalVolume:	20	42	22	161	55	6	18	924	44	12	586	64
Saturation Flow Module:												
Sat/Lane:	1900	1900	1900	1900	1900	1900	1900	1900	1900	1900	1900	1900
Adjustment:	0.92	0.92	0.92	0.92	0.92	0.92	0.95	0.95	0.95	0.95	0.95	0.95
Lanes:	0.24	0.50	0.26	0.72	0.25	0.03	0.04	1.87	0.09	0.04	1.77	0.19
Final Sat.:	417	875	458	1269	434	47	66	3374	161	65	3187	348
Capacity Analysis Module:												
Vol/Sat:	0.05	0.05	0.05	0.13	0.13	0.13	0.27	0.27	0.27	0.18	0.18	0.18
Crit Moves:				****				****				****
Green Time:	15.4	15.4	15.4	15.4	15.4	15.4	33.3	33.3	33.3	22.3	22.3	22.3
Volume/Cap:	0.25	0.25	0.25	0.66	0.66	0.66	0.66	0.66	0.66	0.66	0.66	0.66
Delay/Veh:	27.8	27.8	27.8	34.6	34.6	34.6	19.9	19.9	19.9	27.1	27.1	27.1
User DelAdj:	1.00	1.00	1.00	1.00	1.00	1.00	1.00	1.00	1.00	1.00	1.00	1.00
AdjDel/Veh:	27.8	27.8	27.8	34.6	34.6	34.6	19.9	19.9	19.9	27.1	27.1	27.1
LOS by Move:	C	C	C	C	C	C	B	B	B	C	C	C
HCM2k95thQ:	4	4	4	13	13	13	20	20	20	15	15	15

Note: Queue reported is the number of cars per lane.

BART Phase II Extension Project

Level Of Service Computation Report
 2000 HCM Operations (Future Volume Alternative)
 AM - 2035 No Project Conditions

Intersection #3788: SANTA CLARA/28TH

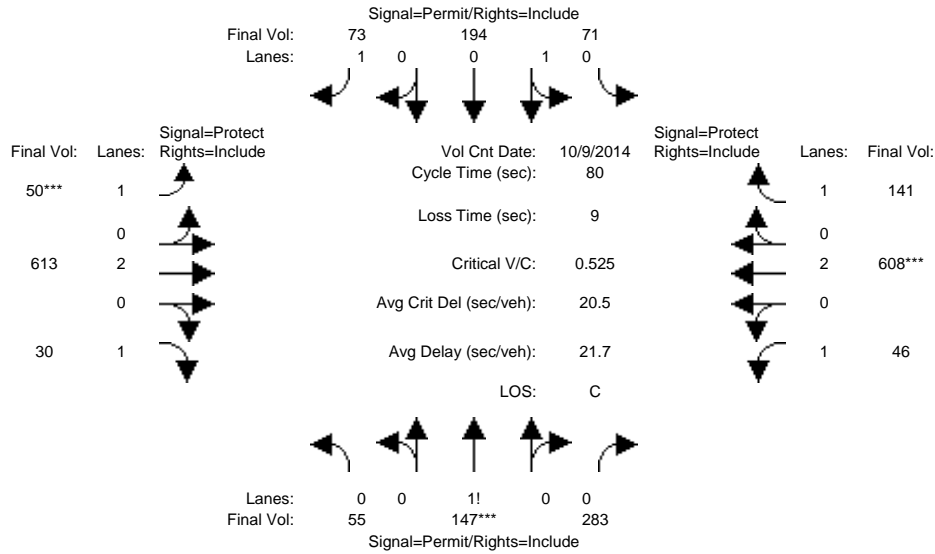

Approach:	North Bound			South Bound			East Bound			West Bound		
	L	T	R	L	T	R	L	T	R	L	T	R
Min. Green:	10	10	10	10	10	10	7	10	10	7	10	10
Y+R:	4.0	4.0	4.0	4.0	4.0	4.0	4.0	4.0	4.0	4.0	4.0	4.0
Volume Module: >> Count Date: 9 Oct 2014 <<												
Base Vol:	55	147	283	71	194	73	50	613	30	46	608	141
Growth Adj:	1.00	1.00	1.00	1.00	1.00	1.00	1.00	1.00	1.00	1.00	1.00	1.00
Initial Bse:	55	147	283	71	194	73	50	613	30	46	608	141
Added Vol:	0	0	0	0	0	0	0	0	0	0	0	0
PasserByVol:	0	0	0	0	0	0	0	0	0	0	0	0
Initial Fut:	55	147	283	71	194	73	50	613	30	46	608	141
User Adj:	1.00	1.00	1.00	1.00	1.00	1.00	1.00	1.00	1.00	1.00	1.00	1.00
PHF Adj:	1.00	1.00	1.00	1.00	1.00	1.00	1.00	1.00	1.00	1.00	1.00	1.00
PHF Volume:	55	147	283	71	194	73	50	613	30	46	608	141
Reduct Vol:	0	0	0	0	0	0	0	0	0	0	0	0
Reduced Vol:	55	147	283	71	194	73	50	613	30	46	608	141
PCE Adj:	1.00	1.00	1.00	1.00	1.00	1.00	1.00	1.00	1.00	1.00	1.00	1.00
MLF Adj:	1.00	1.00	1.00	1.00	1.00	1.00	1.00	1.00	1.00	1.00	1.00	1.00
FinalVolume:	55	147	283	71	194	73	50	613	30	46	608	141
Saturation Flow Module:												
Sat/Lane:	1900	1900	1900	1900	1900	1900	1900	1900	1900	1900	1900	1900
Adjustment:	0.92	0.92	0.92	0.95	0.95	0.92	0.92	1.00	0.92	0.92	1.00	0.92
Lanes:	0.11	0.30	0.59	0.27	0.73	1.00	1.00	2.00	1.00	1.00	2.00	1.00
Final Sat.:	198	530	1021	482	1318	1750	1750	3800	1750	1750	3800	1750
Capacity Analysis Module:												
Vol/Sat:	0.28	0.28	0.28	0.15	0.15	0.04	0.03	0.16	0.02	0.03	0.16	0.08
Crit Moves:	****						****			****		
Green Time:	40.6	40.6	40.6	40.6	40.6	40.6	7.0	19.7	19.7	10.7	23.4	23.4
Volume/Cap:	0.55	0.55	0.55	0.29	0.29	0.08	0.33	0.65	0.07	0.20	0.55	0.28
Delay/Veh:	14.2	14.2	14.2	11.6	11.6	10.2	35.5	28.8	23.2	31.2	24.4	22.1
User DelAdj:	1.00	1.00	1.00	1.00	1.00	1.00	1.00	1.00	1.00	1.00	1.00	1.00
AdjDel/Veh:	14.2	14.2	14.2	11.6	11.6	10.2	35.5	28.8	23.2	31.2	24.4	22.1
LOS by Move:	B	B	B	B	B	B	D	C	C	C	C	C
HCM2k95thQ:	16	16	16	8	8	2	3	13	1	2	12	6

Note: Queue reported is the number of cars per lane.

BART Phase II Extension Project

Level Of Service Computation Report
 2000 HCM Operations (Future Volume Alternative)
 PM - 2035 No Project Conditions

Intersection #3788: SANTA CLARA/28TH

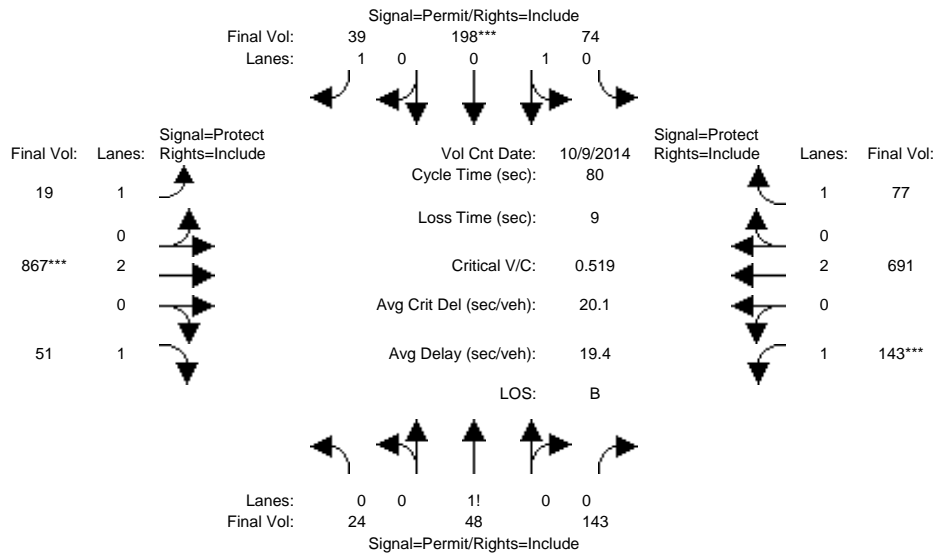

Approach:	North Bound			South Bound			East Bound			West Bound		
	L	T	R	L	T	R	L	T	R	L	T	R
Min. Green:	10	10	10	10	10	10	7	10	10	7	10	10
Y+R:	4.0	4.0	4.0	4.0	4.0	4.0	4.0	4.0	4.0	4.0	4.0	4.0
Volume Module: >> Count Date: 9 Oct 2014 <<												
Base Vol:	24	48	143	74	198	39	19	867	51	143	691	77
Growth Adj:	1.00	1.00	1.00	1.00	1.00	1.00	1.00	1.00	1.00	1.00	1.00	1.00
Initial Bse:	24	48	143	74	198	39	19	867	51	143	691	77
Added Vol:	0	0	0	0	0	0	0	0	0	0	0	0
PasserByVol:	0	0	0	0	0	0	0	0	0	0	0	0
Initial Fut:	24	48	143	74	198	39	19	867	51	143	691	77
User Adj:	1.00	1.00	1.00	1.00	1.00	1.00	1.00	1.00	1.00	1.00	1.00	1.00
PHF Adj:	1.00	1.00	1.00	1.00	1.00	1.00	1.00	1.00	1.00	1.00	1.00	1.00
PHF Volume:	24	48	143	74	198	39	19	867	51	143	691	77
Reduct Vol:	0	0	0	0	0	0	0	0	0	0	0	0
Reduced Vol:	24	48	143	74	198	39	19	867	51	143	691	77
PCE Adj:	1.00	1.00	1.00	1.00	1.00	1.00	1.00	1.00	1.00	1.00	1.00	1.00
MLF Adj:	1.00	1.00	1.00	1.00	1.00	1.00	1.00	1.00	1.00	1.00	1.00	1.00
FinalVolume:	24	48	143	74	198	39	19	867	51	143	691	77
Saturation Flow Module:												
Sat/Lane:	1900	1900	1900	1900	1900	1900	1900	1900	1900	1900	1900	1900
Adjustment:	0.92	0.92	0.92	0.95	0.95	0.92	0.92	1.00	0.92	0.92	1.00	0.92
Lanes:	0.11	0.22	0.67	0.27	0.73	1.00	1.00	2.00	1.00	1.00	2.00	1.00
Final Sat.:	195	391	1164	490	1310	1750	1750	3800	1750	1750	3800	1750
Capacity Analysis Module:												
Vol/Sat:	0.12	0.12	0.12	0.15	0.15	0.02	0.01	0.23	0.03	0.08	0.18	0.04
Crit Moves:				****			****			****		
Green Time:	23.3	23.3	23.3	23.3	23.3	23.3	15.5	35.1	35.1	12.6	32.2	32.2
Volume/Cap:	0.42	0.42	0.42	0.52	0.52	0.08	0.06	0.52	0.07	0.52	0.45	0.11
Delay/Veh:	23.5	23.5	23.5	24.6	24.6	20.6	26.4	16.6	13.0	32.7	17.7	15.0
User DelAdj:	1.00	1.00	1.00	1.00	1.00	1.00	1.00	1.00	1.00	1.00	1.00	1.00
AdjDel/Veh:	23.5	23.5	23.5	24.6	24.6	20.6	26.4	16.6	13.0	32.7	17.7	15.0
LOS by Move:	C	C	C	C	C	C	C	B	B	C	B	B
HCM2k95thQ:	9	9	9	12	12	2	1	14	2	7	12	3

Note: Queue reported is the number of cars per lane.

BART Phase II Extension Project

Level Of Service Computation Report
 2000 HCM Operations (Future Volume Alternative)
 AM - 2035 No Project Conditions

Intersection #3789: SANTA CLARA/21ST

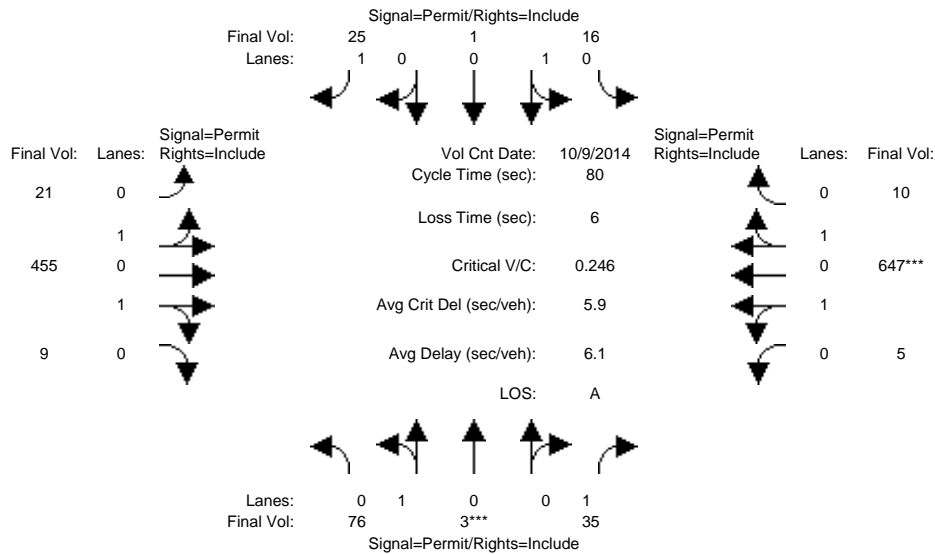

Approach:	North Bound			South Bound			East Bound			West Bound		
	L	T	R	L	T	R	L	T	R	L	T	R
Min. Green:	10	10	10	10	10	10	10	10	10	10	10	10
Y+R:	4.0	4.0	4.0	4.0	4.0	4.0	4.0	4.0	4.0	4.0	4.0	4.0
Volume Module: >> Count Date: 9 Oct 2014 <<												
Base Vol:	76	3	35	16	1	25	21	455	9	5	647	10
Growth Adj:	1.00	1.00	1.00	1.00	1.00	1.00	1.00	1.00	1.00	1.00	1.00	1.00
Initial Bse:	76	3	35	16	1	25	21	455	9	5	647	10
Added Vol:	0	0	0	0	0	0	0	0	0	0	0	0
PasserByVol:	0	0	0	0	0	0	0	0	0	0	0	0
Initial Fut:	76	3	35	16	1	25	21	455	9	5	647	10
User Adj:	1.00	1.00	1.00	1.00	1.00	1.00	1.00	1.00	1.00	1.00	1.00	1.00
PHF Adj:	1.00	1.00	1.00	1.00	1.00	1.00	1.00	1.00	1.00	1.00	1.00	1.00
PHF Volume:	76	3	35	16	1	25	21	455	9	5	647	10
Reduct Vol:	0	0	0	0	0	0	0	0	0	0	0	0
Reduced Vol:	76	3	35	16	1	25	21	455	9	5	647	10
PCE Adj:	1.00	1.00	1.00	1.00	1.00	1.00	1.00	1.00	1.00	1.00	1.00	1.00
MLF Adj:	1.00	1.00	1.00	1.00	1.00	1.00	1.00	1.00	1.00	1.00	1.00	1.00
FinalVolume:	76	3	35	16	1	25	21	455	9	5	647	10
Saturation Flow Module:												
Sat/Lane:	1900	1900	1900	1900	1900	1900	1900	1900	1900	1900	1900	1900
Adjustment:	0.95	0.95	0.92	0.95	0.95	0.92	0.95	0.95	0.95	0.95	0.95	0.95
Lanes:	0.96	0.04	1.00	0.94	0.06	1.00	0.09	1.87	0.04	0.02	1.95	0.03
Final Sat.:	1732	68	1750	1694	106	1750	156	3377	67	27	3518	54
Capacity Analysis Module:												
Vol/Sat:	0.04	0.04	0.02	0.01	0.01	0.01	0.13	0.13	0.13	0.18	0.18	0.18
Crit Moves:	****											
Green Time:	14.3	14.3	14.3	14.3	14.3	14.3	59.7	59.7	59.7	59.7	59.7	59.7
Volume/Cap:	0.25	0.25	0.11	0.05	0.05	0.08	0.18	0.18	0.18	0.25	0.25	0.25
Delay/Veh:	28.7	28.7	27.7	27.3	27.3	27.5	3.0	3.0	3.0	3.2	3.2	3.2
User DelAdj:	1.00	1.00	1.00	1.00	1.00	1.00	1.00	1.00	1.00	1.00	1.00	1.00
AdjDel/Veh:	28.7	28.7	27.7	27.3	27.3	27.5	3.0	3.0	3.0	3.2	3.2	3.2
LOS by Move:	C	C	C	C	C	C	A	A	A	A	A	A
HCM2k95thQ:	4	4	2	1	1	1	4	4	4	5	5	5

Note: Queue reported is the number of cars per lane.

BART Phase II Extension Project

Level Of Service Computation Report
2000 HCM Operations (Future Volume Alternative)
PM - 2035 No Project Conditions

Intersection #3789: SANTA CLARA/21ST

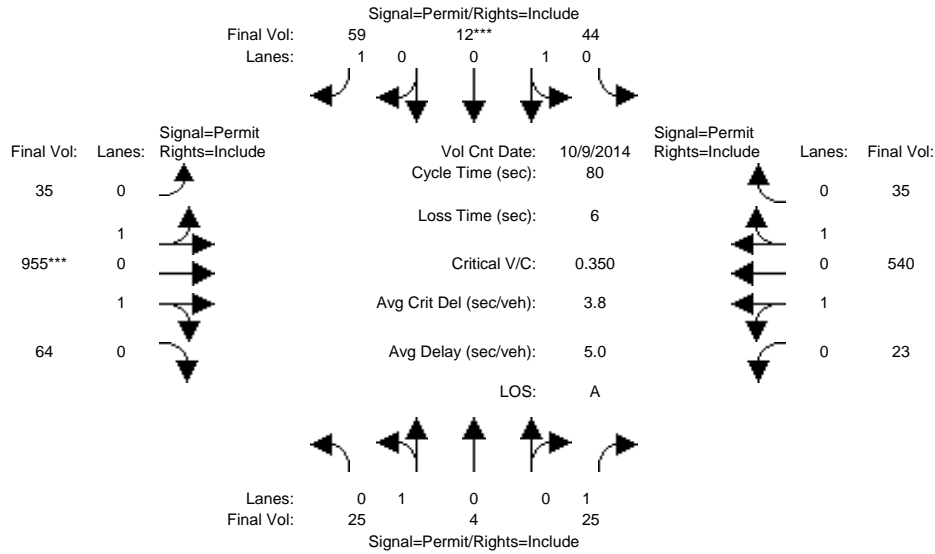

Approach:	North Bound			South Bound			East Bound			West Bound		
Movement:	L	T	R	L	T	R	L	T	R	L	T	R
Min. Green:	10	10	10	10	10	10	10	10	10	10	10	10
Y+R:	4.0	4.0	4.0	4.0	4.0	4.0	4.0	4.0	4.0	4.0	4.0	4.0
Volume Module: >> Count Date: 9 Oct 2014 <<												
Base Vol:	25	4	25	44	12	59	35	955	64	23	540	35
Growth Adj:	1.00	1.00	1.00	1.00	1.00	1.00	1.00	1.00	1.00	1.00	1.00	1.00
Initial Bse:	25	4	25	44	12	59	35	955	64	23	540	35
Added Vol:	0	0	0	0	0	0	0	0	0	0	0	0
PasserByVol:	0	0	0	0	0	0	0	0	0	0	0	0
Initial Fut:	25	4	25	44	12	59	35	955	64	23	540	35
User Adj:	1.00	1.00	1.00	1.00	1.00	1.00	1.00	1.00	1.00	1.00	1.00	1.00
PHF Adj:	1.00	1.00	1.00	1.00	1.00	1.00	1.00	1.00	1.00	1.00	1.00	1.00
PHF Volume:	25	4	25	44	12	59	35	955	64	23	540	35
Reduct Vol:	0	0	0	0	0	0	0	0	0	0	0	0
Reduced Vol:	25	4	25	44	12	59	35	955	64	23	540	35
PCE Adj:	1.00	1.00	1.00	1.00	1.00	1.00	1.00	1.00	1.00	1.00	1.00	1.00
MLF Adj:	1.00	1.00	1.00	1.00	1.00	1.00	1.00	1.00	1.00	1.00	1.00	1.00
FinalVolume:	25	4	25	44	12	59	35	955	64	23	540	35
Saturation Flow Module:												
Sat/Lane:	1900	1900	1900	1900	1900	1900	1900	1900	1900	1900	1900	1900
Adjustment:	0.95	0.95	0.92	0.95	0.95	0.92	0.95	0.95	0.95	0.95	0.95	0.95
Lanes:	0.86	0.14	1.00	0.79	0.21	1.00	0.07	1.81	0.12	0.08	1.80	0.12
Final Sat.:	1552	248	1750	1414	386	1750	120	3262	219	138	3251	211
Capacity Analysis Module:												
Vol/Sat:	0.02	0.02	0.01	0.03	0.03	0.03	0.29	0.29	0.29	0.17	0.17	0.17
Crit Moves:				****			****					
Green Time:	10.0	10.0	10.0	10.0	10.0	10.0	64.0	64.0	64.0	64.0	64.0	64.0
Volume/Cap:	0.13	0.13	0.11	0.25	0.25	0.27	0.37	0.37	0.37	0.21	0.21	0.21
Delay/Veh:	31.4	31.4	31.3	32.2	32.2	32.4	2.3	2.3	2.3	2.0	2.0	2.0
User DelAdj:	1.00	1.00	1.00	1.00	1.00	1.00	1.00	1.00	1.00	1.00	1.00	1.00
AdjDel/Veh:	31.4	31.4	31.3	32.2	32.2	32.4	2.3	2.3	2.3	2.0	2.0	2.0
LOS by Move:	C	C	C	C	C	C	A	A	A	A	A	A
HCM2k95thQ:	2	2	1	3	3	3	8	8	8	4	4	4

Note: Queue reported is the number of cars per lane.

BART Phase II Extension Project

Level Of Service Computation Report
2000 HCM Operations (Future Volume Alternative)
AM - 2035 No Project Conditions

Intersection #3790: SANTA CLARA/24TH

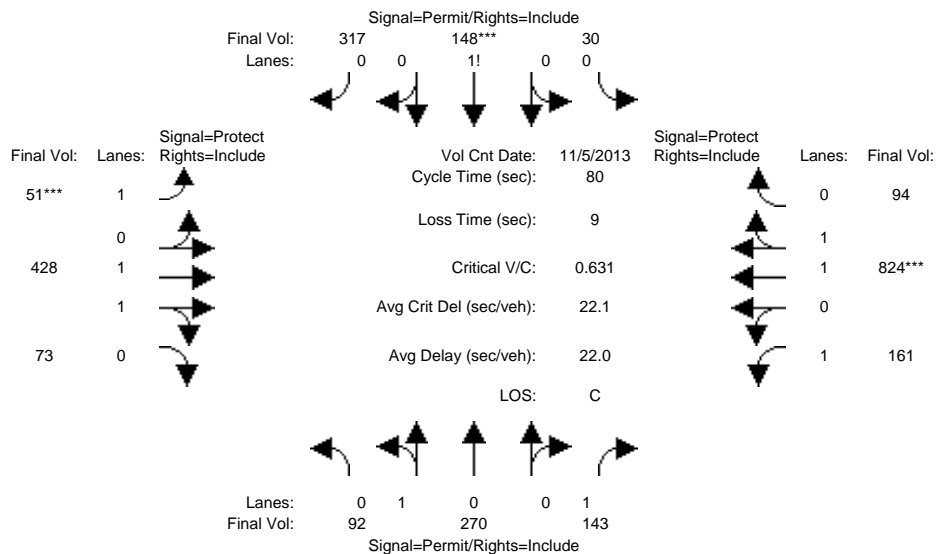

Approach:	North Bound			South Bound			East Bound			West Bound		
Movement:	L	T	R	L	T	R	L	T	R	L	T	R
Min. Green:	10	10	10	10	10	10	7	10	10	7	10	10
Y+R:	4.0	4.0	4.0	4.0	4.0	4.0	4.0	4.0	4.0	4.0	4.0	4.0
Volume Module: >> Count Date: 5 Nov 2013 <<												
Base Vol:	92	270	143	30	148	317	51	428	73	161	824	94
Growth Adj:	1.00	1.00	1.00	1.00	1.00	1.00	1.00	1.00	1.00	1.00	1.00	1.00
Initial Bse:	92	270	143	30	148	317	51	428	73	161	824	94
Added Vol:	0	0	0	0	0	0	0	0	0	0	0	0
PasserByVol:	0	0	0	0	0	0	0	0	0	0	0	0
Initial Fut:	92	270	143	30	148	317	51	428	73	161	824	94
User Adj:	1.00	1.00	1.00	1.00	1.00	1.00	1.00	1.00	1.00	1.00	1.00	1.00
PHF Adj:	1.00	1.00	1.00	1.00	1.00	1.00	1.00	1.00	1.00	1.00	1.00	1.00
PHF Volume:	92	270	143	30	148	317	51	428	73	161	824	94
Reduct Vol:	0	0	0	0	0	0	0	0	0	0	0	0
Reduced Vol:	92	270	143	30	148	317	51	428	73	161	824	94
PCE Adj:	1.00	1.00	1.00	1.00	1.00	1.00	1.00	1.00	1.00	1.00	1.00	1.00
MLF Adj:	1.00	1.00	1.00	1.00	1.00	1.00	1.00	1.00	1.00	1.00	1.00	1.00
FinalVolume:	92	270	143	30	148	317	51	428	73	161	824	94
Saturation Flow Module:												
Sat/Lane:	1900	1900	1900	1900	1900	1900	1900	1900	1900	1900	1900	1900
Adjustment:	0.95	0.95	0.92	0.92	0.92	0.92	0.92	0.98	0.95	0.92	0.98	0.95
Lanes:	0.25	0.75	1.00	0.06	0.30	0.64	1.00	1.70	0.30	1.00	1.79	0.21
Final Sat.:	457	1343	1750	106	523	1121	1750	3160	539	1750	3321	379
Capacity Analysis Module:												
Vol/Sat:	0.20	0.20	0.08	0.28	0.28	0.28	0.03	0.14	0.14	0.09	0.25	0.25
Crit Moves:				****			****			****		
Green Time:	34.1	34.1	34.1	34.1	34.1	34.1	7.0	22.0	22.0	14.9	29.9	29.9
Volume/Cap:	0.47	0.47	0.19	0.66	0.66	0.66	0.33	0.49	0.49	0.49	0.66	0.66
Delay/Veh:	16.9	16.9	14.5	20.6	20.6	20.6	35.6	24.7	24.7	30.3	22.1	22.1
User DelAdj:	1.00	1.00	1.00	1.00	1.00	1.00	1.00	1.00	1.00	1.00	1.00	1.00
AdjDel/Veh:	16.9	16.9	14.5	20.6	20.6	20.6	35.6	24.7	24.7	30.3	22.1	22.1
LOS by Move:	B	B	B	C	C	C	D	C	C	C	C	C
HCM2k95thQ:	13	13	5	21	21	21	3	10	10	8	18	18

Note: Queue reported is the number of cars per lane.

BART Phase II Extension Project

Level Of Service Computation Report
2000 HCM Operations (Future Volume Alternative)
PM - 2035 No Project Conditions

Intersection #3790: SANTA CLARA/24TH

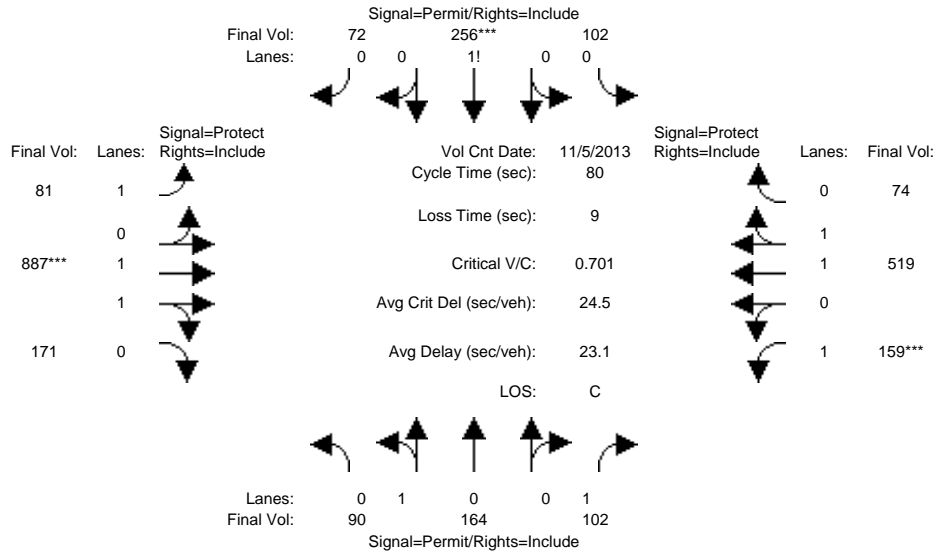

Approach:	North Bound			South Bound			East Bound			West Bound		
Movement:	L	T	R	L	T	R	L	T	R	L	T	R
Min. Green:	10	10	10	10	10	10	7	10	10	7	10	10
Y+R:	4.0	4.0	4.0	4.0	4.0	4.0	4.0	4.0	4.0	4.0	4.0	4.0
Volume Module: >> Count Date: 5 Nov 2013 <<												
Base Vol:	90	164	102	102	256	72	81	887	171	159	519	74
Growth Adj:	1.00	1.00	1.00	1.00	1.00	1.00	1.00	1.00	1.00	1.00	1.00	1.00
Initial Bse:	90	164	102	102	256	72	81	887	171	159	519	74
Added Vol:	0	0	0	0	0	0	0	0	0	0	0	0
PasserByVol:	0	0	0	0	0	0	0	0	0	0	0	0
Initial Fut:	90	164	102	102	256	72	81	887	171	159	519	74
User Adj:	1.00	1.00	1.00	1.00	1.00	1.00	1.00	1.00	1.00	1.00	1.00	1.00
PHF Adj:	1.00	1.00	1.00	1.00	1.00	1.00	1.00	1.00	1.00	1.00	1.00	1.00
PHF Volume:	90	164	102	102	256	72	81	887	171	159	519	74
Reduct Vol:	0	0	0	0	0	0	0	0	0	0	0	0
Reduced Vol:	90	164	102	102	256	72	81	887	171	159	519	74
PCE Adj:	1.00	1.00	1.00	1.00	1.00	1.00	1.00	1.00	1.00	1.00	1.00	1.00
MLF Adj:	1.00	1.00	1.00	1.00	1.00	1.00	1.00	1.00	1.00	1.00	1.00	1.00
FinalVolume:	90	164	102	102	256	72	81	887	171	159	519	74
Saturation Flow Module:												
Sat/Lane:	1900	1900	1900	1900	1900	1900	1900	1900	1900	1900	1900	1900
Adjustment:	0.95	0.95	0.92	0.92	0.92	0.92	0.92	0.98	0.95	0.92	0.98	0.95
Lanes:	0.35	0.65	1.00	0.24	0.59	0.17	1.00	1.67	0.33	1.00	1.74	0.26
Final Sat.:	638	1162	1750	415	1042	293	1750	3102	598	1750	3238	462
Capacity Analysis Module:												
Vol/Sat:	0.14	0.14	0.06	0.25	0.25	0.25	0.05	0.29	0.29	0.09	0.16	0.16
Crit Moves:				****			****			****		
Green Time:	28.0	28.0	28.0	28.0	28.0	28.0	15.2	32.6	32.6	10.4	27.8	27.8
Volume/Cap:	0.40	0.40	0.17	0.70	0.70	0.70	0.24	0.70	0.70	0.70	0.46	0.46
Delay/Veh:	20.1	20.1	18.1	26.0	26.0	26.0	27.9	21.2	21.2	42.8	20.5	20.5
User DelAdj:	1.00	1.00	1.00	1.00	1.00	1.00	1.00	1.00	1.00	1.00	1.00	1.00
AdjDel/Veh:	20.1	20.1	18.1	26.0	26.0	26.0	27.9	21.2	21.2	42.8	20.5	20.5
LOS by Move:	C	C	B	C	C	C	C	C	C	D	C	C
HCM2k95thQ:	9	9	4	20	20	20	4	20	20	8	11	11

Note: Queue reported is the number of cars per lane.

BART Phase II Extension Project

Level Of Service Computation Report
 2000 HCM Operations (Future Volume Alternative)
 AM - 2035 No Project Conditions

Intersection #3832: 24TH/WILLIAM

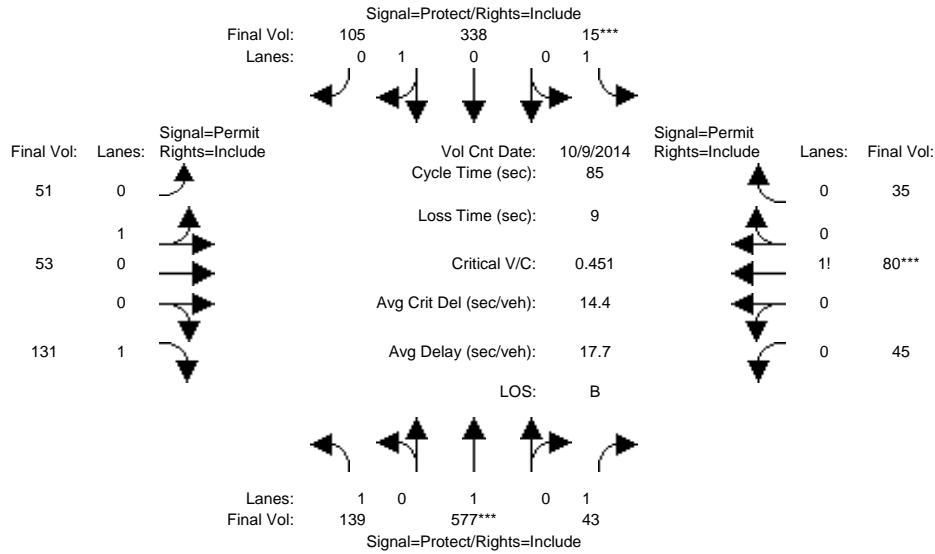

Approach:	North Bound			South Bound			East Bound			West Bound		
	L	T	R	L	T	R	L	T	R	L	T	R
Min. Green:	7	10	10	7	10	10	10	10	10	10	10	10
Y+R:	4.0	4.0	4.0	4.0	4.0	4.0	4.0	4.0	4.0	4.0	4.0	4.0
Volume Module: >> Count Date: 9 Oct 2014 <<												
Base Vol:	139	577	43	15	338	105	51	53	131	45	80	35
Growth Adj:	1.00	1.00	1.00	1.00	1.00	1.00	1.00	1.00	1.00	1.00	1.00	1.00
Initial Bse:	139	577	43	15	338	105	51	53	131	45	80	35
Added Vol:	0	0	0	0	0	0	0	0	0	0	0	0
PasserByVol:	0	0	0	0	0	0	0	0	0	0	0	0
Initial Fut:	139	577	43	15	338	105	51	53	131	45	80	35
User Adj:	1.00	1.00	1.00	1.00	1.00	1.00	1.00	1.00	1.00	1.00	1.00	1.00
PHF Adj:	1.00	1.00	1.00	1.00	1.00	1.00	1.00	1.00	1.00	1.00	1.00	1.00
PHF Volume:	139	577	43	15	338	105	51	53	131	45	80	35
Reduct Vol:	0	0	0	0	0	0	0	0	0	0	0	0
Reduced Vol:	139	577	43	15	338	105	51	53	131	45	80	35
PCE Adj:	1.00	1.00	1.00	1.00	1.00	1.00	1.00	1.00	1.00	1.00	1.00	1.00
MLF Adj:	1.00	1.00	1.00	1.00	1.00	1.00	1.00	1.00	1.00	1.00	1.00	1.00
Final Volume:	139	577	43	15	338	105	51	53	131	45	80	35
Saturation Flow Module:												
Sat/Lane:	1900	1900	1900	1900	1900	1900	1900	1900	1900	1900	1900	1900
Adjustment:	0.92	1.00	0.92	0.92	0.95	0.95	0.95	0.95	0.92	0.92	0.92	0.92
Lanes:	1.00	1.00	1.00	1.00	0.76	0.24	0.49	0.51	1.00	0.28	0.50	0.22
Final Sat.:	1750	1900	1750	1750	1373	427	883	917	1750	492	875	383
Capacity Analysis Module:												
Vol/Sat:	0.08	0.30	0.02	0.01	0.25	0.25	0.06	0.06	0.07	0.09	0.09	0.09
Crit Moves:	****			****						****		
Green Time:	15.1	53.0	53.0	7.0	45.0	45.0	16.0	16.0	16.0	16.0	16.0	16.0
Volume/Cap:	0.45	0.49	0.04	0.10	0.47	0.47	0.31	0.31	0.40	0.49	0.49	0.49
Delay/Veh:	32.3	8.9	6.2	36.4	12.9	12.9	30.3	30.3	31.1	32.0	32.0	32.0
User DelAdj:	1.00	1.00	1.00	1.00	1.00	1.00	1.00	1.00	1.00	1.00	1.00	1.00
AdjDel/Veh:	32.3	8.9	6.2	36.4	12.9	12.9	30.3	30.3	31.1	32.0	32.0	32.0
LOS by Move:	C	A	A	D	B	B	C	C	C	C	C	C
HCM2k95thQ:	7	15	1	1	14	14	5	5	7	9	9	9

Note: Queue reported is the number of cars per lane.

BART Phase II Extension Project

Level Of Service Computation Report
 2000 HCM Operations (Future Volume Alternative)
 PM - 2035 No Project Conditions

Intersection #3832: 24TH/WILLIAM

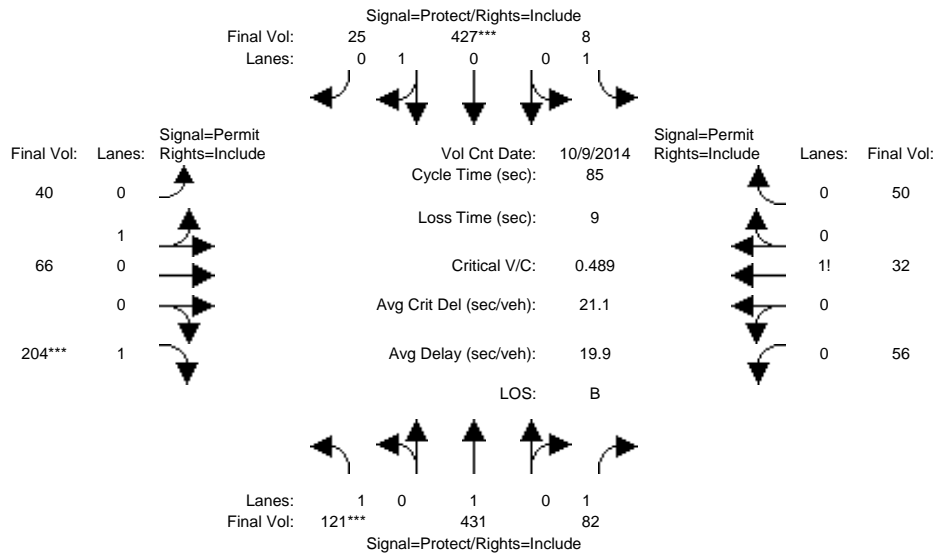

Approach:	North Bound			South Bound			East Bound			West Bound		
	L	T	R	L	T	R	L	T	R	L	T	R
Min. Green:	7	10	10	7	10	10	10	10	10	10	10	10
Y+R:	4.0	4.0	4.0	4.0	4.0	4.0	4.0	4.0	4.0	4.0	4.0	4.0
Volume Module: >> Count Date: 9 Oct 2014 <<												
Base Vol:	121	431	82	8	427	25	40	66	204	56	32	50
Growth Adj:	1.00	1.00	1.00	1.00	1.00	1.00	1.00	1.00	1.00	1.00	1.00	1.00
Initial Bse:	121	431	82	8	427	25	40	66	204	56	32	50
Added Vol:	0	0	0	0	0	0	0	0	0	0	0	0
PasserByVol:	0	0	0	0	0	0	0	0	0	0	0	0
Initial Fut:	121	431	82	8	427	25	40	66	204	56	32	50
User Adj:	1.00	1.00	1.00	1.00	1.00	1.00	1.00	1.00	1.00	1.00	1.00	1.00
PHF Adj:	1.00	1.00	1.00	1.00	1.00	1.00	1.00	1.00	1.00	1.00	1.00	1.00
PHF Volume:	121	431	82	8	427	25	40	66	204	56	32	50
Reduct Vol:	0	0	0	0	0	0	0	0	0	0	0	0
Reduced Vol:	121	431	82	8	427	25	40	66	204	56	32	50
PCE Adj:	1.00	1.00	1.00	1.00	1.00	1.00	1.00	1.00	1.00	1.00	1.00	1.00
MLF Adj:	1.00	1.00	1.00	1.00	1.00	1.00	1.00	1.00	1.00	1.00	1.00	1.00
Final Volume:	121	431	82	8	427	25	40	66	204	56	32	50
Saturation Flow Module:												
Sat/Lane:	1900	1900	1900	1900	1900	1900	1900	1900	1900	1900	1900	1900
Adjustment:	0.92	1.00	0.92	0.92	0.95	0.95	0.95	0.95	0.92	0.92	0.92	0.92
Lanes:	1.00	1.00	1.00	1.00	0.94	0.06	0.38	0.62	1.00	0.41	0.23	0.36
Final Sat.:	1750	1900	1750	1750	1700	100	679	1121	1750	710	406	634
Capacity Analysis Module:												
Vol/Sat:	0.07	0.23	0.05	0.00	0.25	0.25	0.06	0.06	0.12	0.08	0.08	0.08
Crit Moves:	****				****				****			
Green Time:	12.0	40.9	40.9	14.8	43.7	43.7	20.3	20.3	20.3	20.3	20.3	20.3
Volume/Cap:	0.49	0.47	0.10	0.03	0.49	0.49	0.25	0.25	0.49	0.33	0.33	0.33
Delay/Veh:	35.2	15.2	12.1	29.1	13.8	13.8	26.5	26.5	28.8	27.2	27.2	27.2
User DelAdj:	1.00	1.00	1.00	1.00	1.00	1.00	1.00	1.00	1.00	1.00	1.00	1.00
AdjDel/Veh:	35.2	15.2	12.1	29.1	13.8	13.8	26.5	26.5	28.8	27.2	27.2	27.2
LOS by Move:	D	B	B	C	B	B	C	C	C	C	C	C
HCM2k95thQ:	6	14	2	0	15	15	5	5	11	7	7	7

Note: Queue reported is the number of cars per lane.

BART Phase II Extension Project

Level Of Service Computation Report
 2000 HCM Operations (Future Volume Alternative)
 AM - 2035 No Project Conditions

Intersection #4005: JULIAN/28TH

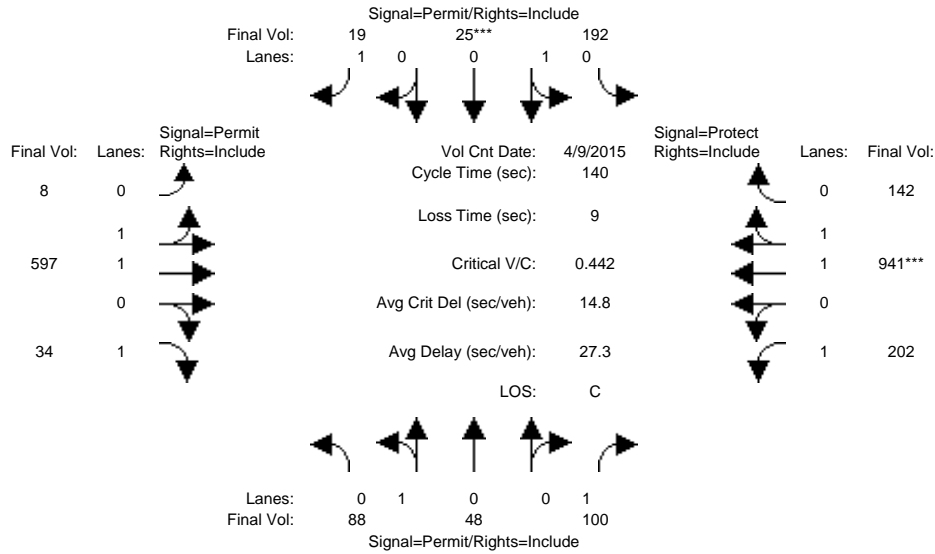

Approach:	North Bound			South Bound			East Bound			West Bound		
	L	T	R	L	T	R	L	T	R	L	T	R
Min. Green:	10	10	10	10	10	10	10	10	10	7	10	10
Y+R:	4.0	4.0	4.0	4.0	4.0	4.0	4.0	4.0	4.0	4.0	4.0	4.0

Volume Module: >> Count Date: 9 Apr 2015 <<

Base Vol:	88	48	100	192	25	19	8	597	34	202	941	142
Growth Adj:	1.00	1.00	1.00	1.00	1.00	1.00	1.00	1.00	1.00	1.00	1.00	1.00
Initial Bse:	88	48	100	192	25	19	8	597	34	202	941	142
Added Vol:	0	0	0	0	0	0	0	0	0	0	0	0
PasserByVol:	0	0	0	0	0	0	0	0	0	0	0	0
Initial Fut:	88	48	100	192	25	19	8	597	34	202	941	142
User Adj:	1.00	1.00	1.00	1.00	1.00	1.00	1.00	1.00	1.00	1.00	1.00	1.00
PHF Adj:	1.00	1.00	1.00	1.00	1.00	1.00	1.00	1.00	1.00	1.00	1.00	1.00
PHF Volume:	88	48	100	192	25	19	8	597	34	202	941	142
Reduct Vol:	0	0	0	0	0	0	0	0	0	0	0	0
Reduced Vol:	88	48	100	192	25	19	8	597	34	202	941	142
PCE Adj:	1.00	1.00	1.00	1.00	1.00	1.00	1.00	1.00	1.00	1.00	1.00	1.00
MLF Adj:	1.00	1.00	1.00	1.00	1.00	1.00	1.00	1.00	1.00	1.00	1.00	1.00
FinalVolume:	88	48	100	192	25	19	8	597	34	202	941	142

Saturation Flow Module:

Sat/Lane:	1900	1900	1900	1900	1900	1900	1900	1900	1900	1900	1900	1900
Adjustment:	0.95	0.95	0.92	0.95	0.95	0.92	0.95	0.97	0.92	0.92	0.98	0.95
Lanes:	0.65	0.35	1.00	0.88	0.12	1.00	0.03	1.97	1.00	1.00	1.73	0.27
Final Sat.:	1165	635	1750	1593	207	1750	49	3651	1750	1750	3215	485

Capacity Analysis Module:

Vol/Sat:	0.08	0.08	0.06	0.12	0.12	0.01	0.16	0.16	0.02	0.12	0.29	0.29
Crit Moves:					****						****	
Green Time:	27.4	27.4	27.4	27.4	27.4	27.4	37.1	37.1	37.1	66.5	104	103.6
Volume/Cap:	0.39	0.39	0.29	0.62	0.62	0.06	0.62	0.62	0.07	0.24	0.40	0.40
Delay/Veh:	49.7	49.7	48.5	54.8	54.8	45.9	46.4	46.4	38.6	22.0	6.8	6.8
User DelAdj:	1.00	1.00	1.00	1.00	1.00	1.00	1.00	1.00	1.00	1.00	1.00	1.00
AdjDel/Veh:	49.7	49.7	48.5	54.8	54.8	45.9	46.4	46.4	38.6	22.0	6.8	6.8
LOS by Move:	D	D	D	D	D	D	D	D	D	C	A	A
HCM2k95thQ:	10	10	8	18	18	1	21	21	2	10	16	16

Note: Queue reported is the number of cars per lane.

BART Phase II Extension Project

Level Of Service Computation Report
 2000 HCM Operations (Future Volume Alternative)
 PM - 2035 No Project Conditions

Intersection #4005: JULIAN/28TH

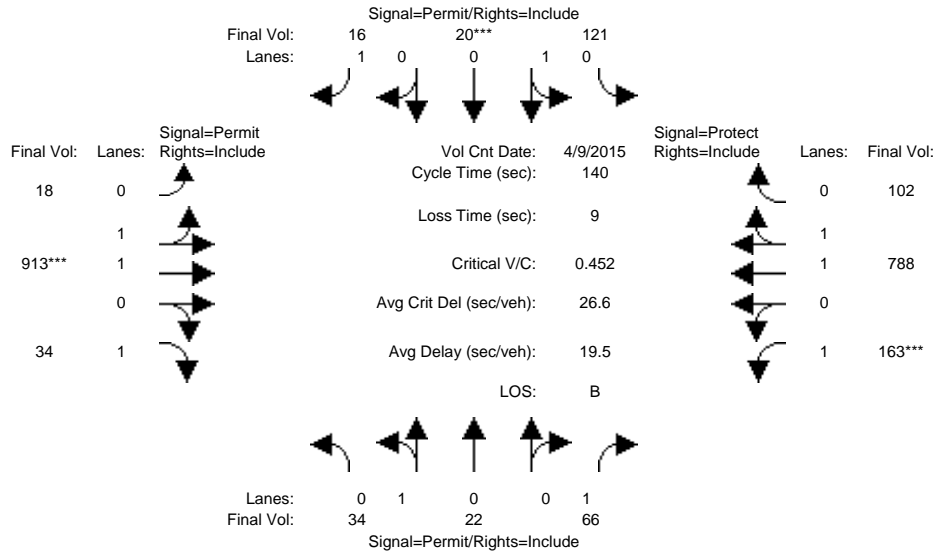

Approach:	North Bound			South Bound			East Bound			West Bound		
	L	T	R	L	T	R	L	T	R	L	T	R
Min. Green:	10	10	10	10	10	10	10	10	10	7	10	10
Y+R:	4.0	4.0	4.0	4.0	4.0	4.0	4.0	4.0	4.0	4.0	4.0	4.0

Volume Module:	>>	Count	Date:	9 Apr 2015	<<							
Base Vol:	34	22	66	121	20	16	18	913	34	163	788	102
Growth Adj:	1.00	1.00	1.00	1.00	1.00	1.00	1.00	1.00	1.00	1.00	1.00	1.00
Initial Bse:	34	22	66	121	20	16	18	913	34	163	788	102
Added Vol:	0	0	0	0	0	0	0	0	0	0	0	0
PasserByVol:	0	0	0	0	0	0	0	0	0	0	0	0
Initial Fut:	34	22	66	121	20	16	18	913	34	163	788	102
User Adj:	1.00	1.00	1.00	1.00	1.00	1.00	1.00	1.00	1.00	1.00	1.00	1.00
PHF Adj:	1.00	1.00	1.00	1.00	1.00	1.00	1.00	1.00	1.00	1.00	1.00	1.00
PHF Volume:	34	22	66	121	20	16	18	913	34	163	788	102
Reduct Vol:	0	0	0	0	0	0	0	0	0	0	0	0
Reduced Vol:	34	22	66	121	20	16	18	913	34	163	788	102
PCE Adj:	1.00	1.00	1.00	1.00	1.00	1.00	1.00	1.00	1.00	1.00	1.00	1.00
MLF Adj:	1.00	1.00	1.00	1.00	1.00	1.00	1.00	1.00	1.00	1.00	1.00	1.00
FinalVolume:	34	22	66	121	20	16	18	913	34	163	788	102

Saturation Flow Module:	North Bound			South Bound			East Bound			West Bound		
Sat/Lane:	1900	1900	1900	1900	1900	1900	1900	1900	1900	1900	1900	1900
Adjustment:	0.95	0.95	0.92	0.95	0.95	0.92	0.95	0.97	0.92	0.92	0.98	0.95
Lanes:	0.61	0.39	1.00	0.86	0.14	1.00	0.04	1.96	1.00	1.00	1.76	0.24
Final Sat.:	1093	707	1750	1545	255	1750	72	3628	1750	1750	3276	424

Capacity Analysis Module:	North Bound			South Bound			East Bound			West Bound		
Vol/Sat:	0.03	0.03	0.04	0.08	0.08	0.01	0.25	0.25	0.02	0.09	0.24	0.24
Crit Moves:				****	****		****	****		****	****	****
Green Time:	24.3	24.3	24.3	24.3	24.3	24.3	77.9	77.9	77.9	28.8	107	106.7
Volume/Cap:	0.18	0.18	0.22	0.45	0.45	0.05	0.45	0.45	0.03	0.45	0.32	0.32
Delay/Veh:	49.7	49.7	50.1	53.0	53.0	48.4	18.6	18.6	14.1	49.6	5.3	5.3
User DelAdj:	1.00	1.00	1.00	1.00	1.00	1.00	1.00	1.00	1.00	1.00	1.00	1.00
AdjDel/Veh:	49.7	49.7	50.1	53.0	53.0	48.4	18.6	18.6	14.1	49.6	5.3	5.3
LOS by Move:	D	D	D	D	D	D	B	B	B	D	A	A
HCM2k95thQ:	4	4	5	12	12	1	21	21	1	12	12	12

Note: Queue reported is the number of cars per lane.

BART Phase II Extension Project

Level Of Service Computation Report
 2000 HCM Operations (Future Volume Alternative)
 AM - 2035 No Project Conditions

Intersection #4022: SANTA CLARA/26TH

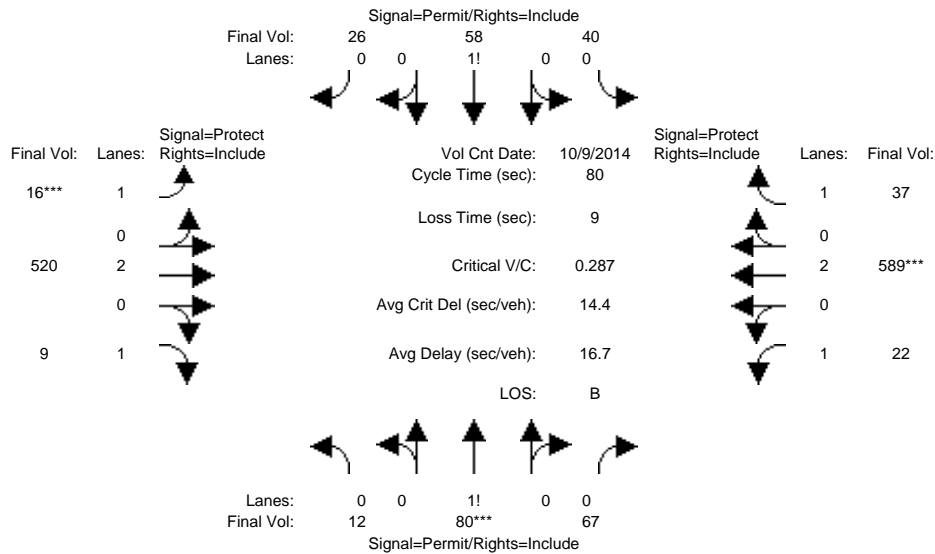

Approach:	North Bound			South Bound			East Bound			West Bound		
	L	T	R	L	T	R	L	T	R	L	T	R
Min. Green:	10	10	10	10	10	10	7	10	10	7	10	10
Y+R:	4.0	4.0	4.0	4.0	4.0	4.0	4.0	4.0	4.0	4.0	4.0	4.0
Volume Module: >> Count Date: 9 Oct 2014 <<												
Base Vol:	12	80	67	40	58	26	16	520	9	22	589	37
Growth Adj:	1.00	1.00	1.00	1.00	1.00	1.00	1.00	1.00	1.00	1.00	1.00	1.00
Initial Bse:	12	80	67	40	58	26	16	520	9	22	589	37
Added Vol:	0	0	0	0	0	0	0	0	0	0	0	0
PasserByVol:	0	0	0	0	0	0	0	0	0	0	0	0
Initial Fut:	12	80	67	40	58	26	16	520	9	22	589	37
User Adj:	1.00	1.00	1.00	1.00	1.00	1.00	1.00	1.00	1.00	1.00	1.00	1.00
PHF Adj:	1.00	1.00	1.00	1.00	1.00	1.00	1.00	1.00	1.00	1.00	1.00	1.00
PHF Volume:	12	80	67	40	58	26	16	520	9	22	589	37
Reduct Vol:	0	0	0	0	0	0	0	0	0	0	0	0
Reduced Vol:	12	80	67	40	58	26	16	520	9	22	589	37
PCE Adj:	1.00	1.00	1.00	1.00	1.00	1.00	1.00	1.00	1.00	1.00	1.00	1.00
MLF Adj:	1.00	1.00	1.00	1.00	1.00	1.00	1.00	1.00	1.00	1.00	1.00	1.00
FinalVolume:	12	80	67	40	58	26	16	520	9	22	589	37
Saturation Flow Module:												
Sat/Lane:	1900	1900	1900	1900	1900	1900	1900	1900	1900	1900	1900	1900
Adjustment:	0.92	0.92	0.92	0.92	0.92	0.92	0.92	1.00	0.92	0.92	1.00	0.92
Lanes:	0.08	0.50	0.42	0.32	0.47	0.21	1.00	2.00	1.00	1.00	2.00	1.00
Final Sat.:	132	881	737	565	819	367	1750	3800	1750	1750	3800	1750
Capacity Analysis Module:												
Vol/Sat:	0.09	0.09	0.09	0.07	0.07	0.07	0.01	0.14	0.01	0.01	0.16	0.02
Crit Moves:	****			****			****			****		
Green Time:	23.7	23.7	23.7	23.7	23.7	23.7	7.0	28.9	28.9	18.5	40.3	40.3
Volume/Cap:	0.31	0.31	0.31	0.24	0.24	0.24	0.10	0.38	0.01	0.05	0.31	0.04
Delay/Veh:	22.2	22.2	22.2	21.6	21.6	21.6	33.9	19.1	16.4	24.0	11.7	10.1
User DelAdj:	1.00	1.00	1.00	1.00	1.00	1.00	1.00	1.00	1.00	1.00	1.00	1.00
AdjDel/Veh:	22.2	22.2	22.2	21.6	21.6	21.6	33.9	19.1	16.4	24.0	11.7	10.1
LOS by Move:	C	C	C	C	C	C	C	B	B	C	B	B
HCM2k95thQ:	7	7	7	5	5	5	1	9	0	1	8	1

Note: Queue reported is the number of cars per lane.

BART Phase II Extension Project

Level Of Service Computation Report
 2000 HCM Operations (Future Volume Alternative)
 PM - 2035 No Project Conditions

Intersection #4022: SANTA CLARA/26TH

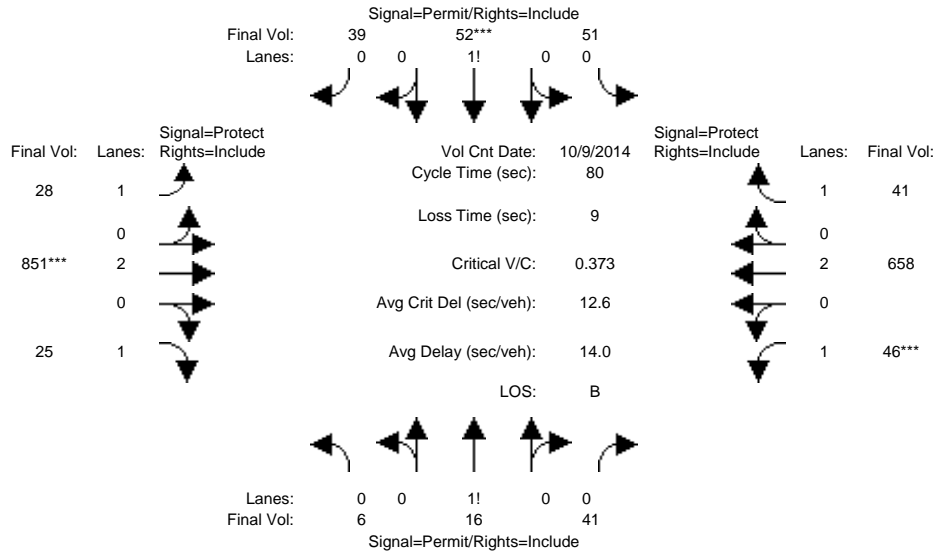

Approach:	North Bound			South Bound			East Bound			West Bound		
	L	T	R	L	T	R	L	T	R	L	T	R
Min. Green:	10	10	10	10	10	10	7	10	10	7	10	10
Y+R:	4.0	4.0	4.0	4.0	4.0	4.0	4.0	4.0	4.0	4.0	4.0	4.0
Volume Module: >> Count Date: 9 Oct 2014 <<												
Base Vol:	6	16	41	51	52	39	28	851	25	46	658	41
Growth Adj:	1.00	1.00	1.00	1.00	1.00	1.00	1.00	1.00	1.00	1.00	1.00	1.00
Initial Bse:	6	16	41	51	52	39	28	851	25	46	658	41
Added Vol:	0	0	0	0	0	0	0	0	0	0	0	0
PasserByVol:	0	0	0	0	0	0	0	0	0	0	0	0
Initial Fut:	6	16	41	51	52	39	28	851	25	46	658	41
User Adj:	1.00	1.00	1.00	1.00	1.00	1.00	1.00	1.00	1.00	1.00	1.00	1.00
PHF Adj:	1.00	1.00	1.00	1.00	1.00	1.00	1.00	1.00	1.00	1.00	1.00	1.00
PHF Volume:	6	16	41	51	52	39	28	851	25	46	658	41
Reduct Vol:	0	0	0	0	0	0	0	0	0	0	0	0
Reduced Vol:	6	16	41	51	52	39	28	851	25	46	658	41
PCE Adj:	1.00	1.00	1.00	1.00	1.00	1.00	1.00	1.00	1.00	1.00	1.00	1.00
MLF Adj:	1.00	1.00	1.00	1.00	1.00	1.00	1.00	1.00	1.00	1.00	1.00	1.00
FinalVolume:	6	16	41	51	52	39	28	851	25	46	658	41
Saturation Flow Module:												
Sat/Lane:	1900	1900	1900	1900	1900	1900	1900	1900	1900	1900	1900	1900
Adjustment:	0.92	0.92	0.92	0.92	0.92	0.92	0.92	1.00	0.92	0.92	1.00	0.92
Lanes:	0.10	0.25	0.65	0.36	0.37	0.27	1.00	2.00	1.00	1.00	2.00	1.00
Final Sat.:	167	444	1139	629	641	481	1750	3800	1750	1750	3800	1750
Capacity Analysis Module:												
Vol/Sat:	0.04	0.04	0.04	0.08	0.08	0.08	0.02	0.22	0.01	0.03	0.17	0.02
Crit Moves:				****			****			****		
Green Time:	17.0	17.0	17.0	17.0	17.0	17.0	18.1	47.0	47.0	7.0	35.9	35.9
Volume/Cap:	0.17	0.17	0.17	0.38	0.38	0.38	0.07	0.38	0.02	0.30	0.39	0.05
Delay/Veh:	25.9	25.9	25.9	27.6	27.6	27.6	24.4	8.9	6.9	35.3	14.9	12.5
User DelAdj:	1.00	1.00	1.00	1.00	1.00	1.00	1.00	1.00	1.00	1.00	1.00	1.00
AdjDel/Veh:	25.9	25.9	25.9	27.6	27.6	27.6	24.4	8.9	6.9	35.3	14.9	12.5
LOS by Move:	C	C	C	C	C	C	C	A	A	D	B	B
HCM2k95thQ:	3	3	3	7	7	7	1	11	1	2	10	1

Note: Queue reported is the number of cars per lane.

BART Phase II Extension Project

Level Of Service Computation Report
 2000 HCM Operations (Future Volume Alternative)
 AM - 2035 Project Conditions

Intersection #3016: 101/ALUM ROCK

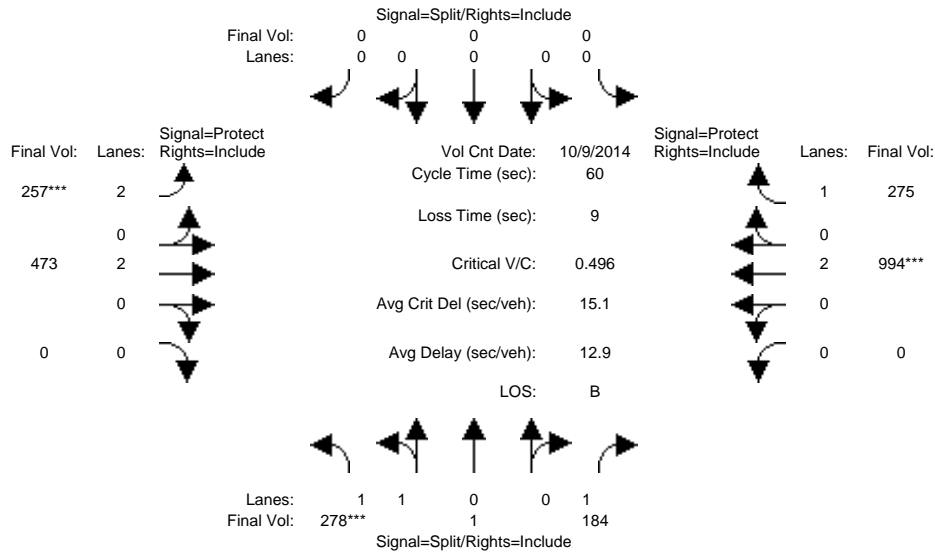

Approach:	North Bound			South Bound			East Bound			West Bound		
	L	T	R	L	T	R	L	T	R	L	T	R
Min. Green:	10	10	10	0	0	0	7	10	0	0	10	10
Y+R:	4.0	4.0	4.0	4.0	4.0	4.0	4.0	4.0	4.0	4.0	4.0	4.0

Volume Module:	>>	Count	Date:	9 Oct 2014	<<												
Base Vol:	278	1	184	0	0	0	257	473	0	0	994	275					
Growth Adj:	1.00	1.00	1.00	1.00	1.00	1.00	1.00	1.00	1.00	1.00	1.00	1.00					
Initial Bse:	278	1	184	0	0	0	257	473	0	0	994	275					
Added Vol:	0	0	0	0	0	0	0	0	0	0	0	0					
PasserByVol:	0	0	0	0	0	0	0	0	0	0	0	0					
Initial Fut:	278	1	184	0	0	0	257	473	0	0	994	275					
User Adj:	1.00	1.00	1.00	1.00	1.00	1.00	1.00	1.00	1.00	1.00	1.00	1.00					
PHF Adj:	1.00	1.00	1.00	1.00	1.00	1.00	1.00	1.00	1.00	1.00	1.00	1.00					
PHF Volume:	278	1	184	0	0	0	257	473	0	0	994	275					
Reduct Vol:	0	0	0	0	0	0	0	0	0	0	0	0					
Reduced Vol:	278	1	184	0	0	0	257	473	0	0	994	275					
PCE Adj:	1.00	1.00	1.00	1.00	1.00	1.00	1.00	1.00	1.00	1.00	1.00	1.00					
MLF Adj:	1.00	1.00	1.00	1.00	1.00	1.00	1.00	1.00	1.00	1.00	1.00	1.00					
Final Volume:	278	1	184	0	0	0	257	473	0	0	994	275					

Saturation Flow Module:												
Sat/Lane:	1900	1900	1900	1900	1900	1900	1900	1900	1900	1900	1900	1900
Adjustment:	0.93	0.95	0.92	0.92	1.00	0.92	0.83	1.00	0.92	0.92	1.00	0.92
Lanes:	1.99	0.01	1.00	0.00	0.00	0.00	2.00	2.00	0.00	0.00	2.00	1.00
Final Sat.:	3537	13	1750	0	0	0	3150	3800	0	0	3800	1750

Capacity Analysis Module:												
Vol/Sat:	0.08	0.08	0.11	0.00	0.00	0.00	0.08	0.12	0.00	0.00	0.26	0.16
Crit Moves:	****						****			****		
Green Time:	12.7	12.7	12.7	0.0	0.0	0.0	9.1	38.3	0.0	0.0	29.2	29.2
Volume/Cap:	0.37	0.37	0.50	0.00	0.00	0.00	0.54	0.20	0.00	0.00	0.54	0.32
Delay/Veh:	20.5	20.5	21.9	0.0	0.0	0.0	24.7	4.5	0.0	0.0	11.0	9.6
User DelAdj:	1.00	1.00	1.00	1.00	1.00	1.00	1.00	1.00	1.00	1.00	1.00	1.00
AdjDel/Veh:	20.5	20.5	21.9	0.0	0.0	0.0	24.7	4.5	0.0	0.0	11.0	9.6
LOS by Move:	C	C	C	A	A	A	C	A	A	A	B	A
HCM2k95thQ:	5	5	8	0	0	0	5	4	0	0	12	7

Note: Queue reported is the number of cars per lane.

BART Phase II Extension Project

Level Of Service Computation Report
 2000 HCM Operations (Future Volume Alternative)
 PM - 2035 Project Conditions

Intersection #3016: 101/ALUM ROCK

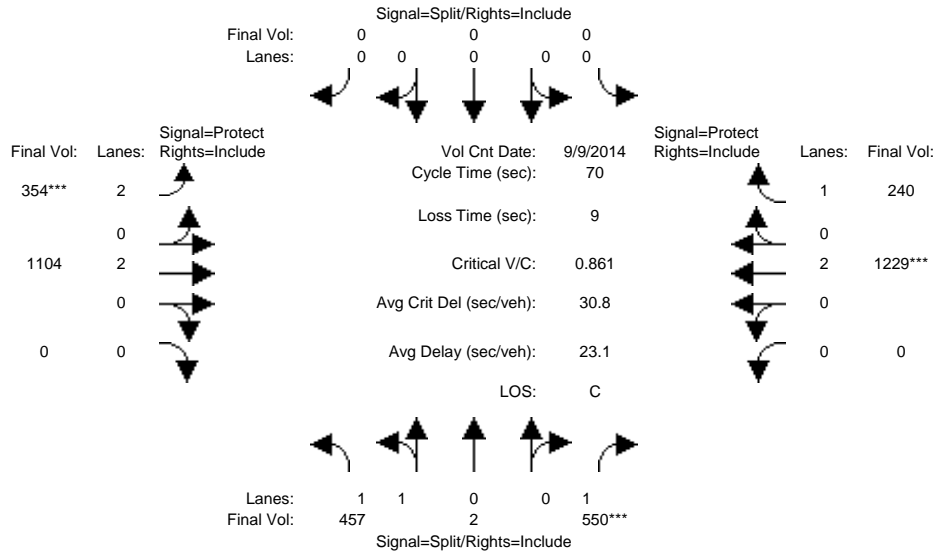

Approach:	North Bound			South Bound			East Bound			West Bound		
	L	T	R	L	T	R	L	T	R	L	T	R
Min. Green:	10	10	10	0	0	0	7	10	0	0	10	10
Y+R:	4.0	4.0	4.0	4.0	4.0	4.0	4.0	4.0	4.0	4.0	4.0	4.0

Volume Module:	>> Count Date: 9 Sep 2014 <<											
Base Vol:	457	2	550	0	0	0	354	1104	0	0	1229	240
Growth Adj:	1.00	1.00	1.00	1.00	1.00	1.00	1.00	1.00	1.00	1.00	1.00	1.00
Initial Bse:	457	2	550	0	0	0	354	1104	0	0	1229	240
Added Vol:	0	0	0	0	0	0	0	0	0	0	0	0
PasserByVol:	0	0	0	0	0	0	0	0	0	0	0	0
Initial Fut:	457	2	550	0	0	0	354	1104	0	0	1229	240
User Adj:	1.00	1.00	1.00	1.00	1.00	1.00	1.00	1.00	1.00	1.00	1.00	1.00
PHF Adj:	1.00	1.00	1.00	1.00	1.00	1.00	1.00	1.00	1.00	1.00	1.00	1.00
PHF Volume:	457	2	550	0	0	0	354	1104	0	0	1229	240
Reduct Vol:	0	0	0	0	0	0	0	0	0	0	0	0
Reduced Vol:	457	2	550	0	0	0	354	1104	0	0	1229	240
PCE Adj:	1.00	1.00	1.00	1.00	1.00	1.00	1.00	1.00	1.00	1.00	1.00	1.00
MLF Adj:	1.00	1.00	1.00	1.00	1.00	1.00	1.00	1.00	1.00	1.00	1.00	1.00
FinalVolume:	457	2	550	0	0	0	354	1104	0	0	1229	240

Saturation Flow Module:												
Sat/Lane:	1900	1900	1900	1900	1900	1900	1900	1900	1900	1900	1900	1900
Adjustment:	0.93	0.95	0.92	0.92	1.00	0.92	0.83	1.00	0.92	0.92	1.00	0.92
Lanes:	1.99	0.01	1.00	0.00	0.00	0.00	2.00	2.00	0.00	0.00	2.00	1.00
Final Sat.:	3535	15	1750	0	0	0	3150	3800	0	0	3800	1750

Capacity Analysis Module:												
Vol/Sat:	0.13	0.13	0.31	0.00	0.00	0.00	0.11	0.29	0.00	0.00	0.32	0.14
Crit Moves:			****				****				****	
Green Time:	25.6	25.6	25.6	0.0	0.0	0.0	9.1	35.4	0.0	0.0	26.3	26.3
Volume/Cap:	0.35	0.35	0.86	0.00	0.00	0.00	0.86	0.57	0.00	0.00	0.86	0.36
Delay/Veh:	16.4	16.4	32.0	0.0	0.0	0.0	46.4	12.4	0.0	0.0	25.7	16.2
User DelAdj:	1.00	1.00	1.00	1.00	1.00	1.00	1.00	1.00	1.00	1.00	1.00	1.00
AdjDel/Veh:	16.4	16.4	32.0	0.0	0.0	0.0	46.4	12.4	0.0	0.0	25.7	16.2
LOS by Move:	B	B	C	A	A	A	D	B	A	A	C	B
HCM2k95thQ:	8	8	27	0	0	0	10	15	0	0	24	8

Note: Queue reported is the number of cars per lane.

BART Phase II Extension Project

Level Of Service Computation Report
 2000 HCM Operations (Future Volume Alternative)
 AM - 2035 Project Conditions

Intersection #3023: 101/SANTA CLARA

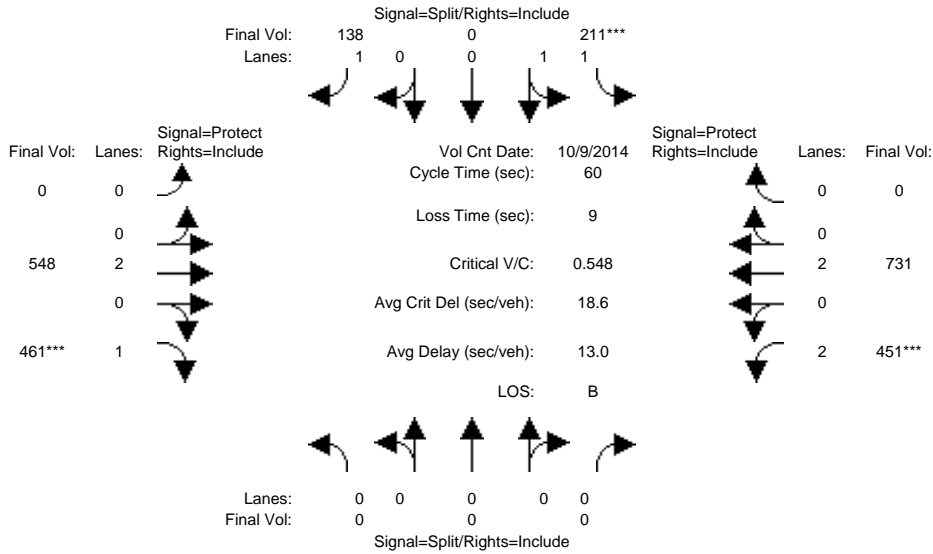

Approach:	North Bound			South Bound			East Bound			West Bound		
	L	T	R	L	T	R	L	T	R	L	T	R
Min. Green:	0	0	0	10	10	10	0	10	10	7	10	0
Y+R:	4.0	4.0	4.0	4.0	4.0	4.0	4.0	4.0	4.0	4.0	4.0	4.0
Volume Module: >> Count Date: 9 Oct 2014 <<												
Base Vol:	0	0	0	211	0	138	0	548	461	451	731	0
Growth Adj:	1.00	1.00	1.00	1.00	1.00	1.00	1.00	1.00	1.00	1.00	1.00	1.00
Initial Bse:	0	0	0	211	0	138	0	548	461	451	731	0
Added Vol:	0	0	0	0	0	0	0	0	0	0	0	0
PasserByVol:	0	0	0	0	0	0	0	0	0	0	0	0
Initial Fut:	0	0	0	211	0	138	0	548	461	451	731	0
User Adj:	1.00	1.00	1.00	1.00	1.00	1.00	1.00	1.00	1.00	1.00	1.00	1.00
PHF Adj:	1.00	1.00	1.00	1.00	1.00	1.00	1.00	1.00	1.00	1.00	1.00	1.00
PHF Volume:	0	0	0	211	0	138	0	548	461	451	731	0
Reduct Vol:	0	0	0	0	0	0	0	0	0	0	0	0
Reduced Vol:	0	0	0	211	0	138	0	548	461	451	731	0
PCE Adj:	1.00	1.00	1.00	1.00	1.00	1.00	1.00	1.00	1.00	1.00	1.00	1.00
MLF Adj:	1.00	1.00	1.00	1.00	1.00	1.00	1.00	1.00	1.00	1.00	1.00	1.00
FinalVolume:	0	0	0	211	0	138	0	548	461	451	731	0
Saturation Flow Module:												
Sat/Lane:	1900	1900	1900	1900	1900	1900	1900	1900	1900	1900	1900	1900
Adjustment:	0.92	1.00	0.92	0.93	1.00	0.92	0.92	1.00	0.92	0.83	1.00	0.92
Lanes:	0.00	0.00	0.00	2.00	0.00	1.00	0.00	2.00	1.00	2.00	2.00	0.00
Final Sat.:	0	0	0	3550	0	1750	0	3800	1750	3150	3800	0
Capacity Analysis Module:												
Vol/Sat:	0.00	0.00	0.00	0.06	0.00	0.08	0.00	0.14	0.26	0.14	0.19	0.00
Crit Moves:				****				****			****	
Green Time:	0.0	0.0	0.0	10.0	0.0	10.0	0.0	26.6	26.6	14.4	41.0	0.0
Volume/Cap:	0.00	0.00	0.00	0.36	0.00	0.47	0.00	0.33	0.60	0.60	0.28	0.00
Delay/Veh:	0.0	0.0	0.0	22.5	0.0	23.8	0.0	11.0	13.9	21.5	3.8	0.0
User DelAdj:	1.00	1.00	1.00	1.00	1.00	1.00	1.00	1.00	1.00	1.00	1.00	1.00
AdjDel/Veh:	0.0	0.0	0.0	22.5	0.0	23.8	0.0	11.0	13.9	21.5	3.8	0.0
LOS by Move:	A	A	A	C	A	C	A	B	B	C	A	A
HCM2k95thQ:	0	0	0	4	0	6	0	6	13	9	5	0

Note: Queue reported is the number of cars per lane.

BART Phase II Extension Project

Level Of Service Computation Report
 2000 HCM Operations (Future Volume Alternative)
 PM - 2035 Project Conditions

Intersection #3023: 101/SANTA CLARA

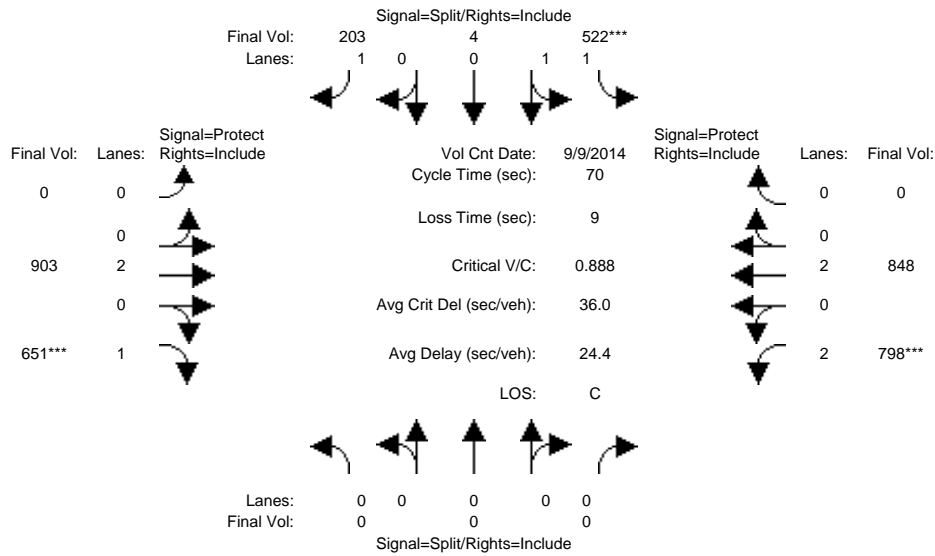

Approach:	North Bound			South Bound			East Bound			West Bound		
	L	T	R	L	T	R	L	T	R	L	T	R
Min. Green:	0	0	0	10	10	10	0	10	10	7	10	0
Y+R:	4.0	4.0	4.0	4.0	4.0	4.0	4.0	4.0	4.0	4.0	4.0	4.0
Volume Module: >> Count Date: 9 Sep 2014 <<												
Base Vol:	0	0	0	522	4	203	0	903	651	798	848	0
Growth Adj:	1.00	1.00	1.00	1.00	1.00	1.00	1.00	1.00	1.00	1.00	1.00	1.00
Initial Bse:	0	0	0	522	4	203	0	903	651	798	848	0
Added Vol:	0	0	0	0	0	0	0	0	0	0	0	0
PasserByVol:	0	0	0	0	0	0	0	0	0	0	0	0
Initial Fut:	0	0	0	522	4	203	0	903	651	798	848	0
User Adj:	1.00	1.00	1.00	1.00	1.00	1.00	1.00	1.00	1.00	1.00	1.00	1.00
PHF Adj:	1.00	1.00	1.00	1.00	1.00	1.00	1.00	1.00	1.00	1.00	1.00	1.00
PHF Volume:	0	0	0	522	4	203	0	903	651	798	848	0
Reduct Vol:	0	0	0	0	0	0	0	0	0	0	0	0
Reduced Vol:	0	0	0	522	4	203	0	903	651	798	848	0
PCE Adj:	1.00	1.00	1.00	1.00	1.00	1.00	1.00	1.00	1.00	1.00	1.00	1.00
MLF Adj:	1.00	1.00	1.00	1.00	1.00	1.00	1.00	1.00	1.00	1.00	1.00	1.00
FinalVolume:	0	0	0	522	4	203	0	903	651	798	848	0
Saturation Flow Module:												
Sat/Lane:	1900	1900	1900	1900	1900	1900	1900	1900	1900	1900	1900	1900
Adjustment:	0.92	1.00	0.92	0.93	0.95	0.92	0.92	1.00	0.92	0.83	1.00	0.92
Lanes:	0.00	0.00	0.00	1.99	0.01	1.00	0.00	2.00	1.00	2.00	2.00	0.00
Final Sat.:	0	0	0	3523	27	1750	0	3800	1750	3150	3800	0
Capacity Analysis Module:												
Vol/Sat:	0.00	0.00	0.00	0.15	0.15	0.12	0.00	0.24	0.37	0.25	0.22	0.00
Crit Moves:				****				****			****	
Green Time:	0.0	0.0	0.0	11.7	11.7	11.7	0.0	29.3	29.3	20.0	49.3	0.0
Volume/Cap:	0.00	0.00	0.00	0.89	0.89	0.69	0.00	0.57	0.89	0.89	0.32	0.00
Delay/Veh:	0.0	0.0	0.0	43.7	43.7	34.6	0.0	16.0	31.5	34.6	4.0	0.0
User DelAdj:	1.00	1.00	1.00	1.00	1.00	1.00	1.00	1.00	1.00	1.00	1.00	1.00
AdjDel/Veh:	0.0	0.0	0.0	43.7	43.7	34.6	0.0	16.0	31.5	34.6	4.0	0.0
LOS by Move:	A	A	A	D	D	C	A	B	C	C	A	A
HCM2k95thQ:	0	0	0	18	18	12	0	14	27	19	7	0

Note: Queue reported is the number of cars per lane.

BART Phase II Extension Project

Level Of Service Computation Report
 2000 HCM Operations (Future Volume Alternative)
 AM - 2035 Project Conditions

Intersection #3036: 280/MCLAUGHLIN

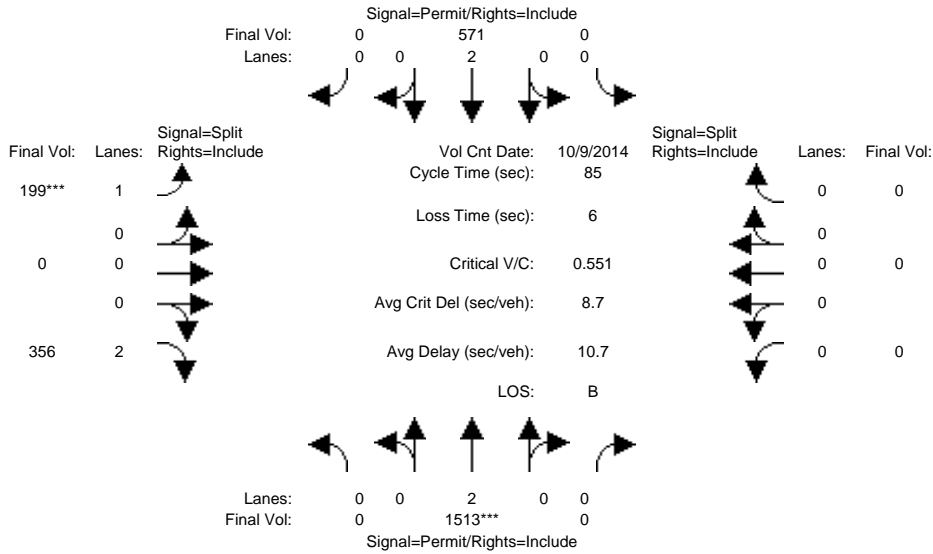

Approach:	North Bound			South Bound			East Bound			West Bound		
	L	T	R	L	T	R	L	T	R	L	T	R
Min. Green:	0	10	0	0	10	0	10	0	10	0	0	0
Y+R:	4.0	4.0	4.0	4.0	4.0	4.0	4.0	4.0	4.0	4.0	4.0	4.0
Volume Module: >> Count Date: 9 Oct 2014 <<												
Base Vol:	0	1513	0	0	571	0	199	0	356	0	0	0
Growth Adj:	1.00	1.00	1.00	1.00	1.00	1.00	1.00	1.00	1.00	1.00	1.00	1.00
Initial Bse:	0	1513	0	0	571	0	199	0	356	0	0	0
Added Vol:	0	0	0	0	0	0	0	0	0	0	0	0
PasserByVol:	0	0	0	0	0	0	0	0	0	0	0	0
Initial Fut:	0	1513	0	0	571	0	199	0	356	0	0	0
User Adj:	1.00	1.00	1.00	1.00	1.00	1.00	1.00	1.00	1.00	1.00	1.00	1.00
PHF Adj:	1.00	1.00	1.00	1.00	1.00	1.00	1.00	1.00	1.00	1.00	1.00	1.00
PHF Volume:	0	1513	0	0	571	0	199	0	356	0	0	0
Reduct Vol:	0	0	0	0	0	0	0	0	0	0	0	0
Reduced Vol:	0	1513	0	0	571	0	199	0	356	0	0	0
PCE Adj:	1.00	1.00	1.00	1.00	1.00	1.00	1.00	1.00	1.00	1.00	1.00	1.00
MLF Adj:	1.00	1.00	1.00	1.00	1.00	1.00	1.00	1.00	1.00	1.00	1.00	1.00
FinalVolume:	0	1513	0	0	571	0	199	0	356	0	0	0
Saturation Flow Module:												
Sat/Lane:	1900	1900	1900	1900	1900	1900	1900	1900	1900	1900	1900	1900
Adjustment:	0.92	1.00	0.92	0.92	1.00	0.92	0.92	1.00	0.83	0.92	1.00	0.92
Lanes:	0.00	2.00	0.00	0.00	2.00	0.00	1.00	0.00	2.00	0.00	0.00	0.00
Final Sat.:	0	3800	0	0	3800	0	1750	0	3150	0	0	0
Capacity Analysis Module:												
Vol/Sat:	0.00	0.40	0.00	0.00	0.15	0.00	0.11	0.00	0.11	0.00	0.00	0.00
Crit Moves:	****			****			****			****		
Green Time:	0.0	61.4	0.0	0.0	61.4	0.0	17.6	0.0	17.6	0.0	0.0	0.0
Volume/Cap:	0.00	0.55	0.00	0.00	0.21	0.00	0.55	0.00	0.55	0.00	0.00	0.00
Delay/Veh:	0.0	5.7	0.0	0.0	3.9	0.0	32.0	0.0	31.2	0.0	0.0	0.0
User DelAdj:	1.00	1.00	1.00	1.00	1.00	1.00	1.00	1.00	1.00	1.00	1.00	1.00
AdjDel/Veh:	0.0	5.7	0.0	0.0	3.9	0.0	32.0	0.0	31.2	0.0	0.0	0.0
LOS by Move:	A	A	A	A	A	A	C	A	C	A	A	A
HCM2k95thQ:	0	17	0	0	5	0	11	0	11	0	0	0

Note: Queue reported is the number of cars per lane.

BART Phase II Extension Project

Level Of Service Computation Report
2000 HCM Operations (Future Volume Alternative)
PM - 2035 Project Conditions

Intersection #3036: 280/MCLAUGHLIN

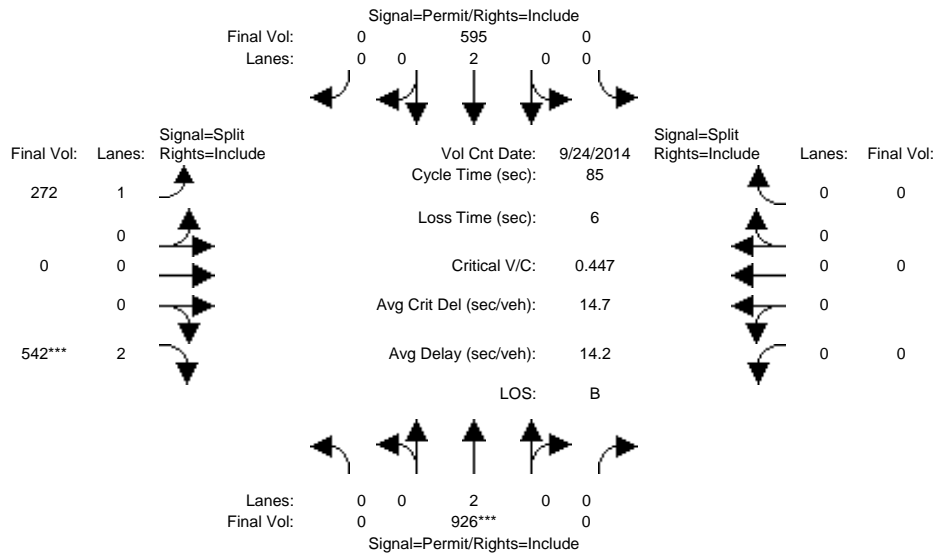

Approach:	North Bound			South Bound			East Bound			West Bound		
Movement:	L	T	R	L	T	R	L	T	R	L	T	R
Min. Green:	0	10	0	0	10	0	10	0	10	0	0	0
Y+R:	4.0	4.0	4.0	4.0	4.0	4.0	4.0	4.0	4.0	4.0	4.0	4.0
Volume Module: >> Count Date: 24 Sep 2014 <<												
Base Vol:	0	926	0	0	595	0	272	0	542	0	0	0
Growth Adj:	1.00	1.00	1.00	1.00	1.00	1.00	1.00	1.00	1.00	1.00	1.00	1.00
Initial Bse:	0	926	0	0	595	0	272	0	542	0	0	0
Added Vol:	0	0	0	0	0	0	0	0	0	0	0	0
PasserByVol:	0	0	0	0	0	0	0	0	0	0	0	0
Initial Fut:	0	926	0	0	595	0	272	0	542	0	0	0
User Adj:	1.00	1.00	1.00	1.00	1.00	1.00	1.00	1.00	1.00	1.00	1.00	1.00
PHF Adj:	1.00	1.00	1.00	1.00	1.00	1.00	1.00	1.00	1.00	1.00	1.00	1.00
PHF Volume:	0	926	0	0	595	0	272	0	542	0	0	0
Reduct Vol:	0	0	0	0	0	0	0	0	0	0	0	0
Reduced Vol:	0	926	0	0	595	0	272	0	542	0	0	0
PCE Adj:	1.00	1.00	1.00	1.00	1.00	1.00	1.00	1.00	1.00	1.00	1.00	1.00
MLF Adj:	1.00	1.00	1.00	1.00	1.00	1.00	1.00	1.00	1.00	1.00	1.00	1.00
Final Volume:	0	926	0	0	595	0	272	0	542	0	0	0
Saturation Flow Module:												
Sat/Lane:	1900	1900	1900	1900	1900	1900	1900	1900	1900	1900	1900	1900
Adjustment:	0.92	1.00	0.92	0.92	1.00	0.92	0.92	1.00	0.83	0.92	1.00	0.92
Lanes:	0.00	2.00	0.00	0.00	2.00	0.00	1.00	0.00	2.00	0.00	0.00	0.00
Final Sat.:	0	3800	0	0	3800	0	1750	0	3150	0	0	0
Capacity Analysis Module:												
Vol/Sat:	0.00	0.24	0.00	0.00	0.16	0.00	0.16	0.00	0.17	0.00	0.00	0.00
Crit Moves:	****						****					
Green Time:	0.0	46.3	0.0	0.0	46.3	0.0	32.7	0.0	32.7	0.0	0.0	0.0
Volume/Cap:	0.00	0.45	0.00	0.00	0.29	0.00	0.40	0.00	0.45	0.00	0.00	0.00
Delay/Veh:	0.0	11.8	0.0	0.0	10.5	0.0	19.5	0.0	19.7	0.0	0.0	0.0
User DelAdj:	1.00	1.00	1.00	1.00	1.00	1.00	1.00	1.00	1.00	1.00	1.00	1.00
AdjDel/Veh:	0.0	11.8	0.0	0.0	10.5	0.0	19.5	0.0	19.7	0.0	0.0	0.0
LOS by Move:	A	B	A	A	B	A	B	A	B	A	A	A
HCM2k95thQ:	0	14	0	0	8	0	11	0	13	0	0	0

Note: Queue reported is the number of cars per lane.

BART Phase II Extension Project

Level Of Service Computation Report
2000 HCM Operations (Future Volume Alternative)
AM - 2035 Project Conditions

Intersection #3210: 101/JULIAN

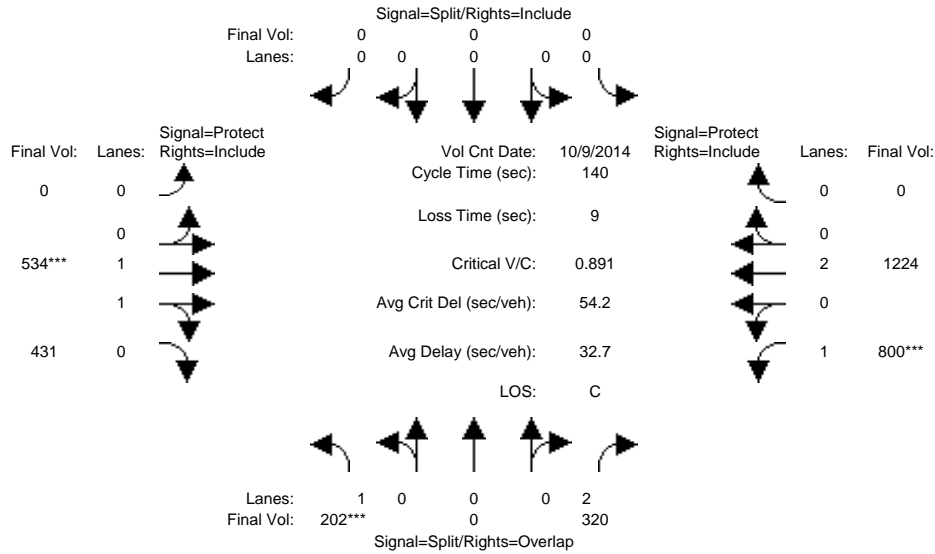

Approach:	North Bound			South Bound			East Bound			West Bound		
	L	T	R	L	T	R	L	T	R	L	T	R
Min. Green:	10	0	10	0	0	0	0	10	10	7	10	0
Y+R:	4.0	4.0	4.0	4.0	4.0	4.0	4.0	4.0	4.0	4.0	4.0	4.0

Volume Module:	>>	Count	Date:	9 Oct 2014	<<							
Base Vol:	202	0	320	0	0	0	0	534	431	800	1224	0
Growth Adj:	1.00	1.00	1.00	1.00	1.00	1.00	1.00	1.00	1.00	1.00	1.00	1.00
Initial Bse:	202	0	320	0	0	0	0	534	431	800	1224	0
Added Vol:	0	0	0	0	0	0	0	0	0	0	0	0
PasserByVol:	0	0	0	0	0	0	0	0	0	0	0	0
Initial Fut:	202	0	320	0	0	0	0	534	431	800	1224	0
User Adj:	1.00	1.00	1.00	1.00	1.00	1.00	1.00	1.00	1.00	1.00	1.00	1.00
PHF Adj:	1.00	1.00	1.00	1.00	1.00	1.00	1.00	1.00	1.00	1.00	1.00	1.00
PHF Volume:	202	0	320	0	0	0	0	534	431	800	1224	0
Reduct Vol:	0	0	0	0	0	0	0	0	0	0	0	0
Reduced Vol:	202	0	320	0	0	0	0	534	431	800	1224	0
PCE Adj:	1.00	1.00	1.00	1.00	1.00	1.00	1.00	1.00	1.00	1.00	1.00	1.00
MLF Adj:	1.00	1.00	1.00	1.00	1.00	1.00	1.00	1.00	1.00	1.00	1.00	1.00
FinalVolume:	202	0	320	0	0	0	0	534	431	800	1224	0

Saturation Flow Module:												
Sat/Lane:	1900	1900	1900	1900	1900	1900	1900	1900	1900	1900	1900	1900
Adjustment:	0.92	1.00	0.83	0.92	1.00	0.92	0.92	0.99	0.95	0.92	1.00	0.92
Lanes:	1.00	0.00	2.00	0.00	0.00	0.00	0.00	1.08	0.92	1.00	2.00	0.00
Final Sat.:	1750	0	3150	0	0	0	0	2046	1652	1750	3800	0

Capacity Analysis Module:												
Vol/Sat:	0.12	0.00	0.10	0.00	0.00	0.00	0.00	0.26	0.26	0.46	0.32	0.00
Crit Moves:	****							****		****		
Green Time:	18.1	0.0	90.0	0.0	0.0	0.0	0.0	41.0	41.0	71.8	113	0.0
Volume/Cap:	0.89	0.00	0.16	0.00	0.00	0.00	0.00	0.89	0.89	0.89	0.40	0.00
Delay/Veh:	92.2	0.0	10.0	0.0	0.0	0.0	0.0	56.7	56.7	41.6	4.0	0.0
User DelAdj:	1.00	1.00	1.00	1.00	1.00	1.00	1.00	1.00	1.00	1.00	1.00	1.00
AdjDel/Veh:	92.2	0.0	10.0	0.0	0.0	0.0	0.0	56.7	56.7	41.6	4.0	0.0
LOS by Move:	F	A	A	A	A	A	A	E	E	D	A	A
HCM2k95thQ:	22	0	6	0	0	0	0	36	36	57	14	0

Note: Queue reported is the number of cars per lane.

BART Phase II Extension Project

Level Of Service Computation Report
2000 HCM Operations (Future Volume Alternative)
PM - 2035 Project Conditions

Intersection #3210: 101/JULIAN

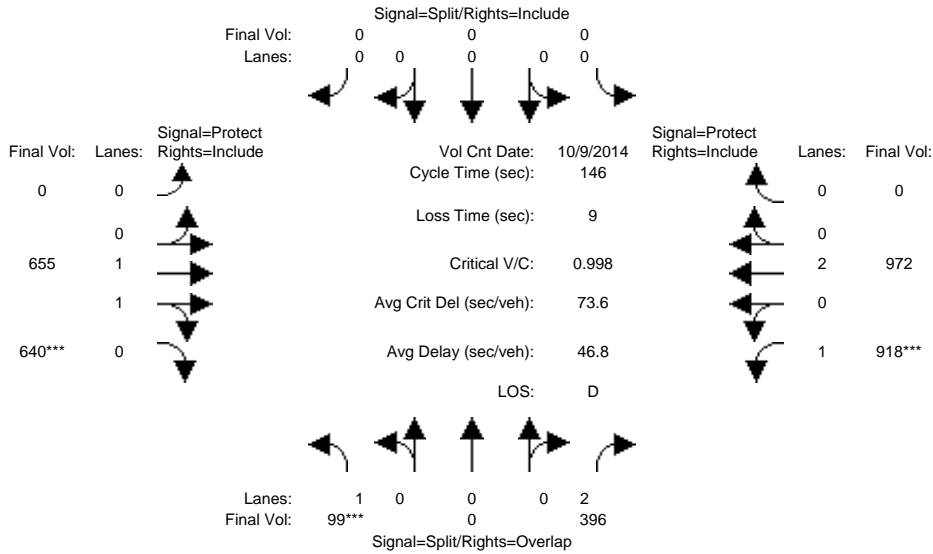

Approach:	North Bound			South Bound			East Bound			West Bound		
Movement:	L	T	R	L	T	R	L	T	R	L	T	R
Min. Green:	10	0	10	0	0	0	0	10	10	7	10	0
Y+R:	4.0	4.0	4.0	4.0	4.0	4.0	4.0	4.0	4.0	4.0	4.0	4.0
Volume Module: >> Count Date: 9 Oct 2014 <<												
Base Vol:	99	0	396	0	0	0	0	655	640	918	972	0
Growth Adj:	1.00	1.00	1.00	1.00	1.00	1.00	1.00	1.00	1.00	1.00	1.00	1.00
Initial Bse:	99	0	396	0	0	0	0	655	640	918	972	0
Added Vol:	0	0	0	0	0	0	0	0	0	0	0	0
PasserByVol:	0	0	0	0	0	0	0	0	0	0	0	0
Initial Fut:	99	0	396	0	0	0	0	655	640	918	972	0
User Adj:	1.00	1.00	1.00	1.00	1.00	1.00	1.00	1.00	1.00	1.00	1.00	1.00
PHF Adj:	1.00	1.00	1.00	1.00	1.00	1.00	1.00	1.00	1.00	1.00	1.00	1.00
PHF Volume:	99	0	396	0	0	0	0	655	640	918	972	0
Reduct Vol:	0	0	0	0	0	0	0	0	0	0	0	0
Reduced Vol:	99	0	396	0	0	0	0	655	640	918	972	0
PCE Adj:	1.00	1.00	1.00	1.00	1.00	1.00	1.00	1.00	1.00	1.00	1.00	1.00
MLF Adj:	1.00	1.00	1.00	1.00	1.00	1.00	1.00	1.00	1.00	1.00	1.00	1.00
FinalVolume:	99	0	396	0	0	0	0	655	640	918	972	0
Saturation Flow Module:												
Sat/Lane:	1900	1900	1900	1900	1900	1900	1900	1900	1900	1900	1900	1900
Adjustment:	0.92	1.00	0.83	0.92	1.00	0.92	0.92	1.00	0.95	0.92	1.00	0.92
Lanes:	1.00	0.00	2.00	0.00	0.00	0.00	0.00	1.00	1.00	1.00	2.00	0.00
Final Sat.:	1750	0	3150	0	0	0	0	1899	1800	1750	3800	0
Capacity Analysis Module:												
Vol/Sat:	0.06	0.00	0.13	0.00	0.00	0.00	0.00	0.34	0.36	0.52	0.26	0.00
Crit Moves:	****							****	****			
Green Time:	10.0	0.0	85.7	0.0	0.0	0.0	0.0	51.3	51.3	75.7	127	0.0
Volume/Cap:	0.83	0.00	0.21	0.00	0.00	0.00	0.00	0.98	1.01	1.01	0.29	0.00
Delay/Veh:	102.5	0.0	14.3	0.0	0.0	0.0	0.0	67.3	75.4	68.0	1.7	0.0
User DelAdj:	1.00	1.00	1.00	1.00	1.00	1.00	1.00	1.00	1.00	1.00	1.00	1.00
AdjDel/Veh:	102.5	0.0	14.3	0.0	0.0	0.0	0.0	67.3	75.4	68.0	1.7	0.0
LOS by Move:	F	A	B	A	A	A	A	E	E	E	A	A
HCM2k95thQ:	13	0	9	0	0	0	0	52	56	80	8	0

Note: Queue reported is the number of cars per lane.

BART Phase II Extension Project

Level Of Service Computation Report
 2000 HCM Operations (Future Volume Alternative)
 AM - 2035 Project Conditions

Intersection #3211: 101/McKee(E)

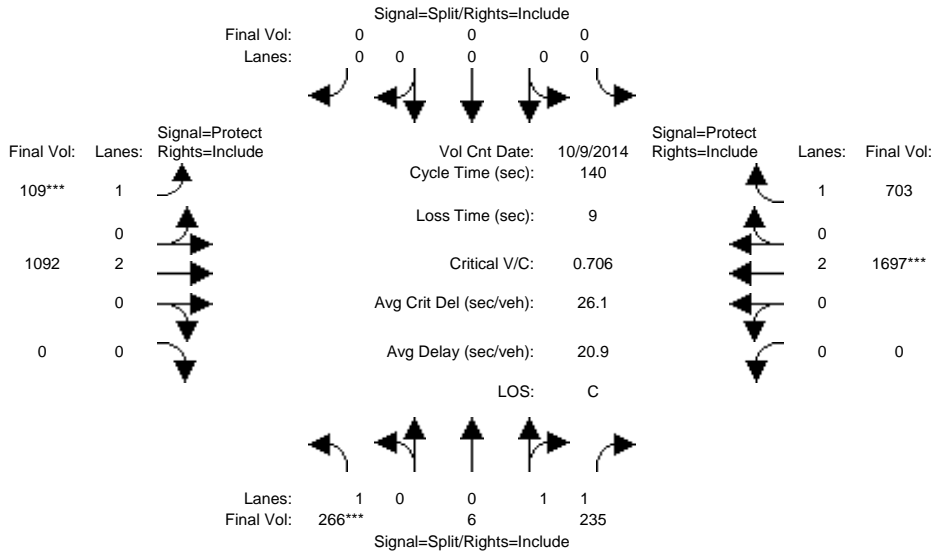

Approach:	North Bound			South Bound			East Bound			West Bound		
	L	T	R	L	T	R	L	T	R	L	T	R
Min. Green:	10	10	10	0	0	0	7	10	0	0	10	10
Y+R:	4.0	4.0	4.0	4.0	4.0	4.0	4.0	4.0	4.0	4.0	4.0	4.0
Volume Module: >> Count Date: 9 Oct 2014 <<												
Base Vol:	266	6	235	0	0	0	109	1092	0	0	1697	703
Growth Adj:	1.00	1.00	1.00	1.00	1.00	1.00	1.00	1.00	1.00	1.00	1.00	1.00
Initial Bse:	266	6	235	0	0	0	109	1092	0	0	1697	703
Added Vol:	0	0	0	0	0	0	0	0	0	0	0	0
PasserByVol:	0	0	0	0	0	0	0	0	0	0	0	0
Initial Fut:	266	6	235	0	0	0	109	1092	0	0	1697	703
User Adj:	1.00	1.00	1.00	1.00	1.00	1.00	1.00	1.00	1.00	1.00	1.00	1.00
PHF Adj:	1.00	1.00	1.00	1.00	1.00	1.00	1.00	1.00	1.00	1.00	1.00	1.00
PHF Volume:	266	6	235	0	0	0	109	1092	0	0	1697	703
Reduct Vol:	0	0	0	0	0	0	0	0	0	0	0	0
Reduced Vol:	266	6	235	0	0	0	109	1092	0	0	1697	703
PCE Adj:	1.00	1.00	1.00	1.00	1.00	1.00	1.00	1.00	1.00	1.00	1.00	1.00
MLF Adj:	1.00	1.00	1.00	1.00	1.00	1.00	1.00	1.00	1.00	1.00	1.00	1.00
FinalVolume:	266	6	235	0	0	0	109	1092	0	0	1697	703
Saturation Flow Module:												
Sat/Lane:	1900	1900	1900	1900	1900	1900	1900	1900	1900	1900	1900	1900
Adjustment:	0.92	0.95	0.95	0.92	1.00	0.92	0.92	1.00	0.92	0.92	1.00	0.92
Lanes:	1.00	0.05	1.95	0.00	0.00	0.00	1.00	2.00	0.00	0.00	2.00	1.00
Final Sat.:	1750	90	3510	0	0	0	1750	3800	0	0	3800	1750
Capacity Analysis Module:												
Vol/Sat:	0.15	0.07	0.07	0.00	0.00	0.00	0.06	0.29	0.00	0.00	0.45	0.40
Crit Moves:	****						****				****	
Green Time:	30.1	30.1	30.1	0.0	0.0	0.0	12.3	101	0.0	0.0	88.5	88.5
Volume/Cap:	0.71	0.31	0.31	0.00	0.00	0.00	0.71	0.40	0.00	0.00	0.71	0.64
Delay/Veh:	56.9	46.4	46.4	0.0	0.0	0.0	76.0	7.8	0.0	0.0	18.1	17.0
User DelAdj:	1.00	1.00	1.00	1.00	1.00	1.00	1.00	1.00	1.00	1.00	1.00	1.00
AdjDel/Veh:	56.9	46.4	46.4	0.0	0.0	0.0	76.0	7.8	0.0	0.0	18.1	17.0
LOS by Move:	E	D	D	A	A	A	E	A	A	A	B	B
HCM2k95thQ:	22	9	9	0	0	0	12	17	0	0	40	34

Note: Queue reported is the number of cars per lane.

BART Phase II Extension Project

Level Of Service Computation Report
2000 HCM Operations (Future Volume Alternative)
PM - 2035 Project Conditions

Intersection #3211: 101/McKee(E)

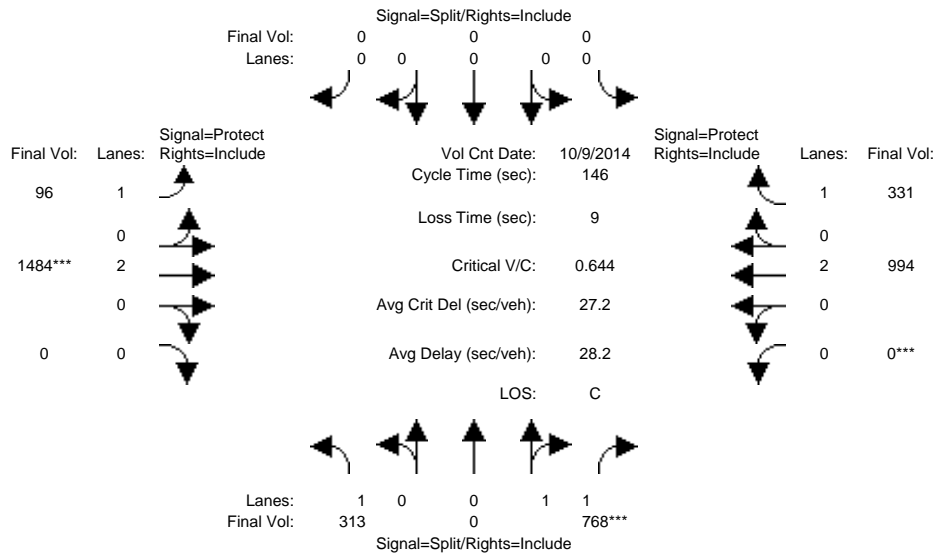

Approach:	North Bound			South Bound			East Bound			West Bound		
Movement:	L	T	R	L	T	R	L	T	R	L	T	R
Min. Green:	10	10	10	0	0	0	7	10	0	0	10	10
Y+R:	4.0	4.0	4.0	4.0	4.0	4.0	4.0	4.0	4.0	4.0	4.0	4.0
Volume Module: >> Count Date: 9 Oct 2014 <<												
Base Vol:	313	0	768	0	0	0	96	1484	0	0	994	331
Growth Adj:	1.00	1.00	1.00	1.00	1.00	1.00	1.00	1.00	1.00	1.00	1.00	1.00
Initial Bse:	313	0	768	0	0	0	96	1484	0	0	994	331
Added Vol:	0	0	0	0	0	0	0	0	0	0	0	0
PasserByVol:	0	0	0	0	0	0	0	0	0	0	0	0
Initial Fut:	313	0	768	0	0	0	96	1484	0	0	994	331
User Adj:	1.00	1.00	1.00	1.00	1.00	1.00	1.00	1.00	1.00	1.00	1.00	1.00
PHF Adj:	1.00	1.00	1.00	1.00	1.00	1.00	1.00	1.00	1.00	1.00	1.00	1.00
PHF Volume:	313	0	768	0	0	0	96	1484	0	0	994	331
Reduct Vol:	0	0	0	0	0	0	0	0	0	0	0	0
Reduced Vol:	313	0	768	0	0	0	96	1484	0	0	994	331
PCE Adj:	1.00	1.00	1.00	1.00	1.00	1.00	1.00	1.00	1.00	1.00	1.00	1.00
MLF Adj:	1.00	1.00	1.00	1.00	1.00	1.00	1.00	1.00	1.00	1.00	1.00	1.00
FinalVolume:	313	0	768	0	0	0	96	1484	0	0	994	331
Saturation Flow Module:												
Sat/Lane:	1900	1900	1900	1900	1900	1900	1900	1900	1900	1900	1900	1900
Adjustment:	0.92	1.00	0.95	0.92	1.00	0.92	0.92	1.00	0.92	0.92	1.00	0.92
Lanes:	1.00	0.00	2.00	0.00	0.00	0.00	1.00	2.00	0.00	0.00	2.00	1.00
Final Sat.:	1750	0	3600	0	0	0	1750	3800	0	0	3800	1750
Capacity Analysis Module:												
Vol/Sat:	0.18	0.00	0.21	0.00	0.00	0.00	0.05	0.39	0.00	0.00	0.26	0.19
Crit Moves:			****					****			****	
Green Time:	48.4	0.0	48.4	0.0	0.0	0.0	15.4	88.6	0.0	0.0	73.2	73.2
Volume/Cap:	0.54	0.00	0.64	0.00	0.00	0.00	0.52	0.64	0.00	0.00	0.52	0.38
Delay/Veh:	40.8	0.0	42.7	0.0	0.0	0.0	64.5	19.1	0.0	0.0	24.8	22.6
User DelAdj:	1.00	1.00	1.00	1.00	1.00	1.00	1.00	1.00	1.00	1.00	1.00	1.00
AdjDel/Veh:	40.8	0.0	42.7	0.0	0.0	0.0	64.5	19.1	0.0	0.0	24.8	22.6
LOS by Move:	D	A	D	A	A	A	E	B	A	A	C	C
HCM2k95thQ:	22	0	27	0	0	0	10	36	0	0	26	18

Note: Queue reported is the number of cars per lane.

BART Phase II Extension Project

Level Of Service Computation Report
2000 HCM Operations (Future Volume Alternative)
AM - 2035 Project Conditions

Intersection #3612: JULIAN/21ST

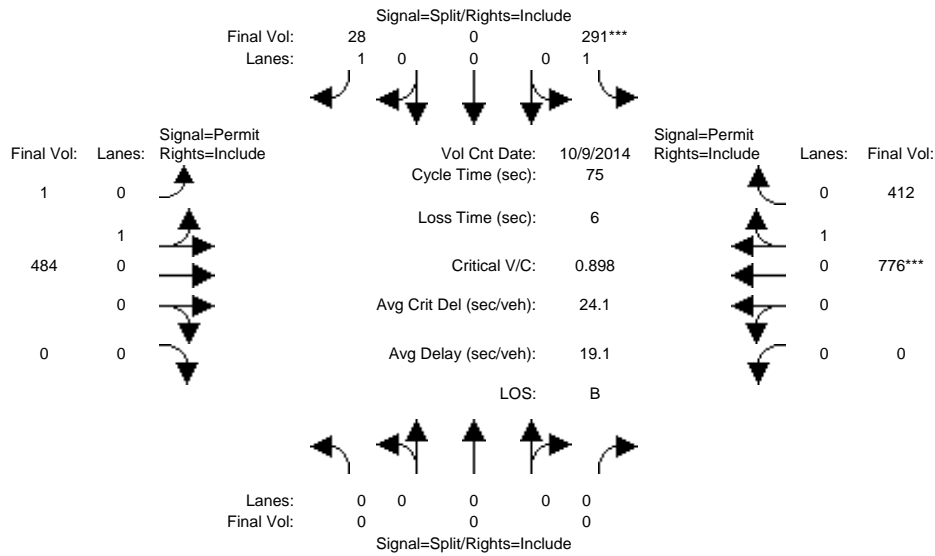

Approach:	North Bound			South Bound			East Bound			West Bound			
	L	T	R	L	T	R	L	T	R	L	T	R	
Min. Green:	0	0	0	10	0	10	10	10	0	0	10	10	
Y+R:	4.0	4.0	4.0	4.0	4.0	4.0	4.0	4.0	4.0	4.0	4.0	4.0	
Volume Module: >> Count Date: 9 Oct 2014 <<													
Base Vol:	0	0	0	291	0	28	1	484	0	0	776	412	
Growth Adj:	1.00	1.00	1.00	1.00	1.00	1.00	1.00	1.00	1.00	1.00	1.00	1.00	
Initial Bse:	0	0	0	291	0	28	1	484	0	0	776	412	
Added Vol:	0	0	0	0	0	0	0	0	0	0	0	0	
PasserByVol:	0	0	0	0	0	0	0	0	0	0	0	0	
Initial Fut:	0	0	0	291	0	28	1	484	0	0	776	412	
User Adj:	1.00	1.00	1.00	1.00	1.00	1.00	1.00	1.00	1.00	1.00	1.00	1.00	
PHF Adj:	1.00	1.00	1.00	1.00	1.00	1.00	1.00	1.00	1.00	1.00	1.00	1.00	
PHF Volume:	0	0	0	291	0	28	1	484	0	0	776	412	
Reduct Vol:	0	0	0	0	0	0	0	0	0	0	0	0	
Reduced Vol:	0	0	0	291	0	28	1	484	0	0	776	412	
PCE Adj:	1.00	1.00	1.00	1.00	1.00	1.00	1.00	1.00	1.00	1.00	1.00	1.00	
MLF Adj:	1.00	1.00	1.00	1.00	1.00	1.00	1.00	1.00	1.00	1.00	1.00	1.00	
FinalVolume:	0	0	0	291	0	28	1	484	0	0	776	412	
Saturation Flow Module:													
Sat/Lane:	1900	1900	1900	1900	1900	1900	1900	1900	1900	1900	1900	1900	
Adjustment:	0.92	1.00	0.92	0.92	1.00	0.92	0.95	0.95	0.92	0.92	0.95	0.95	
Lanes:	0.00	0.00	0.00	1.00	0.00	1.00	0.01	0.99	0.00	0.00	0.65	0.35	
Final Sat.:	0	0	0	1750	0	1750	4	1796	0	0	1176	624	
Capacity Analysis Module:													
Vol/Sat:	0.00	0.00	0.00	0.17	0.00	0.02	0.27	0.27	0.00	0.00	0.66	0.66	
Crit Moves:				****							****		
Green Time:	0.0	0.0	0.0	13.9	0.0	13.9	55.1	55.1	0.0	0.0	55.1	55.1	
Volume/Cap:	0.00	0.00	0.00	0.90	0.00	0.09	0.37	0.37	0.00	0.00	0.90	0.90	
Delay/Veh:	0.0	0.0	0.0	56.0	0.0	25.4	3.8	3.8	0.0	0.0	16.2	16.2	
User DelAdj:	1.00	1.00	1.00	1.00	1.00	1.00	1.00	1.00	1.00	1.00	1.00	1.00	
AdjDel/Veh:	0.0	0.0	0.0	56.0	0.0	25.4	3.8	3.8	0.0	0.0	16.2	16.2	
LOS by Move:	A	A	A	E	A	C	A	A	A	A	B	B	
HCM2k95thQ:	0	0	0	20	0	1	8	8	0	0	42	42	

Note: Queue reported is the number of cars per lane.

BART Phase II Extension Project

Level Of Service Computation Report
2000 HCM Operations (Future Volume Alternative)
PM - 2035 Project Conditions

Intersection #3612: JULIAN/21ST

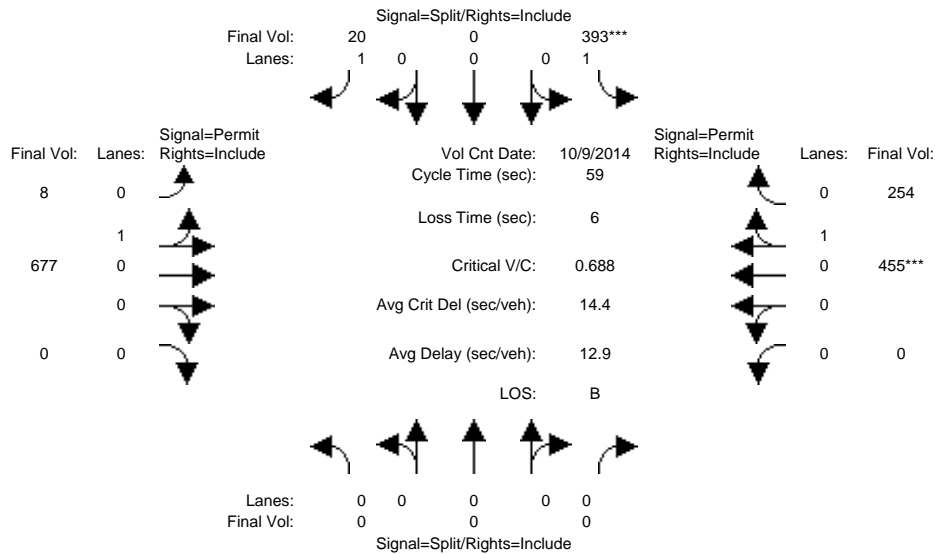

Approach:	North Bound			South Bound			East Bound			West Bound			
	L	T	R	L	T	R	L	T	R	L	T	R	
Min. Green:	0	0	0	10	0	10	10	10	0	0	10	10	
Y+R:	4.0	4.0	4.0	4.0	4.0	4.0	4.0	4.0	4.0	4.0	4.0	4.0	
Volume Module: >> Count Date: 9 Oct 2014 <<													
Base Vol:	0	0	0	393	0	20	8	677	0	0	455	254	
Growth Adj:	1.00	1.00	1.00	1.00	1.00	1.00	1.00	1.00	1.00	1.00	1.00	1.00	
Initial Bse:	0	0	0	393	0	20	8	677	0	0	455	254	
Added Vol:	0	0	0	0	0	0	0	0	0	0	0	0	
PasserByVol:	0	0	0	0	0	0	0	0	0	0	0	0	
Initial Fut:	0	0	0	393	0	20	8	677	0	0	455	254	
User Adj:	1.00	1.00	1.00	1.00	1.00	1.00	1.00	1.00	1.00	1.00	1.00	1.00	
PHF Adj:	1.00	1.00	1.00	1.00	1.00	1.00	1.00	1.00	1.00	1.00	1.00	1.00	
PHF Volume:	0	0	0	393	0	20	8	677	0	0	455	254	
Reduct Vol:	0	0	0	0	0	0	0	0	0	0	0	0	
Reduced Vol:	0	0	0	393	0	20	8	677	0	0	455	254	
PCE Adj:	1.00	1.00	1.00	1.00	1.00	1.00	1.00	1.00	1.00	1.00	1.00	1.00	
MLF Adj:	1.00	1.00	1.00	1.00	1.00	1.00	1.00	1.00	1.00	1.00	1.00	1.00	
FinalVolume:	0	0	0	393	0	20	8	677	0	0	455	254	
Saturation Flow Module:													
Sat/Lane:	1900	1900	1900	1900	1900	1900	1900	1900	1900	1900	1900	1900	
Adjustment:	0.92	1.00	0.92	0.92	1.00	0.92	0.95	0.95	0.92	0.92	0.95	0.95	
Lanes:	0.00	0.00	0.00	1.00	0.00	1.00	0.01	0.99	0.00	0.00	0.64	0.36	
Final Sat.:	0	0	0	1750	0	1750	21	1779	0	0	1155	645	
Capacity Analysis Module:													
Vol/Sat:	0.00	0.00	0.00	0.22	0.00	0.01	0.38	0.38	0.00	0.00	0.39	0.39	
Crit Moves:				****							****		
Green Time:	0.0	0.0	0.0	19.2	0.0	19.2	33.8	33.8	0.0	0.0	33.8	33.8	
Volume/Cap:	0.00	0.00	0.00	0.69	0.00	0.04	0.67	0.67	0.00	0.00	0.69	0.69	
Delay/Veh:	0.0	0.0	0.0	20.8	0.0	13.6	10.4	10.4	0.0	0.0	10.9	10.9	
User DelAdj:	1.00	1.00	1.00	1.00	1.00	1.00	1.00	1.00	1.00	1.00	1.00	1.00	
AdjDel/Veh:	0.0	0.0	0.0	20.8	0.0	13.6	10.4	10.4	0.0	0.0	10.9	10.9	
LOS by Move:	A	A	A	C	A	B	B	B	A	A	B	B	
HCM2k95thQ:	0	0	0	15	0	1	17	17	0	0	18	18	

Note: Queue reported is the number of cars per lane.

BART Phase II Extension Project

Level Of Service Computation Report
2000 HCM Operations (Future Volume Alternative)
AM - 2035 Project Conditions

Intersection #3613: JULIAN/24TH

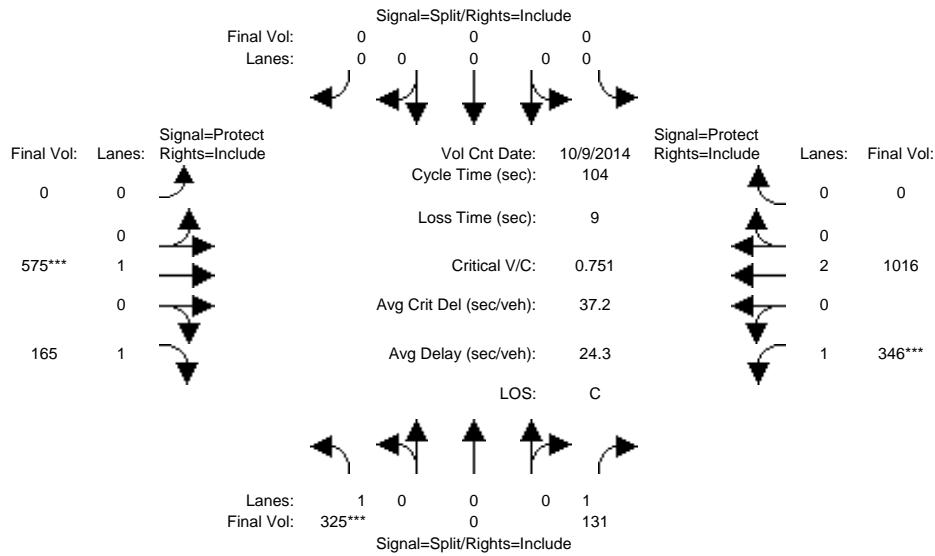

Approach:	North Bound			South Bound			East Bound			West Bound		
	L	T	R	L	T	R	L	T	R	L	T	R
Min. Green:	10	0	10	0	0	0	0	10	10	7	10	0
Y+R:	4.0	4.0	4.0	4.0	4.0	4.0	4.0	4.0	4.0	4.0	4.0	4.0

Volume Module:	>>	Count	Date:	9 Oct 2014	<<							
Base Vol:	325	0	131	0	0	0	0	575	165	346	1016	0
Growth Adj:	1.00	1.00	1.00	1.00	1.00	1.00	1.00	1.00	1.00	1.00	1.00	1.00
Initial Bse:	325	0	131	0	0	0	0	575	165	346	1016	0
Added Vol:	0	0	0	0	0	0	0	0	0	0	0	0
PasserByVol:	0	0	0	0	0	0	0	0	0	0	0	0
Initial Fut:	325	0	131	0	0	0	0	575	165	346	1016	0
User Adj:	1.00	1.00	1.00	1.00	1.00	1.00	1.00	1.00	1.00	1.00	1.00	1.00
PHF Adj:	1.00	1.00	1.00	1.00	1.00	1.00	1.00	1.00	1.00	1.00	1.00	1.00
PHF Volume:	325	0	131	0	0	0	0	575	165	346	1016	0
Reduct Vol:	0	0	0	0	0	0	0	0	0	0	0	0
Reduced Vol:	325	0	131	0	0	0	0	575	165	346	1016	0
PCE Adj:	1.00	1.00	1.00	1.00	1.00	1.00	1.00	1.00	1.00	1.00	1.00	1.00
MLF Adj:	1.00	1.00	1.00	1.00	1.00	1.00	1.00	1.00	1.00	1.00	1.00	1.00
FinalVolume:	325	0	131	0	0	0	0	575	165	346	1016	0

Saturation Flow Module:	Sat/Lane:	1900	1900	1900	1900	1900	1900	1900	1900	1900	1900	1900
Adjustment:	0.92	1.00	0.92	0.92	1.00	0.92	0.92	1.00	0.92	0.92	1.00	0.92
Lanes:	1.00	0.00	1.00	0.00	0.00	0.00	0.00	1.00	1.00	1.00	2.00	0.00
Final Sat.:	1750	0	1750	0	0	0	0	1900	1750	1750	3800	0

Capacity Analysis Module:	Vol/Sat:	0.19	0.00	0.07	0.00	0.00	0.00	0.00	0.30	0.09	0.20	0.27	0.00
Crit Moves:	****								****		****		
Green Time:	25.7	0.0	25.7	0.0	0.0	0.0	0.0	41.9	41.9	27.4	69.3	0.0	
Volume/Cap:	0.75	0.00	0.30	0.00	0.00	0.00	0.00	0.75	0.23	0.75	0.40	0.00	
Delay/Veh:	43.4	0.0	32.2	0.0	0.0	0.0	0.0	30.8	20.6	42.0	8.0	0.0	
User DelAdj:	1.00	1.00	1.00	1.00	1.00	1.00	1.00	1.00	1.00	1.00	1.00	1.00	
AdjDel/Veh:	43.4	0.0	32.2	0.0	0.0	0.0	0.0	30.8	20.6	42.0	8.0	0.0	
LOS by Move:	D	A	C	A	A	A	A	C	C	D	A	A	
HCM2k95thQ:	22	0	7	0	0	0	0	28	7	23	14	0	

Note: Queue reported is the number of cars per lane.

BART Phase II Extension Project

Level Of Service Computation Report
2000 HCM Operations (Future Volume Alternative)
PM - 2035 Project Conditions

Intersection #3613: JULIAN/24TH

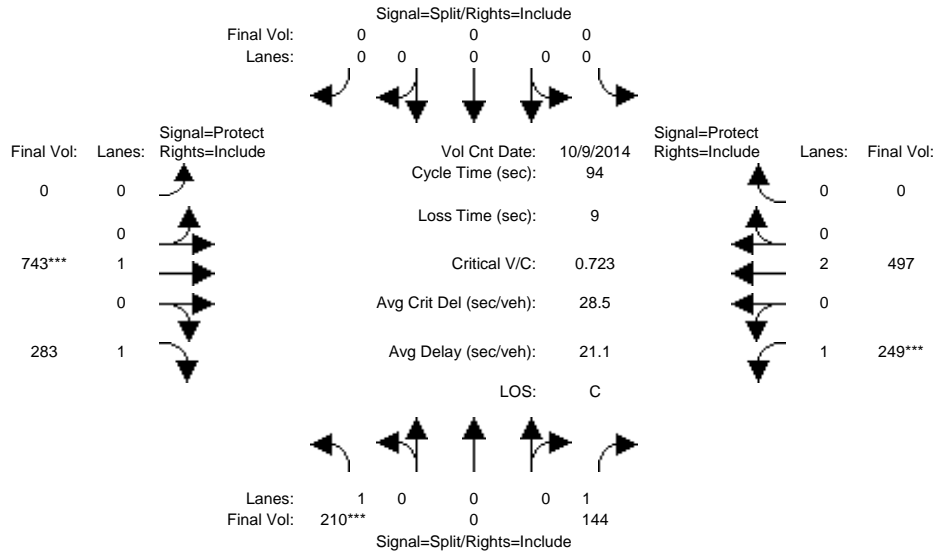

Approach:	North Bound			South Bound			East Bound			West Bound		
	L	T	R	L	T	R	L	T	R	L	T	R
Min. Green:	10	0	10	0	0	0	0	10	10	7	10	0
Y+R:	4.0	4.0	4.0	4.0	4.0	4.0	4.0	4.0	4.0	4.0	4.0	4.0

Volume Module:	>> Count Date: 9 Oct 2014 <<											
Base Vol:	210	0	144	0	0	0	0	743	283	249	497	0
Growth Adj:	1.00	1.00	1.00	1.00	1.00	1.00	1.00	1.00	1.00	1.00	1.00	1.00
Initial Bse:	210	0	144	0	0	0	0	743	283	249	497	0
Added Vol:	0	0	0	0	0	0	0	0	0	0	0	0
PasserByVol:	0	0	0	0	0	0	0	0	0	0	0	0
Initial Fut:	210	0	144	0	0	0	0	743	283	249	497	0
User Adj:	1.00	1.00	1.00	1.00	1.00	1.00	1.00	1.00	1.00	1.00	1.00	1.00
PHF Adj:	1.00	1.00	1.00	1.00	1.00	1.00	1.00	1.00	1.00	1.00	1.00	1.00
PHF Volume:	210	0	144	0	0	0	0	743	283	249	497	0
Reduct Vol:	0	0	0	0	0	0	0	0	0	0	0	0
Reduced Vol:	210	0	144	0	0	0	0	743	283	249	497	0
PCE Adj:	1.00	1.00	1.00	1.00	1.00	1.00	1.00	1.00	1.00	1.00	1.00	1.00
MLF Adj:	1.00	1.00	1.00	1.00	1.00	1.00	1.00	1.00	1.00	1.00	1.00	1.00
FinalVolume:	210	0	144	0	0	0	0	743	283	249	497	0

Saturation Flow Module:												
Sat/Lane:	1900	1900	1900	1900	1900	1900	1900	1900	1900	1900	1900	1900
Adjustment:	0.92	1.00	0.92	0.92	1.00	0.92	0.92	1.00	0.92	0.92	1.00	0.92
Lanes:	1.00	0.00	1.00	0.00	0.00	0.00	0.00	1.00	1.00	1.00	2.00	0.00
Final Sat.:	1750	0	1750	0	0	0	0	1900	1750	1750	3800	0

Capacity Analysis Module:												
Vol/Sat:	0.12	0.00	0.08	0.00	0.00	0.00	0.00	0.39	0.16	0.14	0.13	0.00
Crit Moves:	****							****		****		
Green Time:	15.6	0.0	15.6	0.0	0.0	0.0	0.0	50.9	50.9	18.5	69.4	0.0
Volume/Cap:	0.72	0.00	0.50	0.00	0.00	0.00	0.00	0.72	0.30	0.72	0.18	0.00
Delay/Veh:	45.8	0.0	36.9	0.0	0.0	0.0	0.0	18.8	12.0	42.7	3.7	0.0
User DelAdj:	1.00	1.00	1.00	1.00	1.00	1.00	1.00	1.00	1.00	1.00	1.00	1.00
AdjDel/Veh:	45.8	0.0	36.9	0.0	0.0	0.0	0.0	18.8	12.0	42.7	3.7	0.0
LOS by Move:	D	A	D	A	A	A	A	B	B	D	A	A
HCM2k95thQ:	15	0	9	0	0	0	0	28	9	16	4	0

Note: Queue reported is the number of cars per lane.

BART Phase II Extension Project

Level Of Service Computation Report
2000 HCM Operations (Future Volume Alternative)
AM - 2035 Project Conditions

Intersection #3625: KING/McKEE

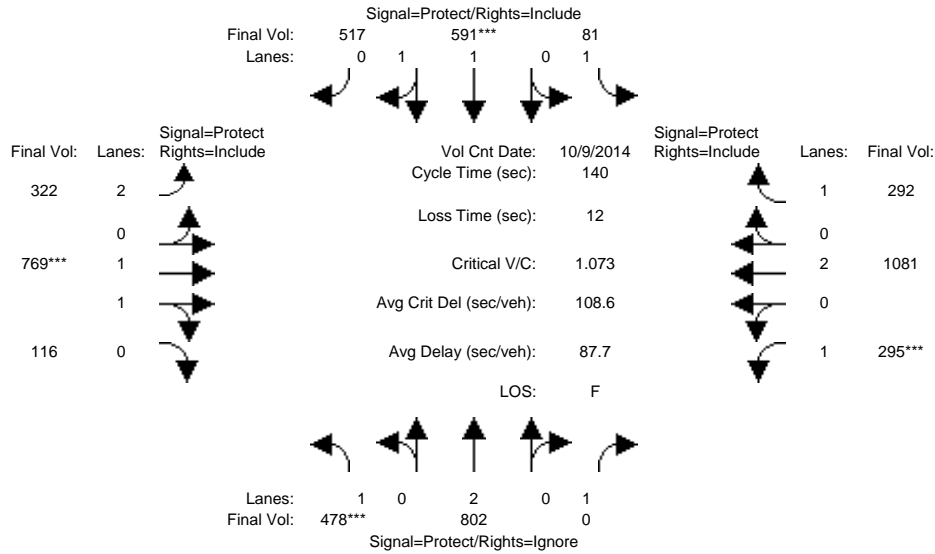

Approach:	North Bound			South Bound			East Bound			West Bound		
	L	T	R	L	T	R	L	T	R	L	T	R
Min. Green:	7	10	10	7	10	10	7	10	10	7	10	10
Y+R:	4.0	4.0	4.0	4.0	4.0	4.0	4.0	4.0	4.0	4.0	4.0	4.0

Volume Module:	>>	Count	Date:	9 Oct 2014	<<							
Base Vol:	478	802	195	81	591	517	322	769	116	295	1081	292
Growth Adj:	1.00	1.00	1.00	1.00	1.00	1.00	1.00	1.00	1.00	1.00	1.00	1.00
Initial Bse:	478	802	195	81	591	517	322	769	116	295	1081	292
Added Vol:	0	0	0	0	0	0	0	0	0	0	0	0
PasserByVol:	0	0	0	0	0	0	0	0	0	0	0	0
Initial Fut:	478	802	195	81	591	517	322	769	116	295	1081	292
User Adj:	1.00	1.00	0.00	1.00	1.00	1.00	1.00	1.00	1.00	1.00	1.00	1.00
PHF Adj:	1.00	1.00	0.00	1.00	1.00	1.00	1.00	1.00	1.00	1.00	1.00	1.00
PHF Volume:	478	802	0	81	591	517	322	769	116	295	1081	292
Reduct Vol:	0	0	0	0	0	0	0	0	0	0	0	0
Reduced Vol:	478	802	0	81	591	517	322	769	116	295	1081	292
PCE Adj:	1.00	1.00	0.00	1.00	1.00	1.00	1.00	1.00	1.00	1.00	1.00	1.00
MLF Adj:	1.00	1.00	0.00	1.00	1.00	1.00	1.00	1.00	1.00	1.00	1.00	1.00
FinalVolume:	478	802	0	81	591	517	322	769	116	295	1081	292

Saturation Flow Module:												
Sat/Lane:	1900	1900	1900	1900	1900	1900	1900	1900	1900	1900	1900	1900
Adjustment:	0.92	1.00	0.92	0.92	1.00	0.95	0.83	0.98	0.95	0.92	1.00	0.92
Lanes:	1.00	2.00	1.00	1.00	1.04	0.96	2.00	1.73	0.27	1.00	2.00	1.00
Final Sat.:	1750	3800	1750	1750	1972	1725	3150	3215	485	1750	3800	1750

Capacity Analysis Module:												
Vol/Sat:	0.27	0.21	0.00	0.05	0.30	0.30	0.10	0.24	0.24	0.17	0.28	0.17
Crit Moves:	****				****			****			****	
Green Time:	35.7	60.4	0.0	14.3	39.1	39.1	14.1	31.2	31.2	22.0	39.2	39.2
Volume/Cap:	1.07	0.49	0.00	0.45	1.07	1.07	1.02	1.07	1.07	1.07	1.02	0.60
Delay/Veh:	115.6	28.9	0.0	61.0	100	100.0	118.0	107	107.0	133.8	82.4	45.6
User DelAdj:	1.00	1.00	1.00	1.00	1.00	1.00	1.00	1.00	1.00	1.00	1.00	1.00
AdjDel/Veh:	115.6	28.9	0.0	61.0	100	100.0	118.0	107	107.0	133.8	82.4	45.6
LOS by Move:	F	C	A	E	F	F	F	F	F	F	F	D
HCM2k95thQ:	47	22	0	7	51	51	19	42	42	31	46	21

Note: Queue reported is the number of cars per lane.

BART Phase II Extension Project

Level Of Service Computation Report
2000 HCM Operations (Future Volume Alternative)
PM - 2035 Project Conditions

Intersection #3625: KING/McKEE

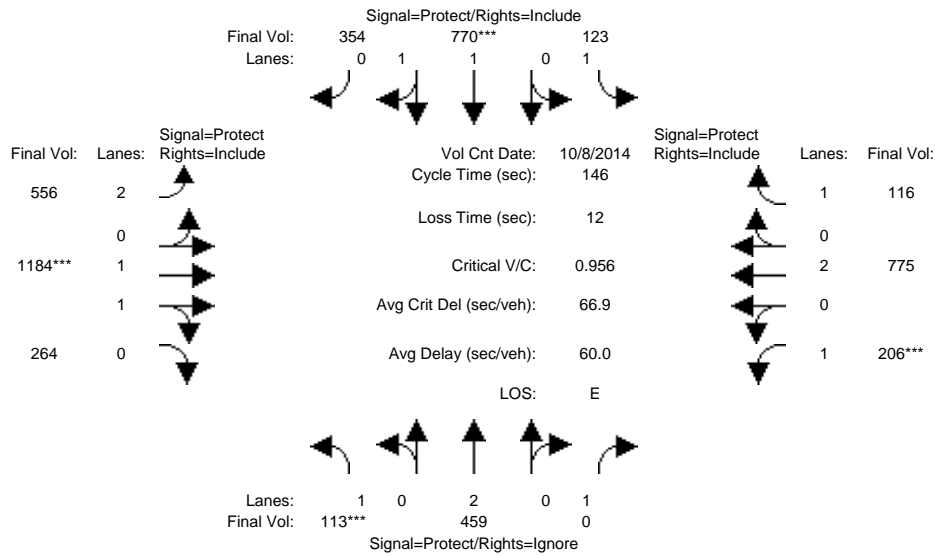

Approach:	North Bound			South Bound			East Bound			West Bound		
	L	T	R	L	T	R	L	T	R	L	T	R
Min. Green:	7	10	10	7	10	10	7	10	10	7	10	10
Y+R:	4.0	4.0	4.0	4.0	4.0	4.0	4.0	4.0	4.0	4.0	4.0	4.0
Volume Module: >> Count Date: 8 Oct 2014 <<												
Base Vol:	113	459	181	123	770	354	556	1184	264	206	775	116
Growth Adj:	1.00	1.00	1.00	1.00	1.00	1.00	1.00	1.00	1.00	1.00	1.00	1.00
Initial Bse:	113	459	181	123	770	354	556	1184	264	206	775	116
Added Vol:	0	0	0	0	0	0	0	0	0	0	0	0
PasserByVol:	0	0	0	0	0	0	0	0	0	0	0	0
Initial Fut:	113	459	181	123	770	354	556	1184	264	206	775	116
User Adj:	1.00	1.00	0.00	1.00	1.00	1.00	1.00	1.00	1.00	1.00	1.00	1.00
PHF Adj:	1.00	1.00	0.00	1.00	1.00	1.00	1.00	1.00	1.00	1.00	1.00	1.00
PHF Volume:	113	459	0	123	770	354	556	1184	264	206	775	116
Reduct Vol:	0	0	0	0	0	0	0	0	0	0	0	0
Reduced Vol:	113	459	0	123	770	354	556	1184	264	206	775	116
PCE Adj:	1.00	1.00	0.00	1.00	1.00	1.00	1.00	1.00	1.00	1.00	1.00	1.00
MLF Adj:	1.00	1.00	0.00	1.00	1.00	1.00	1.00	1.00	1.00	1.00	1.00	1.00
FinalVolume:	113	459	0	123	770	354	556	1184	264	206	775	116
Saturation Flow Module:												
Sat/Lane:	1900	1900	1900	1900	1900	1900	1900	1900	1900	1900	1900	1900
Adjustment:	0.92	1.00	0.92	0.92	0.99	0.95	0.83	0.98	0.95	0.92	1.00	0.92
Lanes:	1.00	2.00	1.00	1.00	1.35	0.65	2.00	1.63	0.37	1.00	2.00	1.00
Final Sat.:	1750	3800	1750	1750	2534	1165	3150	3025	674	1750	3800	1750
Capacity Analysis Module:												
Vol/Sat:	0.06	0.12	0.00	0.07	0.30	0.30	0.18	0.39	0.39	0.12	0.20	0.07
Crit Moves:	****			****			****			****		
Green Time:	9.9	35.6	0.0	20.7	46.4	46.4	36.1	59.8	59.8	18.0	41.7	41.7
Volume/Cap:	0.96	0.50	0.00	0.50	0.96	0.96	0.71	0.96	0.96	0.96	0.71	0.23
Delay/Veh:	136.7	47.9	0.0	59.4	65.6	65.6	53.4	55.9	55.9	112.4	49.1	40.2
User DelAdj:	1.00	1.00	1.00	1.00	1.00	1.00	1.00	1.00	1.00	1.00	1.00	1.00
AdjDel/Veh:	136.7	47.9	0.0	59.4	65.6	65.6	53.4	55.9	55.9	112.4	49.1	40.2
LOS by Move:	F	D	A	E	E	E	D	E	E	F	D	D
HCM2k95thQ:	13	16	0	11	46	46	25	57	57	21	27	8

Note: Queue reported is the number of cars per lane.

BART Phase II Extension Project

Level Of Service Computation Report
 2000 HCM Operations (Future Volume Alternative)
 AM - 2035 Project Conditions

Intersection #3683: McLAUGHLIN/STORY

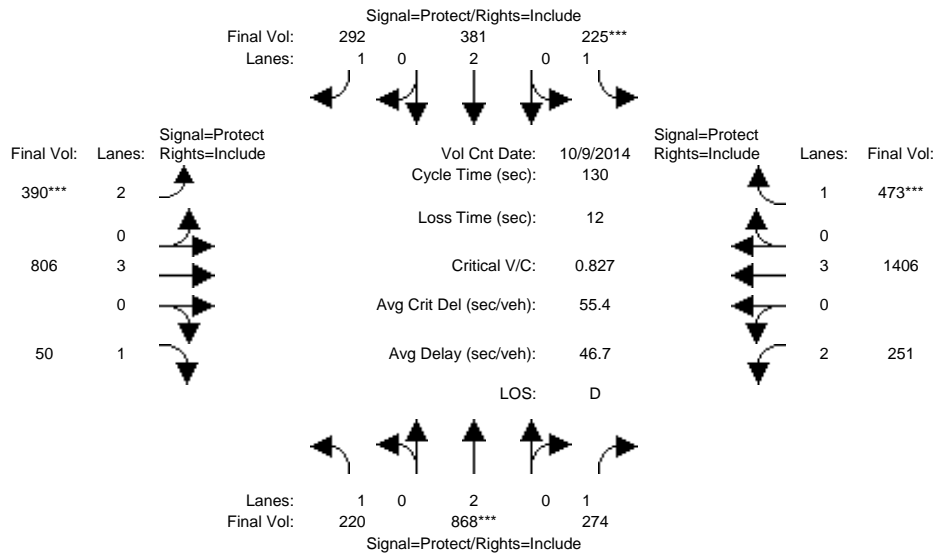

Approach:	North Bound			South Bound			East Bound			West Bound		
Movement:	L	T	R	L	T	R	L	T	R	L	T	R
Min. Green:	7	10	10	7	10	10	7	10	10	7	10	10
Y+R:	4.0	4.0	4.0	4.0	4.0	4.0	4.0	4.0	4.0	4.0	4.0	4.0
Volume Module: >> Count Date: 9 Oct 2014 <<												
Base Vol:	220	868	274	225	381	292	390	806	50	251	1406	473
Growth Adj:	1.00	1.00	1.00	1.00	1.00	1.00	1.00	1.00	1.00	1.00	1.00	1.00
Initial Bse:	220	868	274	225	381	292	390	806	50	251	1406	473
Added Vol:	0	0	0	0	0	0	0	0	0	0	0	0
PasserByVol:	0	0	0	0	0	0	0	0	0	0	0	0
Initial Fut:	220	868	274	225	381	292	390	806	50	251	1406	473
User Adj:	1.00	1.00	1.00	1.00	1.00	1.00	1.00	1.00	1.00	1.00	1.00	1.00
PHF Adj:	1.00	1.00	1.00	1.00	1.00	1.00	1.00	1.00	1.00	1.00	1.00	1.00
PHF Volume:	220	868	274	225	381	292	390	806	50	251	1406	473
Reduct Vol:	0	0	0	0	0	0	0	0	0	0	0	0
Reduced Vol:	220	868	274	225	381	292	390	806	50	251	1406	473
PCE Adj:	1.00	1.00	1.00	1.00	1.00	1.00	1.00	1.00	1.00	1.00	1.00	1.00
MLF Adj:	1.00	1.00	1.00	1.00	1.00	1.00	1.00	1.00	1.00	1.00	1.00	1.00
FinalVolume:	220	868	274	225	381	292	390	806	50	251	1406	473
Saturation Flow Module:												
Sat/Lane:	1900	1900	1900	1900	1900	1900	1900	1900	1900	1900	1900	1900
Adjustment:	0.92	1.00	0.92	0.92	1.00	0.92	0.83	1.00	0.92	0.83	1.00	0.92
Lanes:	1.00	2.00	1.00	1.00	2.00	1.00	2.00	3.00	1.00	2.00	3.00	1.00
Final Sat.:	1750	3800	1750	1750	3800	1750	3150	5700	1750	3150	5700	1750
Capacity Analysis Module:												
Vol/Sat:	0.13	0.23	0.16	0.13	0.10	0.17	0.12	0.14	0.03	0.08	0.25	0.27
Crit Moves:	****			****			****			****		
Green Time:	24.1	35.9	35.9	20.2	32.0	32.0	19.5	39.6	39.6	22.3	42.5	42.5
Volume/Cap:	0.68	0.83	0.57	0.83	0.41	0.68	0.83	0.46	0.09	0.46	0.76	0.83
Delay/Veh:	55.0	49.7	42.0	71.8	41.4	48.7	65.2	36.8	32.4	49.1	40.9	50.1
User DelAdj:	1.00	1.00	1.00	1.00	1.00	1.00	1.00	1.00	1.00	1.00	1.00	1.00
AdjDel/Veh:	55.0	49.7	42.0	71.8	41.4	48.7	65.2	36.8	32.4	49.1	40.9	50.1
LOS by Move:	E	D	D	E	D	D	E	D	C	D	D	D
HCM2k95thQ:	18	31	19	19	12	21	21	16	3	10	29	34

Note: Queue reported is the number of cars per lane.

BART Phase II Extension Project

Level Of Service Computation Report
2000 HCM Operations (Future Volume Alternative)
PM - 2035 Project Conditions

Intersection #3683: McLAUGHLIN/STORY

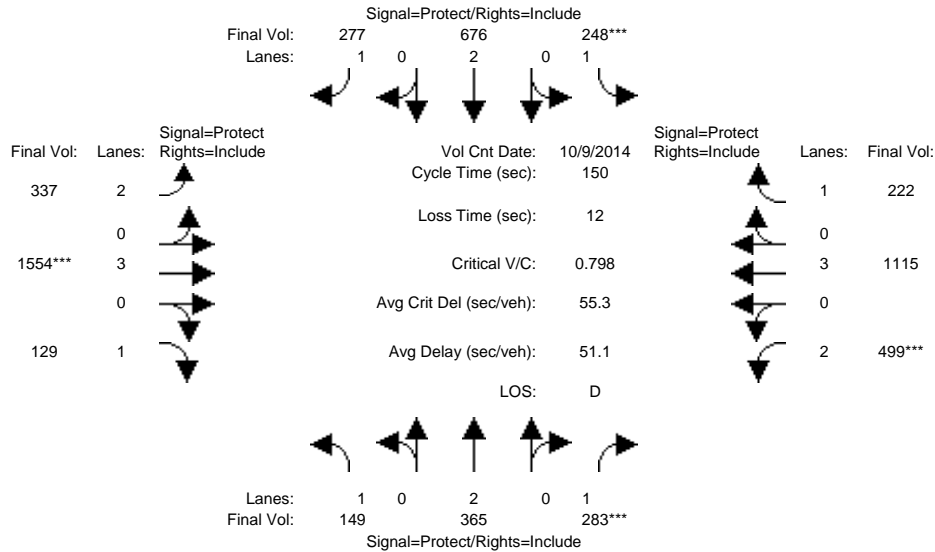

Approach:	North Bound			South Bound			East Bound			West Bound		
	L	T	R	L	T	R	L	T	R	L	T	R
Min. Green:	7	10	10	7	10	10	7	10	10	7	10	10
Y+R:	4.0	4.0	4.0	4.0	4.0	4.0	4.0	4.0	4.0	4.0	4.0	4.0

Volume Module:	>> Count Date: 9 Oct 2014 <<											
Base Vol:	149	365	283	248	676	277	337	1554	129	499	1115	222
Growth Adj:	1.00	1.00	1.00	1.00	1.00	1.00	1.00	1.00	1.00	1.00	1.00	1.00
Initial Bse:	149	365	283	248	676	277	337	1554	129	499	1115	222
Added Vol:	0	0	0	0	0	0	0	0	0	0	0	0
PasserByVol:	0	0	0	0	0	0	0	0	0	0	0	0
Initial Fut:	149	365	283	248	676	277	337	1554	129	499	1115	222
User Adj:	1.00	1.00	1.00	1.00	1.00	1.00	1.00	1.00	1.00	1.00	1.00	1.00
PHF Adj:	1.00	1.00	1.00	1.00	1.00	1.00	1.00	1.00	1.00	1.00	1.00	1.00
PHF Volume:	149	365	283	248	676	277	337	1554	129	499	1115	222
Reduct Vol:	0	0	0	0	0	0	0	0	0	0	0	0
Reduced Vol:	149	365	283	248	676	277	337	1554	129	499	1115	222
PCE Adj:	1.00	1.00	1.00	1.00	1.00	1.00	1.00	1.00	1.00	1.00	1.00	1.00
MLF Adj:	1.00	1.00	1.00	1.00	1.00	1.00	1.00	1.00	1.00	1.00	1.00	1.00
FinalVolume:	149	365	283	248	676	277	337	1554	129	499	1115	222

Saturation Flow Module:												
Sat/Lane:	1900	1900	1900	1900	1900	1900	1900	1900	1900	1900	1900	1900
Adjustment:	0.92	1.00	0.92	0.92	1.00	0.92	0.83	1.00	0.92	0.83	1.00	0.92
Lanes:	1.00	2.00	1.00	1.00	2.00	1.00	2.00	3.00	1.00	2.00	3.00	1.00
Final Sat.:	1750	3800	1750	1750	3800	1750	3150	5700	1750	3150	5700	1750

Capacity Analysis Module:												
Vol/Sat:	0.09	0.10	0.16	0.14	0.18	0.16	0.11	0.27	0.07	0.16	0.20	0.13
Crit Moves:			****	****				****		****		
Green Time:	18.5	30.4	30.4	26.6	38.6	38.6	28.6	51.2	51.2	29.8	52.4	52.4
Volume/Cap:	0.69	0.47	0.80	0.80	0.69	0.62	0.56	0.80	0.22	0.80	0.56	0.36
Delay/Veh:	72.3	53.2	68.9	72.6	52.5	51.7	56.2	47.1	35.3	64.4	39.9	36.8
User DelAdj:	1.00	1.00	1.00	1.00	1.00	1.00	1.00	1.00	1.00	1.00	1.00	1.00
AdjDel/Veh:	72.3	53.2	68.9	72.6	52.5	51.7	56.2	47.1	35.3	64.4	39.9	36.8
LOS by Move:	E	D	E	E	D	D	E	D	D	E	D	D
HCM2k95thQ:	16	14	27	22	25	22	17	38	9	24	24	15

Note: Queue reported is the number of cars per lane.

BART Phase II Extension Project

Level Of Service Computation Report
2000 HCM Operations (Future Volume Alternative)
AM - 2035 Project Conditions

Intersection #3762: SAN ANTONIO/24TH

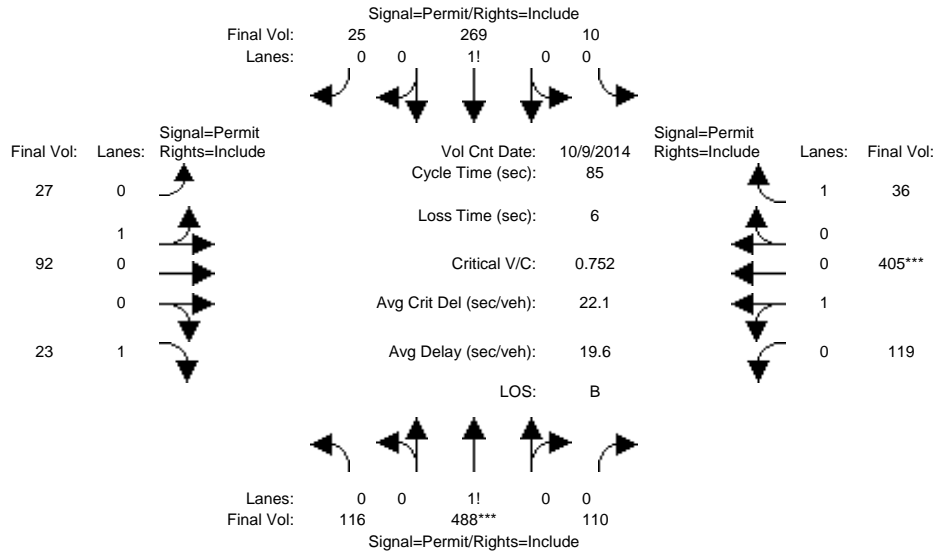

Approach:	North Bound			South Bound			East Bound			West Bound		
Movement:	L	T	R	L	T	R	L	T	R	L	T	R
Min. Green:	10	10	10	10	10	10	10	10	10	10	10	10
Y+R:	4.0	4.0	4.0	4.0	4.0	4.0	4.0	4.0	4.0	4.0	4.0	4.0
Volume Module: >> Count Date: 9 Oct 2014 <<												
Base Vol:	116	488	110	10	269	25	27	92	23	119	405	36
Growth Adj:	1.00	1.00	1.00	1.00	1.00	1.00	1.00	1.00	1.00	1.00	1.00	1.00
Initial Bse:	116	488	110	10	269	25	27	92	23	119	405	36
Added Vol:	0	0	0	0	0	0	0	0	0	0	0	0
PasserByVol:	0	0	0	0	0	0	0	0	0	0	0	0
Initial Fut:	116	488	110	10	269	25	27	92	23	119	405	36
User Adj:	1.00	1.00	1.00	1.00	1.00	1.00	1.00	1.00	1.00	1.00	1.00	1.00
PHF Adj:	1.00	1.00	1.00	1.00	1.00	1.00	1.00	1.00	1.00	1.00	1.00	1.00
PHF Volume:	116	488	110	10	269	25	27	92	23	119	405	36
Reduct Vol:	0	0	0	0	0	0	0	0	0	0	0	0
Reduced Vol:	116	488	110	10	269	25	27	92	23	119	405	36
PCE Adj:	1.00	1.00	1.00	1.00	1.00	1.00	1.00	1.00	1.00	1.00	1.00	1.00
MLF Adj:	1.00	1.00	1.00	1.00	1.00	1.00	1.00	1.00	1.00	1.00	1.00	1.00
FinalVolume:	116	488	110	10	269	25	27	92	23	119	405	36
Saturation Flow Module:												
Sat/Lane:	1900	1900	1900	1900	1900	1900	1900	1900	1900	1900	1900	1900
Adjustment:	0.92	0.92	0.92	0.92	0.92	0.92	0.95	0.95	0.92	0.95	0.95	0.92
Lanes:	0.16	0.69	0.15	0.03	0.89	0.08	0.23	0.77	1.00	0.23	0.77	1.00
Final Sat.:	284	1196	270	58	1549	144	408	1392	1750	409	1391	1750
Capacity Analysis Module:												
Vol/Sat:	0.41	0.41	0.41	0.17	0.17	0.17	0.07	0.07	0.01	0.29	0.29	0.02
Crit Moves:	****									****		
Green Time:	46.1	46.1	46.1	46.1	46.1	46.1	32.9	32.9	32.9	32.9	32.9	32.9
Volume/Cap:	0.75	0.75	0.75	0.32	0.32	0.32	0.17	0.17	0.03	0.75	0.75	0.05
Delay/Veh:	18.5	18.5	18.5	11.0	11.0	11.0	17.2	17.2	16.2	27.1	27.1	16.3
User DelAdj:	1.00	1.00	1.00	1.00	1.00	1.00	1.00	1.00	1.00	1.00	1.00	1.00
AdjDel/Veh:	18.5	18.5	18.5	11.0	11.0	11.0	17.2	17.2	16.2	27.1	27.1	16.3
LOS by Move:	B	B	B	B	B	B	B	B	B	C	C	B
HCM2k95thQ:	28	28	28	9	9	9	4	4	1	23	23	1

Note: Queue reported is the number of cars per lane.

BART Phase II Extension Project

Level Of Service Computation Report
2000 HCM Operations (Future Volume Alternative)
PM - 2035 Project Conditions

Intersection #3762: SAN ANTONIO/24TH

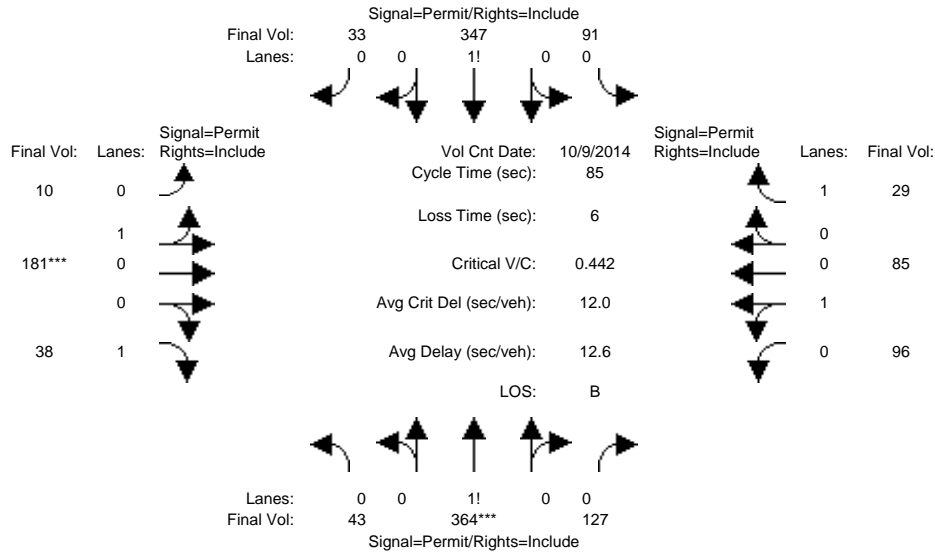

Approach:	North Bound			South Bound			East Bound			West Bound		
	L	T	R	L	T	R	L	T	R	L	T	R
Min. Green:	10	10	10	10	10	10	10	10	10	10	10	10
Y+R:	4.0	4.0	4.0	4.0	4.0	4.0	4.0	4.0	4.0	4.0	4.0	4.0

Volume Module:	>> Count Date: 9 Oct 2014 <<											
Base Vol:	43	364	127	91	347	33	10	181	38	96	85	29
Growth Adj:	1.00	1.00	1.00	1.00	1.00	1.00	1.00	1.00	1.00	1.00	1.00	1.00
Initial Bse:	43	364	127	91	347	33	10	181	38	96	85	29
Added Vol:	0	0	0	0	0	0	0	0	0	0	0	0
PasserByVol:	0	0	0	0	0	0	0	0	0	0	0	0
Initial Fut:	43	364	127	91	347	33	10	181	38	96	85	29
User Adj:	1.00	1.00	1.00	1.00	1.00	1.00	1.00	1.00	1.00	1.00	1.00	1.00
PHF Adj:	1.00	1.00	1.00	1.00	1.00	1.00	1.00	1.00	1.00	1.00	1.00	1.00
PHF Volume:	43	364	127	91	347	33	10	181	38	96	85	29
Reduct Vol:	0	0	0	0	0	0	0	0	0	0	0	0
Reduced Vol:	43	364	127	91	347	33	10	181	38	96	85	29
PCE Adj:	1.00	1.00	1.00	1.00	1.00	1.00	1.00	1.00	1.00	1.00	1.00	1.00
MLF Adj:	1.00	1.00	1.00	1.00	1.00	1.00	1.00	1.00	1.00	1.00	1.00	1.00
FinalVolume:	43	364	127	91	347	33	10	181	38	96	85	29

Saturation Flow Module:												
Sat/Lane:	1900	1900	1900	1900	1900	1900	1900	1900	1900	1900	1900	1900
Adjustment:	0.92	0.92	0.92	0.92	0.92	0.92	0.95	0.95	0.92	0.95	0.95	0.92
Lanes:	0.08	0.68	0.24	0.19	0.74	0.07	0.05	0.95	1.00	0.53	0.47	1.00
Final Sat.:	141	1193	416	338	1289	123	94	1706	1750	955	845	1750

Capacity Analysis Module:												
Vol/Sat:	0.31	0.31	0.31	0.27	0.27	0.27	0.11	0.11	0.02	0.10	0.10	0.02
Crit Moves:	****						****					
Green Time:	58.6	58.6	58.6	58.6	58.6	58.6	20.4	20.4	20.4	20.4	20.4	20.4
Volume/Cap:	0.44	0.44	0.44	0.39	0.39	0.39	0.44	0.44	0.09	0.42	0.42	0.07
Delay/Veh:	6.2	6.2	6.2	5.8	5.8	5.8	28.2	28.2	25.2	28.0	28.0	25.0
User DelAdj:	1.00	1.00	1.00	1.00	1.00	1.00	1.00	1.00	1.00	1.00	1.00	1.00
AdjDel/Veh:	6.2	6.2	6.2	5.8	5.8	5.8	28.2	28.2	25.2	28.0	28.0	25.0
LOS by Move:	A	A	A	A	A	A	C	C	C	C	C	C
HCM2k95thQ:	13	13	13	11	11	11	9	9	2	8	8	1

Note: Queue reported is the number of cars per lane.

BART Phase II Extension Project

Level Of Service Computation Report
2000 HCM Operations (Future Volume Alternative)
AM - 2035 Project Conditions

Intersection #3783: SANTA CLARA/17TH

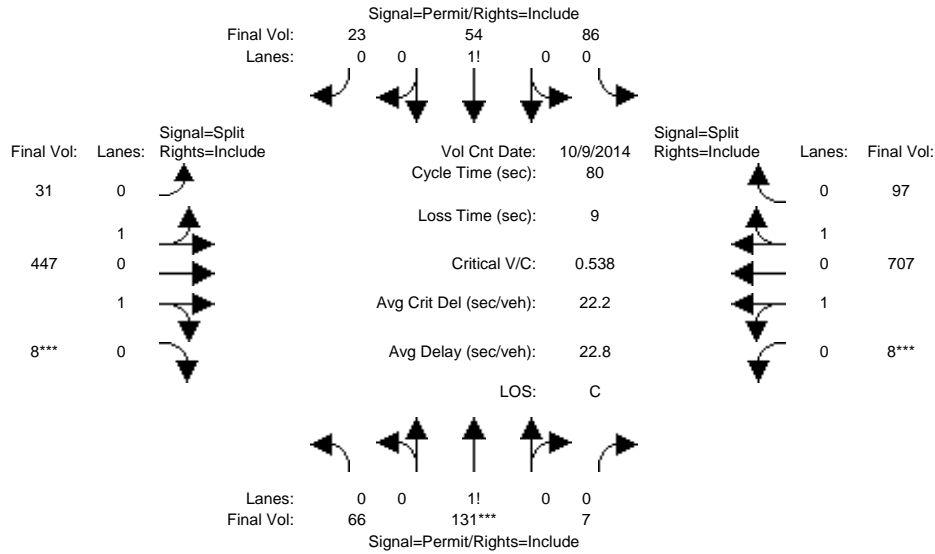

Approach:	North Bound			South Bound			East Bound			West Bound		
	L	T	R	L	T	R	L	T	R	L	T	R
Min. Green:	10	10	10	10	10	10	10	10	10	10	10	10
Y+R:	4.0	4.0	4.0	4.0	4.0	4.0	4.0	4.0	4.0	4.0	4.0	4.0
Volume Module: >> Count Date: 9 Oct 2014 <<												
Base Vol:	66	131	7	86	54	23	31	447	8	8	707	97
Growth Adj:	1.00	1.00	1.00	1.00	1.00	1.00	1.00	1.00	1.00	1.00	1.00	1.00
Initial Bse:	66	131	7	86	54	23	31	447	8	8	707	97
Added Vol:	0	0	0	0	0	0	0	0	0	0	0	0
PasserByVol:	0	0	0	0	0	0	0	0	0	0	0	0
Initial Fut:	66	131	7	86	54	23	31	447	8	8	707	97
User Adj:	1.00	1.00	1.00	1.00	1.00	1.00	1.00	1.00	1.00	1.00	1.00	1.00
PHF Adj:	1.00	1.00	1.00	1.00	1.00	1.00	1.00	1.00	1.00	1.00	1.00	1.00
PHF Volume:	66	131	7	86	54	23	31	447	8	8	707	97
Reduct Vol:	0	0	0	0	0	0	0	0	0	0	0	0
Reduced Vol:	66	131	7	86	54	23	31	447	8	8	707	97
PCE Adj:	1.00	1.00	1.00	1.00	1.00	1.00	1.00	1.00	1.00	1.00	1.00	1.00
MLF Adj:	1.00	1.00	1.00	1.00	1.00	1.00	1.00	1.00	1.00	1.00	1.00	1.00
Final Volume:	66	131	7	86	54	23	31	447	8	8	707	97
Saturation Flow Module:												
Sat/Lane:	1900	1900	1900	1900	1900	1900	1900	1900	1900	1900	1900	1900
Adjustment:	0.92	0.92	0.92	0.92	0.92	0.92	0.95	0.95	0.95	0.95	0.95	0.95
Lanes:	0.32	0.65	0.03	0.53	0.33	0.14	0.13	1.84	0.03	0.02	1.74	0.24
Final Sat.:	566	1124	60	923	580	247	230	3311	59	35	3134	430
Capacity Analysis Module:												
Vol/Sat:	0.12	0.12	0.12	0.09	0.09	0.09	0.14	0.14	0.14	0.23	0.23	0.23
Crit Moves:	****						****			****		
Green Time:	17.3	17.3	17.3	17.3	17.3	17.3	20.1	20.1	20.1	33.6	33.6	33.6
Volume/Cap:	0.54	0.54	0.54	0.43	0.43	0.43	0.54	0.54	0.54	0.54	0.54	0.54
Delay/Veh:	29.3	29.3	29.3	27.8	27.8	27.8	26.6	26.6	26.6	17.8	17.8	17.8
User DelAdj:	1.00	1.00	1.00	1.00	1.00	1.00	1.00	1.00	1.00	1.00	1.00	1.00
AdjDel/Veh:	29.3	29.3	29.3	27.8	27.8	27.8	26.6	26.6	26.6	17.8	17.8	17.8
LOS by Move:	C	C	C	C	C	C	C	C	C	B	B	B
HCM2k95thQ:	11	11	11	8	8	8	12	12	12	15	15	15

Note: Queue reported is the number of cars per lane.

BART Phase II Extension Project

Level Of Service Computation Report
2000 HCM Operations (Future Volume Alternative)
PM - 2035 Project Conditions

Intersection #3783: SANTA CLARA/17TH

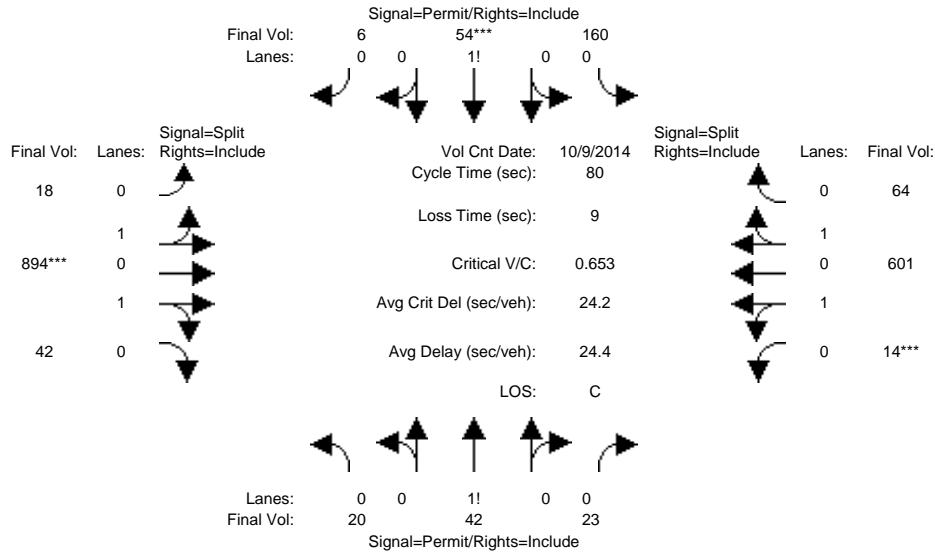

Approach:	North Bound			South Bound			East Bound			West Bound		
	L	T	R	L	T	R	L	T	R	L	T	R
Min. Green:	10	10	10	10	10	10	10	10	10	10	10	10
Y+R:	4.0	4.0	4.0	4.0	4.0	4.0	4.0	4.0	4.0	4.0	4.0	4.0
Volume Module: >> Count Date: 9 Oct 2014 <<												
Base Vol:	20	42	23	160	54	6	18	894	42	14	601	64
Growth Adj:	1.00	1.00	1.00	1.00	1.00	1.00	1.00	1.00	1.00	1.00	1.00	1.00
Initial Bse:	20	42	23	160	54	6	18	894	42	14	601	64
Added Vol:	0	0	0	0	0	0	0	0	0	0	0	0
PasserByVol:	0	0	0	0	0	0	0	0	0	0	0	0
Initial Fut:	20	42	23	160	54	6	18	894	42	14	601	64
User Adj:	1.00	1.00	1.00	1.00	1.00	1.00	1.00	1.00	1.00	1.00	1.00	1.00
PHF Adj:	1.00	1.00	1.00	1.00	1.00	1.00	1.00	1.00	1.00	1.00	1.00	1.00
PHF Volume:	20	42	23	160	54	6	18	894	42	14	601	64
Reduct Vol:	0	0	0	0	0	0	0	0	0	0	0	0
Reduced Vol:	20	42	23	160	54	6	18	894	42	14	601	64
PCE Adj:	1.00	1.00	1.00	1.00	1.00	1.00	1.00	1.00	1.00	1.00	1.00	1.00
MLF Adj:	1.00	1.00	1.00	1.00	1.00	1.00	1.00	1.00	1.00	1.00	1.00	1.00
FinalVolume:	20	42	23	160	54	6	18	894	42	14	601	64
Saturation Flow Module:												
Sat/Lane:	1900	1900	1900	1900	1900	1900	1900	1900	1900	1900	1900	1900
Adjustment:	0.92	0.92	0.92	0.92	0.92	0.92	0.95	0.95	0.95	0.95	0.95	0.95
Lanes:	0.24	0.49	0.27	0.73	0.24	0.03	0.04	1.87	0.09	0.04	1.77	0.19
Final Sat.:	412	865	474	1273	430	48	68	3374	158	74	3186	339
Capacity Analysis Module:												
Vol/Sat:	0.05	0.05	0.05	0.13	0.13	0.13	0.27	0.27	0.27	0.19	0.19	0.19
Crit Moves:				****			****			****		
Green Time:	15.4	15.4	15.4	15.4	15.4	15.4	32.5	32.5	32.5	23.1	23.1	23.1
Volume/Cap:	0.25	0.25	0.25	0.65	0.65	0.65	0.65	0.65	0.65	0.65	0.65	0.65
Delay/Veh:	27.8	27.8	27.8	34.4	34.4	34.4	20.3	20.3	20.3	26.4	26.4	26.4
User DelAdj:	1.00	1.00	1.00	1.00	1.00	1.00	1.00	1.00	1.00	1.00	1.00	1.00
AdjDel/Veh:	27.8	27.8	27.8	34.4	34.4	34.4	20.3	20.3	20.3	26.4	26.4	26.4
LOS by Move:	C	C	C	C	C	C	C	C	C	C	C	C
HCM2k95thQ:	4	4	4	13	13	13	20	20	20	15	15	15

Note: Queue reported is the number of cars per lane.

BART Phase II Extension Project

Level Of Service Computation Report
 2000 HCM Operations (Future Volume Alternative)
 AM - 2035 Project Conditions

Intersection #3788: SANTA CLARA/28TH

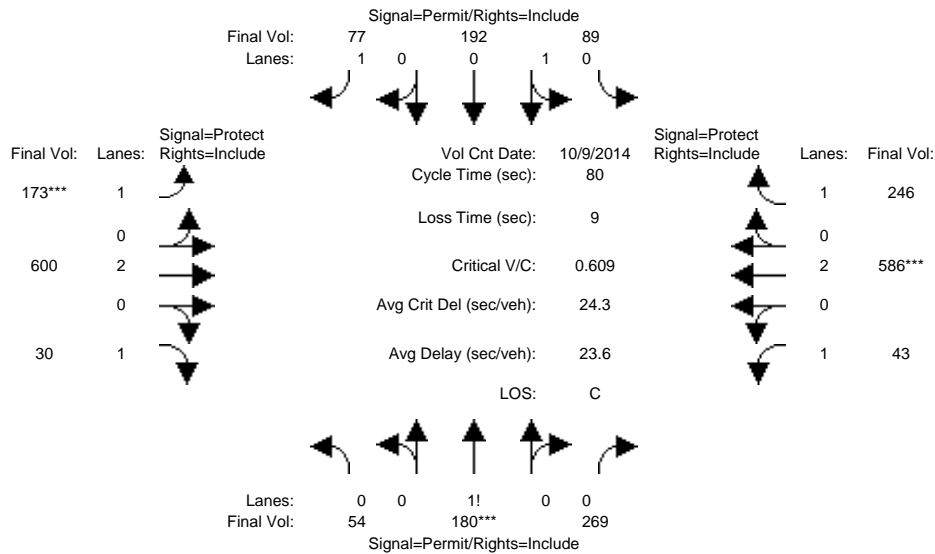

Approach:	North Bound			South Bound			East Bound			West Bound		
Movement:	L	T	R	L	T	R	L	T	R	L	T	R
Min. Green:	10	10	10	10	10	10	7	10	10	7	10	10
Y+R:	4.0	4.0	4.0	4.0	4.0	4.0	4.0	4.0	4.0	4.0	4.0	4.0
Volume Module: >> Count Date: 9 Oct 2014 <<												
Base Vol:	54	180	269	89	192	77	173	600	30	43	586	246
Growth Adj:	1.00	1.00	1.00	1.00	1.00	1.00	1.00	1.00	1.00	1.00	1.00	1.00
Initial Bse:	54	180	269	89	192	77	173	600	30	43	586	246
Added Vol:	0	0	0	0	0	0	0	0	0	0	0	0
PasserByVol:	0	0	0	0	0	0	0	0	0	0	0	0
Initial Fut:	54	180	269	89	192	77	173	600	30	43	586	246
User Adj:	1.00	1.00	1.00	1.00	1.00	1.00	1.00	1.00	1.00	1.00	1.00	1.00
PHF Adj:	1.00	1.00	1.00	1.00	1.00	1.00	1.00	1.00	1.00	1.00	1.00	1.00
PHF Volume:	54	180	269	89	192	77	173	600	30	43	586	246
Reduct Vol:	0	0	0	0	0	0	0	0	0	0	0	0
Reduced Vol:	54	180	269	89	192	77	173	600	30	43	586	246
PCE Adj:	1.00	1.00	1.00	1.00	1.00	1.00	1.00	1.00	1.00	1.00	1.00	1.00
MLF Adj:	1.00	1.00	1.00	1.00	1.00	1.00	1.00	1.00	1.00	1.00	1.00	1.00
FinalVolume:	54	180	269	89	192	77	173	600	30	43	586	246
Saturation Flow Module:												
Sat/Lane:	1900	1900	1900	1900	1900	1900	1900	1900	1900	1900	1900	1900
Adjustment:	0.92	0.92	0.92	0.95	0.95	0.92	0.92	1.00	0.92	0.92	1.00	0.92
Lanes:	0.11	0.36	0.53	0.32	0.68	1.00	1.00	2.00	1.00	1.00	2.00	1.00
Final Sat.:	188	626	936	570	1230	1750	1750	3800	1750	1750	3800	1750
Capacity Analysis Module:												
Vol/Sat:	0.29	0.29	0.29	0.16	0.16	0.04	0.10	0.16	0.02	0.02	0.15	0.14
Crit Moves:	****						****			****		
Green Time:	37.8	37.8	37.8	37.8	37.8	37.8	13.0	21.4	21.4	11.9	20.3	20.3
Volume/Cap:	0.61	0.61	0.61	0.33	0.33	0.09	0.61	0.59	0.06	0.17	0.61	0.56
Delay/Veh:	17.0	17.0	17.0	13.4	13.4	11.7	35.0	26.4	21.9	30.1	27.5	27.5
User DelAdj:	1.00	1.00	1.00	1.00	1.00	1.00	1.00	1.00	1.00	1.00	1.00	1.00
AdjDel/Veh:	17.0	17.0	17.0	13.4	13.4	11.7	35.0	26.4	21.9	30.1	27.5	27.5
LOS by Move:	B	B	B	B	B	B	C	C	C	C	C	C
HCM2k95thQ:	18	18	18	9	9	2	9	12	1	2	12	11

Note: Queue reported is the number of cars per lane.

BART Phase II Extension Project

Level Of Service Computation Report
2000 HCM Operations (Future Volume Alternative)
PM - 2035 Project Conditions

Intersection #3788: SANTA CLARA/28TH

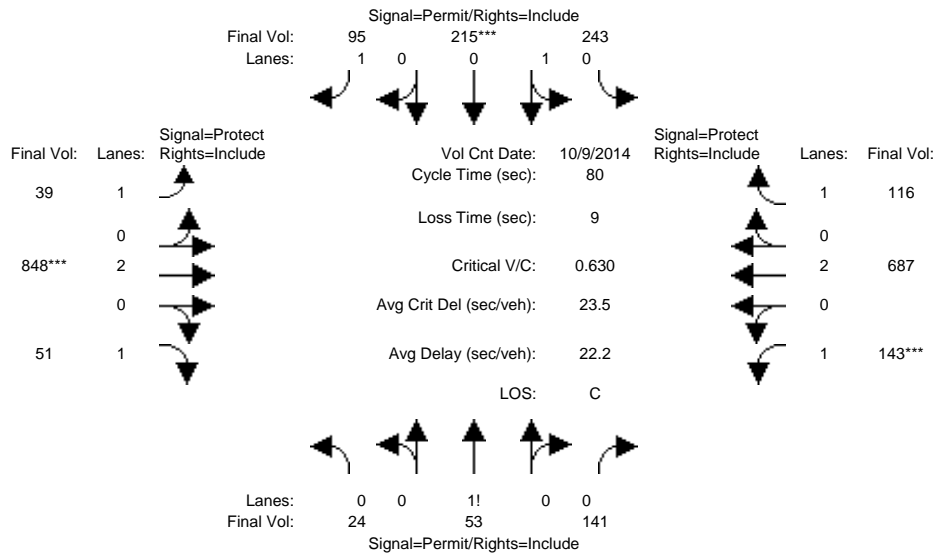

Approach:	North Bound			South Bound			East Bound			West Bound		
	L	T	R	L	T	R	L	T	R	L	T	R
Min. Green:	10	10	10	10	10	10	7	10	10	7	10	10
Y+R:	4.0	4.0	4.0	4.0	4.0	4.0	4.0	4.0	4.0	4.0	4.0	4.0
Volume Module: >> Count Date: 9 Oct 2014 <<												
Base Vol:	24	53	141	243	215	95	39	848	51	143	687	116
Growth Adj:	1.00	1.00	1.00	1.00	1.00	1.00	1.00	1.00	1.00	1.00	1.00	1.00
Initial Bse:	24	53	141	243	215	95	39	848	51	143	687	116
Added Vol:	0	0	0	0	0	0	0	0	0	0	0	0
PasserByVol:	0	0	0	0	0	0	0	0	0	0	0	0
Initial Fut:	24	53	141	243	215	95	39	848	51	143	687	116
User Adj:	1.00	1.00	1.00	1.00	1.00	1.00	1.00	1.00	1.00	1.00	1.00	1.00
PHF Adj:	1.00	1.00	1.00	1.00	1.00	1.00	1.00	1.00	1.00	1.00	1.00	1.00
PHF Volume:	24	53	141	243	215	95	39	848	51	143	687	116
Reduct Vol:	0	0	0	0	0	0	0	0	0	0	0	0
Reduced Vol:	24	53	141	243	215	95	39	848	51	143	687	116
PCE Adj:	1.00	1.00	1.00	1.00	1.00	1.00	1.00	1.00	1.00	1.00	1.00	1.00
MLF Adj:	1.00	1.00	1.00	1.00	1.00	1.00	1.00	1.00	1.00	1.00	1.00	1.00
FinalVolume:	24	53	141	243	215	95	39	848	51	143	687	116
Saturation Flow Module:												
Sat/Lane:	1900	1900	1900	1900	1900	1900	1900	1900	1900	1900	1900	1900
Adjustment:	0.92	0.92	0.92	0.95	0.95	0.92	0.92	1.00	0.92	0.92	1.00	0.92
Lanes:	0.11	0.24	0.65	0.53	0.47	1.00	1.00	2.00	1.00	1.00	2.00	1.00
Final Sat.:	193	425	1132	955	845	1750	1750	3800	1750	1750	3800	1750
Capacity Analysis Module:												
Vol/Sat:	0.12	0.12	0.12	0.25	0.25	0.05	0.02	0.22	0.03	0.08	0.18	0.07
Crit Moves:				****			****			****		
Green Time:	32.3	32.3	32.3	32.3	32.3	32.3	12.6	28.3	28.3	10.4	26.1	26.1
Volume/Cap:	0.31	0.31	0.31	0.63	0.63	0.13	0.14	0.63	0.08	0.63	0.55	0.20
Delay/Veh:	16.5	16.5	16.5	20.9	20.9	15.1	29.3	22.5	17.2	38.6	22.7	19.6
User DelAdj:	1.00	1.00	1.00	1.00	1.00	1.00	1.00	1.00	1.00	1.00	1.00	1.00
AdjDel/Veh:	16.5	16.5	16.5	20.9	20.9	15.1	29.3	22.5	17.2	38.6	22.7	19.6
LOS by Move:	B	B	B	C	C	B	C	C	B	D	C	B
HCM2k95thQ:	8	8	8	19	19	3	2	16	2	7	13	4

Note: Queue reported is the number of cars per lane.

BART Phase II Extension Project

Level Of Service Computation Report
2000 HCM Operations (Future Volume Alternative)
AM - 2035 Project Conditions

Intersection #3789: SANTA CLARA/21ST

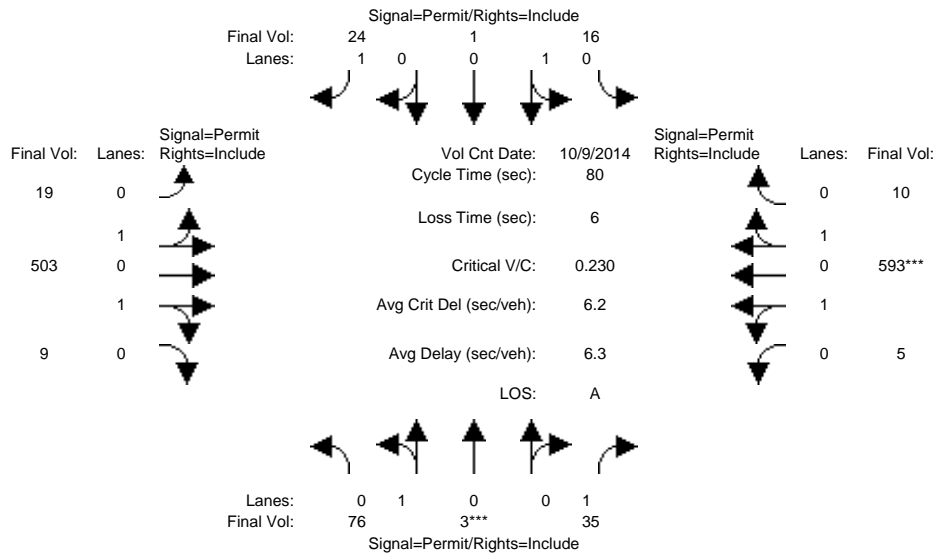

Approach:	North Bound			South Bound			East Bound			West Bound		
	L	T	R	L	T	R	L	T	R	L	T	R
Min. Green:	10	10	10	10	10	10	10	10	10	10	10	10
Y+R:	4.0	4.0	4.0	4.0	4.0	4.0	4.0	4.0	4.0	4.0	4.0	4.0
Volume Module: >> Count Date: 9 Oct 2014 <<												
Base Vol:	76	3	35	16	1	24	19	503	9	5	593	10
Growth Adj:	1.00	1.00	1.00	1.00	1.00	1.00	1.00	1.00	1.00	1.00	1.00	1.00
Initial Bse:	76	3	35	16	1	24	19	503	9	5	593	10
Added Vol:	0	0	0	0	0	0	0	0	0	0	0	0
PasserByVol:	0	0	0	0	0	0	0	0	0	0	0	0
Initial Fut:	76	3	35	16	1	24	19	503	9	5	593	10
User Adj:	1.00	1.00	1.00	1.00	1.00	1.00	1.00	1.00	1.00	1.00	1.00	1.00
PHF Adj:	1.00	1.00	1.00	1.00	1.00	1.00	1.00	1.00	1.00	1.00	1.00	1.00
PHF Volume:	76	3	35	16	1	24	19	503	9	5	593	10
Reduct Vol:	0	0	0	0	0	0	0	0	0	0	0	0
Reduced Vol:	76	3	35	16	1	24	19	503	9	5	593	10
PCE Adj:	1.00	1.00	1.00	1.00	1.00	1.00	1.00	1.00	1.00	1.00	1.00	1.00
MLF Adj:	1.00	1.00	1.00	1.00	1.00	1.00	1.00	1.00	1.00	1.00	1.00	1.00
FinalVolume:	76	3	35	16	1	24	19	503	9	5	593	10
Saturation Flow Module:												
Sat/Lane:	1900	1900	1900	1900	1900	1900	1900	1900	1900	1900	1900	1900
Adjustment:	0.95	0.95	0.92	0.95	0.95	0.92	0.95	0.95	0.95	0.95	0.95	0.95
Lanes:	0.96	0.04	1.00	0.94	0.06	1.00	0.07	1.90	0.03	0.02	1.95	0.03
Final Sat.:	1732	68	1750	1694	106	1750	129	3410	61	30	3511	59
Capacity Analysis Module:												
Vol/Sat:	0.04	0.04	0.02	0.01	0.01	0.01	0.15	0.15	0.15	0.17	0.17	0.17
Crit Moves:	****											
Green Time:	15.3	15.3	15.3	15.3	15.3	15.3	58.7	58.7	58.7	58.7	58.7	58.7
Volume/Cap:	0.23	0.23	0.10	0.05	0.05	0.07	0.20	0.20	0.20	0.23	0.23	0.23
Delay/Veh:	27.7	27.7	26.9	26.5	26.5	26.6	3.4	3.4	3.4	3.4	3.4	3.4
User DelAdj:	1.00	1.00	1.00	1.00	1.00	1.00	1.00	1.00	1.00	1.00	1.00	1.00
AdjDel/Veh:	27.7	27.7	26.9	26.5	26.5	26.6	3.4	3.4	3.4	3.4	3.4	3.4
LOS by Move:	C	C	C	C	C	C	A	A	A	A	A	A
HCM2k95thQ:	4	4	2	1	1	1	4	4	4	5	5	5

Note: Queue reported is the number of cars per lane.

BART Phase II Extension Project

Level Of Service Computation Report
2000 HCM Operations (Future Volume Alternative)
PM - 2035 Project Conditions

Intersection #3789: SANTA CLARA/21ST

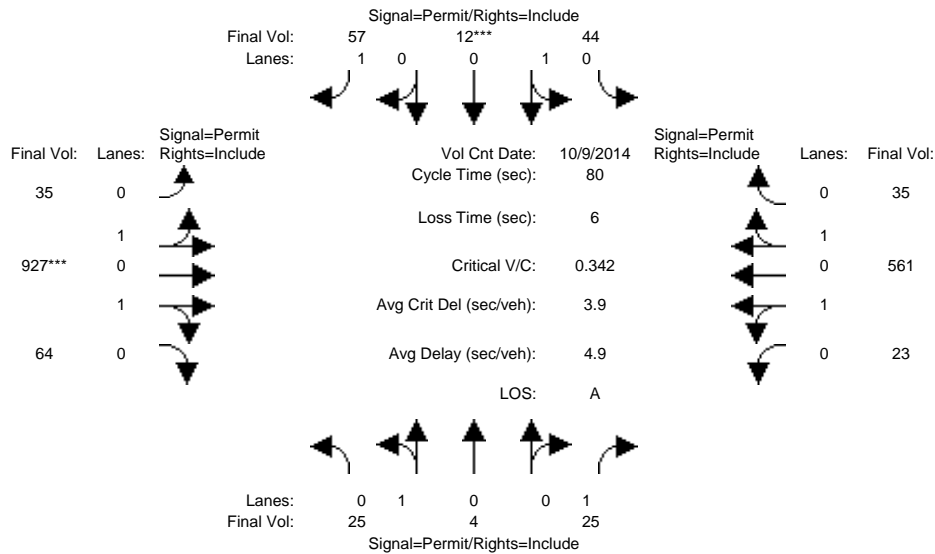

Approach:	North Bound			South Bound			East Bound			West Bound		
	L	T	R	L	T	R	L	T	R	L	T	R
Min. Green:	10	10	10	10	10	10	10	10	10	10	10	10
Y+R:	4.0	4.0	4.0	4.0	4.0	4.0	4.0	4.0	4.0	4.0	4.0	4.0
Volume Module: >> Count Date: 9 Oct 2014 <<												
Base Vol:	25	4	25	44	12	57	35	927	64	23	561	35
Growth Adj:	1.00	1.00	1.00	1.00	1.00	1.00	1.00	1.00	1.00	1.00	1.00	1.00
Initial Bse:	25	4	25	44	12	57	35	927	64	23	561	35
Added Vol:	0	0	0	0	0	0	0	0	0	0	0	0
PasserByVol:	0	0	0	0	0	0	0	0	0	0	0	0
Initial Fut:	25	4	25	44	12	57	35	927	64	23	561	35
User Adj:	1.00	1.00	1.00	1.00	1.00	1.00	1.00	1.00	1.00	1.00	1.00	1.00
PHF Adj:	1.00	1.00	1.00	1.00	1.00	1.00	1.00	1.00	1.00	1.00	1.00	1.00
PHF Volume:	25	4	25	44	12	57	35	927	64	23	561	35
Reduct Vol:	0	0	0	0	0	0	0	0	0	0	0	0
Reduced Vol:	25	4	25	44	12	57	35	927	64	23	561	35
PCE Adj:	1.00	1.00	1.00	1.00	1.00	1.00	1.00	1.00	1.00	1.00	1.00	1.00
MLF Adj:	1.00	1.00	1.00	1.00	1.00	1.00	1.00	1.00	1.00	1.00	1.00	1.00
FinalVolume:	25	4	25	44	12	57	35	927	64	23	561	35
Saturation Flow Module:												
Sat/Lane:	1900	1900	1900	1900	1900	1900	1900	1900	1900	1900	1900	1900
Adjustment:	0.95	0.95	0.92	0.95	0.95	0.92	0.95	0.95	0.95	0.95	0.95	0.95
Lanes:	0.86	0.14	1.00	0.79	0.21	1.00	0.07	1.81	0.12	0.07	1.82	0.11
Final Sat.:	1552	248	1750	1414	386	1750	123	3253	225	134	3263	204
Capacity Analysis Module:												
Vol/Sat:	0.02	0.02	0.01	0.03	0.03	0.03	0.29	0.29	0.29	0.17	0.17	0.17
Crit Moves:				****			****					
Green Time:	10.0	10.0	10.0	10.0	10.0	10.0	64.0	64.0	64.0	64.0	64.0	64.0
Volume/Cap:	0.13	0.13	0.11	0.25	0.25	0.26	0.36	0.36	0.36	0.21	0.21	0.21
Delay/Veh:	31.4	31.4	31.3	32.2	32.2	32.3	2.3	2.3	2.3	2.0	2.0	2.0
User DelAdj:	1.00	1.00	1.00	1.00	1.00	1.00	1.00	1.00	1.00	1.00	1.00	1.00
AdjDel/Veh:	31.4	31.4	31.3	32.2	32.2	32.3	2.3	2.3	2.3	2.0	2.0	2.0
LOS by Move:	C	C	C	C	C	C	A	A	A	A	A	A
HCM2k95thQ:	2	2	1	3	3	3	7	7	7	4	4	4

Note: Queue reported is the number of cars per lane.

BART Phase II Extension Project

Level Of Service Computation Report
2000 HCM Operations (Future Volume Alternative)
AM - 2035 Project Conditions

Intersection #3790: SANTA CLARA/24TH

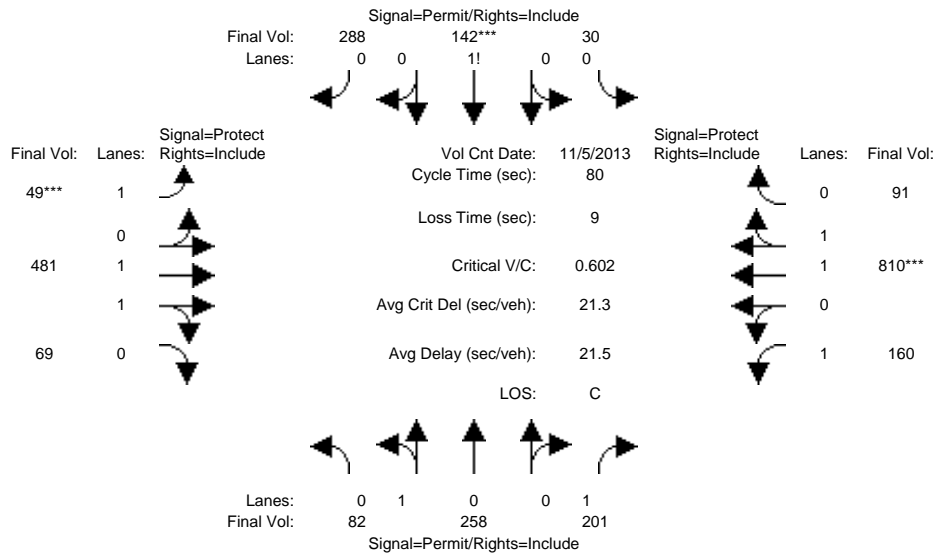

Approach:	North Bound			South Bound			East Bound			West Bound		
	L	T	R	L	T	R	L	T	R	L	T	R
Min. Green:	10	10	10	10	10	10	7	10	10	7	10	10
Y+R:	4.0	4.0	4.0	4.0	4.0	4.0	4.0	4.0	4.0	4.0	4.0	4.0

Volume Module:	>>	Count	Date:	5 Nov 2013	<<											
Base Vol:	82	258	201	30	142	288	49	481	69	160	810	91				
Growth Adj:	1.00	1.00	1.00	1.00	1.00	1.00	1.00	1.00	1.00	1.00	1.00	1.00				
Initial Bse:	82	258	201	30	142	288	49	481	69	160	810	91				
Added Vol:	0	0	0	0	0	0	0	0	0	0	0	0				
PasserByVol:	0	0	0	0	0	0	0	0	0	0	0	0				
Initial Fut:	82	258	201	30	142	288	49	481	69	160	810	91				
User Adj:	1.00	1.00	1.00	1.00	1.00	1.00	1.00	1.00	1.00	1.00	1.00	1.00				
PHF Adj:	1.00	1.00	1.00	1.00	1.00	1.00	1.00	1.00	1.00	1.00	1.00	1.00				
PHF Volume:	82	258	201	30	142	288	49	481	69	160	810	91				
Reduct Vol:	0	0	0	0	0	0	0	0	0	0	0	0				
Reduced Vol:	82	258	201	30	142	288	49	481	69	160	810	91				
PCE Adj:	1.00	1.00	1.00	1.00	1.00	1.00	1.00	1.00	1.00	1.00	1.00	1.00				
MLF Adj:	1.00	1.00	1.00	1.00	1.00	1.00	1.00	1.00	1.00	1.00	1.00	1.00				
FinalVolume:	82	258	201	30	142	288	49	481	69	160	810	91				

Saturation Flow Module:												
Sat/Lane:	1900	1900	1900	1900	1900	1900	1900	1900	1900	1900	1900	1900
Adjustment:	0.95	0.95	0.92	0.92	0.92	0.92	0.92	0.98	0.95	0.92	0.98	0.95
Lanes:	0.24	0.76	1.00	0.06	0.31	0.63	1.00	1.74	0.26	1.00	1.79	0.21
Final Sat.:	434	1366	1750	114	540	1096	1750	3235	464	1750	3326	374

Capacity Analysis Module:												
Vol/Sat:	0.19	0.19	0.11	0.26	0.26	0.26	0.03	0.15	0.15	0.09	0.24	0.24
Crit Moves:				****	****	****	****				****	****
Green Time:	33.2	33.2	33.2	33.2	33.2	33.2	7.0	23.4	23.4	14.4	30.8	30.8
Volume/Cap:	0.45	0.45	0.28	0.63	0.63	0.63	0.32	0.51	0.51	0.51	0.63	0.63
Delay/Veh:	17.3	17.3	15.7	20.4	20.4	20.4	35.5	23.9	23.9	31.0	21.0	21.0
User DelAdj:	1.00	1.00	1.00	1.00	1.00	1.00	1.00	1.00	1.00	1.00	1.00	1.00
AdjDel/Veh:	17.3	17.3	15.7	20.4	20.4	20.4	35.5	23.9	23.9	31.0	21.0	21.0
LOS by Move:	B	B	B	C	C	C	D	C	C	C	C	C
HCM2k95thQ:	12	12	7	19	19	19	2	11	11	8	17	17

Note: Queue reported is the number of cars per lane.

BART Phase II Extension Project

Level Of Service Computation Report
2000 HCM Operations (Future Volume Alternative)
PM - 2035 Project Conditions

Intersection #3790: SANTA CLARA/24TH

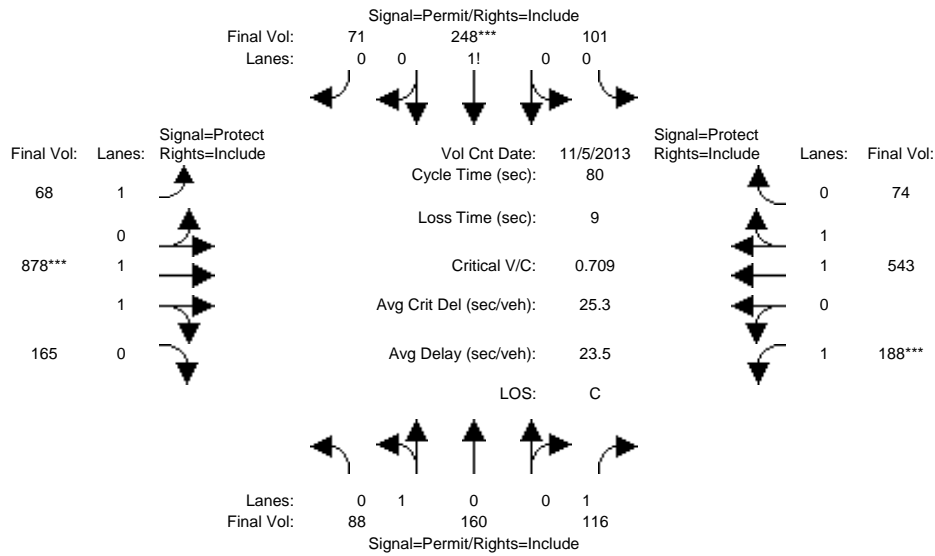

Approach:	North Bound			South Bound			East Bound			West Bound		
Movement:	L	T	R	L	T	R	L	T	R	L	T	R
Min. Green:	10	10	10	10	10	10	7	10	10	7	10	10
Y+R:	4.0	4.0	4.0	4.0	4.0	4.0	4.0	4.0	4.0	4.0	4.0	4.0
Volume Module: >> Count Date: 5 Nov 2013 <<												
Base Vol:	88	160	116	101	248	71	68	878	165	188	543	74
Growth Adj:	1.00	1.00	1.00	1.00	1.00	1.00	1.00	1.00	1.00	1.00	1.00	1.00
Initial Bse:	88	160	116	101	248	71	68	878	165	188	543	74
Added Vol:	0	0	0	0	0	0	0	0	0	0	0	0
PasserByVol:	0	0	0	0	0	0	0	0	0	0	0	0
Initial Fut:	88	160	116	101	248	71	68	878	165	188	543	74
User Adj:	1.00	1.00	1.00	1.00	1.00	1.00	1.00	1.00	1.00	1.00	1.00	1.00
PHF Adj:	1.00	1.00	1.00	1.00	1.00	1.00	1.00	1.00	1.00	1.00	1.00	1.00
PHF Volume:	88	160	116	101	248	71	68	878	165	188	543	74
Reduct Vol:	0	0	0	0	0	0	0	0	0	0	0	0
Reduced Vol:	88	160	116	101	248	71	68	878	165	188	543	74
PCE Adj:	1.00	1.00	1.00	1.00	1.00	1.00	1.00	1.00	1.00	1.00	1.00	1.00
MLF Adj:	1.00	1.00	1.00	1.00	1.00	1.00	1.00	1.00	1.00	1.00	1.00	1.00
FinalVolume:	88	160	116	101	248	71	68	878	165	188	543	74
Saturation Flow Module:												
Sat/Lane:	1900	1900	1900	1900	1900	1900	1900	1900	1900	1900	1900	1900
Adjustment:	0.95	0.95	0.92	0.92	0.92	0.92	0.92	0.98	0.95	0.92	0.98	0.95
Lanes:	0.35	0.65	1.00	0.24	0.59	0.17	1.00	1.67	0.33	1.00	1.75	0.25
Final Sat.:	639	1161	1750	421	1033	296	1750	3114	585	1750	3256	444
Capacity Analysis Module:												
Vol/Sat:	0.14	0.14	0.07	0.24	0.24	0.24	0.04	0.28	0.28	0.11	0.17	0.17
Crit Moves:				****				****				****
Green Time:	27.1	27.1	27.1	27.1	27.1	27.1	15.1	31.8	31.8	12.1	28.8	28.8
Volume/Cap:	0.41	0.41	0.20	0.71	0.71	0.71	0.21	0.71	0.71	0.71	0.46	0.46
Delay/Veh:	20.7	20.7	18.9	27.0	27.0	27.0	27.7	21.8	21.8	40.9	19.9	19.9
User DelAdj:	1.00	1.00	1.00	1.00	1.00	1.00	1.00	1.00	1.00	1.00	1.00	1.00
AdjDel/Veh:	20.7	20.7	18.9	27.0	27.0	27.0	27.7	21.8	21.8	40.9	19.9	19.9
LOS by Move:	C	C	B	C	C	C	C	C	C	D	B	B
HCM2k95thQ:	9	9	4	20	20	20	3	20	20	10	11	11

Note: Queue reported is the number of cars per lane.

BART Phase II Extension Project

Level Of Service Computation Report
2000 HCM Operations (Future Volume Alternative)
AM - 2035 Project Conditions

Intersection #3832: 24TH/WILLIAM

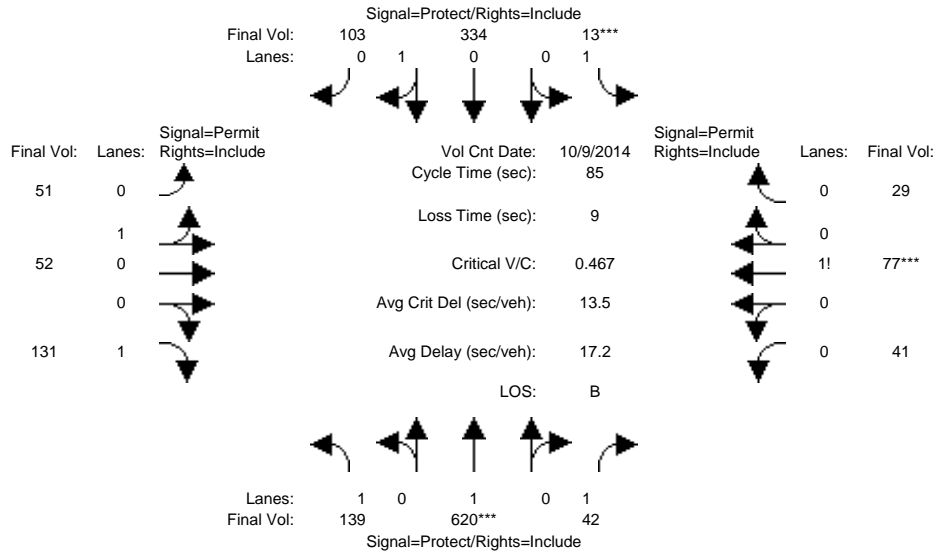

Approach:	North Bound			South Bound			East Bound			West Bound		
Movement:	L	T	R	L	T	R	L	T	R	L	T	R
Min. Green:	7	10	10	7	10	10	10	10	10	10	10	10
Y+R:	4.0	4.0	4.0	4.0	4.0	4.0	4.0	4.0	4.0	4.0	4.0	4.0
Volume Module: >> Count Date: 9 Oct 2014 <<												
Base Vol:	139	620	42	13	334	103	51	52	131	41	77	29
Growth Adj:	1.00	1.00	1.00	1.00	1.00	1.00	1.00	1.00	1.00	1.00	1.00	1.00
Initial Bse:	139	620	42	13	334	103	51	52	131	41	77	29
Added Vol:	0	0	0	0	0	0	0	0	0	0	0	0
PasserByVol:	0	0	0	0	0	0	0	0	0	0	0	0
Initial Fut:	139	620	42	13	334	103	51	52	131	41	77	29
User Adj:	1.00	1.00	1.00	1.00	1.00	1.00	1.00	1.00	1.00	1.00	1.00	1.00
PHF Adj:	1.00	1.00	1.00	1.00	1.00	1.00	1.00	1.00	1.00	1.00	1.00	1.00
PHF Volume:	139	620	42	13	334	103	51	52	131	41	77	29
Reduct Vol:	0	0	0	0	0	0	0	0	0	0	0	0
Reduced Vol:	139	620	42	13	334	103	51	52	131	41	77	29
PCE Adj:	1.00	1.00	1.00	1.00	1.00	1.00	1.00	1.00	1.00	1.00	1.00	1.00
MLF Adj:	1.00	1.00	1.00	1.00	1.00	1.00	1.00	1.00	1.00	1.00	1.00	1.00
FinalVolume:	139	620	42	13	334	103	51	52	131	41	77	29
Saturation Flow Module:												
Sat/Lane:	1900	1900	1900	1900	1900	1900	1900	1900	1900	1900	1900	1900
Adjustment:	0.92	1.00	0.92	0.92	0.95	0.95	0.95	0.95	0.92	0.92	0.92	0.92
Lanes:	1.00	1.00	1.00	1.00	0.76	0.24	0.50	0.50	1.00	0.28	0.52	0.20
Final Sat.:	1750	1900	1750	1750	1376	424	891	909	1750	488	917	345
Capacity Analysis Module:												
Vol/Sat:	0.08	0.33	0.02	0.01	0.24	0.24	0.06	0.06	0.07	0.08	0.08	0.08
Crit Moves:	****			****						****		
Green Time:	15.7	54.9	54.9	7.0	46.2	46.2	14.1	14.1	14.1	14.1	14.1	14.1
Volume/Cap:	0.43	0.51	0.04	0.09	0.45	0.45	0.34	0.34	0.45	0.51	0.51	0.51
Delay/Veh:	31.6	8.3	5.5	36.3	12.0	12.0	32.0	32.0	33.0	33.7	33.7	33.7
User DelAdj:	1.00	1.00	1.00	1.00	1.00	1.00	1.00	1.00	1.00	1.00	1.00	1.00
AdjDel/Veh:	31.6	8.3	5.5	36.3	12.0	12.0	32.0	32.0	33.0	33.7	33.7	33.7
LOS by Move:	C	A	A	D	B	B	C	C	C	C	C	C
HCM2k95thQ:	7	16	1	1	13	13	6	6	8	9	9	9

Note: Queue reported is the number of cars per lane.

BART Phase II Extension Project

Level Of Service Computation Report
 2000 HCM Operations (Future Volume Alternative)
 PM - 2035 Project Conditions

Intersection #3832: 24TH/WILLIAM

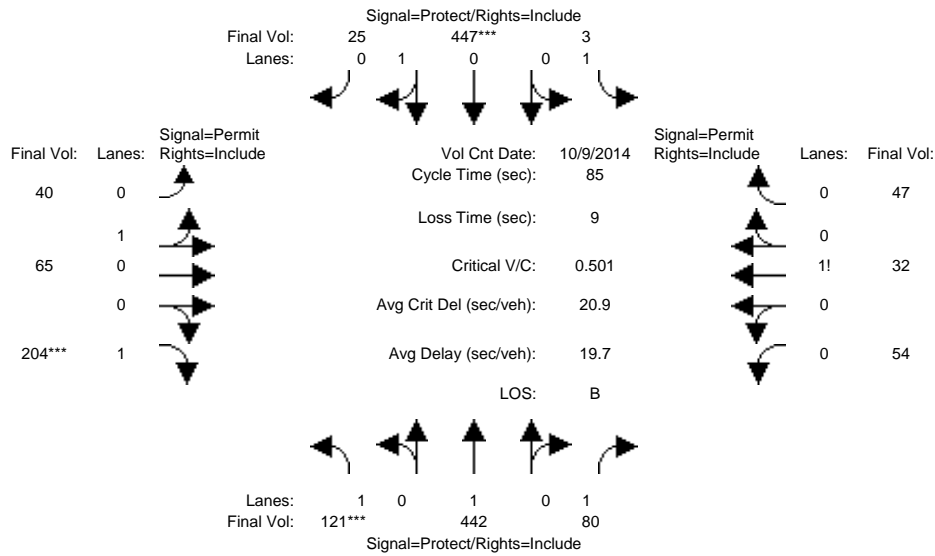

Approach:	North Bound			South Bound			East Bound			West Bound		
	L	T	R	L	T	R	L	T	R	L	T	R
Min. Green:	7	10	10	7	10	10	10	10	10	10	10	10
Y+R:	4.0	4.0	4.0	4.0	4.0	4.0	4.0	4.0	4.0	4.0	4.0	4.0
Volume Module: >> Count Date: 9 Oct 2014 <<												
Base Vol:	121	442	80	3	447	25	40	65	204	54	32	47
Growth Adj:	1.00	1.00	1.00	1.00	1.00	1.00	1.00	1.00	1.00	1.00	1.00	1.00
Initial Bse:	121	442	80	3	447	25	40	65	204	54	32	47
Added Vol:	0	0	0	0	0	0	0	0	0	0	0	0
PasserByVol:	0	0	0	0	0	0	0	0	0	0	0	0
Initial Fut:	121	442	80	3	447	25	40	65	204	54	32	47
User Adj:	1.00	1.00	1.00	1.00	1.00	1.00	1.00	1.00	1.00	1.00	1.00	1.00
PHF Adj:	1.00	1.00	1.00	1.00	1.00	1.00	1.00	1.00	1.00	1.00	1.00	1.00
PHF Volume:	121	442	80	3	447	25	40	65	204	54	32	47
Reduct Vol:	0	0	0	0	0	0	0	0	0	0	0	0
Reduced Vol:	121	442	80	3	447	25	40	65	204	54	32	47
PCE Adj:	1.00	1.00	1.00	1.00	1.00	1.00	1.00	1.00	1.00	1.00	1.00	1.00
MLF Adj:	1.00	1.00	1.00	1.00	1.00	1.00	1.00	1.00	1.00	1.00	1.00	1.00
FinalVolume:	121	442	80	3	447	25	40	65	204	54	32	47
Saturation Flow Module:												
Sat/Lane:	1900	1900	1900	1900	1900	1900	1900	1900	1900	1900	1900	1900
Adjustment:	0.92	1.00	0.92	0.92	0.95	0.95	0.95	0.95	0.92	0.92	0.92	0.92
Lanes:	1.00	1.00	1.00	1.00	0.95	0.05	0.38	0.62	1.00	0.41	0.24	0.35
Final Sat.:	1750	1900	1750	1750	1705	95	686	1114	1750	711	421	618
Capacity Analysis Module:												
Vol/Sat:	0.07	0.23	0.05	0.00	0.26	0.26	0.06	0.06	0.12	0.08	0.08	0.08
Crit Moves:	****				****				****			
Green Time:	11.7	41.5	41.5	14.7	44.5	44.5	19.8	19.8	19.8	19.8	19.8	19.8
Volume/Cap:	0.50	0.48	0.09	0.01	0.50	0.50	0.25	0.25	0.50	0.33	0.33	0.33
Delay/Veh:	35.6	14.9	11.7	29.1	13.5	13.5	26.9	26.9	29.3	27.6	27.6	27.6
User DelAdj:	1.00	1.00	1.00	1.00	1.00	1.00	1.00	1.00	1.00	1.00	1.00	1.00
AdjDel/Veh:	35.6	14.9	11.7	29.1	13.5	13.5	26.9	26.9	29.3	27.6	27.6	27.6
LOS by Move:	D	B	B	C	B	B	C	C	C	C	C	C
HCM2k95thQ:	6	14	2	0	15	15	5	5	11	7	7	7

Note: Queue reported is the number of cars per lane.

BART Phase II Extension Project

Level Of Service Computation Report
2000 HCM Operations (Future Volume Alternative)
AM - 2035 Project Conditions

Intersection #4005: JULIAN/28TH

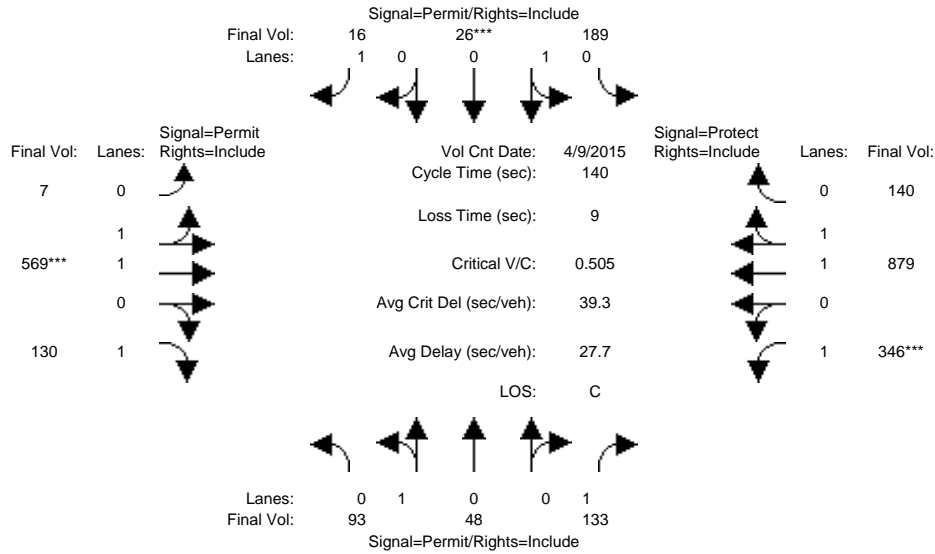

Approach:	North Bound			South Bound			East Bound			West Bound		
	L	T	R	L	T	R	L	T	R	L	T	R
Min. Green:	10	10	10	10	10	10	10	10	10	7	10	10
Y+R:	4.0	4.0	4.0	4.0	4.0	4.0	4.0	4.0	4.0	4.0	4.0	4.0
Volume Module: >> Count Date: 9 Apr 2015 <<												
Base Vol:	93	48	133	189	26	16	7	569	130	346	879	140
Growth Adj:	1.00	1.00	1.00	1.00	1.00	1.00	1.00	1.00	1.00	1.00	1.00	1.00
Initial Bse:	93	48	133	189	26	16	7	569	130	346	879	140
Added Vol:	0	0	0	0	0	0	0	0	0	0	0	0
PasserByVol:	0	0	0	0	0	0	0	0	0	0	0	0
Initial Fut:	93	48	133	189	26	16	7	569	130	346	879	140
User Adj:	1.00	1.00	1.00	1.00	1.00	1.00	1.00	1.00	1.00	1.00	1.00	1.00
PHF Adj:	1.00	1.00	1.00	1.00	1.00	1.00	1.00	1.00	1.00	1.00	1.00	1.00
PHF Volume:	93	48	133	189	26	16	7	569	130	346	879	140
Reduct Vol:	0	0	0	0	0	0	0	0	0	0	0	0
Reduced Vol:	93	48	133	189	26	16	7	569	130	346	879	140
PCE Adj:	1.00	1.00	1.00	1.00	1.00	1.00	1.00	1.00	1.00	1.00	1.00	1.00
MLF Adj:	1.00	1.00	1.00	1.00	1.00	1.00	1.00	1.00	1.00	1.00	1.00	1.00
FinalVolume:	93	48	133	189	26	16	7	569	130	346	879	140
Saturation Flow Module:												
Sat/Lane:	1900	1900	1900	1900	1900	1900	1900	1900	1900	1900	1900	1900
Adjustment:	0.95	0.95	0.92	0.95	0.95	0.92	0.95	0.97	0.92	0.92	0.98	0.95
Lanes:	0.66	0.34	1.00	0.88	0.12	1.00	0.02	1.98	1.00	1.00	1.72	0.28
Final Sat.:	1187	613	1750	1582	218	1750	45	3655	1750	1750	3191	508
Capacity Analysis Module:												
Vol/Sat:	0.08	0.08	0.08	0.12	0.12	0.01	0.16	0.16	0.07	0.20	0.28	0.28
Crit Moves:				****			****			****		
Green Time:	33.1	33.1	33.1	33.1	33.1	33.1	43.1	43.1	43.1	54.8	97.9	97.9
Volume/Cap:	0.33	0.33	0.32	0.51	0.51	0.04	0.51	0.51	0.24	0.51	0.39	0.39
Delay/Veh:	44.7	44.7	44.6	47.3	47.3	41.2	40.1	40.1	36.4	32.9	8.8	8.8
User DelAdj:	1.00	1.00	1.00	1.00	1.00	1.00	1.00	1.00	1.00	1.00	1.00	1.00
AdjDel/Veh:	44.7	44.7	44.6	47.3	47.3	41.2	40.1	40.1	36.4	32.9	8.8	8.8
LOS by Move:	D	D	D	D	D	D	D	D	D	C	A	A
HCM2k95thQ:	10	10	10	16	16	1	19	19	8	21	17	17

Note: Queue reported is the number of cars per lane.

BART Phase II Extension Project

Level Of Service Computation Report
 2000 HCM Operations (Future Volume Alternative)
 PM - 2035 Project Conditions

Intersection #4005: JULIAN/28TH

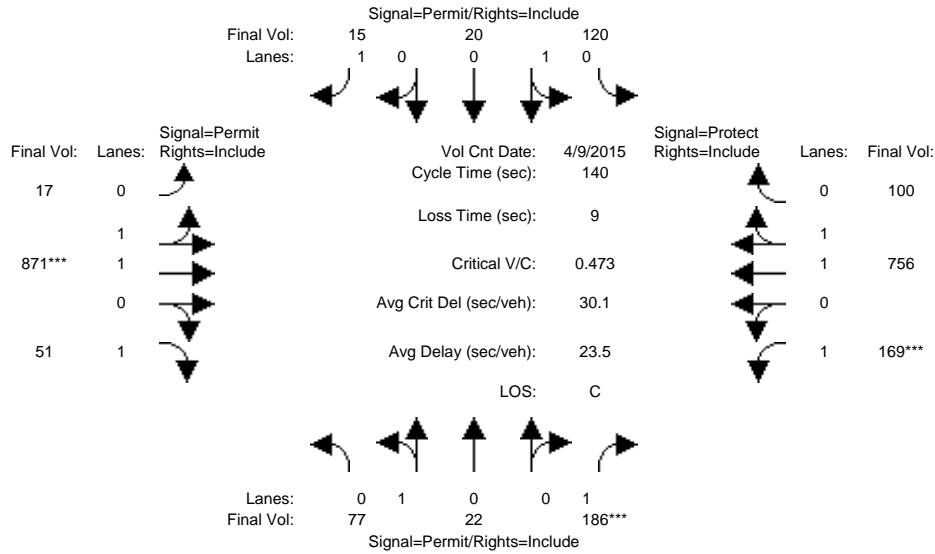

Approach:	North Bound			South Bound			East Bound			West Bound		
	L	T	R	L	T	R	L	T	R	L	T	R
Min. Green:	10	10	10	10	10	10	10	10	10	7	10	10
Y+R:	4.0	4.0	4.0	4.0	4.0	4.0	4.0	4.0	4.0	4.0	4.0	4.0
Volume Module: >> Count Date: 9 Apr 2015 <<												
Base Vol:	77	22	186	120	20	15	17	871	51	169	756	100
Growth Adj:	1.00	1.00	1.00	1.00	1.00	1.00	1.00	1.00	1.00	1.00	1.00	1.00
Initial Bse:	77	22	186	120	20	15	17	871	51	169	756	100
Added Vol:	0	0	0	0	0	0	0	0	0	0	0	0
PasserByVol:	0	0	0	0	0	0	0	0	0	0	0	0
Initial Fut:	77	22	186	120	20	15	17	871	51	169	756	100
User Adj:	1.00	1.00	1.00	1.00	1.00	1.00	1.00	1.00	1.00	1.00	1.00	1.00
PHF Adj:	1.00	1.00	1.00	1.00	1.00	1.00	1.00	1.00	1.00	1.00	1.00	1.00
PHF Volume:	77	22	186	120	20	15	17	871	51	169	756	100
Reduct Vol:	0	0	0	0	0	0	0	0	0	0	0	0
Reduced Vol:	77	22	186	120	20	15	17	871	51	169	756	100
PCE Adj:	1.00	1.00	1.00	1.00	1.00	1.00	1.00	1.00	1.00	1.00	1.00	1.00
MLF Adj:	1.00	1.00	1.00	1.00	1.00	1.00	1.00	1.00	1.00	1.00	1.00	1.00
FinalVolume:	77	22	186	120	20	15	17	871	51	169	756	100
Saturation Flow Module:												
Sat/Lane:	1900	1900	1900	1900	1900	1900	1900	1900	1900	1900	1900	1900
Adjustment:	0.95	0.95	0.92	0.95	0.95	0.92	0.95	0.97	0.92	0.92	0.98	0.95
Lanes:	0.78	0.22	1.00	0.86	0.14	1.00	0.04	1.96	1.00	1.00	1.76	0.24
Final Sat.:	1400	400	1750	1543	257	1750	71	3629	1750	1750	3267	432
Capacity Analysis Module:												
Vol/Sat:	0.06	0.06	0.11	0.08	0.08	0.01	0.24	0.24	0.03	0.10	0.23	0.23
Crit Moves:	****						****			****		
Green Time:	31.4	31.4	31.4	31.4	31.4	31.4	71.0	71.0	71.0	28.6	99.6	99.6
Volume/Cap:	0.24	0.24	0.47	0.35	0.35	0.04	0.47	0.47	0.06	0.47	0.33	0.33
Delay/Veh:	44.9	44.9	48.0	46.2	46.2	42.5	22.6	22.6	17.5	50.1	7.7	7.7
User DelAdj:	1.00	1.00	1.00	1.00	1.00	1.00	1.00	1.00	1.00	1.00	1.00	1.00
AdjDel/Veh:	44.9	44.9	48.0	46.2	46.2	42.5	22.6	22.6	17.5	50.1	7.7	7.7
LOS by Move:	D	D	D	D	D	D	C	C	B	D	A	A
HCM2k95thQ:	7	7	14	10	10	1	22	22	2	13	13	13

Note: Queue reported is the number of cars per lane.

BART Phase II Extension Project

Level Of Service Computation Report
2000 HCM Operations (Future Volume Alternative)
AM - 2035 Project Conditions

Intersection #4022: SANTA CLARA/26TH

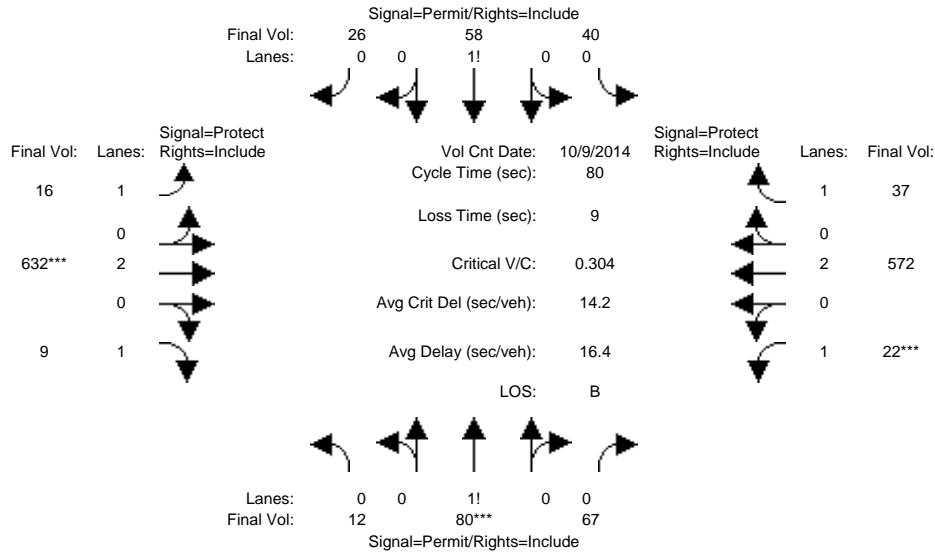

Approach:	North Bound			South Bound			East Bound			West Bound		
	L	T	R	L	T	R	L	T	R	L	T	R
Min. Green:	10	10	10	10	10	10	7	10	10	7	10	10
Y+R:	4.0	4.0	4.0	4.0	4.0	4.0	4.0	4.0	4.0	4.0	4.0	4.0
Volume Module: >> Count Date: 9 Oct 2014 <<												
Base Vol:	12	80	67	40	58	26	16	632	9	22	572	37
Growth Adj:	1.00	1.00	1.00	1.00	1.00	1.00	1.00	1.00	1.00	1.00	1.00	1.00
Initial Bse:	12	80	67	40	58	26	16	632	9	22	572	37
Added Vol:	0	0	0	0	0	0	0	0	0	0	0	0
PasserByVol:	0	0	0	0	0	0	0	0	0	0	0	0
Initial Fut:	12	80	67	40	58	26	16	632	9	22	572	37
User Adj:	1.00	1.00	1.00	1.00	1.00	1.00	1.00	1.00	1.00	1.00	1.00	1.00
PHF Adj:	1.00	1.00	1.00	1.00	1.00	1.00	1.00	1.00	1.00	1.00	1.00	1.00
PHF Volume:	12	80	67	40	58	26	16	632	9	22	572	37
Reduct Vol:	0	0	0	0	0	0	0	0	0	0	0	0
Reduced Vol:	12	80	67	40	58	26	16	632	9	22	572	37
PCE Adj:	1.00	1.00	1.00	1.00	1.00	1.00	1.00	1.00	1.00	1.00	1.00	1.00
MLF Adj:	1.00	1.00	1.00	1.00	1.00	1.00	1.00	1.00	1.00	1.00	1.00	1.00
FinalVolume:	12	80	67	40	58	26	16	632	9	22	572	37
Saturation Flow Module:												
Sat/Lane:	1900	1900	1900	1900	1900	1900	1900	1900	1900	1900	1900	1900
Adjustment:	0.92	0.92	0.92	0.92	0.92	0.92	0.92	1.00	0.92	0.92	1.00	0.92
Lanes:	0.08	0.50	0.42	0.32	0.47	0.21	1.00	2.00	1.00	1.00	2.00	1.00
Final Sat.:	132	881	737	565	819	367	1750	3800	1750	1750	3800	1750
Capacity Analysis Module:												
Vol/Sat:	0.09	0.09	0.09	0.07	0.07	0.07	0.01	0.17	0.01	0.01	0.15	0.02
Crit Moves:	****						****			****		
Green Time:	22.6	22.6	22.6	22.6	22.6	22.6	17.8	41.4	41.4	7.0	30.6	30.6
Volume/Cap:	0.32	0.32	0.32	0.25	0.25	0.25	0.04	0.32	0.01	0.14	0.39	0.06
Delay/Veh:	23.0	23.0	23.0	22.4	22.4	22.4	24.5	11.3	9.4	34.2	18.1	15.6
User DelAdj:	1.00	1.00	1.00	1.00	1.00	1.00	1.00	1.00	1.00	1.00	1.00	1.00
AdjDel/Veh:	23.0	23.0	23.0	22.4	22.4	22.4	24.5	11.3	9.4	34.2	18.1	15.6
LOS by Move:	C	C	C	C	C	C	C	B	A	C	B	B
HCM2k95thQ:	7	7	7	5	5	5	1	9	0	1	10	1

Note: Queue reported is the number of cars per lane.

BART Phase II Extension Project

Level Of Service Computation Report
2000 HCM Operations (Future Volume Alternative)
PM - 2035 Project Conditions

Intersection #4022: SANTA CLARA/26TH

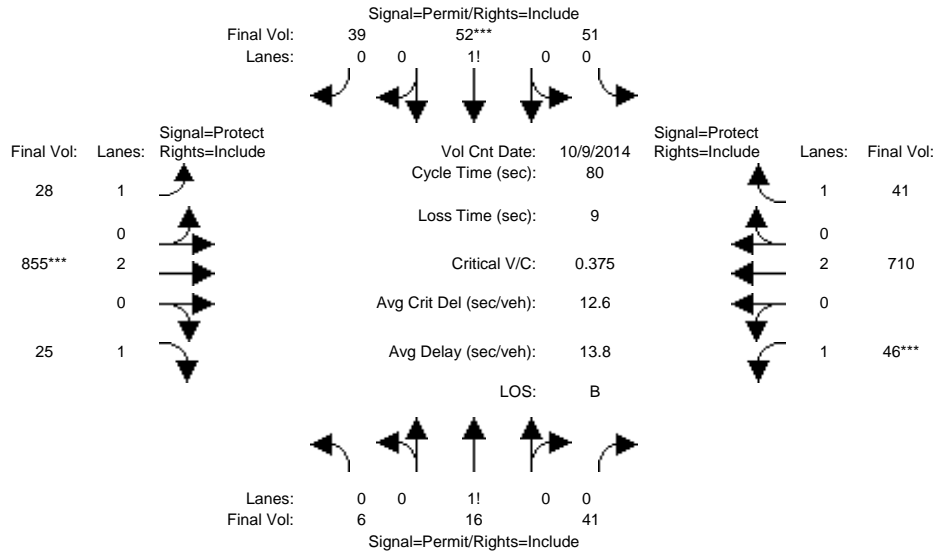

Approach:	North Bound			South Bound			East Bound			West Bound		
	L	T	R	L	T	R	L	T	R	L	T	R
Min. Green:	10	10	10	10	10	10	7	10	10	7	10	10
Y+R:	4.0	4.0	4.0	4.0	4.0	4.0	4.0	4.0	4.0	4.0	4.0	4.0
Volume Module: >> Count Date: 9 Oct 2014 <<												
Base Vol:	6	16	41	51	52	39	28	855	25	46	710	41
Growth Adj:	1.00	1.00	1.00	1.00	1.00	1.00	1.00	1.00	1.00	1.00	1.00	1.00
Initial Bse:	6	16	41	51	52	39	28	855	25	46	710	41
Added Vol:	0	0	0	0	0	0	0	0	0	0	0	0
PasserByVol:	0	0	0	0	0	0	0	0	0	0	0	0
Initial Fut:	6	16	41	51	52	39	28	855	25	46	710	41
User Adj:	1.00	1.00	1.00	1.00	1.00	1.00	1.00	1.00	1.00	1.00	1.00	1.00
PHF Adj:	1.00	1.00	1.00	1.00	1.00	1.00	1.00	1.00	1.00	1.00	1.00	1.00
PHF Volume:	6	16	41	51	52	39	28	855	25	46	710	41
Reduct Vol:	0	0	0	0	0	0	0	0	0	0	0	0
Reduced Vol:	6	16	41	51	52	39	28	855	25	46	710	41
PCE Adj:	1.00	1.00	1.00	1.00	1.00	1.00	1.00	1.00	1.00	1.00	1.00	1.00
MLF Adj:	1.00	1.00	1.00	1.00	1.00	1.00	1.00	1.00	1.00	1.00	1.00	1.00
FinalVolume:	6	16	41	51	52	39	28	855	25	46	710	41
Saturation Flow Module:												
Sat/Lane:	1900	1900	1900	1900	1900	1900	1900	1900	1900	1900	1900	1900
Adjustment:	0.92	0.92	0.92	0.92	0.92	0.92	0.92	1.00	0.92	0.92	1.00	0.92
Lanes:	0.10	0.25	0.65	0.36	0.37	0.27	1.00	2.00	1.00	1.00	2.00	1.00
Final Sat.:	167	444	1139	629	641	481	1750	3800	1750	1750	3800	1750
Capacity Analysis Module:												
Vol/Sat:	0.04	0.04	0.04	0.08	0.08	0.08	0.02	0.23	0.01	0.03	0.19	0.02
Crit Moves:				****			****			****		
Green Time:	17.0	17.0	17.0	17.0	17.0	17.0	17.2	47.0	47.0	7.0	36.8	36.8
Volume/Cap:	0.17	0.17	0.17	0.38	0.38	0.38	0.07	0.38	0.02	0.30	0.41	0.05
Delay/Veh:	26.0	26.0	26.0	27.7	27.7	27.7	25.1	8.9	6.9	35.3	14.5	12.0
User DelAdj:	1.00	1.00	1.00	1.00	1.00	1.00	1.00	1.00	1.00	1.00	1.00	1.00
AdjDel/Veh:	26.0	26.0	26.0	27.7	27.7	27.7	25.1	8.9	6.9	35.3	14.5	12.0
LOS by Move:	C	C	C	C	C	C	C	A	A	D	B	B
HCM2k95thQ:	3	3	3	7	7	7	1	11	1	2	11	1

Note: Queue reported is the number of cars per lane.

Appendix F

Level of Service Calculations – Diridon Station

BART Phase II Extension Project

Level Of Service Computation Report
 2000 HCM Operations (Future Volume Alternative)
 AM - Existing Conditions

Intersection #3013: 87/JULIAN (E) *

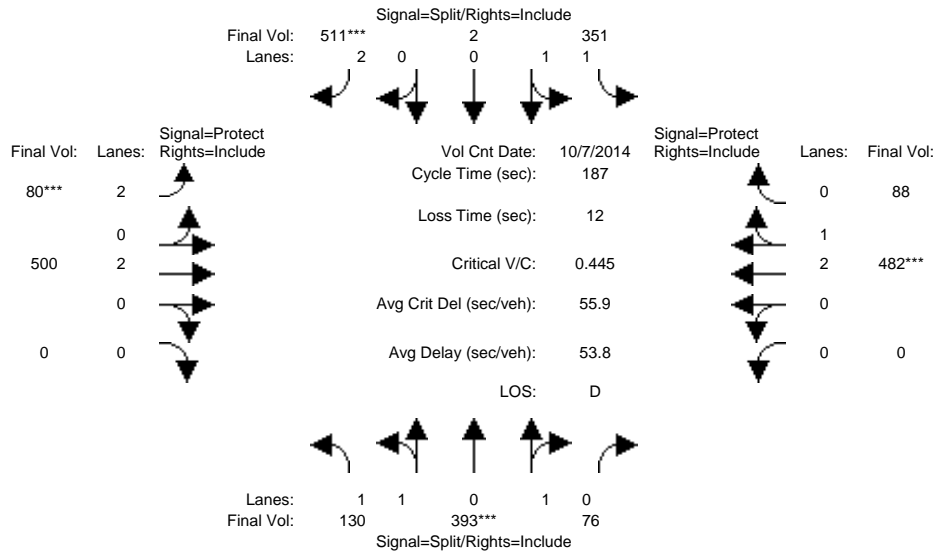

Approach:	North Bound			South Bound			East Bound			West Bound		
	L	T	R	L	T	R	L	T	R	L	T	R
Min. Green:	10	10	10	10	10	10	7	10	0	0	10	10
Y+R:	4.0	4.0	4.0	4.0	4.0	4.0	4.0	4.0	4.0	4.0	4.0	4.0

Volume Module:	>> Count Date: 7 Oct 2014 <<											
Base Vol:	130	393	76	351	2	511	80	500	0	0	482	88
Growth Adj:	1.00	1.00	1.00	1.00	1.00	1.00	1.00	1.00	1.00	1.00	1.00	1.00
Initial Bse:	130	393	76	351	2	511	80	500	0	0	482	88
Added Vol:	0	0	0	0	0	0	0	0	0	0	0	0
PasserByVol:	0	0	0	0	0	0	0	0	0	0	0	0
Initial Fut:	130	393	76	351	2	511	80	500	0	0	482	88
User Adj:	1.00	1.00	1.00	1.00	1.00	1.00	1.00	1.00	1.00	1.00	1.00	1.00
PHF Adj:	1.00	1.00	1.00	1.00	1.00	1.00	1.00	1.00	1.00	1.00	1.00	1.00
PHF Volume:	130	393	76	351	2	511	80	500	0	0	482	88
Reduct Vol:	0	0	0	0	0	0	0	0	0	0	0	0
Reduced Vol:	130	393	76	351	2	511	80	500	0	0	482	88
PCE Adj:	1.00	1.00	1.00	1.00	1.00	1.00	1.00	1.00	1.00	1.00	1.00	1.00
MLF Adj:	1.00	1.00	1.00	1.00	1.00	1.00	1.00	1.00	1.00	1.00	1.00	1.00
Final Volume:	130	393	76	351	2	511	80	500	0	0	482	88

Saturation Flow Module:												
Sat/Lane:	1900	1900	1900	1900	1900	1900	1900	1900	1900	1900	1900	1900
Adjustment:	0.92	0.98	0.95	0.93	0.95	0.83	0.83	1.00	0.92	0.92	0.99	0.95
Lanes:	1.00	1.67	0.33	1.99	0.01	2.00	2.00	2.00	0.00	0.00	2.52	0.48
Final Sat.:	1750	3100	599	3530	20	3150	3150	3800	0	0	4734	864

Capacity Analysis Module:												
Vol/Sat:	0.07	0.13	0.13	0.10	0.10	0.16	0.03	0.13	0.00	0.00	0.10	0.10
Crit Moves:	****			****			****			****		
Green Time:	53.3	53.3	53.3	68.2	68.2	68.2	10.7	53.5	0.0	0.0	42.8	42.8
Volume/Cap:	0.26	0.44	0.44	0.27	0.27	0.44	0.44	0.46	0.00	0.00	0.44	0.44
Delay/Veh:	51.7	55.0	55.0	42.0	42.0	45.3	87.0	55.2	0.0	0.0	62.1	62.1
User DelAdj:	1.00	1.00	1.00	1.00	1.00	1.00	1.00	1.00	1.00	1.00	1.00	1.00
AdjDel/Veh:	51.7	55.0	55.0	42.0	42.0	45.3	87.0	55.2	0.0	0.0	62.1	62.1
LOS by Move:	D	D	D	D	D	D	F	E	A	A	E	E
HCM2k95thQ:	11	20	20	14	14	23	5	21	0	0	17	17

Note: Queue reported is the number of cars per lane.

BART Phase II Extension Project

Level Of Service Computation Report
2000 HCM Operations (Future Volume Alternative)
PM - Existing Conditions

Intersection #3013: 87/JULIAN (E) *

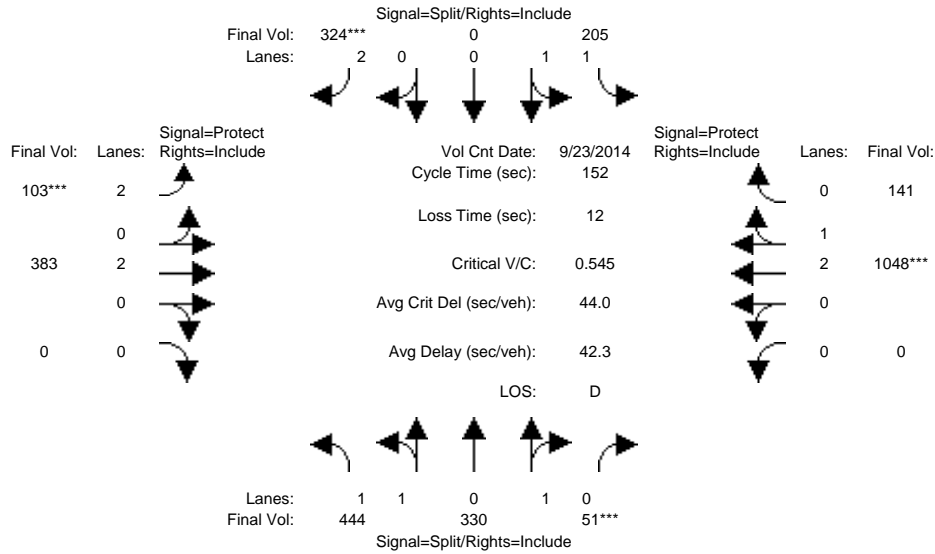

Approach:	North Bound			South Bound			East Bound			West Bound		
	L	T	R	L	T	R	L	T	R	L	T	R
Min. Green:	10	10	10	10	10	10	7	10	0	0	10	10
Y+R:	4.0	4.0	4.0	4.0	4.0	4.0	4.0	4.0	4.0	4.0	4.0	4.0
Volume Module: >> Count Date: 23 Sep 2014 <<												
Base Vol:	444	330	51	205	0	324	103	383	0	0	1048	141
Growth Adj:	1.00	1.00	1.00	1.00	1.00	1.00	1.00	1.00	1.00	1.00	1.00	1.00
Initial Bse:	444	330	51	205	0	324	103	383	0	0	1048	141
Added Vol:	0	0	0	0	0	0	0	0	0	0	0	0
PasserByVol:	0	0	0	0	0	0	0	0	0	0	0	0
Initial Fut:	444	330	51	205	0	324	103	383	0	0	1048	141
User Adj:	1.00	1.00	1.00	1.00	1.00	1.00	1.00	1.00	1.00	1.00	1.00	1.00
PHF Adj:	1.00	1.00	1.00	1.00	1.00	1.00	1.00	1.00	1.00	1.00	1.00	1.00
PHF Volume:	444	330	51	205	0	324	103	383	0	0	1048	141
Reduct Vol:	0	0	0	0	0	0	0	0	0	0	0	0
Reduced Vol:	444	330	51	205	0	324	103	383	0	0	1048	141
PCE Adj:	1.00	1.00	1.00	1.00	1.00	1.00	1.00	1.00	1.00	1.00	1.00	1.00
MLF Adj:	1.00	1.00	1.00	1.00	1.00	1.00	1.00	1.00	1.00	1.00	1.00	1.00
FinalVolume:	444	330	51	205	0	324	103	383	0	0	1048	141
Saturation Flow Module:												
Sat/Lane:	1900	1900	1900	1900	1900	1900	1900	1900	1900	1900	1900	1900
Adjustment:	0.93	0.95	0.95	0.93	1.00	0.83	0.83	1.00	0.92	0.92	0.99	0.95
Lanes:	1.63	1.19	0.18	2.00	0.00	2.00	2.00	2.00	0.00	0.00	2.63	0.37
Final Sat.:	2879	2140	331	3550	0	3150	3150	3800	0	0	4935	664
Capacity Analysis Module:												
Vol/Sat:	0.15	0.15	0.15	0.06	0.00	0.10	0.03	0.10	0.00	0.00	0.21	0.21
Crit Moves:	****			****			****			****		
Green Time:	43.0	43.0	43.0	28.7	0.0	28.7	9.1	68.3	0.0	0.0	59.2	59.2
Volume/Cap:	0.55	0.55	0.55	0.31	0.00	0.55	0.55	0.22	0.00	0.00	0.55	0.55
Delay/Veh:	46.6	46.6	46.6	53.4	0.0	56.8	72.7	25.7	0.0	0.0	36.2	36.2
User DelAdj:	1.00	1.00	1.00	1.00	1.00	1.00	1.00	1.00	1.00	1.00	1.00	1.00
AdjDel/Veh:	46.6	46.6	46.6	53.4	0.0	56.8	72.7	25.7	0.0	0.0	36.2	36.2
LOS by Move:	D	D	D	D	A	E	E	C	A	A	D	D
HCM2k95thQ:	20	20	20	9	0	16	6	10	0	0	25	25

Note: Queue reported is the number of cars per lane.

BART Phase II Extension Project

Level Of Service Computation Report
2000 HCM Operations (Future Volume Alternative)
AM - Existing Conditions

Intersection #3014: 87/JULIAN (W)

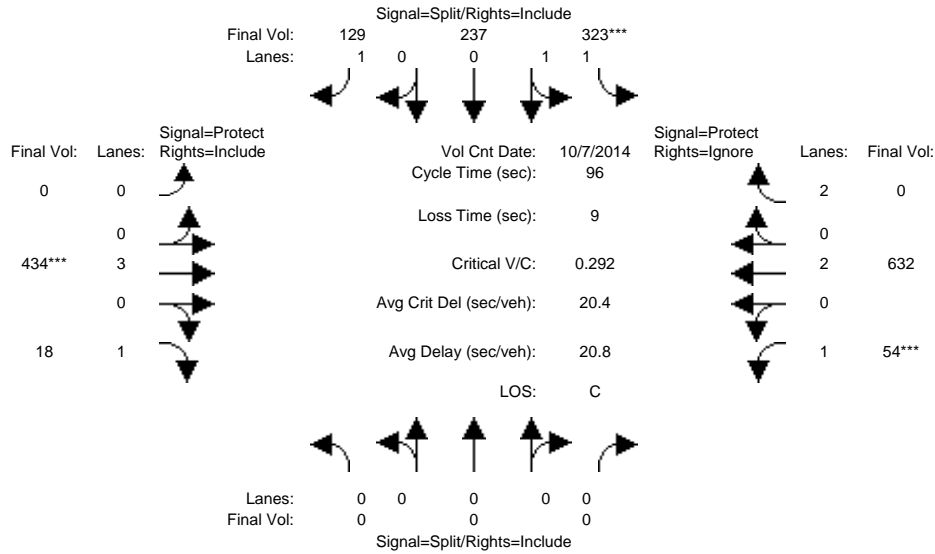

Approach:	North Bound			South Bound			East Bound			West Bound		
	L	T	R	L	T	R	L	T	R	L	T	R
Min. Green:	0	0	0	10	10	10	0	10	10	7	10	10
Y+R:	4.0	4.0	4.0	4.0	4.0	4.0	4.0	4.0	4.0	4.0	4.0	4.0

Volume Module:	>>	Count	Date:	7 Oct 2014	<<							
Base Vol:	0	0	0	323	237	129	0	434	18	54	632	0
Growth Adj:	1.00	1.00	1.00	1.00	1.00	1.00	1.00	1.00	1.00	1.00	1.00	1.00
Initial Bse:	0	0	0	323	237	129	0	434	18	54	632	0
Added Vol:	0	0	0	0	0	0	0	0	0	0	0	0
PasserByVol:	0	0	0	0	0	0	0	0	0	0	0	0
Initial Fut:	0	0	0	323	237	129	0	434	18	54	632	0
User Adj:	1.00	1.00	1.00	1.00	1.00	1.00	1.00	1.00	1.00	1.00	1.00	0.00
PHF Adj:	1.00	1.00	1.00	1.00	1.00	1.00	1.00	1.00	1.00	1.00	1.00	0.00
PHF Volume:	0	0	0	323	237	129	0	434	18	54	632	0
Reduct Vol:	0	0	0	0	0	0	0	0	0	0	0	0
Reduced Vol:	0	0	0	323	237	129	0	434	18	54	632	0
PCE Adj:	1.00	1.00	1.00	1.00	1.00	1.00	1.00	1.00	1.00	1.00	1.00	0.00
MLF Adj:	1.00	1.00	1.00	1.00	1.00	1.00	1.00	1.00	1.00	1.00	1.00	0.00
FinalVolume:	0	0	0	323	237	129	0	434	18	54	632	0

Saturation Flow Module:	Sat/Lane:	1900	1900	1900	1900	1900	1900	1900	1900	1900	1900	1900
Adjustment:	0.92	1.00	0.92	0.92	0.95	0.92	0.92	1.00	0.92	0.92	1.00	0.83
Lanes:	0.00	0.00	0.00	1.17	0.83	1.00	0.00	3.00	1.00	1.00	2.00	2.00
Final Sat.:	0	0	0	2047	1502	1750	0	5700	1750	1750	3800	3150

Capacity Analysis Module:	Vol/Sat:	0.00	0.00	0.00	0.16	0.16	0.07	0.00	0.08	0.01	0.03	0.17	0.00
Crit Moves:				****					****			****	
Green Time:	0.0	0.0	0.0	51.8	51.8	51.8	0.0	25.0	25.0	25.0	10.1	35.2	0.0
Volume/Cap:	0.00	0.00	0.00	0.29	0.29	0.14	0.00	0.29	0.04	0.04	0.29	0.45	0.00
Delay/Veh:	0.0	0.0	0.0	12.1	12.1	11.0	0.0	28.5	26.5	26.5	40.5	23.4	0.0
User DelAdj:	1.00	1.00	1.00	1.00	1.00	1.00	1.00	1.00	1.00	1.00	1.00	1.00	1.00
AdjDel/Veh:	0.0	0.0	0.0	12.1	12.1	11.0	0.0	28.5	26.5	26.5	40.5	23.4	0.0
LOS by Move:	A	A	A	B	B	B	A	C	C	C	D	C	A
HCM2k95thQ:	0	0	0	9	9	4	0	7	1	1	3	13	0

Note: Queue reported is the number of cars per lane.

BART Phase II Extension Project

Level Of Service Computation Report
2000 HCM Operations (Future Volume Alternative)
PM - Existing Conditions

Intersection #3014: 87/JULIAN (W)

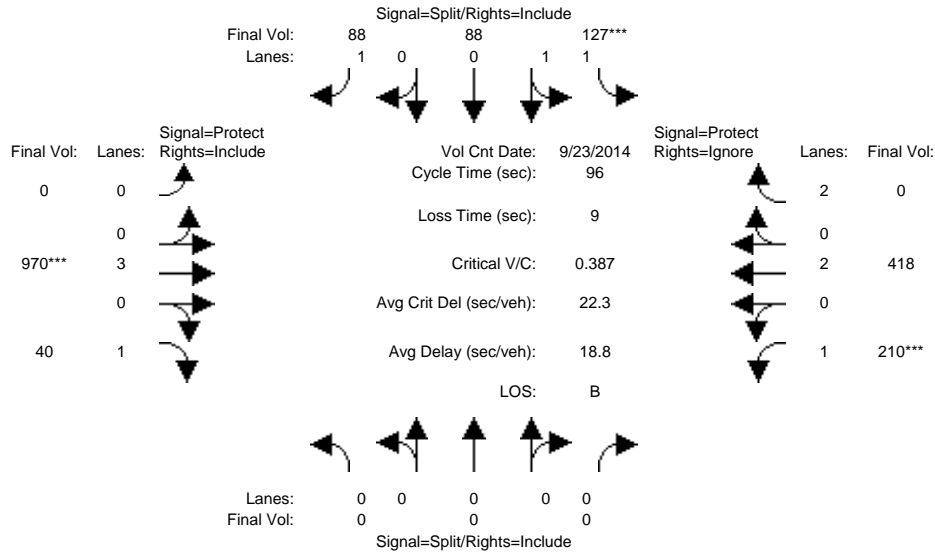

Approach:	North Bound			South Bound			East Bound			West Bound		
	L	T	R	L	T	R	L	T	R	L	T	R
Min. Green:	0	0	0	10	10	10	0	10	10	7	10	10
Y+R:	4.0	4.0	4.0	4.0	4.0	4.0	4.0	4.0	4.0	4.0	4.0	4.0
Volume Module: >> Count Date: 23 Sep 2014 <<												
Base Vol:	0	0	0	127	88	88	0	970	40	210	418	0
Growth Adj:	1.00	1.00	1.00	1.00	1.00	1.00	1.00	1.00	1.00	1.00	1.00	1.00
Initial Bse:	0	0	0	127	88	88	0	970	40	210	418	0
Added Vol:	0	0	0	0	0	0	0	0	0	0	0	0
PasserByVol:	0	0	0	0	0	0	0	0	0	0	0	0
Initial Fut:	0	0	0	127	88	88	0	970	40	210	418	0
User Adj:	1.00	1.00	1.00	1.00	1.00	1.00	1.00	1.00	1.00	1.00	1.00	0.00
PHF Adj:	1.00	1.00	1.00	1.00	1.00	1.00	1.00	1.00	1.00	1.00	1.00	0.00
PHF Volume:	0	0	0	127	88	88	0	970	40	210	418	0
Reduct Vol:	0	0	0	0	0	0	0	0	0	0	0	0
Reduced Vol:	0	0	0	127	88	88	0	970	40	210	418	0
PCE Adj:	1.00	1.00	1.00	1.00	1.00	1.00	1.00	1.00	1.00	1.00	1.00	0.00
MLF Adj:	1.00	1.00	1.00	1.00	1.00	1.00	1.00	1.00	1.00	1.00	1.00	0.00
FinalVolume:	0	0	0	127	88	88	0	970	40	210	418	0
Saturation Flow Module:												
Sat/Lane:	1900	1900	1900	1900	1900	1900	1900	1900	1900	1900	1900	1900
Adjustment:	0.92	1.00	0.92	0.93	0.95	0.92	0.92	1.00	0.92	0.92	1.00	0.83
Lanes:	0.00	0.00	0.00	1.19	0.81	1.00	0.00	3.00	1.00	1.00	2.00	2.00
Final Sat.:	0	0	0	2097	1453	1750	0	5700	1750	1750	3800	3150
Capacity Analysis Module:												
Vol/Sat:	0.00	0.00	0.00	0.06	0.06	0.05	0.00	0.17	0.02	0.12	0.11	0.00
Crit Moves:				****				****				****
Green Time:	0.0	0.0	0.0	15.0	15.0	15.0	0.0	42.2	42.2	29.8	72.0	0.0
Volume/Cap:	0.00	0.00	0.00	0.39	0.39	0.32	0.00	0.39	0.05	0.39	0.15	0.00
Delay/Veh:	0.0	0.0	0.0	36.8	36.8	36.6	0.0	18.3	15.4	26.4	3.4	0.0
User DelAdj:	1.00	1.00	1.00	1.00	1.00	1.00	1.00	1.00	1.00	1.00	1.00	1.00
AdjDel/Veh:	0.0	0.0	0.0	36.8	36.8	36.6	0.0	18.3	15.4	26.4	3.4	0.0
LOS by Move:	A	A	A	D	D	D	A	B	B	C	A	A
HCM2k95thQ:	0	0	0	7	7	5	0	12	1	10	3	0

Note: Queue reported is the number of cars per lane.

BART Phase II Extension Project

Level Of Service Computation Report
 2000 HCM Operations (Future Volume Alternative)
 AM - Existing Conditions

Intersection #3015: 87/SANTA CLARA

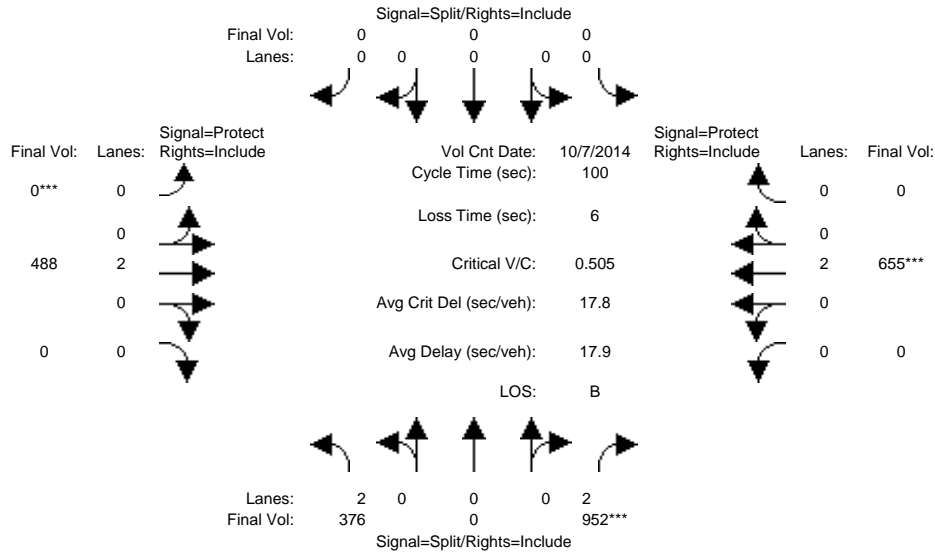

Approach:	North Bound			South Bound			East Bound			West Bound		
	L	T	R	L	T	R	L	T	R	L	T	R
Min. Green:	10	0	10	0	0	0	0	10	0	0	10	0
Y+R:	4.0	4.0	4.0	4.0	4.0	4.0	4.0	4.0	4.0	4.0	4.0	4.0
Volume Module: >> Count Date: 7 Oct 2014 <<												
Base Vol:	376	0	952	0	0	0	0	488	0	0	655	0
Growth Adj:	1.00	1.00	1.00	1.00	1.00	1.00	1.00	1.00	1.00	1.00	1.00	1.00
Initial Bse:	376	0	952	0	0	0	0	488	0	0	655	0
Added Vol:	0	0	0	0	0	0	0	0	0	0	0	0
PasserByVol:	0	0	0	0	0	0	0	0	0	0	0	0
Initial Fut:	376	0	952	0	0	0	0	488	0	0	655	0
User Adj:	1.00	1.00	1.00	1.00	1.00	1.00	1.00	1.00	1.00	1.00	1.00	1.00
PHF Adj:	1.00	1.00	1.00	1.00	1.00	1.00	1.00	1.00	1.00	1.00	1.00	1.00
PHF Volume:	376	0	952	0	0	0	0	488	0	0	655	0
Reduct Vol:	0	0	0	0	0	0	0	0	0	0	0	0
Reduced Vol:	376	0	952	0	0	0	0	488	0	0	655	0
PCE Adj:	1.00	1.00	1.00	1.00	1.00	1.00	1.00	1.00	1.00	1.00	1.00	1.00
MLF Adj:	1.00	1.00	1.00	1.00	1.00	1.00	1.00	1.00	1.00	1.00	1.00	1.00
FinalVolume:	376	0	952	0	0	0	0	488	0	0	655	0
Saturation Flow Module:												
Sat/Lane:	1900	1900	1900	1900	1900	1900	1900	1900	1900	1900	1900	1900
Adjustment:	0.83	1.00	0.83	0.92	1.00	0.92	0.92	1.00	0.92	0.92	1.00	0.92
Lanes:	2.00	0.00	2.00	0.00	0.00	0.00	0.00	2.00	0.00	0.00	2.00	0.00
Final Sat.:	3150	0	3150	0	0	0	0	3800	0	0	3800	0
Capacity Analysis Module:												
Vol/Sat:	0.12	0.00	0.30	0.00	0.00	0.00	0.00	0.13	0.00	0.00	0.17	0.00
Crit Moves:			****					****			****	
Green Time:	59.9	0.0	59.9	0.0	0.0	0.0	0.0	34.1	0.0	0.0	34.1	0.0
Volume/Cap:	0.20	0.00	0.50	0.00	0.00	0.00	0.00	0.38	0.00	0.00	0.50	0.00
Delay/Veh:	9.2	0.0	11.8	0.0	0.0	0.0	0.0	25.1	0.0	0.0	26.5	0.0
User DelAdj:	1.00	1.00	1.00	1.00	1.00	1.00	1.00	1.00	1.00	1.00	1.00	1.00
AdjDel/Veh:	9.2	0.0	11.8	0.0	0.0	0.0	0.0	25.1	0.0	0.0	26.5	0.0
LOS by Move:	A	A	B	A	A	A	A	C	A	A	C	A
HCM2k95thQ:	6	0	19	0	0	0	0	11	0	0	15	0

Note: Queue reported is the number of cars per lane.

BART Phase II Extension Project

Level Of Service Computation Report
 2000 HCM Operations (Future Volume Alternative)
 PM - Existing Conditions

Intersection #3015: 87/SANTA CLARA

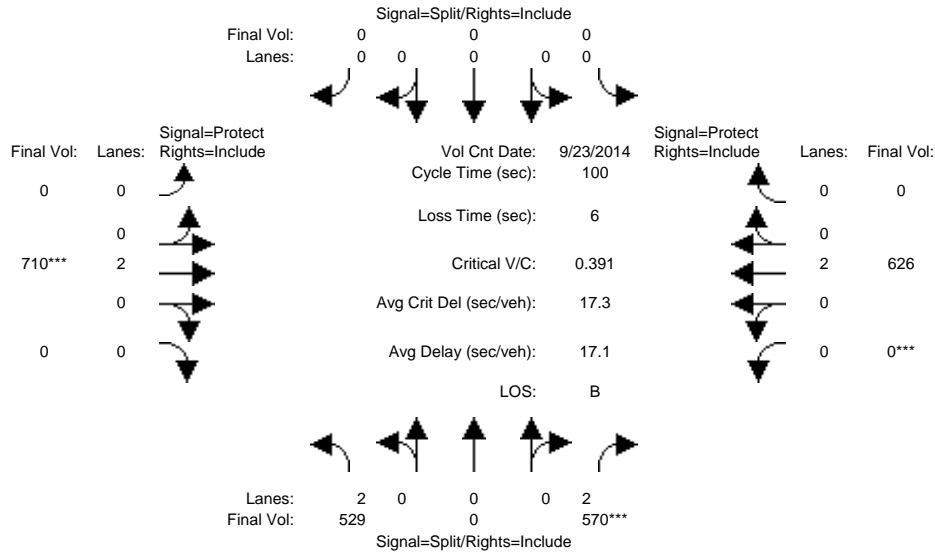

Approach:	North Bound			South Bound			East Bound			West Bound		
	L	T	R	L	T	R	L	T	R	L	T	R
Min. Green:	10	0	10	0	0	0	0	10	0	0	10	0
Y+R:	4.0	4.0	4.0	4.0	4.0	4.0	4.0	4.0	4.0	4.0	4.0	4.0

Volume Module: >> Count Date: 23 Sep 2014 <<

Base Vol:	529	0	570	0	0	0	0	710	0	0	626	0
Growth Adj:	1.00	1.00	1.00	1.00	1.00	1.00	1.00	1.00	1.00	1.00	1.00	1.00
Initial Bse:	529	0	570	0	0	0	0	710	0	0	626	0
Added Vol:	0	0	0	0	0	0	0	0	0	0	0	0
PasserByVol:	0	0	0	0	0	0	0	0	0	0	0	0
Initial Fut:	529	0	570	0	0	0	0	710	0	0	626	0
User Adj:	1.00	1.00	1.00	1.00	1.00	1.00	1.00	1.00	1.00	1.00	1.00	1.00
PHF Adj:	1.00	1.00	1.00	1.00	1.00	1.00	1.00	1.00	1.00	1.00	1.00	1.00
PHF Volume:	529	0	570	0	0	0	0	710	0	0	626	0
Reduct Vol:	0	0	0	0	0	0	0	0	0	0	0	0
Reduced Vol:	529	0	570	0	0	0	0	710	0	0	626	0
PCE Adj:	1.00	1.00	1.00	1.00	1.00	1.00	1.00	1.00	1.00	1.00	1.00	1.00
MLF Adj:	1.00	1.00	1.00	1.00	1.00	1.00	1.00	1.00	1.00	1.00	1.00	1.00
FinalVolume:	529	0	570	0	0	0	0	710	0	0	626	0

Saturation Flow Module:

Sat/Lane:	1900	1900	1900	1900	1900	1900	1900	1900	1900	1900	1900	1900
Adjustment:	0.83	1.00	0.83	0.92	1.00	0.92	0.92	1.00	0.92	0.92	1.00	0.92
Lanes:	2.00	0.00	2.00	0.00	0.00	0.00	0.00	2.00	0.00	0.00	2.00	0.00
Final Sat.:	3150	0	3150	0	0	0	0	3800	0	0	3800	0

Capacity Analysis Module:

Vol/Sat:	0.17	0.00	0.18	0.00	0.00	0.00	0.00	0.19	0.00	0.00	0.16	0.00
Crit Moves:			****					****			****	
Green Time:	46.2	0.0	46.2	0.0	0.0	0.0	0.0	47.8	0.0	0.0	47.8	0.0
Volume/Cap:	0.36	0.00	0.39	0.00	0.00	0.00	0.00	0.39	0.00	0.00	0.34	0.00
Delay/Veh:	17.5	0.0	17.8	0.0	0.0	0.0	0.0	16.9	0.0	0.0	16.5	0.0
User DelAdj:	1.00	1.00	1.00	1.00	1.00	1.00	1.00	1.00	1.00	1.00	1.00	1.00
AdjDel/Veh:	17.5	0.0	17.8	0.0	0.0	0.0	0.0	16.9	0.0	0.0	16.5	0.0
LOS by Move:	B	A	B	A	A	A	A	B	A	A	B	A
HCM2k95thQ:	12	0	13	0	0	0	0	13	0	0	11	0

Note: Queue reported is the number of cars per lane.

BART Phase II Extension Project

Level Of Service Computation Report
 2000 HCM Operations (Future Volume Alternative)
 AM - Existing Conditions

Intersection #3032: 280/BIRD (N)

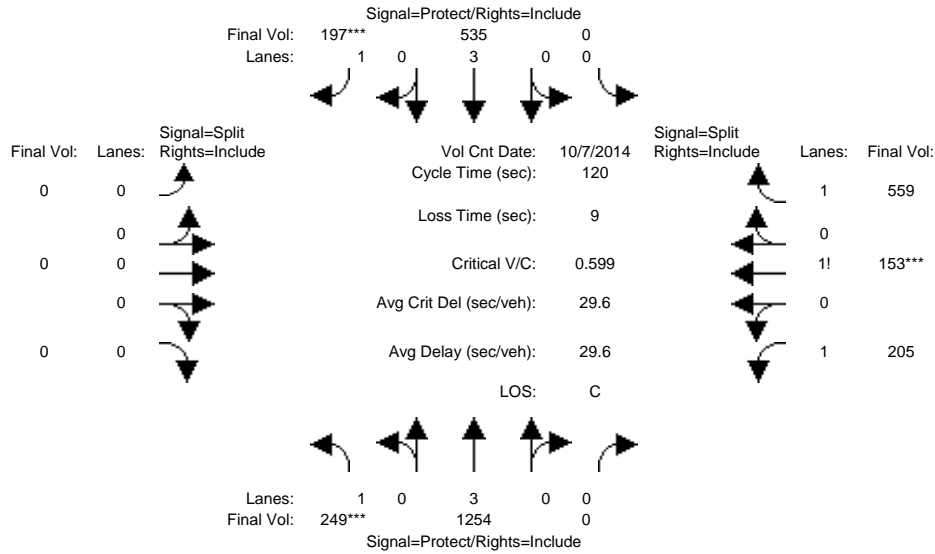

Approach:	North Bound			South Bound			East Bound			West Bound		
	L	T	R	L	T	R	L	T	R	L	T	R
Min. Green:	7	10	0	0	10	10	0	0	0	10	10	10
Y+R:	4.0	4.0	4.0	4.0	4.0	4.0	4.0	4.0	4.0	4.0	4.0	4.0
Volume Module: >> Count Date: 7 Oct 2014 <<												
Base Vol:	249	1254	0	0	535	197	0	0	0	205	153	559
Growth Adj:	1.00	1.00	1.00	1.00	1.00	1.00	1.00	1.00	1.00	1.00	1.00	1.00
Initial Bse:	249	1254	0	0	535	197	0	0	0	205	153	559
Added Vol:	0	0	0	0	0	0	0	0	0	0	0	0
PasserByVol:	0	0	0	0	0	0	0	0	0	0	0	0
Initial Fut:	249	1254	0	0	535	197	0	0	0	205	153	559
User Adj:	1.00	1.00	1.00	1.00	1.00	1.00	1.00	1.00	1.00	1.00	1.00	1.00
PHF Adj:	1.00	1.00	1.00	1.00	1.00	1.00	1.00	1.00	1.00	1.00	1.00	1.00
PHF Volume:	249	1254	0	0	535	197	0	0	0	205	153	559
Reduct Vol:	0	0	0	0	0	0	0	0	0	0	0	0
Reduced Vol:	249	1254	0	0	535	197	0	0	0	205	153	559
PCE Adj:	1.00	1.00	1.00	1.00	1.00	1.00	1.00	1.00	1.00	1.00	1.00	1.00
MLF Adj:	1.00	1.00	1.00	1.00	1.00	1.00	1.00	1.00	1.00	1.00	1.00	1.00
FinalVolume:	249	1254	0	0	535	197	0	0	0	205	153	559
Saturation Flow Module:												
Sat/Lane:	1900	1900	1900	1900	1900	1900	1900	1900	1900	1900	1900	1900
Adjustment:	0.92	1.00	0.92	0.92	1.00	0.92	0.92	1.00	0.92	0.92	0.95	0.95
Lanes:	1.00	3.00	0.00	0.00	3.00	1.00	0.00	0.00	0.00	1.20	0.28	1.52
Final Sat.:	1750	5700	0	0	5700	1750	0	0	0	2093	512	2735
Capacity Analysis Module:												
Vol/Sat:	0.14	0.22	0.00	0.00	0.09	0.11	0.00	0.00	0.00	0.10	0.30	0.20
Crit Moves:	****					****					****	
Green Time:	28.5	51.1	0.0	0.0	22.6	22.6	0.0	0.0	0.0	59.9	59.9	59.9
Volume/Cap:	0.60	0.52	0.00	0.00	0.50	0.60	0.00	0.00	0.00	0.20	0.60	0.41
Delay/Veh:	43.1	25.6	0.0	0.0	44.0	47.6	0.0	0.0	0.0	16.7	22.1	19.0
User DelAdj:	1.00	1.00	1.00	1.00	1.00	1.00	1.00	1.00	1.00	1.00	1.00	1.00
AdjDel/Veh:	43.1	25.6	0.0	0.0	44.0	47.6	0.0	0.0	0.0	16.7	22.1	19.0
LOS by Move:	D	C	A	A	D	D	A	A	A	B	C	B
HCM2k95thQ:	17	21	0	0	11	14	0	0	0	7	26	16

Note: Queue reported is the number of cars per lane.

BART Phase II Extension Project

Level Of Service Computation Report
2000 HCM Operations (Future Volume Alternative)
PM - Existing Conditions

Intersection #3032: 280/BIRD (N)

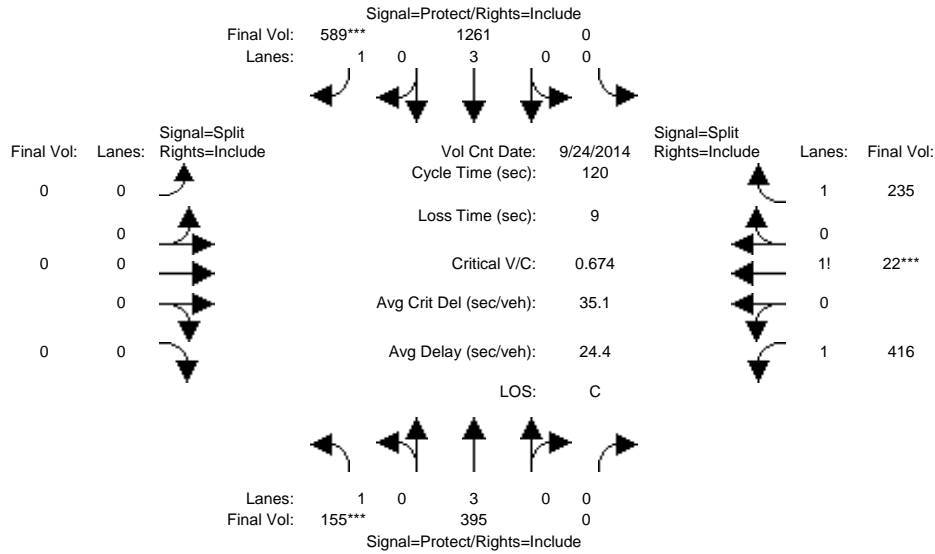

Approach:	North Bound			South Bound			East Bound			West Bound		
Movement:	L	T	R	L	T	R	L	T	R	L	T	R
Min. Green:	7	10	0	0	10	10	0	0	0	10	10	10
Y+R:	4.0	4.0	4.0	4.0	4.0	4.0	4.0	4.0	4.0	4.0	4.0	4.0
Volume Module: >> Count Date: 24 Sep 2014 <<												
Base Vol:	155	395	0	0	1261	589	0	0	0	416	22	235
Growth Adj:	1.00	1.00	1.00	1.00	1.00	1.00	1.00	1.00	1.00	1.00	1.00	1.00
Initial Bse:	155	395	0	0	1261	589	0	0	0	416	22	235
Added Vol:	0	0	0	0	0	0	0	0	0	0	0	0
PasserByVol:	0	0	0	0	0	0	0	0	0	0	0	0
Initial Fut:	155	395	0	0	1261	589	0	0	0	416	22	235
User Adj:	1.00	1.00	1.00	1.00	1.00	1.00	1.00	1.00	1.00	1.00	1.00	1.00
PHF Adj:	1.00	1.00	1.00	1.00	1.00	1.00	1.00	1.00	1.00	1.00	1.00	1.00
PHF Volume:	155	395	0	0	1261	589	0	0	0	416	22	235
Reduct Vol:	0	0	0	0	0	0	0	0	0	0	0	0
Reduced Vol:	155	395	0	0	1261	589	0	0	0	416	22	235
PCE Adj:	1.00	1.00	1.00	1.00	1.00	1.00	1.00	1.00	1.00	1.00	1.00	1.00
MLF Adj:	1.00	1.00	1.00	1.00	1.00	1.00	1.00	1.00	1.00	1.00	1.00	1.00
FinalVolume:	155	395	0	0	1261	589	0	0	0	416	22	235
Saturation Flow Module:												
Sat/Lane:	1900	1900	1900	1900	1900	1900	1900	1900	1900	1900	1900	1900
Adjustment:	0.92	1.00	0.92	0.92	1.00	0.92	0.92	1.00	0.92	0.92	0.92	0.92
Lanes:	1.00	3.00	0.00	0.00	3.00	1.00	0.00	0.00	0.00	1.60	0.06	1.34
Final Sat.:	1750	5700	0	0	5700	1750	0	0	0	2797	111	2342
Capacity Analysis Module:												
Vol/Sat:	0.09	0.07	0.00	0.00	0.22	0.34	0.00	0.00	0.00	0.15	0.20	0.10
Crit Moves:	****					****					****	
Green Time:	15.8	75.7	0.0	0.0	59.9	59.9	0.0	0.0	0.0	35.3	35.3	35.3
Volume/Cap:	0.67	0.11	0.00	0.00	0.44	0.67	0.00	0.00	0.00	0.50	0.67	0.34
Delay/Veh:	57.4	8.8	0.0	0.0	19.4	24.8	0.0	0.0	0.0	35.4	39.1	33.3
User DelAdj:	1.00	1.00	1.00	1.00	1.00	1.00	1.00	1.00	1.00	1.00	1.00	1.00
AdjDel/Veh:	57.4	8.8	0.0	0.0	19.4	24.8	0.0	0.0	0.0	35.4	39.1	33.3
LOS by Move:	E	A	A	A	B	C	A	A	A	D	D	C
HCM2k95thQ:	14	4	0	0	18	30	0	0	0	16	23	11

Note: Queue reported is the number of cars per lane.

BART Phase II Extension Project

Level Of Service Computation Report
2000 HCM Operations (Future Volume Alternative)
AM - Existing Conditions

Intersection #3033: 280/BIRD (S)

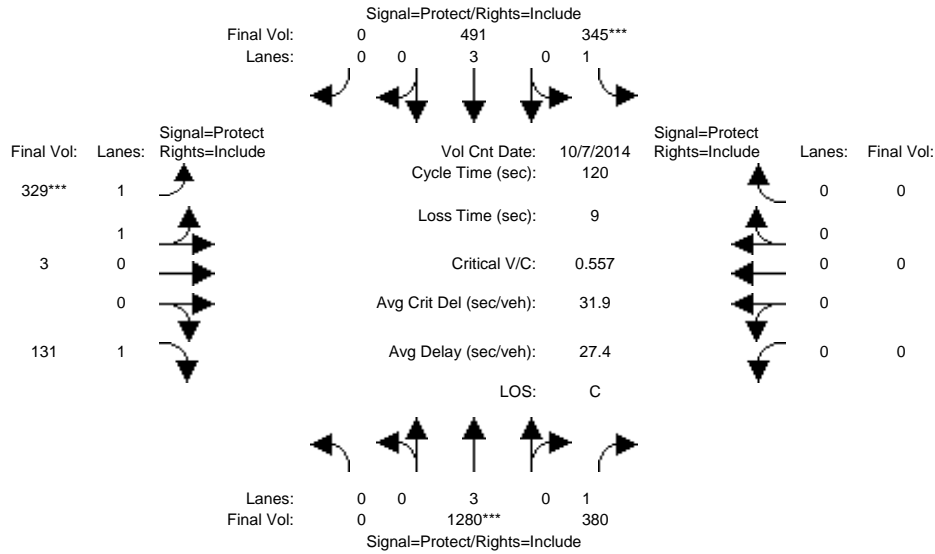

Approach:	North Bound			South Bound			East Bound			West Bound		
	L	T	R	L	T	R	L	T	R	L	T	R
Min. Green:	0	10	10	7	10	0	10	10	10	0	0	0
Y+R:	4.0	4.0	4.0	4.0	4.0	4.0	4.0	4.0	4.0	4.0	4.0	4.0
Volume Module: >> Count Date: 7 Oct 2014 <<												
Base Vol:	0	1280	380	345	491	0	329	3	131	0	0	0
Growth Adj:	1.00	1.00	1.00	1.00	1.00	1.00	1.00	1.00	1.00	1.00	1.00	1.00
Initial Bse:	0	1280	380	345	491	0	329	3	131	0	0	0
Added Vol:	0	0	0	0	0	0	0	0	0	0	0	0
PasserByVol:	0	0	0	0	0	0	0	0	0	0	0	0
Initial Fut:	0	1280	380	345	491	0	329	3	131	0	0	0
User Adj:	1.00	1.00	1.00	1.00	1.00	1.00	1.00	1.00	1.00	1.00	1.00	1.00
PHF Adj:	1.00	1.00	1.00	1.00	1.00	1.00	1.00	1.00	1.00	1.00	1.00	1.00
PHF Volume:	0	1280	380	345	491	0	329	3	131	0	0	0
Reduct Vol:	0	0	0	0	0	0	0	0	0	0	0	0
Reduced Vol:	0	1280	380	345	491	0	329	3	131	0	0	0
PCE Adj:	1.00	1.00	1.00	1.00	1.00	1.00	1.00	1.00	1.00	1.00	1.00	1.00
MLF Adj:	1.00	1.00	1.00	1.00	1.00	1.00	1.00	1.00	1.00	1.00	1.00	1.00
FinalVolume:	0	1280	380	345	491	0	329	3	131	0	0	0
Saturation Flow Module:												
Sat/Lane:	1900	1900	1900	1900	1900	1900	1900	1900	1900	1900	1900	1900
Adjustment:	0.92	1.00	0.92	0.92	1.00	0.92	0.93	0.95	0.92	0.92	1.00	0.92
Lanes:	0.00	3.00	1.00	1.00	3.00	0.00	1.98	0.02	1.00	0.00	0.00	0.00
Final Sat.:	0	5700	1750	1750	5700	0	3518	32	1750	0	0	0
Capacity Analysis Module:												
Vol/Sat:	0.00	0.22	0.22	0.20	0.09	0.00	0.09	0.09	0.07	0.00	0.00	0.00
Crit Moves:	****			****			****					
Green Time:	0.0	48.4	48.4	42.5	90.9	0.0	20.1	20.1	20.1	0.0	0.0	0.0
Volume/Cap:	0.00	0.56	0.54	0.56	0.11	0.00	0.56	0.56	0.45	0.00	0.00	0.00
Delay/Veh:	0.0	27.9	28.1	32.3	3.9	0.0	47.0	47.0	46.0	0.0	0.0	0.0
User DelAdj:	1.00	1.00	1.00	1.00	1.00	1.00	1.00	1.00	1.00	1.00	1.00	1.00
AdjDel/Veh:	0.0	27.9	28.1	32.3	3.9	0.0	47.0	47.0	46.0	0.0	0.0	0.0
LOS by Move:	A	C	C	C	A	A	D	D	D	A	A	A
HCM2k95thQ:	0	21	21	21	3	0	13	13	10	0	0	0

Note: Queue reported is the number of cars per lane.

BART Phase II Extension Project

Level Of Service Computation Report
2000 HCM Operations (Future Volume Alternative)
PM - Existing Conditions

Intersection #3033: 280/BIRD (S)

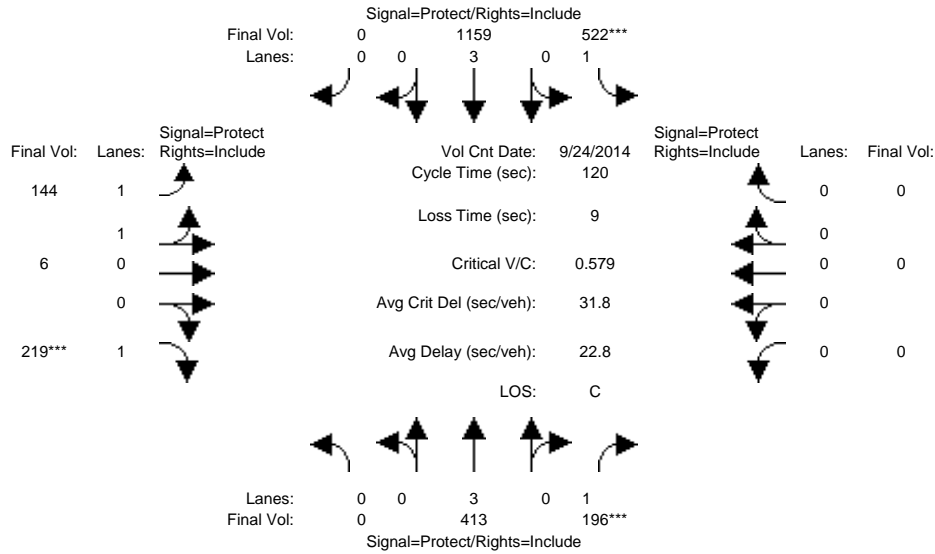

Approach:	North Bound			South Bound			East Bound			West Bound		
	L	T	R	L	T	R	L	T	R	L	T	R
Min. Green:	0	10	10	7	10	0	10	10	10	0	0	0
Y+R:	4.0	4.0	4.0	4.0	4.0	4.0	4.0	4.0	4.0	4.0	4.0	4.0
Volume Module: >> Count Date: 24 Sep 2014 <<												
Base Vol:	0	413	196	522	1159	0	144	6	219	0	0	0
Growth Adj:	1.00	1.00	1.00	1.00	1.00	1.00	1.00	1.00	1.00	1.00	1.00	1.00
Initial Bse:	0	413	196	522	1159	0	144	6	219	0	0	0
Added Vol:	0	0	0	0	0	0	0	0	0	0	0	0
PasserByVol:	0	0	0	0	0	0	0	0	0	0	0	0
Initial Fut:	0	413	196	522	1159	0	144	6	219	0	0	0
User Adj:	1.00	1.00	1.00	1.00	1.00	1.00	1.00	1.00	1.00	1.00	1.00	1.00
PHF Adj:	1.00	1.00	1.00	1.00	1.00	1.00	1.00	1.00	1.00	1.00	1.00	1.00
PHF Volume:	0	413	196	522	1159	0	144	6	219	0	0	0
Reduct Vol:	0	0	0	0	0	0	0	0	0	0	0	0
Reduced Vol:	0	413	196	522	1159	0	144	6	219	0	0	0
PCE Adj:	1.00	1.00	1.00	1.00	1.00	1.00	1.00	1.00	1.00	1.00	1.00	1.00
MLF Adj:	1.00	1.00	1.00	1.00	1.00	1.00	1.00	1.00	1.00	1.00	1.00	1.00
Final Volume:	0	413	196	522	1159	0	144	6	219	0	0	0
Saturation Flow Module:												
Sat/Lane:	1900	1900	1900	1900	1900	1900	1900	1900	1900	1900	1900	1900
Adjustment:	0.92	1.00	0.92	0.92	1.00	0.92	0.93	0.95	0.92	0.92	1.00	0.92
Lanes:	0.00	3.00	1.00	1.00	3.00	0.00	1.92	0.08	1.00	0.00	0.00	0.00
Final Sat.:	0	5700	1750	1750	5700	0	3408	142	1750	0	0	0
Capacity Analysis Module:												
Vol/Sat:	0.00	0.07	0.11	0.30	0.20	0.00	0.04	0.04	0.13	0.00	0.00	0.00
Crit Moves:			****	****					****			
Green Time:	0.0	23.2	23.2	61.8	85.1	0.0	25.9	25.9	25.9	0.0	0.0	0.0
Volume/Cap:	0.00	0.37	0.58	0.58	0.29	0.00	0.20	0.20	0.58	0.00	0.00	0.00
Delay/Veh:	0.0	42.3	46.4	21.0	6.4	0.0	38.6	38.6	44.4	0.0	0.0	0.0
User DelAdj:	1.00	1.00	1.00	1.00	1.00	1.00	1.00	1.00	1.00	1.00	1.00	1.00
AdjDel/Veh:	0.0	42.3	46.4	21.0	6.4	0.0	38.6	38.6	44.4	0.0	0.0	0.0
LOS by Move:	A	D	D	C	A	A	D	D	D	A	A	A
HCM2k95thQ:	0	8	13	25	10	0	5	5	16	0	0	0

Note: Queue reported is the number of cars per lane.

BART Phase II Extension Project

Level Of Service Computation Report
2000 HCM Operations (Future Volume Alternative)
AM - Existing Conditions

Intersection #3058: ALAMEDA/NAGLEE

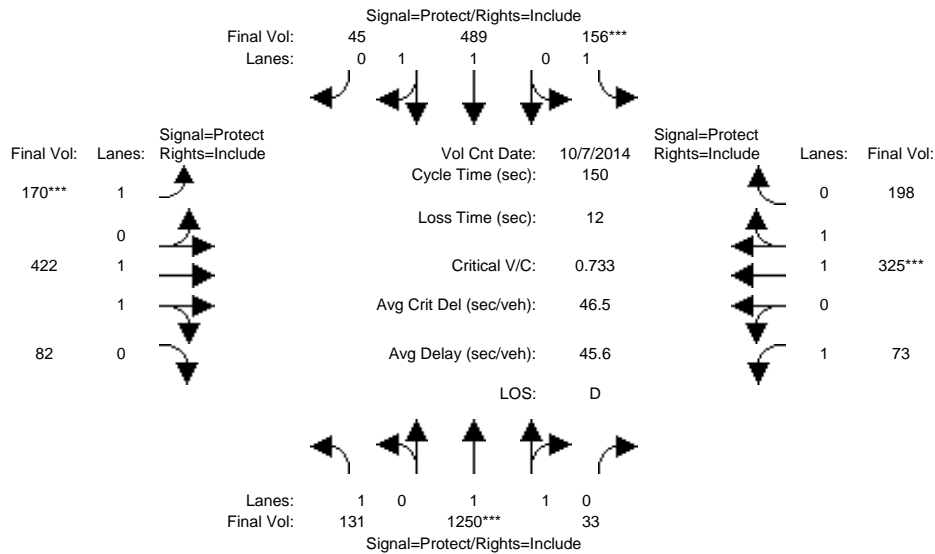

Approach:	North Bound			South Bound			East Bound			West Bound		
	L	T	R	L	T	R	L	T	R	L	T	R
Min. Green:	7	10	10	7	10	10	7	10	10	7	10	10
Y+R:	4.0	4.0	4.0	4.0	4.0	4.0	4.0	4.0	4.0	4.0	4.0	4.0

Volume Module: >> Count Date: 7 Oct 2014 <<

Base Vol:	131	1250	33	156	489	45	170	422	82	73	325	198
Growth Adj:	1.00	1.00	1.00	1.00	1.00	1.00	1.00	1.00	1.00	1.00	1.00	1.00
Initial Bse:	131	1250	33	156	489	45	170	422	82	73	325	198
Added Vol:	0	0	0	0	0	0	0	0	0	0	0	0
PasserByVol:	0	0	0	0	0	0	0	0	0	0	0	0
Initial Fut:	131	1250	33	156	489	45	170	422	82	73	325	198
User Adj:	1.00	1.00	1.00	1.00	1.00	1.00	1.00	1.00	1.00	1.00	1.00	1.00
PHF Adj:	1.00	1.00	1.00	1.00	1.00	1.00	1.00	1.00	1.00	1.00	1.00	1.00
PHF Volume:	131	1250	33	156	489	45	170	422	82	73	325	198
Reduct Vol:	0	0	0	0	0	0	0	0	0	0	0	0
Reduced Vol:	131	1250	33	156	489	45	170	422	82	73	325	198
PCE Adj:	1.00	1.00	1.00	1.00	1.00	1.00	1.00	1.00	1.00	1.00	1.00	1.00
MLF Adj:	1.00	1.00	1.00	1.00	1.00	1.00	1.00	1.00	1.00	1.00	1.00	1.00
FinalVolume:	131	1250	33	156	489	45	170	422	82	73	325	198

Saturation Flow Module:

Sat/Lane:	1900	1900	1900	1900	1900	1900	1900	1900	1900	1900	1900	1900
Adjustment:	0.92	0.97	0.95	0.92	0.98	0.95	0.92	0.98	0.95	0.92	0.99	0.95
Lanes:	1.00	1.95	0.05	1.00	1.83	0.17	1.00	1.67	0.33	1.00	1.22	0.78
Final Sat.:	1750	3605	95	1750	3388	312	1750	3098	602	1750	2298	1400

Capacity Analysis Module:

Vol/Sat:	0.07	0.35	0.35	0.09	0.14	0.14	0.10	0.14	0.14	0.04	0.14	0.14
Crit Moves:	****	****	****	****	****	****	****	****	****	****	****	****
Green Time:	30.5	71.0	71.0	18.2	58.7	58.7	19.9	36.4	36.4	12.5	28.9	28.9
Volume/Cap:	0.37	0.73	0.73	0.73	0.37	0.37	0.73	0.56	0.56	0.50	0.73	0.73
Delay/Veh:	52.1	33.5	33.5	75.9	32.6	32.6	73.9	50.7	50.7	68.6	60.8	60.8
User DelAdj:	1.00	1.00	1.00	1.00	1.00	1.00	1.00	1.00	1.00	1.00	1.00	1.00
AdjDel/Veh:	52.1	33.5	33.5	75.9	32.6	32.6	73.9	50.7	50.7	68.6	60.8	60.8
LOS by Move:	D	C	C	E	C	C	E	D	D	E	E	E
HCM2k95thQ:	11	41	41	15	16	16	18	20	20	7	21	21

Note: Queue reported is the number of cars per lane.

BART Phase II Extension Project

Level Of Service Computation Report
2000 HCM Operations (Future Volume Alternative)
PM - Existing Conditions

Intersection #3058: ALAMEDA/NAGLEE

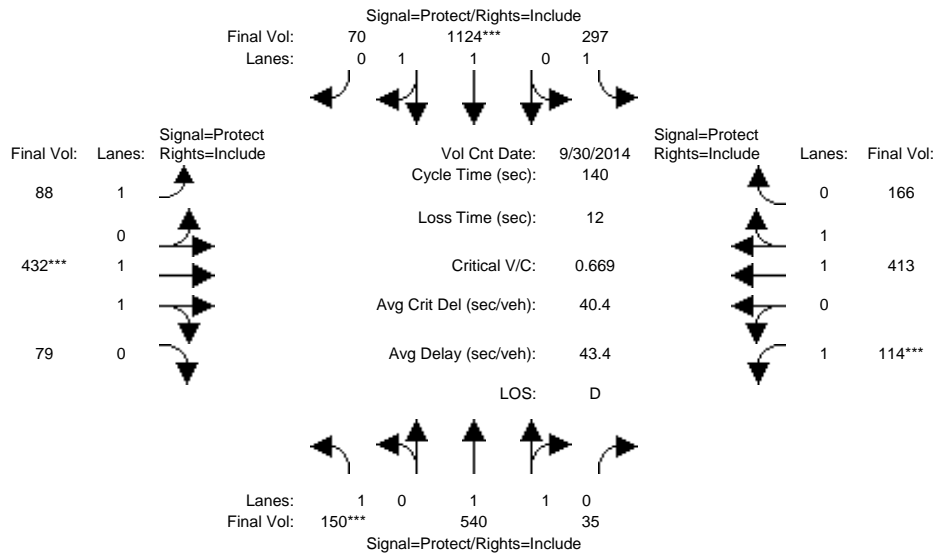

Approach:	North Bound			South Bound			East Bound			West Bound		
	L	T	R	L	T	R	L	T	R	L	T	R
Min. Green:	7	10	10	7	10	10	7	10	10	7	10	10
Y+R:	4.0	4.0	4.0	4.0	4.0	4.0	4.0	4.0	4.0	4.0	4.0	4.0

Volume Module:	>> Count Date: 30 Sep 2014 <<											
Base Vol:	150	540	35	297	1124	70	88	432	79	114	413	166
Growth Adj:	1.00	1.00	1.00	1.00	1.00	1.00	1.00	1.00	1.00	1.00	1.00	1.00
Initial Bse:	150	540	35	297	1124	70	88	432	79	114	413	166
Added Vol:	0	0	0	0	0	0	0	0	0	0	0	0
PasserByVol:	0	0	0	0	0	0	0	0	0	0	0	0
Initial Fut:	150	540	35	297	1124	70	88	432	79	114	413	166
User Adj:	1.00	1.00	1.00	1.00	1.00	1.00	1.00	1.00	1.00	1.00	1.00	1.00
PHF Adj:	1.00	1.00	1.00	1.00	1.00	1.00	1.00	1.00	1.00	1.00	1.00	1.00
PHF Volume:	150	540	35	297	1124	70	88	432	79	114	413	166
Reduct Vol:	0	0	0	0	0	0	0	0	0	0	0	0
Reduced Vol:	150	540	35	297	1124	70	88	432	79	114	413	166
PCE Adj:	1.00	1.00	1.00	1.00	1.00	1.00	1.00	1.00	1.00	1.00	1.00	1.00
MLF Adj:	1.00	1.00	1.00	1.00	1.00	1.00	1.00	1.00	1.00	1.00	1.00	1.00
Final Volume:	150	540	35	297	1124	70	88	432	79	114	413	166

Saturation Flow Module:												
Sat/Lane:	1900	1900	1900	1900	1900	1900	1900	1900	1900	1900	1900	1900
Adjustment:	0.92	0.98	0.95	0.92	0.98	0.95	0.92	0.98	0.95	0.92	0.98	0.95
Lanes:	1.00	1.87	0.13	1.00	1.88	0.12	1.00	1.68	0.32	1.00	1.41	0.59
Final Sat.:	1750	3475	225	1750	3483	217	1750	3128	572	1750	2638	1060

Capacity Analysis Module:												
Vol/Sat:	0.09	0.16	0.16	0.17	0.32	0.32	0.05	0.14	0.14	0.07	0.16	0.16
Crit Moves:	****			****			****			****		
Green Time:	17.9	40.9	40.9	44.6	67.5	67.5	10.3	28.9	28.9	13.6	32.2	32.2
Volume/Cap:	0.67	0.53	0.53	0.53	0.67	0.67	0.68	0.67	0.67	0.67	0.68	0.68
Delay/Veh:	65.8	42.1	42.1	40.1	28.7	28.7	77.0	53.4	53.4	70.8	51.5	51.5
User DelAdj:	1.00	1.00	1.00	1.00	1.00	1.00	1.00	1.00	1.00	1.00	1.00	1.00
AdjDel/Veh:	65.8	42.1	42.1	40.1	28.7	28.7	77.0	53.4	53.4	70.8	51.5	51.5
LOS by Move:	E	D	D	D	C	C	E	D	D	E	D	D
HCM2k95thQ:	15	20	20	20	34	34	10	20	20	10	21	21

Note: Queue reported is the number of cars per lane.

BART Phase II Extension Project

Level Of Service Computation Report
2000 HCM Operations (Future Volume Alternative)
AM - Existing Conditions

Intersection #3059: ALAMEDA/RACE *

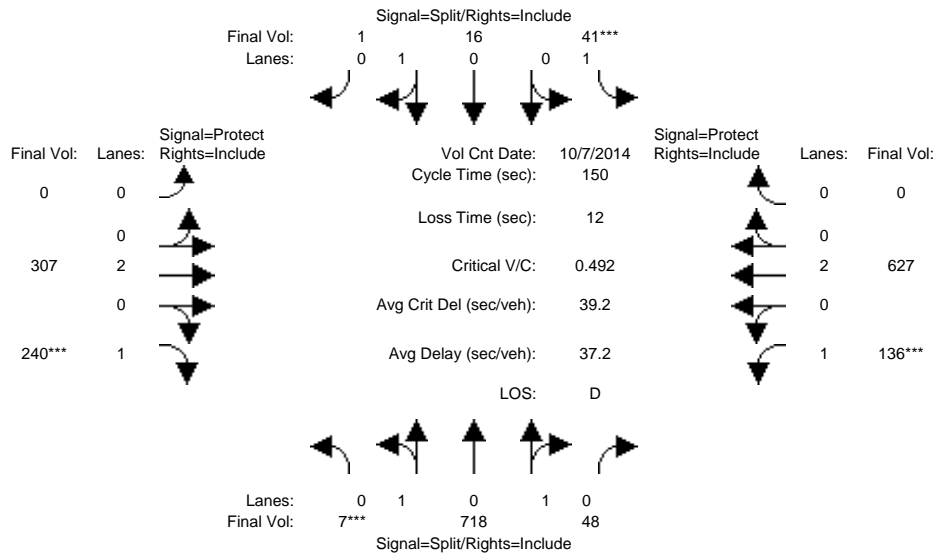

Approach:	North Bound			South Bound			East Bound			West Bound		
	L	T	R	L	T	R	L	T	R	L	T	R
Min. Green:	10	10	10	10	10	10	0	10	10	7	10	0
Y+R:	4.0	4.0	4.0	4.0	4.0	4.0	4.0	4.0	4.0	4.0	4.0	4.0
Volume Module: >> Count Date: 7 Oct 2014 <<												
Base Vol:	7	718	48	41	16	1	0	307	240	136	627	0
Growth Adj:	1.00	1.00	1.00	1.00	1.00	1.00	1.00	1.00	1.00	1.00	1.00	1.00
Initial Bse:	7	718	48	41	16	1	0	307	240	136	627	0
Added Vol:	0	0	0	0	0	0	0	0	0	0	0	0
PasserByVol:	0	0	0	0	0	0	0	0	0	0	0	0
Initial Fut:	7	718	48	41	16	1	0	307	240	136	627	0
User Adj:	1.00	1.00	1.00	1.00	1.00	1.00	1.00	1.00	1.00	1.00	1.00	1.00
PHF Adj:	1.00	1.00	1.00	1.00	1.00	1.00	1.00	1.00	1.00	1.00	1.00	1.00
PHF Volume:	7	718	48	41	16	1	0	307	240	136	627	0
Reduct Vol:	0	0	0	0	0	0	0	0	0	0	0	0
Reduced Vol:	7	718	48	41	16	1	0	307	240	136	627	0
PCE Adj:	1.00	1.00	1.00	1.00	1.00	1.00	1.00	1.00	1.00	1.00	1.00	1.00
MLF Adj:	1.00	1.00	1.00	1.00	1.00	1.00	1.00	1.00	1.00	1.00	1.00	1.00
FinalVolume:	7	718	48	41	16	1	0	307	240	136	627	0
Saturation Flow Module:												
Sat/Lane:	1900	1900	1900	1900	1900	1900	1900	1900	1900	1900	1900	1900
Adjustment:	0.95	0.95	0.95	0.92	0.95	0.95	0.92	1.00	0.92	0.92	1.00	0.92
Lanes:	0.02	1.86	0.12	1.00	0.94	0.06	0.00	2.00	1.00	1.00	2.00	0.00
Final Sat.:	33	3344	224	1750	1694	106	0	3800	1750	1750	3800	0
Capacity Analysis Module:												
Vol/Sat:	0.21	0.21	0.21	0.02	0.01	0.01	0.00	0.08	0.14	0.08	0.17	0.00
Crit Moves:	****			****					****	****		
Green Time:	64.0	64.0	64.0	10.0	10.0	10.0	0.0	40.9	40.9	23.2	64.0	0.0
Volume/Cap:	0.50	0.50	0.50	0.35	0.14	0.14	0.00	0.30	0.50	0.50	0.39	0.00
Delay/Veh:	31.7	31.7	31.7	68.7	66.5	66.5	0.0	43.4	46.9	59.7	29.7	0.0
User DelAdj:	1.00	1.00	1.00	1.00	1.00	1.00	1.00	1.00	1.00	1.00	1.00	1.00
AdjDel/Veh:	31.7	31.7	31.7	68.7	66.5	66.5	0.0	43.4	46.9	59.7	29.7	0.0
LOS by Move:	C	C	C	E	E	E	A	D	D	E	C	A
HCM2k95thQ:	24	24	24	5	2	2	0	10	18	12	18	0

Note: Queue reported is the number of cars per lane.

BART Phase II Extension Project

Level Of Service Computation Report
2000 HCM Operations (Future Volume Alternative)
PM - Existing Conditions

Intersection #3059: ALAMEDA/RACE *

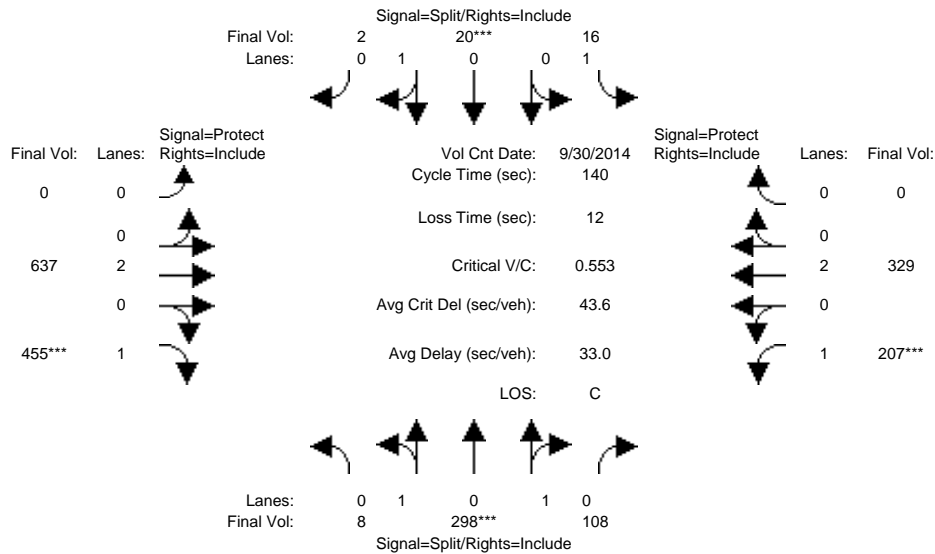

Approach:	North Bound			South Bound			East Bound			West Bound		
	L	T	R	L	T	R	L	T	R	L	T	R
Min. Green:	10	10	10	10	10	10	0	10	10	7	10	0
Y+R:	4.0	4.0	4.0	4.0	4.0	4.0	4.0	4.0	4.0	4.0	4.0	4.0
Volume Module: >> Count Date: 30 Sep 2014 <<												
Base Vol:	8	298	108	16	20	2	0	637	455	207	329	0
Growth Adj:	1.00	1.00	1.00	1.00	1.00	1.00	1.00	1.00	1.00	1.00	1.00	1.00
Initial Bse:	8	298	108	16	20	2	0	637	455	207	329	0
Added Vol:	0	0	0	0	0	0	0	0	0	0	0	0
PasserByVol:	0	0	0	0	0	0	0	0	0	0	0	0
Initial Fut:	8	298	108	16	20	2	0	637	455	207	329	0
User Adj:	1.00	1.00	1.00	1.00	1.00	1.00	1.00	1.00	1.00	1.00	1.00	1.00
PHF Adj:	1.00	1.00	1.00	1.00	1.00	1.00	1.00	1.00	1.00	1.00	1.00	1.00
PHF Volume:	8	298	108	16	20	2	0	637	455	207	329	0
Reduct Vol:	0	0	0	0	0	0	0	0	0	0	0	0
Reduced Vol:	8	298	108	16	20	2	0	637	455	207	329	0
PCE Adj:	1.00	1.00	1.00	1.00	1.00	1.00	1.00	1.00	1.00	1.00	1.00	1.00
MLF Adj:	1.00	1.00	1.00	1.00	1.00	1.00	1.00	1.00	1.00	1.00	1.00	1.00
Final Volume:	8	298	108	16	20	2	0	637	455	207	329	0
Saturation Flow Module:												
Sat/Lane:	1900	1900	1900	1900	1900	1900	1900	1900	1900	1900	1900	1900
Adjustment:	0.95	0.95	0.95	0.92	0.95	0.95	0.92	1.00	0.92	0.92	1.00	0.92
Lanes:	0.04	1.44	0.52	1.00	0.91	0.09	0.00	2.00	1.00	1.00	2.00	0.00
Final Sat.:	70	2591	939	1750	1636	164	0	3800	1750	1750	3800	0
Capacity Analysis Module:												
Vol/Sat:	0.12	0.12	0.12	0.01	0.01	0.01	0.00	0.17	0.26	0.12	0.09	0.00
Crit Moves:	****	****	****	****	****	****	****	****	****	****	****	****
Green Time:	27.5	27.5	27.5	10.0	10.0	10.0	0.0	62.2	62.2	28.3	90.5	0.0
Volume/Cap:	0.59	0.59	0.59	0.13	0.17	0.17	0.00	0.38	0.59	0.59	0.13	0.00
Delay/Veh:	52.3	52.3	52.3	61.4	61.7	61.7	0.0	26.1	30.4	53.1	9.6	0.0
User DelAdj:	1.00	1.00	1.00	1.00	1.00	1.00	1.00	1.00	1.00	1.00	1.00	1.00
AdjDel/Veh:	52.3	52.3	52.3	61.4	61.7	61.7	0.0	26.1	30.4	53.1	9.6	0.0
LOS by Move:	D	D	D	E	E	E	A	C	C	D	A	A
HCM2k95thQ:	16	16	16	2	2	2	0	16	27	16	5	0

Note: Queue reported is the number of cars per lane.

BART Phase II Extension Project

Level Of Service Computation Report
 2000 HCM Operations (Future Volume Alternative)
 AM - Existing Conditions

Intersection #3066: AUTUMN/SANTA CLARA

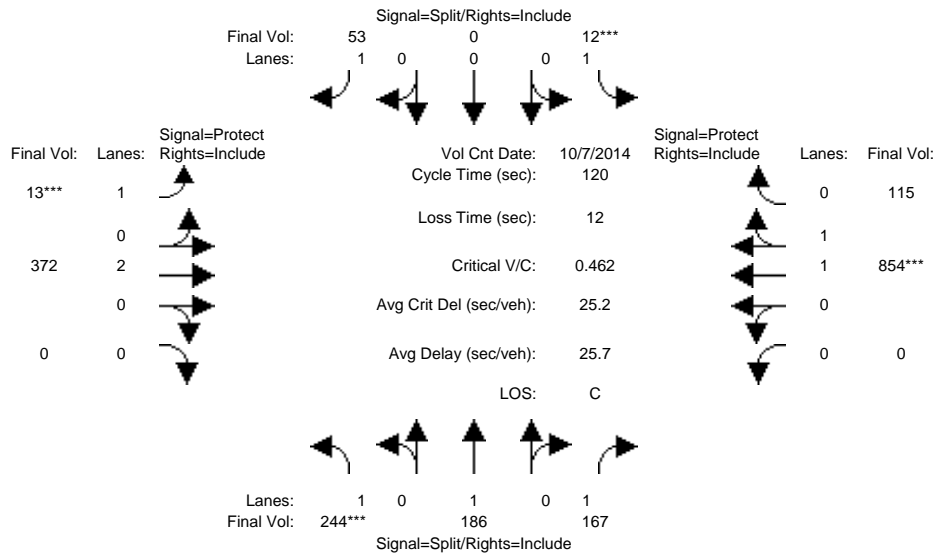

Approach:	North Bound			South Bound			East Bound			West Bound		
	L	T	R	L	T	R	L	T	R	L	T	R
Min. Green:	10	10	10	10	0	10	7	10	0	0	10	10
Y+R:	4.0	4.0	4.0	4.0	4.0	4.0	4.0	4.0	4.0	4.0	4.0	4.0
Volume Module: >> Count Date: 7 Oct 2014 <<												
Base Vol:	244	186	167	12	0	53	13	372	0	0	854	115
Growth Adj:	1.00	1.00	1.00	1.00	1.00	1.00	1.00	1.00	1.00	1.00	1.00	1.00
Initial Bse:	244	186	167	12	0	53	13	372	0	0	854	115
Added Vol:	0	0	0	0	0	0	0	0	0	0	0	0
PasserByVol:	0	0	0	0	0	0	0	0	0	0	0	0
Initial Fut:	244	186	167	12	0	53	13	372	0	0	854	115
User Adj:	1.00	1.00	1.00	1.00	1.00	1.00	1.00	1.00	1.00	1.00	1.00	1.00
PHF Adj:	1.00	1.00	1.00	1.00	1.00	1.00	1.00	1.00	1.00	1.00	1.00	1.00
PHF Volume:	244	186	167	12	0	53	13	372	0	0	854	115
Reduct Vol:	0	0	0	0	0	0	0	0	0	0	0	0
Reduced Vol:	244	186	167	12	0	53	13	372	0	0	854	115
PCE Adj:	1.00	1.00	1.00	1.00	1.00	1.00	1.00	1.00	1.00	1.00	1.00	1.00
MLF Adj:	1.00	1.00	1.00	1.00	1.00	1.00	1.00	1.00	1.00	1.00	1.00	1.00
FinalVolume:	244	186	167	12	0	53	13	372	0	0	854	115
Saturation Flow Module:												
Sat/Lane:	1900	1900	1900	1900	1900	1900	1900	1900	1900	1900	1900	1900
Adjustment:	0.92	1.00	0.92	0.92	1.00	0.92	0.92	1.00	0.92	0.92	0.98	0.95
Lanes:	1.00	1.00	1.00	1.00	0.00	1.00	1.00	2.00	0.00	0.00	1.76	0.24
Final Sat.:	1750	1900	1750	1750	0	1750	1750	3800	0	0	3261	439
Capacity Analysis Module:												
Vol/Sat:	0.14	0.10	0.10	0.01	0.00	0.03	0.01	0.10	0.00	0.00	0.26	0.26
Crit Moves:	****			****			****				****	
Green Time:	31.6	31.6	31.6	10.0	0.0	10.0	7.0	66.4	0.0	0.0	59.4	59.4
Volume/Cap:	0.53	0.37	0.36	0.08	0.00	0.36	0.13	0.18	0.00	0.00	0.53	0.53
Delay/Veh:	39.0	36.6	36.5	51.0	0.0	53.5	54.2	13.3	0.0	0.0	21.0	21.0
User DelAdj:	1.00	1.00	1.00	1.00	1.00	1.00	1.00	1.00	1.00	1.00	1.00	1.00
AdjDel/Veh:	39.0	36.6	36.5	51.0	0.0	53.5	54.2	13.3	0.0	0.0	21.0	21.0
LOS by Move:	D	D	D	D	A	D	D	B	A	A	C	C
HCM2k95thQ:	15	10	10	1	0	4	1	7	0	0	22	22

Note: Queue reported is the number of cars per lane.

BART Phase II Extension Project

Level Of Service Computation Report
2000 HCM Operations (Future Volume Alternative)
PM - Existing Conditions

Intersection #3066: AUTUMN/SANTA CLARA

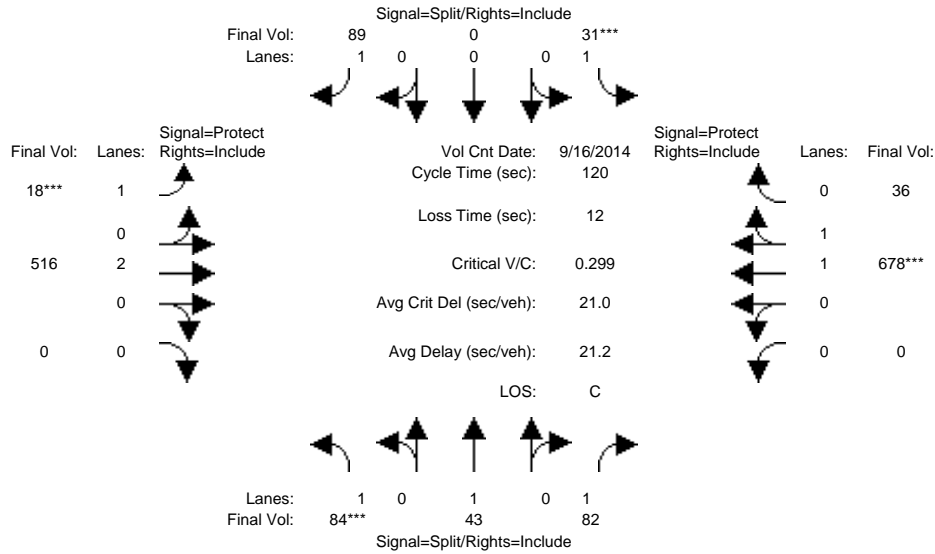

Approach:	North Bound			South Bound			East Bound			West Bound		
	L	T	R	L	T	R	L	T	R	L	T	R
Min. Green:	10	10	10	10	0	10	7	10	0	0	10	10
Y+R:	4.0	4.0	4.0	4.0	4.0	4.0	4.0	4.0	4.0	4.0	4.0	4.0

Volume Module: >> Count Date: 16 Sep 2014 <<

Base Vol:	84	43	82	31	0	89	18	516	0	0	678	36
Growth Adj:	1.00	1.00	1.00	1.00	1.00	1.00	1.00	1.00	1.00	1.00	1.00	1.00
Initial Bse:	84	43	82	31	0	89	18	516	0	0	678	36
Added Vol:	0	0	0	0	0	0	0	0	0	0	0	0
PasserByVol:	0	0	0	0	0	0	0	0	0	0	0	0
Initial Fut:	84	43	82	31	0	89	18	516	0	0	678	36
User Adj:	1.00	1.00	1.00	1.00	1.00	1.00	1.00	1.00	1.00	1.00	1.00	1.00
PHF Adj:	1.00	1.00	1.00	1.00	1.00	1.00	1.00	1.00	1.00	1.00	1.00	1.00
PHF Volume:	84	43	82	31	0	89	18	516	0	0	678	36
Reduct Vol:	0	0	0	0	0	0	0	0	0	0	0	0
Reduced Vol:	84	43	82	31	0	89	18	516	0	0	678	36
PCE Adj:	1.00	1.00	1.00	1.00	1.00	1.00	1.00	1.00	1.00	1.00	1.00	1.00
MLF Adj:	1.00	1.00	1.00	1.00	1.00	1.00	1.00	1.00	1.00	1.00	1.00	1.00
FinalVolume:	84	43	82	31	0	89	18	516	0	0	678	36

Saturation Flow Module:

Sat/Lane:	1900	1900	1900	1900	1900	1900	1900	1900	1900	1900	1900	1900
Adjustment:	0.92	1.00	0.92	0.92	1.00	0.92	0.92	1.00	0.92	0.92	0.98	0.95
Lanes:	1.00	1.00	1.00	1.00	0.00	1.00	1.00	2.00	0.00	0.00	1.90	0.10
Final Sat.:	1750	1900	1750	1750	0	1750	1750	3800	0	0	3513	187

Capacity Analysis Module:

Vol/Sat:	0.05	0.02	0.05	0.02	0.00	0.05	0.01	0.14	0.00	0.00	0.19	0.19
Crit Moves:	****			****			****				****	
Green Time:	16.1	16.1	16.1	20.4	0.0	20.4	7.0	71.5	0.0	0.0	64.5	64.5
Volume/Cap:	0.36	0.17	0.35	0.10	0.00	0.30	0.18	0.23	0.00	0.00	0.36	0.36
Delay/Veh:	48.2	46.4	48.1	42.2	0.0	44.1	54.6	11.4	0.0	0.0	16.0	16.0
User DelAdj:	1.00	1.00	1.00	1.00	1.00	1.00	1.00	1.00	1.00	1.00	1.00	1.00
AdjDel/Veh:	48.2	46.4	48.1	42.2	0.0	44.1	54.6	11.4	0.0	0.0	16.0	16.0
LOS by Move:	D	D	D	D	A	D	D	B	A	A	B	B
HCM2k95thQ:	6	3	6	2	0	6	1	8	0	0	14	14

Note: Queue reported is the number of cars per lane.

BART Phase II Extension Project

Level Of Service Computation Report
 2000 HCM Operations (Future Volume Alternative)
 AM - Existing Conditions

Intersection #3077: BIRD/SAN CARLOS

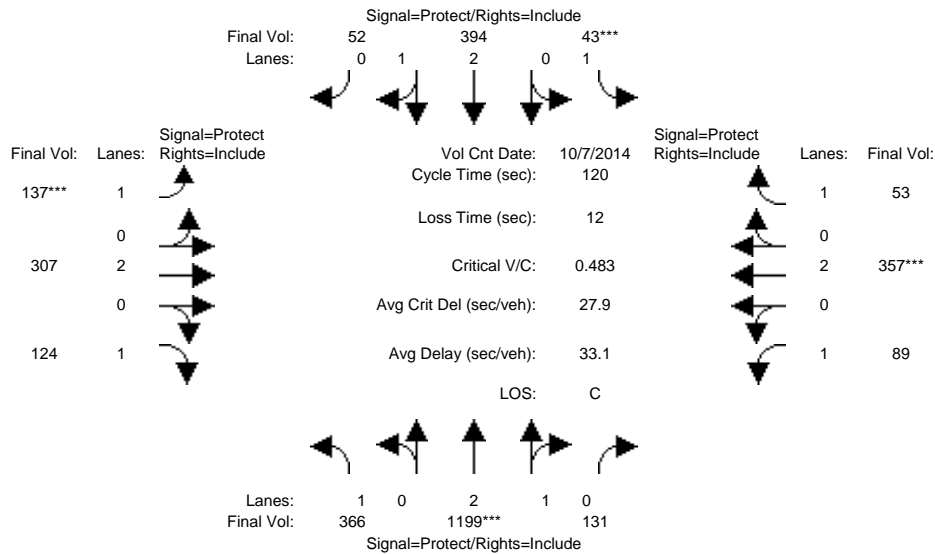

Approach:	North Bound			South Bound			East Bound			West Bound		
Movement:	L	T	R	L	T	R	L	T	R	L	T	R
Min. Green:	7	10	10	7	10	10	7	10	10	7	10	10
Y+R:	4.0	4.0	4.0	4.0	4.0	4.0	4.0	4.0	4.0	4.0	4.0	4.0
Volume Module: >> Count Date: 7 Oct 2014 <<												
Base Vol:	366	1199	131	43	394	52	137	307	124	89	357	53
Growth Adj:	1.00	1.00	1.00	1.00	1.00	1.00	1.00	1.00	1.00	1.00	1.00	1.00
Initial Bse:	366	1199	131	43	394	52	137	307	124	89	357	53
Added Vol:	0	0	0	0	0	0	0	0	0	0	0	0
PasserByVol:	0	0	0	0	0	0	0	0	0	0	0	0
Initial Fut:	366	1199	131	43	394	52	137	307	124	89	357	53
User Adj:	1.00	1.00	1.00	1.00	1.00	1.00	1.00	1.00	1.00	1.00	1.00	1.00
PHF Adj:	1.00	1.00	1.00	1.00	1.00	1.00	1.00	1.00	1.00	1.00	1.00	1.00
PHF Volume:	366	1199	131	43	394	52	137	307	124	89	357	53
Reduct Vol:	0	0	0	0	0	0	0	0	0	0	0	0
Reduced Vol:	366	1199	131	43	394	52	137	307	124	89	357	53
PCE Adj:	1.00	1.00	1.00	1.00	1.00	1.00	1.00	1.00	1.00	1.00	1.00	1.00
MLF Adj:	1.00	1.00	1.00	1.00	1.00	1.00	1.00	1.00	1.00	1.00	1.00	1.00
Final Volume:	366	1199	131	43	394	52	137	307	124	89	357	53
Saturation Flow Module:												
Sat/Lane:	1900	1900	1900	1900	1900	1900	1900	1900	1900	1900	1900	1900
Adjustment:	0.92	0.99	0.95	0.92	0.99	0.95	0.92	1.00	0.92	0.92	1.00	0.92
Lanes:	1.00	2.69	0.31	1.00	2.64	0.36	1.00	2.00	1.00	1.00	2.00	1.00
Final Sat.:	1750	5048	551	1750	4946	653	1750	3800	1750	1750	3800	1750
Capacity Analysis Module:												
Vol/Sat:	0.21	0.24	0.24	0.02	0.08	0.08	0.08	0.08	0.07	0.05	0.09	0.03
Crit Moves:	****			****			****			****		
Green Time:	46.9	58.5	58.5	7.0	18.7	18.7	19.3	25.0	25.0	17.5	23.2	23.2
Volume/Cap:	0.54	0.49	0.49	0.42	0.51	0.51	0.49	0.39	0.34	0.35	0.49	0.16
Delay/Veh:	29.0	20.8	20.8	57.3	47.0	47.0	47.2	41.3	41.1	47.0	43.6	40.5
User DelAdj:	1.00	1.00	1.00	1.00	1.00	1.00	1.00	1.00	1.00	1.00	1.00	1.00
AdjDel/Veh:	29.0	20.8	20.8	57.3	47.0	47.0	47.2	41.3	41.1	47.0	43.6	40.5
LOS by Move:	C	C	C	E	D	D	D	D	D	D	D	D
HCM2k95thQ:	20	20	20	3	10	10	10	9	8	6	11	3

Note: Queue reported is the number of cars per lane.

BART Phase II Extension Project

Level Of Service Computation Report
 2000 HCM Operations (Future Volume Alternative)
 PM - Existing Conditions

Intersection #3077: BIRD/SAN CARLOS

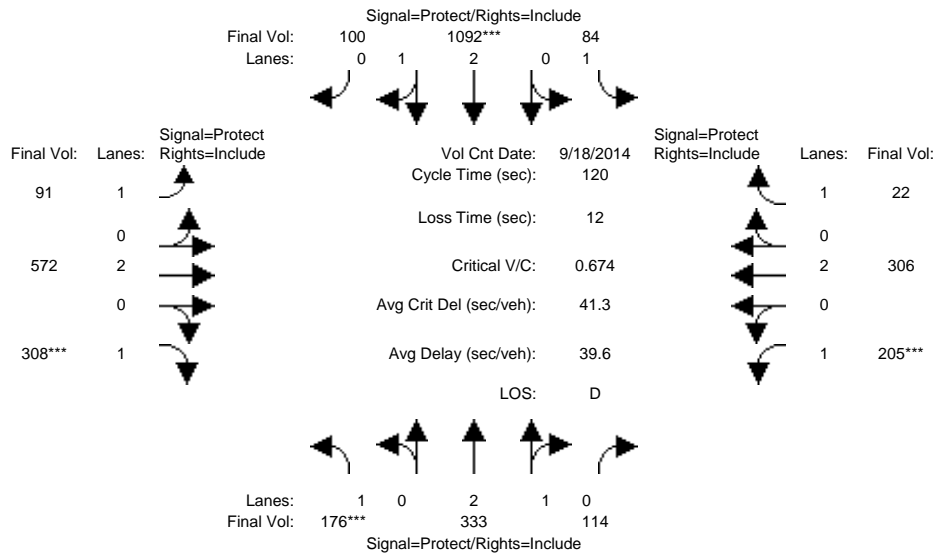

Approach:	North Bound			South Bound			East Bound			West Bound		
	L	T	R	L	T	R	L	T	R	L	T	R
Min. Green:	7	10	10	7	10	10	7	10	10	7	10	10
Y+R:	4.0	4.0	4.0	4.0	4.0	4.0	4.0	4.0	4.0	4.0	4.0	4.0

Volume Module:	>> Count Date: 18 Sep 2014 <<											
Base Vol:	176	333	114	84	1092	100	91	572	308	205	306	22
Growth Adj:	1.00	1.00	1.00	1.00	1.00	1.00	1.00	1.00	1.00	1.00	1.00	1.00
Initial Bse:	176	333	114	84	1092	100	91	572	308	205	306	22
Added Vol:	0	0	0	0	0	0	0	0	0	0	0	0
PasserByVol:	0	0	0	0	0	0	0	0	0	0	0	0
Initial Fut:	176	333	114	84	1092	100	91	572	308	205	306	22
User Adj:	1.00	1.00	1.00	1.00	1.00	1.00	1.00	1.00	1.00	1.00	1.00	1.00
PHF Adj:	1.00	1.00	1.00	1.00	1.00	1.00	1.00	1.00	1.00	1.00	1.00	1.00
PHF Volume:	176	333	114	84	1092	100	91	572	308	205	306	22
Reduct Vol:	0	0	0	0	0	0	0	0	0	0	0	0
Reduced Vol:	176	333	114	84	1092	100	91	572	308	205	306	22
PCE Adj:	1.00	1.00	1.00	1.00	1.00	1.00	1.00	1.00	1.00	1.00	1.00	1.00
MLF Adj:	1.00	1.00	1.00	1.00	1.00	1.00	1.00	1.00	1.00	1.00	1.00	1.00
FinalVolume:	176	333	114	84	1092	100	91	572	308	205	306	22

Saturation Flow Module:												
Sat/Lane:	1900	1900	1900	1900	1900	1900	1900	1900	1900	1900	1900	1900
Adjustment:	0.92	0.99	0.95	0.92	0.99	0.95	0.92	1.00	0.92	0.92	1.00	0.92
Lanes:	1.00	2.21	0.79	1.00	2.74	0.26	1.00	2.00	1.00	1.00	2.00	1.00
Final Sat.:	1750	4170	1428	1750	5130	470	1750	3800	1750	1750	3800	1750

Capacity Analysis Module:												
Vol/Sat:	0.10	0.08	0.08	0.05	0.21	0.21	0.05	0.15	0.18	0.12	0.08	0.01
Crit Moves:	****			****			****		****			
Green Time:	17.9	32.8	32.8	23.0	37.9	37.9	21.5	31.3	31.3	20.9	30.7	30.7
Volume/Cap:	0.67	0.29	0.29	0.25	0.67	0.67	0.29	0.58	0.67	0.67	0.31	0.05
Delay/Veh:	55.1	34.5	34.5	41.6	36.7	36.7	43.2	39.4	43.7	52.3	36.3	33.7
User DelAdj:	1.00	1.00	1.00	1.00	1.00	1.00	1.00	1.00	1.00	1.00	1.00	1.00
AdjDel/Veh:	55.1	34.5	34.5	41.6	36.7	36.7	43.2	39.4	43.7	52.3	36.3	33.7
LOS by Move:	E	C	C	D	D	D	D	D	D	D	D	C
HCM2k95thQ:	13	8	8	6	23	23	6	17	20	15	9	1

Note: Queue reported is the number of cars per lane.

BART Phase II Extension Project

Level Of Service Computation Report
 2000 HCM Operations (Future Volume Alternative)
 AM - Existing Conditions

Intersection #3112: MONTGOMERY/SANTA CLARA

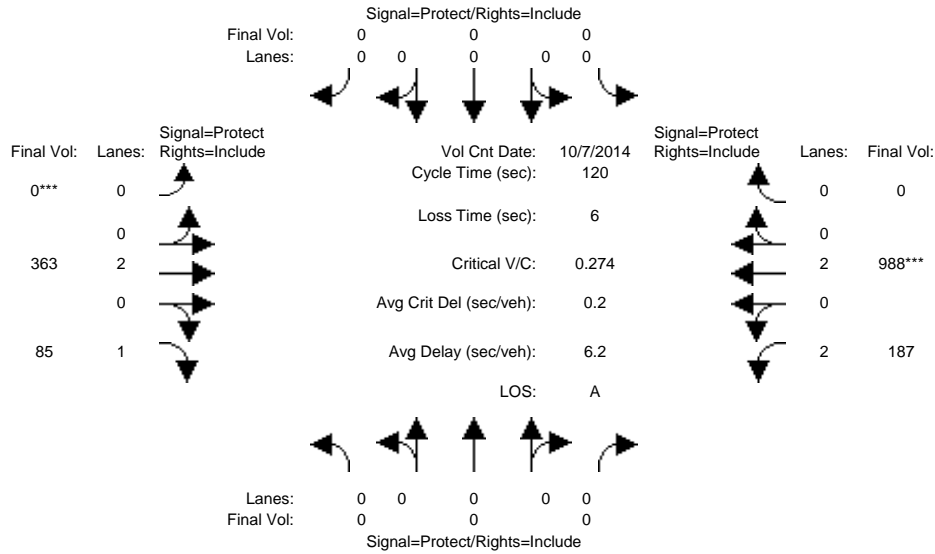

Approach:	North Bound			South Bound			East Bound			West Bound			
	L	T	R	L	T	R	L	T	R	L	T	R	
Min. Green:	0	0	0	0	0	0	0	10	10	7	10	0	
Y+R:	4.0	4.0	4.0	4.0	4.0	4.0	4.0	4.0	4.0	4.0	4.0	4.0	
Volume Module: >> Count Date: 7 Oct 2014 <<													
Base Vol:	0	0	0	0	0	0	0	363	85	187	988	0	
Growth Adj:	1.00	1.00	1.00	1.00	1.00	1.00	1.00	1.00	1.00	1.00	1.00	1.00	
Initial Bse:	0	0	0	0	0	0	0	363	85	187	988	0	
Added Vol:	0	0	0	0	0	0	0	0	0	0	0	0	
PasserByVol:	0	0	0	0	0	0	0	0	0	0	0	0	
Initial Fut:	0	0	0	0	0	0	0	363	85	187	988	0	
User Adj:	1.00	1.00	1.00	1.00	1.00	1.00	1.00	1.00	1.00	1.00	1.00	1.00	
PHF Adj:	1.00	1.00	1.00	1.00	1.00	1.00	1.00	1.00	1.00	1.00	1.00	1.00	
PHF Volume:	0	0	0	0	0	0	0	363	85	187	988	0	
Reduct Vol:	0	0	0	0	0	0	0	0	0	0	0	0	
Reduced Vol:	0	0	0	0	0	0	0	363	85	187	988	0	
PCE Adj:	1.00	1.00	1.00	1.00	1.00	1.00	1.00	1.00	1.00	1.00	1.00	1.00	
MLF Adj:	1.00	1.00	1.00	1.00	1.00	1.00	1.00	1.00	1.00	1.00	1.00	1.00	
FinalVolume:	0	0	0	0	0	0	0	363	85	187	988	0	
Saturation Flow Module:													
Sat/Lane:	1900	1900	1900	1900	1900	1900	1900	1900	1900	1900	1900	1900	
Adjustment:	0.92	1.00	0.92	0.92	1.00	0.92	0.92	1.00	0.92	0.83	1.00	0.92	
Lanes:	0.00	0.00	0.00	0.00	0.00	0.00	0.00	2.00	1.00	2.00	2.00	0.00	
Final Sat.:	0	0	0	0	0	0	0	3800	1750	3150	3800	0	
Capacity Analysis Module:													
Vol/Sat:	0.00	0.00	0.00	0.00	0.00	0.00	0.00	0.10	0.05	0.06	0.26	0.00	
Crit Moves:							****	****					
Green Time:	0.0	0.0	0.0	0.0	0.0	0.0	0.0	70.3	70.3	43.7	114	0.0	
Volume/Cap:	0.00	0.00	0.00	0.00	0.00	0.00	0.00	0.16	0.08	0.16	0.27	0.00	
Delay/Veh:	0.0	0.0	0.0	0.0	0.0	0.0	0.0	11.4	10.8	25.9	0.2	0.0	
User DelAdj:	1.00	1.00	1.00	1.00	1.00	1.00	1.00	1.00	1.00	1.00	1.00	1.00	
AdjDel/Veh:	0.0	0.0	0.0	0.0	0.0	0.0	0.0	11.4	10.8	25.9	0.2	0.0	
LOS by Move:	A	A	A	A	A	A	A	B	B	C	A	A	
HCM2k95thQ:	0	0	0	0	0	0	0	6	3	5	3	0	

Note: Queue reported is the number of cars per lane.

BART Phase II Extension Project

Level Of Service Computation Report
 2000 HCM Operations (Future Volume Alternative)
 PM - Existing Conditions

Intersection #3112: MONTGOMERY/SANTA CLARA

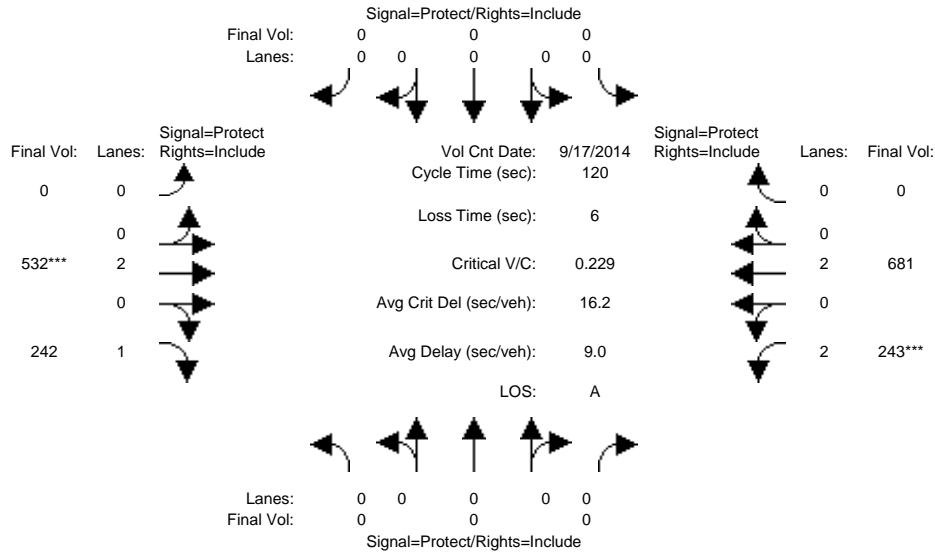

Approach:	North Bound			South Bound			East Bound			West Bound		
	L	T	R	L	T	R	L	T	R	L	T	R
Min. Green:	0	0	0	0	0	0	0	10	10	7	10	0
Y+R:	4.0	4.0	4.0	4.0	4.0	4.0	4.0	4.0	4.0	4.0	4.0	4.0
Volume Module: >> Count Date: 17 Sep 2014 <<												
Base Vol:	0	0	0	0	0	0	0	532	242	243	681	0
Growth Adj:	1.00	1.00	1.00	1.00	1.00	1.00	1.00	1.00	1.00	1.00	1.00	1.00
Initial Bse:	0	0	0	0	0	0	0	532	242	243	681	0
Added Vol:	0	0	0	0	0	0	0	0	0	0	0	0
PasserByVol:	0	0	0	0	0	0	0	0	0	0	0	0
Initial Fut:	0	0	0	0	0	0	0	532	242	243	681	0
User Adj:	1.00	1.00	1.00	1.00	1.00	1.00	1.00	1.00	1.00	1.00	1.00	1.00
PHF Adj:	1.00	1.00	1.00	1.00	1.00	1.00	1.00	1.00	1.00	1.00	1.00	1.00
PHF Volume:	0	0	0	0	0	0	0	532	242	243	681	0
Reduct Vol:	0	0	0	0	0	0	0	0	0	0	0	0
Reduced Vol:	0	0	0	0	0	0	0	532	242	243	681	0
PCE Adj:	1.00	1.00	1.00	1.00	1.00	1.00	1.00	1.00	1.00	1.00	1.00	1.00
MLF Adj:	1.00	1.00	1.00	1.00	1.00	1.00	1.00	1.00	1.00	1.00	1.00	1.00
FinalVolume:	0	0	0	0	0	0	0	532	242	243	681	0
Saturation Flow Module:												
Sat/Lane:	1900	1900	1900	1900	1900	1900	1900	1900	1900	1900	1900	1900
Adjustment:	0.92	1.00	0.92	0.92	1.00	0.92	0.92	1.00	0.92	0.83	1.00	0.92
Lanes:	0.00	0.00	0.00	0.00	0.00	0.00	0.00	2.00	1.00	2.00	2.00	0.00
Final Sat.:	0	0	0	0	0	0	0	3800	1750	3150	3800	0
Capacity Analysis Module:												
Vol/Sat:	0.00	0.00	0.00	0.00	0.00	0.00	0.00	0.14	0.14	0.08	0.18	0.00
Crit Moves:	****											
Green Time:	0.0	0.0	0.0	0.0	0.0	0.0	0.0	73.5	73.5	40.5	114	0.0
Volume/Cap:	0.00	0.00	0.00	0.00	0.00	0.00	0.00	0.23	0.23	0.23	0.19	0.00
Delay/Veh:	0.0	0.0	0.0	0.0	0.0	0.0	0.0	10.5	10.6	28.6	0.2	0.0
User DelAdj:	1.00	1.00	1.00	1.00	1.00	1.00	1.00	1.00	1.00	1.00	1.00	1.00
AdjDel/Veh:	0.0	0.0	0.0	0.0	0.0	0.0	0.0	10.5	10.6	28.6	0.2	0.0
LOS by Move:	A	A	A	A	A	A	A	B	B	C	A	A
HCM2k95thQ:	0	0	0	0	0	0	0	8	8	7	2	0

Note: Queue reported is the number of cars per lane.

BART Phase II Extension Project

Level Of Service Computation Report
2000 HCM Operations (Future Volume Alternative)
AM - Existing Conditions

Intersection #3227: ALAMEDA/JULIAN

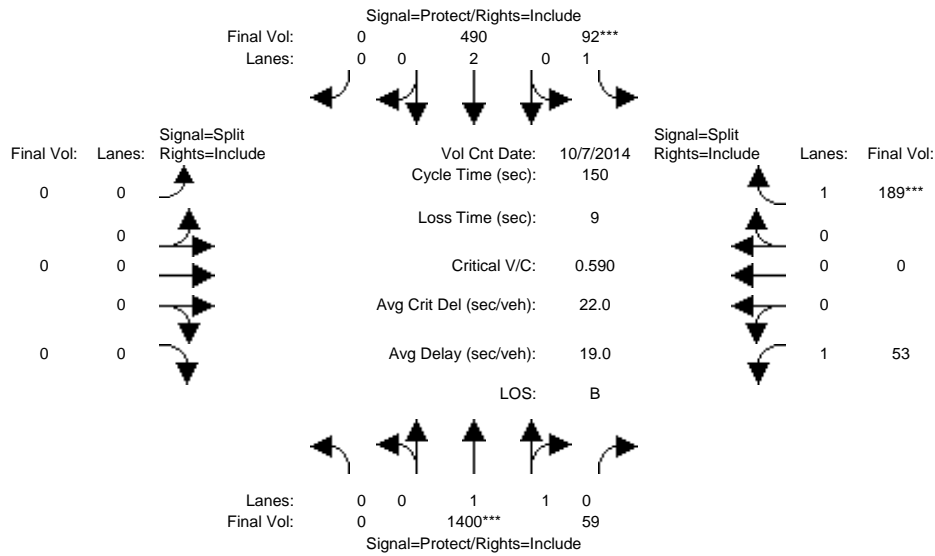

Approach:	North Bound			South Bound			East Bound			West Bound		
	L	T	R	L	T	R	L	T	R	L	T	R
Min. Green:	0	10	10	7	10	0	0	0	0	10	0	10
Y+R:	4.0	4.0	4.0	4.0	4.0	4.0	4.0	4.0	4.0	4.0	4.0	4.0

Volume Module:	>>	Count	Date:	7 Oct 2014	<<							
Base Vol:	0	1400	59	92	490	0	0	0	0	53	0	189
Growth Adj:	1.00	1.00	1.00	1.00	1.00	1.00	1.00	1.00	1.00	1.00	1.00	1.00
Initial Bse:	0	1400	59	92	490	0	0	0	0	53	0	189
Added Vol:	0	0	0	0	0	0	0	0	0	0	0	0
PasserByVol:	0	0	0	0	0	0	0	0	0	0	0	0
Initial Fut:	0	1400	59	92	490	0	0	0	0	53	0	189
User Adj:	1.00	1.00	1.00	1.00	1.00	1.00	1.00	1.00	1.00	1.00	1.00	1.00
PHF Adj:	1.00	1.00	1.00	1.00	1.00	1.00	1.00	1.00	1.00	1.00	1.00	1.00
PHF Volume:	0	1400	59	92	490	0	0	0	0	53	0	189
Reduct Vol:	0	0	0	0	0	0	0	0	0	0	0	0
Reduced Vol:	0	1400	59	92	490	0	0	0	0	53	0	189
PCE Adj:	1.00	1.00	1.00	1.00	1.00	1.00	1.00	1.00	1.00	1.00	1.00	1.00
MLF Adj:	1.00	1.00	1.00	1.00	1.00	1.00	1.00	1.00	1.00	1.00	1.00	1.00
FinalVolume:	0	1400	59	92	490	0	0	0	0	53	0	189

Saturation Flow Module:												
Sat/Lane:	1900	1900	1900	1900	1900	1900	1900	1900	1900	1900	1900	1900
Adjustment:	0.92	0.97	0.95	0.92	1.00	0.92	0.92	1.00	0.92	0.92	1.00	0.92
Lanes:	0.00	1.92	0.08	1.00	2.00	0.00	0.00	0.00	0.00	1.00	0.00	1.00
Final Sat.:	0	3550	150	1750	3800	0	0	0	0	1750	0	1750

Capacity Analysis Module:												
Vol/Sat:	0.00	0.39	0.39	0.05	0.13	0.00	0.00	0.00	0.00	0.03	0.00	0.11
Crit Moves:	****			****						****		
Green Time:	0.0	100	100.2	13.4	114	0.0	0.0	0.0	0.0	27.4	0.0	27.4
Volume/Cap:	0.00	0.59	0.59	0.59	0.17	0.00	0.00	0.00	0.00	0.17	0.00	0.59
Delay/Veh:	0.0	14.0	14.0	71.6	5.1	0.0	0.0	0.0	0.0	51.9	0.0	59.0
User DelAdj:	1.00	1.00	1.00	1.00	1.00	1.00	1.00	1.00	1.00	1.00	1.00	1.00
AdjDel/Veh:	0.0	14.0	14.0	71.6	5.1	0.0	0.0	0.0	0.0	51.9	0.0	59.0
LOS by Move:	A	B	B	E	A	A	A	A	A	D	A	E
HCM2k95thQ:	0	32	32	9	6	0	0	0	0	4	0	16

Note: Queue reported is the number of cars per lane.

BART Phase II Extension Project

Level Of Service Computation Report
2000 HCM Operations (Future Volume Alternative)
PM - Existing Conditions

Intersection #3227: ALAMEDA/JULIAN

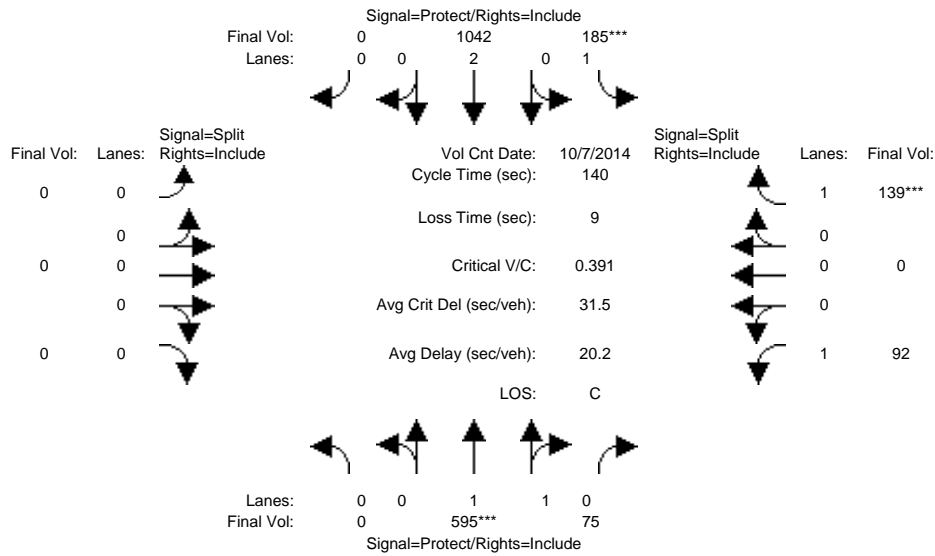

Approach:	North Bound			South Bound			East Bound			West Bound		
	L	T	R	L	T	R	L	T	R	L	T	R
Min. Green:	0	10	10	7	10	0	0	0	0	10	0	10
Y+R:	4.0	4.0	4.0	4.0	4.0	4.0	4.0	4.0	4.0	4.0	4.0	4.0
Volume Module: >> Count Date: 7 Oct 2014 <<												
Base Vol:	0	595	75	185	1042	0	0	0	0	92	0	139
Growth Adj:	1.00	1.00	1.00	1.00	1.00	1.00	1.00	1.00	1.00	1.00	1.00	1.00
Initial Bse:	0	595	75	185	1042	0	0	0	0	92	0	139
Added Vol:	0	0	0	0	0	0	0	0	0	0	0	0
PasserByVol:	0	0	0	0	0	0	0	0	0	0	0	0
Initial Fut:	0	595	75	185	1042	0	0	0	0	92	0	139
User Adj:	1.00	1.00	1.00	1.00	1.00	1.00	1.00	1.00	1.00	1.00	1.00	1.00
PHF Adj:	1.00	1.00	1.00	1.00	1.00	1.00	1.00	1.00	1.00	1.00	1.00	1.00
PHF Volume:	0	595	75	185	1042	0	0	0	0	92	0	139
Reduct Vol:	0	0	0	0	0	0	0	0	0	0	0	0
Reduced Vol:	0	595	75	185	1042	0	0	0	0	92	0	139
PCE Adj:	1.00	1.00	1.00	1.00	1.00	1.00	1.00	1.00	1.00	1.00	1.00	1.00
MLF Adj:	1.00	1.00	1.00	1.00	1.00	1.00	1.00	1.00	1.00	1.00	1.00	1.00
FinalVolume:	0	595	75	185	1042	0	0	0	0	92	0	139
Saturation Flow Module:												
Sat/Lane:	1900	1900	1900	1900	1900	1900	1900	1900	1900	1900	1900	1900
Adjustment:	0.92	0.98	0.95	0.92	1.00	0.92	0.92	1.00	0.92	0.92	1.00	0.92
Lanes:	0.00	1.77	0.23	1.00	2.00	0.00	0.00	0.00	0.00	1.00	0.00	1.00
Final Sat.:	0	3286	414	1750	3800	0	0	0	0	1750	0	1750
Capacity Analysis Module:												
Vol/Sat:	0.00	0.18	0.18	0.11	0.27	0.00	0.00	0.00	0.00	0.05	0.00	0.08
Crit Moves:	****			****						****		
Green Time:	0.0	64.8	64.8	37.8	103	0.0	0.0	0.0	0.0	28.4	0.0	28.4
Volume/Cap:	0.00	0.39	0.39	0.39	0.37	0.00	0.00	0.00	0.00	0.26	0.00	0.39
Delay/Veh:	0.0	24.8	24.8	42.2	7.0	0.0	0.0	0.0	0.0	47.3	0.0	49.0
User DelAdj:	1.00	1.00	1.00	1.00	1.00	1.00	1.00	1.00	1.00	1.00	1.00	1.00
AdjDel/Veh:	0.0	24.8	24.8	42.2	7.0	0.0	0.0	0.0	0.0	47.3	0.0	49.0
LOS by Move:	A	C	C	D	A	A	A	A	A	D	A	D
HCM2k95thQ:	0	17	17	13	15	0	0	0	0	7	0	10

Note: Queue reported is the number of cars per lane.

BART Phase II Extension Project

Level Of Service Computation Report
2000 HCM Operations (Future Volume Alternative)
AM - Existing Conditions

Intersection #3230: ALAMEDA/STOCKTON

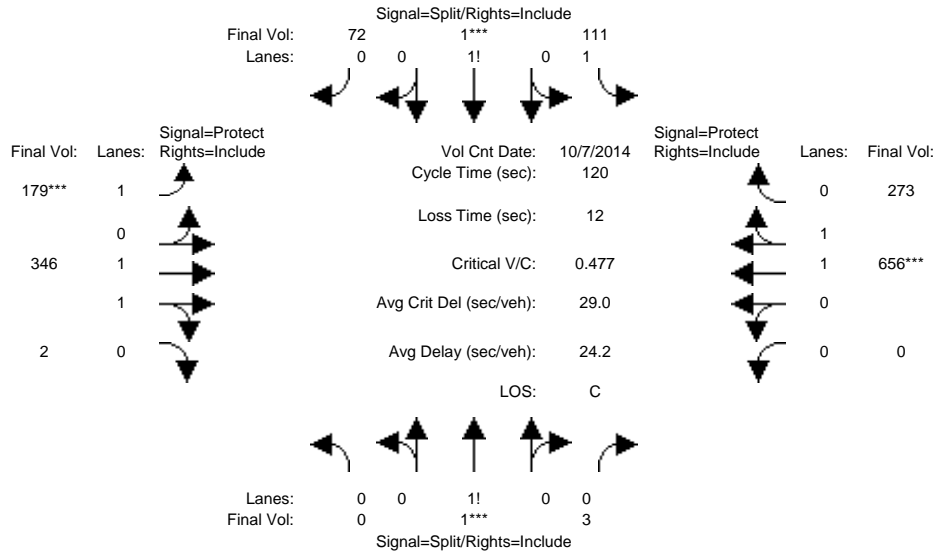

Approach:	North Bound			South Bound			East Bound			West Bound		
	L	T	R	L	T	R	L	T	R	L	T	R
Min. Green:	10	10	10	10	10	10	7	10	10	0	10	10
Y+R:	4.0	4.0	4.0	4.0	4.0	4.0	4.0	4.0	4.0	4.0	4.0	4.0
Volume Module: >> Count Date: 7 Oct 2014 <<												
Base Vol:	0	1	3	111	1	72	179	346	2	0	656	273
Growth Adj:	1.00	1.00	1.00	1.00	1.00	1.00	1.00	1.00	1.00	1.00	1.00	1.00
Initial Bse:	0	1	3	111	1	72	179	346	2	0	656	273
Added Vol:	0	0	0	0	0	0	0	0	0	0	0	0
PasserByVol:	0	0	0	0	0	0	0	0	0	0	0	0
Initial Fut:	0	1	3	111	1	72	179	346	2	0	656	273
User Adj:	1.00	1.00	1.00	1.00	1.00	1.00	1.00	1.00	1.00	1.00	1.00	1.00
PHF Adj:	1.00	1.00	1.00	1.00	1.00	1.00	1.00	1.00	1.00	1.00	1.00	1.00
PHF Volume:	0	1	3	111	1	72	179	346	2	0	656	273
Reduct Vol:	0	0	0	0	0	0	0	0	0	0	0	0
Reduced Vol:	0	1	3	111	1	72	179	346	2	0	656	273
PCE Adj:	1.00	1.00	1.00	1.00	1.00	1.00	1.00	1.00	1.00	1.00	1.00	1.00
MLF Adj:	1.00	1.00	1.00	1.00	1.00	1.00	1.00	1.00	1.00	1.00	1.00	1.00
FinalVolume:	0	1	3	111	1	72	179	346	2	0	656	273
Saturation Flow Module:												
Sat/Lane:	1900	1900	1900	1900	1900	1900	1900	1900	1900	1900	1900	1900
Adjustment:	0.92	0.95	0.95	0.92	0.92	0.92	0.92	0.97	0.95	0.92	0.98	0.95
Lanes:	0.00	0.25	0.75	1.43	0.01	0.56	1.00	1.99	0.01	0.00	1.40	0.60
Final Sat.:	0	450	1350	2506	14	981	1750	3679	21	0	2612	1087
Capacity Analysis Module:												
Vol/Sat:	0.00	0.00	0.00	0.04	0.07	0.07	0.10	0.09	0.09	0.00	0.25	0.25
Crit Moves:	****			****			****			****		
Green Time:	0.0	10.0	10.0	16.9	16.9	16.9	23.5	81.1	81.1	0.0	57.7	57.7
Volume/Cap:	0.00	0.03	0.03	0.32	0.52	0.52	0.52	0.14	0.14	0.00	0.52	0.52
Delay/Veh:	0.0	50.6	50.6	46.7	49.3	49.3	44.7	7.0	7.0	0.0	21.9	21.9
User DelAdj:	1.00	1.00	1.00	1.00	1.00	1.00	1.00	1.00	1.00	1.00	1.00	1.00
AdjDel/Veh:	0.0	50.6	50.6	46.7	49.3	49.3	44.7	7.0	7.0	0.0	21.9	21.9
LOS by Move:	A	D	D	D	D	D	D	A	A	A	C	C
HCM2k95thQ:	0	0	0	5	9	9	12	5	5	0	21	21

Note: Queue reported is the number of cars per lane.

BART Phase II Extension Project

Level Of Service Computation Report
2000 HCM Operations (Future Volume Alternative)
PM - Existing Conditions

Intersection #3230: ALAMEDA/STOCKTON

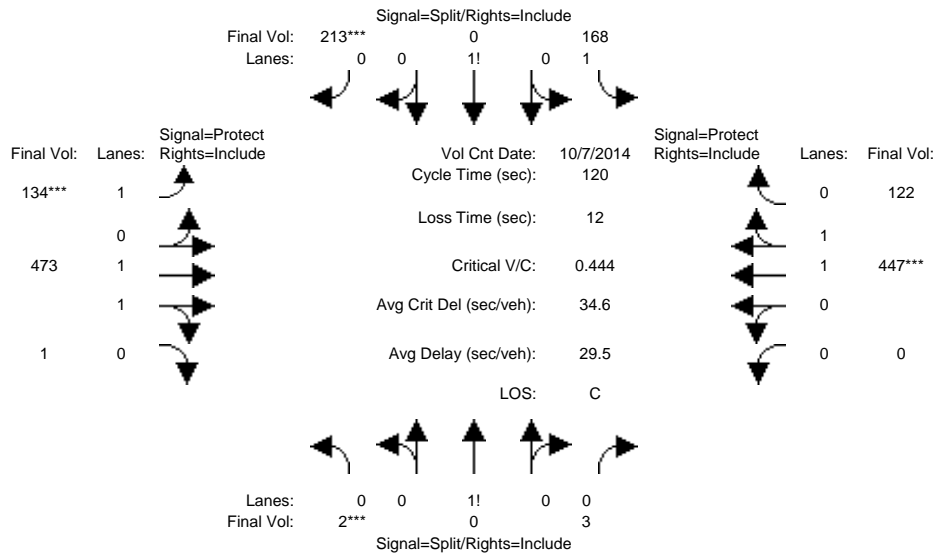

Approach:	North Bound			South Bound			East Bound			West Bound		
	L	T	R	L	T	R	L	T	R	L	T	R
Min. Green:	10	10	10	10	10	10	7	10	10	0	10	10
Y+R:	4.0	4.0	4.0	4.0	4.0	4.0	4.0	4.0	4.0	4.0	4.0	4.0
Volume Module: >> Count Date: 7 Oct 2014 <<												
Base Vol:	2	0	3	168	0	213	134	473	1	0	447	122
Growth Adj:	1.00	1.00	1.00	1.00	1.00	1.00	1.00	1.00	1.00	1.00	1.00	1.00
Initial Bse:	2	0	3	168	0	213	134	473	1	0	447	122
Added Vol:	0	0	0	0	0	0	0	0	0	0	0	0
PasserByVol:	0	0	0	0	0	0	0	0	0	0	0	0
Initial Fut:	2	0	3	168	0	213	134	473	1	0	447	122
User Adj:	1.00	1.00	1.00	1.00	1.00	1.00	1.00	1.00	1.00	1.00	1.00	1.00
PHF Adj:	1.00	1.00	1.00	1.00	1.00	1.00	1.00	1.00	1.00	1.00	1.00	1.00
PHF Volume:	2	0	3	168	0	213	134	473	1	0	447	122
Reduct Vol:	0	0	0	0	0	0	0	0	0	0	0	0
Reduced Vol:	2	0	3	168	0	213	134	473	1	0	447	122
PCE Adj:	1.00	1.00	1.00	1.00	1.00	1.00	1.00	1.00	1.00	1.00	1.00	1.00
MLF Adj:	1.00	1.00	1.00	1.00	1.00	1.00	1.00	1.00	1.00	1.00	1.00	1.00
Final Volume:	2	0	3	168	0	213	134	473	1	0	447	122
Saturation Flow Module:												
Sat/Lane:	1900	1900	1900	1900	1900	1900	1900	1900	1900	1900	1900	1900
Adjustment:	0.92	0.92	0.92	0.92	1.00	0.95	0.92	0.97	0.95	0.92	0.98	0.95
Lanes:	0.40	0.00	0.60	1.29	0.00	0.71	1.00	1.99	0.01	0.00	1.56	0.44
Final Sat.:	700	0	1050	2255	0	1281	1750	3692	8	0	2906	793
Capacity Analysis Module:												
Vol/Sat:	0.00	0.00	0.00	0.07	0.00	0.17	0.08	0.13	0.13	0.00	0.15	0.15
Crit Moves:	****					****	****				****	
Green Time:	10.0	0.0	10.0	41.1	0.0	41.1	18.9	56.9	56.9	0.0	38.0	38.0
Volume/Cap:	0.03	0.00	0.03	0.22	0.00	0.49	0.49	0.27	0.27	0.00	0.49	0.49
Delay/Veh:	50.7	0.0	50.7	28.1	0.0	31.6	47.5	19.1	19.1	0.0	33.4	33.4
User DelAdj:	1.00	1.00	1.00	1.00	1.00	1.00	1.00	1.00	1.00	1.00	1.00	1.00
AdjDel/Veh:	50.7	0.0	50.7	28.1	0.0	31.6	47.5	19.1	19.1	0.0	33.4	33.4
LOS by Move:	D	A	D	C	A	C	D	B	B	A	C	C
HCM2k95thQ:	0	0	0	7	0	16	9	10	10	0	16	16

Note: Queue reported is the number of cars per lane.

BART Phase II Extension Project

Level Of Service Computation Report
2000 HCM Operations (Future Volume Alternative)
AM - Existing Conditions

Intersection #3263: AUTUMN/JULIAN

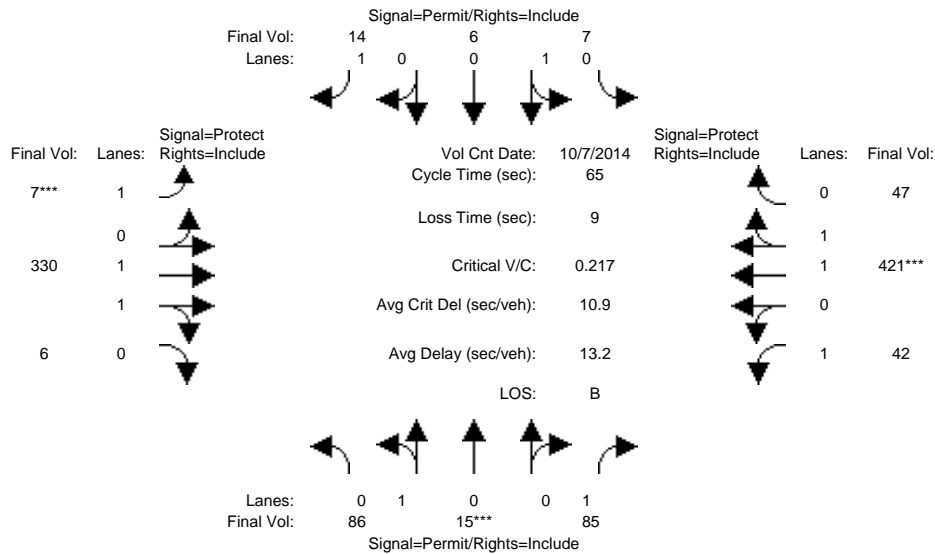

Approach:	North Bound			South Bound			East Bound			West Bound		
	L	T	R	L	T	R	L	T	R	L	T	R
Min. Green:	10	10	10	10	10	10	7	10	10	7	10	10
Y+R:	4.0	4.0	4.0	4.0	4.0	4.0	4.0	4.0	4.0	4.0	4.0	4.0
Volume Module: >> Count Date: 7 Oct 2014 <<												
Base Vol:	86	15	85	7	6	14	7	330	6	42	421	47
Growth Adj:	1.00	1.00	1.00	1.00	1.00	1.00	1.00	1.00	1.00	1.00	1.00	1.00
Initial Bse:	86	15	85	7	6	14	7	330	6	42	421	47
Added Vol:	0	0	0	0	0	0	0	0	0	0	0	0
PasserByVol:	0	0	0	0	0	0	0	0	0	0	0	0
Initial Fut:	86	15	85	7	6	14	7	330	6	42	421	47
User Adj:	1.00	1.00	1.00	1.00	1.00	1.00	1.00	1.00	1.00	1.00	1.00	1.00
PHF Adj:	1.00	1.00	1.00	1.00	1.00	1.00	1.00	1.00	1.00	1.00	1.00	1.00
PHF Volume:	86	15	85	7	6	14	7	330	6	42	421	47
Reduct Vol:	0	0	0	0	0	0	0	0	0	0	0	0
Reduced Vol:	86	15	85	7	6	14	7	330	6	42	421	47
PCE Adj:	1.00	1.00	1.00	1.00	1.00	1.00	1.00	1.00	1.00	1.00	1.00	1.00
MLF Adj:	1.00	1.00	1.00	1.00	1.00	1.00	1.00	1.00	1.00	1.00	1.00	1.00
FinalVolume:	86	15	85	7	6	14	7	330	6	42	421	47
Saturation Flow Module:												
Sat/Lane:	1900	1900	1900	1900	1900	1900	1900	1900	1900	1900	1900	1900
Adjustment:	0.95	0.95	0.92	0.95	0.95	0.92	0.92	0.97	0.95	0.92	0.98	0.95
Lanes:	0.85	0.15	1.00	0.54	0.46	1.00	1.00	1.96	0.04	1.00	1.79	0.21
Final Sat.:	1533	267	1750	969	831	1750	1750	3634	66	1750	3328	372
Capacity Analysis Module:												
Vol/Sat:	0.06	0.06	0.05	0.01	0.01	0.01	0.00	0.09	0.09	0.02	0.13	0.13
Crit Moves:	****						****			****		
Green Time:	15.1	15.1	15.1	15.1	15.1	15.1	7.0	24.1	24.1	16.9	33.9	33.9
Volume/Cap:	0.24	0.24	0.21	0.03	0.03	0.03	0.04	0.25	0.25	0.09	0.24	0.24
Delay/Veh:	20.6	20.6	20.4	19.4	19.4	19.4	26.1	14.3	14.3	18.4	8.6	8.6
User DelAdj:	1.00	1.00	1.00	1.00	1.00	1.00	1.00	1.00	1.00	1.00	1.00	1.00
AdjDel/Veh:	20.6	20.6	20.4	19.4	19.4	19.4	26.1	14.3	14.3	18.4	8.6	8.6
LOS by Move:	C	C	C	B	B	B	C	B	B	B	A	A
HCM2k95thQ:	3	3	3	0	0	1	0	5	5	1	5	5

Note: Queue reported is the number of cars per lane.

BART Phase II Extension Project

Level Of Service Computation Report
2000 HCM Operations (Future Volume Alternative)
PM - Existing Conditions

Intersection #3263: AUTUMN/JULIAN

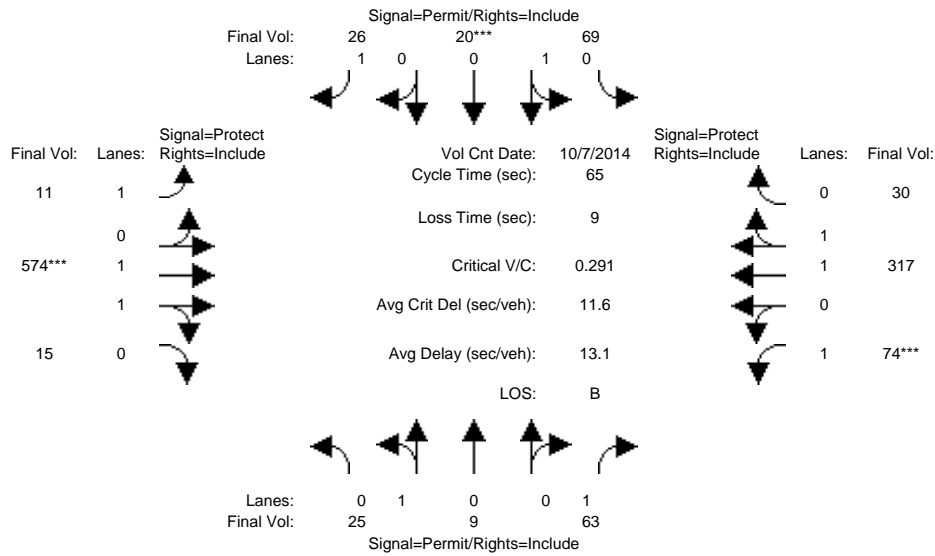

Approach:	North Bound			South Bound			East Bound			West Bound		
Movement:	L	T	R	L	T	R	L	T	R	L	T	R
Min. Green:	10	10	10	10	10	10	7	10	10	7	10	10
Y+R:	4.0	4.0	4.0	4.0	4.0	4.0	4.0	4.0	4.0	4.0	4.0	4.0
Volume Module: >> Count Date: 7 Oct 2014 <<												
Base Vol:	25	9	63	69	20	26	11	574	15	74	317	30
Growth Adj:	1.00	1.00	1.00	1.00	1.00	1.00	1.00	1.00	1.00	1.00	1.00	1.00
Initial Bse:	25	9	63	69	20	26	11	574	15	74	317	30
Added Vol:	0	0	0	0	0	0	0	0	0	0	0	0
PasserByVol:	0	0	0	0	0	0	0	0	0	0	0	0
Initial Fut:	25	9	63	69	20	26	11	574	15	74	317	30
User Adj:	1.00	1.00	1.00	1.00	1.00	1.00	1.00	1.00	1.00	1.00	1.00	1.00
PHF Adj:	1.00	1.00	1.00	1.00	1.00	1.00	1.00	1.00	1.00	1.00	1.00	1.00
PHF Volume:	25	9	63	69	20	26	11	574	15	74	317	30
Reduct Vol:	0	0	0	0	0	0	0	0	0	0	0	0
Reduced Vol:	25	9	63	69	20	26	11	574	15	74	317	30
PCE Adj:	1.00	1.00	1.00	1.00	1.00	1.00	1.00	1.00	1.00	1.00	1.00	1.00
MLF Adj:	1.00	1.00	1.00	1.00	1.00	1.00	1.00	1.00	1.00	1.00	1.00	1.00
FinalVolume:	25	9	63	69	20	26	11	574	15	74	317	30
Saturation Flow Module:												
Sat/Lane:	1900	1900	1900	1900	1900	1900	1900	1900	1900	1900	1900	1900
Adjustment:	0.95	0.95	0.92	0.95	0.95	0.92	0.92	0.97	0.95	0.92	0.98	0.95
Lanes:	0.74	0.26	1.00	0.78	0.22	1.00	1.00	1.95	0.05	1.00	1.82	0.18
Final Sat.:	1324	476	1750	1396	404	1750	1750	3606	94	1750	3380	320
Capacity Analysis Module:												
Vol/Sat:	0.02	0.02	0.04	0.05	0.05	0.01	0.01	0.16	0.16	0.04	0.09	0.09
Crit Moves:				****			****			****		
Green Time:	11.0	11.0	11.0	11.0	11.0	11.0	18.5	35.5	35.5	9.4	26.5	26.5
Volume/Cap:	0.11	0.11	0.21	0.29	0.29	0.09	0.02	0.29	0.29	0.29	0.23	0.23
Delay/Veh:	23.0	23.0	23.6	24.1	24.1	22.9	16.7	8.0	8.0	25.4	12.7	12.7
User DelAdj:	1.00	1.00	1.00	1.00	1.00	1.00	1.00	1.00	1.00	1.00	1.00	1.00
AdjDel/Veh:	23.0	23.0	23.6	24.1	24.1	22.9	16.7	8.0	8.0	25.4	12.7	12.7
LOS by Move:	C	C	C	C	C	C	B	A	A	C	B	B
HCM2k95thQ:	1	1	2	4	4	1	0	6	6	3	5	5

Note: Queue reported is the number of cars per lane.

BART Phase II Extension Project

Level Of Service Computation Report
 2000 HCM Operations (Future Volume Alternative)
 AM - Existing Conditions

Intersection #3264: AUTUMN/SAN FERNANDO

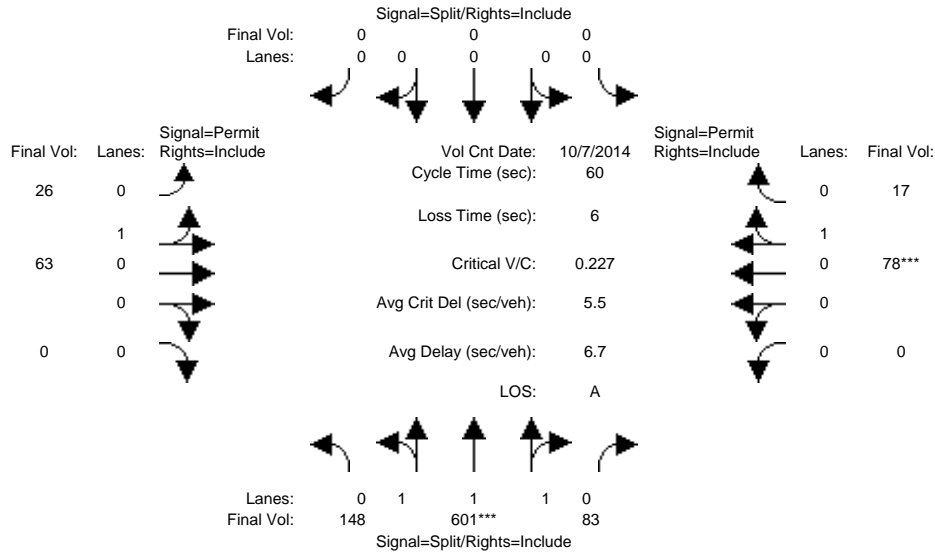

Approach:	North Bound			South Bound			East Bound			West Bound		
	L	T	R	L	T	R	L	T	R	L	T	R
Min. Green:	10	10	10	0	0	0	10	10	0	0	10	10
Y+R:	4.0	4.0	4.0	4.0	4.0	4.0	4.0	4.0	4.0	4.0	4.0	4.0
Volume Module: >> Count Date: 7 Oct 2014 <<												
Base Vol:	148	601	83	0	0	0	26	63	0	0	78	17
Growth Adj:	1.00	1.00	1.00	1.00	1.00	1.00	1.00	1.00	1.00	1.00	1.00	1.00
Initial Bse:	148	601	83	0	0	0	26	63	0	0	78	17
Added Vol:	0	0	0	0	0	0	0	0	0	0	0	0
PasserByVol:	0	0	0	0	0	0	0	0	0	0	0	0
Initial Fut:	148	601	83	0	0	0	26	63	0	0	78	17
User Adj:	1.00	1.00	1.00	1.00	1.00	1.00	1.00	1.00	1.00	1.00	1.00	1.00
PHF Adj:	1.00	1.00	1.00	1.00	1.00	1.00	1.00	1.00	1.00	1.00	1.00	1.00
PHF Volume:	148	601	83	0	0	0	26	63	0	0	78	17
Reduct Vol:	0	0	0	0	0	0	0	0	0	0	0	0
Reduced Vol:	148	601	83	0	0	0	26	63	0	0	78	17
PCE Adj:	1.00	1.00	1.00	1.00	1.00	1.00	1.00	1.00	1.00	1.00	1.00	1.00
MLF Adj:	1.00	1.00	1.00	1.00	1.00	1.00	1.00	1.00	1.00	1.00	1.00	1.00
FinalVolume:	148	601	83	0	0	0	26	63	0	0	78	17
Saturation Flow Module:												
Sat/Lane:	1900	1900	1900	1900	1900	1900	1900	1900	1900	1900	1900	1900
Adjustment:	0.95	0.97	0.95	0.92	1.00	0.92	0.95	0.95	0.92	0.92	0.95	0.95
Lanes:	0.54	2.16	0.30	0.00	0.00	0.00	0.29	0.71	0.00	0.00	0.82	0.18
Final Sat.:	978	3972	549	0	0	0	526	1274	0	0	1478	322
Capacity Analysis Module:												
Vol/Sat:	0.15	0.15	0.15	0.00	0.00	0.00	0.05	0.05	0.00	0.00	0.05	0.05
Crit Moves:	****									****		
Green Time:	40.0	40.0	40.0	0.0	0.0	0.0	14.0	14.0	0.0	0.0	14.0	14.0
Volume/Cap:	0.23	0.23	0.23	0.00	0.00	0.00	0.21	0.21	0.00	0.00	0.23	0.23
Delay/Veh:	3.9	3.9	3.9	0.0	0.0	0.0	18.8	18.8	0.0	0.0	18.9	18.9
User DelAdj:	1.00	1.00	1.00	1.00	1.00	1.00	1.00	1.00	1.00	1.00	1.00	1.00
AdjDel/Veh:	3.9	3.9	3.9	0.0	0.0	0.0	18.8	18.8	0.0	0.0	18.9	18.9
LOS by Move:	A	A	A	A	A	A	B	B	A	A	B	B
HCM2k95thQ:	4	4	4	0	0	0	3	3	0	0	3	3

Note: Queue reported is the number of cars per lane.

BART Phase II Extension Project

Level Of Service Computation Report
 2000 HCM Operations (Future Volume Alternative)
 PM - Existing Conditions

Intersection #3264: AUTUMN/SAN FERNANDO

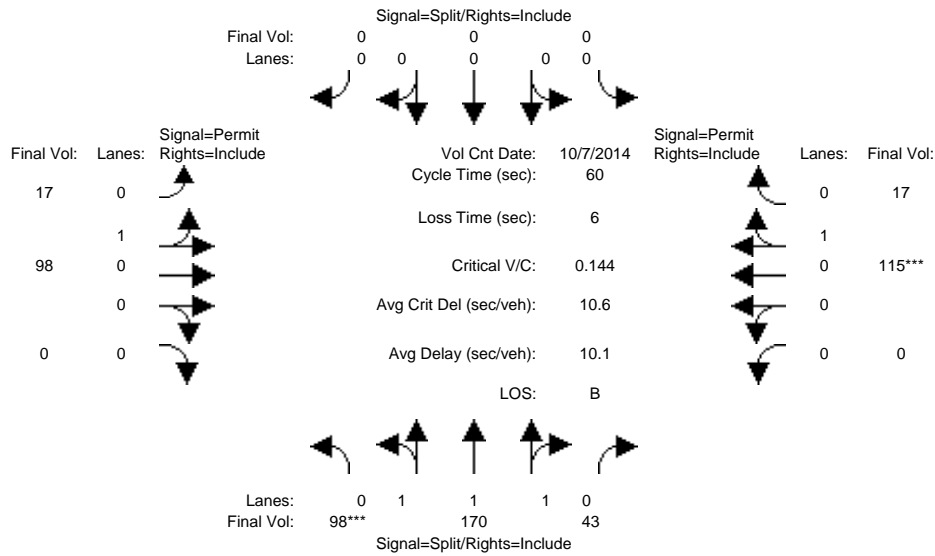

Approach:	North Bound			South Bound			East Bound			West Bound		
	L	T	R	L	T	R	L	T	R	L	T	R
Min. Green:	10	10	10	0	0	0	10	10	0	0	10	10
Y+R:	4.0	4.0	4.0	4.0	4.0	4.0	4.0	4.0	4.0	4.0	4.0	4.0

Volume Module:	>> Count Date: 7 Oct 2014 <<											
Base Vol:	98	170	43	0	0	0	17	98	0	0	115	17
Growth Adj:	1.00	1.00	1.00	1.00	1.00	1.00	1.00	1.00	1.00	1.00	1.00	1.00
Initial Bse:	98	170	43	0	0	0	17	98	0	0	115	17
Added Vol:	0	0	0	0	0	0	0	0	0	0	0	0
PasserByVol:	0	0	0	0	0	0	0	0	0	0	0	0
Initial Fut:	98	170	43	0	0	0	17	98	0	0	115	17
User Adj:	1.00	1.00	1.00	1.00	1.00	1.00	1.00	1.00	1.00	1.00	1.00	1.00
PHF Adj:	1.00	1.00	1.00	1.00	1.00	1.00	1.00	1.00	1.00	1.00	1.00	1.00
PHF Volume:	98	170	43	0	0	0	17	98	0	0	115	17
Reduct Vol:	0	0	0	0	0	0	0	0	0	0	0	0
Reduced Vol:	98	170	43	0	0	0	17	98	0	0	115	17
PCE Adj:	1.00	1.00	1.00	1.00	1.00	1.00	1.00	1.00	1.00	1.00	1.00	1.00
MLF Adj:	1.00	1.00	1.00	1.00	1.00	1.00	1.00	1.00	1.00	1.00	1.00	1.00
FinalVolume:	98	170	43	0	0	0	17	98	0	0	115	17

Saturation Flow Module:												
Sat/Lane:	1900	1900	1900	1900	1900	1900	1900	1900	1900	1900	1900	1900
Adjustment:	0.95	0.98	0.95	0.92	1.00	0.92	0.95	0.95	0.92	0.92	0.95	0.95
Lanes:	0.96	1.62	0.42	0.00	0.00	0.00	0.15	0.85	0.00	0.00	0.87	0.13
Final Sat.:	1733	3006	760	0	0	0	266	1534	0	0	1568	232

Capacity Analysis Module:												
Vol/Sat:	0.06	0.06	0.06	0.00	0.00	0.00	0.06	0.06	0.00	0.00	0.07	0.07
Crit Moves:	****									****		
Green Time:	23.5	23.5	23.5	0.0	0.0	0.0	30.5	30.5	0.0	0.0	30.5	30.5
Volume/Cap:	0.14	0.14	0.14	0.00	0.00	0.00	0.13	0.13	0.00	0.00	0.14	0.14
Delay/Veh:	11.8	11.8	11.8	0.0	0.0	0.0	7.8	7.8	0.0	0.0	7.9	7.9
User DelAdj:	1.00	1.00	1.00	1.00	1.00	1.00	1.00	1.00	1.00	1.00	1.00	1.00
AdjDel/Veh:	11.8	11.8	11.8	0.0	0.0	0.0	7.8	7.8	0.0	0.0	7.9	7.9
LOS by Move:	B	B	B	A	A	A	A	A	A	A	A	A
HCM2k95thQ:	3	3	3	0	0	0	2	2	0	0	3	3

Note: Queue reported is the number of cars per lane.

BART Phase II Extension Project

Level Of Service Computation Report
2000 HCM Operations (Future Volume Alternative)
AM - Existing Conditions

Intersection #3266: AUZERAIS/BIRD

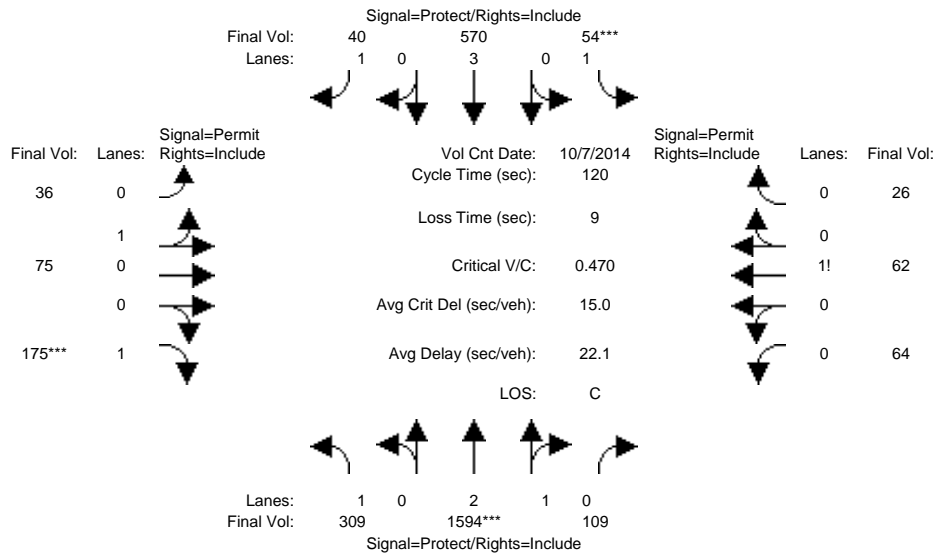

Approach:	North Bound			South Bound			East Bound			West Bound		
	L	T	R	L	T	R	L	T	R	L	T	R
Min. Green:	7	10	10	7	10	10	10	10	10	10	10	10
Y+R:	4.0	4.0	4.0	4.0	4.0	4.0	4.0	4.0	4.0	4.0	4.0	4.0
Volume Module: >> Count Date: 7 Oct 2014 <<												
Base Vol:	309	1594	109	54	570	40	36	75	175	64	62	26
Growth Adj:	1.00	1.00	1.00	1.00	1.00	1.00	1.00	1.00	1.00	1.00	1.00	1.00
Initial Bse:	309	1594	109	54	570	40	36	75	175	64	62	26
Added Vol:	0	0	0	0	0	0	0	0	0	0	0	0
PasserByVol:	0	0	0	0	0	0	0	0	0	0	0	0
Initial Fut:	309	1594	109	54	570	40	36	75	175	64	62	26
User Adj:	1.00	1.00	1.00	1.00	1.00	1.00	1.00	1.00	1.00	1.00	1.00	1.00
PHF Adj:	1.00	1.00	1.00	1.00	1.00	1.00	1.00	1.00	1.00	1.00	1.00	1.00
PHF Volume:	309	1594	109	54	570	40	36	75	175	64	62	26
Reduct Vol:	0	0	0	0	0	0	0	0	0	0	0	0
Reduced Vol:	309	1594	109	54	570	40	36	75	175	64	62	26
PCE Adj:	1.00	1.00	1.00	1.00	1.00	1.00	1.00	1.00	1.00	1.00	1.00	1.00
MLF Adj:	1.00	1.00	1.00	1.00	1.00	1.00	1.00	1.00	1.00	1.00	1.00	1.00
FinalVolume:	309	1594	109	54	570	40	36	75	175	64	62	26
Saturation Flow Module:												
Sat/Lane:	1900	1900	1900	1900	1900	1900	1900	1900	1900	1900	1900	1900
Adjustment:	0.92	0.98	0.95	0.92	1.00	0.92	0.95	0.95	0.92	0.92	0.92	0.92
Lanes:	1.00	2.80	0.20	1.00	3.00	1.00	0.32	0.68	1.00	0.42	0.41	0.17
Final Sat.:	1750	5241	358	1750	5700	1750	584	1216	1750	737	714	299
Capacity Analysis Module:												
Vol/Sat:	0.18	0.30	0.30	0.03	0.10	0.02	0.06	0.06	0.10	0.09	0.09	0.09
Crit Moves:	****			****			****			****		
Green Time:	54.6	77.6	77.6	7.9	30.9	30.9	25.5	25.5	25.5	25.5	25.5	25.5
Volume/Cap:	0.39	0.47	0.47	0.47	0.39	0.09	0.29	0.29	0.47	0.41	0.41	0.41
Delay/Veh:	22.0	10.9	10.9	57.1	36.9	33.9	40.1	40.1	42.3	41.5	41.5	41.5
User DelAdj:	1.00	1.00	1.00	1.00	1.00	1.00	1.00	1.00	1.00	1.00	1.00	1.00
AdjDel/Veh:	22.0	10.9	10.9	57.1	36.9	33.9	40.1	40.1	42.3	41.5	41.5	41.5
LOS by Move:	C	B	B	E	D	C	D	D	D	D	D	D
HCM2k95thQ:	15	19	19	4	11	2	7	7	12	10	10	10

Note: Queue reported is the number of cars per lane.

BART Phase II Extension Project

Level Of Service Computation Report
2000 HCM Operations (Future Volume Alternative)
PM - Existing Conditions

Intersection #3266: AUZERAIS/BIRD

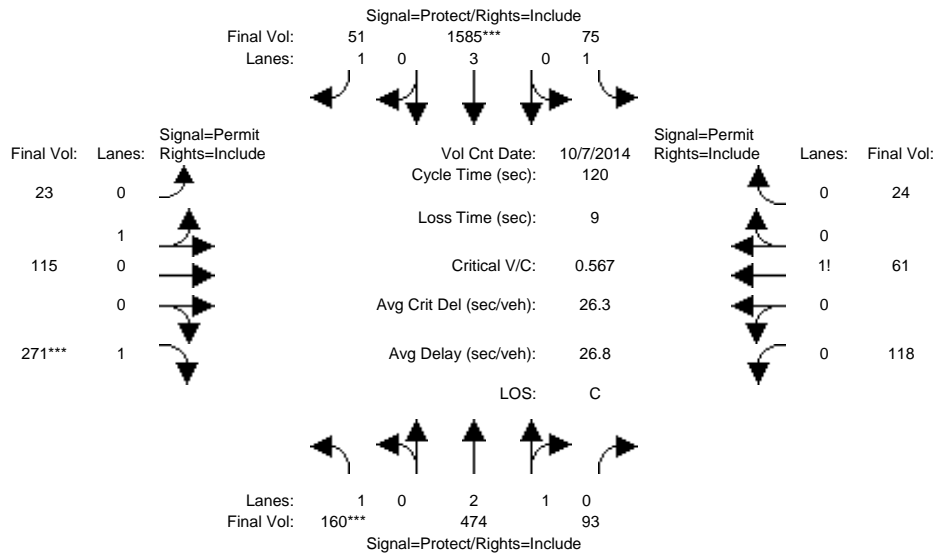

Approach:	North Bound			South Bound			East Bound			West Bound		
Movement:	L	T	R	L	T	R	L	T	R	L	T	R
Min. Green:	7	10	10	7	10	10	10	10	10	10	10	10
Y+R:	4.0	4.0	4.0	4.0	4.0	4.0	4.0	4.0	4.0	4.0	4.0	4.0
Volume Module: >> Count Date: 7 Oct 2014 <<												
Base Vol:	160	474	93	75	1585	51	23	115	271	118	61	24
Growth Adj:	1.00	1.00	1.00	1.00	1.00	1.00	1.00	1.00	1.00	1.00	1.00	1.00
Initial Bse:	160	474	93	75	1585	51	23	115	271	118	61	24
Added Vol:	0	0	0	0	0	0	0	0	0	0	0	0
PasserByVol:	0	0	0	0	0	0	0	0	0	0	0	0
Initial Fut:	160	474	93	75	1585	51	23	115	271	118	61	24
User Adj:	1.00	1.00	1.00	1.00	1.00	1.00	1.00	1.00	1.00	1.00	1.00	1.00
PHF Adj:	1.00	1.00	1.00	1.00	1.00	1.00	1.00	1.00	1.00	1.00	1.00	1.00
PHF Volume:	160	474	93	75	1585	51	23	115	271	118	61	24
Reduct Vol:	0	0	0	0	0	0	0	0	0	0	0	0
Reduced Vol:	160	474	93	75	1585	51	23	115	271	118	61	24
PCE Adj:	1.00	1.00	1.00	1.00	1.00	1.00	1.00	1.00	1.00	1.00	1.00	1.00
MLF Adj:	1.00	1.00	1.00	1.00	1.00	1.00	1.00	1.00	1.00	1.00	1.00	1.00
Final Volume:	160	474	93	75	1585	51	23	115	271	118	61	24
Saturation Flow Module:												
Sat/Lane:	1900	1900	1900	1900	1900	1900	1900	1900	1900	1900	1900	1900
Adjustment:	0.92	0.99	0.95	0.92	1.00	0.92	0.95	0.95	0.92	0.92	0.92	0.92
Lanes:	1.00	2.49	0.51	1.00	3.00	1.00	0.17	0.83	1.00	0.58	0.30	0.12
Final Sat.:	1750	4680	918	1750	5700	1750	300	1500	1750	1017	526	207
Capacity Analysis Module:												
Vol/Sat:	0.09	0.10	0.10	0.04	0.28	0.03	0.08	0.08	0.15	0.12	0.12	0.12
Crit Moves:	****			****			****			****		
Green Time:	19.4	49.6	49.6	28.6	58.9	58.9	32.8	32.8	32.8	32.8	32.8	32.8
Volume/Cap:	0.57	0.24	0.24	0.18	0.57	0.06	0.28	0.28	0.57	0.42	0.42	0.42
Delay/Veh:	49.1	23.0	23.0	36.6	21.8	16.1	34.6	34.6	39.1	36.5	36.5	36.5
User DelAdj:	1.00	1.00	1.00	1.00	1.00	1.00	1.00	1.00	1.00	1.00	1.00	1.00
AdjDel/Veh:	49.1	23.0	23.0	36.6	21.8	16.1	34.6	34.6	39.1	36.5	36.5	36.5
LOS by Move:	D	C	C	D	C	B	C	C	D	D	D	D
HCM2k95thQ:	11	9	9	5	24	2	8	8	17	12	12	12

Note: Queue reported is the number of cars per lane.

BART Phase II Extension Project

Level Of Service Computation Report
2000 HCM Operations (Future Volume Alternative)
AM - Existing Conditions

Intersection #3363: CAHILL/SANTA CLARA

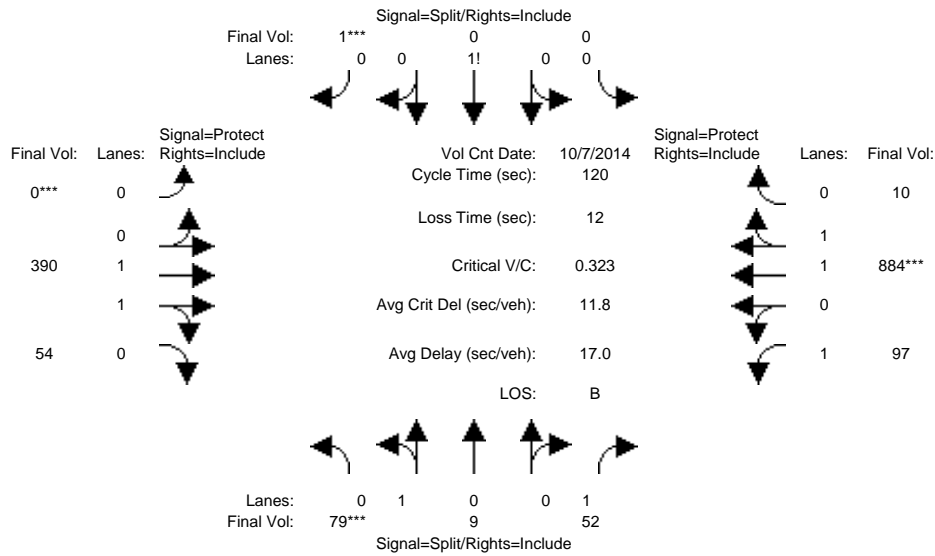

Approach:	North Bound			South Bound			East Bound			West Bound		
Movement:	L	T	R	L	T	R	L	T	R	L	T	R
Min. Green:	10	10	10	10	10	10	7	10	10	7	10	10
Y+R:	4.0	4.0	4.0	4.0	4.0	4.0	4.0	4.0	4.0	4.0	4.0	4.0
Volume Module: >> Count Date: 7 Oct 2014 <<												
Base Vol:	79	9	52	0	0	1	0	390	54	97	884	10
Growth Adj:	1.00	1.00	1.00	1.00	1.00	1.00	1.00	1.00	1.00	1.00	1.00	1.00
Initial Bse:	79	9	52	0	0	1	0	390	54	97	884	10
Added Vol:	0	0	0	0	0	0	0	0	0	0	0	0
PasserByVol:	0	0	0	0	0	0	0	0	0	0	0	0
Initial Fut:	79	9	52	0	0	1	0	390	54	97	884	10
User Adj:	1.00	1.00	1.00	1.00	1.00	1.00	1.00	1.00	1.00	1.00	1.00	1.00
PHF Adj:	1.00	1.00	1.00	1.00	1.00	1.00	1.00	1.00	1.00	1.00	1.00	1.00
PHF Volume:	79	9	52	0	0	1	0	390	54	97	884	10
Reduct Vol:	0	0	0	0	0	0	0	0	0	0	0	0
Reduced Vol:	79	9	52	0	0	1	0	390	54	97	884	10
PCE Adj:	1.00	1.00	1.00	1.00	1.00	1.00	1.00	1.00	1.00	1.00	1.00	1.00
MLF Adj:	1.00	1.00	1.00	1.00	1.00	1.00	1.00	1.00	1.00	1.00	1.00	1.00
FinalVolume:	79	9	52	0	0	1	0	390	54	97	884	10
Saturation Flow Module:												
Sat/Lane:	1900	1900	1900	1900	1900	1900	1900	1900	1900	1900	1900	1900
Adjustment:	0.95	0.95	0.92	0.92	1.00	0.92	0.92	0.98	0.95	0.92	0.97	0.95
Lanes:	0.90	0.10	1.00	0.00	0.00	1.00	0.00	1.75	0.25	1.00	1.98	0.02
Final Sat.:	1616	184	1750	0	0	1750	0	3250	450	1750	3659	41
Capacity Analysis Module:												
Vol/Sat:	0.05	0.05	0.03	0.00	0.00	0.00	0.00	0.12	0.12	0.06	0.24	0.24
Crit Moves:	****					****	****				****	
Green Time:	16.5	16.5	16.5	0.0	0.0	10.0	0.0	54.8	54.8	26.7	81.5	81.5
Volume/Cap:	0.36	0.36	0.22	0.00	0.00	0.01	0.00	0.26	0.26	0.25	0.36	0.36
Delay/Veh:	47.8	47.8	46.5	0.0	0.0	50.5	0.0	20.2	20.2	38.8	8.2	8.2
User DelAdj:	1.00	1.00	1.00	1.00	1.00	1.00	1.00	1.00	1.00	1.00	1.00	1.00
AdjDel/Veh:	47.8	47.8	46.5	0.0	0.0	50.5	0.0	20.2	20.2	38.8	8.2	8.2
LOS by Move:	D	D	D	A	A	D	A	C	C	D	A	A
HCM2k95thQ:	7	7	4	0	0	0	0	10	10	6	13	13

Note: Queue reported is the number of cars per lane.

BART Phase II Extension Project

Level Of Service Computation Report
2000 HCM Operations (Future Volume Alternative)
PM - Existing Conditions

Intersection #3363: CAHILL/SANTA CLARA

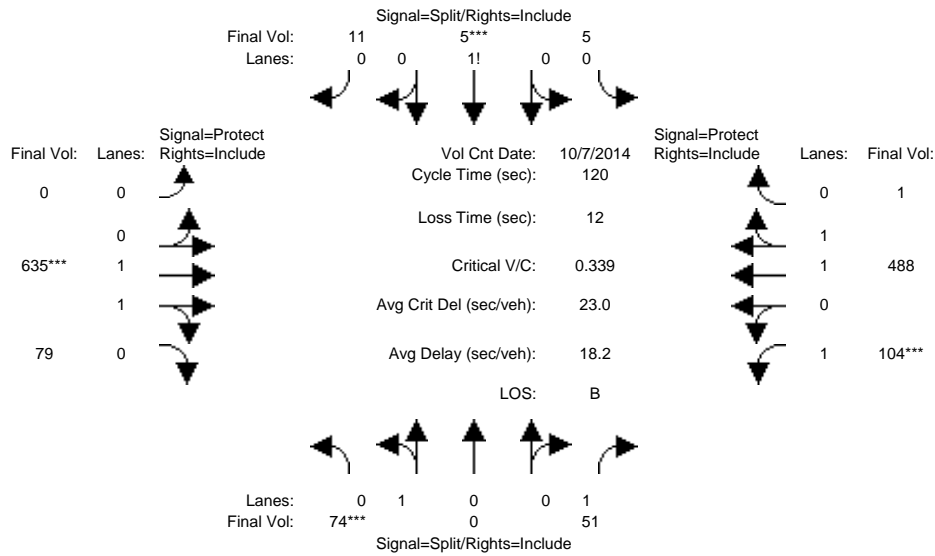

Approach:	North Bound			South Bound			East Bound			West Bound		
	L	T	R	L	T	R	L	T	R	L	T	R
Min. Green:	10	10	10	10	10	10	7	10	10	7	10	10
Y+R:	4.0	4.0	4.0	4.0	4.0	4.0	4.0	4.0	4.0	4.0	4.0	4.0
Volume Module: >> Count Date: 7 Oct 2014 <<												
Base Vol:	74	0	51	5	5	11	0	635	79	104	488	1
Growth Adj:	1.00	1.00	1.00	1.00	1.00	1.00	1.00	1.00	1.00	1.00	1.00	1.00
Initial Bse:	74	0	51	5	5	11	0	635	79	104	488	1
Added Vol:	0	0	0	0	0	0	0	0	0	0	0	0
PasserByVol:	0	0	0	0	0	0	0	0	0	0	0	0
Initial Fut:	74	0	51	5	5	11	0	635	79	104	488	1
User Adj:	1.00	1.00	1.00	1.00	1.00	1.00	1.00	1.00	1.00	1.00	1.00	1.00
PHF Adj:	1.00	1.00	1.00	1.00	1.00	1.00	1.00	1.00	1.00	1.00	1.00	1.00
PHF Volume:	74	0	51	5	5	11	0	635	79	104	488	1
Reduct Vol:	0	0	0	0	0	0	0	0	0	0	0	0
Reduced Vol:	74	0	51	5	5	11	0	635	79	104	488	1
PCE Adj:	1.00	1.00	1.00	1.00	1.00	1.00	1.00	1.00	1.00	1.00	1.00	1.00
MLF Adj:	1.00	1.00	1.00	1.00	1.00	1.00	1.00	1.00	1.00	1.00	1.00	1.00
FinalVolume:	74	0	51	5	5	11	0	635	79	104	488	1
Saturation Flow Module:												
Sat/Lane:	1900	1900	1900	1900	1900	1900	1900	1900	1900	1900	1900	1900
Adjustment:	0.95	0.95	0.92	0.92	0.92	0.92	0.92	0.98	0.95	0.92	0.97	0.95
Lanes:	1.00	0.00	1.00	0.24	0.24	0.52	0.00	1.77	0.23	1.00	1.99	0.01
Final Sat.:	1800	0	1750	417	417	917	0	3290	409	1750	3692	8
Capacity Analysis Module:												
Vol/Sat:	0.04	0.00	0.03	0.01	0.01	0.01	0.00	0.19	0.19	0.06	0.13	0.13
Crit Moves:	****			****			****			****		
Green Time:	13.7	0.0	13.7	10.0	10.0	10.0	0.0	64.4	64.4	19.8	84.3	84.3
Volume/Cap:	0.36	0.00	0.25	0.14	0.14	0.14	0.00	0.36	0.36	0.36	0.19	0.19
Delay/Veh:	50.2	0.0	49.1	51.5	51.5	51.5	0.0	16.1	16.1	45.2	6.2	6.2
User DelAdj:	1.00	1.00	1.00	1.00	1.00	1.00	1.00	1.00	1.00	1.00	1.00	1.00
AdjDel/Veh:	50.2	0.0	49.1	51.5	51.5	51.5	0.0	16.1	16.1	45.2	6.2	6.2
LOS by Move:	D	A	D	D	D	D	A	B	B	D	A	A
HCM2k95thQ:	6	0	4	2	2	2	0	14	14	7	6	6

Note: Queue reported is the number of cars per lane.

BART Phase II Extension Project

Level Of Service Computation Report
 2000 HCM Operations (Future Volume Alternative)
 AM - Existing Conditions

Intersection #3445: DELMAS/PARK *

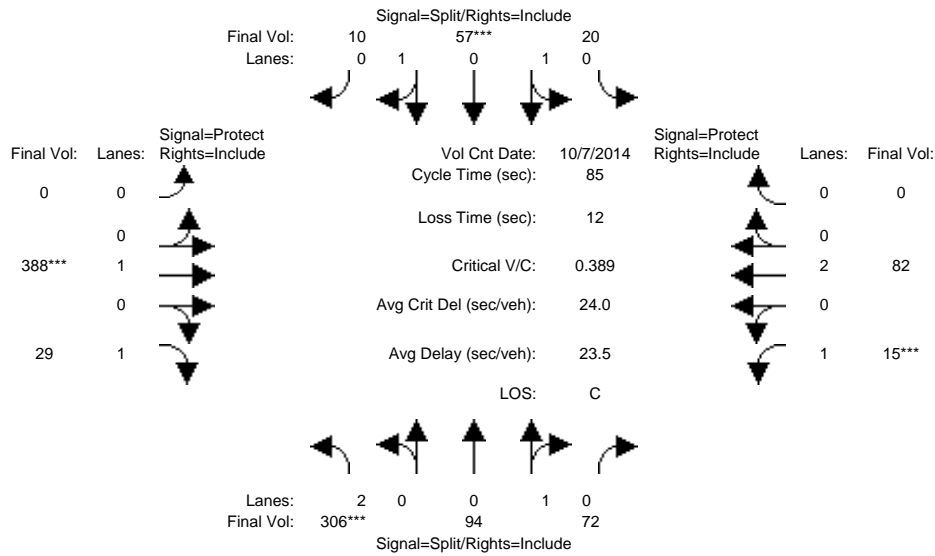

Approach:	North Bound			South Bound			East Bound			West Bound		
	L	T	R	L	T	R	L	T	R	L	T	R
Min. Green:	10	10	10	10	10	10	0	10	10	7	10	0
Y+R:	4.0	4.0	4.0	4.0	4.0	4.0	4.0	4.0	4.0	4.0	4.0	4.0

Volume Module: >> Count Date: 7 Oct 2014 <<

Base Vol:	306	94	72	20	57	10	0	388	29	15	82	0
Growth Adj:	1.00	1.00	1.00	1.00	1.00	1.00	1.00	1.00	1.00	1.00	1.00	1.00
Initial Bse:	306	94	72	20	57	10	0	388	29	15	82	0
Added Vol:	0	0	0	0	0	0	0	0	0	0	0	0
PasserByVol:	0	0	0	0	0	0	0	0	0	0	0	0
Initial Fut:	306	94	72	20	57	10	0	388	29	15	82	0
User Adj:	1.00	1.00	1.00	1.00	1.00	1.00	1.00	1.00	1.00	1.00	1.00	1.00
PHF Adj:	1.00	1.00	1.00	1.00	1.00	1.00	1.00	1.00	1.00	1.00	1.00	1.00
PHF Volume:	306	94	72	20	57	10	0	388	29	15	82	0
Reduct Vol:	0	0	0	0	0	0	0	0	0	0	0	0
Reduced Vol:	306	94	72	20	57	10	0	388	29	15	82	0
PCE Adj:	1.00	1.00	1.00	1.00	1.00	1.00	1.00	1.00	1.00	1.00	1.00	1.00
MLF Adj:	1.00	1.00	1.00	1.00	1.00	1.00	1.00	1.00	1.00	1.00	1.00	1.00
FinalVolume:	306	94	72	20	57	10	0	388	29	15	82	0

Saturation Flow Module:

Sat/Lane:	1900	1900	1900	1900	1900	1900	1900	1900	1900	1900	1900	1900
Adjustment:	0.83	0.95	0.95	0.95	0.95	0.95	0.92	1.00	0.92	0.92	1.00	0.92
Lanes:	2.00	0.57	0.43	0.46	1.31	0.23	0.00	1.00	1.00	1.00	2.00	0.00
Final Sat.:	3150	1019	781	828	2359	414	0	1900	1750	1750	3800	0

Capacity Analysis Module:

Vol/Sat:	0.10	0.09	0.09	0.02	0.02	0.02	0.00	0.20	0.02	0.01	0.02	0.00
Crit Moves:	****			****			****			****		
Green Time:	18.1	18.1	18.1	10.0	10.0	10.0	0.0	37.9	37.9	7.0	44.9	0.0
Volume/Cap:	0.46	0.43	0.43	0.21	0.21	0.21	0.00	0.46	0.04	0.10	0.04	0.00
Delay/Veh:	29.7	29.8	29.8	34.1	34.1	34.1	0.0	16.8	13.3	36.4	9.7	0.0
User DelAdj:	1.00	1.00	1.00	1.00	1.00	1.00	1.00	1.00	1.00	1.00	1.00	1.00
AdjDel/Veh:	29.7	29.8	29.8	34.1	34.1	34.1	0.0	16.8	13.3	36.4	9.7	0.0
LOS by Move:	C	C	C	C	C	C	A	B	B	D	A	A
HCM2k95thQ:	9	9	9	2	2	2	0	13	1	1	1	0

Note: Queue reported is the number of cars per lane.

BART Phase II Extension Project

Level Of Service Computation Report
2000 HCM Operations (Future Volume Alternative)
PM - Existing Conditions

Intersection #3445: DELMAS/PARK *

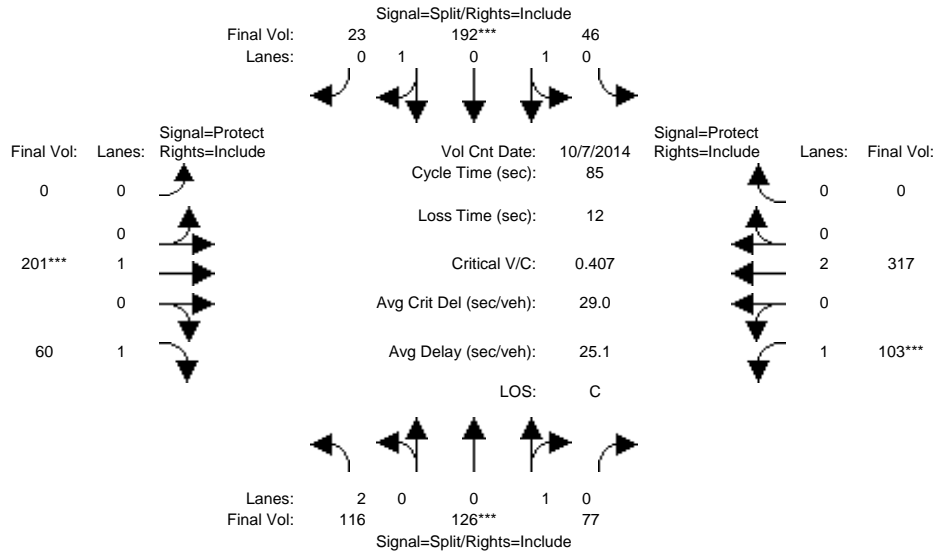

Approach:	North Bound			South Bound			East Bound			West Bound		
	L	T	R	L	T	R	L	T	R	L	T	R
Min. Green:	10	10	10	10	10	10	0	10	10	7	10	0
Y+R:	4.0	4.0	4.0	4.0	4.0	4.0	4.0	4.0	4.0	4.0	4.0	4.0
Volume Module: >> Count Date: 7 Oct 2014 <<												
Base Vol:	116	126	77	46	192	23	0	201	60	103	317	0
Growth Adj:	1.00	1.00	1.00	1.00	1.00	1.00	1.00	1.00	1.00	1.00	1.00	1.00
Initial Bse:	116	126	77	46	192	23	0	201	60	103	317	0
Added Vol:	0	0	0	0	0	0	0	0	0	0	0	0
PasserByVol:	0	0	0	0	0	0	0	0	0	0	0	0
Initial Fut:	116	126	77	46	192	23	0	201	60	103	317	0
User Adj:	1.00	1.00	1.00	1.00	1.00	1.00	1.00	1.00	1.00	1.00	1.00	1.00
PHF Adj:	1.00	1.00	1.00	1.00	1.00	1.00	1.00	1.00	1.00	1.00	1.00	1.00
PHF Volume:	116	126	77	46	192	23	0	201	60	103	317	0
Reduct Vol:	0	0	0	0	0	0	0	0	0	0	0	0
Reduced Vol:	116	126	77	46	192	23	0	201	60	103	317	0
PCE Adj:	1.00	1.00	1.00	1.00	1.00	1.00	1.00	1.00	1.00	1.00	1.00	1.00
MLF Adj:	1.00	1.00	1.00	1.00	1.00	1.00	1.00	1.00	1.00	1.00	1.00	1.00
FinalVolume:	116	126	77	46	192	23	0	201	60	103	317	0
Saturation Flow Module:												
Sat/Lane:	1900	1900	1900	1900	1900	1900	1900	1900	1900	1900	1900	1900
Adjustment:	0.83	0.95	0.95	0.95	0.95	0.95	0.92	1.00	0.92	0.92	1.00	0.92
Lanes:	2.00	0.62	0.38	0.35	1.47	0.18	0.00	1.00	1.00	1.00	2.00	0.00
Final Sat.:	3150	1117	683	634	2648	317	0	1900	1750	1750	3800	0
Capacity Analysis Module:												
Vol/Sat:	0.04	0.11	0.11	0.07	0.07	0.07	0.00	0.11	0.03	0.06	0.08	0.00
Crit Moves:	****			****			****			****		
Green Time:	23.5	23.5	23.5	15.1	15.1	15.1	0.0	22.1	22.1	12.3	34.3	0.0
Volume/Cap:	0.13	0.41	0.41	0.41	0.41	0.41	0.00	0.41	0.13	0.41	0.21	0.00
Delay/Veh:	23.1	25.6	25.6	31.4	31.4	31.4	0.0	26.6	24.3	34.1	16.5	0.0
User DelAdj:	1.00	1.00	1.00	1.00	1.00	1.00	1.00	1.00	1.00	1.00	1.00	1.00
AdjDel/Veh:	23.1	25.6	25.6	31.4	31.4	31.4	0.0	26.6	24.3	34.1	16.5	0.0
LOS by Move:	C	C	C	C	C	C	A	C	C	C	B	A
HCM2k95thQ:	3	9	9	6	6	6	0	8	3	5	5	0

Note: Queue reported is the number of cars per lane.

BART Phase II Extension Project

Level Of Service Computation Report
2000 HCM Operations (Future Volume Alternative)
AM - Existing Conditions

Intersection #3552: FRUITDALE/MERIDIAN

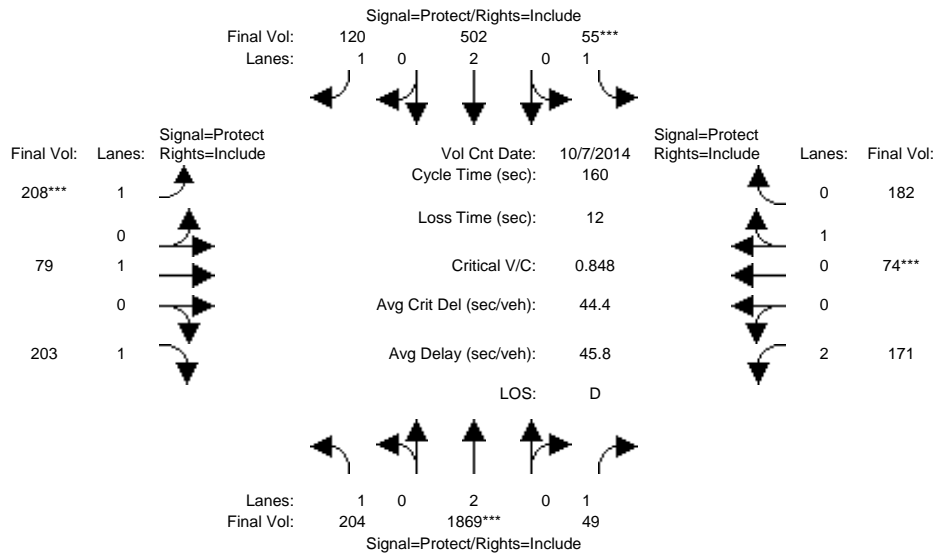

Approach:	North Bound			South Bound			East Bound			West Bound		
Movement:	L	T	R	L	T	R	L	T	R	L	T	R
Min. Green:	7	10	10	7	10	10	7	10	10	7	10	10
Y+R:	4.0	4.0	4.0	4.0	4.0	4.0	4.0	4.0	4.0	4.0	4.0	4.0
Volume Module: >> Count Date: 7 Oct 2014 <<												
Base Vol:	204	1869	49	55	502	120	208	79	203	171	74	182
Growth Adj:	1.00	1.00	1.00	1.00	1.00	1.00	1.00	1.00	1.00	1.00	1.00	1.00
Initial Bse:	204	1869	49	55	502	120	208	79	203	171	74	182
Added Vol:	0	0	0	0	0	0	0	0	0	0	0	0
PasserByVol:	0	0	0	0	0	0	0	0	0	0	0	0
Initial Fut:	204	1869	49	55	502	120	208	79	203	171	74	182
User Adj:	1.00	1.00	1.00	1.00	1.00	1.00	1.00	1.00	1.00	1.00	1.00	1.00
PHF Adj:	1.00	1.00	1.00	1.00	1.00	1.00	1.00	1.00	1.00	1.00	1.00	1.00
PHF Volume:	204	1869	49	55	502	120	208	79	203	171	74	182
Reduct Vol:	0	0	0	0	0	0	0	0	0	0	0	0
Reduced Vol:	204	1869	49	55	502	120	208	79	203	171	74	182
PCE Adj:	1.00	1.00	1.00	1.00	1.00	1.00	1.00	1.00	1.00	1.00	1.00	1.00
MLF Adj:	1.00	1.00	1.00	1.00	1.00	1.00	1.00	1.00	1.00	1.00	1.00	1.00
FinalVolume:	204	1869	49	55	502	120	208	79	203	171	74	182
Saturation Flow Module:												
Sat/Lane:	1900	1900	1900	1900	1900	1900	1900	1900	1900	1900	1900	1900
Adjustment:	0.92	1.00	0.92	0.92	1.00	0.92	0.92	1.00	0.92	0.83	0.95	0.95
Lanes:	1.00	2.00	1.00	1.00	2.00	1.00	1.00	1.00	1.00	2.00	0.29	0.71
Final Sat.:	1750	3800	1750	1750	3800	1750	1750	1900	1750	3150	520	1280
Capacity Analysis Module:												
Vol/Sat:	0.12	0.49	0.03	0.03	0.13	0.07	0.12	0.04	0.12	0.05	0.14	0.14
Crit Moves:	****			****			****			****		
Green Time:	46.5	92.1	92.1	7.0	52.6	52.6	22.3	33.3	33.3	15.6	26.6	26.6
Volume/Cap:	0.40	0.85	0.05	0.72	0.40	0.21	0.85	0.20	0.56	0.56	0.85	0.85
Delay/Veh:	46.1	31.9	14.8	103.3	41.7	38.8	91.6	52.6	58.7	71.2	85.4	85.4
User DelAdj:	1.00	1.00	1.00	1.00	1.00	1.00	1.00	1.00	1.00	1.00	1.00	1.00
AdjDel/Veh:	46.1	31.9	14.8	103.3	41.7	38.8	91.6	52.6	58.7	71.2	85.4	85.4
LOS by Move:	D	C	B	F	D	D	F	D	E	E	F	F
HCM2k95thQ:	16	62	2	6	17	9	21	6	17	11	27	27

Note: Queue reported is the number of cars per lane.

BART Phase II Extension Project

Level Of Service Computation Report
2000 HCM Operations (Future Volume Alternative)
PM - Existing Conditions

Intersection #3552: FRUITDALE/MERIDIAN

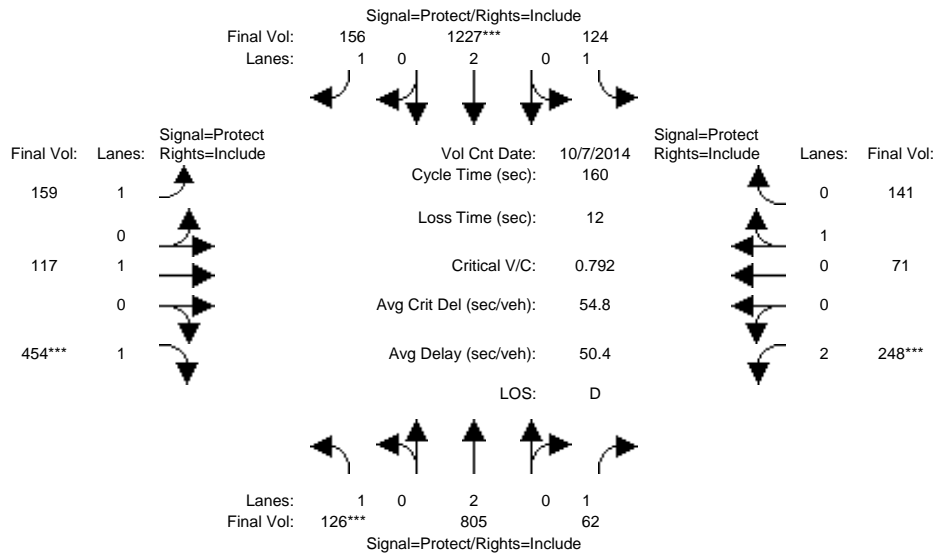

Approach:	North Bound			South Bound			East Bound			West Bound		
Movement:	L	T	R	L	T	R	L	T	R	L	T	R
Min. Green:	7	10	10	7	10	10	7	10	10	7	10	10
Y+R:	4.0	4.0	4.0	4.0	4.0	4.0	4.0	4.0	4.0	4.0	4.0	4.0
Volume Module: >> Count Date: 7 Oct 2014 <<												
Base Vol:	126	805	62	124	1227	156	159	117	454	248	71	141
Growth Adj:	1.00	1.00	1.00	1.00	1.00	1.00	1.00	1.00	1.00	1.00	1.00	1.00
Initial Bse:	126	805	62	124	1227	156	159	117	454	248	71	141
Added Vol:	0	0	0	0	0	0	0	0	0	0	0	0
PasserByVol:	0	0	0	0	0	0	0	0	0	0	0	0
Initial Fut:	126	805	62	124	1227	156	159	117	454	248	71	141
User Adj:	1.00	1.00	1.00	1.00	1.00	1.00	1.00	1.00	1.00	1.00	1.00	1.00
PHF Adj:	1.00	1.00	1.00	1.00	1.00	1.00	1.00	1.00	1.00	1.00	1.00	1.00
PHF Volume:	126	805	62	124	1227	156	159	117	454	248	71	141
Reduct Vol:	0	0	0	0	0	0	0	0	0	0	0	0
Reduced Vol:	126	805	62	124	1227	156	159	117	454	248	71	141
PCE Adj:	1.00	1.00	1.00	1.00	1.00	1.00	1.00	1.00	1.00	1.00	1.00	1.00
MLF Adj:	1.00	1.00	1.00	1.00	1.00	1.00	1.00	1.00	1.00	1.00	1.00	1.00
Final Volume:	126	805	62	124	1227	156	159	117	454	248	71	141
Saturation Flow Module:												
Sat/Lane:	1900	1900	1900	1900	1900	1900	1900	1900	1900	1900	1900	1900
Adjustment:	0.92	1.00	0.92	0.92	1.00	0.92	0.92	1.00	0.92	0.83	0.95	0.95
Lanes:	1.00	2.00	1.00	1.00	2.00	1.00	1.00	1.00	1.00	2.00	0.33	0.67
Final Sat.:	1750	3800	1750	1750	3800	1750	1750	1900	1750	3150	603	1197
Capacity Analysis Module:												
Vol/Sat:	0.07	0.21	0.04	0.07	0.32	0.09	0.09	0.06	0.26	0.08	0.12	0.12
Crit Moves:	****				****				****	****		
Green Time:	14.5	59.7	59.7	20.0	65.2	65.2	29.7	52.4	52.4	15.9	38.5	38.5
Volume/Cap:	0.79	0.57	0.09	0.57	0.79	0.22	0.49	0.19	0.79	0.79	0.49	0.49
Delay/Veh:	94.4	40.4	32.6	69.4	44.4	31.0	59.5	38.7	56.3	83.4	53.1	53.1
User DelAdj:	1.00	1.00	1.00	1.00	1.00	1.00	1.00	1.00	1.00	1.00	1.00	1.00
AdjDel/Veh:	94.4	40.4	32.6	69.4	44.4	31.0	59.5	38.7	56.3	83.4	53.1	53.1
LOS by Move:	F	D	C	E	D	C	E	D	E	F	D	D
HCM2k95thQ:	16	27	4	12	44	10	14	8	37	17	18	18

Note: Queue reported is the number of cars per lane.

BART Phase II Extension Project

Level Of Service Computation Report
2000 HCM Operations (Future Volume Alternative)
AM - Existing Conditions

Intersection #3553: FRUITDALE/SOUTHWEST

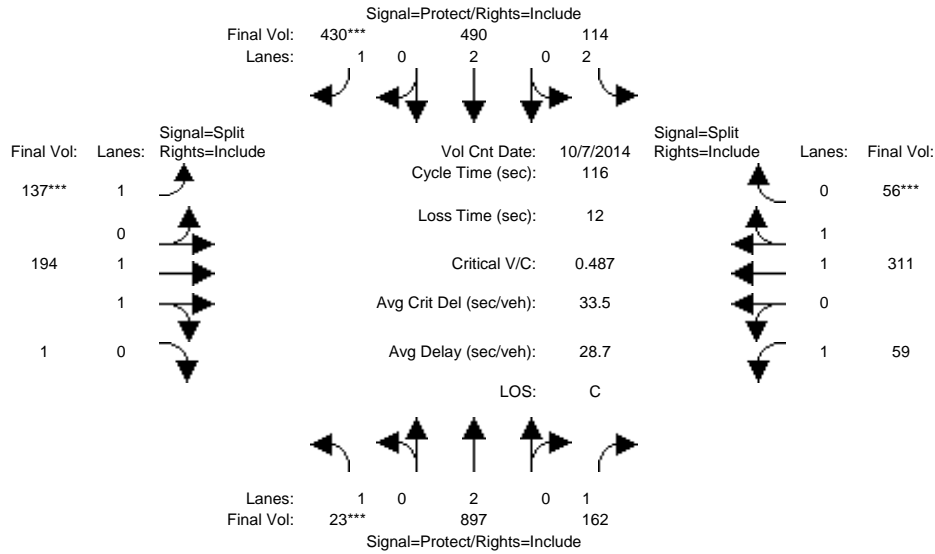

Approach:	North Bound			South Bound			East Bound			West Bound		
	L	T	R	L	T	R	L	T	R	L	T	R
Min. Green:	7	10	10	7	10	10	10	10	10	10	10	10
Y+R:	4.0	4.0	4.0	4.0	4.0	4.0	4.0	4.0	4.0	4.0	4.0	4.0

Volume Module:	>>	Count	Date:	7 Oct 2014	<<											
Base Vol:	23	897	162	114	490	430	137	194	1	59	311	56				
Growth Adj:	1.00	1.00	1.00	1.00	1.00	1.00	1.00	1.00	1.00	1.00	1.00	1.00				
Initial Bse:	23	897	162	114	490	430	137	194	1	59	311	56				
Added Vol:	0	0	0	0	0	0	0	0	0	0	0	0				
PasserByVol:	0	0	0	0	0	0	0	0	0	0	0	0				
Initial Fut:	23	897	162	114	490	430	137	194	1	59	311	56				
User Adj:	1.00	1.00	1.00	1.00	1.00	1.00	1.00	1.00	1.00	1.00	1.00	1.00				
PHF Adj:	1.00	1.00	1.00	1.00	1.00	1.00	1.00	1.00	1.00	1.00	1.00	1.00				
PHF Volume:	23	897	162	114	490	430	137	194	1	59	311	56				
Reduct Vol:	0	0	0	0	0	0	0	0	0	0	0	0				
Reduced Vol:	23	897	162	114	490	430	137	194	1	59	311	56				
PCE Adj:	1.00	1.00	1.00	1.00	1.00	1.00	1.00	1.00	1.00	1.00	1.00	1.00				
MLF Adj:	1.00	1.00	1.00	1.00	1.00	1.00	1.00	1.00	1.00	1.00	1.00	1.00				
FinalVolume:	23	897	162	114	490	430	137	194	1	59	311	56				

Saturation Flow Module:												
Sat/Lane:	1900	1900	1900	1900	1900	1900	1900	1900	1900	1900	1900	1900
Adjustment:	0.92	1.00	0.92	0.83	1.00	0.92	0.92	0.97	0.95	0.92	0.98	0.95
Lanes:	1.00	2.00	1.00	2.00	2.00	1.00	1.00	1.99	0.01	1.00	1.69	0.31
Final Sat.:	1750	3800	1750	3150	3800	1750	1750	3681	19	1750	3135	565

Capacity Analysis Module:												
Vol/Sat:	0.01	0.24	0.09	0.04	0.13	0.25	0.08	0.05	0.05	0.03	0.10	0.10
Crit Moves:	****					****	****					****
Green Time:	7.0	50.4	50.4	12.9	56.3	56.3	17.9	17.9	17.9	22.7	22.7	22.7
Volume/Cap:	0.22	0.54	0.21	0.33	0.27	0.51	0.51	0.34	0.34	0.17	0.51	0.51
Delay/Veh:	52.9	24.6	20.6	48.1	17.7	20.9	46.5	44.1	44.1	39.0	42.2	42.2
User DelAdj:	1.00	1.00	1.00	1.00	1.00	1.00	1.00	1.00	1.00	1.00	1.00	1.00
AdjDel/Veh:	52.9	24.6	20.6	48.1	17.7	20.9	46.5	44.1	44.1	39.0	42.2	42.2
LOS by Move:	D	C	C	D	B	C	D	D	D	D	D	D
HCM2k95thQ:	2	21	8	5	10	21	9	6	6	4	11	11

Note: Queue reported is the number of cars per lane.

BART Phase II Extension Project

Level Of Service Computation Report
2000 HCM Operations (Future Volume Alternative)
PM - Existing Conditions

Intersection #3553: FRUITDALE/SOUTHWEST

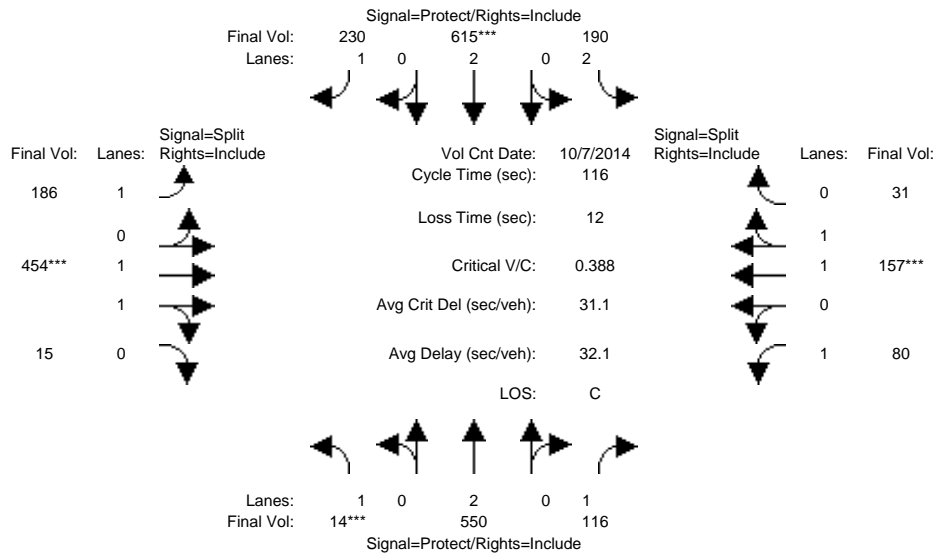

Approach:	North Bound			South Bound			East Bound			West Bound		
	L	T	R	L	T	R	L	T	R	L	T	R
Min. Green:	7	10	10	7	10	10	10	10	10	10	10	10
Y+R:	4.0	4.0	4.0	4.0	4.0	4.0	4.0	4.0	4.0	4.0	4.0	4.0

Volume Module:	>>	Count	Date:	7 Oct 2014	<<							
Base Vol:	14	550	116	190	615	230	186	454	15	80	157	31
Growth Adj:	1.00	1.00	1.00	1.00	1.00	1.00	1.00	1.00	1.00	1.00	1.00	1.00
Initial Bse:	14	550	116	190	615	230	186	454	15	80	157	31
Added Vol:	0	0	0	0	0	0	0	0	0	0	0	0
PasserByVol:	0	0	0	0	0	0	0	0	0	0	0	0
Initial Fut:	14	550	116	190	615	230	186	454	15	80	157	31
User Adj:	1.00	1.00	1.00	1.00	1.00	1.00	1.00	1.00	1.00	1.00	1.00	1.00
PHF Adj:	1.00	1.00	1.00	1.00	1.00	1.00	1.00	1.00	1.00	1.00	1.00	1.00
PHF Volume:	14	550	116	190	615	230	186	454	15	80	157	31
Reduct Vol:	0	0	0	0	0	0	0	0	0	0	0	0
Reduced Vol:	14	550	116	190	615	230	186	454	15	80	157	31
PCE Adj:	1.00	1.00	1.00	1.00	1.00	1.00	1.00	1.00	1.00	1.00	1.00	1.00
MLF Adj:	1.00	1.00	1.00	1.00	1.00	1.00	1.00	1.00	1.00	1.00	1.00	1.00
FinalVolume:	14	550	116	190	615	230	186	454	15	80	157	31

Saturation Flow Module:												
Sat/Lane:	1900	1900	1900	1900	1900	1900	1900	1900	1900	1900	1900	1900
Adjustment:	0.92	1.00	0.92	0.83	1.00	0.92	0.92	0.97	0.95	0.92	0.98	0.95
Lanes:	1.00	2.00	1.00	2.00	2.00	1.00	1.00	1.93	0.07	1.00	1.66	0.34
Final Sat.:	1750	3800	1750	3150	3800	1750	1750	3582	118	1750	3089	610

Capacity Analysis Module:												
Vol/Sat:	0.01	0.14	0.07	0.06	0.16	0.13	0.11	0.13	0.13	0.05	0.05	0.05
Crit Moves:	****			****			****			****		
Green Time:	7.0	37.6	37.6	15.7	46.3	46.3	36.2	36.2	36.2	14.5	14.5	14.5
Volume/Cap:	0.13	0.45	0.20	0.45	0.41	0.33	0.34	0.41	0.41	0.37	0.41	0.41
Delay/Veh:	52.2	31.3	28.6	46.9	25.2	24.4	31.1	31.6	31.6	47.5	47.3	47.3
User DelAdj:	1.00	1.00	1.00	1.00	1.00	1.00	1.00	1.00	1.00	1.00	1.00	1.00
AdjDel/Veh:	52.2	31.3	28.6	46.9	25.2	24.4	31.1	31.6	31.6	47.5	47.3	47.3
LOS by Move:	D	C	C	D	C	C	C	C	C	D	D	D
HCM2k95thQ:	1	15	6	8	15	12	10	12	12	6	6	6

Note: Queue reported is the number of cars per lane.

BART Phase II Extension Project

Level Of Service Computation Report
2000 HCM Operations (Future Volume Alternative)
AM - Existing Conditions

Intersection #3606: JULIAN/MONTGOMERY

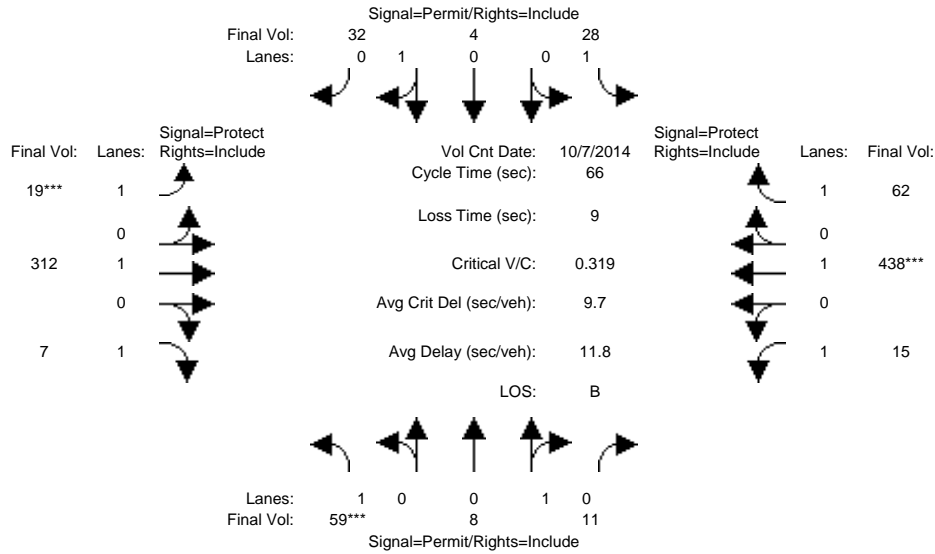

Approach:	North Bound			South Bound			East Bound			West Bound		
	L	T	R	L	T	R	L	T	R	L	T	R
Min. Green:	10	10	10	10	10	10	7	10	10	7	10	10
Y+R:	4.0	4.0	4.0	4.0	4.0	4.0	4.0	4.0	4.0	4.0	4.0	4.0
Volume Module: >> Count Date: 7 Oct 2014 <<												
Base Vol:	59	8	11	28	4	32	19	312	7	15	438	62
Growth Adj:	1.00	1.00	1.00	1.00	1.00	1.00	1.00	1.00	1.00	1.00	1.00	1.00
Initial Bse:	59	8	11	28	4	32	19	312	7	15	438	62
Added Vol:	0	0	0	0	0	0	0	0	0	0	0	0
PasserByVol:	0	0	0	0	0	0	0	0	0	0	0	0
Initial Fut:	59	8	11	28	4	32	19	312	7	15	438	62
User Adj:	1.00	1.00	1.00	1.00	1.00	1.00	1.00	1.00	1.00	1.00	1.00	1.00
PHF Adj:	1.00	1.00	1.00	1.00	1.00	1.00	1.00	1.00	1.00	1.00	1.00	1.00
PHF Volume:	59	8	11	28	4	32	19	312	7	15	438	62
Reduct Vol:	0	0	0	0	0	0	0	0	0	0	0	0
Reduced Vol:	59	8	11	28	4	32	19	312	7	15	438	62
PCE Adj:	1.00	1.00	1.00	1.00	1.00	1.00	1.00	1.00	1.00	1.00	1.00	1.00
MLF Adj:	1.00	1.00	1.00	1.00	1.00	1.00	1.00	1.00	1.00	1.00	1.00	1.00
FinalVolume:	59	8	11	28	4	32	19	312	7	15	438	62
Saturation Flow Module:												
Sat/Lane:	1900	1900	1900	1900	1900	1900	1900	1900	1900	1900	1900	1900
Adjustment:	0.92	0.95	0.95	0.92	0.95	0.95	0.92	1.00	0.92	0.92	1.00	0.92
Lanes:	1.00	0.42	0.58	1.00	0.11	0.89	1.00	1.00	1.00	1.00	1.00	1.00
Final Sat.:	1750	758	1042	1750	200	1600	1750	1900	1750	1750	1900	1750
Capacity Analysis Module:												
Vol/Sat:	0.03	0.01	0.01	0.02	0.02	0.02	0.01	0.16	0.00	0.01	0.23	0.04
Crit Moves:	****						****				****	
Green Time:	10.0	10.0	10.0	10.0	10.0	10.0	7.0	28.6	28.6	18.4	40.0	40.0
Volume/Cap:	0.22	0.07	0.07	0.11	0.13	0.13	0.10	0.38	0.01	0.03	0.38	0.06
Delay/Veh:	25.0	24.1	24.1	24.3	24.5	24.5	26.9	13.0	10.7	17.3	6.9	5.3
User DelAdj:	1.00	1.00	1.00	1.00	1.00	1.00	1.00	1.00	1.00	1.00	1.00	1.00
AdjDel/Veh:	25.0	24.1	24.1	24.3	24.5	24.5	26.9	13.0	10.7	17.3	6.9	5.3
LOS by Move:	C	C	C	C	C	C	C	B	B	B	A	A
HCM2k95thQ:	3	1	1	1	2	2	1	8	0	0	9	1

Note: Queue reported is the number of cars per lane.

BART Phase II Extension Project

Level Of Service Computation Report
2000 HCM Operations (Future Volume Alternative)
PM - Existing Conditions

Intersection #3606: JULIAN/MONTGOMERY

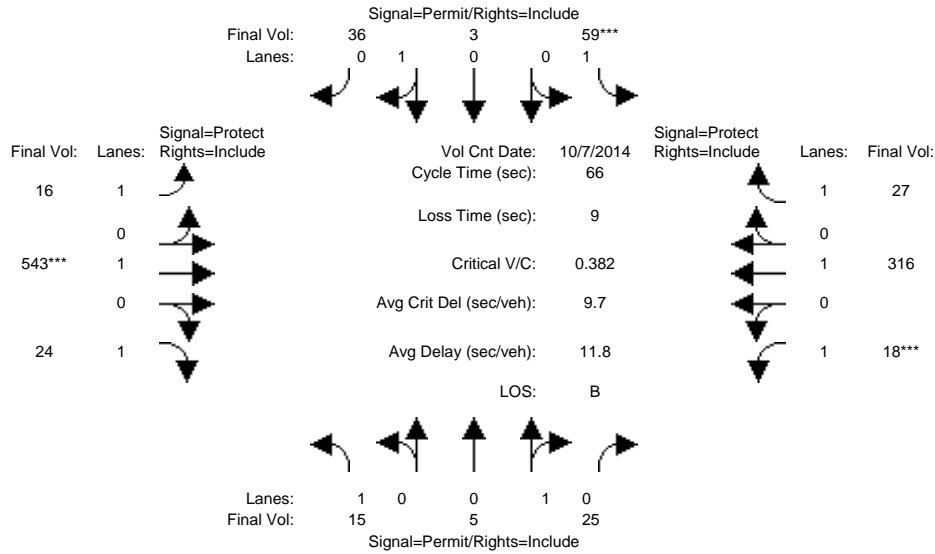

Approach:	North Bound			South Bound			East Bound			West Bound		
	L	T	R	L	T	R	L	T	R	L	T	R
Min. Green:	10	10	10	10	10	10	7	10	10	7	10	10
Y+R:	4.0	4.0	4.0	4.0	4.0	4.0	4.0	4.0	4.0	4.0	4.0	4.0
Volume Module: >> Count Date: 7 Oct 2014 <<												
Base Vol:	15	5	25	59	3	36	16	543	24	18	316	27
Growth Adj:	1.00	1.00	1.00	1.00	1.00	1.00	1.00	1.00	1.00	1.00	1.00	1.00
Initial Bse:	15	5	25	59	3	36	16	543	24	18	316	27
Added Vol:	0	0	0	0	0	0	0	0	0	0	0	0
PasserByVol:	0	0	0	0	0	0	0	0	0	0	0	0
Initial Fut:	15	5	25	59	3	36	16	543	24	18	316	27
User Adj:	1.00	1.00	1.00	1.00	1.00	1.00	1.00	1.00	1.00	1.00	1.00	1.00
PHF Adj:	1.00	1.00	1.00	1.00	1.00	1.00	1.00	1.00	1.00	1.00	1.00	1.00
PHF Volume:	15	5	25	59	3	36	16	543	24	18	316	27
Reduct Vol:	0	0	0	0	0	0	0	0	0	0	0	0
Reduced Vol:	15	5	25	59	3	36	16	543	24	18	316	27
PCE Adj:	1.00	1.00	1.00	1.00	1.00	1.00	1.00	1.00	1.00	1.00	1.00	1.00
MLF Adj:	1.00	1.00	1.00	1.00	1.00	1.00	1.00	1.00	1.00	1.00	1.00	1.00
FinalVolume:	15	5	25	59	3	36	16	543	24	18	316	27
Saturation Flow Module:												
Sat/Lane:	1900	1900	1900	1900	1900	1900	1900	1900	1900	1900	1900	1900
Adjustment:	0.92	0.95	0.95	0.92	0.95	0.95	0.92	1.00	0.92	0.92	1.00	0.92
Lanes:	1.00	0.17	0.83	1.00	0.08	0.92	1.00	1.00	1.00	1.00	1.00	1.00
Final Sat.:	1750	300	1500	1750	138	1662	1750	1900	1750	1750	1900	1750
Capacity Analysis Module:												
Vol/Sat:	0.01	0.02	0.02	0.03	0.02	0.02	0.01	0.29	0.01	0.01	0.17	0.02
Crit Moves:				****				****				****
Green Time:	10.0	10.0	10.0	10.0	10.0	10.0	18.3	40.0	40.0	7.0	28.7	28.7
Volume/Cap:	0.06	0.11	0.11	0.22	0.14	0.14	0.03	0.47	0.02	0.10	0.38	0.04
Delay/Veh:	24.1	24.3	24.3	25.0	24.5	24.5	17.4	7.5	5.2	26.9	12.9	10.7
User DelAdj:	1.00	1.00	1.00	1.00	1.00	1.00	1.00	1.00	1.00	1.00	1.00	1.00
AdjDel/Veh:	24.1	24.3	24.3	25.0	24.5	24.5	17.4	7.5	5.2	26.9	12.9	10.7
LOS by Move:	C	C	C	C	C	C	B	A	A	C	B	B
HCM2k95thQ:	1	1	1	3	2	2	1	11	0	1	8	1

Note: Queue reported is the number of cars per lane.

BART Phase II Extension Project

Level Of Service Computation Report
2000 HCM Operations (Future Volume Alternative)
AM - Existing Conditions

Intersection #3608: JULIAN/STOCKTON

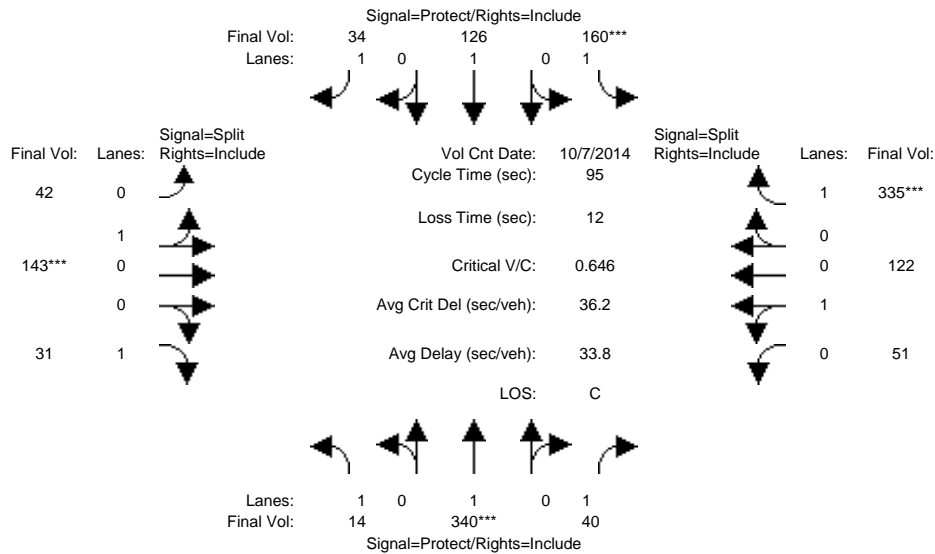

Approach:	North Bound			South Bound			East Bound			West Bound		
	L	T	R	L	T	R	L	T	R	L	T	R
Min. Green:	7	10	10	7	10	10	10	10	10	10	10	10
Y+R:	4.0	4.0	4.0	4.0	4.0	4.0	4.0	4.0	4.0	4.0	4.0	4.0

Volume Module: >> Count Date: 7 Oct 2014 <<

Base Vol:	14	340	40	160	126	34	42	143	31	51	122	335
Growth Adj:	1.00	1.00	1.00	1.00	1.00	1.00	1.00	1.00	1.00	1.00	1.00	1.00
Initial Bse:	14	340	40	160	126	34	42	143	31	51	122	335
Added Vol:	0	0	0	0	0	0	0	0	0	0	0	0
PasserByVol:	0	0	0	0	0	0	0	0	0	0	0	0
Initial Fut:	14	340	40	160	126	34	42	143	31	51	122	335
User Adj:	1.00	1.00	1.00	1.00	1.00	1.00	1.00	1.00	1.00	1.00	1.00	1.00
PHF Adj:	1.00	1.00	1.00	1.00	1.00	1.00	1.00	1.00	1.00	1.00	1.00	1.00
PHF Volume:	14	340	40	160	126	34	42	143	31	51	122	335
Reduct Vol:	0	0	0	0	0	0	0	0	0	0	0	0
Reduced Vol:	14	340	40	160	126	34	42	143	31	51	122	335
PCE Adj:	1.00	1.00	1.00	1.00	1.00	1.00	1.00	1.00	1.00	1.00	1.00	1.00
MLF Adj:	1.00	1.00	1.00	1.00	1.00	1.00	1.00	1.00	1.00	1.00	1.00	1.00
FinalVolume:	14	340	40	160	126	34	42	143	31	51	122	335

Saturation Flow Module:

Sat/Lane:	1900	1900	1900	1900	1900	1900	1900	1900	1900	1900	1900	1900
Adjustment:	0.92	1.00	0.92	0.92	1.00	0.92	0.95	0.95	0.92	0.95	0.95	0.92
Lanes:	1.00	1.00	1.00	1.00	1.00	1.00	0.23	0.77	1.00	0.29	0.71	1.00
Final Sat.:	1750	1900	1750	1750	1900	1750	409	1391	1750	531	1269	1750

Capacity Analysis Module:

Vol/Sat:	0.01	0.18	0.02	0.09	0.07	0.02	0.10	0.10	0.02	0.10	0.10	0.19
Crit Moves:	****	****	****	****	****	****	****	****	****	****	****	****
Green Time:	16.4	26.3	26.3	13.4	23.4	23.4	15.1	15.1	15.1	28.1	28.1	28.1
Volume/Cap:	0.05	0.65	0.08	0.65	0.27	0.08	0.65	0.65	0.11	0.32	0.32	0.65
Delay/Veh:	32.9	33.0	25.5	44.3	29.2	27.6	42.5	42.5	34.4	26.4	26.4	31.9
User DelAdj:	1.00	1.00	1.00	1.00	1.00	1.00	1.00	1.00	1.00	1.00	1.00	1.00
AdjDel/Veh:	32.9	33.0	25.5	44.3	29.2	27.6	42.5	42.5	34.4	26.4	26.4	31.9
LOS by Move:	C	C	C	D	C	C	D	D	C	C	C	C
HCM2k95thQ:	1	16	2	10	6	2	11	11	2	8	8	17

Note: Queue reported is the number of cars per lane.

BART Phase II Extension Project

Level Of Service Computation Report
2000 HCM Operations (Future Volume Alternative)
PM - Existing Conditions

Intersection #3608: JULIAN/STOCKTON

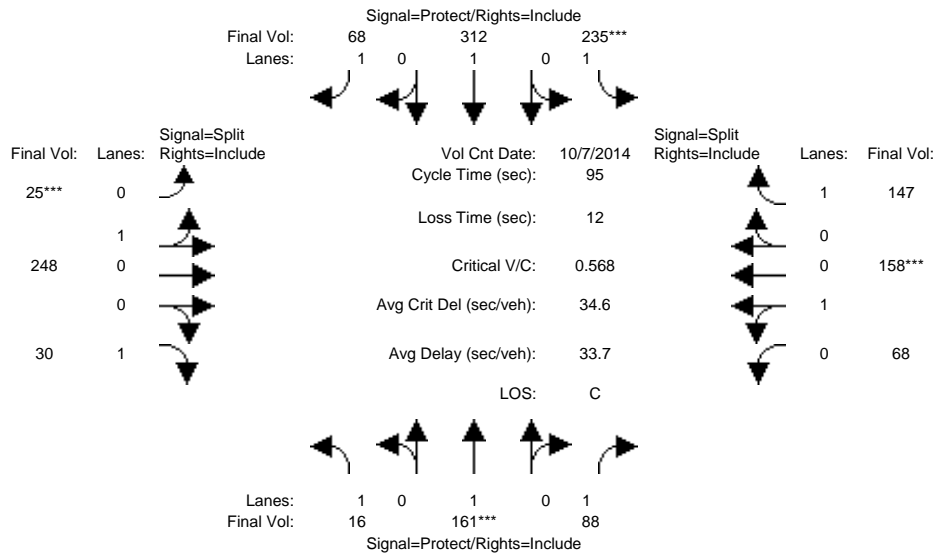

Approach:	North Bound			South Bound			East Bound			West Bound		
Movement:	L	T	R	L	T	R	L	T	R	L	T	R
Min. Green:	7	10	10	7	10	10	10	10	10	10	10	10
Y+R:	4.0	4.0	4.0	4.0	4.0	4.0	4.0	4.0	4.0	4.0	4.0	4.0
Volume Module: >> Count Date: 7 Oct 2014 <<												
Base Vol:	16	161	88	235	312	68	25	248	30	68	158	147
Growth Adj:	1.00	1.00	1.00	1.00	1.00	1.00	1.00	1.00	1.00	1.00	1.00	1.00
Initial Bse:	16	161	88	235	312	68	25	248	30	68	158	147
Added Vol:	0	0	0	0	0	0	0	0	0	0	0	0
PasserByVol:	0	0	0	0	0	0	0	0	0	0	0	0
Initial Fut:	16	161	88	235	312	68	25	248	30	68	158	147
User Adj:	1.00	1.00	1.00	1.00	1.00	1.00	1.00	1.00	1.00	1.00	1.00	1.00
PHF Adj:	1.00	1.00	1.00	1.00	1.00	1.00	1.00	1.00	1.00	1.00	1.00	1.00
PHF Volume:	16	161	88	235	312	68	25	248	30	68	158	147
Reduct Vol:	0	0	0	0	0	0	0	0	0	0	0	0
Reduced Vol:	16	161	88	235	312	68	25	248	30	68	158	147
PCE Adj:	1.00	1.00	1.00	1.00	1.00	1.00	1.00	1.00	1.00	1.00	1.00	1.00
MLF Adj:	1.00	1.00	1.00	1.00	1.00	1.00	1.00	1.00	1.00	1.00	1.00	1.00
FinalVolume:	16	161	88	235	312	68	25	248	30	68	158	147
Saturation Flow Module:												
Sat/Lane:	1900	1900	1900	1900	1900	1900	1900	1900	1900	1900	1900	1900
Adjustment:	0.92	1.00	0.92	0.92	1.00	0.92	0.95	0.95	0.92	0.95	0.95	0.92
Lanes:	1.00	1.00	1.00	1.00	1.00	1.00	0.09	0.91	1.00	0.30	0.70	1.00
Final Sat.:	1750	1900	1750	1750	1900	1750	165	1635	1750	542	1258	1750
Capacity Analysis Module:												
Vol/Sat:	0.01	0.08	0.05	0.13	0.16	0.04	0.15	0.15	0.02	0.13	0.13	0.08
Crit Moves:	****			****			****			****		
Green Time:	11.3	14.2	14.2	22.5	25.3	25.3	25.4	25.4	25.4	21.0	21.0	21.0
Volume/Cap:	0.08	0.57	0.34	0.57	0.62	0.15	0.57	0.57	0.06	0.57	0.57	0.38
Delay/Veh:	37.3	40.3	37.0	33.9	32.9	26.8	31.7	31.7	26.0	34.9	34.9	32.1
User DelAdj:	1.00	1.00	1.00	1.00	1.00	1.00	1.00	1.00	1.00	1.00	1.00	1.00
AdjDel/Veh:	37.3	40.3	37.0	33.9	32.9	26.8	31.7	31.7	26.0	34.9	34.9	32.1
LOS by Move:	D	D	D	C	C	C	C	C	C	C	C	C
HCM2k95thQ:	1	9	5	12	15	3	14	14	1	12	12	8

Note: Queue reported is the number of cars per lane.

BART Phase II Extension Project

Level Of Service Computation Report
2000 HCM Operations (Future Volume Alternative)
AM - Existing Conditions

Intersection #3651: LINCOLN/PARKMOOR

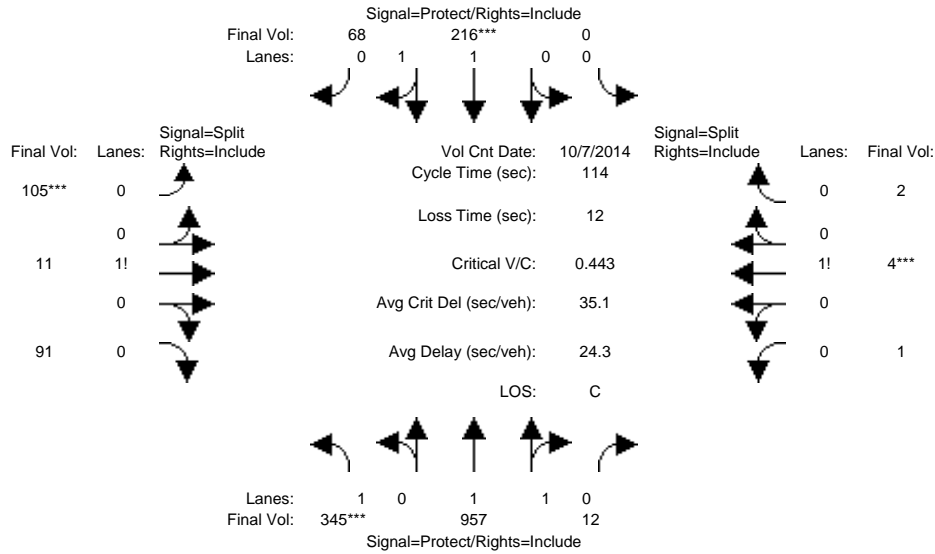

Approach:	North Bound			South Bound			East Bound			West Bound		
	L	T	R	L	T	R	L	T	R	L	T	R
Min. Green:	7	10	10	0	10	10	10	10	10	10	10	10
Y+R:	4.0	4.0	4.0	4.0	4.0	4.0	4.0	4.0	4.0	4.0	4.0	4.0

Volume Module: >> Count Date: 7 Oct 2014 <<

Base Vol:	345	957	12	0	216	68	105	11	91	1	4	2
Growth Adj:	1.00	1.00	1.00	1.00	1.00	1.00	1.00	1.00	1.00	1.00	1.00	1.00
Initial Bse:	345	957	12	0	216	68	105	11	91	1	4	2
Added Vol:	0	0	0	0	0	0	0	0	0	0	0	0
PasserByVol:	0	0	0	0	0	0	0	0	0	0	0	0
Initial Fut:	345	957	12	0	216	68	105	11	91	1	4	2
User Adj:	1.00	1.00	1.00	1.00	1.00	1.00	1.00	1.00	1.00	1.00	1.00	1.00
PHF Adj:	1.00	1.00	1.00	1.00	1.00	1.00	1.00	1.00	1.00	1.00	1.00	1.00
PHF Volume:	345	957	12	0	216	68	105	11	91	1	4	2
Reduct Vol:	0	0	0	0	0	0	0	0	0	0	0	0
Reduced Vol:	345	957	12	0	216	68	105	11	91	1	4	2
PCE Adj:	1.00	1.00	1.00	1.00	1.00	1.00	1.00	1.00	1.00	1.00	1.00	1.00
MLF Adj:	1.00	1.00	1.00	1.00	1.00	1.00	1.00	1.00	1.00	1.00	1.00	1.00
FinalVolume:	345	957	12	0	216	68	105	11	91	1	4	2

Saturation Flow Module:

Sat/Lane:	1900	1900	1900	1900	1900	1900	1900	1900	1900	1900	1900	1900
Adjustment:	0.92	0.97	0.95	0.92	0.98	0.95	0.92	0.92	0.92	0.92	0.92	0.92
Lanes:	1.00	1.97	0.03	0.00	1.51	0.49	0.51	0.05	0.44	0.14	0.57	0.29
Final Sat.:	1750	3654	46	0	2813	886	888	93	769	250	1000	500

Capacity Analysis Module:

Vol/Sat:	0.20	0.26	0.26	0.00	0.08	0.08	0.12	0.12	0.12	0.00	0.00	0.00
Crit Moves:	****				****		****				****	
Green Time:	46.2	64.3	64.3	0.0	18.0	18.0	27.7	27.7	27.7	10.0	10.0	10.0
Volume/Cap:	0.49	0.46	0.46	0.00	0.49	0.49	0.49	0.49	0.49	0.05	0.05	0.05
Delay/Veh:	25.6	14.9	14.9	0.0	44.4	44.4	37.9	37.9	37.9	47.8	47.8	47.8
User DelAdj:	1.00	1.00	1.00	1.00	1.00	1.00	1.00	1.00	1.00	1.00	1.00	1.00
AdjDel/Veh:	25.6	14.9	14.9	0.0	44.4	44.4	37.9	37.9	37.9	47.8	47.8	47.8
LOS by Move:	C	B	B	A	D	D	D	D	D	D	D	D
HCM2k95thQ:	17	18	18	0	9	9	13	13	13	1	1	1

Note: Queue reported is the number of cars per lane.

BART Phase II Extension Project

Level Of Service Computation Report
2000 HCM Operations (Future Volume Alternative)
PM - Existing Conditions

Intersection #3651: LINCOLN/PARKMOOR

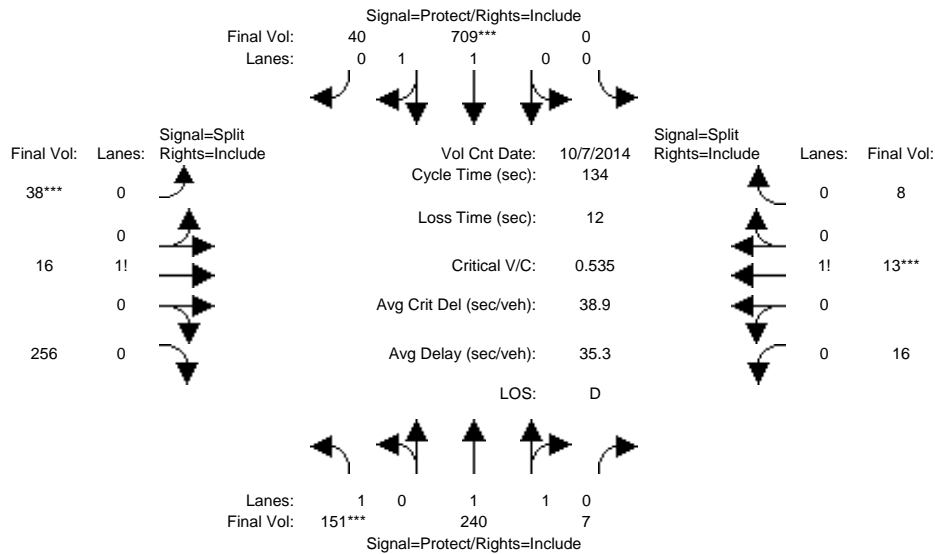

Approach:	North Bound			South Bound			East Bound			West Bound		
Movement:	L	T	R	L	T	R	L	T	R	L	T	R
Min. Green:	7	10	10	0	10	10	10	10	10	10	10	10
Y+R:	4.0	4.0	4.0	4.0	4.0	4.0	4.0	4.0	4.0	4.0	4.0	4.0
Volume Module: >> Count Date: 7 Oct 2014 <<												
Base Vol:	151	240	7	0	709	40	38	16	256	16	13	8
Growth Adj:	1.00	1.00	1.00	1.00	1.00	1.00	1.00	1.00	1.00	1.00	1.00	1.00
Initial Bse:	151	240	7	0	709	40	38	16	256	16	13	8
Added Vol:	0	0	0	0	0	0	0	0	0	0	0	0
PasserByVol:	0	0	0	0	0	0	0	0	0	0	0	0
Initial Fut:	151	240	7	0	709	40	38	16	256	16	13	8
User Adj:	1.00	1.00	1.00	1.00	1.00	1.00	1.00	1.00	1.00	1.00	1.00	1.00
PHF Adj:	1.00	1.00	1.00	1.00	1.00	1.00	1.00	1.00	1.00	1.00	1.00	1.00
PHF Volume:	151	240	7	0	709	40	38	16	256	16	13	8
Reduct Vol:	0	0	0	0	0	0	0	0	0	0	0	0
Reduced Vol:	151	240	7	0	709	40	38	16	256	16	13	8
PCE Adj:	1.00	1.00	1.00	1.00	1.00	1.00	1.00	1.00	1.00	1.00	1.00	1.00
MLF Adj:	1.00	1.00	1.00	1.00	1.00	1.00	1.00	1.00	1.00	1.00	1.00	1.00
FinalVolume:	151	240	7	0	709	40	38	16	256	16	13	8
Saturation Flow Module:												
Sat/Lane:	1900	1900	1900	1900	1900	1900	1900	1900	1900	1900	1900	1900
Adjustment:	0.92	0.97	0.95	0.92	0.98	0.95	0.92	0.92	0.92	0.92	0.92	0.92
Lanes:	1.00	1.94	0.06	0.00	1.89	0.11	0.12	0.05	0.83	0.43	0.35	0.22
Final Sat.:	1750	3595	105	0	3502	198	215	90	1445	757	615	378
Capacity Analysis Module:												
Vol/Sat:	0.09	0.07	0.07	0.00	0.20	0.20	0.18	0.18	0.18	0.02	0.02	0.02
Crit Moves:	****				****		****				****	
Green Time:	20.7	69.4	69.4	0.0	48.7	48.7	42.6	42.6	42.6	10.0	10.0	10.0
Volume/Cap:	0.56	0.13	0.13	0.00	0.56	0.56	0.56	0.56	0.56	0.28	0.28	0.28
Delay/Veh:	55.0	16.7	16.7	0.0	34.6	34.6	39.2	39.2	39.2	59.8	59.8	59.8
User DelAdj:	1.00	1.00	1.00	1.00	1.00	1.00	1.00	1.00	1.00	1.00	1.00	1.00
AdjDel/Veh:	55.0	16.7	16.7	0.0	34.6	34.6	39.2	39.2	39.2	59.8	59.8	59.8
LOS by Move:	D	B	B	A	C	C	D	D	D	E	E	E
HCM2k95thQ:	12	5	5	0	22	22	20	20	20	4	4	4

Note: Queue reported is the number of cars per lane.

BART Phase II Extension Project

Level Of Service Computation Report
 2000 HCM Operations (Future Volume Alternative)
 AM - Existing Conditions

Intersection #3653: LINCOLN/SAN CARLOS

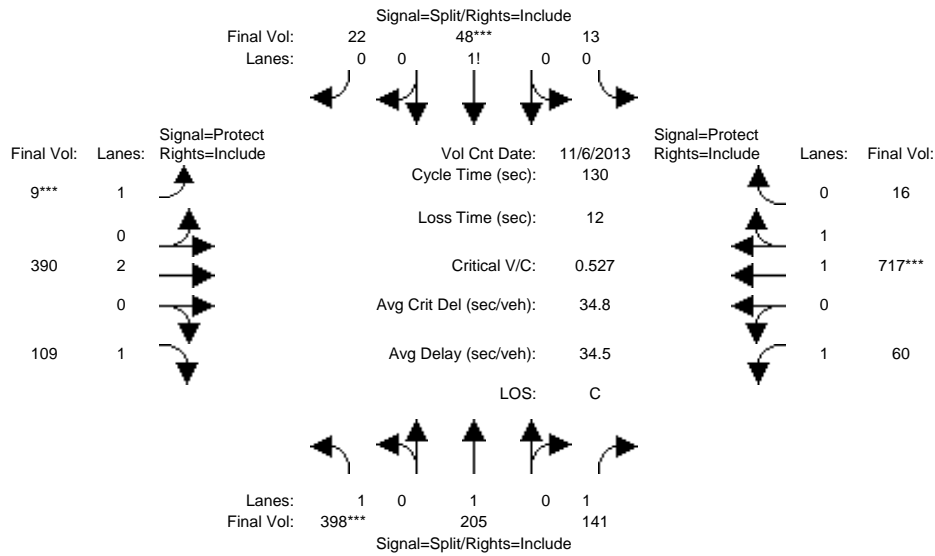

Approach:	North Bound			South Bound			East Bound			West Bound		
	L	T	R	L	T	R	L	T	R	L	T	R
Min. Green:	10	10	10	10	10	10	7	10	10	7	10	10
Y+R:	4.0	4.0	4.0	4.0	4.0	4.0	4.0	4.0	4.0	4.0	4.0	4.0

Volume Module:	>> Count Date: 6 Nov 2013 <<											
Base Vol:	398	205	141	13	48	22	9	390	109	60	717	16
Growth Adj:	1.00	1.00	1.00	1.00	1.00	1.00	1.00	1.00	1.00	1.00	1.00	1.00
Initial Bse:	398	205	141	13	48	22	9	390	109	60	717	16
Added Vol:	0	0	0	0	0	0	0	0	0	0	0	0
PasserByVol:	0	0	0	0	0	0	0	0	0	0	0	0
Initial Fut:	398	205	141	13	48	22	9	390	109	60	717	16
User Adj:	1.00	1.00	1.00	1.00	1.00	1.00	1.00	1.00	1.00	1.00	1.00	1.00
PHF Adj:	1.00	1.00	1.00	1.00	1.00	1.00	1.00	1.00	1.00	1.00	1.00	1.00
PHF Volume:	398	205	141	13	48	22	9	390	109	60	717	16
Reduct Vol:	0	0	0	0	0	0	0	0	0	0	0	0
Reduced Vol:	398	205	141	13	48	22	9	390	109	60	717	16
PCE Adj:	1.00	1.00	1.00	1.00	1.00	1.00	1.00	1.00	1.00	1.00	1.00	1.00
MLF Adj:	1.00	1.00	1.00	1.00	1.00	1.00	1.00	1.00	1.00	1.00	1.00	1.00
FinalVolume:	398	205	141	13	48	22	9	390	109	60	717	16

Saturation Flow Module:												
Sat/Lane:	1900	1900	1900	1900	1900	1900	1900	1900	1900	1900	1900	1900
Adjustment:	0.92	1.00	0.92	0.92	0.92	0.92	0.92	1.00	0.92	0.92	0.97	0.95
Lanes:	1.00	1.00	1.00	0.16	0.58	0.26	1.00	2.00	1.00	1.00	1.96	0.04
Final Sat.:	1750	1900	1750	274	1012	464	1750	3800	1750	1750	3619	81

Capacity Analysis Module:												
Vol/Sat:	0.23	0.11	0.08	0.05	0.05	0.05	0.01	0.10	0.06	0.03	0.20	0.20
Crit Moves:	****				****		****				****	
Green Time:	53.4	53.4	53.4	11.1	11.1	11.1	7.0	35.1	35.1	18.4	46.5	46.5
Volume/Cap:	0.55	0.26	0.20	0.55	0.55	0.55	0.10	0.38	0.23	0.24	0.55	0.55
Delay/Veh:	30.2	25.5	24.7	61.5	61.5	61.5	58.9	38.8	37.2	50.1	34.0	34.0
User DelAdj:	1.00	1.00	1.00	1.00	1.00	1.00	1.00	1.00	1.00	1.00	1.00	1.00
AdjDel/Veh:	30.2	25.5	24.7	61.5	61.5	61.5	58.9	38.8	37.2	50.1	34.0	34.0
LOS by Move:	C	C	C	E	E	E	E	D	D	D	C	C
HCM2k95thQ:	23	10	7	8	8	8	1	12	7	4	21	21

Note: Queue reported is the number of cars per lane.

BART Phase II Extension Project

Level Of Service Computation Report
2000 HCM Operations (Future Volume Alternative)
PM - Existing Conditions

Intersection #3653: LINCOLN/SAN CARLOS

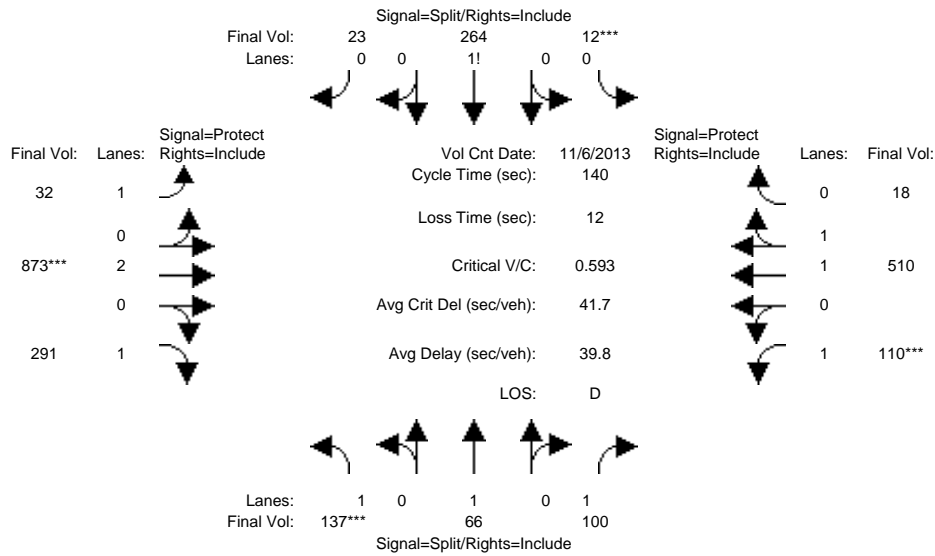

Approach:	North Bound			South Bound			East Bound			West Bound		
	L	T	R	L	T	R	L	T	R	L	T	R
Min. Green:	10	10	10	10	10	10	7	10	10	7	10	10
Y+R:	4.0	4.0	4.0	4.0	4.0	4.0	4.0	4.0	4.0	4.0	4.0	4.0

Volume Module: >> Count Date: 6 Nov 2013 <<

Base Vol:	137	66	100	12	264	23	32	873	291	110	510	18
Growth Adj:	1.00	1.00	1.00	1.00	1.00	1.00	1.00	1.00	1.00	1.00	1.00	1.00
Initial Bse:	137	66	100	12	264	23	32	873	291	110	510	18
Added Vol:	0	0	0	0	0	0	0	0	0	0	0	0
PasserByVol:	0	0	0	0	0	0	0	0	0	0	0	0
Initial Fut:	137	66	100	12	264	23	32	873	291	110	510	18
User Adj:	1.00	1.00	1.00	1.00	1.00	1.00	1.00	1.00	1.00	1.00	1.00	1.00
PHF Adj:	1.00	1.00	1.00	1.00	1.00	1.00	1.00	1.00	1.00	1.00	1.00	1.00
PHF Volume:	137	66	100	12	264	23	32	873	291	110	510	18
Reduct Vol:	0	0	0	0	0	0	0	0	0	0	0	0
Reduced Vol:	137	66	100	12	264	23	32	873	291	110	510	18
PCE Adj:	1.00	1.00	1.00	1.00	1.00	1.00	1.00	1.00	1.00	1.00	1.00	1.00
MLF Adj:	1.00	1.00	1.00	1.00	1.00	1.00	1.00	1.00	1.00	1.00	1.00	1.00
FinalVolume:	137	66	100	12	264	23	32	873	291	110	510	18

Saturation Flow Module:

Sat/Lane:	1900	1900	1900	1900	1900	1900	1900	1900	1900	1900	1900	1900
Adjustment:	0.92	1.00	0.92	0.92	0.92	0.92	0.92	1.00	0.92	0.92	0.97	0.95
Lanes:	1.00	1.00	1.00	0.04	0.88	0.08	1.00	2.00	1.00	1.00	1.93	0.07
Final Sat.:	1750	1900	1750	70	1545	135	1750	3800	1750	1750	3574	126

Capacity Analysis Module:

Vol/Sat:	0.08	0.03	0.06	0.17	0.17	0.17	0.02	0.23	0.17	0.06	0.14	0.14
Crit Moves:	****			****				****		****		
Green Time:	18.5	18.5	18.5	40.4	40.4	40.4	17.9	54.3	54.3	14.9	51.2	51.2
Volume/Cap:	0.59	0.26	0.43	0.59	0.59	0.59	0.14	0.59	0.43	0.59	0.39	0.39
Delay/Veh:	61.3	55.2	57.2	44.6	44.6	44.6	54.5	34.7	31.9	64.7	33.0	33.0
User DelAdj:	1.00	1.00	1.00	1.00	1.00	1.00	1.00	1.00	1.00	1.00	1.00	1.00
AdjDel/Veh:	61.3	55.2	57.2	44.6	44.6	44.6	54.5	34.7	31.9	64.7	33.0	33.0
LOS by Move:	E	E	E	D	D	D	D	C	C	E	C	C
HCM2k95thQ:	12	5	8	22	22	22	3	26	18	10	16	16

Note: Queue reported is the number of cars per lane.

BART Phase II Extension Project

Level Of Service Computation Report
2000 HCM Operations (Future Volume Alternative)
AM - Existing Conditions

Intersection #3690: MERIDIAN/PARKMOOR

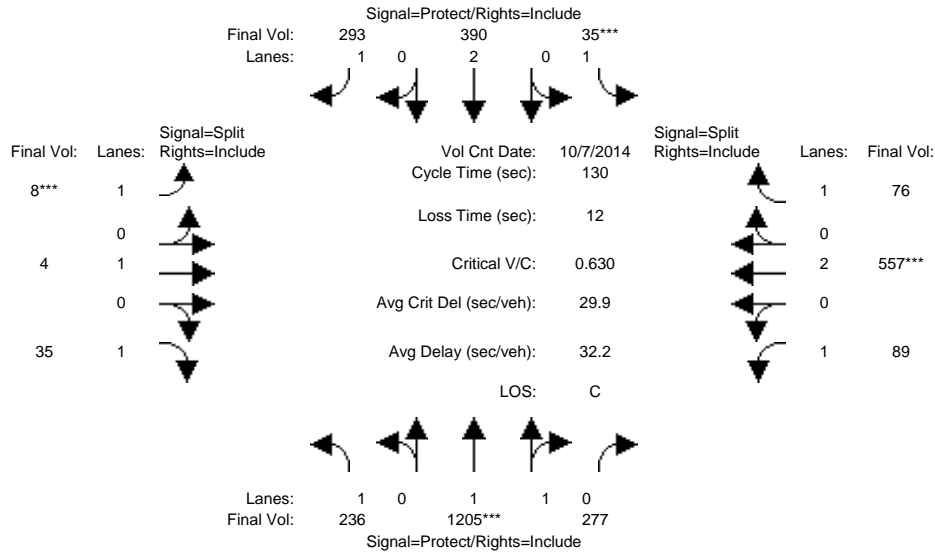

Approach:	North Bound			South Bound			East Bound			West Bound		
	L	T	R	L	T	R	L	T	R	L	T	R
Min. Green:	7	10	10	7	10	10	10	10	10	10	10	10
Y+R:	4.0	4.0	4.0	4.0	4.0	4.0	4.0	4.0	4.0	4.0	4.0	4.0
Volume Module: >> Count Date: 7 Oct 2014 <<												
Base Vol:	236	1205	277	35	390	293	8	4	35	89	557	76
Growth Adj:	1.00	1.00	1.00	1.00	1.00	1.00	1.00	1.00	1.00	1.00	1.00	1.00
Initial Bse:	236	1205	277	35	390	293	8	4	35	89	557	76
Added Vol:	0	0	0	0	0	0	0	0	0	0	0	0
PasserByVol:	0	0	0	0	0	0	0	0	0	0	0	0
Initial Fut:	236	1205	277	35	390	293	8	4	35	89	557	76
User Adj:	1.00	1.00	1.00	1.00	1.00	1.00	1.00	1.00	1.00	1.00	1.00	1.00
PHF Adj:	1.00	1.00	1.00	1.00	1.00	1.00	1.00	1.00	1.00	1.00	1.00	1.00
PHF Volume:	236	1205	277	35	390	293	8	4	35	89	557	76
Reduct Vol:	0	0	0	0	0	0	0	0	0	0	0	0
Reduced Vol:	236	1205	277	35	390	293	8	4	35	89	557	76
PCE Adj:	1.00	1.00	1.00	1.00	1.00	1.00	1.00	1.00	1.00	1.00	1.00	1.00
MLF Adj:	1.00	1.00	1.00	1.00	1.00	1.00	1.00	1.00	1.00	1.00	1.00	1.00
Final Volume:	236	1205	277	35	390	293	8	4	35	89	557	76
Saturation Flow Module:												
Sat/Lane:	1900	1900	1900	1900	1900	1900	1900	1900	1900	1900	1900	1900
Adjustment:	0.92	0.98	0.95	0.92	1.00	0.92	0.92	1.00	0.92	0.92	1.00	0.92
Lanes:	1.00	1.62	0.38	1.00	2.00	1.00	1.00	1.00	1.00	1.00	2.00	1.00
Final Sat.:	1750	3008	691	1750	3800	1750	1750	1900	1750	1750	3800	1750
Capacity Analysis Module:												
Vol/Sat:	0.13	0.40	0.40	0.02	0.10	0.17	0.00	0.00	0.02	0.05	0.15	0.04
Crit Moves:	****			****			****			****		
Green Time:	36.1	73.9	73.9	7.0	44.8	44.8	10.0	10.0	10.0	27.1	27.1	27.1
Volume/Cap:	0.49	0.70	0.70	0.37	0.30	0.49	0.06	0.03	0.26	0.24	0.70	0.21
Delay/Veh:	40.0	21.3	21.3	61.8	31.2	34.1	55.8	55.6	57.5	43.3	50.7	42.9
User DelAdj:	1.00	1.00	1.00	1.00	1.00	1.00	1.00	1.00	1.00	1.00	1.00	1.00
AdjDel/Veh:	40.0	21.3	21.3	61.8	31.2	34.1	55.8	55.6	57.5	43.3	50.7	42.9
LOS by Move:	D	C	C	E	C	C	E	E	E	D	D	D
HCM2k95thQ:	16	37	37	3	11	18	1	0	3	6	19	5

Note: Queue reported is the number of cars per lane.

BART Phase II Extension Project

Level Of Service Computation Report
2000 HCM Operations (Future Volume Alternative)
PM - Existing Conditions

Intersection #3690: MERIDIAN/PARKMOOR

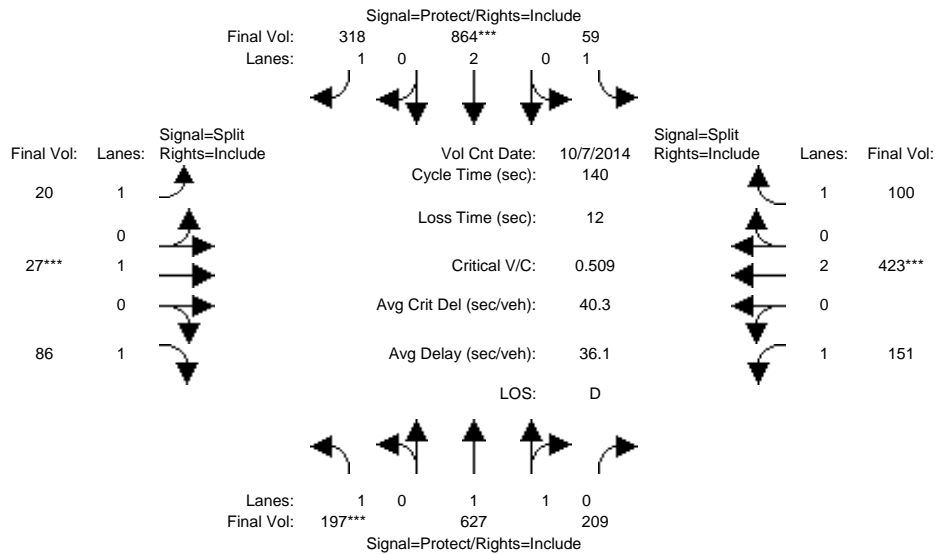

Approach:	North Bound			South Bound			East Bound			West Bound		
	L	T	R	L	T	R	L	T	R	L	T	R
Min. Green:	7	10	10	7	10	10	10	10	10	10	10	10
Y+R:	4.0	4.0	4.0	4.0	4.0	4.0	4.0	4.0	4.0	4.0	4.0	4.0
Volume Module: >> Count Date: 7 Oct 2014 <<												
Base Vol:	197	627	209	59	864	318	20	27	86	151	423	100
Growth Adj:	1.00	1.00	1.00	1.00	1.00	1.00	1.00	1.00	1.00	1.00	1.00	1.00
Initial Bse:	197	627	209	59	864	318	20	27	86	151	423	100
Added Vol:	0	0	0	0	0	0	0	0	0	0	0	0
PasserByVol:	0	0	0	0	0	0	0	0	0	0	0	0
Initial Fut:	197	627	209	59	864	318	20	27	86	151	423	100
User Adj:	1.00	1.00	1.00	1.00	1.00	1.00	1.00	1.00	1.00	1.00	1.00	1.00
PHF Adj:	1.00	1.00	1.00	1.00	1.00	1.00	1.00	1.00	1.00	1.00	1.00	1.00
PHF Volume:	197	627	209	59	864	318	20	27	86	151	423	100
Reduct Vol:	0	0	0	0	0	0	0	0	0	0	0	0
Reduced Vol:	197	627	209	59	864	318	20	27	86	151	423	100
PCE Adj:	1.00	1.00	1.00	1.00	1.00	1.00	1.00	1.00	1.00	1.00	1.00	1.00
MLF Adj:	1.00	1.00	1.00	1.00	1.00	1.00	1.00	1.00	1.00	1.00	1.00	1.00
FinalVolume:	197	627	209	59	864	318	20	27	86	151	423	100
Saturation Flow Module:												
Sat/Lane:	1900	1900	1900	1900	1900	1900	1900	1900	1900	1900	1900	1900
Adjustment:	0.92	0.98	0.95	0.92	1.00	0.92	0.92	1.00	0.92	0.92	1.00	0.92
Lanes:	1.00	1.49	0.51	1.00	2.00	1.00	1.00	1.00	1.00	1.00	2.00	1.00
Final Sat.:	1750	2774	925	1750	3800	1750	1750	1900	1750	1750	3800	1750
Capacity Analysis Module:												
Vol/Sat:	0.11	0.23	0.23	0.03	0.23	0.18	0.01	0.01	0.05	0.09	0.11	0.06
Crit Moves:	****				****			****			****	
Green Time:	28.6	70.6	70.6	15.6	57.7	57.7	13.5	13.5	13.5	28.2	28.2	28.2
Volume/Cap:	0.55	0.45	0.45	0.30	0.55	0.44	0.12	0.15	0.51	0.43	0.55	0.28
Delay/Veh:	51.8	22.4	22.4	58.1	31.7	30.0	58.1	58.3	62.7	49.7	51.1	47.8
User DelAdj:	1.00	1.00	1.00	1.00	1.00	1.00	1.00	1.00	1.00	1.00	1.00	1.00
AdjDel/Veh:	51.8	22.4	22.4	58.1	31.7	30.0	58.1	58.3	62.7	49.7	51.1	47.8
LOS by Move:	D	C	C	E	C	C	E	E	E	D	D	D
HCM2k95thQ:	16	21	21	5	24	19	2	2	8	11	15	7

Note: Queue reported is the number of cars per lane.

BART Phase II Extension Project

Level Of Service Computation Report
 2000 HCM Operations (Future Volume Alternative)
 AM - Existing Conditions

Intersection #3693: MERIDIAN/SAN CARLOS

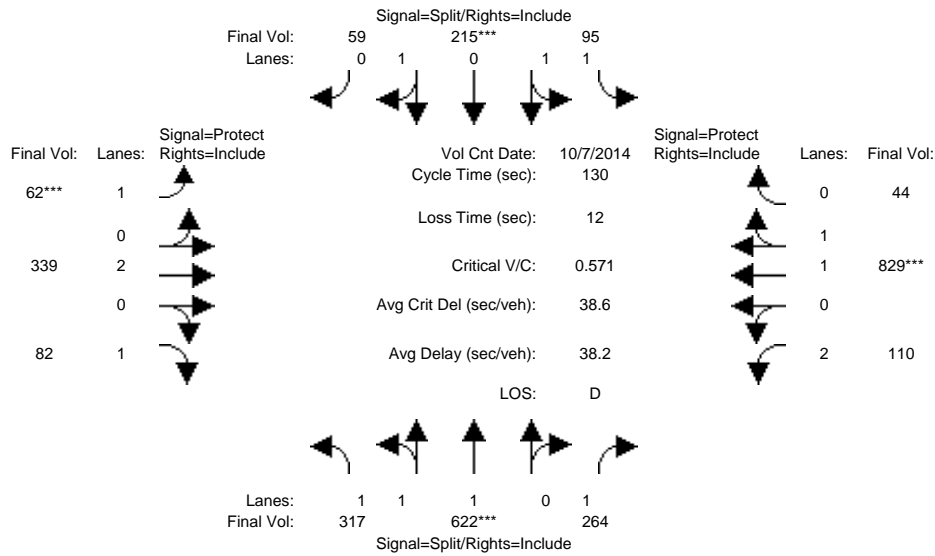

Approach:	North Bound			South Bound			East Bound			West Bound		
Movement:	L	T	R	L	T	R	L	T	R	L	T	R
Min. Green:	10	10	10	10	10	10	7	10	10	7	10	10
Y+R:	4.0	4.0	4.0	4.0	4.0	4.0	4.0	4.0	4.0	4.0	4.0	4.0
Volume Module: >> Count Date: 7 Oct 2014 <<												
Base Vol:	317	622	264	95	215	59	62	339	82	110	829	44
Growth Adj:	1.00	1.00	1.00	1.00	1.00	1.00	1.00	1.00	1.00	1.00	1.00	1.00
Initial Bse:	317	622	264	95	215	59	62	339	82	110	829	44
Added Vol:	0	0	0	0	0	0	0	0	0	0	0	0
PasserByVol:	0	0	0	0	0	0	0	0	0	0	0	0
Initial Fut:	317	622	264	95	215	59	62	339	82	110	829	44
User Adj:	1.00	1.00	1.00	1.00	1.00	1.00	1.00	1.00	1.00	1.00	1.00	1.00
PHF Adj:	1.00	1.00	1.00	1.00	1.00	1.00	1.00	1.00	1.00	1.00	1.00	1.00
PHF Volume:	317	622	264	95	215	59	62	339	82	110	829	44
Reduct Vol:	0	0	0	0	0	0	0	0	0	0	0	0
Reduced Vol:	317	622	264	95	215	59	62	339	82	110	829	44
PCE Adj:	1.00	1.00	1.00	1.00	1.00	1.00	1.00	1.00	1.00	1.00	1.00	1.00
MLF Adj:	1.00	1.00	1.00	1.00	1.00	1.00	1.00	1.00	1.00	1.00	1.00	1.00
FinalVolume:	317	622	264	95	215	59	62	339	82	110	829	44
Saturation Flow Module:												
Sat/Lane:	1900	1900	1900	1900	1900	1900	1900	1900	1900	1900	1900	1900
Adjustment:	0.92	0.97	0.92	0.92	0.98	0.95	0.92	1.00	0.92	0.83	0.98	0.95
Lanes:	1.05	1.95	1.00	1.00	1.56	0.44	1.00	2.00	1.00	2.00	1.90	0.10
Final Sat.:	1839	3608	1750	1750	2903	797	1750	3800	1750	3150	3513	186
Capacity Analysis Module:												
Vol/Sat:	0.17	0.17	0.15	0.05	0.07	0.07	0.04	0.09	0.05	0.03	0.24	0.24
Crit Moves:	****			****			****			****		
Green Time:	39.3	39.3	39.3	16.9	16.9	16.9	8.1	38.6	38.6	23.3	53.8	53.8
Volume/Cap:	0.57	0.57	0.50	0.42	0.57	0.57	0.57	0.30	0.16	0.20	0.57	0.57
Delay/Veh:	38.7	38.7	38.0	52.4	54.4	54.4	66.3	35.5	33.9	45.6	29.8	29.8
User DelAdj:	1.00	1.00	1.00	1.00	1.00	1.00	1.00	1.00	1.00	1.00	1.00	1.00
AdjDel/Veh:	38.7	38.7	38.0	52.4	54.4	54.4	66.3	35.5	33.9	45.6	29.8	29.8
LOS by Move:	D	D	D	D	D	D	E	D	C	D	C	C
HCM2k95thQ:	20	20	17	7	10	10	5	10	5	4	24	24

Note: Queue reported is the number of cars per lane.

BART Phase II Extension Project

Level Of Service Computation Report
 2000 HCM Operations (Future Volume Alternative)
 PM - Existing Conditions

Intersection #3693: MERIDIAN/SAN CARLOS

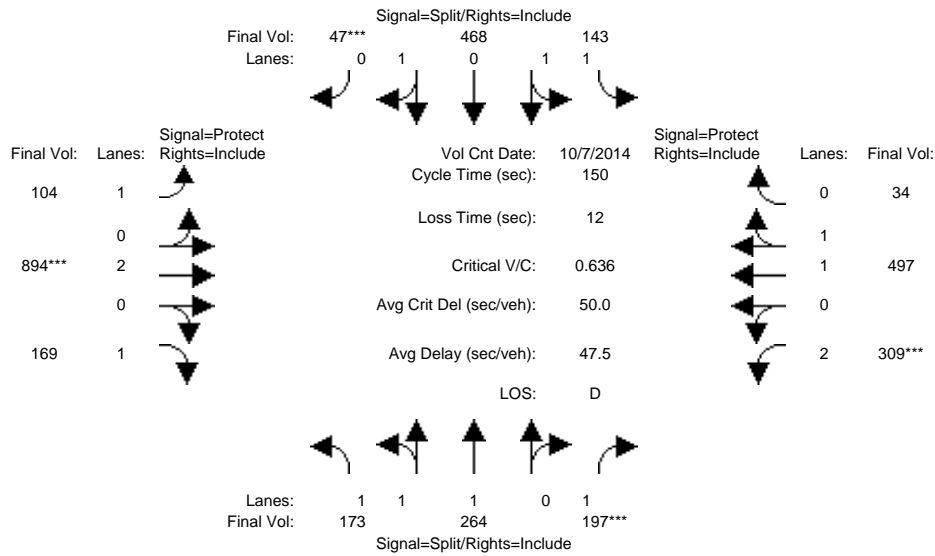

Approach:	North Bound			South Bound			East Bound			West Bound		
Movement:	L	T	R	L	T	R	L	T	R	L	T	R
Min. Green:	10	10	10	10	10	10	7	10	10	7	10	10
Y+R:	4.0	4.0	4.0	4.0	4.0	4.0	4.0	4.0	4.0	4.0	4.0	4.0
Volume Module: >> Count Date: 7 Oct 2014 <<												
Base Vol:	173	264	197	143	468	47	104	894	169	309	497	34
Growth Adj:	1.00	1.00	1.00	1.00	1.00	1.00	1.00	1.00	1.00	1.00	1.00	1.00
Initial Bse:	173	264	197	143	468	47	104	894	169	309	497	34
Added Vol:	0	0	0	0	0	0	0	0	0	0	0	0
PasserByVol:	0	0	0	0	0	0	0	0	0	0	0	0
Initial Fut:	173	264	197	143	468	47	104	894	169	309	497	34
User Adj:	1.00	1.00	1.00	1.00	1.00	1.00	1.00	1.00	1.00	1.00	1.00	1.00
PHF Adj:	1.00	1.00	1.00	1.00	1.00	1.00	1.00	1.00	1.00	1.00	1.00	1.00
PHF Volume:	173	264	197	143	468	47	104	894	169	309	497	34
Reduct Vol:	0	0	0	0	0	0	0	0	0	0	0	0
Reduced Vol:	173	264	197	143	468	47	104	894	169	309	497	34
PCE Adj:	1.00	1.00	1.00	1.00	1.00	1.00	1.00	1.00	1.00	1.00	1.00	1.00
MLF Adj:	1.00	1.00	1.00	1.00	1.00	1.00	1.00	1.00	1.00	1.00	1.00	1.00
FinalVolume:	173	264	197	143	468	47	104	894	169	309	497	34
Saturation Flow Module:												
Sat/Lane:	1900	1900	1900	1900	1900	1900	1900	1900	1900	1900	1900	1900
Adjustment:	0.93	0.98	0.92	0.92	0.98	0.95	0.92	1.00	0.92	0.83	0.98	0.95
Lanes:	1.23	1.77	1.00	1.00	1.81	0.19	1.00	2.00	1.00	2.00	1.87	0.13
Final Sat.:	2156	3290	1750	1750	3362	338	1750	3800	1750	3150	3463	237
Capacity Analysis Module:												
Vol/Sat:	0.08	0.08	0.11	0.08	0.14	0.14	0.06	0.24	0.10	0.10	0.14	0.14
Crit Moves:			****			****		****			****	
Green Time:	26.5	26.5	26.5	32.8	32.8	32.8	23.0	55.5	55.5	23.1	55.6	55.6
Volume/Cap:	0.45	0.45	0.64	0.37	0.64	0.64	0.39	0.64	0.26	0.64	0.39	0.39
Delay/Veh:	55.6	55.6	61.6	50.0	54.5	54.5	58.1	39.9	33.2	62.3	34.9	34.9
User DelAdj:	1.00	1.00	1.00	1.00	1.00	1.00	1.00	1.00	1.00	1.00	1.00	1.00
AdjDel/Veh:	55.6	55.6	61.6	50.0	54.5	54.5	58.1	39.9	33.2	62.3	34.9	34.9
LOS by Move:	E	E	E	D	D	D	E	D	C	E	C	C
HCM2k95thQ:	12	12	17	11	20	20	9	29	11	15	16	16

Note: Queue reported is the number of cars per lane.

BART Phase II Extension Project

Level Of Service Computation Report
2000 HCM Operations (Future Volume Alternative)
AM - Existing Conditions

Intersection #3709: MONTGOMERY/PARK

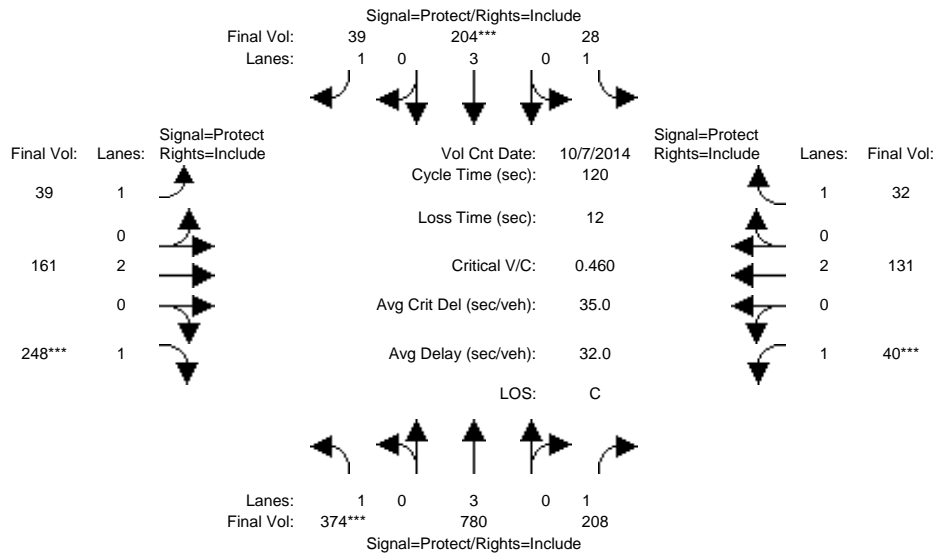

Approach:	North Bound			South Bound			East Bound			West Bound		
Movement:	L	T	R	L	T	R	L	T	R	L	T	R
Min. Green:	7	10	10	7	10	10	7	10	10	7	10	10
Y+R:	4.0	4.0	4.0	4.0	4.0	4.0	4.0	4.0	4.0	4.0	4.0	4.0
Volume Module: >> Count Date: 7 Oct 2014 <<												
Base Vol:	374	780	208	28	204	39	39	161	248	40	131	32
Growth Adj:	1.00	1.00	1.00	1.00	1.00	1.00	1.00	1.00	1.00	1.00	1.00	1.00
Initial Bse:	374	780	208	28	204	39	39	161	248	40	131	32
Added Vol:	0	0	0	0	0	0	0	0	0	0	0	0
PasserByVol:	0	0	0	0	0	0	0	0	0	0	0	0
Initial Fut:	374	780	208	28	204	39	39	161	248	40	131	32
User Adj:	1.00	1.00	1.00	1.00	1.00	1.00	1.00	1.00	1.00	1.00	1.00	1.00
PHF Adj:	1.00	1.00	1.00	1.00	1.00	1.00	1.00	1.00	1.00	1.00	1.00	1.00
PHF Volume:	374	780	208	28	204	39	39	161	248	40	131	32
Reduct Vol:	0	0	0	0	0	0	0	0	0	0	0	0
Reduced Vol:	374	780	208	28	204	39	39	161	248	40	131	32
PCE Adj:	1.00	1.00	1.00	1.00	1.00	1.00	1.00	1.00	1.00	1.00	1.00	1.00
MLF Adj:	1.00	1.00	1.00	1.00	1.00	1.00	1.00	1.00	1.00	1.00	1.00	1.00
FinalVolume:	374	780	208	28	204	39	39	161	248	40	131	32
Saturation Flow Module:												
Sat/Lane:	1900	1900	1900	1900	1900	1900	1900	1900	1900	1900	1900	1900
Adjustment:	0.92	1.00	0.92	0.92	1.00	0.92	0.92	1.00	0.92	0.92	1.00	0.92
Lanes:	1.00	3.00	1.00	1.00	3.00	1.00	1.00	2.00	1.00	1.00	2.00	1.00
Final Sat.:	1750	5700	1750	1750	5700	1750	1750	3800	1750	1750	3800	1750
Capacity Analysis Module:												
Vol/Sat:	0.21	0.14	0.12	0.02	0.04	0.02	0.02	0.04	0.14	0.02	0.03	0.02
Crit Moves:	****				****				****	****		
Green Time:	54.7	45.4	45.4	19.3	10.0	10.0	17.8	36.3	36.3	7.0	25.5	25.5
Volume/Cap:	0.47	0.36	0.31	0.10	0.43	0.27	0.15	0.14	0.47	0.39	0.16	0.09
Delay/Veh:	23.0	27.0	26.6	43.1	52.9	52.6	44.8	30.6	34.7	56.9	38.7	38.0
User DelAdj:	1.00	1.00	1.00	1.00	1.00	1.00	1.00	1.00	1.00	1.00	1.00	1.00
AdjDel/Veh:	23.0	27.0	26.6	43.1	52.9	52.6	44.8	30.6	34.7	56.9	38.7	38.0
LOS by Move:	C	C	C	D	D	D	D	C	C	E	D	D
HCM2k95thQ:	18	13	11	2	6	3	3	4	15	3	4	2

Note: Queue reported is the number of cars per lane.

BART Phase II Extension Project

Level Of Service Computation Report
2000 HCM Operations (Future Volume Alternative)
PM - Existing Conditions

Intersection #3709: MONTGOMERY/PARK

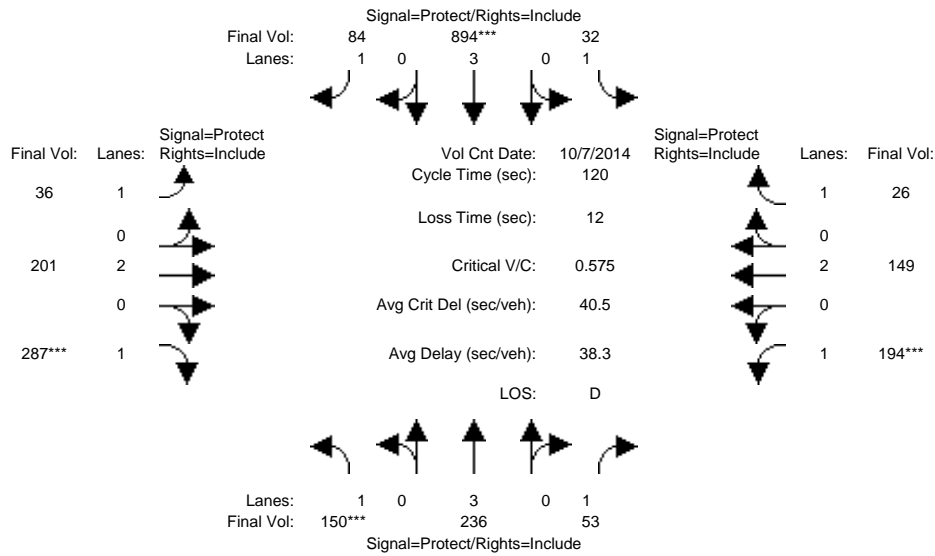

Approach:	North Bound			South Bound			East Bound			West Bound		
	L	T	R	L	T	R	L	T	R	L	T	R
Min. Green:	7	10	10	7	10	10	7	10	10	7	10	10
Y+R:	4.0	4.0	4.0	4.0	4.0	4.0	4.0	4.0	4.0	4.0	4.0	4.0

Volume Module:	>> Count Date: 7 Oct 2014 <<											
Base Vol:	150	236	53	32	894	84	36	201	287	194	149	26
Growth Adj:	1.00	1.00	1.00	1.00	1.00	1.00	1.00	1.00	1.00	1.00	1.00	1.00
Initial Bse:	150	236	53	32	894	84	36	201	287	194	149	26
Added Vol:	0	0	0	0	0	0	0	0	0	0	0	0
PasserByVol:	0	0	0	0	0	0	0	0	0	0	0	0
Initial Fut:	150	236	53	32	894	84	36	201	287	194	149	26
User Adj:	1.00	1.00	1.00	1.00	1.00	1.00	1.00	1.00	1.00	1.00	1.00	1.00
PHF Adj:	1.00	1.00	1.00	1.00	1.00	1.00	1.00	1.00	1.00	1.00	1.00	1.00
PHF Volume:	150	236	53	32	894	84	36	201	287	194	149	26
Reduct Vol:	0	0	0	0	0	0	0	0	0	0	0	0
Reduced Vol:	150	236	53	32	894	84	36	201	287	194	149	26
PCE Adj:	1.00	1.00	1.00	1.00	1.00	1.00	1.00	1.00	1.00	1.00	1.00	1.00
MLF Adj:	1.00	1.00	1.00	1.00	1.00	1.00	1.00	1.00	1.00	1.00	1.00	1.00
FinalVolume:	150	236	53	32	894	84	36	201	287	194	149	26

Saturation Flow Module:												
Sat/Lane:	1900	1900	1900	1900	1900	1900	1900	1900	1900	1900	1900	1900
Adjustment:	0.92	1.00	0.92	0.92	1.00	0.92	0.92	1.00	0.92	0.92	1.00	0.92
Lanes:	1.00	3.00	1.00	1.00	3.00	1.00	1.00	2.00	1.00	1.00	2.00	1.00
Final Sat.:	1750	5700	1750	1750	5700	1750	1750	3800	1750	1750	3800	1750

Capacity Analysis Module:												
Vol/Sat:	0.09	0.04	0.03	0.02	0.16	0.05	0.02	0.05	0.16	0.11	0.04	0.01
Crit Moves:	****				****				****	****		
Green Time:	17.9	29.8	29.8	20.8	32.7	32.7	23.6	34.2	34.2	23.1	33.7	33.7
Volume/Cap:	0.57	0.17	0.12	0.11	0.57	0.18	0.10	0.19	0.57	0.57	0.14	0.05
Delay/Veh:	50.6	35.4	35.1	41.9	38.2	33.5	39.6	32.4	38.3	46.4	32.3	31.5
User DelAdj:	1.00	1.00	1.00	1.00	1.00	1.00	1.00	1.00	1.00	1.00	1.00	1.00
AdjDel/Veh:	50.6	35.4	35.1	41.9	38.2	33.5	39.6	32.4	38.3	46.4	32.3	31.5
LOS by Move:	D	D	D	D	D	C	D	C	D	D	C	C
HCM2k95thQ:	11	4	3	2	18	5	2	5	18	13	4	1

Note: Queue reported is the number of cars per lane.

BART Phase II Extension Project

Level Of Service Computation Report
2000 HCM Operations (Future Volume Alternative)
AM - Existing Conditions

Intersection #3710: MONTGOMERY/SAN FERNANDO

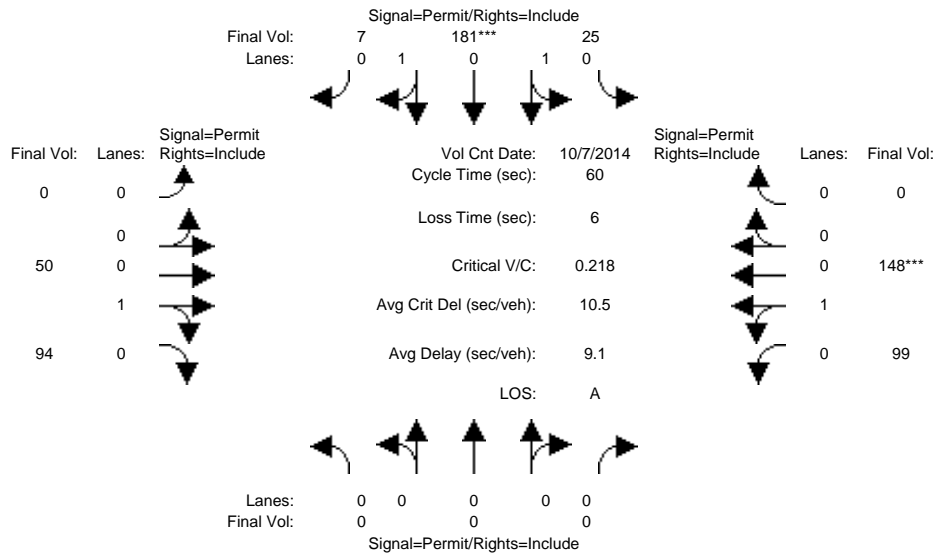

Approach:	North Bound			South Bound			East Bound			West Bound		
	L	T	R	L	T	R	L	T	R	L	T	R
Min. Green:	0	0	0	10	10	10	0	10	10	10	10	0
Y+R:	4.0	4.0	4.0	4.0	4.0	4.0	4.0	4.0	4.0	4.0	4.0	4.0
Volume Module: >> Count Date: 7 Oct 2014 <<												
Base Vol:	0	0	0	25	181	7	0	50	94	99	148	0
Growth Adj:	1.00	1.00	1.00	1.00	1.00	1.00	1.00	1.00	1.00	1.00	1.00	1.00
Initial Bse:	0	0	0	25	181	7	0	50	94	99	148	0
Added Vol:	0	0	0	0	0	0	0	0	0	0	0	0
PasserByVol:	0	0	0	0	0	0	0	0	0	0	0	0
Initial Fut:	0	0	0	25	181	7	0	50	94	99	148	0
User Adj:	1.00	1.00	1.00	1.00	1.00	1.00	1.00	1.00	1.00	1.00	1.00	1.00
PHF Adj:	1.00	1.00	1.00	1.00	1.00	1.00	1.00	1.00	1.00	1.00	1.00	1.00
PHF Volume:	0	0	0	25	181	7	0	50	94	99	148	0
Reduct Vol:	0	0	0	0	0	0	0	0	0	0	0	0
Reduced Vol:	0	0	0	25	181	7	0	50	94	99	148	0
PCE Adj:	1.00	1.00	1.00	1.00	1.00	1.00	1.00	1.00	1.00	1.00	1.00	1.00
MLF Adj:	1.00	1.00	1.00	1.00	1.00	1.00	1.00	1.00	1.00	1.00	1.00	1.00
Final Volume:	0	0	0	25	181	7	0	50	94	99	148	0
Saturation Flow Module:												
Sat/Lane:	1900	1900	1900	1900	1900	1900	1900	1900	1900	1900	1900	1900
Adjustment:	0.92	1.00	0.92	0.95	0.95	0.95	0.92	0.95	0.95	0.95	0.95	0.92
Lanes:	0.00	0.00	0.00	0.23	1.70	0.07	0.00	0.35	0.65	0.40	0.60	0.00
Final Sat.:	0	0	0	423	3059	118	0	625	1175	721	1079	0
Capacity Analysis Module:												
Vol/Sat:	0.00	0.00	0.00	0.06	0.06	0.06	0.00	0.08	0.08	0.14	0.14	0.00
Crit Moves:	*****											
Green Time:	0.0	0.0	0.0	16.3	16.3	16.3	0.0	37.7	37.7	37.7	37.7	0.0
Volume/Cap:	0.00	0.00	0.00	0.22	0.22	0.22	0.00	0.13	0.13	0.22	0.22	0.00
Delay/Veh:	0.0	0.0	0.0	17.1	17.1	17.1	0.0	4.5	4.5	4.9	4.9	0.0
User DelAdj:	1.00	1.00	1.00	1.00	1.00	1.00	1.00	1.00	1.00	1.00	1.00	1.00
AdjDel/Veh:	0.0	0.0	0.0	17.1	17.1	17.1	0.0	4.5	4.5	4.9	4.9	0.0
LOS by Move:	A	A	A	B	B	B	A	A	A	A	A	A
HCM2k95thQ:	0	0	0	3	3	3	0	2	2	4	4	0

Note: Queue reported is the number of cars per lane.

BART Phase II Extension Project

Level Of Service Computation Report
2000 HCM Operations (Future Volume Alternative)
PM - Existing Conditions

Intersection #3710: MONTGOMERY/SAN FERNANDO

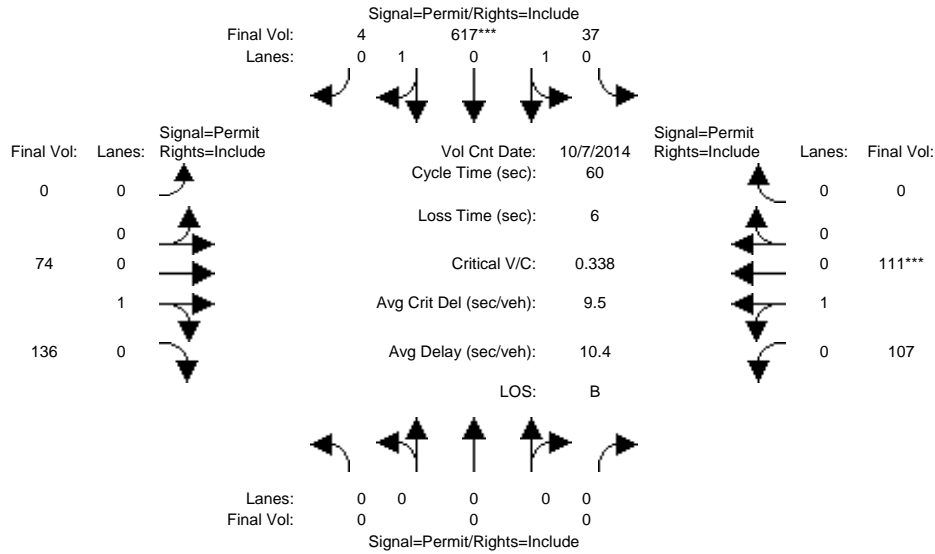

Approach:	North Bound			South Bound			East Bound			West Bound		
	L	T	R	L	T	R	L	T	R	L	T	R
Min. Green:	0	0	0	10	10	10	0	10	10	10	10	0
Y+R:	4.0	4.0	4.0	4.0	4.0	4.0	4.0	4.0	4.0	4.0	4.0	4.0
Volume Module: >> Count Date: 7 Oct 2014 <<												
Base Vol:	0	0	0	37	617	4	0	74	136	107	111	0
Growth Adj:	1.00	1.00	1.00	1.00	1.00	1.00	1.00	1.00	1.00	1.00	1.00	1.00
Initial Bse:	0	0	0	37	617	4	0	74	136	107	111	0
Added Vol:	0	0	0	0	0	0	0	0	0	0	0	0
PasserByVol:	0	0	0	0	0	0	0	0	0	0	0	0
Initial Fut:	0	0	0	37	617	4	0	74	136	107	111	0
User Adj:	1.00	1.00	1.00	1.00	1.00	1.00	1.00	1.00	1.00	1.00	1.00	1.00
PHF Adj:	1.00	1.00	1.00	1.00	1.00	1.00	1.00	1.00	1.00	1.00	1.00	1.00
PHF Volume:	0	0	0	37	617	4	0	74	136	107	111	0
Reduct Vol:	0	0	0	0	0	0	0	0	0	0	0	0
Reduced Vol:	0	0	0	37	617	4	0	74	136	107	111	0
PCE Adj:	1.00	1.00	1.00	1.00	1.00	1.00	1.00	1.00	1.00	1.00	1.00	1.00
MLF Adj:	1.00	1.00	1.00	1.00	1.00	1.00	1.00	1.00	1.00	1.00	1.00	1.00
FinalVolume:	0	0	0	37	617	4	0	74	136	107	111	0
Saturation Flow Module:												
Sat/Lane:	1900	1900	1900	1900	1900	1900	1900	1900	1900	1900	1900	1900
Adjustment:	0.92	1.00	0.92	0.95	0.95	0.95	0.92	0.95	0.95	0.95	0.95	0.92
Lanes:	0.00	0.00	0.00	0.11	1.88	0.01	0.00	0.35	0.65	0.49	0.51	0.00
Final Sat.:	0	0	0	202	3376	22	0	634	1166	883	917	0
Capacity Analysis Module:												
Vol/Sat:	0.00	0.00	0.00	0.18	0.18	0.18	0.00	0.12	0.12	0.12	0.12	0.00
Crit Moves:	*****											
Green Time:	0.0	0.0	0.0	32.5	32.5	32.5	0.0	21.5	21.5	21.5	21.5	0.0
Volume/Cap:	0.00	0.00	0.00	0.34	0.34	0.34	0.00	0.33	0.33	0.34	0.34	0.00
Delay/Veh:	0.0	0.0	0.0	7.8	7.8	7.8	0.0	14.3	14.3	14.4	14.4	0.0
User DelAdj:	1.00	1.00	1.00	1.00	1.00	1.00	1.00	1.00	1.00	1.00	1.00	1.00
AdjDel/Veh:	0.0	0.0	0.0	7.8	7.8	7.8	0.0	14.3	14.3	14.4	14.4	0.0
LOS by Move:	A	A	A	A	A	A	A	B	B	B	B	A
HCM2k95thQ:	0	0	0	7	7	7	0	6	6	6	6	0

Note: Queue reported is the number of cars per lane.

BART Phase II Extension Project

Level Of Service Computation Report
2000 HCM Operations (Future Volume Alternative)
AM - Existing Conditions

Intersection #3748: RACE/SAN CARLOS

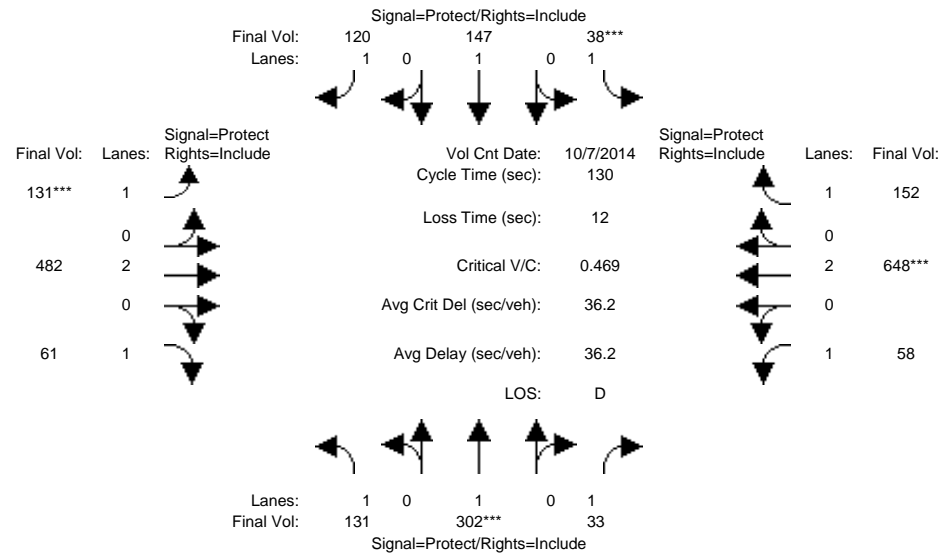

Approach:	North Bound			South Bound			East Bound			West Bound		
	L	T	R	L	T	R	L	T	R	L	T	R
Min. Green:	7	10	10	7	10	10	7	10	10	7	10	10
Y+R:	4.0	4.0	4.0	4.0	4.0	4.0	4.0	4.0	4.0	4.0	4.0	4.0
Volume Module: >> Count Date: 7 Oct 2014 <<												
Base Vol:	131	302	33	38	147	120	131	482	61	58	648	152
Growth Adj:	1.00	1.00	1.00	1.00	1.00	1.00	1.00	1.00	1.00	1.00	1.00	1.00
Initial Bse:	131	302	33	38	147	120	131	482	61	58	648	152
Added Vol:	0	0	0	0	0	0	0	0	0	0	0	0
PasserByVol:	0	0	0	0	0	0	0	0	0	0	0	0
Initial Fut:	131	302	33	38	147	120	131	482	61	58	648	152
User Adj:	1.00	1.00	1.00	1.00	1.00	1.00	1.00	1.00	1.00	1.00	1.00	1.00
PHF Adj:	1.00	1.00	1.00	1.00	1.00	1.00	1.00	1.00	1.00	1.00	1.00	1.00
PHF Volume:	131	302	33	38	147	120	131	482	61	58	648	152
Reduct Vol:	0	0	0	0	0	0	0	0	0	0	0	0
Reduced Vol:	131	302	33	38	147	120	131	482	61	58	648	152
PCE Adj:	1.00	1.00	1.00	1.00	1.00	1.00	1.00	1.00	1.00	1.00	1.00	1.00
MLF Adj:	1.00	1.00	1.00	1.00	1.00	1.00	1.00	1.00	1.00	1.00	1.00	1.00
FinalVolume:	131	302	33	38	147	120	131	482	61	58	648	152
Saturation Flow Module:												
Sat/Lane:	1900	1900	1900	1900	1900	1900	1900	1900	1900	1900	1900	1900
Adjustment:	0.92	1.00	0.92	0.92	1.00	0.92	0.92	1.00	0.92	0.92	1.00	0.92
Lanes:	1.00	1.00	1.00	1.00	1.00	1.00	1.00	2.00	1.00	1.00	2.00	1.00
Final Sat.:	1750	1900	1750	1750	1900	1750	1750	3800	1750	1750	3800	1750
Capacity Analysis Module:												
Vol/Sat:	0.07	0.16	0.02	0.02	0.08	0.07	0.07	0.13	0.03	0.03	0.17	0.09
Crit Moves:	****	****	****	****	****	****	****	****	****	****	****	****
Green Time:	24.9	43.6	43.6	7.0	25.7	25.7	20.6	47.3	47.3	20.1	46.8	46.8
Volume/Cap:	0.39	0.47	0.06	0.40	0.39	0.35	0.47	0.35	0.10	0.21	0.47	0.24
Delay/Veh:	46.7	34.7	29.3	62.3	46.0	45.5	51.1	30.3	27.3	48.5	32.3	29.3
User DelAdj:	1.00	1.00	1.00	1.00	1.00	1.00	1.00	1.00	1.00	1.00	1.00	1.00
AdjDel/Veh:	46.7	34.7	29.3	62.3	46.0	45.5	51.1	30.3	27.3	48.5	32.3	29.3
LOS by Move:	D	C	C	E	D	D	D	C	C	D	C	C
HCM2k95thQ:	9	17	2	3	10	8	10	13	3	4	18	9

Note: Queue reported is the number of cars per lane.

BART Phase II Extension Project

Level Of Service Computation Report
2000 HCM Operations (Future Volume Alternative)
PM - Existing Conditions

Intersection #3748: RACE/SAN CARLOS

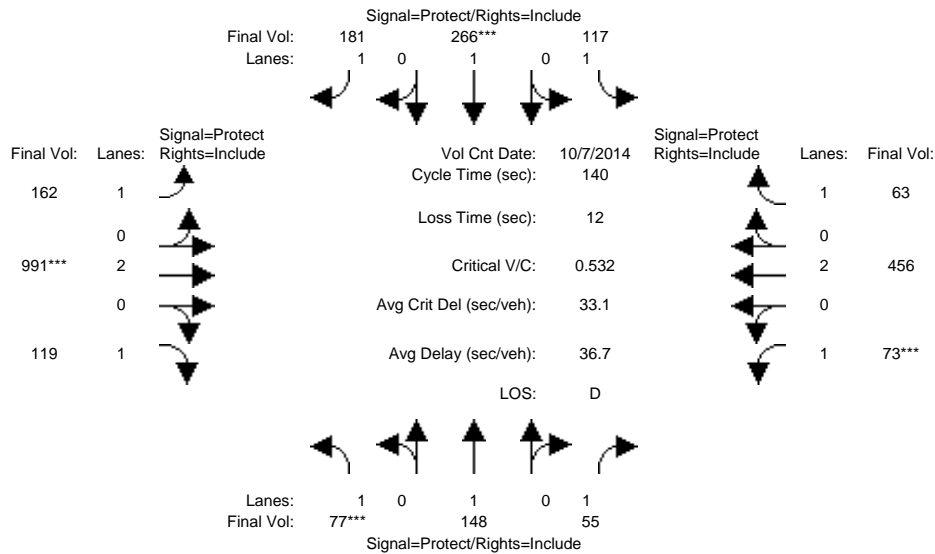

Approach:	North Bound			South Bound			East Bound			West Bound		
Movement:	L	T	R	L	T	R	L	T	R	L	T	R
Min. Green:	7	10	10	7	10	10	7	10	10	7	10	10
Y+R:	4.0	4.0	4.0	4.0	4.0	4.0	4.0	4.0	4.0	4.0	4.0	4.0
Volume Module: >> Count Date: 7 Oct 2014 <<												
Base Vol:	77	148	55	117	266	181	162	991	119	73	456	63
Growth Adj:	1.00	1.00	1.00	1.00	1.00	1.00	1.00	1.00	1.00	1.00	1.00	1.00
Initial Bse:	77	148	55	117	266	181	162	991	119	73	456	63
Added Vol:	0	0	0	0	0	0	0	0	0	0	0	0
PasserByVol:	0	0	0	0	0	0	0	0	0	0	0	0
Initial Fut:	77	148	55	117	266	181	162	991	119	73	456	63
User Adj:	1.00	1.00	1.00	1.00	1.00	1.00	1.00	1.00	1.00	1.00	1.00	1.00
PHF Adj:	1.00	1.00	1.00	1.00	1.00	1.00	1.00	1.00	1.00	1.00	1.00	1.00
PHF Volume:	77	148	55	117	266	181	162	991	119	73	456	63
Reduct Vol:	0	0	0	0	0	0	0	0	0	0	0	0
Reduced Vol:	77	148	55	117	266	181	162	991	119	73	456	63
PCE Adj:	1.00	1.00	1.00	1.00	1.00	1.00	1.00	1.00	1.00	1.00	1.00	1.00
MLF Adj:	1.00	1.00	1.00	1.00	1.00	1.00	1.00	1.00	1.00	1.00	1.00	1.00
FinalVolume:	77	148	55	117	266	181	162	991	119	73	456	63
Saturation Flow Module:												
Sat/Lane:	1900	1900	1900	1900	1900	1900	1900	1900	1900	1900	1900	1900
Adjustment:	0.92	1.00	0.92	0.92	1.00	0.92	0.92	1.00	0.92	0.92	1.00	0.92
Lanes:	1.00	1.00	1.00	1.00	1.00	1.00	1.00	2.00	1.00	1.00	2.00	1.00
Final Sat.:	1750	1900	1750	1750	1900	1750	1750	3800	1750	1750	3800	1750
Capacity Analysis Module:												
Vol/Sat:	0.04	0.08	0.03	0.07	0.14	0.10	0.09	0.26	0.07	0.04	0.12	0.04
Crit Moves:	****				****			****			****	
Green Time:	11.6	26.1	26.1	22.4	36.8	36.8	34.7	68.6	68.6	11.0	44.9	44.9
Volume/Cap:	0.53	0.42	0.17	0.42	0.53	0.39	0.37	0.53	0.14	0.53	0.37	0.11
Delay/Veh:	65.4	51.1	48.1	54.0	45.3	43.0	44.2	24.9	19.6	66.0	36.9	33.6
User DelAdj:	1.00	1.00	1.00	1.00	1.00	1.00	1.00	1.00	1.00	1.00	1.00	1.00
AdjDel/Veh:	65.4	51.1	48.1	54.0	45.3	43.0	44.2	24.9	19.6	66.0	36.9	33.6
LOS by Move:	E	D	D	D	D	D	D	C	B	E	D	C
HCM2k95thQ:	7	11	4	9	18	13	12	25	6	7	14	4

Note: Queue reported is the number of cars per lane.

BART Phase II Extension Project

Level Of Service Computation Report
 2000 HCM Operations (Future Volume Alternative)
 AM - Existing Conditions

Intersection #3985: DELMAS/SAN FERNANDO

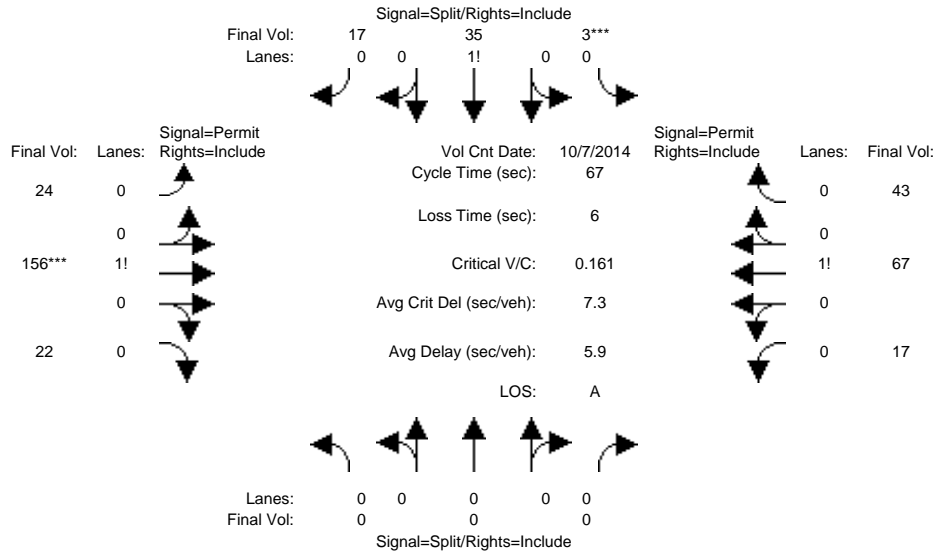

Approach:	North Bound			South Bound			East Bound			West Bound			
	L	T	R	L	T	R	L	T	R	L	T	R	
Min. Green:	0	0	0	10	10	10	10	10	10	10	10	10	
Y+R:	4.0	4.0	4.0	4.0	4.0	4.0	4.0	4.0	4.0	4.0	4.0	4.0	
Volume Module: >> Count Date: 7 Oct 2014 <<													
Base Vol:	0	0	0	3	35	17	24	156	22	17	67	43	
Growth Adj:	1.00	1.00	1.00	1.00	1.00	1.00	1.00	1.00	1.00	1.00	1.00	1.00	
Initial Bse:	0	0	0	3	35	17	24	156	22	17	67	43	
Added Vol:	0	0	0	0	0	0	0	0	0	0	0	0	
PasserByVol:	0	0	0	0	0	0	0	0	0	0	0	0	
Initial Fut:	0	0	0	3	35	17	24	156	22	17	67	43	
User Adj:	1.00	1.00	1.00	1.00	1.00	1.00	1.00	1.00	1.00	1.00	1.00	1.00	
PHF Adj:	1.00	1.00	1.00	1.00	1.00	1.00	1.00	1.00	1.00	1.00	1.00	1.00	
PHF Volume:	0	0	0	3	35	17	24	156	22	17	67	43	
Reduct Vol:	0	0	0	0	0	0	0	0	0	0	0	0	
Reduced Vol:	0	0	0	3	35	17	24	156	22	17	67	43	
PCE Adj:	1.00	1.00	1.00	1.00	1.00	1.00	1.00	1.00	1.00	1.00	1.00	1.00	
MLF Adj:	1.00	1.00	1.00	1.00	1.00	1.00	1.00	1.00	1.00	1.00	1.00	1.00	
FinalVolume:	0	0	0	3	35	17	24	156	22	17	67	43	
Saturation Flow Module:													
Sat/Lane:	1900	1900	1900	1900	1900	1900	1900	1900	1900	1900	1900	1900	
Adjustment:	0.92	1.00	0.92	0.92	0.92	0.92	0.92	0.92	0.92	0.92	0.92	0.92	
Lanes:	0.00	0.00	0.00	0.05	0.64	0.31	0.12	0.77	0.11	0.13	0.53	0.34	
Final Sat.:	0	0	0	95	1114	541	208	1351	191	234	923	593	
Capacity Analysis Module:													
Vol/Sat:	0.00	0.00	0.00	0.03	0.03	0.03	0.12	0.12	0.12	0.07	0.07	0.07	
Crit Moves:				****				****					
Green Time:	0.0	0.0	0.0	13.1	13.1	13.1	47.9	47.9	47.9	47.9	47.9	47.9	
Volume/Cap:	0.00	0.00	0.00	0.16	0.16	0.16	0.16	0.16	0.16	0.10	0.10	0.10	
Delay/Veh:	0.0	0.0	0.0	22.6	22.6	22.6	3.1	3.1	3.1	3.0	3.0	3.0	
User DelAdj:	1.00	1.00	1.00	1.00	1.00	1.00	1.00	1.00	1.00	1.00	1.00	1.00	
AdjDel/Veh:	0.0	0.0	0.0	22.6	22.6	22.6	3.1	3.1	3.1	3.0	3.0	3.0	
LOS by Move:	A	A	A	C	C	C	A	A	A	A	A	A	
HCM2k95thQ:	0	0	0	2	2	2	3	3	3	2	2	2	

Note: Queue reported is the number of cars per lane.

BART Phase II Extension Project

Level Of Service Computation Report
2000 HCM Operations (Future Volume Alternative)
PM - Existing Conditions

Intersection #3985: DELMAS/SAN FERNANDO

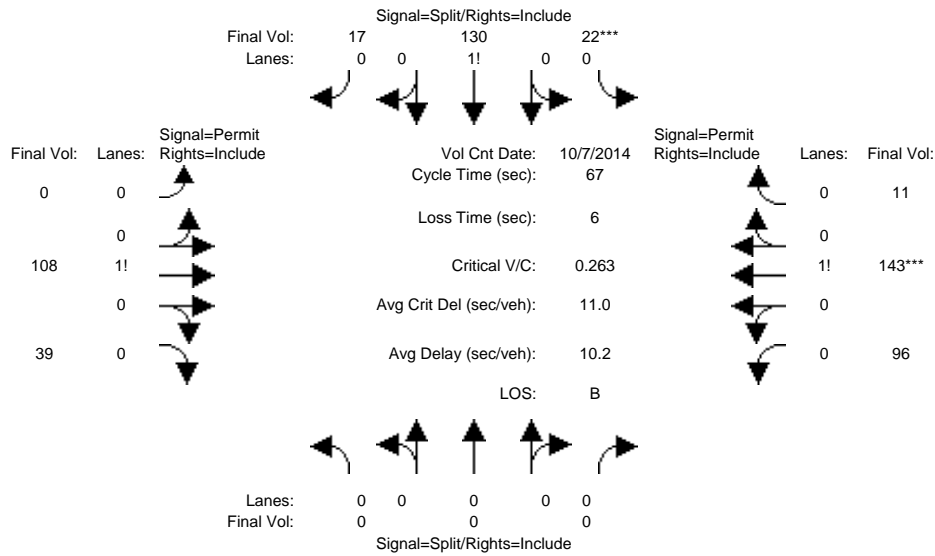

Approach:	North Bound			South Bound			East Bound			West Bound		
	L	T	R	L	T	R	L	T	R	L	T	R
Min. Green:	0	0	0	10	10	10	10	10	10	10	10	10
Y+R:	4.0	4.0	4.0	4.0	4.0	4.0	4.0	4.0	4.0	4.0	4.0	4.0
Volume Module: >> Count Date: 7 Oct 2014 <<												
Base Vol:	0	0	0	22	130	17	0	108	39	96	143	11
Growth Adj:	1.00	1.00	1.00	1.00	1.00	1.00	1.00	1.00	1.00	1.00	1.00	1.00
Initial Bse:	0	0	0	22	130	17	0	108	39	96	143	11
Added Vol:	0	0	0	0	0	0	0	0	0	0	0	0
PasserByVol:	0	0	0	0	0	0	0	0	0	0	0	0
Initial Fut:	0	0	0	22	130	17	0	108	39	96	143	11
User Adj:	1.00	1.00	1.00	1.00	1.00	1.00	1.00	1.00	1.00	1.00	1.00	1.00
PHF Adj:	1.00	1.00	1.00	1.00	1.00	1.00	1.00	1.00	1.00	1.00	1.00	1.00
PHF Volume:	0	0	0	22	130	17	0	108	39	96	143	11
Reduct Vol:	0	0	0	0	0	0	0	0	0	0	0	0
Reduced Vol:	0	0	0	22	130	17	0	108	39	96	143	11
PCE Adj:	1.00	1.00	1.00	1.00	1.00	1.00	1.00	1.00	1.00	1.00	1.00	1.00
MLF Adj:	1.00	1.00	1.00	1.00	1.00	1.00	1.00	1.00	1.00	1.00	1.00	1.00
FinalVolume:	0	0	0	22	130	17	0	108	39	96	143	11
Saturation Flow Module:												
Sat/Lane:	1900	1900	1900	1900	1900	1900	1900	1900	1900	1900	1900	1900
Adjustment:	0.92	1.00	0.92	0.92	0.92	0.92	0.92	0.95	0.95	0.92	0.92	0.92
Lanes:	0.00	0.00	0.00	0.13	0.77	0.10	0.00	0.73	0.27	0.38	0.58	0.04
Final Sat.:	0	0	0	228	1346	176	0	1322	478	672	1001	77
Capacity Analysis Module:												
Vol/Sat:	0.00	0.00	0.00	0.10	0.10	0.10	0.00	0.08	0.08	0.14	0.14	0.14
Crit Moves:	****											
Green Time:	0.0	0.0	0.0	24.6	24.6	24.6	0.0	36.4	36.4	36.4	36.4	36.4
Volume/Cap:	0.00	0.00	0.00	0.26	0.26	0.26	0.00	0.15	0.15	0.26	0.26	0.26
Delay/Veh:	0.0	0.0	0.0	15.1	15.1	15.1	0.0	7.7	7.7	8.3	8.3	8.3
User DelAdj:	1.00	1.00	1.00	1.00	1.00	1.00	1.00	1.00	1.00	1.00	1.00	1.00
AdjDel/Veh:	0.0	0.0	0.0	15.1	15.1	15.1	0.0	7.7	7.7	8.3	8.3	8.3
LOS by Move:	A	A	A	B	B	B	A	A	A	A	A	A
HCM2k95thQ:	0	0	0	6	6	6	0	3	3	6	6	6

Note: Queue reported is the number of cars per lane.

BART Phase II Extension Project

Level Of Service Computation Report
 2000 HCM Operations (Future Volume Alternative)
 AM - 2025 No Project Conditions

Intersection #3013: 87/JULIAN (E) *

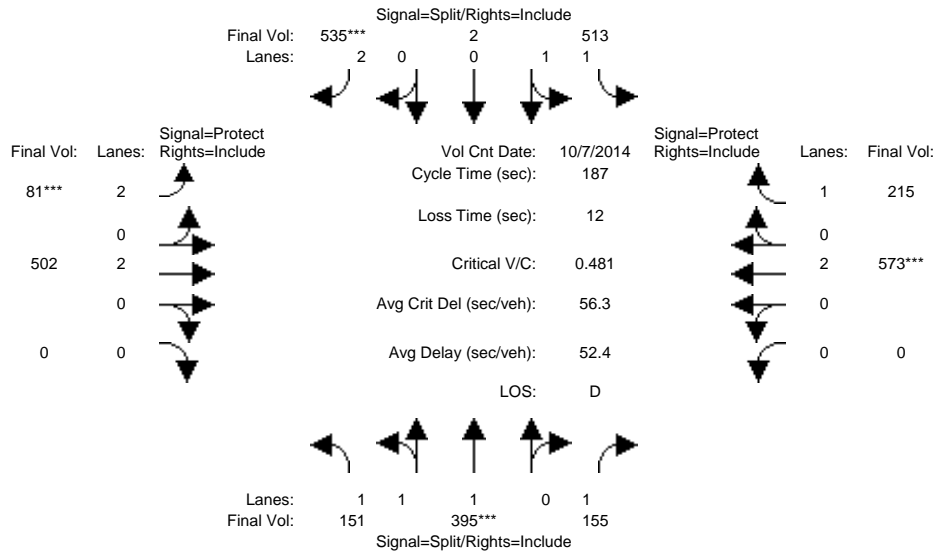

Approach:	North Bound			South Bound			East Bound			West Bound		
	L	T	R	L	T	R	L	T	R	L	T	R
Min. Green:	10	10	10	10	10	10	7	10	0	0	10	10
Y+R:	4.0	4.0	4.0	4.0	4.0	4.0	4.0	4.0	4.0	4.0	4.0	4.0

Volume Module:	>>	Count	Date:	7 Oct 2014	<<							
Base Vol:	151	395	155	513	2	535	81	502	0	0	573	215
Growth Adj:	1.00	1.00	1.00	1.00	1.00	1.00	1.00	1.00	1.00	1.00	1.00	1.00
Initial Bse:	151	395	155	513	2	535	81	502	0	0	573	215
Added Vol:	0	0	0	0	0	0	0	0	0	0	0	0
PasserByVol:	0	0	0	0	0	0	0	0	0	0	0	0
Initial Fut:	151	395	155	513	2	535	81	502	0	0	573	215
User Adj:	1.00	1.00	1.00	1.00	1.00	1.00	1.00	1.00	1.00	1.00	1.00	1.00
PHF Adj:	1.00	1.00	1.00	1.00	1.00	1.00	1.00	1.00	1.00	1.00	1.00	1.00
PHF Volume:	151	395	155	513	2	535	81	502	0	0	573	215
Reduct Vol:	0	0	0	0	0	0	0	0	0	0	0	0
Reduced Vol:	151	395	155	513	2	535	81	502	0	0	573	215
PCE Adj:	1.00	1.00	1.00	1.00	1.00	1.00	1.00	1.00	1.00	1.00	1.00	1.00
MLF Adj:	1.00	1.00	1.00	1.00	1.00	1.00	1.00	1.00	1.00	1.00	1.00	1.00
Final Volume:	151	395	155	513	2	535	81	502	0	0	573	215

Saturation Flow Module:												
Sat/Lane:	1900	1900	1900	1900	1900	1900	1900	1900	1900	1900	1900	1900
Adjustment:	0.92	1.00	0.92	0.93	0.95	0.83	0.83	1.00	0.92	0.92	1.00	0.92
Lanes:	1.00	2.00	1.00	1.99	0.01	2.00	2.00	2.00	0.00	0.00	2.00	1.00
Final Sat.:	1750	3800	1750	3536	14	3150	3150	3800	0	0	3800	1750

Capacity Analysis Module:												
Vol/Sat:	0.09	0.10	0.09	0.15	0.15	0.17	0.03	0.13	0.00	0.00	0.15	0.12
Crit Moves:	****			****			****			****		
Green Time:	40.4	40.4	40.4	66.0	66.0	66.0	10.0	68.6	0.0	0.0	58.6	58.6
Volume/Cap:	0.40	0.48	0.41	0.41	0.41	0.48	0.48	0.36	0.00	0.00	0.48	0.39
Delay/Veh:	63.1	64.5	63.8	46.0	46.0	47.5	88.1	43.4	0.0	0.0	52.2	50.7
User DelAdj:	1.00	1.00	1.00	1.00	1.00	1.00	1.00	1.00	1.00	1.00	1.00	1.00
AdjDel/Veh:	63.1	64.5	63.8	46.0	46.0	47.5	88.1	43.4	0.0	0.0	52.2	50.7
LOS by Move:	E	E	E	D	D	D	F	D	A	A	D	D
HCM2k95thQ:	15	18	15	21	21	25	5	18	0	0	23	19

Note: Queue reported is the number of cars per lane.

BART Phase II Extension Project

Level Of Service Computation Report
 2000 HCM Operations (Future Volume Alternative)
 PM - 2025 No Project Conditions

Intersection #3013: 87/JULIAN (E) *

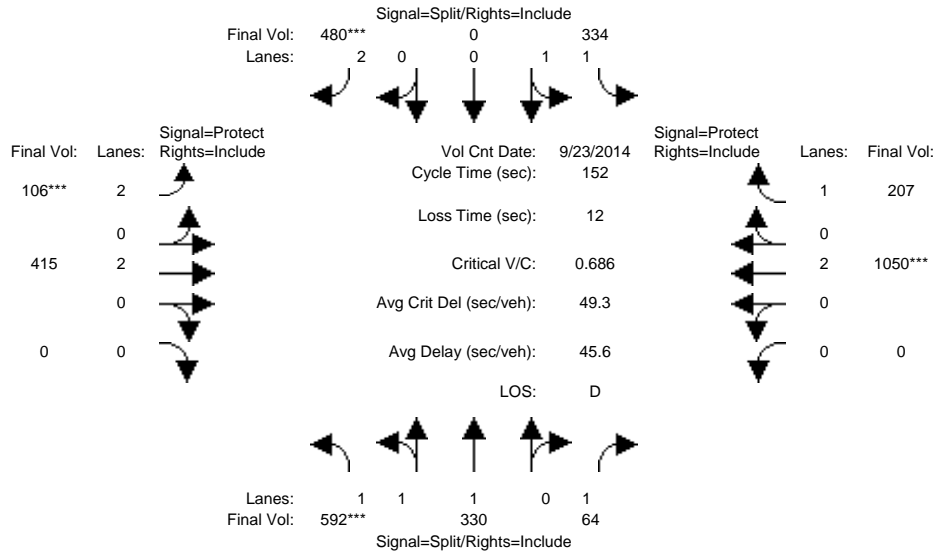

Approach:	North Bound			South Bound			East Bound			West Bound		
	L	T	R	L	T	R	L	T	R	L	T	R
Min. Green:	10	10	10	10	10	10	7	10	0	0	10	10
Y+R:	4.0	4.0	4.0	4.0	4.0	4.0	4.0	4.0	4.0	4.0	4.0	4.0
Volume Module: >> Count Date: 23 Sep 2014 <<												
Base Vol:	592	330	64	334	0	480	106	415	0	0	1050	207
Growth Adj:	1.00	1.00	1.00	1.00	1.00	1.00	1.00	1.00	1.00	1.00	1.00	1.00
Initial Bse:	592	330	64	334	0	480	106	415	0	0	1050	207
Added Vol:	0	0	0	0	0	0	0	0	0	0	0	0
PasserByVol:	0	0	0	0	0	0	0	0	0	0	0	0
Initial Fut:	592	330	64	334	0	480	106	415	0	0	1050	207
User Adj:	1.00	1.00	1.00	1.00	1.00	1.00	1.00	1.00	1.00	1.00	1.00	1.00
PHF Adj:	1.00	1.00	1.00	1.00	1.00	1.00	1.00	1.00	1.00	1.00	1.00	1.00
PHF Volume:	592	330	64	334	0	480	106	415	0	0	1050	207
Reduct Vol:	0	0	0	0	0	0	0	0	0	0	0	0
Reduced Vol:	592	330	64	334	0	480	106	415	0	0	1050	207
PCE Adj:	1.00	1.00	1.00	1.00	1.00	1.00	1.00	1.00	1.00	1.00	1.00	1.00
MLF Adj:	1.00	1.00	1.00	1.00	1.00	1.00	1.00	1.00	1.00	1.00	1.00	1.00
FinalVolume:	592	330	64	334	0	480	106	415	0	0	1050	207
Saturation Flow Module:												
Sat/Lane:	1900	1900	1900	1900	1900	1900	1900	1900	1900	1900	1900	1900
Adjustment:	0.93	1.00	0.92	0.93	1.00	0.83	0.83	1.00	0.92	0.92	1.00	0.92
Lanes:	1.97	1.03	1.00	2.00	0.00	2.00	2.00	2.00	0.00	0.00	2.00	1.00
Final Sat.:	3496	1949	1750	3550	0	3150	3150	3800	0	0	3800	1750
Capacity Analysis Module:												
Vol/Sat:	0.17	0.17	0.04	0.09	0.00	0.15	0.03	0.11	0.00	0.00	0.28	0.12
Crit Moves:	****					****	****				****	
Green Time:	37.5	37.5	37.5	33.8	0.0	33.8	7.5	68.7	0.0	0.0	61.2	61.2
Volume/Cap:	0.69	0.69	0.15	0.42	0.00	0.69	0.69	0.24	0.00	0.00	0.69	0.29
Delay/Veh:	53.4	53.4	44.9	51.1	0.0	57.1	83.2	25.7	0.0	0.0	38.8	31.0
User DelAdj:	1.00	1.00	1.00	1.00	1.00	1.00	1.00	1.00	1.00	1.00	1.00	1.00
AdjDel/Veh:	53.4	53.4	44.9	51.1	0.0	57.1	83.2	25.7	0.0	0.0	38.8	31.0
LOS by Move:	D	D	D	D	A	E	F	C	A	A	D	C
HCM2k95thQ:	24	24	5	14	0	24	6	11	0	0	34	13

Note: Queue reported is the number of cars per lane.

BART Phase II Extension Project

Level Of Service Computation Report
 2000 HCM Operations (Future Volume Alternative)
 AM - 2025 No Project Conditions

Intersection #3014: 87/JULIAN (W)

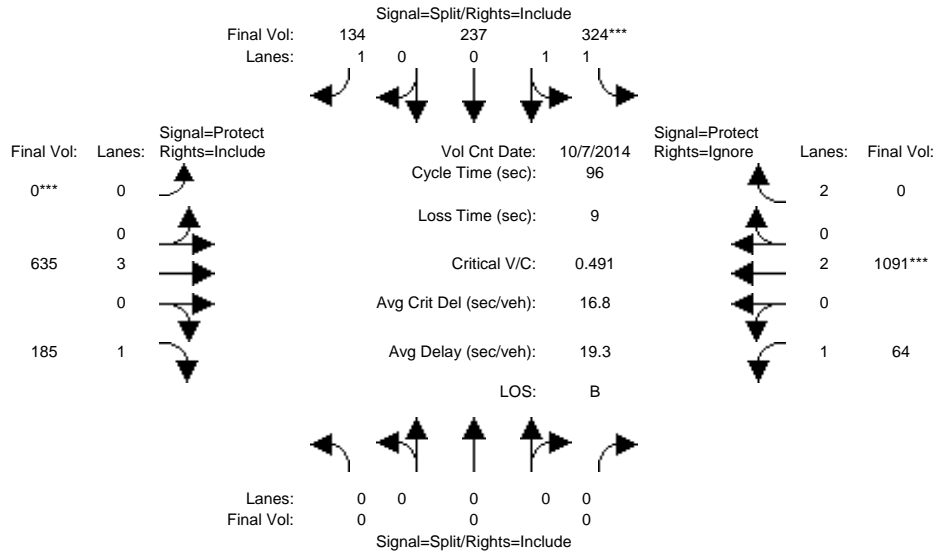

Approach:	North Bound			South Bound			East Bound			West Bound		
	L	T	R	L	T	R	L	T	R	L	T	R
Min. Green:	0	0	0	10	10	10	0	10	10	7	10	10
Y+R:	4.0	4.0	4.0	4.0	4.0	4.0	4.0	4.0	4.0	4.0	4.0	4.0
Volume Module: >> Count Date: 7 Oct 2014 <<												
Base Vol:	0	0	0	324	237	134	0	635	185	64	1091	0
Growth Adj:	1.00	1.00	1.00	1.00	1.00	1.00	1.00	1.00	1.00	1.00	1.00	1.00
Initial Bse:	0	0	0	324	237	134	0	635	185	64	1091	0
Added Vol:	0	0	0	0	0	0	0	0	0	0	0	0
PasserByVol:	0	0	0	0	0	0	0	0	0	0	0	0
Initial Fut:	0	0	0	324	237	134	0	635	185	64	1091	0
User Adj:	1.00	1.00	1.00	1.00	1.00	1.00	1.00	1.00	1.00	1.00	1.00	0.00
PHF Adj:	1.00	1.00	1.00	1.00	1.00	1.00	1.00	1.00	1.00	1.00	1.00	0.00
PHF Volume:	0	0	0	324	237	134	0	635	185	64	1091	0
Reduct Vol:	0	0	0	0	0	0	0	0	0	0	0	0
Reduced Vol:	0	0	0	324	237	134	0	635	185	64	1091	0
PCE Adj:	1.00	1.00	1.00	1.00	1.00	1.00	1.00	1.00	1.00	1.00	1.00	0.00
MLF Adj:	1.00	1.00	1.00	1.00	1.00	1.00	1.00	1.00	1.00	1.00	1.00	0.00
FinalVolume:	0	0	0	324	237	134	0	635	185	64	1091	0
Saturation Flow Module:												
Sat/Lane:	1900	1900	1900	1900	1900	1900	1900	1900	1900	1900	1900	1900
Adjustment:	0.92	1.00	0.92	0.92	0.95	0.92	0.92	1.00	0.92	0.92	1.00	0.83
Lanes:	0.00	0.00	0.00	1.17	0.83	1.00	0.00	3.00	1.00	1.00	2.00	2.00
Final Sat.:	0	0	0	2050	1500	1750	0	5700	1750	1750	3800	3150
Capacity Analysis Module:												
Vol/Sat:	0.00	0.00	0.00	0.16	0.16	0.08	0.00	0.11	0.11	0.04	0.29	0.00
Crit Moves:				****				****				****
Green Time:	0.0	0.0	0.0	30.9	30.9	30.9	0.0	33.9	33.9	22.2	56.1	0.0
Volume/Cap:	0.00	0.00	0.00	0.49	0.49	0.24	0.00	0.32	0.30	0.16	0.49	0.00
Delay/Veh:	0.0	0.0	0.0	26.6	26.6	24.1	0.0	22.7	22.7	29.6	11.8	0.0
User DelAdj:	1.00	1.00	1.00	1.00	1.00	1.00	1.00	1.00	1.00	1.00	1.00	1.00
AdjDel/Veh:	0.0	0.0	0.0	26.6	26.6	24.1	0.0	22.7	22.7	29.6	11.8	0.0
LOS by Move:	A	A	A	C	C	C	A	C	C	C	B	A
HCM2k95thQ:	0	0	0	14	14	6	0	9	8	3	17	0

Note: Queue reported is the number of cars per lane.

BART Phase II Extension Project

Level Of Service Computation Report
 2000 HCM Operations (Future Volume Alternative)
 PM - 2025 No Project Conditions

Intersection #3014: 87/JULIAN (W)

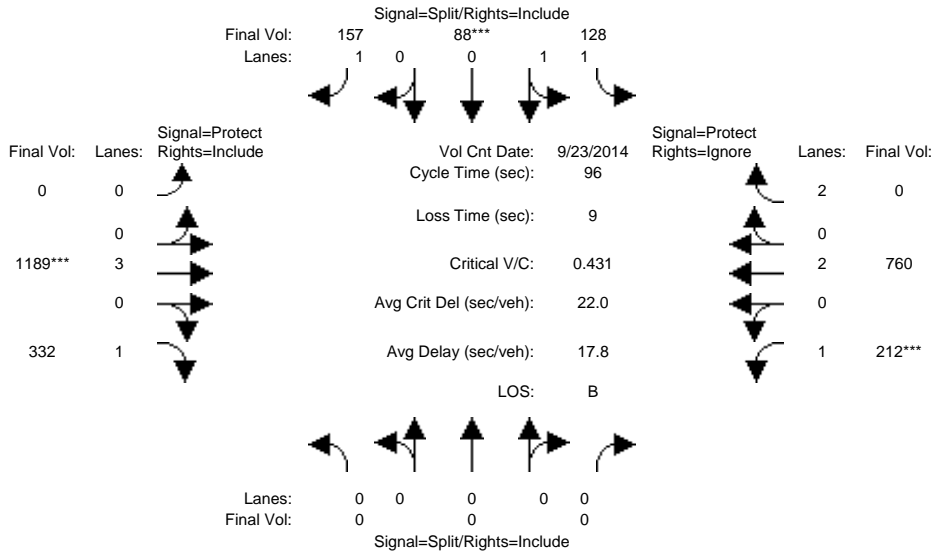

Approach:	North Bound			South Bound			East Bound			West Bound		
	L	T	R	L	T	R	L	T	R	L	T	R
Min. Green:	0	0	0	10	10	10	0	10	10	7	10	10
Y+R:	4.0	4.0	4.0	4.0	4.0	4.0	4.0	4.0	4.0	4.0	4.0	4.0
Volume Module: >> Count Date: 23 Sep 2014 <<												
Base Vol:	0	0	0	128	88	157	0	1189	332	212	760	0
Growth Adj:	1.00	1.00	1.00	1.00	1.00	1.00	1.00	1.00	1.00	1.00	1.00	1.00
Initial Bse:	0	0	0	128	88	157	0	1189	332	212	760	0
Added Vol:	0	0	0	0	0	0	0	0	0	0	0	0
PasserByVol:	0	0	0	0	0	0	0	0	0	0	0	0
Initial Fut:	0	0	0	128	88	157	0	1189	332	212	760	0
User Adj:	1.00	1.00	1.00	1.00	1.00	1.00	1.00	1.00	1.00	1.00	1.00	0.00
PHF Adj:	1.00	1.00	1.00	1.00	1.00	1.00	1.00	1.00	1.00	1.00	1.00	0.00
PHF Volume:	0	0	0	128	88	157	0	1189	332	212	760	0
Reduct Vol:	0	0	0	0	0	0	0	0	0	0	0	0
Reduced Vol:	0	0	0	128	88	157	0	1189	332	212	760	0
PCE Adj:	1.00	1.00	1.00	1.00	1.00	1.00	1.00	1.00	1.00	1.00	1.00	0.00
MLF Adj:	1.00	1.00	1.00	1.00	1.00	1.00	1.00	1.00	1.00	1.00	1.00	0.00
FinalVolume:	0	0	0	128	88	157	0	1189	332	212	760	0
Saturation Flow Module:												
Sat/Lane:	1900	1900	1900	1900	1900	1900	1900	1900	1900	1900	1900	1900
Adjustment:	0.92	1.00	0.92	0.93	0.95	0.92	0.92	1.00	0.92	0.92	1.00	0.83
Lanes:	0.00	0.00	0.00	1.20	0.80	1.00	0.00	3.00	1.00	1.00	2.00	2.00
Final Sat.:	0	0	0	2103	1446	1750	0	5700	1750	1750	3800	3150
Capacity Analysis Module:												
Vol/Sat:	0.00	0.00	0.00	0.06	0.06	0.09	0.00	0.21	0.19	0.12	0.20	0.00
Crit Moves:				****			****			****		
Green Time:	0.0	0.0	0.0	18.6	18.6	18.6	0.0	43.3	43.3	25.1	68.4	0.0
Volume/Cap:	0.00	0.00	0.00	0.31	0.31	0.46	0.00	0.46	0.42	0.46	0.28	0.00
Delay/Veh:	0.0	0.0	0.0	33.5	33.5	35.3	0.0	18.4	18.2	30.5	5.0	0.0
User DelAdj:	1.00	1.00	1.00	1.00	1.00	1.00	1.00	1.00	1.00	1.00	1.00	1.00
AdjDel/Veh:	0.0	0.0	0.0	33.5	33.5	35.3	0.0	18.4	18.2	30.5	5.0	0.0
LOS by Move:	A	A	A	C	C	D	A	B	B	C	A	A
HCM2k95thQ:	0	0	0	6	6	10	0	14	13	11	8	0

Note: Queue reported is the number of cars per lane.

BART Phase II Extension Project

Level Of Service Computation Report
 2000 HCM Operations (Future Volume Alternative)
 AM - 2025 No Project Conditions

Intersection #3015: 87/SANTA CLARA

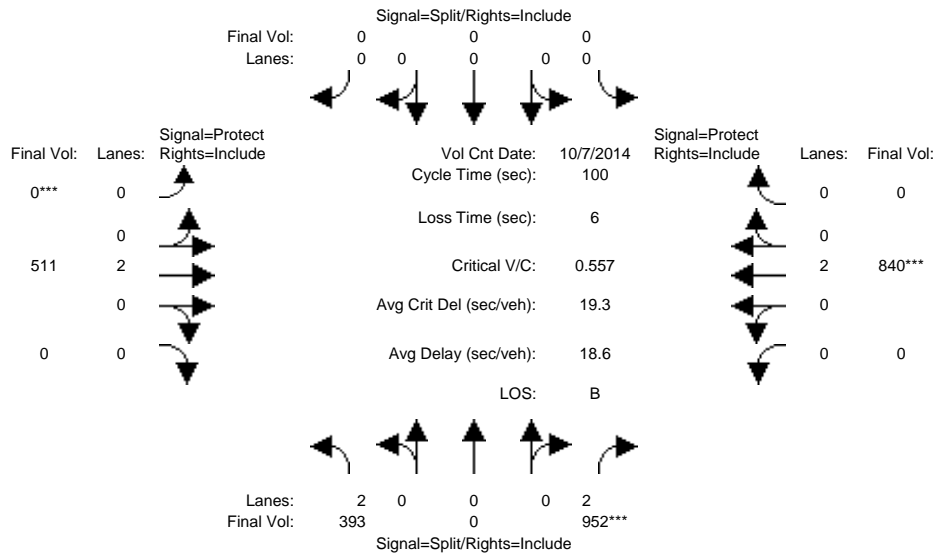

Approach:	North Bound			South Bound			East Bound			West Bound		
	L	T	R	L	T	R	L	T	R	L	T	R
Min. Green:	10	0	10	0	0	0	0	10	0	0	10	0
Y+R:	4.0	4.0	4.0	4.0	4.0	4.0	4.0	4.0	4.0	4.0	4.0	4.0

Volume Module:	>>	Count	Date:	7 Oct 2014	<<							
Base Vol:	393	0	952	0	0	0	0	511	0	0	840	0
Growth Adj:	1.00	1.00	1.00	1.00	1.00	1.00	1.00	1.00	1.00	1.00	1.00	1.00
Initial Bse:	393	0	952	0	0	0	0	511	0	0	840	0
Added Vol:	0	0	0	0	0	0	0	0	0	0	0	0
PasserByVol:	0	0	0	0	0	0	0	0	0	0	0	0
Initial Fut:	393	0	952	0	0	0	0	511	0	0	840	0
User Adj:	1.00	1.00	1.00	1.00	1.00	1.00	1.00	1.00	1.00	1.00	1.00	1.00
PHF Adj:	1.00	1.00	1.00	1.00	1.00	1.00	1.00	1.00	1.00	1.00	1.00	1.00
PHF Volume:	393	0	952	0	0	0	0	511	0	0	840	0
Reduct Vol:	0	0	0	0	0	0	0	0	0	0	0	0
Reduced Vol:	393	0	952	0	0	0	0	511	0	0	840	0
PCE Adj:	1.00	1.00	1.00	1.00	1.00	1.00	1.00	1.00	1.00	1.00	1.00	1.00
MLF Adj:	1.00	1.00	1.00	1.00	1.00	1.00	1.00	1.00	1.00	1.00	1.00	1.00
FinalVolume:	393	0	952	0	0	0	0	511	0	0	840	0

Saturation Flow Module:												
Sat/Lane:	1900	1900	1900	1900	1900	1900	1900	1900	1900	1900	1900	1900
Adjustment:	0.83	1.00	0.83	0.92	1.00	0.92	0.92	1.00	0.92	0.92	1.00	0.92
Lanes:	2.00	0.00	2.00	0.00	0.00	0.00	0.00	2.00	0.00	0.00	2.00	0.00
Final Sat.:	3150	0	3150	0	0	0	0	3800	0	0	3800	0

Capacity Analysis Module:												
Vol/Sat:	0.12	0.00	0.30	0.00	0.00	0.00	0.00	0.13	0.00	0.00	0.22	0.00
Crit Moves:			****					****			****	
Green Time:	54.3	0.0	54.3	0.0	0.0	0.0	0.0	39.7	0.0	0.0	39.7	0.0
Volume/Cap:	0.23	0.00	0.56	0.00	0.00	0.00	0.00	0.34	0.00	0.00	0.56	0.00
Delay/Veh:	12.0	0.0	15.4	0.0	0.0	0.0	0.0	21.1	0.0	0.0	23.8	0.0
User DelAdj:	1.00	1.00	1.00	1.00	1.00	1.00	1.00	1.00	1.00	1.00	1.00	1.00
AdjDel/Veh:	12.0	0.0	15.4	0.0	0.0	0.0	0.0	21.1	0.0	0.0	23.8	0.0
LOS by Move:	B	A	B	A	A	A	A	C	A	A	C	A
HCM2k95thQ:	7	0	21	0	0	0	0	10	0	0	18	0

Note: Queue reported is the number of cars per lane.

BART Phase II Extension Project

Level Of Service Computation Report
 2000 HCM Operations (Future Volume Alternative)
 PM - 2025 No Project Conditions

Intersection #3015: 87/SANTA CLARA

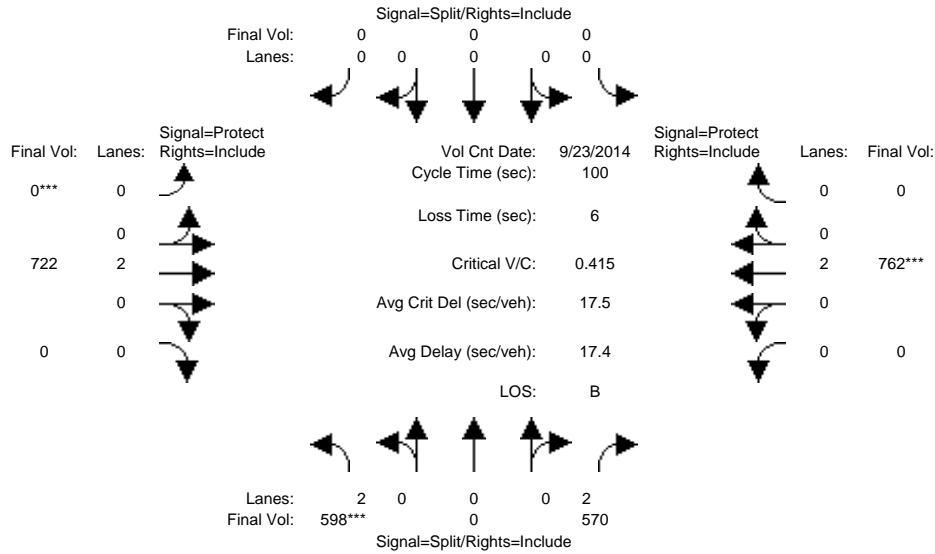

Approach:	North Bound			South Bound			East Bound			West Bound		
	L	T	R	L	T	R	L	T	R	L	T	R
Min. Green:	10	0	10	0	0	0	0	10	0	0	10	0
Y+R:	4.0	4.0	4.0	4.0	4.0	4.0	4.0	4.0	4.0	4.0	4.0	4.0
Volume Module: >> Count Date: 23 Sep 2014 <<												
Base Vol:	598	0	570	0	0	0	0	722	0	0	762	0
Growth Adj:	1.00	1.00	1.00	1.00	1.00	1.00	1.00	1.00	1.00	1.00	1.00	1.00
Initial Bse:	598	0	570	0	0	0	0	722	0	0	762	0
Added Vol:	0	0	0	0	0	0	0	0	0	0	0	0
PasserByVol:	0	0	0	0	0	0	0	0	0	0	0	0
Initial Fut:	598	0	570	0	0	0	0	722	0	0	762	0
User Adj:	1.00	1.00	1.00	1.00	1.00	1.00	1.00	1.00	1.00	1.00	1.00	1.00
PHF Adj:	1.00	1.00	1.00	1.00	1.00	1.00	1.00	1.00	1.00	1.00	1.00	1.00
PHF Volume:	598	0	570	0	0	0	0	722	0	0	762	0
Reduct Vol:	0	0	0	0	0	0	0	0	0	0	0	0
Reduced Vol:	598	0	570	0	0	0	0	722	0	0	762	0
PCE Adj:	1.00	1.00	1.00	1.00	1.00	1.00	1.00	1.00	1.00	1.00	1.00	1.00
MLF Adj:	1.00	1.00	1.00	1.00	1.00	1.00	1.00	1.00	1.00	1.00	1.00	1.00
FinalVolume:	598	0	570	0	0	0	0	722	0	0	762	0
Saturation Flow Module:												
Sat/Lane:	1900	1900	1900	1900	1900	1900	1900	1900	1900	1900	1900	1900
Adjustment:	0.83	1.00	0.83	0.92	1.00	0.92	0.92	1.00	0.92	0.92	1.00	0.92
Lanes:	2.00	0.00	2.00	0.00	0.00	0.00	0.00	2.00	0.00	0.00	2.00	0.00
Final Sat.:	3150	0	3150	0	0	0	0	3800	0	0	3800	0
Capacity Analysis Module:												
Vol/Sat:	0.19	0.00	0.18	0.00	0.00	0.00	0.00	0.19	0.00	0.00	0.20	0.00
Crit Moves:	****							****			****	
Green Time:	45.7	0.0	45.7	0.0	0.0	0.0	0.0	48.3	0.0	0.0	48.3	0.0
Volume/Cap:	0.42	0.00	0.40	0.00	0.00	0.00	0.00	0.39	0.00	0.00	0.42	0.00
Delay/Veh:	18.4	0.0	18.2	0.0	0.0	0.0	0.0	16.6	0.0	0.0	16.9	0.0
User DelAdj:	1.00	1.00	1.00	1.00	1.00	1.00	1.00	1.00	1.00	1.00	1.00	1.00
AdjDel/Veh:	18.4	0.0	18.2	0.0	0.0	0.0	0.0	16.6	0.0	0.0	16.9	0.0
LOS by Move:	B	A	B	A	A	A	A	B	A	A	B	A
HCM2k95thQ:	14	0	13	0	0	0	0	13	0	0	14	0

Note: Queue reported is the number of cars per lane.

BART Phase II Extension Project

Level Of Service Computation Report
 2000 HCM Operations (Future Volume Alternative)
 AM - 2025 No Project Conditions

Intersection #3032: 280/BIRD (N)

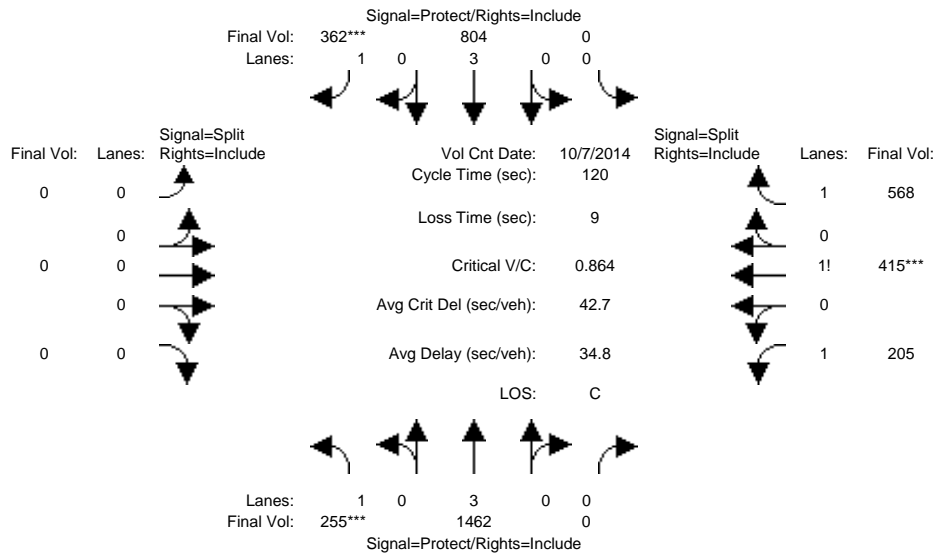

Approach:	North Bound			South Bound			East Bound			West Bound		
Movement:	L	T	R	L	T	R	L	T	R	L	T	R
Min. Green:	7	10	0	0	10	10	0	0	0	10	10	10
Y+R:	4.0	4.0	4.0	4.0	4.0	4.0	4.0	4.0	4.0	4.0	4.0	4.0
Volume Module: >> Count Date: 7 Oct 2014 <<												
Base Vol:	255	1462	0	0	804	362	0	0	0	205	415	568
Growth Adj:	1.00	1.00	1.00	1.00	1.00	1.00	1.00	1.00	1.00	1.00	1.00	1.00
Initial Bse:	255	1462	0	0	804	362	0	0	0	205	415	568
Added Vol:	0	0	0	0	0	0	0	0	0	0	0	0
PasserByVol:	0	0	0	0	0	0	0	0	0	0	0	0
Initial Fut:	255	1462	0	0	804	362	0	0	0	205	415	568
User Adj:	1.00	1.00	1.00	1.00	1.00	1.00	1.00	1.00	1.00	1.00	1.00	1.00
PHF Adj:	1.00	1.00	1.00	1.00	1.00	1.00	1.00	1.00	1.00	1.00	1.00	1.00
PHF Volume:	255	1462	0	0	804	362	0	0	0	205	415	568
Reduct Vol:	0	0	0	0	0	0	0	0	0	0	0	0
Reduced Vol:	255	1462	0	0	804	362	0	0	0	205	415	568
PCE Adj:	1.00	1.00	1.00	1.00	1.00	1.00	1.00	1.00	1.00	1.00	1.00	1.00
MLF Adj:	1.00	1.00	1.00	1.00	1.00	1.00	1.00	1.00	1.00	1.00	1.00	1.00
FinalVolume:	255	1462	0	0	804	362	0	0	0	205	415	568
Saturation Flow Module:												
Sat/Lane:	1900	1900	1900	1900	1900	1900	1900	1900	1900	1900	1900	1900
Adjustment:	0.92	1.00	0.92	0.92	1.00	0.92	0.92	1.00	0.92	0.92	0.95	0.95
Lanes:	1.00	3.00	0.00	0.00	3.00	1.00	0.00	0.00	0.00	1.13	0.52	1.35
Final Sat.:	1750	5700	0	0	5700	1750	0	0	0	1979	929	2435
Capacity Analysis Module:												
Vol/Sat:	0.15	0.26	0.00	0.00	0.14	0.21	0.00	0.00	0.00	0.10	0.45	0.23
Crit Moves:	****					****					****	
Green Time:	20.2	49.0	0.0	0.0	28.7	28.7	0.0	0.0	0.0	62.0	62.0	62.0
Volume/Cap:	0.86	0.63	0.00	0.00	0.59	0.86	0.00	0.00	0.00	0.20	0.86	0.45
Delay/Veh:	70.8	28.8	0.0	0.0	41.1	60.6	0.0	0.0	0.0	15.6	31.2	18.4
User DelAdj:	1.00	1.00	1.00	1.00	1.00	1.00	1.00	1.00	1.00	1.00	1.00	1.00
AdjDel/Veh:	70.8	28.8	0.0	0.0	41.1	60.6	0.0	0.0	0.0	15.6	31.2	18.4
LOS by Move:	E	C	A	A	D	E	A	A	A	B	C	B
HCM2k95thQ:	23	26	0	0	16	26	0	0	0	8	48	19

Note: Queue reported is the number of cars per lane.

BART Phase II Extension Project

Level Of Service Computation Report
 2000 HCM Operations (Future Volume Alternative)
 PM - 2025 No Project Conditions

Intersection #3032: 280/BIRD (N)

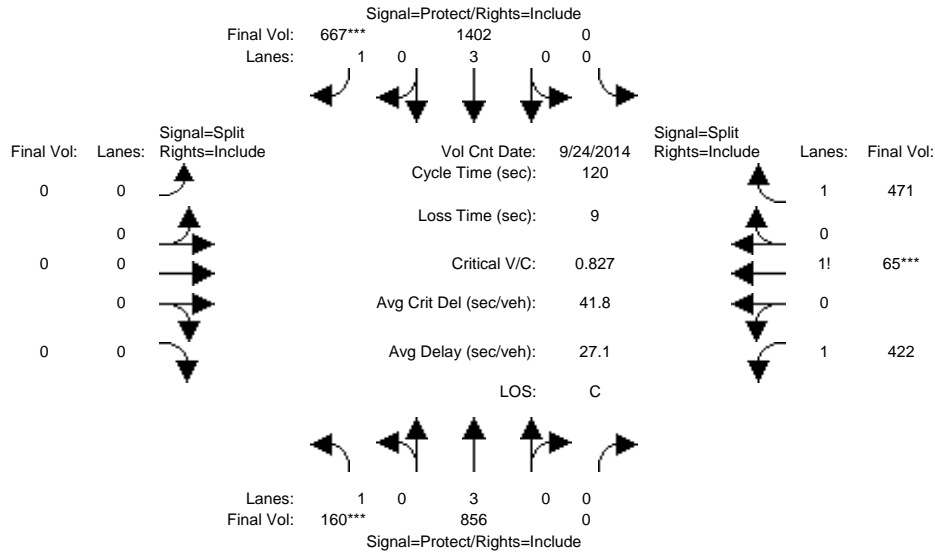

Approach:	North Bound			South Bound			East Bound			West Bound		
	L	T	R	L	T	R	L	T	R	L	T	R
Min. Green:	7	10	0	0	10	10	0	0	0	10	10	10
Y+R:	4.0	4.0	4.0	4.0	4.0	4.0	4.0	4.0	4.0	4.0	4.0	4.0
Volume Module: >> Count Date: 24 Sep 2014 <<												
Base Vol:	160	856	0	0	1402	667	0	0	0	422	65	471
Growth Adj:	1.00	1.00	1.00	1.00	1.00	1.00	1.00	1.00	1.00	1.00	1.00	1.00
Initial Bse:	160	856	0	0	1402	667	0	0	0	422	65	471
Added Vol:	0	0	0	0	0	0	0	0	0	0	0	0
PasserByVol:	0	0	0	0	0	0	0	0	0	0	0	0
Initial Fut:	160	856	0	0	1402	667	0	0	0	422	65	471
User Adj:	1.00	1.00	1.00	1.00	1.00	1.00	1.00	1.00	1.00	1.00	1.00	1.00
PHF Adj:	1.00	1.00	1.00	1.00	1.00	1.00	1.00	1.00	1.00	1.00	1.00	1.00
PHF Volume:	160	856	0	0	1402	667	0	0	0	422	65	471
Reduct Vol:	0	0	0	0	0	0	0	0	0	0	0	0
Reduced Vol:	160	856	0	0	1402	667	0	0	0	422	65	471
PCE Adj:	1.00	1.00	1.00	1.00	1.00	1.00	1.00	1.00	1.00	1.00	1.00	1.00
MLF Adj:	1.00	1.00	1.00	1.00	1.00	1.00	1.00	1.00	1.00	1.00	1.00	1.00
FinalVolume:	160	856	0	0	1402	667	0	0	0	422	65	471
Saturation Flow Module:												
Sat/Lane:	1900	1900	1900	1900	1900	1900	1900	1900	1900	1900	1900	1900
Adjustment:	0.92	1.00	0.92	0.92	1.00	0.92	0.92	1.00	0.92	0.92	0.92	0.92
Lanes:	1.00	3.00	0.00	0.00	3.00	1.00	0.00	0.00	0.00	1.41	0.13	1.46
Final Sat.:	1750	5700	0	0	5700	1750	0	0	0	2472	222	2556
Capacity Analysis Module:												
Vol/Sat:	0.09	0.15	0.00	0.00	0.25	0.38	0.00	0.00	0.00	0.17	0.29	0.18
Crit Moves:	****				****					****		
Green Time:	13.3	68.6	0.0	0.0	55.3	55.3	0.0	0.0	0.0	42.4	42.4	42.4
Volume/Cap:	0.83	0.26	0.00	0.00	0.53	0.83	0.00	0.00	0.00	0.48	0.83	0.52
Delay/Veh:	76.7	13.0	0.0	0.0	23.3	35.2	0.0	0.0	0.0	30.4	40.5	31.0
User DelAdj:	1.00	1.00	1.00	1.00	1.00	1.00	1.00	1.00	1.00	1.00	1.00	1.00
AdjDel/Veh:	76.7	13.0	0.0	0.0	23.3	35.2	0.0	0.0	0.0	30.4	40.5	31.0
LOS by Move:	E	B	A	A	C	D	A	A	A	C	D	C
HCM2k95thQ:	16	10	0	0	21	39	0	0	0	17	35	19

Note: Queue reported is the number of cars per lane.

BART Phase II Extension Project

Level Of Service Computation Report
 2000 HCM Operations (Future Volume Alternative)
 AM - 2025 No Project Conditions

Intersection #3033: 280/BIRD (S)

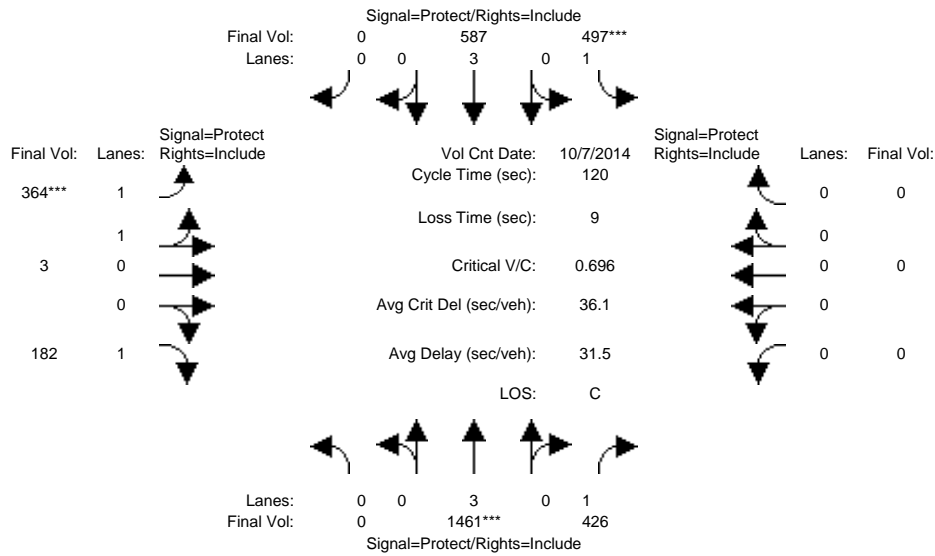

Approach:	North Bound			South Bound			East Bound			West Bound		
	L	T	R	L	T	R	L	T	R	L	T	R
Min. Green:	0	10	10	7	10	0	10	10	10	0	0	0
Y+R:	4.0	4.0	4.0	4.0	4.0	4.0	4.0	4.0	4.0	4.0	4.0	4.0

Volume Module:	>>	Count	Date:	7 Oct 2014	<<												
Base Vol:	0	1461	426	497	587	0	364	3	182	0	0	0					
Growth Adj:	1.00	1.00	1.00	1.00	1.00	1.00	1.00	1.00	1.00	1.00	1.00	1.00					
Initial Bse:	0	1461	426	497	587	0	364	3	182	0	0	0					
Added Vol:	0	0	0	0	0	0	0	0	0	0	0	0					
PasserByVol:	0	0	0	0	0	0	0	0	0	0	0	0					
Initial Fut:	0	1461	426	497	587	0	364	3	182	0	0	0					
User Adj:	1.00	1.00	1.00	1.00	1.00	1.00	1.00	1.00	1.00	1.00	1.00	1.00					
PHF Adj:	1.00	1.00	1.00	1.00	1.00	1.00	1.00	1.00	1.00	1.00	1.00	1.00					
PHF Volume:	0	1461	426	497	587	0	364	3	182	0	0	0					
Reduct Vol:	0	0	0	0	0	0	0	0	0	0	0	0					
Reduced Vol:	0	1461	426	497	587	0	364	3	182	0	0	0					
PCE Adj:	1.00	1.00	1.00	1.00	1.00	1.00	1.00	1.00	1.00	1.00	1.00	1.00					
MLF Adj:	1.00	1.00	1.00	1.00	1.00	1.00	1.00	1.00	1.00	1.00	1.00	1.00					
FinalVolume:	0	1461	426	497	587	0	364	3	182	0	0	0					

Saturation Flow Module:												
Sat/Lane:	1900	1900	1900	1900	1900	1900	1900	1900	1900	1900	1900	1900
Adjustment:	0.92	1.00	0.92	0.92	1.00	0.92	0.93	0.95	0.92	0.92	1.00	0.92
Lanes:	0.00	3.00	1.00	1.00	3.00	0.00	1.98	0.02	1.00	0.00	0.00	0.00
Final Sat.:	0	5700	1750	1750	5700	0	3521	29	1750	0	0	0

Capacity Analysis Module:												
Vol/Sat:	0.00	0.26	0.24	0.28	0.10	0.00	0.10	0.10	0.10	0.00	0.00	0.00
Crit Moves:	****			****			****					
Green Time:	0.0	44.2	44.2	49.0	93.2	0.0	17.8	17.8	17.8	0.0	0.0	0.0
Volume/Cap:	0.00	0.70	0.66	0.70	0.13	0.00	0.70	0.70	0.70	0.00	0.00	0.00
Delay/Veh:	0.0	33.2	34.2	32.4	3.4	0.0	52.6	52.6	56.8	0.0	0.0	0.0
User DelAdj:	1.00	1.00	1.00	1.00	1.00	1.00	1.00	1.00	1.00	1.00	1.00	1.00
AdjDel/Veh:	0.0	33.2	34.2	32.4	3.4	0.0	52.6	52.6	56.8	0.0	0.0	0.0
LOS by Move:	A	C	C	C	A	A	D	D	E	A	A	A
HCM2k95thQ:	0	27	25	29	4	0	15	15	15	0	0	0

Note: Queue reported is the number of cars per lane.

BART Phase II Extension Project

Level Of Service Computation Report
 2000 HCM Operations (Future Volume Alternative)
 PM - 2025 No Project Conditions

Intersection #3033: 280/BIRD (S)

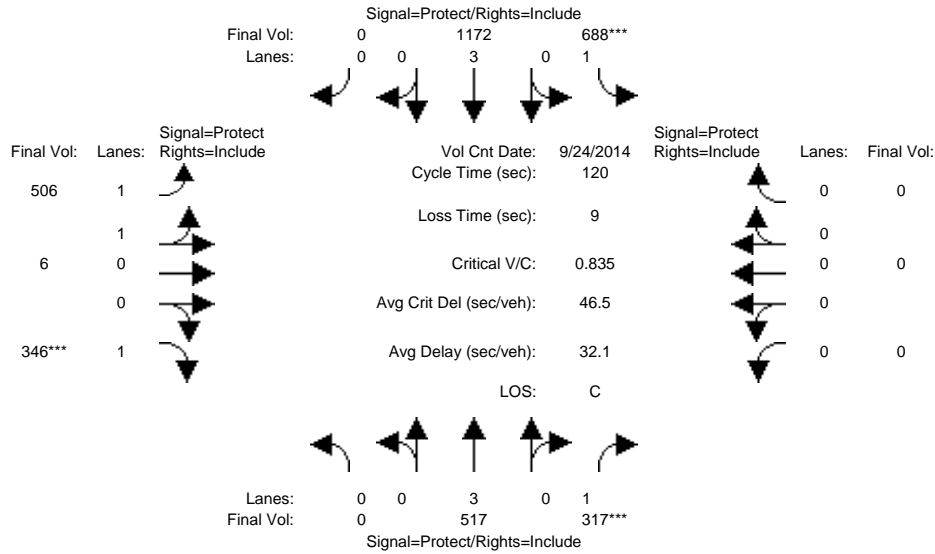

Approach:	North Bound			South Bound			East Bound			West Bound		
	L	T	R	L	T	R	L	T	R	L	T	R
Min. Green:	0	10	10	7	10	0	10	10	10	0	0	0
Y+R:	4.0	4.0	4.0	4.0	4.0	4.0	4.0	4.0	4.0	4.0	4.0	4.0

Volume Module:	>> Count Date: 24 Sep 2014 <<											
Base Vol:	0	517	317	688	1172	0	506	6	346	0	0	0
Growth Adj:	1.00	1.00	1.00	1.00	1.00	1.00	1.00	1.00	1.00	1.00	1.00	1.00
Initial Bse:	0	517	317	688	1172	0	506	6	346	0	0	0
Added Vol:	0	0	0	0	0	0	0	0	0	0	0	0
PasserByVol:	0	0	0	0	0	0	0	0	0	0	0	0
Initial Fut:	0	517	317	688	1172	0	506	6	346	0	0	0
User Adj:	1.00	1.00	1.00	1.00	1.00	1.00	1.00	1.00	1.00	1.00	1.00	1.00
PHF Adj:	1.00	1.00	1.00	1.00	1.00	1.00	1.00	1.00	1.00	1.00	1.00	1.00
PHF Volume:	0	517	317	688	1172	0	506	6	346	0	0	0
Reduct Vol:	0	0	0	0	0	0	0	0	0	0	0	0
Reduced Vol:	0	517	317	688	1172	0	506	6	346	0	0	0
PCE Adj:	1.00	1.00	1.00	1.00	1.00	1.00	1.00	1.00	1.00	1.00	1.00	1.00
MLF Adj:	1.00	1.00	1.00	1.00	1.00	1.00	1.00	1.00	1.00	1.00	1.00	1.00
Final Volume:	0	517	317	688	1172	0	506	6	346	0	0	0

Saturation Flow Module:												
Sat/Lane:	1900	1900	1900	1900	1900	1900	1900	1900	1900	1900	1900	1900
Adjustment:	0.92	1.00	0.92	0.92	1.00	0.92	0.93	0.95	0.92	0.92	1.00	0.92
Lanes:	0.00	3.00	1.00	1.00	3.00	0.00	1.98	0.02	1.00	0.00	0.00	0.00
Final Sat.:	0	5700	1750	1750	5700	0	3508	42	1750	0	0	0

Capacity Analysis Module:												
Vol/Sat:	0.00	0.09	0.18	0.39	0.21	0.00	0.14	0.14	0.20	0.00	0.00	0.00
Crit Moves:			****	****					****			
Green Time:	0.0	26.0	26.0	56.5	82.6	0.0	28.4	28.4	28.4	0.0	0.0	0.0
Volume/Cap:	0.00	0.42	0.83	0.83	0.30	0.00	0.61	0.61	0.83	0.00	0.00	0.00
Delay/Veh:	0.0	40.7	59.6	35.0	7.4	0.0	42.1	42.1	57.2	0.0	0.0	0.0
User DelAdj:	1.00	1.00	1.00	1.00	1.00	1.00	1.00	1.00	1.00	1.00	1.00	1.00
AdjDel/Veh:	0.0	40.7	59.6	35.0	7.4	0.0	42.1	42.1	57.2	0.0	0.0	0.0
LOS by Move:	A	D	E	D	A	A	D	D	E	A	A	A
HCM2k95thQ:	0	10	23	42	11	0	18	18	27	0	0	0

Note: Queue reported is the number of cars per lane.

BART Phase II Extension Project

Level Of Service Computation Report
 2000 HCM Operations (Future Volume Alternative)
 AM - 2025 No Project Conditions

Intersection #3058: ALAMEDA/NAGLEE

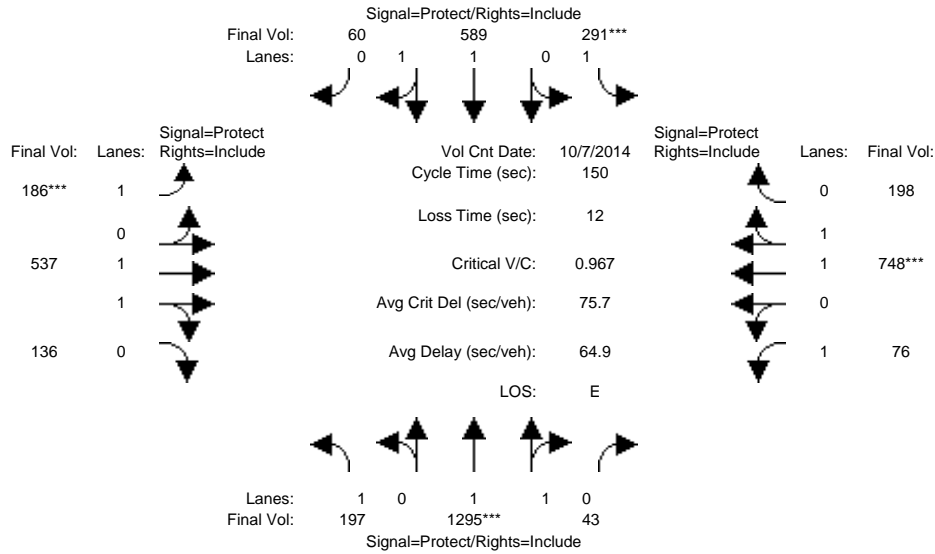

Approach:	North Bound			South Bound			East Bound			West Bound		
	L	T	R	L	T	R	L	T	R	L	T	R
Min. Green:	7	10	10	7	10	10	7	10	10	7	10	10
Y+R:	4.0	4.0	4.0	4.0	4.0	4.0	4.0	4.0	4.0	4.0	4.0	4.0
Volume Module: >> Count Date: 7 Oct 2014 <<												
Base Vol:	197	1295	43	291	589	60	186	537	136	76	748	198
Growth Adj:	1.00	1.00	1.00	1.00	1.00	1.00	1.00	1.00	1.00	1.00	1.00	1.00
Initial Bse:	197	1295	43	291	589	60	186	537	136	76	748	198
Added Vol:	0	0	0	0	0	0	0	0	0	0	0	0
PasserByVol:	0	0	0	0	0	0	0	0	0	0	0	0
Initial Fut:	197	1295	43	291	589	60	186	537	136	76	748	198
User Adj:	1.00	1.00	1.00	1.00	1.00	1.00	1.00	1.00	1.00	1.00	1.00	1.00
PHF Adj:	1.00	1.00	1.00	1.00	1.00	1.00	1.00	1.00	1.00	1.00	1.00	1.00
PHF Volume:	197	1295	43	291	589	60	186	537	136	76	748	198
Reduct Vol:	0	0	0	0	0	0	0	0	0	0	0	0
Reduced Vol:	197	1295	43	291	589	60	186	537	136	76	748	198
PCE Adj:	1.00	1.00	1.00	1.00	1.00	1.00	1.00	1.00	1.00	1.00	1.00	1.00
MLF Adj:	1.00	1.00	1.00	1.00	1.00	1.00	1.00	1.00	1.00	1.00	1.00	1.00
Final Volume:	197	1295	43	291	589	60	186	537	136	76	748	198
Saturation Flow Module:												
Sat/Lane:	1900	1900	1900	1900	1900	1900	1900	1900	1900	1900	1900	1900
Adjustment:	0.92	0.97	0.95	0.92	0.98	0.95	0.92	0.98	0.95	0.92	0.98	0.95
Lanes:	1.00	1.93	0.07	1.00	1.81	0.19	1.00	1.58	0.42	1.00	1.57	0.43
Final Sat.:	1750	3581	119	1750	3358	342	1750	2952	748	1750	2925	774
Capacity Analysis Module:												
Vol/Sat:	0.11	0.36	0.36	0.17	0.18	0.18	0.11	0.18	0.18	0.04	0.26	0.26
Crit Moves:	****			****			****			****		
Green Time:	32.0	56.1	56.1	25.8	49.9	49.9	16.5	44.7	44.7	11.5	39.7	39.7
Volume/Cap:	0.53	0.97	0.97	0.97	0.53	0.53	0.97	0.61	0.61	0.57	0.97	0.97
Delay/Veh:	53.7	63.0	63.0	104.6	41.0	41.0	121.7	46.2	46.2	72.6	75.7	75.7
User DelAdj:	1.00	1.00	1.00	1.00	1.00	1.00	1.00	1.00	1.00	1.00	1.00	1.00
AdjDel/Veh:	53.7	63.0	63.0	104.6	41.0	41.0	121.7	46.2	46.2	72.6	75.7	75.7
LOS by Move:	D	E	E	F	D	D	F	D	D	E	E	E
HCM2k95thQ:	17	57	57	29	22	22	23	25	25	7	42	42

Note: Queue reported is the number of cars per lane.

BART Phase II Extension Project

Level Of Service Computation Report
 2000 HCM Operations (Future Volume Alternative)
 PM - 2025 No Project Conditions

Intersection #3058: ALAMEDA/NAGLEE

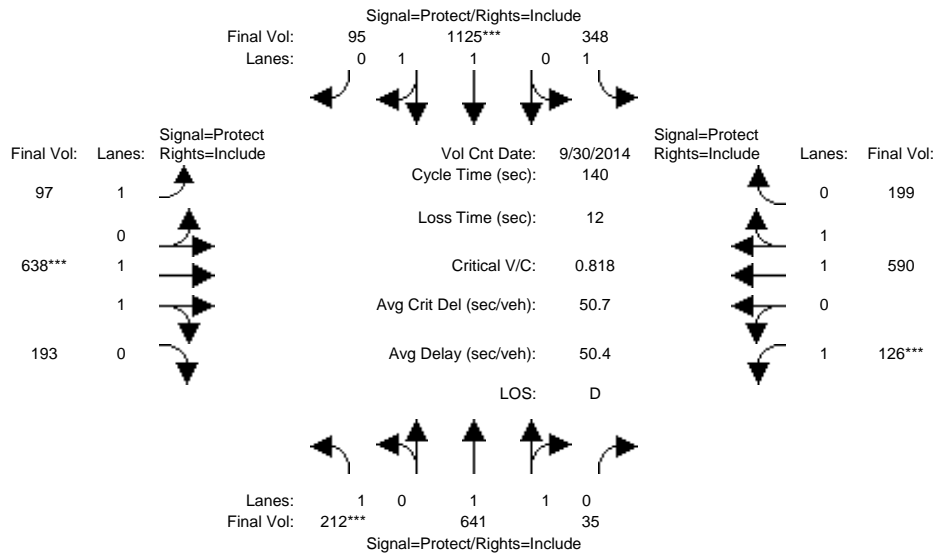

Approach:	North Bound			South Bound			East Bound			West Bound		
	L	T	R	L	T	R	L	T	R	L	T	R
Min. Green:	7	10	10	7	10	10	7	10	10	7	10	10
Y+R:	4.0	4.0	4.0	4.0	4.0	4.0	4.0	4.0	4.0	4.0	4.0	4.0

Volume Module:	>> Count Date: 30 Sep 2014 <<											
Base Vol:	212	641	35	348	1125	95	97	638	193	126	590	199
Growth Adj:	1.00	1.00	1.00	1.00	1.00	1.00	1.00	1.00	1.00	1.00	1.00	1.00
Initial Bse:	212	641	35	348	1125	95	97	638	193	126	590	199
Added Vol:	0	0	0	0	0	0	0	0	0	0	0	0
PasserByVol:	0	0	0	0	0	0	0	0	0	0	0	0
Initial Fut:	212	641	35	348	1125	95	97	638	193	126	590	199
User Adj:	1.00	1.00	1.00	1.00	1.00	1.00	1.00	1.00	1.00	1.00	1.00	1.00
PHF Adj:	1.00	1.00	1.00	1.00	1.00	1.00	1.00	1.00	1.00	1.00	1.00	1.00
PHF Volume:	212	641	35	348	1125	95	97	638	193	126	590	199
Reduct Vol:	0	0	0	0	0	0	0	0	0	0	0	0
Reduced Vol:	212	641	35	348	1125	95	97	638	193	126	590	199
PCE Adj:	1.00	1.00	1.00	1.00	1.00	1.00	1.00	1.00	1.00	1.00	1.00	1.00
MLF Adj:	1.00	1.00	1.00	1.00	1.00	1.00	1.00	1.00	1.00	1.00	1.00	1.00
FinalVolume:	212	641	35	348	1125	95	97	638	193	126	590	199

Saturation Flow Module:												
Sat/Lane:	1900	1900	1900	1900	1900	1900	1900	1900	1900	1900	1900	1900
Adjustment:	0.92	0.98	0.95	0.92	0.98	0.95	0.92	0.98	0.95	0.92	0.98	0.95
Lanes:	1.00	1.89	0.11	1.00	1.84	0.16	1.00	1.52	0.48	1.00	1.48	0.52
Final Sat.:	1750	3508	192	1750	3412	288	1750	2840	859	1750	2766	933

Capacity Analysis Module:												
Vol/Sat:	0.12	0.18	0.18	0.20	0.33	0.33	0.06	0.22	0.22	0.07	0.21	0.21
Crit Moves:	****			****			****			****		
Green Time:	20.7	37.0	37.0	40.2	56.5	56.5	10.5	38.5	38.5	12.3	40.3	40.3
Volume/Cap:	0.82	0.69	0.69	0.69	0.82	0.82	0.74	0.82	0.82	0.82	0.74	0.74
Delay/Veh:	75.9	48.5	48.5	48.5	40.9	40.9	83.4	52.8	52.8	90.5	47.9	47.9
User DelAdj:	1.00	1.00	1.00	1.00	1.00	1.00	1.00	1.00	1.00	1.00	1.00	1.00
AdjDel/Veh:	75.9	48.5	48.5	48.5	40.9	40.9	83.4	52.8	52.8	90.5	47.9	47.9
LOS by Move:	E	D	D	D	D	D	F	D	D	F	D	D
HCM2k95thQ:	21	25	25	25	41	41	12	32	32	12	28	28

Note: Queue reported is the number of cars per lane.

BART Phase II Extension Project

Level Of Service Computation Report
 2000 HCM Operations (Future Volume Alternative)
 AM - 2025 No Project Conditions

Intersection #3059: ALAMEDA/RACE *

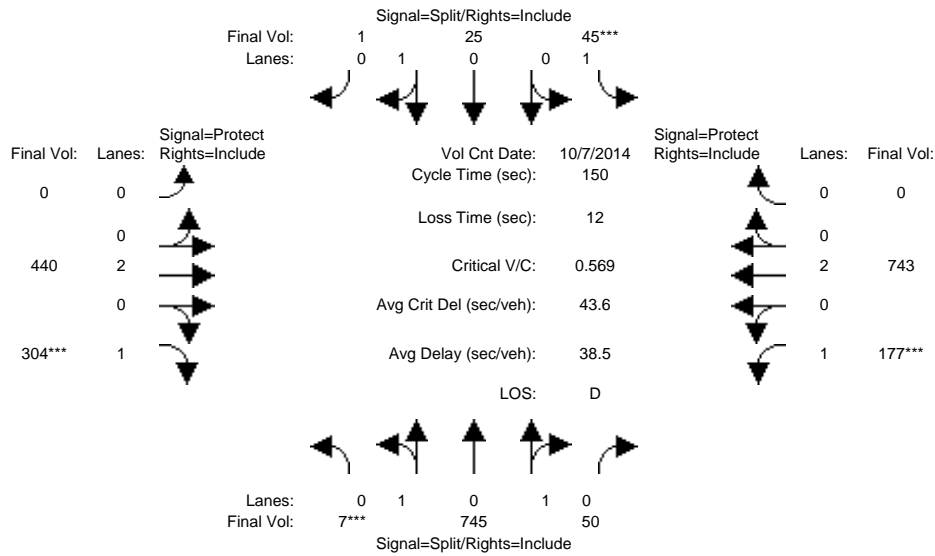

Approach:	North Bound			South Bound			East Bound			West Bound		
	L	T	R	L	T	R	L	T	R	L	T	R
Min. Green:	10	10	10	10	10	10	0	10	10	7	10	0
Y+R:	4.0	4.0	4.0	4.0	4.0	4.0	4.0	4.0	4.0	4.0	4.0	4.0
Volume Module: >> Count Date: 7 Oct 2014 <<												
Base Vol:	7	745	50	45	25	1	0	440	304	177	743	0
Growth Adj:	1.00	1.00	1.00	1.00	1.00	1.00	1.00	1.00	1.00	1.00	1.00	1.00
Initial Bse:	7	745	50	45	25	1	0	440	304	177	743	0
Added Vol:	0	0	0	0	0	0	0	0	0	0	0	0
PasserByVol:	0	0	0	0	0	0	0	0	0	0	0	0
Initial Fut:	7	745	50	45	25	1	0	440	304	177	743	0
User Adj:	1.00	1.00	1.00	1.00	1.00	1.00	1.00	1.00	1.00	1.00	1.00	1.00
PHF Adj:	1.00	1.00	1.00	1.00	1.00	1.00	1.00	1.00	1.00	1.00	1.00	1.00
PHF Volume:	7	745	50	45	25	1	0	440	304	177	743	0
Reduct Vol:	0	0	0	0	0	0	0	0	0	0	0	0
Reduced Vol:	7	745	50	45	25	1	0	440	304	177	743	0
PCE Adj:	1.00	1.00	1.00	1.00	1.00	1.00	1.00	1.00	1.00	1.00	1.00	1.00
MLF Adj:	1.00	1.00	1.00	1.00	1.00	1.00	1.00	1.00	1.00	1.00	1.00	1.00
FinalVolume:	7	745	50	45	25	1	0	440	304	177	743	0
Saturation Flow Module:												
Sat/Lane:	1900	1900	1900	1900	1900	1900	1900	1900	1900	1900	1900	1900
Adjustment:	0.95	0.95	0.95	0.92	0.95	0.95	0.92	1.00	0.92	0.92	1.00	0.92
Lanes:	0.02	1.86	0.12	1.00	0.96	0.04	0.00	2.00	1.00	1.00	2.00	0.00
Final Sat.:	31	3344	224	1750	1731	69	0	3800	1750	1750	3800	0
Capacity Analysis Module:												
Vol/Sat:	0.22	0.22	0.22	0.03	0.01	0.01	0.00	0.12	0.17	0.10	0.20	0.00
Crit Moves:	****			****					****	****		
Green Time:	57.3	57.3	57.3	10.0	10.0	10.0	0.0	44.7	44.7	26.0	70.7	0.0
Volume/Cap:	0.58	0.58	0.58	0.39	0.22	0.22	0.00	0.39	0.58	0.58	0.41	0.00
Delay/Veh:	37.5	37.5	37.5	69.2	67.2	67.2	0.0	42.0	46.4	59.9	26.2	0.0
User DelAdj:	1.00	1.00	1.00	1.00	1.00	1.00	1.00	1.00	1.00	1.00	1.00	1.00
AdjDel/Veh:	37.5	37.5	37.5	69.2	67.2	67.2	0.0	42.0	46.4	59.9	26.2	0.0
LOS by Move:	D	D	D	E	E	E	A	D	D	E	C	A
HCM2k95thQ:	27	27	27	5	3	3	0	15	23	15	20	0

Note: Queue reported is the number of cars per lane.

BART Phase II Extension Project

Level Of Service Computation Report
2000 HCM Operations (Future Volume Alternative)
PM - 2025 No Project Conditions

Intersection #3059: ALAMEDA/RACE *

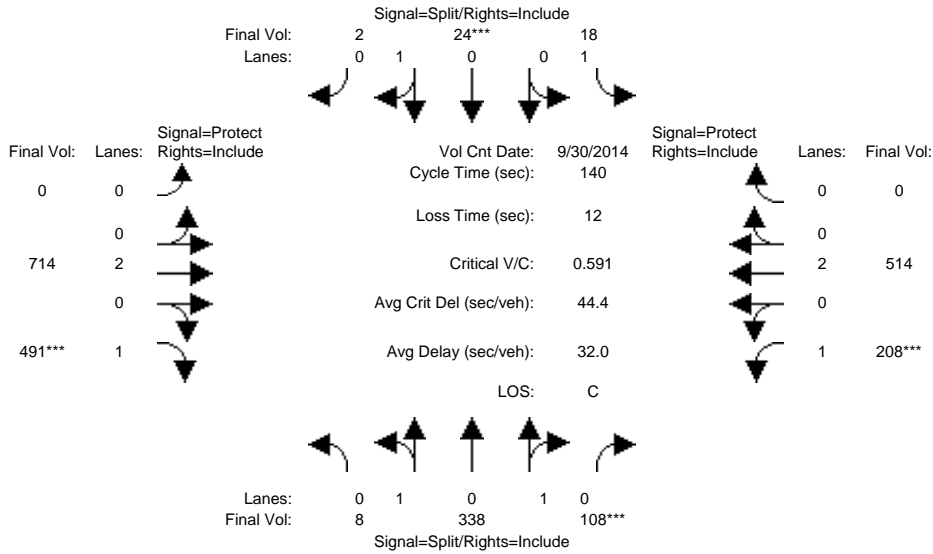

Approach:	North Bound			South Bound			East Bound			West Bound		
	L	T	R	L	T	R	L	T	R	L	T	R
Min. Green:	10	10	10	10	10	10	0	10	10	7	10	0
Y+R:	4.0	4.0	4.0	4.0	4.0	4.0	4.0	4.0	4.0	4.0	4.0	4.0
Volume Module: >> Count Date: 30 Sep 2014 <<												
Base Vol:	8	338	108	18	24	2	0	714	491	208	514	0
Growth Adj:	1.00	1.00	1.00	1.00	1.00	1.00	1.00	1.00	1.00	1.00	1.00	1.00
Initial Bse:	8	338	108	18	24	2	0	714	491	208	514	0
Added Vol:	0	0	0	0	0	0	0	0	0	0	0	0
PasserByVol:	0	0	0	0	0	0	0	0	0	0	0	0
Initial Fut:	8	338	108	18	24	2	0	714	491	208	514	0
User Adj:	1.00	1.00	1.00	1.00	1.00	1.00	1.00	1.00	1.00	1.00	1.00	1.00
PHF Adj:	1.00	1.00	1.00	1.00	1.00	1.00	1.00	1.00	1.00	1.00	1.00	1.00
PHF Volume:	8	338	108	18	24	2	0	714	491	208	514	0
Reduct Vol:	0	0	0	0	0	0	0	0	0	0	0	0
Reduced Vol:	8	338	108	18	24	2	0	714	491	208	514	0
PCE Adj:	1.00	1.00	1.00	1.00	1.00	1.00	1.00	1.00	1.00	1.00	1.00	1.00
MLF Adj:	1.00	1.00	1.00	1.00	1.00	1.00	1.00	1.00	1.00	1.00	1.00	1.00
FinalVolume:	8	338	108	18	24	2	0	714	491	208	514	0
Saturation Flow Module:												
Sat/Lane:	1900	1900	1900	1900	1900	1900	1900	1900	1900	1900	1900	1900
Adjustment:	0.95	0.95	0.95	0.92	0.95	0.95	0.92	1.00	0.92	0.92	1.00	0.92
Lanes:	0.03	1.49	0.48	1.00	0.92	0.08	0.00	2.00	1.00	1.00	2.00	0.00
Final Sat.:	63	2680	856	1750	1662	138	0	3800	1750	1750	3800	0
Capacity Analysis Module:												
Vol/Sat:	0.13	0.13	0.13	0.01	0.01	0.01	0.00	0.19	0.28	0.12	0.14	0.00
Crit Moves:			****			****			****		****	
Green Time:	28.3	28.3	28.3	10.0	10.0	10.0	0.0	63.0	63.0	26.7	89.7	0.0
Volume/Cap:	0.62	0.62	0.62	0.14	0.20	0.20	0.00	0.42	0.62	0.62	0.21	0.00
Delay/Veh:	52.7	52.7	52.7	61.5	62.0	62.0	0.0	26.2	31.0	55.7	10.5	0.0
User DelAdj:	1.00	1.00	1.00	1.00	1.00	1.00	1.00	1.00	1.00	1.00	1.00	1.00
AdjDel/Veh:	52.7	52.7	52.7	61.5	62.0	62.0	0.0	26.2	31.0	55.7	10.5	0.0
LOS by Move:	D	D	D	E	E	E	A	C	C	E	B	A
HCM2k95thQ:	17	17	17	2	3	3	0	18	30	17	9	0

Note: Queue reported is the number of cars per lane.

BART Phase II Extension Project

Level Of Service Computation Report
 2000 HCM Operations (Future Volume Alternative)
 AM - 2025 No Project Conditions

Intersection #3066: AUTUMN/SANTA CLARA

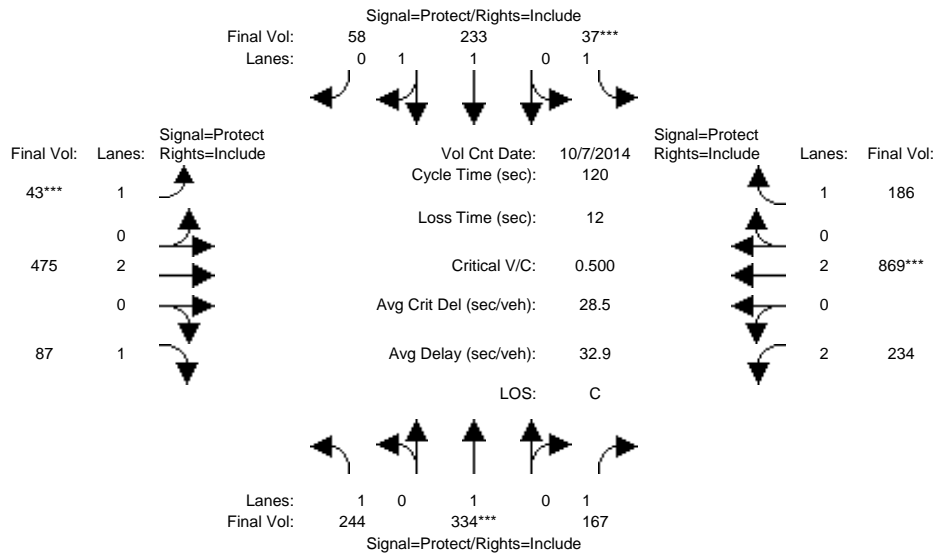

Approach:	North Bound			South Bound			East Bound			West Bound		
	L	T	R	L	T	R	L	T	R	L	T	R
Min. Green:	7	10	10	7	10	10	7	10	10	7	10	10
Y+R:	4.0	4.0	4.0	4.0	4.0	4.0	4.0	4.0	4.0	4.0	4.0	4.0

Volume Module:	Count Date: 7 Oct 2014											
Base Vol:	244	334	167	37	233	58	43	475	87	234	869	186
Growth Adj:	1.00	1.00	1.00	1.00	1.00	1.00	1.00	1.00	1.00	1.00	1.00	1.00
Initial Bse:	244	334	167	37	233	58	43	475	87	234	869	186
Added Vol:	0	0	0	0	0	0	0	0	0	0	0	0
PasserByVol:	0	0	0	0	0	0	0	0	0	0	0	0
Initial Fut:	244	334	167	37	233	58	43	475	87	234	869	186
User Adj:	1.00	1.00	1.00	1.00	1.00	1.00	1.00	1.00	1.00	1.00	1.00	1.00
PHF Adj:	1.00	1.00	1.00	1.00	1.00	1.00	1.00	1.00	1.00	1.00	1.00	1.00
PHF Volume:	244	334	167	37	233	58	43	475	87	234	869	186
Reduct Vol:	0	0	0	0	0	0	0	0	0	0	0	0
Reduced Vol:	244	334	167	37	233	58	43	475	87	234	869	186
PCE Adj:	1.00	1.00	1.00	1.00	1.00	1.00	1.00	1.00	1.00	1.00	1.00	1.00
MLF Adj:	1.00	1.00	1.00	1.00	1.00	1.00	1.00	1.00	1.00	1.00	1.00	1.00
FinalVolume:	244	334	167	37	233	58	43	475	87	234	869	186

Saturation Flow Module:	Sat/Lane: 1900											
Adjustment:	0.92	1.00	0.92	0.92	0.98	0.95	0.92	1.00	0.92	0.83	1.00	0.92
Lanes:	1.00	1.00	1.00	1.00	1.59	0.41	1.00	2.00	1.00	2.00	2.00	1.00
Final Sat.:	1750	1900	1750	1750	2962	737	1750	3800	1750	3150	3800	1750

Capacity Analysis Module:	Vol/Sat: 0.14 0.18 0.10 0.02 0.08 0.08 0.02 0.13 0.05 0.07 0.23 0.11											
Crit Moves:	****	****	****	****	****	****	****	****	****	****	****	****
Green Time:	30.0	40.9	40.9	7.0	17.9	17.9	7.0	37.7	37.7	22.4	53.1	53.1
Volume/Cap:	0.56	0.52	0.28	0.36	0.53	0.53	0.42	0.40	0.16	0.40	0.52	0.24
Delay/Veh:	40.9	32.4	29.1	56.5	48.1	48.1	57.3	32.5	29.8	43.3	24.4	21.0
User DelAdj:	1.00	1.00	1.00	1.00	1.00	1.00	1.00	1.00	1.00	1.00	1.00	1.00
AdjDel/Veh:	40.9	32.4	29.1	56.5	48.1	48.1	57.3	32.5	29.8	43.3	24.4	21.0
LOS by Move:	D	C	C	E	D	D	E	C	C	D	C	C
HCM2k95thQ:	16	18	9	3	10	10	3	13	5	9	20	9

Note: Queue reported is the number of cars per lane.

BART Phase II Extension Project

Level Of Service Computation Report
 2000 HCM Operations (Future Volume Alternative)
 PM - 2025 No Project Conditions

Intersection #3066: AUTUMN/SANTA CLARA

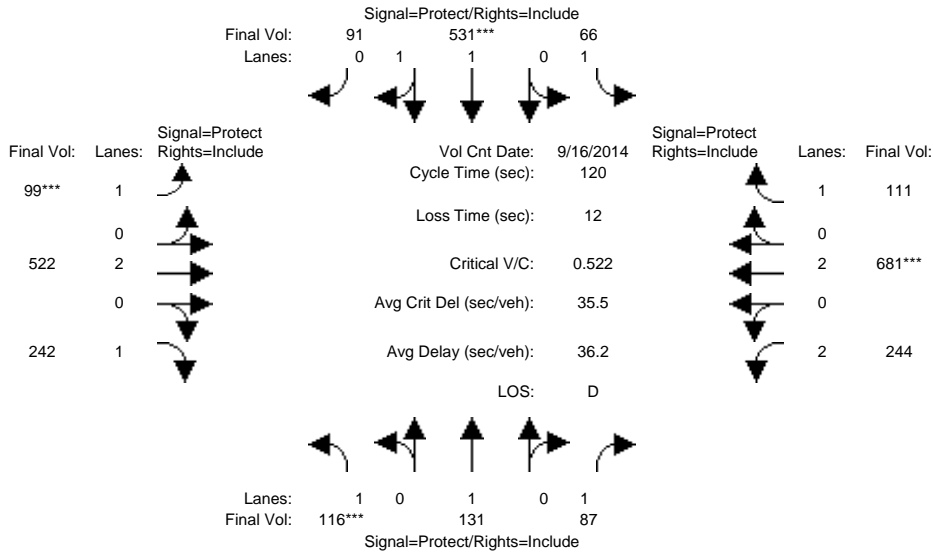

Approach:	North Bound			South Bound			East Bound			West Bound		
	L	T	R	L	T	R	L	T	R	L	T	R
Min. Green:	7	10	10	7	10	10	7	10	10	7	10	10
Y+R:	4.0	4.0	4.0	4.0	4.0	4.0	4.0	4.0	4.0	4.0	4.0	4.0

Volume Module:	>> Count Date: 16 Sep 2014 <<											
Base Vol:	116	131	87	66	531	91	99	522	242	244	681	111
Growth Adj:	1.00	1.00	1.00	1.00	1.00	1.00	1.00	1.00	1.00	1.00	1.00	1.00
Initial Bse:	116	131	87	66	531	91	99	522	242	244	681	111
Added Vol:	0	0	0	0	0	0	0	0	0	0	0	0
PasserByVol:	0	0	0	0	0	0	0	0	0	0	0	0
Initial Fut:	116	131	87	66	531	91	99	522	242	244	681	111
User Adj:	1.00	1.00	1.00	1.00	1.00	1.00	1.00	1.00	1.00	1.00	1.00	1.00
PHF Adj:	1.00	1.00	1.00	1.00	1.00	1.00	1.00	1.00	1.00	1.00	1.00	1.00
PHF Volume:	116	131	87	66	531	91	99	522	242	244	681	111
Reduct Vol:	0	0	0	0	0	0	0	0	0	0	0	0
Reduced Vol:	116	131	87	66	531	91	99	522	242	244	681	111
PCE Adj:	1.00	1.00	1.00	1.00	1.00	1.00	1.00	1.00	1.00	1.00	1.00	1.00
MLF Adj:	1.00	1.00	1.00	1.00	1.00	1.00	1.00	1.00	1.00	1.00	1.00	1.00
FinalVolume:	116	131	87	66	531	91	99	522	242	244	681	111

Saturation Flow Module:												
Sat/Lane:	1900	1900	1900	1900	1900	1900	1900	1900	1900	1900	1900	1900
Adjustment:	0.92	1.00	0.92	0.92	0.98	0.95	0.92	1.00	0.92	0.83	1.00	0.92
Lanes:	1.00	1.00	1.00	1.00	1.70	0.30	1.00	2.00	1.00	2.00	2.00	1.00
Final Sat.:	1750	1900	1750	1750	3158	541	1750	3800	1750	3150	3800	1750

Capacity Analysis Module:												
Vol/Sat:	0.07	0.07	0.05	0.04	0.17	0.17	0.06	0.14	0.14	0.08	0.18	0.06
Crit Moves:	****				****		****			****		
Green Time:	15.2	31.7	31.7	22.2	38.6	38.6	13.0	34.7	34.7	19.4	41.2	41.2
Volume/Cap:	0.52	0.26	0.19	0.20	0.52	0.52	0.52	0.47	0.48	0.48	0.52	0.18
Delay/Veh:	51.2	35.2	34.4	41.8	33.6	33.6	53.2	35.5	35.9	46.4	31.9	27.8
User DelAdj:	1.00	1.00	1.00	1.00	1.00	1.00	1.00	1.00	1.00	1.00	1.00	1.00
AdjDel/Veh:	51.2	35.2	34.4	41.8	33.6	33.6	53.2	35.5	35.9	46.4	31.9	27.8
LOS by Move:	D	D	C	D	C	C	D	D	D	D	C	C
HCM2k95thQ:	8	7	5	4	17	17	7	15	15	9	18	6

Note: Queue reported is the number of cars per lane.

BART Phase II Extension Project

Level Of Service Computation Report
 2000 HCM Operations (Future Volume Alternative)
 AM - 2025 No Project Conditions

Intersection #3077: BIRD/SAN CARLOS

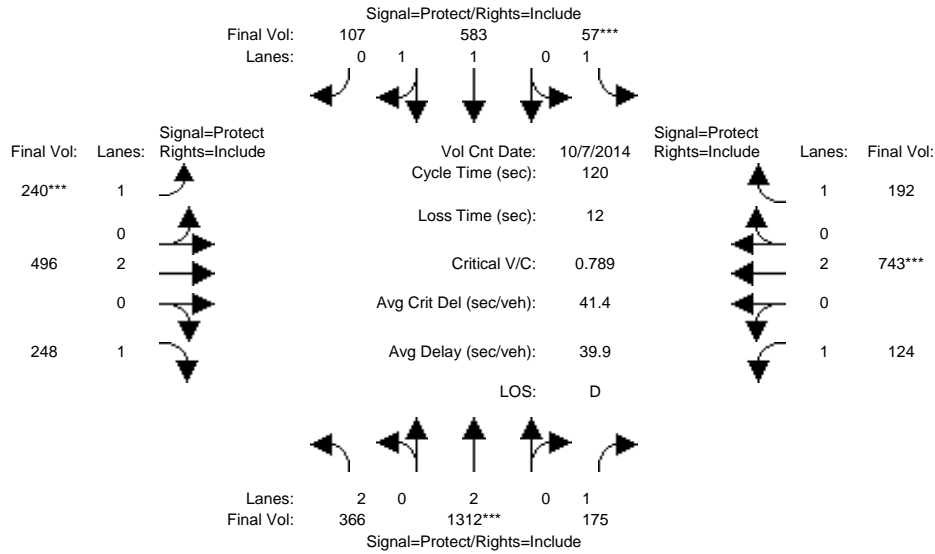

Approach:	North Bound			South Bound			East Bound			West Bound		
	L	T	R	L	T	R	L	T	R	L	T	R
Min. Green:	7	10	10	7	10	10	7	10	10	7	10	10
Y+R:	4.0	4.0	4.0	4.0	4.0	4.0	4.0	4.0	4.0	4.0	4.0	4.0
Volume Module: >> Count Date: 7 Oct 2014 <<												
Base Vol:	366	1312	175	57	583	107	240	496	248	124	743	192
Growth Adj:	1.00	1.00	1.00	1.00	1.00	1.00	1.00	1.00	1.00	1.00	1.00	1.00
Initial Bse:	366	1312	175	57	583	107	240	496	248	124	743	192
Added Vol:	0	0	0	0	0	0	0	0	0	0	0	0
PasserByVol:	0	0	0	0	0	0	0	0	0	0	0	0
Initial Fut:	366	1312	175	57	583	107	240	496	248	124	743	192
User Adj:	1.00	1.00	1.00	1.00	1.00	1.00	1.00	1.00	1.00	1.00	1.00	1.00
PHF Adj:	1.00	1.00	1.00	1.00	1.00	1.00	1.00	1.00	1.00	1.00	1.00	1.00
PHF Volume:	366	1312	175	57	583	107	240	496	248	124	743	192
Reduct Vol:	0	0	0	0	0	0	0	0	0	0	0	0
Reduced Vol:	366	1312	175	57	583	107	240	496	248	124	743	192
PCE Adj:	1.00	1.00	1.00	1.00	1.00	1.00	1.00	1.00	1.00	1.00	1.00	1.00
MLF Adj:	1.00	1.00	1.00	1.00	1.00	1.00	1.00	1.00	1.00	1.00	1.00	1.00
FinalVolume:	366	1312	175	57	583	107	240	496	248	124	743	192
Saturation Flow Module:												
Sat/Lane:	1900	1900	1900	1900	1900	1900	1900	1900	1900	1900	1900	1900
Adjustment:	0.83	1.00	0.92	0.92	0.98	0.95	0.92	1.00	0.92	0.92	1.00	0.92
Lanes:	2.00	2.00	1.00	1.00	1.68	0.32	1.00	2.00	1.00	1.00	2.00	1.00
Final Sat.:	3150	3800	1750	1750	3126	574	1750	3800	1750	1750	3800	1750
Capacity Analysis Module:												
Vol/Sat:	0.12	0.35	0.10	0.03	0.19	0.19	0.14	0.13	0.14	0.07	0.20	0.11
Crit Moves:	****			****			****			****		
Green Time:	22.4	51.4	51.4	7.0	36.0	36.0	20.4	33.0	33.0	16.5	29.1	29.1
Volume/Cap:	0.62	0.81	0.23	0.56	0.62	0.62	0.81	0.47	0.51	0.51	0.81	0.45
Delay/Veh:	46.9	33.0	21.9	61.8	37.2	37.2	62.6	36.6	37.7	49.9	48.0	39.4
User DelAdj:	1.00	1.00	1.00	1.00	1.00	1.00	1.00	1.00	1.00	1.00	1.00	1.00
AdjDel/Veh:	46.9	33.0	21.9	61.8	37.2	37.2	62.6	36.6	37.7	49.9	48.0	39.4
LOS by Move:	D	C	C	E	D	D	E	D	D	D	D	D
HCM2k95thQ:	14	36	8	5	20	20	18	14	15	9	24	12

Note: Queue reported is the number of cars per lane.

BART Phase II Extension Project

Level Of Service Computation Report
 2000 HCM Operations (Future Volume Alternative)
 PM - 2025 No Project Conditions

Intersection #3077: BIRD/SAN CARLOS

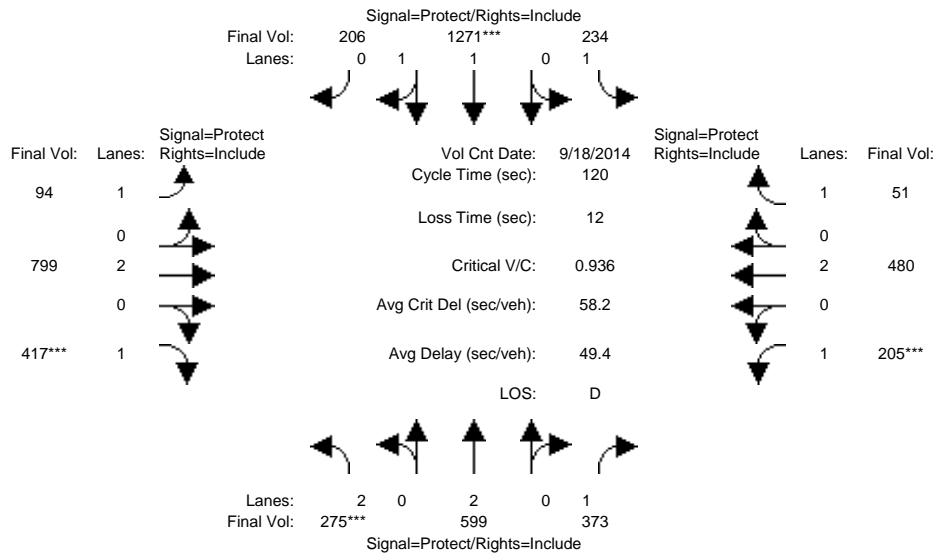

Approach:	North Bound			South Bound			East Bound			West Bound		
	L	T	R	L	T	R	L	T	R	L	T	R
Min. Green:	7	10	10	7	10	10	7	10	10	7	10	10
Y+R:	4.0	4.0	4.0	4.0	4.0	4.0	4.0	4.0	4.0	4.0	4.0	4.0

Volume Module:	>> Count Date: 18 Sep 2014 <<											
Base Vol:	275	599	373	234	1271	206	94	799	417	205	480	51
Growth Adj:	1.00	1.00	1.00	1.00	1.00	1.00	1.00	1.00	1.00	1.00	1.00	1.00
Initial Bse:	275	599	373	234	1271	206	94	799	417	205	480	51
Added Vol:	0	0	0	0	0	0	0	0	0	0	0	0
PasserByVol:	0	0	0	0	0	0	0	0	0	0	0	0
Initial Fut:	275	599	373	234	1271	206	94	799	417	205	480	51
User Adj:	1.00	1.00	1.00	1.00	1.00	1.00	1.00	1.00	1.00	1.00	1.00	1.00
PHF Adj:	1.00	1.00	1.00	1.00	1.00	1.00	1.00	1.00	1.00	1.00	1.00	1.00
PHF Volume:	275	599	373	234	1271	206	94	799	417	205	480	51
Reduct Vol:	0	0	0	0	0	0	0	0	0	0	0	0
Reduced Vol:	275	599	373	234	1271	206	94	799	417	205	480	51
PCE Adj:	1.00	1.00	1.00	1.00	1.00	1.00	1.00	1.00	1.00	1.00	1.00	1.00
MLF Adj:	1.00	1.00	1.00	1.00	1.00	1.00	1.00	1.00	1.00	1.00	1.00	1.00
FinalVolume:	275	599	373	234	1271	206	94	799	417	205	480	51

Saturation Flow Module:												
Sat/Lane:	1900	1900	1900	1900	1900	1900	1900	1900	1900	1900	1900	1900
Adjustment:	0.83	1.00	0.92	0.92	0.98	0.95	0.92	1.00	0.92	0.92	1.00	0.92
Lanes:	2.00	2.00	1.00	1.00	1.71	0.29	1.00	2.00	1.00	1.00	2.00	1.00
Final Sat.:	3150	3800	1750	1750	3184	516	1750	3800	1750	1750	3800	1750

Capacity Analysis Module:												
Vol/Sat:	0.09	0.16	0.21	0.13	0.40	0.40	0.05	0.21	0.24	0.12	0.13	0.03
Crit Moves:	****			****			****		****			
Green Time:	11.2	38.4	38.4	24.1	51.2	51.2	14.4	30.6	30.6	15.0	31.2	31.2
Volume/Cap:	0.94	0.49	0.67	0.67	0.94	0.94	0.45	0.83	0.94	0.94	0.49	0.11
Delay/Veh:	89.8	33.3	38.4	49.1	43.6	43.6	50.6	48.1	70.9	95.0	38.0	34.0
User DelAdj:	1.00	1.00	1.00	1.00	1.00	1.00	1.00	1.00	1.00	1.00	1.00	1.00
AdjDel/Veh:	89.8	33.3	38.4	49.1	43.6	43.6	50.6	48.1	70.9	95.0	38.0	34.0
LOS by Move:	F	C	D	D	D	D	D	D	E	F	D	C
HCM2k95thQ:	14	16	23	16	48	48	7	26	32	18	14	3

Note: Queue reported is the number of cars per lane.

BART Phase II Extension Project

Level Of Service Computation Report
 2000 HCM Operations (Future Volume Alternative)
 AM - 2025 No Project Conditions

Intersection #3112: MONTGOMERY/SANTA CLARA

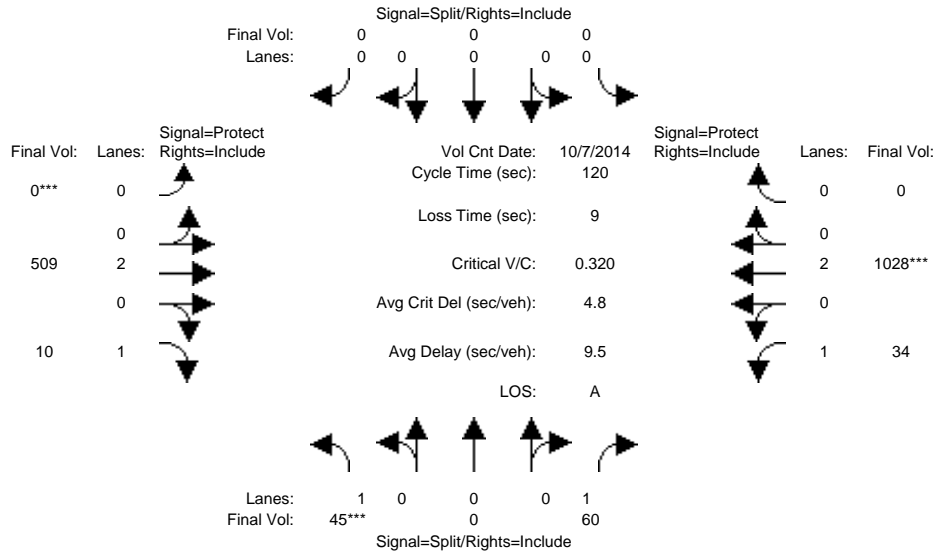

Approach:	North Bound			South Bound			East Bound			West Bound		
	L	T	R	L	T	R	L	T	R	L	T	R
Min. Green:	10	0	10	0	0	0	0	10	10	7	10	0
Y+R:	4.0	4.0	4.0	4.0	4.0	4.0	4.0	4.0	4.0	4.0	4.0	4.0

Volume Module:	>>	Count	Date:	7 Oct 2014	<<							
Base Vol:	45	0	60	0	0	0	0	509	10	34	1028	0
Growth Adj:	1.00	1.00	1.00	1.00	1.00	1.00	1.00	1.00	1.00	1.00	1.00	1.00
Initial Bse:	45	0	60	0	0	0	0	509	10	34	1028	0
Added Vol:	0	0	0	0	0	0	0	0	0	0	0	0
PasserByVol:	0	0	0	0	0	0	0	0	0	0	0	0
Initial Fut:	45	0	60	0	0	0	0	509	10	34	1028	0
User Adj:	1.00	1.00	1.00	1.00	1.00	1.00	1.00	1.00	1.00	1.00	1.00	1.00
PHF Adj:	1.00	1.00	1.00	1.00	1.00	1.00	1.00	1.00	1.00	1.00	1.00	1.00
PHF Volume:	45	0	60	0	0	0	0	509	10	34	1028	0
Reduct Vol:	0	0	0	0	0	0	0	0	0	0	0	0
Reduced Vol:	45	0	60	0	0	0	0	509	10	34	1028	0
PCE Adj:	1.00	1.00	1.00	1.00	1.00	1.00	1.00	1.00	1.00	1.00	1.00	1.00
MLF Adj:	1.00	1.00	1.00	1.00	1.00	1.00	1.00	1.00	1.00	1.00	1.00	1.00
FinalVolume:	45	0	60	0	0	0	0	509	10	34	1028	0

Saturation Flow Module:	Sat/Lane:	1900	1900	1900	1900	1900	1900	1900	1900	1900	1900	1900
Adjustment:	0.92	1.00	0.92	0.92	1.00	0.92	0.92	1.00	0.92	0.92	1.00	0.92
Lanes:	1.00	0.00	1.00	0.00	0.00	0.00	0.00	2.00	1.00	1.00	2.00	0.00
Final Sat.:	1750	0	1750	0	0	0	0	3800	1750	1750	3800	0

Capacity Analysis Module:	Vol/Sat:	0.03	0.00	0.03	0.00	0.00	0.00	0.00	0.13	0.01	0.02	0.27	0.00
Crit Moves:	****								****			****	
Green Time:	12.8	0.0	12.8	0.0	0.0	0.0	0.0	68.4	68.4	29.8	98.2	0.0	
Volume/Cap:	0.24	0.00	0.32	0.00	0.00	0.00	0.00	0.24	0.01	0.08	0.33	0.00	
Delay/Veh:	49.8	0.0	50.5	0.0	0.0	0.0	0.0	12.9	11.2	34.7	2.8	0.0	
User DelAdj:	1.00	1.00	1.00	1.00	1.00	1.00	1.00	1.00	1.00	1.00	1.00	1.00	
AdjDel/Veh:	49.8	0.0	50.5	0.0	0.0	0.0	0.0	12.9	11.2	34.7	2.8	0.0	
LOS by Move:	D	A	D	A	A	A	A	B	B	C	A	A	
HCM2k95thQ:	4	0	5	0	0	0	0	9	0	2	9	0	

Note: Queue reported is the number of cars per lane.

BART Phase II Extension Project

Level Of Service Computation Report
 2000 HCM Operations (Future Volume Alternative)
 PM - 2025 No Project Conditions

Intersection #3112: MONTGOMERY/SANTA CLARA

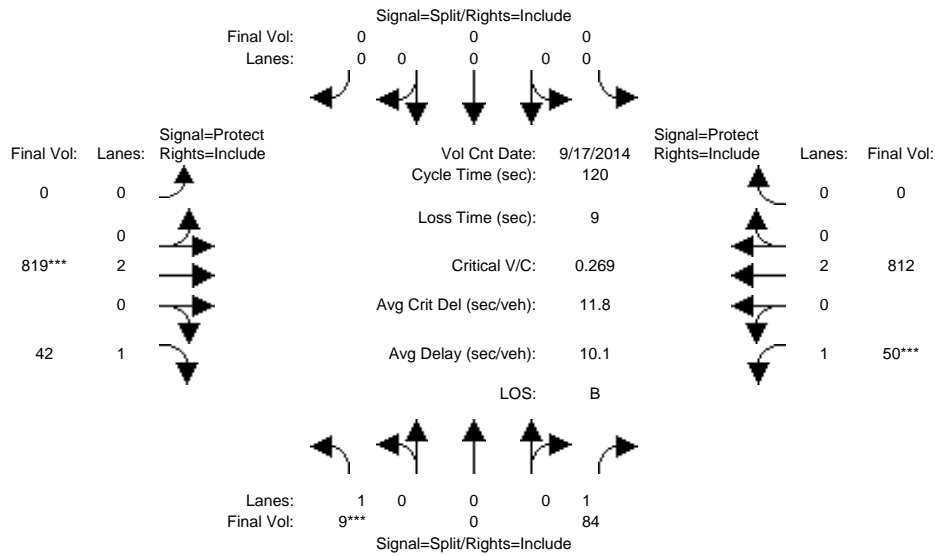

Approach:	North Bound			South Bound			East Bound			West Bound		
	L	T	R	L	T	R	L	T	R	L	T	R
Min. Green:	10	0	10	0	0	0	0	10	10	7	10	0
Y+R:	4.0	4.0	4.0	4.0	4.0	4.0	4.0	4.0	4.0	4.0	4.0	4.0
Volume Module: >> Count Date: 17 Sep 2014 <<												
Base Vol:	9	0	84	0	0	0	0	819	42	50	812	0
Growth Adj:	1.00	1.00	1.00	1.00	1.00	1.00	1.00	1.00	1.00	1.00	1.00	1.00
Initial Bse:	9	0	84	0	0	0	0	819	42	50	812	0
Added Vol:	0	0	0	0	0	0	0	0	0	0	0	0
PasserByVol:	0	0	0	0	0	0	0	0	0	0	0	0
Initial Fut:	9	0	84	0	0	0	0	819	42	50	812	0
User Adj:	1.00	1.00	1.00	1.00	1.00	1.00	1.00	1.00	1.00	1.00	1.00	1.00
PHF Adj:	1.00	1.00	1.00	1.00	1.00	1.00	1.00	1.00	1.00	1.00	1.00	1.00
PHF Volume:	9	0	84	0	0	0	0	819	42	50	812	0
Reduct Vol:	0	0	0	0	0	0	0	0	0	0	0	0
Reduced Vol:	9	0	84	0	0	0	0	819	42	50	812	0
PCE Adj:	1.00	1.00	1.00	1.00	1.00	1.00	1.00	1.00	1.00	1.00	1.00	1.00
MLF Adj:	1.00	1.00	1.00	1.00	1.00	1.00	1.00	1.00	1.00	1.00	1.00	1.00
Final Volume:	9	0	84	0	0	0	0	819	42	50	812	0
Saturation Flow Module:												
Sat/Lane:	1900	1900	1900	1900	1900	1900	1900	1900	1900	1900	1900	1900
Adjustment:	0.92	1.00	0.92	0.92	1.00	0.92	0.92	1.00	0.92	0.92	1.00	0.92
Lanes:	1.00	0.00	1.00	0.00	0.00	0.00	0.00	2.00	1.00	1.00	2.00	0.00
Final Sat.:	1750	0	1750	0	0	0	0	3800	1750	1750	3800	0
Capacity Analysis Module:												
Vol/Sat:	0.01	0.00	0.05	0.00	0.00	0.00	0.00	0.22	0.02	0.03	0.21	0.00
Crit Moves:	****							****		****		
Green Time:	21.4	0.0	21.4	0.0	0.0	0.0	0.0	79.1	79.1	10.5	89.6	0.0
Volume/Cap:	0.03	0.00	0.27	0.00	0.00	0.00	0.00	0.33	0.04	0.33	0.29	0.00
Delay/Veh:	40.8	0.0	43.0	0.0	0.0	0.0	0.0	8.9	7.1	52.7	4.9	0.0
User DelAdj:	1.00	1.00	1.00	1.00	1.00	1.00	1.00	1.00	1.00	1.00	1.00	1.00
AdjDel/Veh:	40.8	0.0	43.0	0.0	0.0	0.0	0.0	8.9	7.1	52.7	4.9	0.0
LOS by Move:	D	A	D	A	A	A	A	A	A	D	A	A
HCM2k95thQ:	1	0	6	0	0	0	0	12	1	4	9	0

Note: Queue reported is the number of cars per lane.

BART Phase II Extension Project

Level Of Service Computation Report
 2000 HCM Operations (Future Volume Alternative)
 AM - 2025 No Project Conditions

Intersection #3227: ALAMEDA/JULIAN

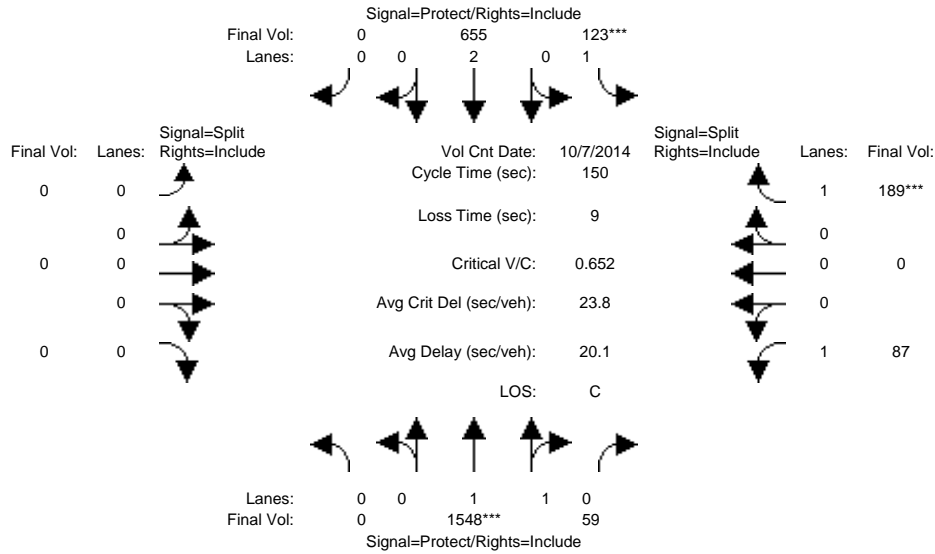

Approach:	North Bound			South Bound			East Bound			West Bound			
	L	T	R	L	T	R	L	T	R	L	T	R	
Min. Green:	0	10	10	7	10	0	0	0	0	10	0	10	
Y+R:	4.0	4.0	4.0	4.0	4.0	4.0	4.0	4.0	4.0	4.0	4.0	4.0	
Volume Module: >> Count Date: 7 Oct 2014 <<													
Base Vol:	0	1548	59	123	655	0	0	0	0	87	0	189	
Growth Adj:	1.00	1.00	1.00	1.00	1.00	1.00	1.00	1.00	1.00	1.00	1.00	1.00	
Initial Bse:	0	1548	59	123	655	0	0	0	0	87	0	189	
Added Vol:	0	0	0	0	0	0	0	0	0	0	0	0	
PasserByVol:	0	0	0	0	0	0	0	0	0	0	0	0	
Initial Fut:	0	1548	59	123	655	0	0	0	0	87	0	189	
User Adj:	1.00	1.00	1.00	1.00	1.00	1.00	1.00	1.00	1.00	1.00	1.00	1.00	
PHF Adj:	1.00	1.00	1.00	1.00	1.00	1.00	1.00	1.00	1.00	1.00	1.00	1.00	
PHF Volume:	0	1548	59	123	655	0	0	0	0	87	0	189	
Reduct Vol:	0	0	0	0	0	0	0	0	0	0	0	0	
Reduced Vol:	0	1548	59	123	655	0	0	0	0	87	0	189	
PCE Adj:	1.00	1.00	1.00	1.00	1.00	1.00	1.00	1.00	1.00	1.00	1.00	1.00	
MLF Adj:	1.00	1.00	1.00	1.00	1.00	1.00	1.00	1.00	1.00	1.00	1.00	1.00	
FinalVolume:	0	1548	59	123	655	0	0	0	0	87	0	189	
Saturation Flow Module:													
Sat/Lane:	1900	1900	1900	1900	1900	1900	1900	1900	1900	1900	1900	1900	
Adjustment:	0.92	0.97	0.95	0.92	1.00	0.92	0.92	1.00	0.92	0.92	1.00	0.92	
Lanes:	0.00	1.92	0.08	1.00	2.00	0.00	0.00	0.00	0.00	1.00	0.00	1.00	
Final Sat.:	0	3564	136	1750	3800	0	0	0	0	1750	0	1750	
Capacity Analysis Module:													
Vol/Sat:	0.00	0.43	0.43	0.07	0.17	0.00	0.00	0.00	0.00	0.05	0.00	0.11	
Crit Moves:	****		****									****	
Green Time:	0.0	xxxx	100.0	16.2	116	0.0	0.0	0.0	0.0	24.9	0.0	24.9	
Volume/Cap:	0.00	0.65	0.65	0.65	0.22	0.00	0.00	0.00	0.00	0.30	0.00	0.65	
Delay/Veh:	0.0	15.4	15.4	72.1	4.7	0.0	0.0	0.0	0.0	55.5	0.0	63.7	
User DelAdj:	1.00	1.00	1.00	1.00	1.00	1.00	1.00	1.00	1.00	1.00	1.00	1.00	
AdjDel/Veh:	0.0	15.4	15.4	72.1	4.7	0.0	0.0	0.0	0.0	55.5	0.0	63.7	
LOS by Move:	A	B	B	E	A	A	A	A	A	E	A	E	
HCM2k95thQ:	0	37	37	12	8	0	0	0	0	7	0	16	

Note: Queue reported is the number of cars per lane.

BART Phase II Extension Project

Level Of Service Computation Report
 2000 HCM Operations (Future Volume Alternative)
 PM - 2025 No Project Conditions

Intersection #3227: ALAMEDA/JULIAN

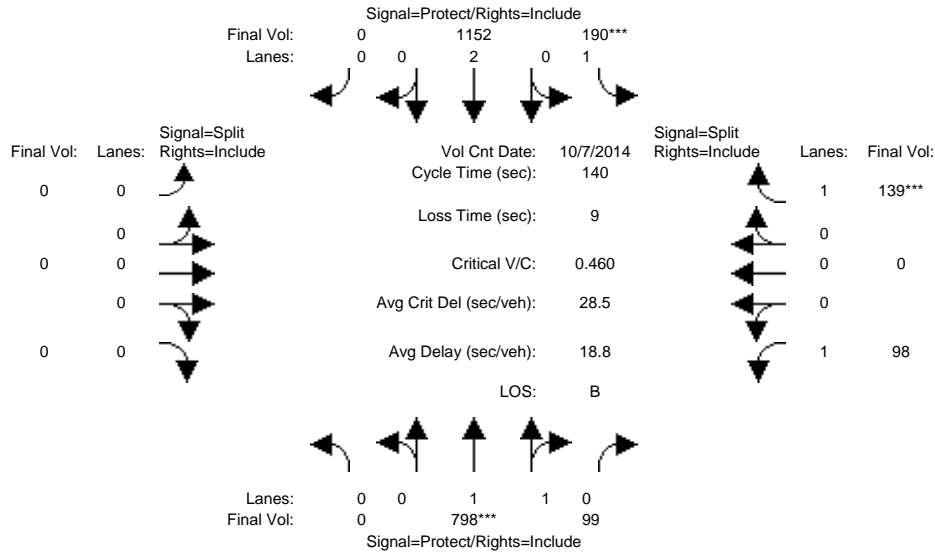

Approach:	North Bound			South Bound			East Bound			West Bound		
	L	T	R	L	T	R	L	T	R	L	T	R
Min. Green:	0	10	10	7	10	0	0	0	0	10	0	10
Y+R:	4.0	4.0	4.0	4.0	4.0	4.0	4.0	4.0	4.0	4.0	4.0	4.0
Volume Module: >> Count Date: 7 Oct 2014 <<												
Base Vol:	0	798	99	190	1152	0	0	0	0	98	0	139
Growth Adj:	1.00	1.00	1.00	1.00	1.00	1.00	1.00	1.00	1.00	1.00	1.00	1.00
Initial Bse:	0	798	99	190	1152	0	0	0	0	98	0	139
Added Vol:	0	0	0	0	0	0	0	0	0	0	0	0
PasserByVol:	0	0	0	0	0	0	0	0	0	0	0	0
Initial Fut:	0	798	99	190	1152	0	0	0	0	98	0	139
User Adj:	1.00	1.00	1.00	1.00	1.00	1.00	1.00	1.00	1.00	1.00	1.00	1.00
PHF Adj:	1.00	1.00	1.00	1.00	1.00	1.00	1.00	1.00	1.00	1.00	1.00	1.00
PHF Volume:	0	798	99	190	1152	0	0	0	0	98	0	139
Reduct Vol:	0	0	0	0	0	0	0	0	0	0	0	0
Reduced Vol:	0	798	99	190	1152	0	0	0	0	98	0	139
PCE Adj:	1.00	1.00	1.00	1.00	1.00	1.00	1.00	1.00	1.00	1.00	1.00	1.00
MLF Adj:	1.00	1.00	1.00	1.00	1.00	1.00	1.00	1.00	1.00	1.00	1.00	1.00
FinalVolume:	0	798	99	190	1152	0	0	0	0	98	0	139
Saturation Flow Module:												
Sat/Lane:	1900	1900	1900	1900	1900	1900	1900	1900	1900	1900	1900	1900
Adjustment:	0.92	0.98	0.95	0.92	1.00	0.92	0.92	1.00	0.92	0.92	1.00	0.92
Lanes:	0.00	1.77	0.23	1.00	2.00	0.00	0.00	0.00	0.00	1.00	0.00	1.00
Final Sat.:	0	3291	408	1750	3800	0	0	0	0	1750	0	1750
Capacity Analysis Module:												
Vol/Sat:	0.00	0.24	0.24	0.11	0.30	0.00	0.00	0.00	0.00	0.06	0.00	0.08
Crit Moves:	****			****						****		
Green Time:	0.0	73.8	73.8	33.0	107	0.0	0.0	0.0	0.0	24.2	0.0	24.2
Volume/Cap:	0.00	0.46	0.46	0.46	0.40	0.00	0.00	0.00	0.00	0.32	0.00	0.46
Delay/Veh:	0.0	20.8	20.8	46.6	5.7	0.0	0.0	0.0	0.0	51.4	0.0	53.2
User DelAdj:	1.00	1.00	1.00	1.00	1.00	1.00	1.00	1.00	1.00	1.00	1.00	1.00
AdjDel/Veh:	0.0	20.8	20.8	46.6	5.7	0.0	0.0	0.0	0.0	51.4	0.0	53.2
LOS by Move:	A	C	C	D	A	A	A	A	A	D	A	D
HCM2k95thQ:	0	21	21	14	16	0	0	0	0	8	0	11

Note: Queue reported is the number of cars per lane.

BART Phase II Extension Project

Level Of Service Computation Report
 2000 HCM Operations (Future Volume Alternative)
 AM - 2025 No Project Conditions

Intersection #3230: ALAMEDA/STOCKTON

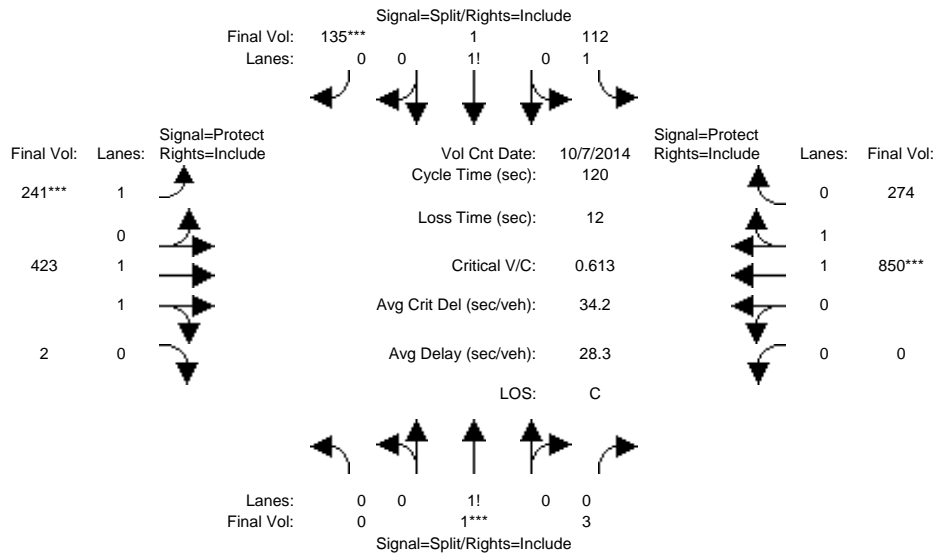

Approach:	North Bound			South Bound			East Bound			West Bound		
	L	T	R	L	T	R	L	T	R	L	T	R
Min. Green:	10	10	10	10	10	10	7	10	10	0	10	10
Y+R:	4.0	4.0	4.0	4.0	4.0	4.0	4.0	4.0	4.0	4.0	4.0	4.0
Volume Module: >> Count Date: 7 Oct 2014 <<												
Base Vol:	0	1	3	112	1	135	241	423	2	0	850	274
Growth Adj:	1.00	1.00	1.00	1.00	1.00	1.00	1.00	1.00	1.00	1.00	1.00	1.00
Initial Bse:	0	1	3	112	1	135	241	423	2	0	850	274
Added Vol:	0	0	0	0	0	0	0	0	0	0	0	0
PasserByVol:	0	0	0	0	0	0	0	0	0	0	0	0
Initial Fut:	0	1	3	112	1	135	241	423	2	0	850	274
User Adj:	1.00	1.00	1.00	1.00	1.00	1.00	1.00	1.00	1.00	1.00	1.00	1.00
PHF Adj:	1.00	1.00	1.00	1.00	1.00	1.00	1.00	1.00	1.00	1.00	1.00	1.00
PHF Volume:	0	1	3	112	1	135	241	423	2	0	850	274
Reduct Vol:	0	0	0	0	0	0	0	0	0	0	0	0
Reduced Vol:	0	1	3	112	1	135	241	423	2	0	850	274
PCE Adj:	1.00	1.00	1.00	1.00	1.00	1.00	1.00	1.00	1.00	1.00	1.00	1.00
MLF Adj:	1.00	1.00	1.00	1.00	1.00	1.00	1.00	1.00	1.00	1.00	1.00	1.00
FinalVolume:	0	1	3	112	1	135	241	423	2	0	850	274
Saturation Flow Module:												
Sat/Lane:	1900	1900	1900	1900	1900	1900	1900	1900	1900	1900	1900	1900
Adjustment:	0.92	0.95	0.95	0.92	0.95	0.95	0.92	0.97	0.95	0.92	0.98	0.95
Lanes:	0.00	0.25	0.75	1.30	0.01	0.69	1.00	1.99	0.01	0.00	1.50	0.50
Final Sat.:	0	450	1350	2271	9	1255	1750	3683	17	0	2797	902
Capacity Analysis Module:												
Vol/Sat:	0.00	0.00	0.00	0.05	0.11	0.11	0.14	0.11	0.11	0.00	0.30	0.30
Crit Moves:	****					****	****			****		
Green Time:	0.0	10.0	10.0	19.2	19.2	19.2	24.6	78.8	78.8	0.0	54.2	54.2
Volume/Cap:	0.00	0.03	0.03	0.31	0.67	0.67	0.67	0.17	0.17	0.00	0.67	0.67
Delay/Veh:	0.0	50.6	50.6	44.8	52.3	52.3	48.9	8.0	8.0	0.0	27.0	27.0
User DelAdj:	1.00	1.00	1.00	1.00	1.00	1.00	1.00	1.00	1.00	1.00	1.00	1.00
AdjDel/Veh:	0.0	50.6	50.6	44.8	52.3	52.3	48.9	8.0	8.0	0.0	27.0	27.0
LOS by Move:	A	D	D	D	D	D	D	A	A	A	C	C
HCM2k95thQ:	0	0	0	6	14	14	17	6	6	0	29	29

Note: Queue reported is the number of cars per lane.

BART Phase II Extension Project

Level Of Service Computation Report
2000 HCM Operations (Future Volume Alternative)
PM - 2025 No Project Conditions

Intersection #3230: ALAMEDA/STOCKTON

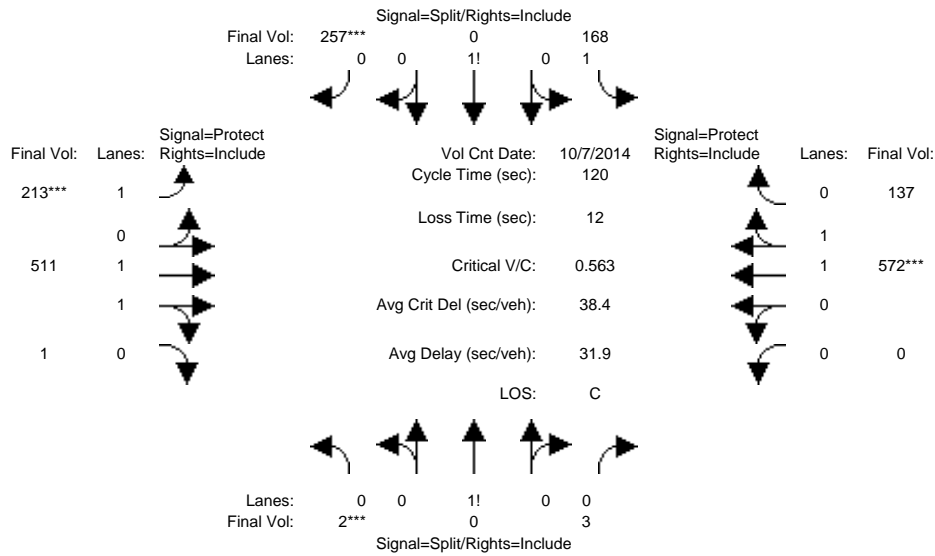

Approach:	North Bound			South Bound			East Bound			West Bound		
	L	T	R	L	T	R	L	T	R	L	T	R
Min. Green:	10	10	10	10	10	10	7	10	10	0	10	10
Y+R:	4.0	4.0	4.0	4.0	4.0	4.0	4.0	4.0	4.0	4.0	4.0	4.0
Volume Module: >> Count Date: 7 Oct 2014 <<												
Base Vol:	2	0	3	168	0	257	213	511	1	0	572	137
Growth Adj:	1.00	1.00	1.00	1.00	1.00	1.00	1.00	1.00	1.00	1.00	1.00	1.00
Initial Bse:	2	0	3	168	0	257	213	511	1	0	572	137
Added Vol:	0	0	0	0	0	0	0	0	0	0	0	0
PasserByVol:	0	0	0	0	0	0	0	0	0	0	0	0
Initial Fut:	2	0	3	168	0	257	213	511	1	0	572	137
User Adj:	1.00	1.00	1.00	1.00	1.00	1.00	1.00	1.00	1.00	1.00	1.00	1.00
PHF Adj:	1.00	1.00	1.00	1.00	1.00	1.00	1.00	1.00	1.00	1.00	1.00	1.00
PHF Volume:	2	0	3	168	0	257	213	511	1	0	572	137
Reduct Vol:	0	0	0	0	0	0	0	0	0	0	0	0
Reduced Vol:	2	0	3	168	0	257	213	511	1	0	572	137
PCE Adj:	1.00	1.00	1.00	1.00	1.00	1.00	1.00	1.00	1.00	1.00	1.00	1.00
MLF Adj:	1.00	1.00	1.00	1.00	1.00	1.00	1.00	1.00	1.00	1.00	1.00	1.00
FinalVolume:	2	0	3	168	0	257	213	511	1	0	572	137
Saturation Flow Module:												
Sat/Lane:	1900	1900	1900	1900	1900	1900	1900	1900	1900	1900	1900	1900
Adjustment:	0.92	0.92	0.92	0.92	1.00	0.95	0.92	0.97	0.95	0.92	0.98	0.95
Lanes:	0.40	0.00	0.60	1.25	0.00	0.75	1.00	1.99	0.01	0.00	1.60	0.40
Final Sat.:	700	0	1050	2190	0	1347	1750	3693	7	0	2985	715
Capacity Analysis Module:												
Vol/Sat:	0.00	0.00	0.00	0.08	0.00	0.19	0.12	0.14	0.14	0.00	0.19	0.19
Crit Moves:	****					****	****				****	
Green Time:	10.0	0.0	10.0	37.1	0.0	37.1	23.7	60.9	60.9	0.0	37.3	37.3
Volume/Cap:	0.03	0.00	0.03	0.25	0.00	0.62	0.62	0.27	0.27	0.00	0.62	0.62
Delay/Veh:	50.7	0.0	50.7	31.1	0.0	37.1	47.4	17.0	17.0	0.0	36.3	36.3
User DelAdj:	1.00	1.00	1.00	1.00	1.00	1.00	1.00	1.00	1.00	1.00	1.00	1.00
AdjDel/Veh:	50.7	0.0	50.7	31.1	0.0	37.1	47.4	17.0	17.0	0.0	36.3	36.3
LOS by Move:	D	A	D	C	A	D	D	B	B	A	D	D
HCM2k95thQ:	0	0	0	8	0	20	15	10	10	0	21	21

Note: Queue reported is the number of cars per lane.

BART Phase II Extension Project

Level Of Service Computation Report
 2000 HCM Operations (Future Volume Alternative)
 AM - 2025 No Project Conditions

Intersection #3263: AUTUMN/JULIAN

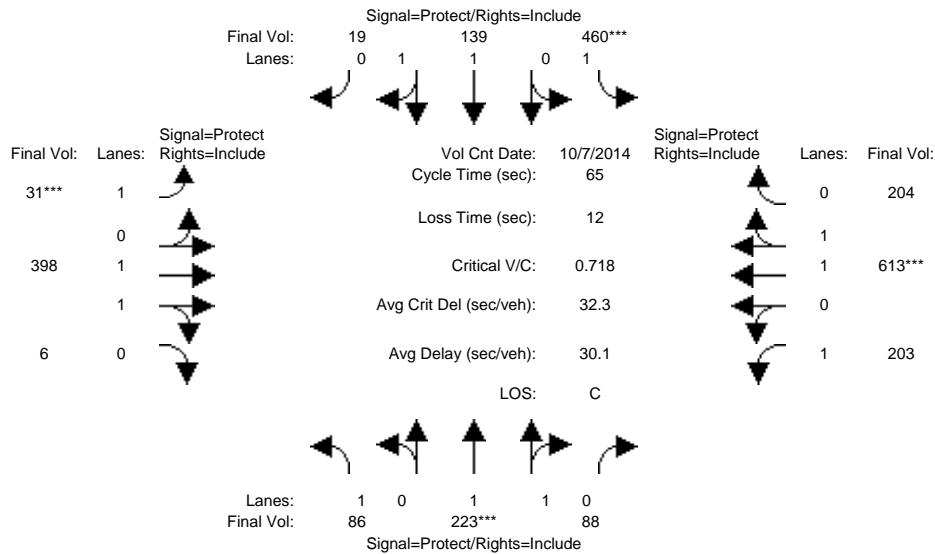

Approach:	North Bound			South Bound			East Bound			West Bound		
	L	T	R	L	T	R	L	T	R	L	T	R
Min. Green:	7	10	10	7	10	10	7	10	10	7	10	10
Y+R:	4.0	4.0	4.0	4.0	4.0	4.0	4.0	4.0	4.0	4.0	4.0	4.0
Volume Module: >> Count Date: 7 Oct 2014 <<												
Base Vol:	86	223	88	460	139	19	31	398	6	203	613	204
Growth Adj:	1.00	1.00	1.00	1.00	1.00	1.00	1.00	1.00	1.00	1.00	1.00	1.00
Initial Bse:	86	223	88	460	139	19	31	398	6	203	613	204
Added Vol:	0	0	0	0	0	0	0	0	0	0	0	0
PasserByVol:	0	0	0	0	0	0	0	0	0	0	0	0
Initial Fut:	86	223	88	460	139	19	31	398	6	203	613	204
User Adj:	1.00	1.00	1.00	1.00	1.00	1.00	1.00	1.00	1.00	1.00	1.00	1.00
PHF Adj:	1.00	1.00	1.00	1.00	1.00	1.00	1.00	1.00	1.00	1.00	1.00	1.00
PHF Volume:	86	223	88	460	139	19	31	398	6	203	613	204
Reduct Vol:	0	0	0	0	0	0	0	0	0	0	0	0
Reduced Vol:	86	223	88	460	139	19	31	398	6	203	613	204
PCE Adj:	1.00	1.00	1.00	1.00	1.00	1.00	1.00	1.00	1.00	1.00	1.00	1.00
MLF Adj:	1.00	1.00	1.00	1.00	1.00	1.00	1.00	1.00	1.00	1.00	1.00	1.00
FinalVolume:	86	223	88	460	139	19	31	398	6	203	613	204
Saturation Flow Module:												
Sat/Lane:	1900	1900	1900	1900	1900	1900	1900	1900	1900	1900	1900	1900
Adjustment:	0.92	0.98	0.95	0.92	0.98	0.95	0.92	0.97	0.95	0.92	0.98	0.95
Lanes:	1.00	1.42	0.58	1.00	1.75	0.25	1.00	1.97	0.03	1.00	1.49	0.51
Final Sat.:	1750	2652	1047	1750	3255	445	1750	3645	55	1750	2775	924
Capacity Analysis Module:												
Vol/Sat:	0.05	0.08	0.08	0.26	0.04	0.04	0.02	0.11	0.11	0.12	0.22	0.22
Crit Moves:	****	****	****	****	****	****	****	****	****	****	****	****
Green Time:	12.2	10.0	10.0	19.6	17.4	17.4	7.0	13.4	13.4	10.1	16.4	16.4
Volume/Cap:	0.26	0.55	0.55	0.87	0.16	0.16	0.16	0.53	0.53	0.75	0.87	0.87
Delay/Veh:	23.0	26.5	26.5	36.4	18.3	18.3	26.8	23.7	23.7	37.2	32.4	32.4
User DelAdj:	1.00	1.00	1.00	1.00	1.00	1.00	1.00	1.00	1.00	1.00	1.00	1.00
AdjDel/Veh:	23.0	26.5	26.5	36.4	18.3	18.3	26.8	23.7	23.7	37.2	32.4	32.4
LOS by Move:	C	C	C	D	B	B	C	C	C	D	C	C
HCM2k95thQ:	3	6	6	23	3	3	1	7	7	9	17	17

Note: Queue reported is the number of cars per lane.

BART Phase II Extension Project

Level Of Service Computation Report
 2000 HCM Operations (Future Volume Alternative)
 PM - 2025 No Project Conditions

Intersection #3263: AUTUMN/JULIAN

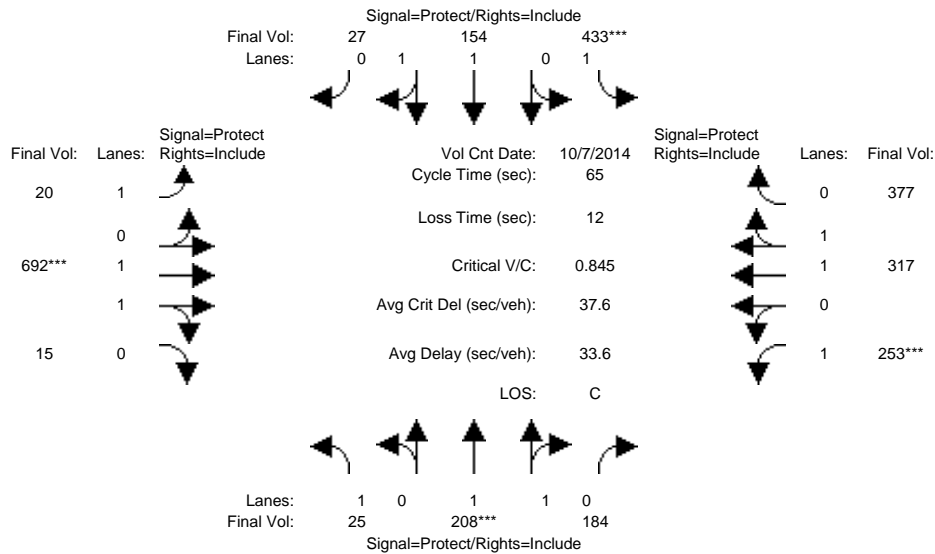

Approach:	North Bound			South Bound			East Bound			West Bound		
	L	T	R	L	T	R	L	T	R	L	T	R
Min. Green:	7	10	10	7	10	10	7	10	10	7	10	10
Y+R:	4.0	4.0	4.0	4.0	4.0	4.0	4.0	4.0	4.0	4.0	4.0	4.0
Volume Module: >> Count Date: 7 Oct 2014 <<												
Base Vol:	25	208	184	433	154	27	20	692	15	253	317	377
Growth Adj:	1.00	1.00	1.00	1.00	1.00	1.00	1.00	1.00	1.00	1.00	1.00	1.00
Initial Bse:	25	208	184	433	154	27	20	692	15	253	317	377
Added Vol:	0	0	0	0	0	0	0	0	0	0	0	0
PasserByVol:	0	0	0	0	0	0	0	0	0	0	0	0
Initial Fut:	25	208	184	433	154	27	20	692	15	253	317	377
User Adj:	1.00	1.00	1.00	1.00	1.00	1.00	1.00	1.00	1.00	1.00	1.00	1.00
PHF Adj:	1.00	1.00	1.00	1.00	1.00	1.00	1.00	1.00	1.00	1.00	1.00	1.00
PHF Volume:	25	208	184	433	154	27	20	692	15	253	317	377
Reduct Vol:	0	0	0	0	0	0	0	0	0	0	0	0
Reduced Vol:	25	208	184	433	154	27	20	692	15	253	317	377
PCE Adj:	1.00	1.00	1.00	1.00	1.00	1.00	1.00	1.00	1.00	1.00	1.00	1.00
MLF Adj:	1.00	1.00	1.00	1.00	1.00	1.00	1.00	1.00	1.00	1.00	1.00	1.00
FinalVolume:	25	208	184	433	154	27	20	692	15	253	317	377
Saturation Flow Module:												
Sat/Lane:	1900	1900	1900	1900	1900	1900	1900	1900	1900	1900	1900	1900
Adjustment:	0.92	1.00	0.95	0.92	0.98	0.95	0.92	0.97	0.95	0.92	1.00	0.92
Lanes:	1.00	1.04	0.96	1.00	1.69	0.31	1.00	1.96	0.04	1.00	1.00	1.00
Final Sat.:	1750	1962	1736	1750	3148	552	1750	3621	78	1750	1900	1750
Capacity Analysis Module:												
Vol/Sat:	0.01	0.11	0.11	0.25	0.05	0.05	0.01	0.19	0.19	0.14	0.17	0.22
Crit Moves:	****			****			****			****		
Green Time:	11.6	10.0	10.0	18.2	16.6	16.6	8.2	14.1	14.1	10.7	16.5	16.5
Volume/Cap:	0.08	0.69	0.69	0.88	0.19	0.19	0.09	0.88	0.88	0.88	0.66	0.85
Delay/Veh:	22.3	29.6	29.6	39.1	19.0	19.0	25.2	35.8	35.8	52.1	23.2	31.4
User DelAdj:	1.00	1.00	1.00	1.00	1.00	1.00	1.00	1.00	1.00	1.00	1.00	1.00
AdjDel/Veh:	22.3	29.6	29.6	39.1	19.0	19.0	25.2	35.8	35.8	52.1	23.2	31.4
LOS by Move:	C	C	C	D	B	B	C	D	D	D	C	C
HCM2k95thQ:	1	8	8	23	3	3	1	15	15	12	11	16

Note: Queue reported is the number of cars per lane.

BART Phase II Extension Project

Level Of Service Computation Report
 2000 HCM Operations (Future Volume Alternative)
 AM - 2025 No Project Conditions

Intersection #3264: AUTUMN/SAN FERNANDO

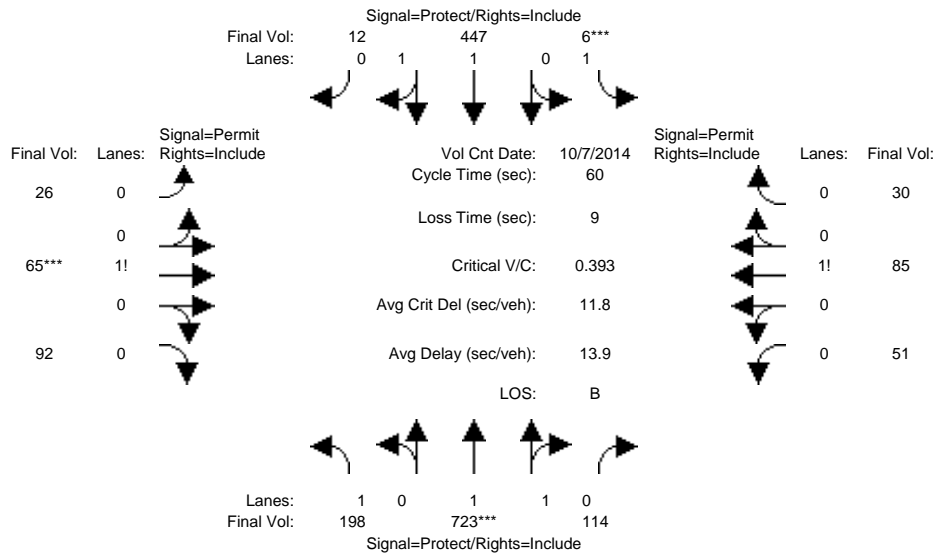

Approach:	North Bound			South Bound			East Bound			West Bound		
	L	T	R	L	T	R	L	T	R	L	T	R
Min. Green:	7	10	10	7	10	10	10	10	10	10	10	10
Y+R:	4.0	4.0	4.0	4.0	4.0	4.0	4.0	4.0	4.0	4.0	4.0	4.0
Volume Module: >> Count Date: 7 Oct 2014 <<												
Base Vol:	198	723	114	6	447	12	26	65	92	51	85	30
Growth Adj:	1.00	1.00	1.00	1.00	1.00	1.00	1.00	1.00	1.00	1.00	1.00	1.00
Initial Bse:	198	723	114	6	447	12	26	65	92	51	85	30
Added Vol:	0	0	0	0	0	0	0	0	0	0	0	0
PasserByVol:	0	0	0	0	0	0	0	0	0	0	0	0
Initial Fut:	198	723	114	6	447	12	26	65	92	51	85	30
User Adj:	1.00	1.00	1.00	1.00	1.00	1.00	1.00	1.00	1.00	1.00	1.00	1.00
PHF Adj:	1.00	1.00	1.00	1.00	1.00	1.00	1.00	1.00	1.00	1.00	1.00	1.00
PHF Volume:	198	723	114	6	447	12	26	65	92	51	85	30
Reduct Vol:	0	0	0	0	0	0	0	0	0	0	0	0
Reduced Vol:	198	723	114	6	447	12	26	65	92	51	85	30
PCE Adj:	1.00	1.00	1.00	1.00	1.00	1.00	1.00	1.00	1.00	1.00	1.00	1.00
MLF Adj:	1.00	1.00	1.00	1.00	1.00	1.00	1.00	1.00	1.00	1.00	1.00	1.00
FinalVolume:	198	723	114	6	447	12	26	65	92	51	85	30
Saturation Flow Module:												
Sat/Lane:	1900	1900	1900	1900	1900	1900	1900	1900	1900	1900	1900	1900
Adjustment:	0.92	0.98	0.95	0.92	0.97	0.95	0.92	0.92	0.92	0.92	0.92	0.92
Lanes:	1.00	1.72	0.28	1.00	1.95	0.05	0.14	0.36	0.50	0.31	0.51	0.18
Final Sat.:	1750	3196	504	1750	3603	97	249	622	880	538	896	316
Capacity Analysis Module:												
Vol/Sat:	0.11	0.23	0.23	0.00	0.12	0.12	0.10	0.10	0.10	0.09	0.09	0.09
Crit Moves:	****			****			****			****		
Green Time:	15.3	30.1	30.1	7.0	21.8	21.8	13.9	13.9	13.9	13.9	13.9	13.9
Volume/Cap:	0.44	0.45	0.45	0.03	0.34	0.34	0.45	0.45	0.45	0.41	0.41	0.41
Delay/Veh:	19.5	9.8	9.8	23.5	14.0	14.0	20.6	20.6	20.6	20.2	20.2	20.2
User DelAdj:	1.00	1.00	1.00	1.00	1.00	1.00	1.00	1.00	1.00	1.00	1.00	1.00
AdjDel/Veh:	19.5	9.8	9.8	23.5	14.0	14.0	20.6	20.6	20.6	20.2	20.2	20.2
LOS by Move:	B	A	A	C	B	B	C	C	C	C	C	C
HCM2k95thQ:	7	10	10	0	7	7	7	7	7	6	6	6

Note: Queue reported is the number of cars per lane.

BART Phase II Extension Project

Level Of Service Computation Report
2000 HCM Operations (Future Volume Alternative)
PM - 2025 No Project Conditions

Intersection #3264: AUTUMN/SAN FERNANDO

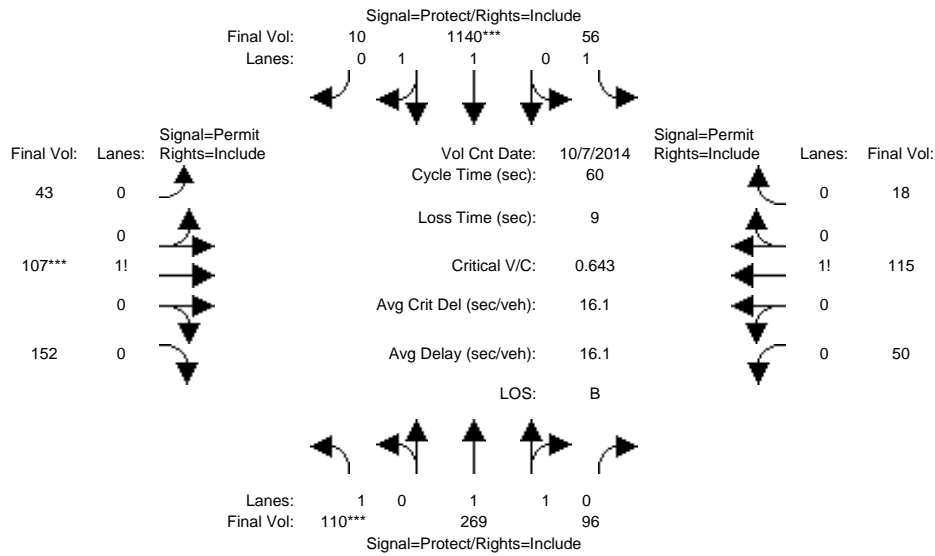

Approach:	North Bound			South Bound			East Bound			West Bound		
	L	T	R	L	T	R	L	T	R	L	T	R
Min. Green:	7	10	10	7	10	10	10	10	10	10	10	10
Y+R:	4.0	4.0	4.0	4.0	4.0	4.0	4.0	4.0	4.0	4.0	4.0	4.0

Volume Module:	>> Count Date: 7 Oct 2014 <<											
Base Vol:	110	269	96	56	1140	10	43	107	152	50	115	18
Growth Adj:	1.00	1.00	1.00	1.00	1.00	1.00	1.00	1.00	1.00	1.00	1.00	1.00
Initial Bse:	110	269	96	56	1140	10	43	107	152	50	115	18
Added Vol:	0	0	0	0	0	0	0	0	0	0	0	0
PasserByVol:	0	0	0	0	0	0	0	0	0	0	0	0
Initial Fut:	110	269	96	56	1140	10	43	107	152	50	115	18
User Adj:	1.00	1.00	1.00	1.00	1.00	1.00	1.00	1.00	1.00	1.00	1.00	1.00
PHF Adj:	1.00	1.00	1.00	1.00	1.00	1.00	1.00	1.00	1.00	1.00	1.00	1.00
PHF Volume:	110	269	96	56	1140	10	43	107	152	50	115	18
Reduct Vol:	0	0	0	0	0	0	0	0	0	0	0	0
Reduced Vol:	110	269	96	56	1140	10	43	107	152	50	115	18
PCE Adj:	1.00	1.00	1.00	1.00	1.00	1.00	1.00	1.00	1.00	1.00	1.00	1.00
MLF Adj:	1.00	1.00	1.00	1.00	1.00	1.00	1.00	1.00	1.00	1.00	1.00	1.00
Final Volume:	110	269	96	56	1140	10	43	107	152	50	115	18

Saturation Flow Module:												
Sat/Lane:	1900	1900	1900	1900	1900	1900	1900	1900	1900	1900	1900	1900
Adjustment:	0.92	0.98	0.95	0.92	0.97	0.95	0.92	0.92	0.92	0.92	0.92	0.92
Lanes:	1.00	1.46	0.54	1.00	1.98	0.02	0.14	0.35	0.51	0.27	0.63	0.10
Final Sat.:	1750	2726	973	1750	3668	32	249	620	881	478	1100	172

Capacity Analysis Module:												
Vol/Sat:	0.06	0.10	0.10	0.03	0.31	0.31	0.17	0.17	0.17	0.10	0.10	0.10
Crit Moves:	****			****			****					
Green Time:	7.0	20.8	20.8	14.5	28.3	28.3	15.7	15.7	15.7	15.7	15.7	15.7
Volume/Cap:	0.54	0.29	0.29	0.13	0.66	0.66	0.66	0.66	0.66	0.40	0.40	0.40
Delay/Veh:	27.8	14.4	14.4	17.9	13.1	13.1	23.3	23.3	23.3	18.8	18.8	18.8
User DelAdj:	1.00	1.00	1.00	1.00	1.00	1.00	1.00	1.00	1.00	1.00	1.00	1.00
AdjDel/Veh:	27.8	14.4	14.4	17.9	13.1	13.1	23.3	23.3	23.3	18.8	18.8	18.8
LOS by Move:	C	B	B	B	B	B	C	C	C	B	B	B
HCM2k95thQ:	4	5	5	2	17	17	13	13	13	6	6	6

Note: Queue reported is the number of cars per lane.

BART Phase II Extension Project

Level Of Service Computation Report
 2000 HCM Operations (Future Volume Alternative)
 AM - 2025 No Project Conditions

Intersection #3266: AUZERAIS/BIRD

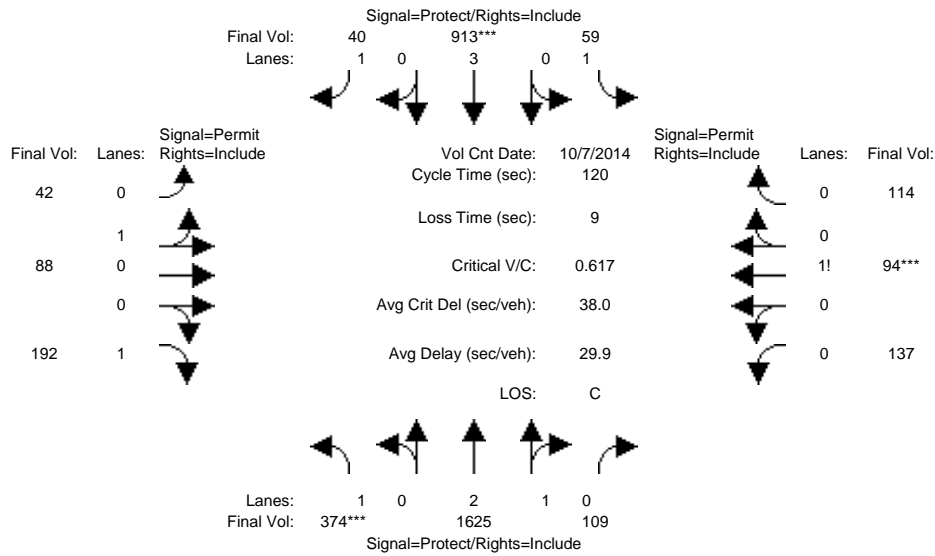

Approach:	North Bound			South Bound			East Bound			West Bound		
Movement:	L	T	R	L	T	R	L	T	R	L	T	R
Min. Green:	7	10	10	7	10	10	10	10	10	10	10	10
Y+R:	4.0	4.0	4.0	4.0	4.0	4.0	4.0	4.0	4.0	4.0	4.0	4.0
Volume Module: >> Count Date: 7 Oct 2014 <<												
Base Vol:	374	1625	109	59	913	40	42	88	192	137	94	114
Growth Adj:	1.00	1.00	1.00	1.00	1.00	1.00	1.00	1.00	1.00	1.00	1.00	1.00
Initial Bse:	374	1625	109	59	913	40	42	88	192	137	94	114
Added Vol:	0	0	0	0	0	0	0	0	0	0	0	0
PasserByVol:	0	0	0	0	0	0	0	0	0	0	0	0
Initial Fut:	374	1625	109	59	913	40	42	88	192	137	94	114
User Adj:	1.00	1.00	1.00	1.00	1.00	1.00	1.00	1.00	1.00	1.00	1.00	1.00
PHF Adj:	1.00	1.00	1.00	1.00	1.00	1.00	1.00	1.00	1.00	1.00	1.00	1.00
PHF Volume:	374	1625	109	59	913	40	42	88	192	137	94	114
Reduct Vol:	0	0	0	0	0	0	0	0	0	0	0	0
Reduced Vol:	374	1625	109	59	913	40	42	88	192	137	94	114
PCE Adj:	1.00	1.00	1.00	1.00	1.00	1.00	1.00	1.00	1.00	1.00	1.00	1.00
MLF Adj:	1.00	1.00	1.00	1.00	1.00	1.00	1.00	1.00	1.00	1.00	1.00	1.00
FinalVolume:	374	1625	109	59	913	40	42	88	192	137	94	114
Saturation Flow Module:												
Sat/Lane:	1900	1900	1900	1900	1900	1900	1900	1900	1900	1900	1900	1900
Adjustment:	0.92	0.98	0.95	0.92	1.00	0.92	0.95	0.95	0.92	0.92	0.92	0.92
Lanes:	1.00	2.80	0.20	1.00	3.00	1.00	0.32	0.68	1.00	0.40	0.27	0.33
Final Sat.:	1750	5248	352	1750	5700	1750	582	1218	1750	695	477	578
Capacity Analysis Module:												
Vol/Sat:	0.21	0.31	0.31	0.03	0.16	0.02	0.07	0.07	0.11	0.20	0.20	0.20
Crit Moves:	****				****						****	
Green Time:	41.5	61.2	61.2	11.5	31.1	31.1	38.3	38.3	38.3	38.3	38.3	38.3
Volume/Cap:	0.62	0.61	0.61	0.35	0.62	0.09	0.23	0.23	0.34	0.62	0.62	0.62
Delay/Veh:	34.6	21.3	21.3	52.0	40.0	33.8	30.2	30.2	31.6	36.7	36.7	36.7
User DelAdj:	1.00	1.00	1.00	1.00	1.00	1.00	1.00	1.00	1.00	1.00	1.00	1.00
AdjDel/Veh:	34.6	21.3	21.3	52.0	40.0	33.8	30.2	30.2	31.6	36.7	36.7	36.7
LOS by Move:	C	C	C	D	D	C	C	C	C	D	D	D
HCM2k95thQ:	22	26	26	4	18	2	7	7	11	21	21	21

Note: Queue reported is the number of cars per lane.

BART Phase II Extension Project

Level Of Service Computation Report
 2000 HCM Operations (Future Volume Alternative)
 PM - 2025 No Project Conditions

Intersection #3266: AUZERAIS/BIRD

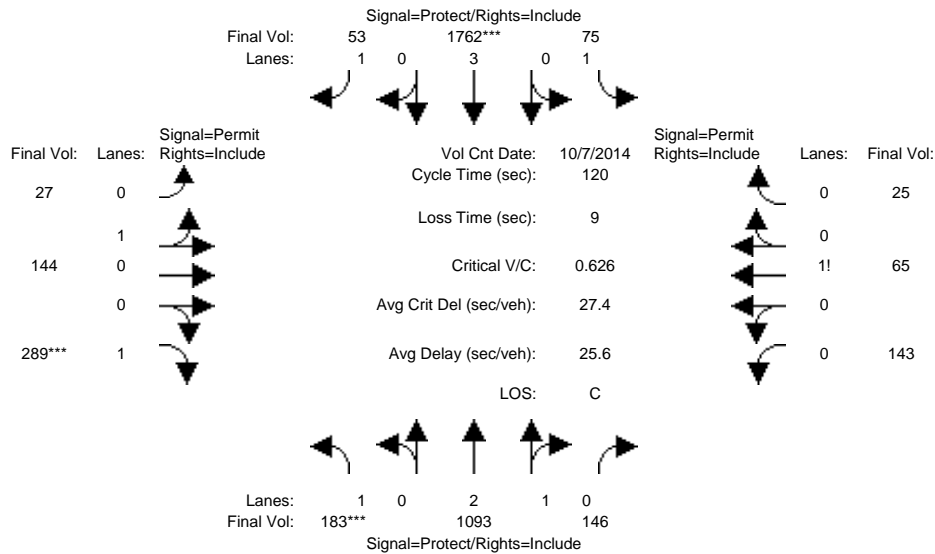

Approach:	North Bound			South Bound			East Bound			West Bound		
	L	T	R	L	T	R	L	T	R	L	T	R
Min. Green:	7	10	10	7	10	10	10	10	10	10	10	10
Y+R:	4.0	4.0	4.0	4.0	4.0	4.0	4.0	4.0	4.0	4.0	4.0	4.0
Volume Module: >> Count Date: 7 Oct 2014 <<												
Base Vol:	183	1093	146	75	1762	53	27	144	289	143	65	25
Growth Adj:	1.00	1.00	1.00	1.00	1.00	1.00	1.00	1.00	1.00	1.00	1.00	1.00
Initial Bse:	183	1093	146	75	1762	53	27	144	289	143	65	25
Added Vol:	0	0	0	0	0	0	0	0	0	0	0	0
PasserByVol:	0	0	0	0	0	0	0	0	0	0	0	0
Initial Fut:	183	1093	146	75	1762	53	27	144	289	143	65	25
User Adj:	1.00	1.00	1.00	1.00	1.00	1.00	1.00	1.00	1.00	1.00	1.00	1.00
PHF Adj:	1.00	1.00	1.00	1.00	1.00	1.00	1.00	1.00	1.00	1.00	1.00	1.00
PHF Volume:	183	1093	146	75	1762	53	27	144	289	143	65	25
Reduct Vol:	0	0	0	0	0	0	0	0	0	0	0	0
Reduced Vol:	183	1093	146	75	1762	53	27	144	289	143	65	25
PCE Adj:	1.00	1.00	1.00	1.00	1.00	1.00	1.00	1.00	1.00	1.00	1.00	1.00
MLF Adj:	1.00	1.00	1.00	1.00	1.00	1.00	1.00	1.00	1.00	1.00	1.00	1.00
FinalVolume:	183	1093	146	75	1762	53	27	144	289	143	65	25
Saturation Flow Module:												
Sat/Lane:	1900	1900	1900	1900	1900	1900	1900	1900	1900	1900	1900	1900
Adjustment:	0.92	0.99	0.95	0.92	1.00	0.92	0.95	0.95	0.92	0.92	0.92	0.92
Lanes:	1.00	2.63	0.37	1.00	3.00	1.00	0.16	0.84	1.00	0.61	0.28	0.11
Final Sat.:	1750	4939	660	1750	5700	1750	284	1516	1750	1074	488	188
Capacity Analysis Module:												
Vol/Sat:	0.10	0.22	0.22	0.04	0.31	0.03	0.10	0.10	0.17	0.13	0.13	0.13
Crit Moves:	****				****				****			
Green Time:	20.1	62.8	62.8	16.5	59.3	59.3	31.7	31.7	31.7	31.7	31.7	31.7
Volume/Cap:	0.63	0.42	0.42	0.31	0.63	0.06	0.36	0.36	0.63	0.50	0.50	0.50
Delay/Veh:	50.7	17.6	17.6	47.3	22.7	15.9	36.4	36.4	41.6	38.4	38.4	38.4
User DelAdj:	1.00	1.00	1.00	1.00	1.00	1.00	1.00	1.00	1.00	1.00	1.00	1.00
AdjDel/Veh:	50.7	17.6	17.6	47.3	22.7	15.9	36.4	36.4	41.6	38.4	38.4	38.4
LOS by Move:	D	B	B	D	C	B	D	D	D	D	D	D
HCM2k95thQ:	13	17	17	5	27	2	10	10	19	15	15	15

Note: Queue reported is the number of cars per lane.

BART Phase II Extension Project

Level Of Service Computation Report
 2000 HCM Operations (Future Volume Alternative)
 AM - 2025 No Project Conditions

Intersection #3363: CAHILL/SANTA CLARA

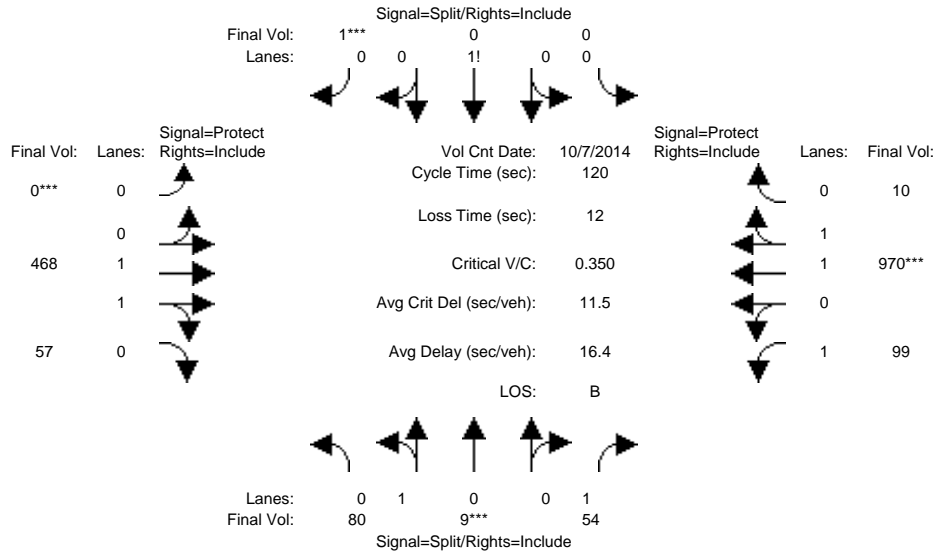

Approach:	North Bound			South Bound			East Bound			West Bound		
Movement:	L	T	R	L	T	R	L	T	R	L	T	R
Min. Green:	10	10	10	10	10	10	7	10	10	7	10	10
Y+R:	4.0	4.0	4.0	4.0	4.0	4.0	4.0	4.0	4.0	4.0	4.0	4.0
Volume Module: >> Count Date: 7 Oct 2014 <<												
Base Vol:	80	9	54	0	0	1	0	468	57	99	970	10
Growth Adj:	1.00	1.00	1.00	1.00	1.00	1.00	1.00	1.00	1.00	1.00	1.00	1.00
Initial Bse:	80	9	54	0	0	1	0	468	57	99	970	10
Added Vol:	0	0	0	0	0	0	0	0	0	0	0	0
PasserByVol:	0	0	0	0	0	0	0	0	0	0	0	0
Initial Fut:	80	9	54	0	0	1	0	468	57	99	970	10
User Adj:	1.00	1.00	1.00	1.00	1.00	1.00	1.00	1.00	1.00	1.00	1.00	1.00
PHF Adj:	1.00	1.00	1.00	1.00	1.00	1.00	1.00	1.00	1.00	1.00	1.00	1.00
PHF Volume:	80	9	54	0	0	1	0	468	57	99	970	10
Reduct Vol:	0	0	0	0	0	0	0	0	0	0	0	0
Reduced Vol:	80	9	54	0	0	1	0	468	57	99	970	10
PCE Adj:	1.00	1.00	1.00	1.00	1.00	1.00	1.00	1.00	1.00	1.00	1.00	1.00
MLF Adj:	1.00	1.00	1.00	1.00	1.00	1.00	1.00	1.00	1.00	1.00	1.00	1.00
Final Volume:	80	9	54	0	0	1	0	468	57	99	970	10
Saturation Flow Module:												
Sat/Lane:	1900	1900	1900	1900	1900	1900	1900	1900	1900	1900	1900	1900
Adjustment:	0.95	0.95	0.92	0.92	1.00	0.92	0.92	0.98	0.95	0.92	0.97	0.95
Lanes:	0.90	0.10	1.00	0.00	0.00	1.00	0.00	1.78	0.22	1.00	1.98	0.02
Final Sat.:	1618	182	1750	0	0	1750	0	3298	402	1750	3662	38
Capacity Analysis Module:												
Vol/Sat:	0.05	0.05	0.03	0.00	0.00	0.00	0.00	0.14	0.14	0.06	0.26	0.26
Crit Moves:	****			****			****			****		
Green Time:	15.4	15.4	15.4	0.0	0.0	10.0	0.0	58.5	58.5	24.1	82.6	82.6
Volume/Cap:	0.38	0.38	0.24	0.00	0.00	0.01	0.00	0.29	0.29	0.28	0.38	0.38
Delay/Veh:	49.0	49.0	47.6	0.0	0.0	50.5	0.0	18.4	18.4	41.1	8.0	8.0
User DelAdj:	1.00	1.00	1.00	1.00	1.00	1.00	1.00	1.00	1.00	1.00	1.00	1.00
AdjDel/Veh:	49.0	49.0	47.6	0.0	0.0	50.5	0.0	18.4	18.4	41.1	8.0	8.0
LOS by Move:	D	D	D	A	A	D	A	B	B	D	A	A
HCM2k95thQ:	7	7	4	0	0	0	0	11	11	6	15	15

Note: Queue reported is the number of cars per lane.

BART Phase II Extension Project

Level Of Service Computation Report
 2000 HCM Operations (Future Volume Alternative)
 PM - 2025 No Project Conditions

Intersection #3363: CAHILL/SANTA CLARA

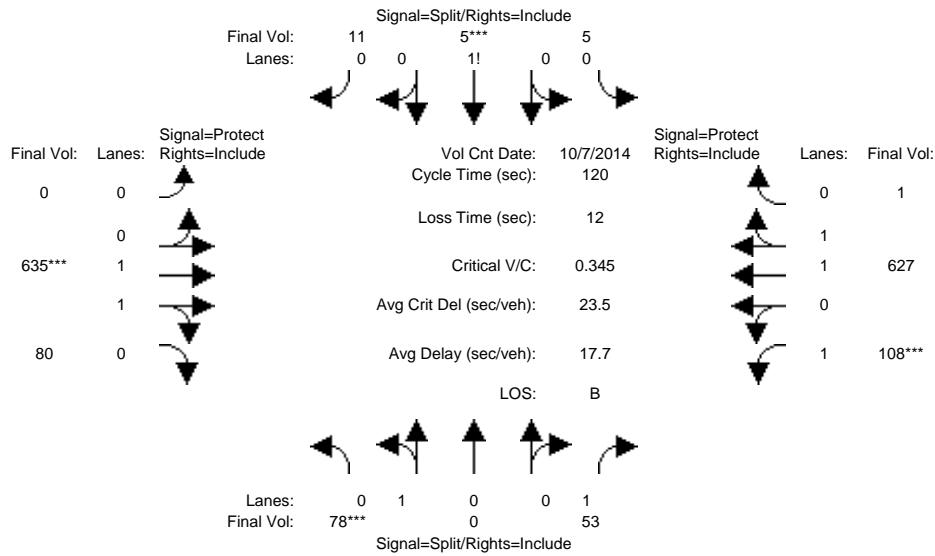

Approach:	North Bound			South Bound			East Bound			West Bound		
	L	T	R	L	T	R	L	T	R	L	T	R
Min. Green:	10	10	10	10	10	10	7	10	10	7	10	10
Y+R:	4.0	4.0	4.0	4.0	4.0	4.0	4.0	4.0	4.0	4.0	4.0	4.0
Volume Module: >> Count Date: 7 Oct 2014 <<												
Base Vol:	78	0	53	5	5	11	0	635	80	108	627	1
Growth Adj:	1.00	1.00	1.00	1.00	1.00	1.00	1.00	1.00	1.00	1.00	1.00	1.00
Initial Bse:	78	0	53	5	5	11	0	635	80	108	627	1
Added Vol:	0	0	0	0	0	0	0	0	0	0	0	0
PasserByVol:	0	0	0	0	0	0	0	0	0	0	0	0
Initial Fut:	78	0	53	5	5	11	0	635	80	108	627	1
User Adj:	1.00	1.00	1.00	1.00	1.00	1.00	1.00	1.00	1.00	1.00	1.00	1.00
PHF Adj:	1.00	1.00	1.00	1.00	1.00	1.00	1.00	1.00	1.00	1.00	1.00	1.00
PHF Volume:	78	0	53	5	5	11	0	635	80	108	627	1
Reduct Vol:	0	0	0	0	0	0	0	0	0	0	0	0
Reduced Vol:	78	0	53	5	5	11	0	635	80	108	627	1
PCE Adj:	1.00	1.00	1.00	1.00	1.00	1.00	1.00	1.00	1.00	1.00	1.00	1.00
MLF Adj:	1.00	1.00	1.00	1.00	1.00	1.00	1.00	1.00	1.00	1.00	1.00	1.00
FinalVolume:	78	0	53	5	5	11	0	635	80	108	627	1
Saturation Flow Module:												
Sat/Lane:	1900	1900	1900	1900	1900	1900	1900	1900	1900	1900	1900	1900
Adjustment:	0.95	0.95	0.92	0.92	0.92	0.92	0.92	0.98	0.95	0.92	0.97	0.95
Lanes:	1.00	0.00	1.00	0.24	0.24	0.52	0.00	1.77	0.23	1.00	1.99	0.01
Final Sat.:	1800	0	1750	417	417	917	0	3286	414	1750	3694	6
Capacity Analysis Module:												
Vol/Sat:	0.04	0.00	0.03	0.01	0.01	0.01	0.00	0.19	0.19	0.06	0.17	0.17
Crit Moves:	****			****			****			****		
Green Time:	14.2	0.0	14.2	10.0	10.0	10.0	0.0	63.5	63.5	20.3	83.8	83.8
Volume/Cap:	0.37	0.00	0.26	0.14	0.14	0.14	0.00	0.37	0.37	0.37	0.24	0.24
Delay/Veh:	49.8	0.0	48.7	51.5	51.5	51.5	0.0	16.6	16.6	44.9	6.6	6.6
User DelAdj:	1.00	1.00	1.00	1.00	1.00	1.00	1.00	1.00	1.00	1.00	1.00	1.00
AdjDel/Veh:	49.8	0.0	48.7	51.5	51.5	51.5	0.0	16.6	16.6	44.9	6.6	6.6
LOS by Move:	D	A	D	D	D	D	A	B	B	D	A	A
HCM2k95thQ:	6	0	4	2	2	2	0	14	14	7	8	8

Note: Queue reported is the number of cars per lane.

BART Phase II Extension Project

Level Of Service Computation Report
2000 HCM Operations (Future Volume Alternative)
AM - 2025 No Project Conditions

Intersection #3445: DELMAS/PARK *

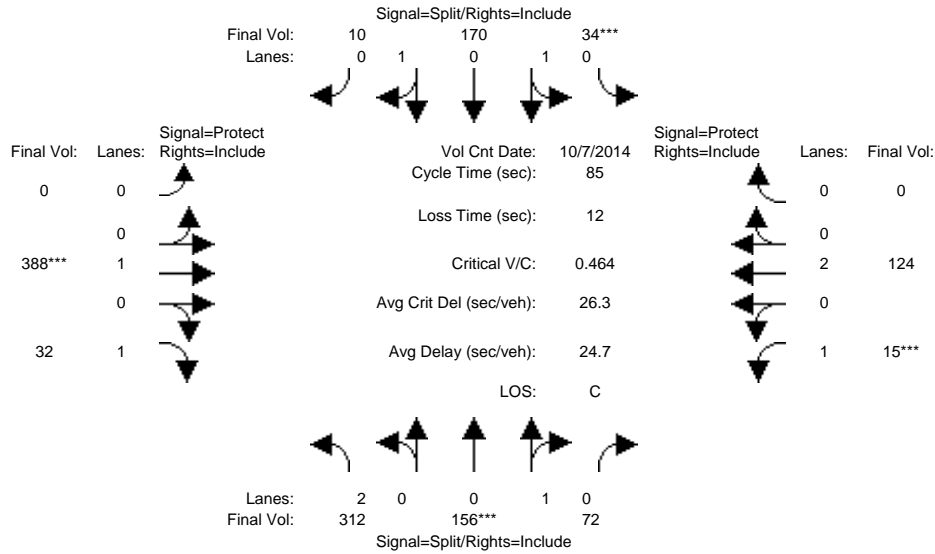

Approach:	North Bound			South Bound			East Bound			West Bound		
Movement:	L	T	R	L	T	R	L	T	R	L	T	R
Min. Green:	10	10	10	10	10	10	0	10	10	7	10	0
Y+R:	4.0	4.0	4.0	4.0	4.0	4.0	4.0	4.0	4.0	4.0	4.0	4.0
Volume Module: >> Count Date: 7 Oct 2014 <<												
Base Vol:	312	156	72	34	170	10	0	388	32	15	124	0
Growth Adj:	1.00	1.00	1.00	1.00	1.00	1.00	1.00	1.00	1.00	1.00	1.00	1.00
Initial Bse:	312	156	72	34	170	10	0	388	32	15	124	0
Added Vol:	0	0	0	0	0	0	0	0	0	0	0	0
PasserByVol:	0	0	0	0	0	0	0	0	0	0	0	0
Initial Fut:	312	156	72	34	170	10	0	388	32	15	124	0
User Adj:	1.00	1.00	1.00	1.00	1.00	1.00	1.00	1.00	1.00	1.00	1.00	1.00
PHF Adj:	1.00	1.00	1.00	1.00	1.00	1.00	1.00	1.00	1.00	1.00	1.00	1.00
PHF Volume:	312	156	72	34	170	10	0	388	32	15	124	0
Reduct Vol:	0	0	0	0	0	0	0	0	0	0	0	0
Reduced Vol:	312	156	72	34	170	10	0	388	32	15	124	0
PCE Adj:	1.00	1.00	1.00	1.00	1.00	1.00	1.00	1.00	1.00	1.00	1.00	1.00
MLF Adj:	1.00	1.00	1.00	1.00	1.00	1.00	1.00	1.00	1.00	1.00	1.00	1.00
Final Volume:	312	156	72	34	170	10	0	388	32	15	124	0
Saturation Flow Module:												
Sat/Lane:	1900	1900	1900	1900	1900	1900	1900	1900	1900	1900	1900	1900
Adjustment:	0.83	0.95	0.95	0.95	0.95	0.95	0.92	1.00	0.92	0.92	1.00	0.92
Lanes:	2.00	0.68	0.32	0.32	1.59	0.09	0.00	1.00	1.00	1.00	2.00	0.00
Final Sat.:	3150	1232	568	572	2860	168	0	1900	1750	1750	3800	0
Capacity Analysis Module:												
Vol/Sat:	0.10	0.13	0.13	0.06	0.06	0.06	0.00	0.20	0.02	0.01	0.03	0.00
Crit Moves:	****			****			****			****		
Green Time:	21.4	21.4	21.4	10.1	10.1	10.1	0.0	34.5	34.5	7.0	41.5	0.0
Volume/Cap:	0.39	0.50	0.50	0.50	0.50	0.50	0.00	0.50	0.05	0.10	0.07	0.00
Delay/Veh:	26.7	28.1	28.1	36.1	36.1	36.1	0.0	19.4	15.3	36.4	11.5	0.0
User DelAdj:	1.00	1.00	1.00	1.00	1.00	1.00	1.00	1.00	1.00	1.00	1.00	1.00
AdjDel/Veh:	26.7	28.1	28.1	36.1	36.1	36.1	0.0	19.4	15.3	36.4	11.5	0.0
LOS by Move:	C	C	C	D	D	D	A	B	B	D	B	A
HCM2k95thQ:	9	11	11	6	6	6	0	14	1	1	2	0

Note: Queue reported is the number of cars per lane.

BART Phase II Extension Project

Level Of Service Computation Report
 2000 HCM Operations (Future Volume Alternative)
 PM - 2025 No Project Conditions

Intersection #3445: DELMAS/PARK *

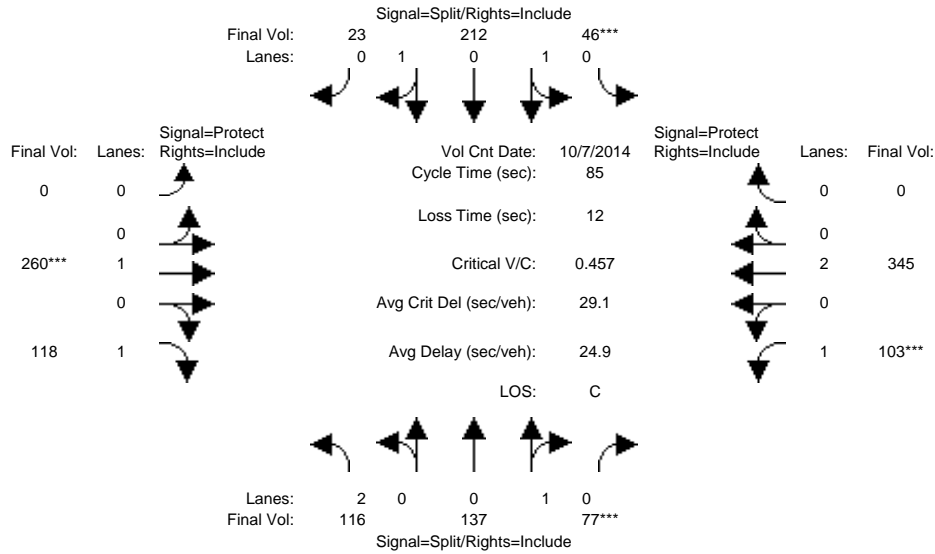

Approach:	North Bound			South Bound			East Bound			West Bound		
	L	T	R	L	T	R	L	T	R	L	T	R
Min. Green:	10	10	10	10	10	10	0	10	10	7	10	0
Y+R:	4.0	4.0	4.0	4.0	4.0	4.0	4.0	4.0	4.0	4.0	4.0	4.0
Volume Module: >> Count Date: 7 Oct 2014 <<												
Base Vol:	116	137	77	46	212	23	0	260	118	103	345	0
Growth Adj:	1.00	1.00	1.00	1.00	1.00	1.00	1.00	1.00	1.00	1.00	1.00	1.00
Initial Bse:	116	137	77	46	212	23	0	260	118	103	345	0
Added Vol:	0	0	0	0	0	0	0	0	0	0	0	0
PasserByVol:	0	0	0	0	0	0	0	0	0	0	0	0
Initial Fut:	116	137	77	46	212	23	0	260	118	103	345	0
User Adj:	1.00	1.00	1.00	1.00	1.00	1.00	1.00	1.00	1.00	1.00	1.00	1.00
PHF Adj:	1.00	1.00	1.00	1.00	1.00	1.00	1.00	1.00	1.00	1.00	1.00	1.00
PHF Volume:	116	137	77	46	212	23	0	260	118	103	345	0
Reduct Vol:	0	0	0	0	0	0	0	0	0	0	0	0
Reduced Vol:	116	137	77	46	212	23	0	260	118	103	345	0
PCE Adj:	1.00	1.00	1.00	1.00	1.00	1.00	1.00	1.00	1.00	1.00	1.00	1.00
MLF Adj:	1.00	1.00	1.00	1.00	1.00	1.00	1.00	1.00	1.00	1.00	1.00	1.00
FinalVolume:	116	137	77	46	212	23	0	260	118	103	345	0
Saturation Flow Module:												
Sat/Lane:	1900	1900	1900	1900	1900	1900	1900	1900	1900	1900	1900	1900
Adjustment:	0.83	0.95	0.95	0.95	0.95	0.95	0.92	1.00	0.92	0.92	1.00	0.92
Lanes:	2.00	0.64	0.36	0.33	1.51	0.16	0.00	1.00	1.00	1.00	2.00	0.00
Final Sat.:	3150	1152	648	589	2716	295	0	1900	1750	1750	3800	0
Capacity Analysis Module:												
Vol/Sat:	0.04	0.12	0.12	0.08	0.08	0.08	0.00	0.14	0.07	0.06	0.09	0.00
Crit Moves:			****	****				****		****		
Green Time:	22.1	22.1	22.1	14.5	14.5	14.5	0.0	25.4	25.4	10.9	36.4	0.0
Volume/Cap:	0.14	0.46	0.46	0.46	0.46	0.46	0.00	0.46	0.23	0.46	0.21	0.00
Delay/Veh:	24.2	27.1	27.1	32.2	32.2	32.2	0.0	24.8	22.6	35.8	15.4	0.0
User DelAdj:	1.00	1.00	1.00	1.00	1.00	1.00	1.00	1.00	1.00	1.00	1.00	1.00
AdjDel/Veh:	24.2	27.1	27.1	32.2	32.2	32.2	0.0	24.8	22.6	35.8	15.4	0.0
LOS by Move:	C	C	C	C	C	C	A	C	C	D	B	A
HCM2k95thQ:	3	10	10	7	7	7	0	10	5	5	5	0

Note: Queue reported is the number of cars per lane.

BART Phase II Extension Project

Level Of Service Computation Report
2000 HCM Operations (Future Volume Alternative)
AM - 2025 No Project Conditions

Intersection #3552: FRUITDALE/MERIDIAN

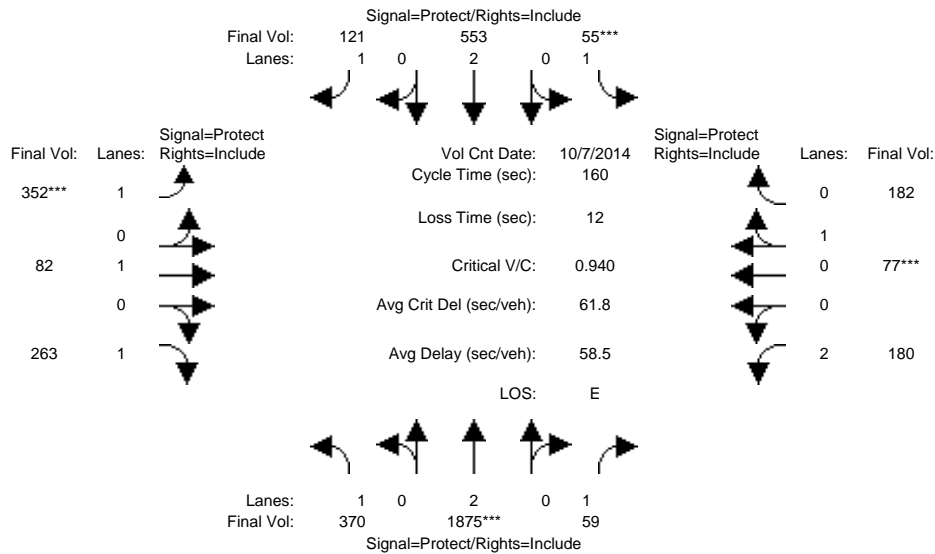

Approach:	North Bound			South Bound			East Bound			West Bound		
Movement:	L	T	R	L	T	R	L	T	R	L	T	R
Min. Green:	7	10	10	7	10	10	7	10	10	7	10	10
Y+R:	4.0	4.0	4.0	4.0	4.0	4.0	4.0	4.0	4.0	4.0	4.0	4.0
Volume Module: >> Count Date: 7 Oct 2014 <<												
Base Vol:	370	1875	59	55	553	121	352	82	263	180	77	182
Growth Adj:	1.00	1.00	1.00	1.00	1.00	1.00	1.00	1.00	1.00	1.00	1.00	1.00
Initial Bse:	370	1875	59	55	553	121	352	82	263	180	77	182
Added Vol:	0	0	0	0	0	0	0	0	0	0	0	0
PasserByVol:	0	0	0	0	0	0	0	0	0	0	0	0
Initial Fut:	370	1875	59	55	553	121	352	82	263	180	77	182
User Adj:	1.00	1.00	1.00	1.00	1.00	1.00	1.00	1.00	1.00	1.00	1.00	1.00
PHF Adj:	1.00	1.00	1.00	1.00	1.00	1.00	1.00	1.00	1.00	1.00	1.00	1.00
PHF Volume:	370	1875	59	55	553	121	352	82	263	180	77	182
Reduct Vol:	0	0	0	0	0	0	0	0	0	0	0	0
Reduced Vol:	370	1875	59	55	553	121	352	82	263	180	77	182
PCE Adj:	1.00	1.00	1.00	1.00	1.00	1.00	1.00	1.00	1.00	1.00	1.00	1.00
MLF Adj:	1.00	1.00	1.00	1.00	1.00	1.00	1.00	1.00	1.00	1.00	1.00	1.00
FinalVolume:	370	1875	59	55	553	121	352	82	263	180	77	182
Saturation Flow Module:												
Sat/Lane:	1900	1900	1900	1900	1900	1900	1900	1900	1900	1900	1900	1900
Adjustment:	0.92	1.00	0.92	0.92	1.00	0.92	0.92	1.00	0.92	0.83	0.95	0.95
Lanes:	1.00	2.00	1.00	1.00	2.00	1.00	1.00	1.00	1.00	2.00	0.30	0.70
Final Sat.:	1750	3800	1750	1750	3800	1750	1750	1900	1750	3150	535	1265
Capacity Analysis Module:												
Vol/Sat:	0.21	0.49	0.03	0.03	0.15	0.07	0.20	0.04	0.15	0.06	0.14	0.14
Crit Moves:	****			****			****			****		
Green Time:	53.3	83.0	83.0	7.0	36.7	36.7	33.8	42.0	42.0	16.0	24.2	24.2
Volume/Cap:	0.63	0.95	0.07	0.72	0.63	0.30	0.95	0.16	0.57	0.57	0.95	0.95
Delay/Veh:	47.4	47.6	19.2	103.3	57.2	51.5	96.5	45.6	52.9	71.3	109	108.6
User DelAdj:	1.00	1.00	1.00	1.00	1.00	1.00	1.00	1.00	1.00	1.00	1.00	1.00
AdjDel/Veh:	47.4	47.6	19.2	103.3	57.2	51.5	96.5	45.6	52.9	71.3	109	108.6
LOS by Move:	D	D	B	F	E	D	F	D	D	E	F	F
HCM2k95thQ:	29	74	3	6	22	10	35	6	21	11	30	30

Note: Queue reported is the number of cars per lane.

BART Phase II Extension Project

Level Of Service Computation Report
2000 HCM Operations (Future Volume Alternative)
PM - 2025 No Project Conditions

Intersection #3552: FRUITDALE/MERIDIAN

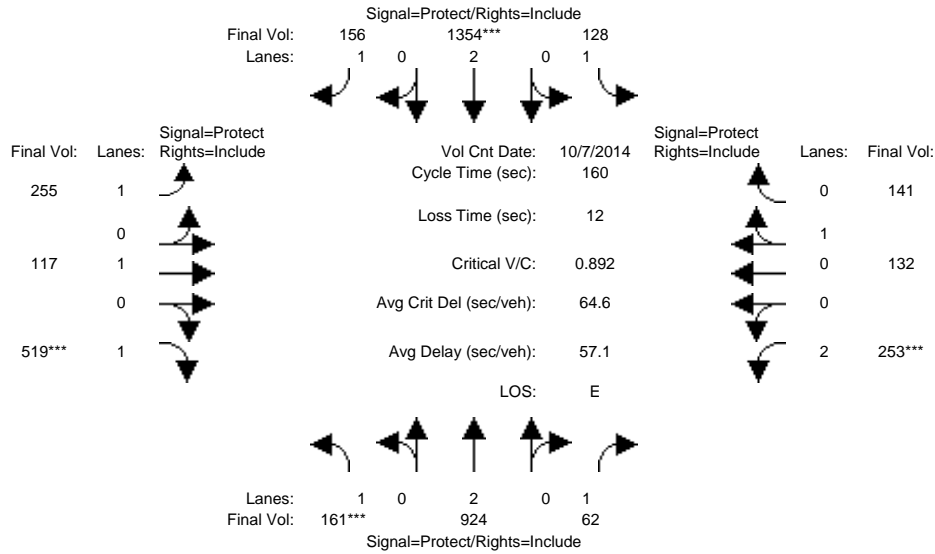

Approach:	North Bound			South Bound			East Bound			West Bound		
	L	T	R	L	T	R	L	T	R	L	T	R
Min. Green:	7	10	10	7	10	10	7	10	10	7	10	10
Y+R:	4.0	4.0	4.0	4.0	4.0	4.0	4.0	4.0	4.0	4.0	4.0	4.0

Volume Module:	>> Count Date: 7 Oct 2014 <<											
Base Vol:	161	924	62	128	1354	156	255	117	519	253	132	141
Growth Adj:	1.00	1.00	1.00	1.00	1.00	1.00	1.00	1.00	1.00	1.00	1.00	1.00
Initial Bse:	161	924	62	128	1354	156	255	117	519	253	132	141
Added Vol:	0	0	0	0	0	0	0	0	0	0	0	0
PasserByVol:	0	0	0	0	0	0	0	0	0	0	0	0
Initial Fut:	161	924	62	128	1354	156	255	117	519	253	132	141
User Adj:	1.00	1.00	1.00	1.00	1.00	1.00	1.00	1.00	1.00	1.00	1.00	1.00
PHF Adj:	1.00	1.00	1.00	1.00	1.00	1.00	1.00	1.00	1.00	1.00	1.00	1.00
PHF Volume:	161	924	62	128	1354	156	255	117	519	253	132	141
Reduct Vol:	0	0	0	0	0	0	0	0	0	0	0	0
Reduced Vol:	161	924	62	128	1354	156	255	117	519	253	132	141
PCE Adj:	1.00	1.00	1.00	1.00	1.00	1.00	1.00	1.00	1.00	1.00	1.00	1.00
MLF Adj:	1.00	1.00	1.00	1.00	1.00	1.00	1.00	1.00	1.00	1.00	1.00	1.00
FinalVolume:	161	924	62	128	1354	156	255	117	519	253	132	141

Saturation Flow Module:												
Sat/Lane:	1900	1900	1900	1900	1900	1900	1900	1900	1900	1900	1900	1900
Adjustment:	0.92	1.00	0.92	0.92	1.00	0.92	0.92	1.00	0.92	0.83	0.95	0.95
Lanes:	1.00	2.00	1.00	1.00	2.00	1.00	1.00	1.00	1.00	2.00	0.48	0.52
Final Sat.:	1750	3800	1750	1750	3800	1750	1750	1900	1750	3150	870	930

Capacity Analysis Module:												
Vol/Sat:	0.09	0.24	0.04	0.07	0.36	0.09	0.15	0.06	0.30	0.08	0.15	0.15
Crit Moves:	****				****				****	****		
Green Time:	16.5	61.8	61.8	18.6	63.9	63.9	33.1	53.2	53.2	14.4	34.5	34.5
Volume/Cap:	0.89	0.63	0.09	0.63	0.89	0.22	0.70	0.19	0.89	0.89	0.70	0.70
Delay/Veh:	109.1	40.7	31.3	73.6	51.9	31.8	65.0	38.1	66.6	99.7	63.8	63.8
User DelAdj:	1.00	1.00	1.00	1.00	1.00	1.00	1.00	1.00	1.00	1.00	1.00	1.00
AdjDel/Veh:	109.1	40.7	31.3	73.6	51.9	31.8	65.0	38.1	66.6	99.7	63.8	63.8
LOS by Move:	F	D	C	E	D	C	E	D	E	F	E	E
HCM2k95thQ:	20	31	4	13	52	10	23	8	45	19	25	25

Note: Queue reported is the number of cars per lane.

BART Phase II Extension Project

Level Of Service Computation Report
 2000 HCM Operations (Future Volume Alternative)
 AM - 2025 No Project Conditions

Intersection #3553: FRUITDALE/SOUTHWEST

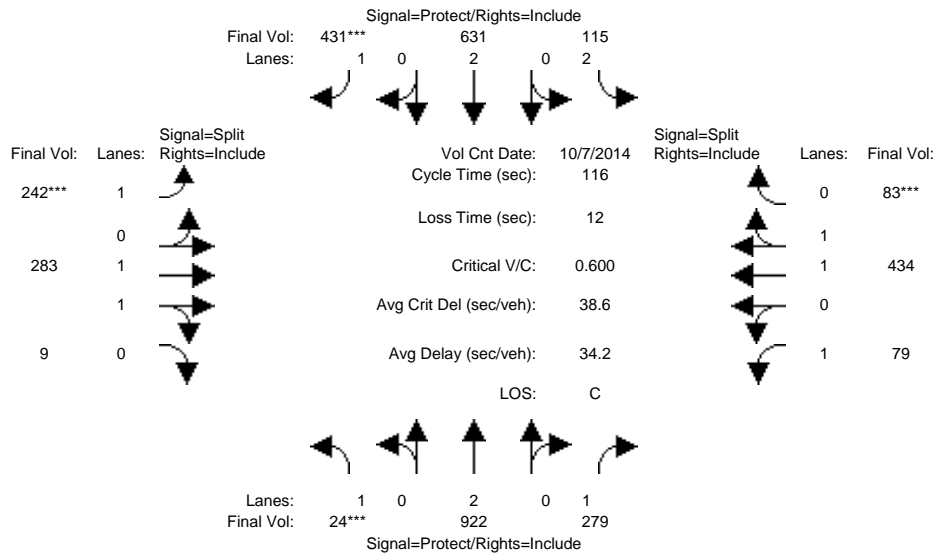

Approach:	North Bound			South Bound			East Bound			West Bound		
Movement:	L	T	R	L	T	R	L	T	R	L	T	R
Min. Green:	7	10	10	7	10	10	10	10	10	10	10	10
Y+R:	4.0	4.0	4.0	4.0	4.0	4.0	4.0	4.0	4.0	4.0	4.0	4.0
Volume Module: >> Count Date: 7 Oct 2014 <<												
Base Vol:	24	922	279	115	631	431	242	283	9	79	434	83
Growth Adj:	1.00	1.00	1.00	1.00	1.00	1.00	1.00	1.00	1.00	1.00	1.00	1.00
Initial Bse:	24	922	279	115	631	431	242	283	9	79	434	83
Added Vol:	0	0	0	0	0	0	0	0	0	0	0	0
PasserByVol:	0	0	0	0	0	0	0	0	0	0	0	0
Initial Fut:	24	922	279	115	631	431	242	283	9	79	434	83
User Adj:	1.00	1.00	1.00	1.00	1.00	1.00	1.00	1.00	1.00	1.00	1.00	1.00
PHF Adj:	1.00	1.00	1.00	1.00	1.00	1.00	1.00	1.00	1.00	1.00	1.00	1.00
PHF Volume:	24	922	279	115	631	431	242	283	9	79	434	83
Reduct Vol:	0	0	0	0	0	0	0	0	0	0	0	0
Reduced Vol:	24	922	279	115	631	431	242	283	9	79	434	83
PCE Adj:	1.00	1.00	1.00	1.00	1.00	1.00	1.00	1.00	1.00	1.00	1.00	1.00
MLF Adj:	1.00	1.00	1.00	1.00	1.00	1.00	1.00	1.00	1.00	1.00	1.00	1.00
FinalVolume:	24	922	279	115	631	431	242	283	9	79	434	83
Saturation Flow Module:												
Sat/Lane:	1900	1900	1900	1900	1900	1900	1900	1900	1900	1900	1900	1900
Adjustment:	0.92	1.00	0.92	0.83	1.00	0.92	0.92	0.97	0.95	0.92	0.98	0.95
Lanes:	1.00	2.00	1.00	2.00	2.00	1.00	1.00	1.94	0.06	1.00	1.67	0.33
Final Sat.:	1750	3800	1750	3150	3800	1750	1750	3586	114	1750	3106	594
Capacity Analysis Module:												
Vol/Sat:	0.01	0.24	0.16	0.04	0.17	0.25	0.14	0.08	0.08	0.05	0.14	0.14
Crit Moves:	****					****	****					****
Green Time:	7.0	42.1	42.1	10.5	45.6	45.6	25.6	25.6	25.6	25.9	25.9	25.9
Volume/Cap:	0.23	0.67	0.44	0.40	0.42	0.63	0.63	0.36	0.36	0.20	0.63	0.63
Delay/Veh:	53.0	32.4	28.5	50.8	25.8	30.2	44.1	38.5	38.5	36.9	42.3	42.3
User DelAdj:	1.00	1.00	1.00	1.00	1.00	1.00	1.00	1.00	1.00	1.00	1.00	1.00
AdjDel/Veh:	53.0	32.4	28.5	50.8	25.8	30.2	44.1	38.5	38.5	36.9	42.3	42.3
LOS by Move:	D	C	C	D	C	C	D	D	D	D	D	D
HCM2k95thQ:	2	25	15	6	15	24	16	9	9	5	15	15

Note: Queue reported is the number of cars per lane.

BART Phase II Extension Project

Level Of Service Computation Report
 2000 HCM Operations (Future Volume Alternative)
 PM - 2025 No Project Conditions

Intersection #3553: FRUITDALE/SOUTHWEST

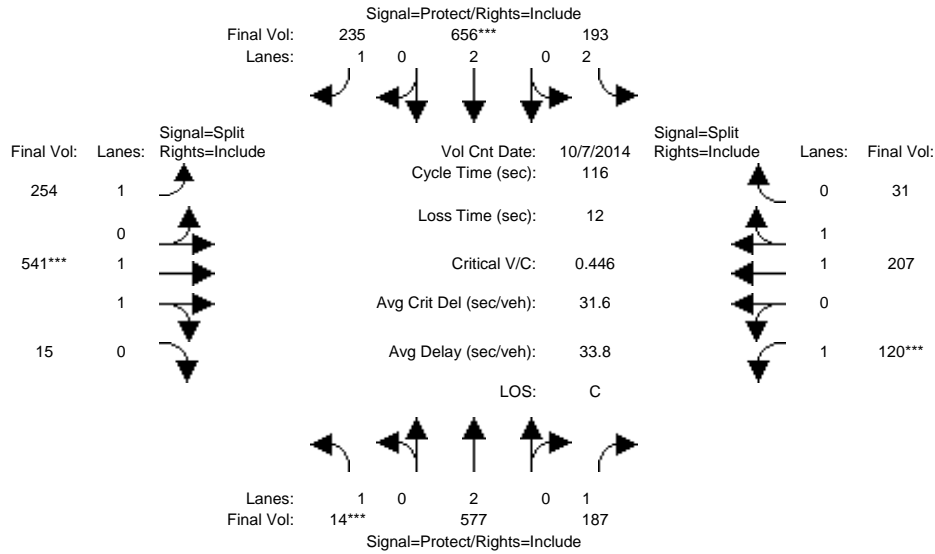

Approach:	North Bound			South Bound			East Bound			West Bound		
Movement:	L	T	R	L	T	R	L	T	R	L	T	R
Min. Green:	7	10	10	7	10	10	10	10	10	10	10	10
Y+R:	4.0	4.0	4.0	4.0	4.0	4.0	4.0	4.0	4.0	4.0	4.0	4.0
Volume Module: >> Count Date: 7 Oct 2014 <<												
Base Vol:	14	577	187	193	656	235	254	541	15	120	207	31
Growth Adj:	1.00	1.00	1.00	1.00	1.00	1.00	1.00	1.00	1.00	1.00	1.00	1.00
Initial Bse:	14	577	187	193	656	235	254	541	15	120	207	31
Added Vol:	0	0	0	0	0	0	0	0	0	0	0	0
PasserByVol:	0	0	0	0	0	0	0	0	0	0	0	0
Initial Fut:	14	577	187	193	656	235	254	541	15	120	207	31
User Adj:	1.00	1.00	1.00	1.00	1.00	1.00	1.00	1.00	1.00	1.00	1.00	1.00
PHF Adj:	1.00	1.00	1.00	1.00	1.00	1.00	1.00	1.00	1.00	1.00	1.00	1.00
PHF Volume:	14	577	187	193	656	235	254	541	15	120	207	31
Reduct Vol:	0	0	0	0	0	0	0	0	0	0	0	0
Reduced Vol:	14	577	187	193	656	235	254	541	15	120	207	31
PCE Adj:	1.00	1.00	1.00	1.00	1.00	1.00	1.00	1.00	1.00	1.00	1.00	1.00
MLF Adj:	1.00	1.00	1.00	1.00	1.00	1.00	1.00	1.00	1.00	1.00	1.00	1.00
FinalVolume:	14	577	187	193	656	235	254	541	15	120	207	31
Saturation Flow Module:												
Sat/Lane:	1900	1900	1900	1900	1900	1900	1900	1900	1900	1900	1900	1900
Adjustment:	0.92	1.00	0.92	0.83	1.00	0.92	0.92	0.97	0.95	0.92	0.98	0.95
Lanes:	1.00	2.00	1.00	2.00	2.00	1.00	1.00	1.94	0.06	1.00	1.73	0.27
Final Sat.:	1750	3800	1750	3150	3800	1750	1750	3600	100	1750	3218	482
Capacity Analysis Module:												
Vol/Sat:	0.01	0.15	0.11	0.06	0.17	0.13	0.15	0.15	0.15	0.07	0.06	0.06
Crit Moves:	****			****			****			****		
Green Time:	7.0	35.5	35.5	14.3	42.8	42.8	37.2	37.2	37.2	17.0	17.0	17.0
Volume/Cap:	0.13	0.50	0.35	0.50	0.47	0.36	0.45	0.47	0.47	0.47	0.44	0.44
Delay/Veh:	52.2	33.3	31.7	48.5	28.2	27.0	31.9	31.8	31.8	46.7	45.7	45.7
User DelAdj:	1.00	1.00	1.00	1.00	1.00	1.00	1.00	1.00	1.00	1.00	1.00	1.00
AdjDel/Veh:	52.2	33.3	31.7	48.5	28.2	27.0	31.9	31.8	31.8	46.7	45.7	45.7
LOS by Move:	D	C	C	D	C	C	C	C	C	D	D	D
HCM2k95thQ:	1	16	11	9	17	13	14	15	15	8	8	8

Note: Queue reported is the number of cars per lane.

BART Phase II Extension Project

Level Of Service Computation Report
 2000 HCM Operations (Future Volume Alternative)
 AM - 2025 No Project Conditions

Intersection #3606: JULIAN/MONTGOMERY

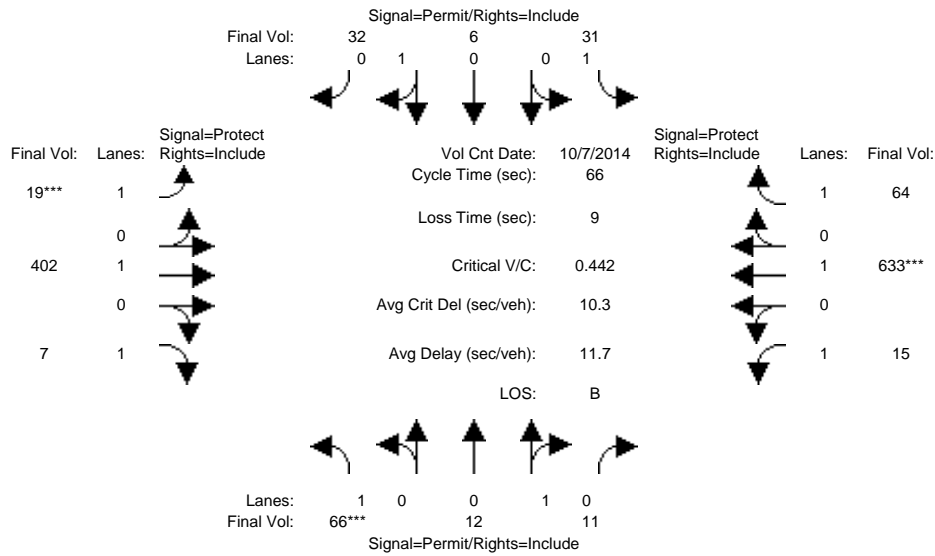

Approach:	North Bound			South Bound			East Bound			West Bound		
	L	T	R	L	T	R	L	T	R	L	T	R
Min. Green:	10	10	10	10	10	10	7	10	10	7	10	10
Y+R:	4.0	4.0	4.0	4.0	4.0	4.0	4.0	4.0	4.0	4.0	4.0	4.0
Volume Module:	>> Count Date: 7 Oct 2014 <<											
Base Vol:	66	12	11	31	6	32	19	402	7	15	633	64
Growth Adj:	1.00	1.00	1.00	1.00	1.00	1.00	1.00	1.00	1.00	1.00	1.00	1.00
Initial Bse:	66	12	11	31	6	32	19	402	7	15	633	64
Added Vol:	0	0	0	0	0	0	0	0	0	0	0	0
PasserByVol:	0	0	0	0	0	0	0	0	0	0	0	0
Initial Fut:	66	12	11	31	6	32	19	402	7	15	633	64
User Adj:	1.00	1.00	1.00	1.00	1.00	1.00	1.00	1.00	1.00	1.00	1.00	1.00
PHF Adj:	1.00	1.00	1.00	1.00	1.00	1.00	1.00	1.00	1.00	1.00	1.00	1.00
PHF Volume:	66	12	11	31	6	32	19	402	7	15	633	64
Reduct Vol:	0	0	0	0	0	0	0	0	0	0	0	0
Reduced Vol:	66	12	11	31	6	32	19	402	7	15	633	64
PCE Adj:	1.00	1.00	1.00	1.00	1.00	1.00	1.00	1.00	1.00	1.00	1.00	1.00
MLF Adj:	1.00	1.00	1.00	1.00	1.00	1.00	1.00	1.00	1.00	1.00	1.00	1.00
FinalVolume:	66	12	11	31	6	32	19	402	7	15	633	64
Saturation Flow Module:												
Sat/Lane:	1900	1900	1900	1900	1900	1900	1900	1900	1900	1900	1900	1900
Adjustment:	0.92	0.95	0.95	0.92	0.95	0.95	0.92	1.00	0.92	0.92	1.00	0.92
Lanes:	1.00	0.52	0.48	1.00	0.16	0.84	1.00	1.00	1.00	1.00	1.00	1.00
Final Sat.:	1750	939	861	1750	284	1516	1750	1900	1750	1750	1900	1750
Capacity Analysis Module:												
Vol/Sat:	0.04	0.01	0.01	0.02	0.02	0.02	0.01	0.21	0.00	0.01	0.33	0.04
Crit Moves:	****						****					
Green Time:	10.0	10.0	10.0	10.0	10.0	10.0	7.0	31.3	31.3	15.7	40.0	40.0
Volume/Cap:	0.25	0.08	0.08	0.12	0.14	0.14	0.10	0.45	0.01	0.04	0.55	0.06
Delay/Veh:	25.2	24.2	24.2	24.4	24.5	24.5	26.9	11.9	9.2	19.4	8.2	5.3
User DelAdj:	1.00	1.00	1.00	1.00	1.00	1.00	1.00	1.00	1.00	1.00	1.00	1.00
AdjDel/Veh:	25.2	24.2	24.2	24.4	24.5	24.5	26.9	11.9	9.2	19.4	8.2	5.3
LOS by Move:	C	C	C	C	C	C	C	B	A	B	A	A
HCM2k95thQ:	3	1	1	1	2	2	1	10	0	0	14	1

Note: Queue reported is the number of cars per lane.

BART Phase II Extension Project

Level Of Service Computation Report
 2000 HCM Operations (Future Volume Alternative)
 PM - 2025 No Project Conditions

Intersection #3606: JULIAN/MONTGOMERY

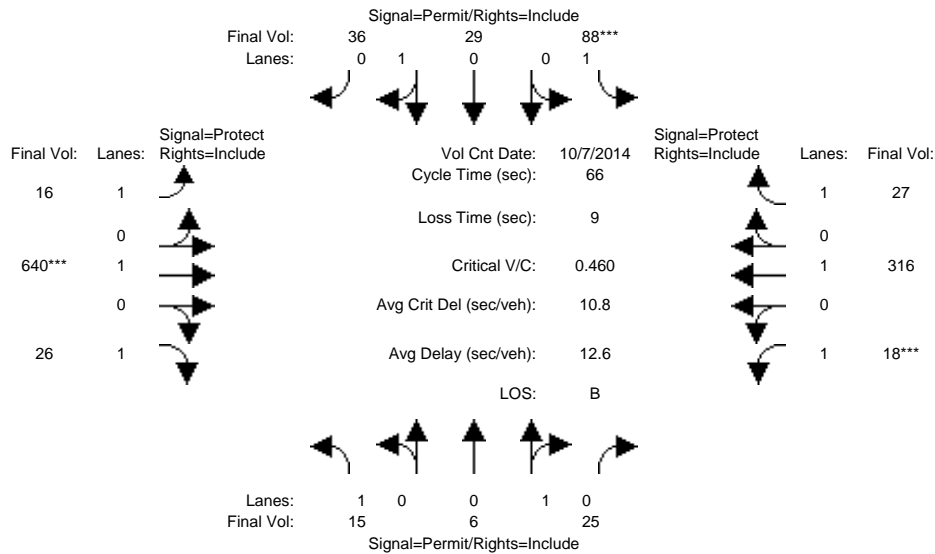

Approach:	North Bound			South Bound			East Bound			West Bound		
	L	T	R	L	T	R	L	T	R	L	T	R
Min. Green:	10	10	10	10	10	10	7	10	10	7	10	10
Y+R:	4.0	4.0	4.0	4.0	4.0	4.0	4.0	4.0	4.0	4.0	4.0	4.0

Volume Module: >> Count Date: 7 Oct 2014 <<

Base Vol:	15	6	25	88	29	36	16	640	26	18	316	27
Growth Adj:	1.00	1.00	1.00	1.00	1.00	1.00	1.00	1.00	1.00	1.00	1.00	1.00
Initial Bse:	15	6	25	88	29	36	16	640	26	18	316	27
Added Vol:	0	0	0	0	0	0	0	0	0	0	0	0
PasserByVol:	0	0	0	0	0	0	0	0	0	0	0	0
Initial Fut:	15	6	25	88	29	36	16	640	26	18	316	27
User Adj:	1.00	1.00	1.00	1.00	1.00	1.00	1.00	1.00	1.00	1.00	1.00	1.00
PHF Adj:	1.00	1.00	1.00	1.00	1.00	1.00	1.00	1.00	1.00	1.00	1.00	1.00
PHF Volume:	15	6	25	88	29	36	16	640	26	18	316	27
Reduct Vol:	0	0	0	0	0	0	0	0	0	0	0	0
Reduced Vol:	15	6	25	88	29	36	16	640	26	18	316	27
PCE Adj:	1.00	1.00	1.00	1.00	1.00	1.00	1.00	1.00	1.00	1.00	1.00	1.00
MLF Adj:	1.00	1.00	1.00	1.00	1.00	1.00	1.00	1.00	1.00	1.00	1.00	1.00
FinalVolume:	15	6	25	88	29	36	16	640	26	18	316	27

Saturation Flow Module:

Sat/Lane:	1900	1900	1900	1900	1900	1900	1900	1900	1900	1900	1900	1900
Adjustment:	0.92	0.95	0.95	0.92	0.95	0.95	0.92	1.00	0.92	0.92	1.00	0.92
Lanes:	1.00	0.19	0.81	1.00	0.45	0.55	1.00	1.00	1.00	1.00	1.00	1.00
Final Sat.:	1750	348	1452	1750	803	997	1750	1900	1750	1750	1900	1750

Capacity Analysis Module:

Vol/Sat:	0.01	0.02	0.02	0.05	0.04	0.04	0.01	0.34	0.01	0.01	0.17	0.02
Crit Moves:				****				****			****	
Green Time:	10.0	10.0	10.0	10.0	10.0	10.0	18.3	40.0	40.0	7.0	28.7	28.7
Volume/Cap:	0.06	0.11	0.11	0.33	0.24	0.24	0.03	0.56	0.02	0.10	0.38	0.04
Delay/Veh:	24.1	24.4	24.4	25.8	25.1	25.1	17.4	8.3	5.2	26.9	12.9	10.7
User DelAdj:	1.00	1.00	1.00	1.00	1.00	1.00	1.00	1.00	1.00	1.00	1.00	1.00
AdjDel/Veh:	24.1	24.4	24.4	25.8	25.1	25.1	17.4	8.3	5.2	26.9	12.9	10.7
LOS by Move:	C	C	C	C	C	C	B	A	A	C	B	B
HCM2k95thQ:	1	1	1	4	3	3	1	14	0	1	8	1

Note: Queue reported is the number of cars per lane.

BART Phase II Extension Project

Level Of Service Computation Report
2000 HCM Operations (Future Volume Alternative)
AM - 2025 No Project Conditions

Intersection #3608: JULIAN/STOCKTON

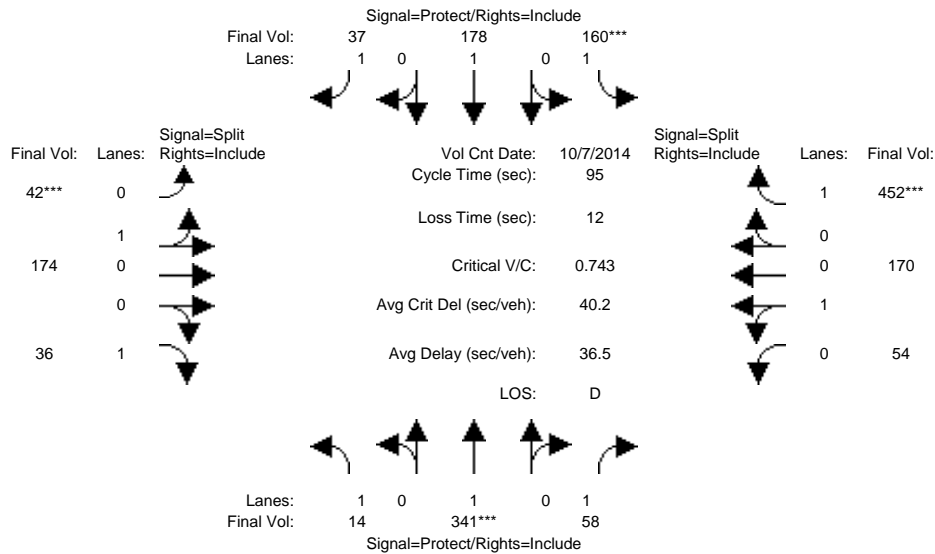

Approach:	North Bound			South Bound			East Bound			West Bound		
Movement:	L	T	R	L	T	R	L	T	R	L	T	R
Min. Green:	7	10	10	7	10	10	10	10	10	10	10	10
Y+R:	4.0	4.0	4.0	4.0	4.0	4.0	4.0	4.0	4.0	4.0	4.0	4.0
Volume Module: >> Count Date: 7 Oct 2014 <<												
Base Vol:	14	341	58	160	178	37	42	174	36	54	170	452
Growth Adj:	1.00	1.00	1.00	1.00	1.00	1.00	1.00	1.00	1.00	1.00	1.00	1.00
Initial Bse:	14	341	58	160	178	37	42	174	36	54	170	452
Added Vol:	0	0	0	0	0	0	0	0	0	0	0	0
PasserByVol:	0	0	0	0	0	0	0	0	0	0	0	0
Initial Fut:	14	341	58	160	178	37	42	174	36	54	170	452
User Adj:	1.00	1.00	1.00	1.00	1.00	1.00	1.00	1.00	1.00	1.00	1.00	1.00
PHF Adj:	1.00	1.00	1.00	1.00	1.00	1.00	1.00	1.00	1.00	1.00	1.00	1.00
PHF Volume:	14	341	58	160	178	37	42	174	36	54	170	452
Reduct Vol:	0	0	0	0	0	0	0	0	0	0	0	0
Reduced Vol:	14	341	58	160	178	37	42	174	36	54	170	452
PCE Adj:	1.00	1.00	1.00	1.00	1.00	1.00	1.00	1.00	1.00	1.00	1.00	1.00
MLF Adj:	1.00	1.00	1.00	1.00	1.00	1.00	1.00	1.00	1.00	1.00	1.00	1.00
FinalVolume:	14	341	58	160	178	37	42	174	36	54	170	452
Saturation Flow Module:												
Sat/Lane:	1900	1900	1900	1900	1900	1900	1900	1900	1900	1900	1900	1900
Adjustment:	0.92	1.00	0.92	0.92	1.00	0.92	0.95	0.95	0.92	0.95	0.95	0.92
Lanes:	1.00	1.00	1.00	1.00	1.00	1.00	0.19	0.81	1.00	0.24	0.76	1.00
Final Sat.:	1750	1900	1750	1750	1900	1750	350	1450	1750	434	1366	1750
Capacity Analysis Module:												
Vol/Sat:	0.01	0.18	0.03	0.09	0.09	0.02	0.12	0.12	0.02	0.12	0.12	0.26
Crit Moves:	****			****			****			****		
Green Time:	14.3	22.9	22.9	11.7	20.4	20.4	15.3	15.3	15.3	33.0	33.0	33.0
Volume/Cap:	0.05	0.74	0.14	0.74	0.44	0.10	0.74	0.74	0.13	0.36	0.36	0.74
Delay/Veh:	34.7	39.8	28.4	53.2	33.1	30.1	47.9	47.9	34.3	23.4	23.4	32.2
User DelAdj:	1.00	1.00	1.00	1.00	1.00	1.00	1.00	1.00	1.00	1.00	1.00	1.00
AdjDel/Veh:	34.7	39.8	28.4	53.2	33.1	30.1	47.9	47.9	34.3	23.4	23.4	32.2
LOS by Move:	C	D	C	D	C	C	D	D	C	C	C	C
HCM2k95thQ:	1	18	3	10	9	2	13	13	2	10	10	23

Note: Queue reported is the number of cars per lane.

BART Phase II Extension Project

Level Of Service Computation Report
 2000 HCM Operations (Future Volume Alternative)
 PM - 2025 No Project Conditions

Intersection #3608: JULIAN/STOCKTON

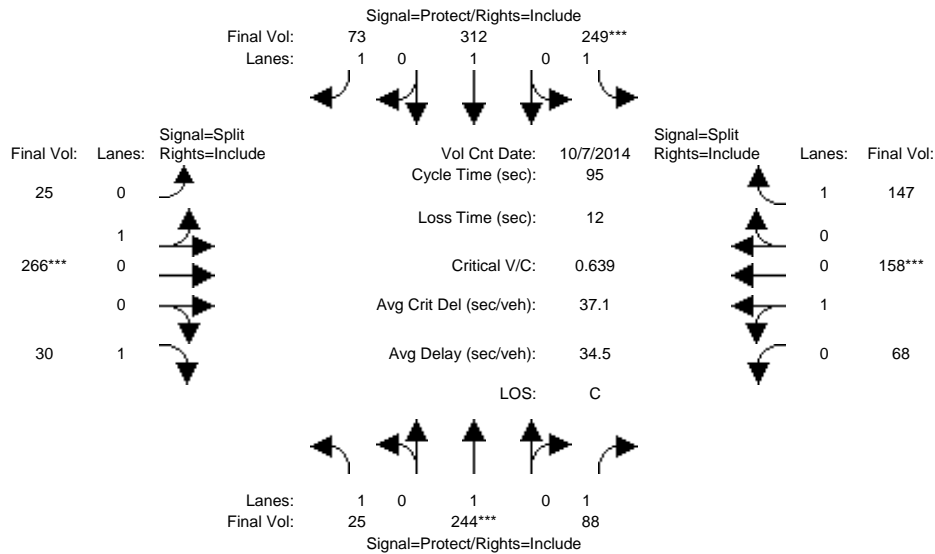

Approach:	North Bound			South Bound			East Bound			West Bound		
	L	T	R	L	T	R	L	T	R	L	T	R
Min. Green:	7	10	10	7	10	10	10	10	10	10	10	10
Y+R:	4.0	4.0	4.0	4.0	4.0	4.0	4.0	4.0	4.0	4.0	4.0	4.0
Volume Module: >> Count Date: 7 Oct 2014 <<												
Base Vol:	25	244	88	249	312	73	25	266	30	68	158	147
Growth Adj:	1.00	1.00	1.00	1.00	1.00	1.00	1.00	1.00	1.00	1.00	1.00	1.00
Initial Bse:	25	244	88	249	312	73	25	266	30	68	158	147
Added Vol:	0	0	0	0	0	0	0	0	0	0	0	0
PasserByVol:	0	0	0	0	0	0	0	0	0	0	0	0
Initial Fut:	25	244	88	249	312	73	25	266	30	68	158	147
User Adj:	1.00	1.00	1.00	1.00	1.00	1.00	1.00	1.00	1.00	1.00	1.00	1.00
PHF Adj:	1.00	1.00	1.00	1.00	1.00	1.00	1.00	1.00	1.00	1.00	1.00	1.00
PHF Volume:	25	244	88	249	312	73	25	266	30	68	158	147
Reduct Vol:	0	0	0	0	0	0	0	0	0	0	0	0
Reduced Vol:	25	244	88	249	312	73	25	266	30	68	158	147
PCE Adj:	1.00	1.00	1.00	1.00	1.00	1.00	1.00	1.00	1.00	1.00	1.00	1.00
MLF Adj:	1.00	1.00	1.00	1.00	1.00	1.00	1.00	1.00	1.00	1.00	1.00	1.00
FinalVolume:	25	244	88	249	312	73	25	266	30	68	158	147
Saturation Flow Module:												
Sat/Lane:	1900	1900	1900	1900	1900	1900	1900	1900	1900	1900	1900	1900
Adjustment:	0.92	1.00	0.92	0.92	1.00	0.92	0.95	0.95	0.92	0.95	0.95	0.92
Lanes:	1.00	1.00	1.00	1.00	1.00	1.00	0.09	0.91	1.00	0.30	0.70	1.00
Final Sat.:	1750	1900	1750	1750	1900	1750	155	1645	1750	542	1258	1750
Capacity Analysis Module:												
Vol/Sat:	0.01	0.13	0.05	0.14	0.16	0.04	0.16	0.16	0.02	0.13	0.13	0.08
Crit Moves:	****			****			****			****		
Green Time:	12.5	19.1	19.1	21.2	27.8	27.8	24.1	24.1	24.1	18.7	18.7	18.7
Volume/Cap:	0.11	0.64	0.25	0.64	0.56	0.14	0.64	0.64	0.07	0.64	0.64	0.43
Delay/Veh:	36.6	38.4	32.3	37.0	29.7	24.9	34.6	34.6	27.0	38.9	38.9	34.3
User DelAdj:	1.00	1.00	1.00	1.00	1.00	1.00	1.00	1.00	1.00	1.00	1.00	1.00
AdjDel/Veh:	36.6	38.4	32.3	37.0	29.7	24.9	34.6	34.6	27.0	38.9	38.9	34.3
LOS by Move:	D	D	C	D	C	C	C	C	C	D	D	C
HCM2k95thQ:	1	13	5	14	14	3	15	15	1	12	12	8

Note: Queue reported is the number of cars per lane.

BART Phase II Extension Project

Level Of Service Computation Report
 2000 HCM Operations (Future Volume Alternative)
 AM - 2025 No Project Conditions

Intersection #3651: LINCOLN/PARKMOOR

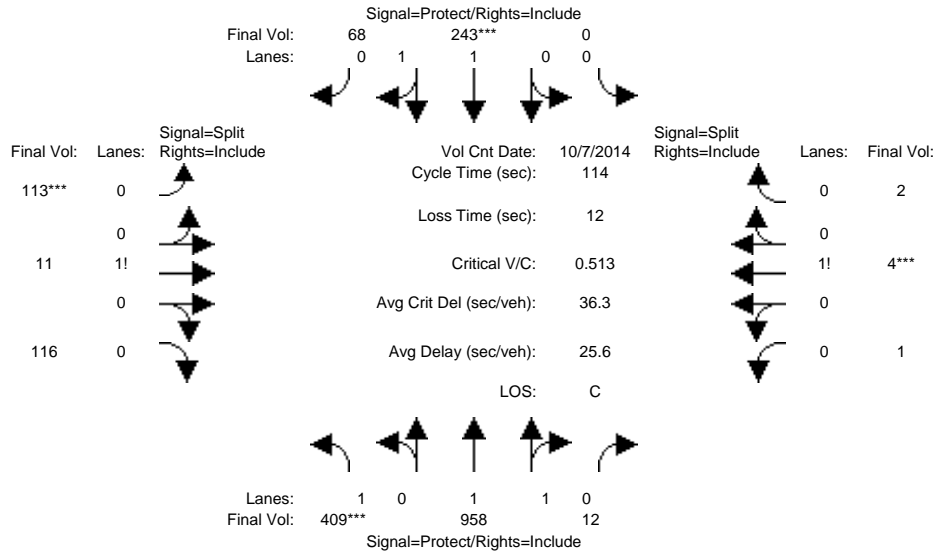

Approach:	North Bound			South Bound			East Bound			West Bound		
	L	T	R	L	T	R	L	T	R	L	T	R
Min. Green:	7	10	10	0	10	10	10	10	10	10	10	10
Y+R:	4.0	4.0	4.0	4.0	4.0	4.0	4.0	4.0	4.0	4.0	4.0	4.0

Volume Module: >> Count Date: 7 Oct 2014 <<

Base Vol:	409	958	12	0	243	68	113	11	116	1	4	2
Growth Adj:	1.00	1.00	1.00	1.00	1.00	1.00	1.00	1.00	1.00	1.00	1.00	1.00
Initial Bse:	409	958	12	0	243	68	113	11	116	1	4	2
Added Vol:	0	0	0	0	0	0	0	0	0	0	0	0
PasserByVol:	0	0	0	0	0	0	0	0	0	0	0	0
Initial Fut:	409	958	12	0	243	68	113	11	116	1	4	2
User Adj:	1.00	1.00	1.00	1.00	1.00	1.00	1.00	1.00	1.00	1.00	1.00	1.00
PHF Adj:	1.00	1.00	1.00	1.00	1.00	1.00	1.00	1.00	1.00	1.00	1.00	1.00
PHF Volume:	409	958	12	0	243	68	113	11	116	1	4	2
Reduct Vol:	0	0	0	0	0	0	0	0	0	0	0	0
Reduced Vol:	409	958	12	0	243	68	113	11	116	1	4	2
PCE Adj:	1.00	1.00	1.00	1.00	1.00	1.00	1.00	1.00	1.00	1.00	1.00	1.00
MLF Adj:	1.00	1.00	1.00	1.00	1.00	1.00	1.00	1.00	1.00	1.00	1.00	1.00
FinalVolume:	409	958	12	0	243	68	113	11	116	1	4	2

Saturation Flow Module:

Sat/Lane:	1900	1900	1900	1900	1900	1900	1900	1900	1900	1900	1900	1900
Adjustment:	0.92	0.97	0.95	0.92	0.98	0.95	0.92	0.92	0.92	0.92	0.92	0.92
Lanes:	1.00	1.97	0.03	0.00	1.55	0.45	0.47	0.05	0.48	0.14	0.57	0.29
Final Sat.:	1750	3654	46	0	2890	809	824	80	846	250	1000	500

Capacity Analysis Module:

Vol/Sat:	0.23	0.26	0.26	0.00	0.08	0.08	0.14	0.14	0.14	0.00	0.00	0.00
Crit Moves:	****				****		****				****	
Green Time:	47.3	64.3	64.3	0.0	17.0	17.0	27.7	27.7	27.7	10.0	10.0	10.0
Volume/Cap:	0.56	0.47	0.47	0.00	0.56	0.56	0.56	0.56	0.56	0.05	0.05	0.05
Delay/Veh:	26.5	14.9	14.9	0.0	46.4	46.4	39.6	39.6	39.6	47.8	47.8	47.8
User DelAdj:	1.00	1.00	1.00	1.00	1.00	1.00	1.00	1.00	1.00	1.00	1.00	1.00
AdjDel/Veh:	26.5	14.9	14.9	0.0	46.4	46.4	39.6	39.6	39.6	47.8	47.8	47.8
LOS by Move:	C	B	B	A	D	D	D	D	D	D	D	D
HCM2k95thQ:	21	19	19	0	10	10	15	15	15	1	1	1

Note: Queue reported is the number of cars per lane.

BART Phase II Extension Project

Level Of Service Computation Report
 2000 HCM Operations (Future Volume Alternative)
 PM - 2025 No Project Conditions

Intersection #3651: LINCOLN/PARKMOOR

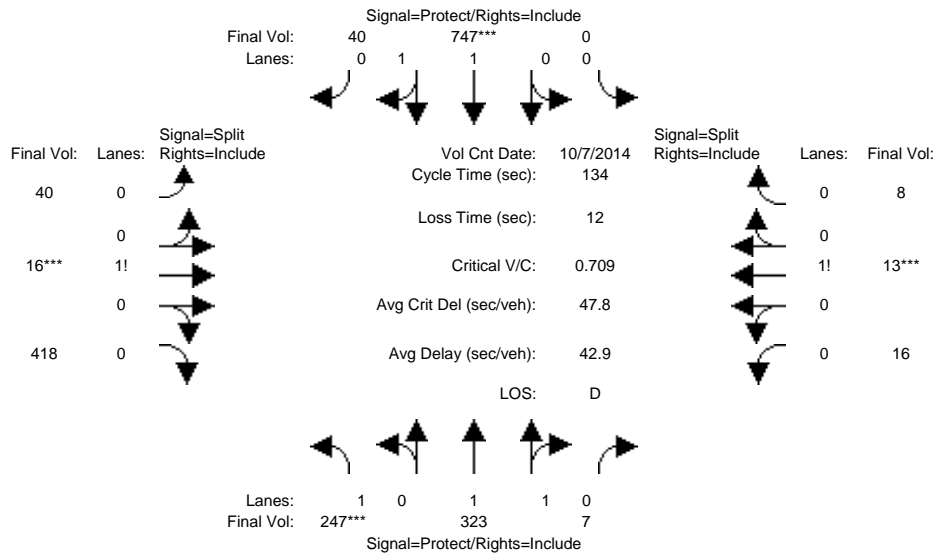

Approach:	North Bound			South Bound			East Bound			West Bound		
	L	T	R	L	T	R	L	T	R	L	T	R
Min. Green:	7	10	10	0	10	10	10	10	10	10	10	10
Y+R:	4.0	4.0	4.0	4.0	4.0	4.0	4.0	4.0	4.0	4.0	4.0	4.0

Volume Module:	>>	Count	Date:	7 Oct 2014	<<							
Base Vol:	247	323	7	0	747	40	40	16	418	16	13	8
Growth Adj:	1.00	1.00	1.00	1.00	1.00	1.00	1.00	1.00	1.00	1.00	1.00	1.00
Initial Bse:	247	323	7	0	747	40	40	16	418	16	13	8
Added Vol:	0	0	0	0	0	0	0	0	0	0	0	0
PasserByVol:	0	0	0	0	0	0	0	0	0	0	0	0
Initial Fut:	247	323	7	0	747	40	40	16	418	16	13	8
User Adj:	1.00	1.00	1.00	1.00	1.00	1.00	1.00	1.00	1.00	1.00	1.00	1.00
PHF Adj:	1.00	1.00	1.00	1.00	1.00	1.00	1.00	1.00	1.00	1.00	1.00	1.00
PHF Volume:	247	323	7	0	747	40	40	16	418	16	13	8
Reduct Vol:	0	0	0	0	0	0	0	0	0	0	0	0
Reduced Vol:	247	323	7	0	747	40	40	16	418	16	13	8
PCE Adj:	1.00	1.00	1.00	1.00	1.00	1.00	1.00	1.00	1.00	1.00	1.00	1.00
MLF Adj:	1.00	1.00	1.00	1.00	1.00	1.00	1.00	1.00	1.00	1.00	1.00	1.00
FinalVolume:	247	323	7	0	747	40	40	16	418	16	13	8

Saturation Flow Module:	Sat/Lane:	1900	1900	1900	1900	1900	1900	1900	1900	1900	1900	1900
Adjustment:	0.92	0.97	0.95	0.92	0.98	0.95	0.92	0.92	0.92	0.92	0.92	0.92
Lanes:	1.00	1.96	0.04	0.00	1.90	0.10	0.08	0.03	0.89	0.43	0.35	0.22
Final Sat.:	1750	3621	78	0	3512	188	148	59	1543	757	615	378

Capacity Analysis Module:	Vol/Sat:	0.14	0.09	0.09	0.00	0.21	0.21	0.27	0.27	0.27	0.02	0.02	0.02
Crit Moves:	****				****			****			****		
Green Time:	25.3	63.4	63.4	0.0	38.1	38.1	48.6	48.6	48.6	48.6	10.0	10.0	10.0
Volume/Cap:	0.75	0.19	0.19	0.00	0.75	0.75	0.75	0.75	0.75	0.75	0.28	0.28	0.28
Delay/Veh:	60.4	20.4	20.4	0.0	46.5	46.5	42.2	42.2	42.2	42.2	59.8	59.8	59.8
User DelAdj:	1.00	1.00	1.00	1.00	1.00	1.00	1.00	1.00	1.00	1.00	1.00	1.00	1.00
AdjDel/Veh:	60.4	20.4	20.4	0.0	46.5	46.5	42.2	42.2	42.2	42.2	59.8	59.8	59.8
LOS by Move:	E	C	C	A	D	D	D	D	D	D	E	E	E
HCM2k95thQ:	20	8	8	0	27	27	32	32	32	32	4	4	4

Note: Queue reported is the number of cars per lane.

BART Phase II Extension Project

Level Of Service Computation Report
 2000 HCM Operations (Future Volume Alternative)
 AM - 2025 No Project Conditions

Intersection #3653: LINCOLN/SAN CARLOS

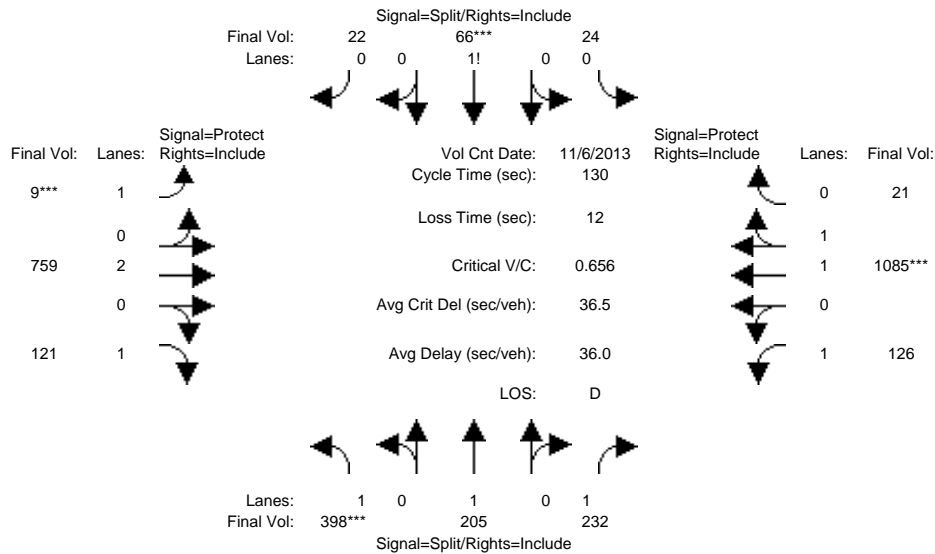

Approach:	North Bound			South Bound			East Bound			West Bound		
	L	T	R	L	T	R	L	T	R	L	T	R
Min. Green:	10	10	10	10	10	10	7	10	10	7	10	10
Y+R:	4.0	4.0	4.0	4.0	4.0	4.0	4.0	4.0	4.0	4.0	4.0	4.0
Volume Module: >> Count Date: 6 Nov 2013 <<												
Base Vol:	398	205	232	24	66	22	9	759	121	126	1085	21
Growth Adj:	1.00	1.00	1.00	1.00	1.00	1.00	1.00	1.00	1.00	1.00	1.00	1.00
Initial Bse:	398	205	232	24	66	22	9	759	121	126	1085	21
Added Vol:	0	0	0	0	0	0	0	0	0	0	0	0
PasserByVol:	0	0	0	0	0	0	0	0	0	0	0	0
Initial Fut:	398	205	232	24	66	22	9	759	121	126	1085	21
User Adj:	1.00	1.00	1.00	1.00	1.00	1.00	1.00	1.00	1.00	1.00	1.00	1.00
PHF Adj:	1.00	1.00	1.00	1.00	1.00	1.00	1.00	1.00	1.00	1.00	1.00	1.00
PHF Volume:	398	205	232	24	66	22	9	759	121	126	1085	21
Reduct Vol:	0	0	0	0	0	0	0	0	0	0	0	0
Reduced Vol:	398	205	232	24	66	22	9	759	121	126	1085	21
PCE Adj:	1.00	1.00	1.00	1.00	1.00	1.00	1.00	1.00	1.00	1.00	1.00	1.00
MLF Adj:	1.00	1.00	1.00	1.00	1.00	1.00	1.00	1.00	1.00	1.00	1.00	1.00
FinalVolume:	398	205	232	24	66	22	9	759	121	126	1085	21
Saturation Flow Module:												
Sat/Lane:	1900	1900	1900	1900	1900	1900	1900	1900	1900	1900	1900	1900
Adjustment:	0.92	1.00	0.92	0.92	0.92	0.92	0.92	1.00	0.92	0.92	0.97	0.95
Lanes:	1.00	1.00	1.00	0.21	0.59	0.20	1.00	2.00	1.00	1.00	1.96	0.04
Final Sat.:	1750	1900	1750	375	1031	344	1750	3800	1750	1750	3630	70
Capacity Analysis Module:												
Vol/Sat:	0.23	0.11	0.13	0.06	0.06	0.06	0.01	0.20	0.07	0.07	0.30	0.30
Crit Moves:	****				****		****				****	
Green Time:	42.8	42.8	42.8	12.0	12.0	12.0	7.0	46.5	46.5	16.7	56.2	56.2
Volume/Cap:	0.69	0.33	0.40	0.69	0.69	0.69	0.10	0.56	0.19	0.56	0.69	0.69
Delay/Veh:	41.5	33.1	34.2	69.2	69.2	69.2	58.9	34.1	29.0	56.3	31.2	31.2
User DelAdj:	1.00	1.00	1.00	1.00	1.00	1.00	1.00	1.00	1.00	1.00	1.00	1.00
AdjDel/Veh:	41.5	33.1	34.2	69.2	69.2	69.2	58.9	34.1	29.0	56.3	31.2	31.2
LOS by Move:	D	C	C	E	E	E	E	C	C	E	C	C
HCM2k95thQ:	26	11	14	12	12	12	1	21	7	10	31	31

Note: Queue reported is the number of cars per lane.

BART Phase II Extension Project

Level Of Service Computation Report
2000 HCM Operations (Future Volume Alternative)
PM - 2025 No Project Conditions

Intersection #3653: LINCOLN/SAN CARLOS

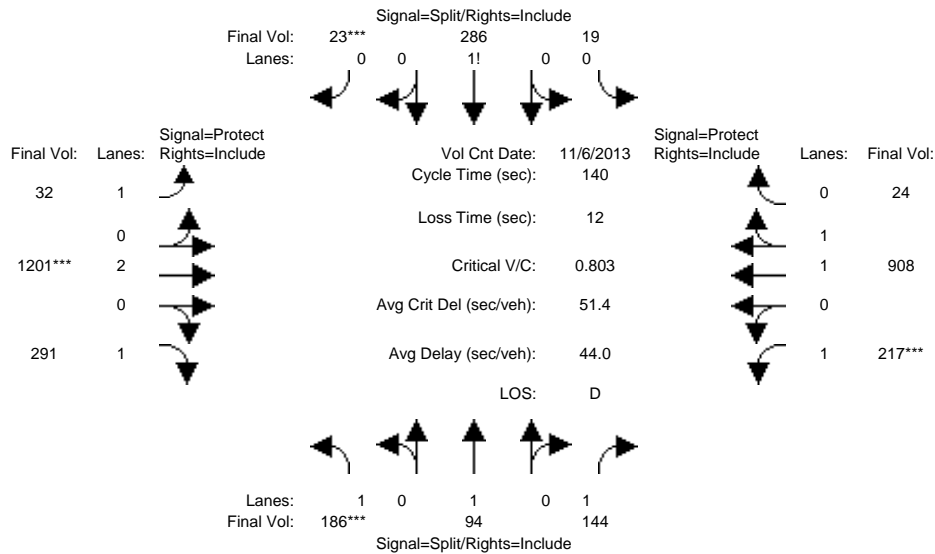

Approach:	North Bound			South Bound			East Bound			West Bound		
	L	T	R	L	T	R	L	T	R	L	T	R
Min. Green:	10	10	10	10	10	10	7	10	10	7	10	10
Y+R:	4.0	4.0	4.0	4.0	4.0	4.0	4.0	4.0	4.0	4.0	4.0	4.0

Volume Module: >> Count Date: 6 Nov 2013 <<

Base Vol:	186	94	144	19	286	23	32	1201	291	217	908	24
Growth Adj:	1.00	1.00	1.00	1.00	1.00	1.00	1.00	1.00	1.00	1.00	1.00	1.00
Initial Bse:	186	94	144	19	286	23	32	1201	291	217	908	24
Added Vol:	0	0	0	0	0	0	0	0	0	0	0	0
PasserByVol:	0	0	0	0	0	0	0	0	0	0	0	0
Initial Fut:	186	94	144	19	286	23	32	1201	291	217	908	24
User Adj:	1.00	1.00	1.00	1.00	1.00	1.00	1.00	1.00	1.00	1.00	1.00	1.00
PHF Adj:	1.00	1.00	1.00	1.00	1.00	1.00	1.00	1.00	1.00	1.00	1.00	1.00
PHF Volume:	186	94	144	19	286	23	32	1201	291	217	908	24
Reduct Vol:	0	0	0	0	0	0	0	0	0	0	0	0
Reduced Vol:	186	94	144	19	286	23	32	1201	291	217	908	24
PCE Adj:	1.00	1.00	1.00	1.00	1.00	1.00	1.00	1.00	1.00	1.00	1.00	1.00
MLF Adj:	1.00	1.00	1.00	1.00	1.00	1.00	1.00	1.00	1.00	1.00	1.00	1.00
FinalVolume:	186	94	144	19	286	23	32	1201	291	217	908	24

Saturation Flow Module:

Sat/Lane:	1900	1900	1900	1900	1900	1900	1900	1900	1900	1900	1900	1900
Adjustment:	0.92	1.00	0.92	0.92	0.92	0.92	0.92	1.00	0.92	0.92	0.97	0.95
Lanes:	1.00	1.00	1.00	0.06	0.87	0.07	1.00	2.00	1.00	1.00	1.95	0.05
Final Sat.:	1750	1900	1750	101	1526	123	1750	3800	1750	1750	3605	95

Capacity Analysis Module:

Vol/Sat:	0.11	0.05	0.08	0.19	0.19	0.19	0.02	0.32	0.17	0.12	0.25	0.25
Crit Moves:	****					****		****		****		
Green Time:	18.5	18.5	18.5	32.7	32.7	32.7	12.7	55.1	55.1	21.6	64.1	64.1
Volume/Cap:	0.80	0.37	0.62	0.80	0.80	0.80	0.20	0.80	0.42	0.80	0.55	0.55
Delay/Veh:	76.9	56.4	62.5	61.5	61.5	61.5	59.6	40.8	31.3	72.9	27.9	27.9
User DelAdj:	1.00	1.00	1.00	1.00	1.00	1.00	1.00	1.00	1.00	1.00	1.00	1.00
AdjDel/Veh:	76.9	56.4	62.5	61.5	61.5	61.5	59.6	40.8	31.3	72.9	27.9	27.9
LOS by Move:	E	E	E	E	E	E	E	D	C	E	C	C
HCM2k95thQ:	17	7	12	28	28	28	3	39	18	19	26	26

Note: Queue reported is the number of cars per lane.

BART Phase II Extension Project

Level Of Service Computation Report
 2000 HCM Operations (Future Volume Alternative)
 AM - 2025 No Project Conditions

Intersection #3690: MERIDIAN/PARKMOOR

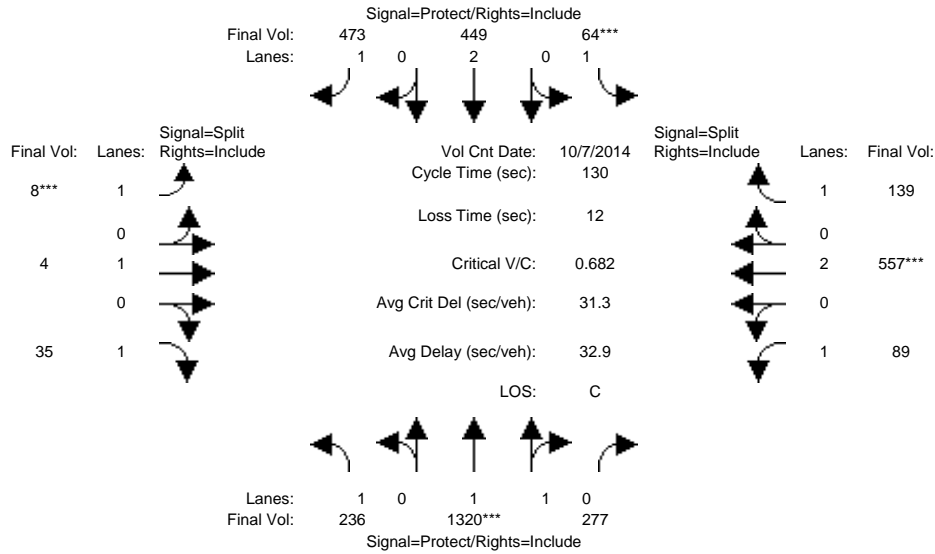

Approach:	North Bound			South Bound			East Bound			West Bound		
	L	T	R	L	T	R	L	T	R	L	T	R
Min. Green:	7	10	10	7	10	10	10	10	10	10	10	10
Y+R:	4.0	4.0	4.0	4.0	4.0	4.0	4.0	4.0	4.0	4.0	4.0	4.0
Volume Module: >> Count Date: 7 Oct 2014 <<												
Base Vol:	236	1320	277	64	449	473	8	4	35	89	557	139
Growth Adj:	1.00	1.00	1.00	1.00	1.00	1.00	1.00	1.00	1.00	1.00	1.00	1.00
Initial Bse:	236	1320	277	64	449	473	8	4	35	89	557	139
Added Vol:	0	0	0	0	0	0	0	0	0	0	0	0
PasserByVol:	0	0	0	0	0	0	0	0	0	0	0	0
Initial Fut:	236	1320	277	64	449	473	8	4	35	89	557	139
User Adj:	1.00	1.00	1.00	1.00	1.00	1.00	1.00	1.00	1.00	1.00	1.00	1.00
PHF Adj:	1.00	1.00	1.00	1.00	1.00	1.00	1.00	1.00	1.00	1.00	1.00	1.00
PHF Volume:	236	1320	277	64	449	473	8	4	35	89	557	139
Reduct Vol:	0	0	0	0	0	0	0	0	0	0	0	0
Reduced Vol:	236	1320	277	64	449	473	8	4	35	89	557	139
PCE Adj:	1.00	1.00	1.00	1.00	1.00	1.00	1.00	1.00	1.00	1.00	1.00	1.00
MLF Adj:	1.00	1.00	1.00	1.00	1.00	1.00	1.00	1.00	1.00	1.00	1.00	1.00
FinalVolume:	236	1320	277	64	449	473	8	4	35	89	557	139
Saturation Flow Module:												
Sat/Lane:	1900	1900	1900	1900	1900	1900	1900	1900	1900	1900	1900	1900
Adjustment:	0.92	0.98	0.95	0.92	1.00	0.92	0.92	1.00	0.92	0.92	1.00	0.92
Lanes:	1.00	1.64	0.36	1.00	2.00	1.00	1.00	1.00	1.00	1.00	2.00	1.00
Final Sat.:	1750	3058	642	1750	3800	1750	1750	1900	1750	1750	3800	1750
Capacity Analysis Module:												
Vol/Sat:	0.13	0.43	0.43	0.04	0.12	0.27	0.00	0.00	0.02	0.05	0.15	0.08
Crit Moves:	****			****			****			****		
Green Time:	27.4	75.4	75.4	7.0	55.0	55.0	10.0	10.0	10.0	25.6	25.6	25.6
Volume/Cap:	0.64	0.74	0.74	0.68	0.28	0.64	0.06	0.03	0.26	0.26	0.74	0.40
Delay/Veh:	50.5	21.6	21.6	78.6	24.6	31.6	55.8	55.6	57.5	44.6	53.2	46.3
User DelAdj:	1.00	1.00	1.00	1.00	1.00	1.00	1.00	1.00	1.00	1.00	1.00	1.00
AdjDel/Veh:	50.5	21.6	21.6	78.6	24.6	31.6	55.8	55.6	57.5	44.6	53.2	46.3
LOS by Move:	D	C	C	E	C	C	E	E	E	D	D	D
HCM2k95thQ:	19	41	41	6	11	28	1	0	3	6	20	10

Note: Queue reported is the number of cars per lane.

BART Phase II Extension Project

Level Of Service Computation Report
2000 HCM Operations (Future Volume Alternative)
PM - 2025 No Project Conditions

Intersection #3690: MERIDIAN/PARKMOOR

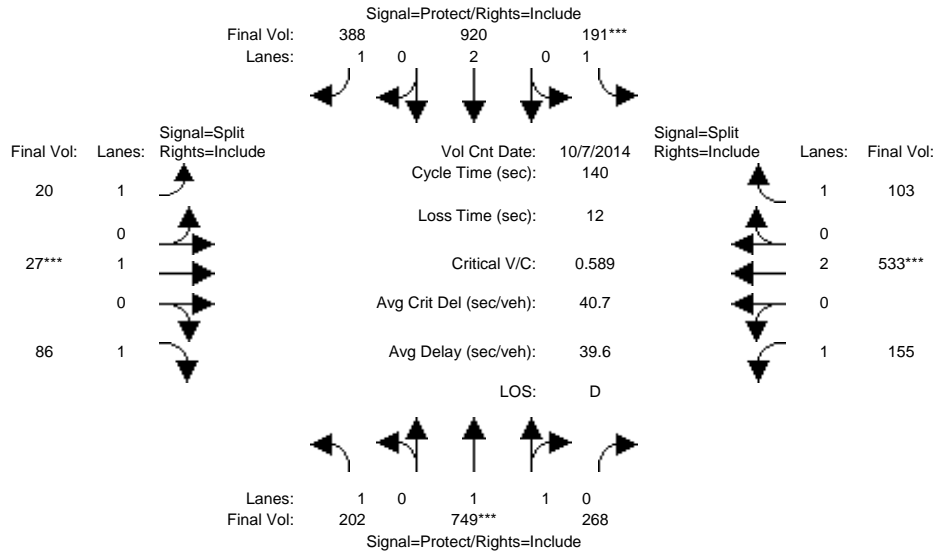

Approach:	North Bound			South Bound			East Bound			West Bound		
	L	T	R	L	T	R	L	T	R	L	T	R
Min. Green:	7	10	10	7	10	10	10	10	10	10	10	10
Y+R:	4.0	4.0	4.0	4.0	4.0	4.0	4.0	4.0	4.0	4.0	4.0	4.0
Volume Module: >> Count Date: 7 Oct 2014 <<												
Base Vol:	202	749	268	191	920	388	20	27	86	155	533	103
Growth Adj:	1.00	1.00	1.00	1.00	1.00	1.00	1.00	1.00	1.00	1.00	1.00	1.00
Initial Bse:	202	749	268	191	920	388	20	27	86	155	533	103
Added Vol:	0	0	0	0	0	0	0	0	0	0	0	0
PasserByVol:	0	0	0	0	0	0	0	0	0	0	0	0
Initial Fut:	202	749	268	191	920	388	20	27	86	155	533	103
User Adj:	1.00	1.00	1.00	1.00	1.00	1.00	1.00	1.00	1.00	1.00	1.00	1.00
PHF Adj:	1.00	1.00	1.00	1.00	1.00	1.00	1.00	1.00	1.00	1.00	1.00	1.00
PHF Volume:	202	749	268	191	920	388	20	27	86	155	533	103
Reduct Vol:	0	0	0	0	0	0	0	0	0	0	0	0
Reduced Vol:	202	749	268	191	920	388	20	27	86	155	533	103
PCE Adj:	1.00	1.00	1.00	1.00	1.00	1.00	1.00	1.00	1.00	1.00	1.00	1.00
MLF Adj:	1.00	1.00	1.00	1.00	1.00	1.00	1.00	1.00	1.00	1.00	1.00	1.00
FinalVolume:	202	749	268	191	920	388	20	27	86	155	533	103
Saturation Flow Module:												
Sat/Lane:	1900	1900	1900	1900	1900	1900	1900	1900	1900	1900	1900	1900
Adjustment:	0.92	0.98	0.95	0.92	1.00	0.92	0.92	1.00	0.92	0.92	1.00	0.92
Lanes:	1.00	1.46	0.54	1.00	2.00	1.00	1.00	1.00	1.00	1.00	2.00	1.00
Final Sat.:	1750	2724	975	1750	3800	1750	1750	1900	1750	1750	3800	1750
Capacity Analysis Module:												
Vol/Sat:	0.12	0.27	0.27	0.11	0.24	0.22	0.01	0.01	0.05	0.09	0.14	0.06
Crit Moves:	****			****			****			****		
Green Time:	27.5	61.0	61.0	24.2	57.7	57.7	11.7	11.7	11.7	31.1	31.1	31.1
Volume/Cap:	0.59	0.63	0.63	0.63	0.59	0.54	0.14	0.17	0.59	0.40	0.63	0.26
Delay/Veh:	53.7	31.6	31.6	58.0	32.5	31.9	59.9	60.2	68.0	47.1	50.8	45.4
User DelAdj:	1.00	1.00	1.00	1.00	1.00	1.00	1.00	1.00	1.00	1.00	1.00	1.00
AdjDel/Veh:	53.7	31.6	31.6	58.0	32.5	31.9	59.9	60.2	68.0	47.1	50.8	45.4
LOS by Move:	D	C	C	E	C	C	E	E	E	D	D	D
HCM2k95thQ:	17	30	30	15	26	24	2	2	8	11	19	8

Note: Queue reported is the number of cars per lane.

BART Phase II Extension Project

Level Of Service Computation Report
 2000 HCM Operations (Future Volume Alternative)
 AM - 2025 No Project Conditions

Intersection #3693: MERIDIAN/SAN CARLOS

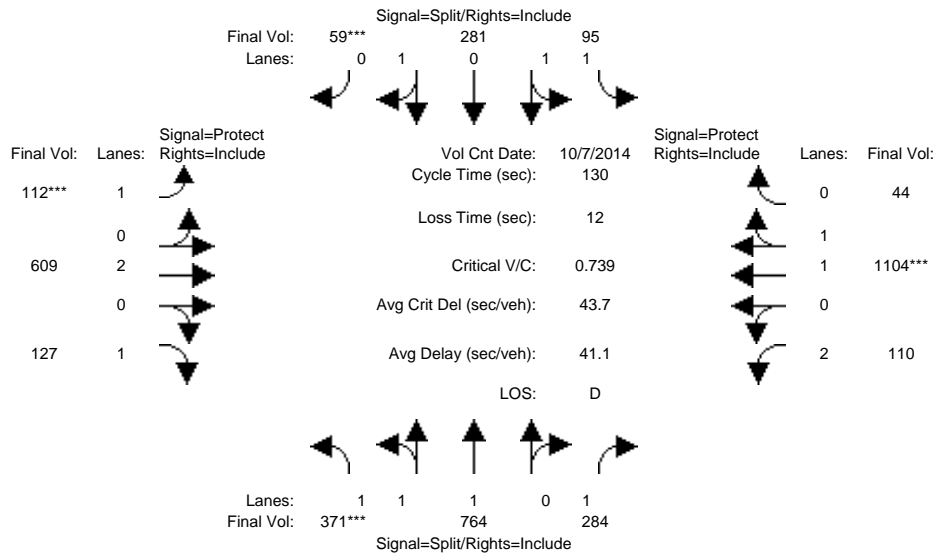

Approach:	North Bound			South Bound			East Bound			West Bound		
	L	T	R	L	T	R	L	T	R	L	T	R
Min. Green:	10	10	10	10	10	10	7	10	10	7	10	10
Y+R:	4.0	4.0	4.0	4.0	4.0	4.0	4.0	4.0	4.0	4.0	4.0	4.0
Volume Module: >> Count Date: 7 Oct 2014 <<												
Base Vol:	371	764	284	95	281	59	112	609	127	110	1104	44
Growth Adj:	1.00	1.00	1.00	1.00	1.00	1.00	1.00	1.00	1.00	1.00	1.00	1.00
Initial Bse:	371	764	284	95	281	59	112	609	127	110	1104	44
Added Vol:	0	0	0	0	0	0	0	0	0	0	0	0
PasserByVol:	0	0	0	0	0	0	0	0	0	0	0	0
Initial Fut:	371	764	284	95	281	59	112	609	127	110	1104	44
User Adj:	1.00	1.00	1.00	1.00	1.00	1.00	1.00	1.00	1.00	1.00	1.00	1.00
PHF Adj:	1.00	1.00	1.00	1.00	1.00	1.00	1.00	1.00	1.00	1.00	1.00	1.00
PHF Volume:	371	764	284	95	281	59	112	609	127	110	1104	44
Reduct Vol:	0	0	0	0	0	0	0	0	0	0	0	0
Reduced Vol:	371	764	284	95	281	59	112	609	127	110	1104	44
PCE Adj:	1.00	1.00	1.00	1.00	1.00	1.00	1.00	1.00	1.00	1.00	1.00	1.00
MLF Adj:	1.00	1.00	1.00	1.00	1.00	1.00	1.00	1.00	1.00	1.00	1.00	1.00
FinalVolume:	371	764	284	95	281	59	112	609	127	110	1104	44
Saturation Flow Module:												
Sat/Lane:	1900	1900	1900	1900	1900	1900	1900	1900	1900	1900	1900	1900
Adjustment:	0.92	1.00	0.92	0.92	0.98	0.95	0.92	1.00	0.92	0.83	0.97	0.95
Lanes:	1.04	1.96	1.00	1.00	1.64	0.36	1.00	2.00	1.00	2.00	1.92	0.08
Final Sat.:	1812	3732	1750	1750	3057	642	1750	3800	1750	3150	3558	142
Capacity Analysis Module:												
Vol/Sat:	0.20	0.20	0.16	0.05	0.09	0.09	0.06	0.16	0.07	0.03	0.31	0.31
Crit Moves:	****					****	****				****	
Green Time:	36.0	36.0	36.0	16.2	16.2	16.2	11.3	49.3	49.3	16.6	54.6	54.6
Volume/Cap:	0.74	0.74	0.59	0.44	0.74	0.74	0.74	0.42	0.19	0.27	0.74	0.74
Delay/Veh:	44.7	44.7	42.4	53.0	59.8	59.8	75.4	30.0	27.2	51.7	33.6	33.6
User DelAdj:	1.00	1.00	1.00	1.00	1.00	1.00	1.00	1.00	1.00	1.00	1.00	1.00
AdjDel/Veh:	44.7	44.7	42.4	53.0	59.8	59.8	75.4	30.0	27.2	51.7	33.6	33.6
LOS by Move:	D	D	D	D	E	E	E	C	C	D	C	C
HCM2k95thQ:	25	25	19	7	13	13	10	16	7	5	34	34

Note: Queue reported is the number of cars per lane.

BART Phase II Extension Project

Level Of Service Computation Report
 2000 HCM Operations (Future Volume Alternative)
 PM - 2025 No Project Conditions

Intersection #3693: MERIDIAN/SAN CARLOS

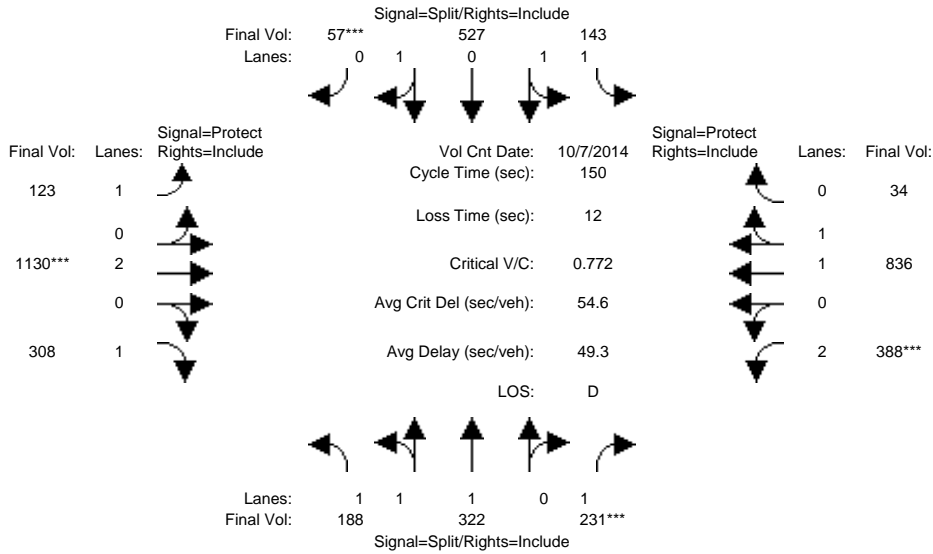

Approach:	North Bound			South Bound			East Bound			West Bound		
	L	T	R	L	T	R	L	T	R	L	T	R
Min. Green:	10	10	10	10	10	10	7	10	10	7	10	10
Y+R:	4.0	4.0	4.0	4.0	4.0	4.0	4.0	4.0	4.0	4.0	4.0	4.0
Volume Module: >> Count Date: 7 Oct 2014 <<												
Base Vol:	188	322	231	143	527	57	123	1130	308	388	836	34
Growth Adj:	1.00	1.00	1.00	1.00	1.00	1.00	1.00	1.00	1.00	1.00	1.00	1.00
Initial Bse:	188	322	231	143	527	57	123	1130	308	388	836	34
Added Vol:	0	0	0	0	0	0	0	0	0	0	0	0
PasserByVol:	0	0	0	0	0	0	0	0	0	0	0	0
Initial Fut:	188	322	231	143	527	57	123	1130	308	388	836	34
User Adj:	1.00	1.00	1.00	1.00	1.00	1.00	1.00	1.00	1.00	1.00	1.00	1.00
PHF Adj:	1.00	1.00	1.00	1.00	1.00	1.00	1.00	1.00	1.00	1.00	1.00	1.00
PHF Volume:	188	322	231	143	527	57	123	1130	308	388	836	34
Reduct Vol:	0	0	0	0	0	0	0	0	0	0	0	0
Reduced Vol:	188	322	231	143	527	57	123	1130	308	388	836	34
PCE Adj:	1.00	1.00	1.00	1.00	1.00	1.00	1.00	1.00	1.00	1.00	1.00	1.00
MLF Adj:	1.00	1.00	1.00	1.00	1.00	1.00	1.00	1.00	1.00	1.00	1.00	1.00
FinalVolume:	188	322	231	143	527	57	123	1130	308	388	836	34
Saturation Flow Module:												
Sat/Lane:	1900	1900	1900	1900	1900	1900	1900	1900	1900	1900	1900	1900
Adjustment:	0.92	0.98	0.92	0.92	0.98	0.95	0.92	1.00	0.92	0.83	0.97	0.95
Lanes:	1.14	1.86	1.00	1.00	1.80	0.20	1.00	2.00	1.00	2.00	1.92	0.08
Final Sat.:	2008	3439	1750	1750	3339	361	1750	3800	1750	3150	3555	145
Capacity Analysis Module:												
Vol/Sat:	0.09	0.09	0.13	0.08	0.16	0.16	0.07	0.30	0.18	0.12	0.24	0.24
Crit Moves:			****			****		****		****		
Green Time:	25.6	25.6	25.6	30.7	30.7	30.7	18.8	57.8	57.8	23.9	62.9	62.9
Volume/Cap:	0.55	0.55	0.77	0.40	0.77	0.77	0.56	0.77	0.46	0.77	0.56	0.56
Delay/Veh:	57.6	57.6	71.1	51.8	60.4	60.4	65.0	43.0	34.9	67.7	33.5	33.5
User DelAdj:	1.00	1.00	1.00	1.00	1.00	1.00	1.00	1.00	1.00	1.00	1.00	1.00
AdjDel/Veh:	57.6	57.6	71.1	51.8	60.4	60.4	65.0	43.0	34.9	67.7	33.5	33.5
LOS by Move:	E	E	E	D	E	E	E	D	C	E	C	C
HCM2k95thQ:	14	14	21	11	24	24	11	38	20	20	27	27

Note: Queue reported is the number of cars per lane.

BART Phase II Extension Project

Level Of Service Computation Report
 2000 HCM Operations (Future Volume Alternative)
 AM - 2025 No Project Conditions

Intersection #3709: MONTGOMERY/PARK

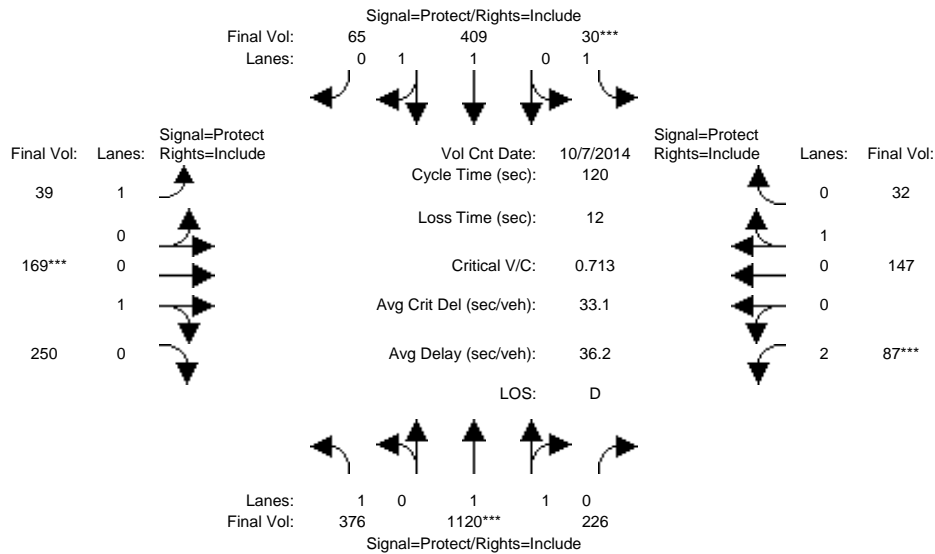

Approach:	North Bound			South Bound			East Bound			West Bound		
	L	T	R	L	T	R	L	T	R	L	T	R
Min. Green:	7	10	10	7	10	10	7	10	10	7	10	10
Y+R:	4.0	4.0	4.0	4.0	4.0	4.0	4.0	4.0	4.0	4.0	4.0	4.0
Volume Module: >> Count Date: 7 Oct 2014 <<												
Base Vol:	376	1120	226	30	409	65	39	169	250	87	147	32
Growth Adj:	1.00	1.00	1.00	1.00	1.00	1.00	1.00	1.00	1.00	1.00	1.00	1.00
Initial Bse:	376	1120	226	30	409	65	39	169	250	87	147	32
Added Vol:	0	0	0	0	0	0	0	0	0	0	0	0
PasserByVol:	0	0	0	0	0	0	0	0	0	0	0	0
Initial Fut:	376	1120	226	30	409	65	39	169	250	87	147	32
User Adj:	1.00	1.00	1.00	1.00	1.00	1.00	1.00	1.00	1.00	1.00	1.00	1.00
PHF Adj:	1.00	1.00	1.00	1.00	1.00	1.00	1.00	1.00	1.00	1.00	1.00	1.00
PHF Volume:	376	1120	226	30	409	65	39	169	250	87	147	32
Reduct Vol:	0	0	0	0	0	0	0	0	0	0	0	0
Reduced Vol:	376	1120	226	30	409	65	39	169	250	87	147	32
PCE Adj:	1.00	1.00	1.00	1.00	1.00	1.00	1.00	1.00	1.00	1.00	1.00	1.00
MLF Adj:	1.00	1.00	1.00	1.00	1.00	1.00	1.00	1.00	1.00	1.00	1.00	1.00
FinalVolume:	376	1120	226	30	409	65	39	169	250	87	147	32
Saturation Flow Module:												
Sat/Lane:	1900	1900	1900	1900	1900	1900	1900	1900	1900	1900	1900	1900
Adjustment:	0.92	0.98	0.95	0.92	0.98	0.95	0.92	0.95	0.95	0.83	0.95	0.95
Lanes:	1.00	1.65	0.35	1.00	1.72	0.28	1.00	0.40	0.60	2.00	0.82	0.18
Final Sat.:	1750	3078	621	1750	3192	507	1750	726	1074	3150	1478	322
Capacity Analysis Module:												
Vol/Sat:	0.21	0.36	0.36	0.02	0.13	0.13	0.02	0.23	0.23	0.03	0.10	0.10
Crit Moves:	****			****			****			****		
Green Time:	40.3	57.3	57.3	7.0	24.0	24.0	16.1	36.7	36.7	7.0	27.5	27.5
Volume/Cap:	0.64	0.76	0.76	0.29	0.64	0.64	0.17	0.76	0.76	0.47	0.43	0.43
Delay/Veh:	36.1	27.7	27.7	55.7	45.9	45.9	46.3	43.9	43.9	56.6	40.3	40.3
User DelAdj:	1.00	1.00	1.00	1.00	1.00	1.00	1.00	1.00	1.00	1.00	1.00	1.00
AdjDel/Veh:	36.1	27.7	27.7	55.7	45.9	45.9	46.3	43.9	43.9	56.6	40.3	40.3
LOS by Move:	D	C	C	E	D	D	D	D	D	E	D	D
HCM2k95thQ:	23	36	36	3	17	17	3	27	27	4	11	11

Note: Queue reported is the number of cars per lane.

BART Phase II Extension Project

Level Of Service Computation Report
 2000 HCM Operations (Future Volume Alternative)
 PM - 2025 No Project Conditions

Intersection #3709: MONTGOMERY/PARK

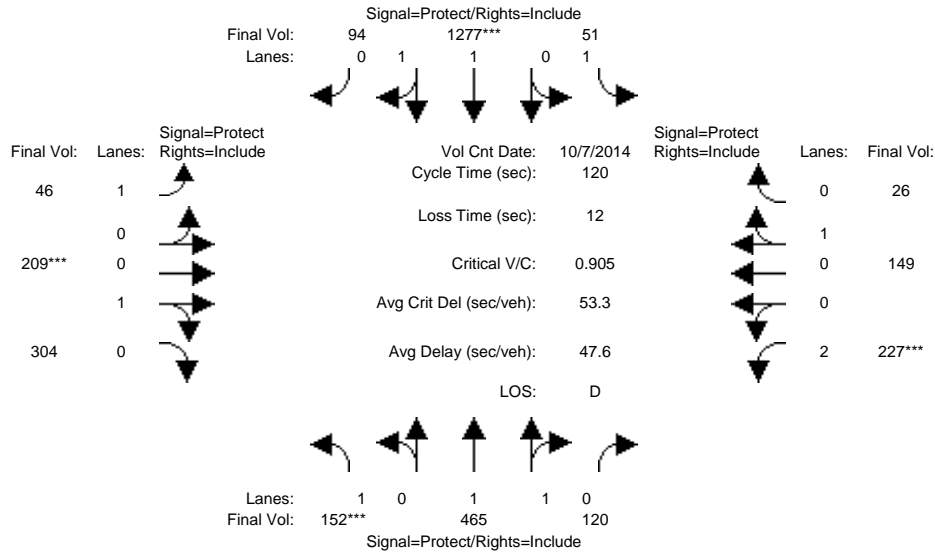

Approach:	North Bound			South Bound			East Bound			West Bound		
	L	T	R	L	T	R	L	T	R	L	T	R
Min. Green:	7	10	10	7	10	10	7	10	10	7	10	10
Y+R:	4.0	4.0	4.0	4.0	4.0	4.0	4.0	4.0	4.0	4.0	4.0	4.0

Volume Module:	>> Count Date: 7 Oct 2014 <<											
Base Vol:	152	465	120	51	1277	94	46	209	304	227	149	26
Growth Adj:	1.00	1.00	1.00	1.00	1.00	1.00	1.00	1.00	1.00	1.00	1.00	1.00
Initial Bse:	152	465	120	51	1277	94	46	209	304	227	149	26
Added Vol:	0	0	0	0	0	0	0	0	0	0	0	0
PasserByVol:	0	0	0	0	0	0	0	0	0	0	0	0
Initial Fut:	152	465	120	51	1277	94	46	209	304	227	149	26
User Adj:	1.00	1.00	1.00	1.00	1.00	1.00	1.00	1.00	1.00	1.00	1.00	1.00
PHF Adj:	1.00	1.00	1.00	1.00	1.00	1.00	1.00	1.00	1.00	1.00	1.00	1.00
PHF Volume:	152	465	120	51	1277	94	46	209	304	227	149	26
Reduct Vol:	0	0	0	0	0	0	0	0	0	0	0	0
Reduced Vol:	152	465	120	51	1277	94	46	209	304	227	149	26
PCE Adj:	1.00	1.00	1.00	1.00	1.00	1.00	1.00	1.00	1.00	1.00	1.00	1.00
MLF Adj:	1.00	1.00	1.00	1.00	1.00	1.00	1.00	1.00	1.00	1.00	1.00	1.00
FinalVolume:	152	465	120	51	1277	94	46	209	304	227	149	26

Saturation Flow Module:												
Sat/Lane:	1900	1900	1900	1900	1900	1900	1900	1900	1900	1900	1900	1900
Adjustment:	0.92	0.98	0.95	0.92	0.98	0.95	0.92	0.95	0.95	0.83	0.95	0.95
Lanes:	1.00	1.58	0.42	1.00	1.86	0.14	1.00	0.41	0.59	2.00	0.85	0.15
Final Sat.:	1750	2940	759	1750	3446	254	1750	733	1067	3150	1533	267

Capacity Analysis Module:												
Vol/Sat:	0.09	0.16	0.16	0.03	0.37	0.37	0.03	0.29	0.29	0.07	0.10	0.10
Crit Moves:	****			****			****			****		
Green Time:	11.5	44.3	44.3	16.3	49.1	49.1	17.8	37.8	37.8	9.6	29.6	29.6
Volume/Cap:	0.90	0.43	0.43	0.21	0.90	0.90	0.18	0.90	0.90	0.90	0.39	0.39
Delay/Veh:	96.8	28.6	28.6	46.6	41.3	41.3	45.1	57.4	57.4	87.6	38.3	38.3
User DelAdj:	1.00	1.00	1.00	1.00	1.00	1.00	1.00	1.00	1.00	1.00	1.00	1.00
AdjDel/Veh:	96.8	28.6	28.6	46.6	41.3	41.3	45.1	57.4	57.4	87.6	38.3	38.3
LOS by Move:	F	C	C	D	D	D	D	E	E	F	D	D
HCM2k95thQ:	13	15	15	4	45	45	3	35	35	11	11	11

Note: Queue reported is the number of cars per lane.

BART Phase II Extension Project

Level Of Service Computation Report
 2000 HCM Operations (Future Volume Alternative)
 AM - 2025 No Project Conditions

Intersection #3710: MONTGOMERY/SAN FERNANDO

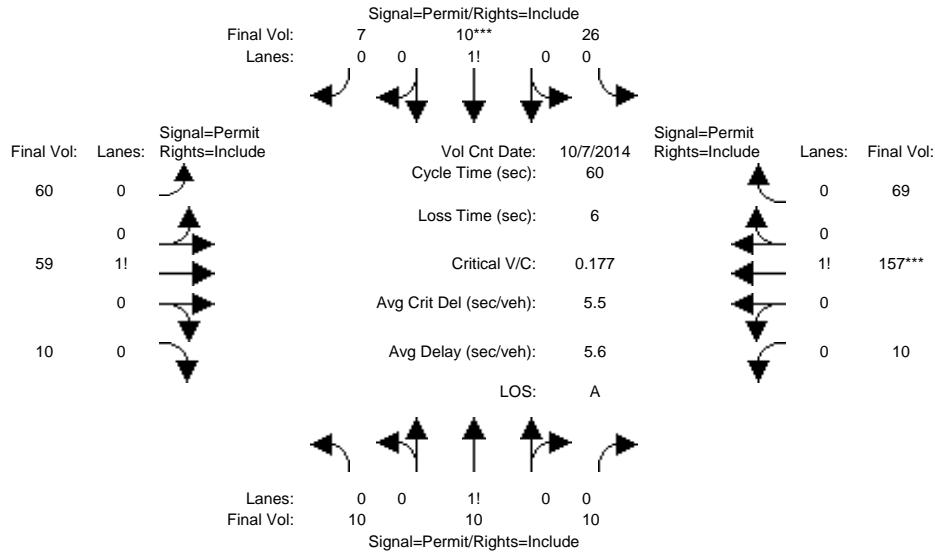

Approach:	North Bound			South Bound			East Bound			West Bound			
	L	T	R	L	T	R	L	T	R	L	T	R	
Min. Green:	10	10	10	10	10	10	10	10	10	10	10	10	
Y+R:	4.0	4.0	4.0	4.0	4.0	4.0	4.0	4.0	4.0	4.0	4.0	4.0	
Volume Module: >> Count Date: 7 Oct 2014 <<													
Base Vol:	10	10	10	26	10	7	60	59	10	10	157	69	
Growth Adj:	1.00	1.00	1.00	1.00	1.00	1.00	1.00	1.00	1.00	1.00	1.00	1.00	
Initial Bse:	10	10	10	26	10	7	60	59	10	10	157	69	
Added Vol:	0	0	0	0	0	0	0	0	0	0	0	0	
PasserByVol:	0	0	0	0	0	0	0	0	0	0	0	0	
Initial Fut:	10	10	10	26	10	7	60	59	10	10	157	69	
User Adj:	1.00	1.00	1.00	1.00	1.00	1.00	1.00	1.00	1.00	1.00	1.00	1.00	
PHF Adj:	1.00	1.00	1.00	1.00	1.00	1.00	1.00	1.00	1.00	1.00	1.00	1.00	
PHF Volume:	10	10	10	26	10	7	60	59	10	10	157	69	
Reduct Vol:	0	0	0	0	0	0	0	0	0	0	0	0	
Reduced Vol:	10	10	10	26	10	7	60	59	10	10	157	69	
PCE Adj:	1.00	1.00	1.00	1.00	1.00	1.00	1.00	1.00	1.00	1.00	1.00	1.00	
MLF Adj:	1.00	1.00	1.00	1.00	1.00	1.00	1.00	1.00	1.00	1.00	1.00	1.00	
FinalVolume:	10	10	10	26	10	7	60	59	10	10	157	69	
Saturation Flow Module:													
Sat/Lane:	1900	1900	1900	1900	1900	1900	1900	1900	1900	1900	1900	1900	
Adjustment:	0.92	0.92	0.92	0.92	0.92	0.92	0.92	0.92	0.92	0.92	0.92	0.92	
Lanes:	0.34	0.33	0.33	0.61	0.23	0.16	0.46	0.46	0.08	0.04	0.67	0.29	
Final Sat.:	583	583	583	1058	407	285	814	800	136	74	1164	512	
Capacity Analysis Module:													
Vol/Sat:	0.02	0.02	0.02	0.02	0.02	0.02	0.07	0.07	0.07	0.13	0.13	0.13	
Crit Moves:							****						
Green Time:	10.0	10.0	10.0	10.0	10.0	10.0	44.0	44.0	44.0	44.0	44.0	44.0	
Volume/Cap:	0.10	0.10	0.10	0.15	0.15	0.15	0.10	0.10	0.10	0.18	0.18	0.18	
Delay/Veh:	21.4	21.4	21.4	21.6	21.6	21.6	2.3	2.3	2.3	2.5	2.5	2.5	
User DelAdj:	1.00	1.00	1.00	1.00	1.00	1.00	1.00	1.00	1.00	1.00	1.00	1.00	
AdjDel/Veh:	21.4	21.4	21.4	21.6	21.6	21.6	2.3	2.3	2.3	2.5	2.5	2.5	
LOS by Move:	C	C	C	C	C	C	A	A	A	A	A	A	
HCM2k95thQ:	1	1	1	1	1	1	2	2	2	3	3	3	

Note: Queue reported is the number of cars per lane.

BART Phase II Extension Project

Level Of Service Computation Report
 2000 HCM Operations (Future Volume Alternative)
 PM - 2025 No Project Conditions

Intersection #3710: MONTGOMERY/SAN FERNANDO

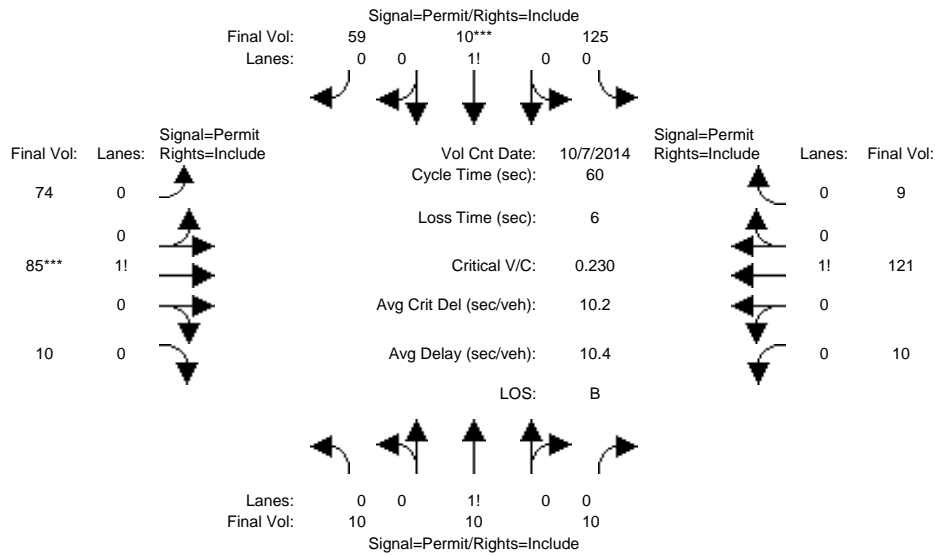

Approach:	North Bound			South Bound			East Bound			West Bound		
	L	T	R	L	T	R	L	T	R	L	T	R
Min. Green:	10	10	10	10	10	10	10	10	10	10	10	10
Y+R:	4.0	4.0	4.0	4.0	4.0	4.0	4.0	4.0	4.0	4.0	4.0	4.0

Volume Module: >> Count Date: 7 Oct 2014 <<

Base Vol:	10	10	10	125	10	59	74	85	10	10	121	9
Growth Adj:	1.00	1.00	1.00	1.00	1.00	1.00	1.00	1.00	1.00	1.00	1.00	1.00
Initial Bse:	10	10	10	125	10	59	74	85	10	10	121	9
Added Vol:	0	0	0	0	0	0	0	0	0	0	0	0
PasserByVol:	0	0	0	0	0	0	0	0	0	0	0	0
Initial Fut:	10	10	10	125	10	59	74	85	10	10	121	9
User Adj:	1.00	1.00	1.00	1.00	1.00	1.00	1.00	1.00	1.00	1.00	1.00	1.00
PHF Adj:	1.00	1.00	1.00	1.00	1.00	1.00	1.00	1.00	1.00	1.00	1.00	1.00
PHF Volume:	10	10	10	125	10	59	74	85	10	10	121	9
Reduct Vol:	0	0	0	0	0	0	0	0	0	0	0	0
Reduced Vol:	10	10	10	125	10	59	74	85	10	10	121	9
PCE Adj:	1.00	1.00	1.00	1.00	1.00	1.00	1.00	1.00	1.00	1.00	1.00	1.00
MLF Adj:	1.00	1.00	1.00	1.00	1.00	1.00	1.00	1.00	1.00	1.00	1.00	1.00
FinalVolume:	10	10	10	125	10	59	74	85	10	10	121	9

Saturation Flow Module:

Sat/Lane:	1900	1900	1900	1900	1900	1900	1900	1900	1900	1900	1900	1900
Adjustment:	0.92	0.92	0.92	0.92	0.92	0.92	0.92	0.92	0.92	0.92	0.92	0.92
Lanes:	0.34	0.33	0.33	0.65	0.05	0.30	0.44	0.50	0.06	0.07	0.87	0.06
Final Sat.:	583	583	583	1128	90	532	766	880	104	125	1513	113

Capacity Analysis Module:

Vol/Sat:	0.02	0.02	0.02	0.11	0.11	0.11	0.10	0.10	0.10	0.08	0.08	0.08
Crit Moves:				****			****					
Green Time:	28.9	28.9	28.9	28.9	28.9	28.9	25.1	25.1	25.1	25.1	25.1	25.1
Volume/Cap:	0.04	0.04	0.04	0.23	0.23	0.23	0.23	0.23	0.23	0.19	0.19	0.19
Delay/Veh:	8.2	8.2	8.2	9.2	9.2	9.2	11.4	11.4	11.4	11.1	11.1	11.1
User DelAdj:	1.00	1.00	1.00	1.00	1.00	1.00	1.00	1.00	1.00	1.00	1.00	1.00
AdjDel/Veh:	8.2	8.2	8.2	9.2	9.2	9.2	11.4	11.4	11.4	11.1	11.1	11.1
LOS by Move:	A	A	A	A	A	A	B	B	B	B	B	B
HCM2k95thQ:	1	1	1	4	4	4	5	5	5	3	3	3

Note: Queue reported is the number of cars per lane.

BART Phase II Extension Project

Level Of Service Computation Report
 2000 HCM Operations (Future Volume Alternative)
 AM - 2025 No Project Conditions

Intersection #3748: RACE/SAN CARLOS

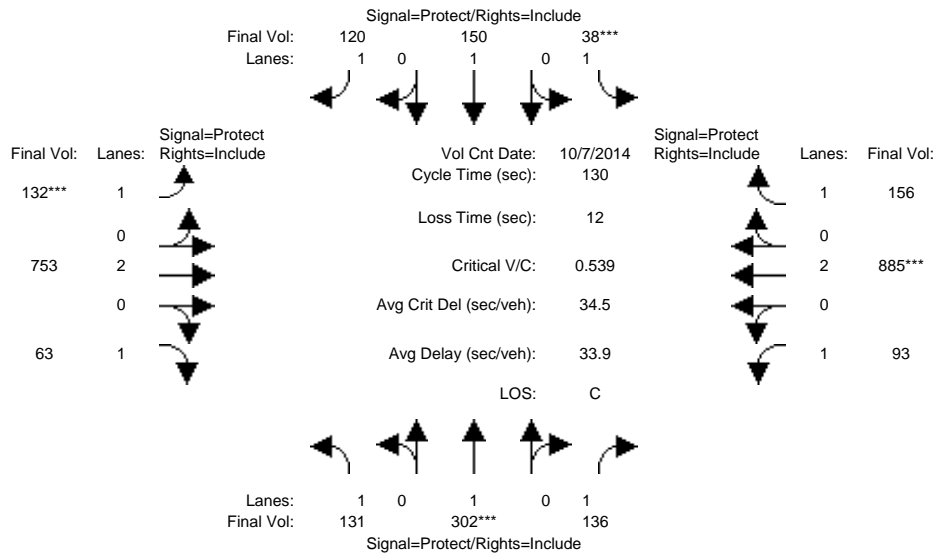

Approach:	North Bound			South Bound			East Bound			West Bound		
	L	T	R	L	T	R	L	T	R	L	T	R
Min. Green:	7	10	10	7	10	10	7	10	10	7	10	10
Y+R:	4.0	4.0	4.0	4.0	4.0	4.0	4.0	4.0	4.0	4.0	4.0	4.0
Volume Module: >> Count Date: 7 Oct 2014 <<												
Base Vol:	131	302	136	38	150	120	132	753	63	93	885	156
Growth Adj:	1.00	1.00	1.00	1.00	1.00	1.00	1.00	1.00	1.00	1.00	1.00	1.00
Initial Bse:	131	302	136	38	150	120	132	753	63	93	885	156
Added Vol:	0	0	0	0	0	0	0	0	0	0	0	0
PasserByVol:	0	0	0	0	0	0	0	0	0	0	0	0
Initial Fut:	131	302	136	38	150	120	132	753	63	93	885	156
User Adj:	1.00	1.00	1.00	1.00	1.00	1.00	1.00	1.00	1.00	1.00	1.00	1.00
PHF Adj:	1.00	1.00	1.00	1.00	1.00	1.00	1.00	1.00	1.00	1.00	1.00	1.00
PHF Volume:	131	302	136	38	150	120	132	753	63	93	885	156
Reduct Vol:	0	0	0	0	0	0	0	0	0	0	0	0
Reduced Vol:	131	302	136	38	150	120	132	753	63	93	885	156
PCE Adj:	1.00	1.00	1.00	1.00	1.00	1.00	1.00	1.00	1.00	1.00	1.00	1.00
MLF Adj:	1.00	1.00	1.00	1.00	1.00	1.00	1.00	1.00	1.00	1.00	1.00	1.00
FinalVolume:	131	302	136	38	150	120	132	753	63	93	885	156
Saturation Flow Module:												
Sat/Lane:	1900	1900	1900	1900	1900	1900	1900	1900	1900	1900	1900	1900
Adjustment:	0.92	1.00	0.92	0.92	1.00	0.92	0.92	1.00	0.92	0.92	1.00	0.92
Lanes:	1.00	1.00	1.00	1.00	1.00	1.00	1.00	2.00	1.00	1.00	2.00	1.00
Final Sat.:	1750	1900	1750	1750	1900	1750	1750	3800	1750	1750	3800	1750
Capacity Analysis Module:												
Vol/Sat:	0.07	0.16	0.08	0.02	0.08	0.07	0.08	0.20	0.04	0.05	0.23	0.09
Crit Moves:	****			****			****			****		
Green Time:	21.8	37.8	37.8	7.0	23.0	23.0	17.9	57.6	57.6	15.6	55.3	55.3
Volume/Cap:	0.45	0.55	0.27	0.40	0.45	0.39	0.55	0.45	0.08	0.44	0.55	0.21
Delay/Veh:	49.8	40.1	35.8	62.3	48.8	48.1	54.9	25.3	21.0	54.6	28.4	23.7
User DelAdj:	1.00	1.00	1.00	1.00	1.00	1.00	1.00	1.00	1.00	1.00	1.00	1.00
AdjDel/Veh:	49.8	40.1	35.8	62.3	48.8	48.1	54.9	25.3	21.0	54.6	28.4	23.7
LOS by Move:	D	D	D	E	D	D	D	C	C	D	C	C
HCM2k95thQ:	10	18	9	3	10	9	10	19	3	7	23	8

Note: Queue reported is the number of cars per lane.

BART Phase II Extension Project

Level Of Service Computation Report
2000 HCM Operations (Future Volume Alternative)
PM - 2025 No Project Conditions

Intersection #3748: RACE/SAN CARLOS

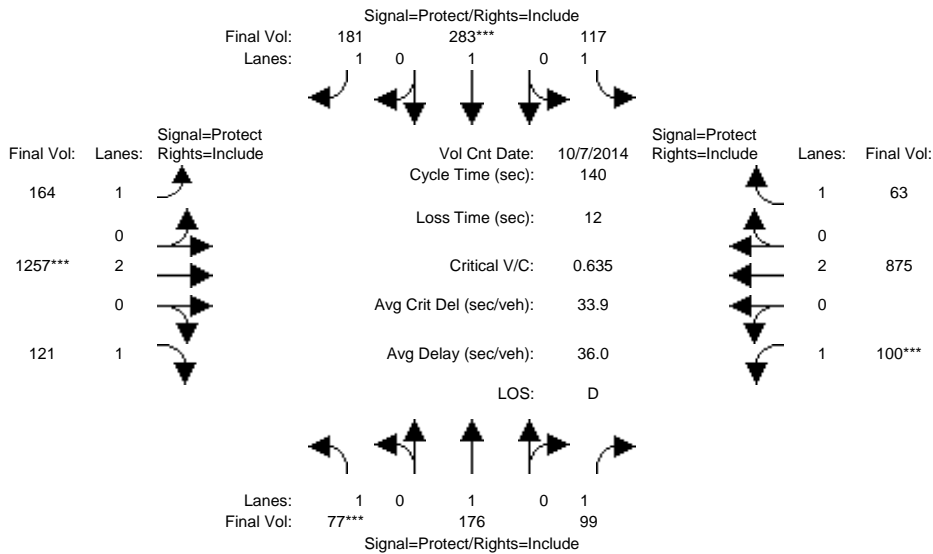

Approach:	North Bound			South Bound			East Bound			West Bound		
Movement:	L	T	R	L	T	R	L	T	R	L	T	R
Min. Green:	7	10	10	7	10	10	7	10	10	7	10	10
Y+R:	4.0	4.0	4.0	4.0	4.0	4.0	4.0	4.0	4.0	4.0	4.0	4.0
Volume Module: >> Count Date: 7 Oct 2014 <<												
Base Vol:	77	176	99	117	283	181	164	1257	121	100	875	63
Growth Adj:	1.00	1.00	1.00	1.00	1.00	1.00	1.00	1.00	1.00	1.00	1.00	1.00
Initial Bse:	77	176	99	117	283	181	164	1257	121	100	875	63
Added Vol:	0	0	0	0	0	0	0	0	0	0	0	0
PasserByVol:	0	0	0	0	0	0	0	0	0	0	0	0
Initial Fut:	77	176	99	117	283	181	164	1257	121	100	875	63
User Adj:	1.00	1.00	1.00	1.00	1.00	1.00	1.00	1.00	1.00	1.00	1.00	1.00
PHF Adj:	1.00	1.00	1.00	1.00	1.00	1.00	1.00	1.00	1.00	1.00	1.00	1.00
PHF Volume:	77	176	99	117	283	181	164	1257	121	100	875	63
Reduct Vol:	0	0	0	0	0	0	0	0	0	0	0	0
Reduced Vol:	77	176	99	117	283	181	164	1257	121	100	875	63
PCE Adj:	1.00	1.00	1.00	1.00	1.00	1.00	1.00	1.00	1.00	1.00	1.00	1.00
MLF Adj:	1.00	1.00	1.00	1.00	1.00	1.00	1.00	1.00	1.00	1.00	1.00	1.00
FinalVolume:	77	176	99	117	283	181	164	1257	121	100	875	63
Saturation Flow Module:												
Sat/Lane:	1900	1900	1900	1900	1900	1900	1900	1900	1900	1900	1900	1900
Adjustment:	0.92	1.00	0.92	0.92	1.00	0.92	0.92	1.00	0.92	0.92	1.00	0.92
Lanes:	1.00	1.00	1.00	1.00	1.00	1.00	1.00	2.00	1.00	1.00	2.00	1.00
Final Sat.:	1750	1900	1750	1750	1900	1750	1750	3800	1750	1750	3800	1750
Capacity Analysis Module:												
Vol/Sat:	0.04	0.09	0.06	0.07	0.15	0.10	0.09	0.33	0.07	0.06	0.23	0.04
Crit Moves:	****			****			****			****		
Green Time:	9.7	24.7	24.7	17.8	32.8	32.8	24.7	72.9	72.9	12.6	60.8	60.8
Volume/Cap:	0.64	0.53	0.32	0.53	0.64	0.44	0.53	0.64	0.13	0.64	0.53	0.08
Delay/Veh:	74.0	53.9	50.9	59.4	51.2	46.5	54.1	24.7	17.3	69.8	29.5	23.3
User DelAdj:	1.00	1.00	1.00	1.00	1.00	1.00	1.00	1.00	1.00	1.00	1.00	1.00
AdjDel/Veh:	74.0	53.9	50.9	59.4	51.2	46.5	54.1	24.7	17.3	69.8	29.5	23.3
LOS by Move:	E	D	D	E	D	D	D	C	B	E	C	C
HCM2k95thQ:	7	13	8	10	20	13	13	32	6	9	24	3

Note: Queue reported is the number of cars per lane.

BART Phase II Extension Project

Level Of Service Computation Report
 2000 HCM Operations (Future Volume Alternative)
 AM - 2025 No Project Conditions

Intersection #3985: DELMAS/SAN FERNANDO

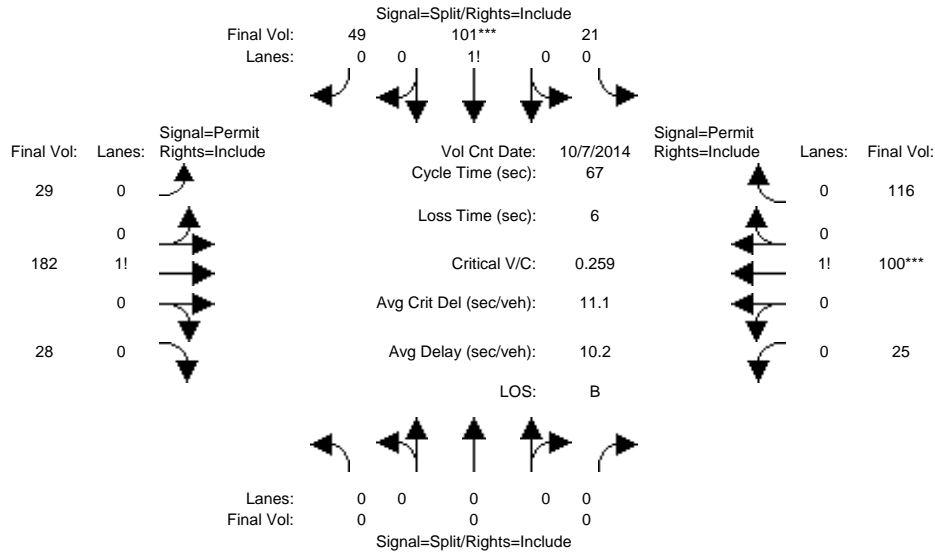

Approach:	North Bound			South Bound			East Bound			West Bound		
	L	T	R	L	T	R	L	T	R	L	T	R
Min. Green:	0	0	0	10	10	10	10	10	10	10	10	10
Y+R:	4.0	4.0	4.0	4.0	4.0	4.0	4.0	4.0	4.0	4.0	4.0	4.0
Volume Module: >> Count Date: 7 Oct 2014 <<												
Base Vol:	0	0	0	21	101	49	29	182	28	25	100	116
Growth Adj:	1.00	1.00	1.00	1.00	1.00	1.00	1.00	1.00	1.00	1.00	1.00	1.00
Initial Bse:	0	0	0	21	101	49	29	182	28	25	100	116
Added Vol:	0	0	0	0	0	0	0	0	0	0	0	0
PasserByVol:	0	0	0	0	0	0	0	0	0	0	0	0
Initial Fut:	0	0	0	21	101	49	29	182	28	25	100	116
User Adj:	1.00	1.00	1.00	1.00	1.00	1.00	1.00	1.00	1.00	1.00	1.00	1.00
PHF Adj:	1.00	1.00	1.00	1.00	1.00	1.00	1.00	1.00	1.00	1.00	1.00	1.00
PHF Volume:	0	0	0	21	101	49	29	182	28	25	100	116
Reduct Vol:	0	0	0	0	0	0	0	0	0	0	0	0
Reduced Vol:	0	0	0	21	101	49	29	182	28	25	100	116
PCE Adj:	1.00	1.00	1.00	1.00	1.00	1.00	1.00	1.00	1.00	1.00	1.00	1.00
MLF Adj:	1.00	1.00	1.00	1.00	1.00	1.00	1.00	1.00	1.00	1.00	1.00	1.00
FinalVolume:	0	0	0	21	101	49	29	182	28	25	100	116
Saturation Flow Module:												
Sat/Lane:	1900	1900	1900	1900	1900	1900	1900	1900	1900	1900	1900	1900
Adjustment:	0.92	1.00	0.92	0.92	0.92	0.92	0.92	0.92	0.92	0.92	0.92	0.92
Lanes:	0.00	0.00	0.00	0.12	0.59	0.29	0.12	0.76	0.12	0.10	0.41	0.49
Final Sat.:	0	0	0	215	1034	501	212	1333	205	182	726	842
Capacity Analysis Module:												
Vol/Sat:	0.00	0.00	0.00	0.10	0.10	0.10	0.14	0.14	0.14	0.14	0.14	0.14
Crit Moves:				****						****		
Green Time:	0.0	0.0	0.0	25.3	25.3	25.3	35.7	35.7	35.7	35.7	35.7	35.7
Volume/Cap:	0.00	0.00	0.00	0.26	0.26	0.26	0.26	0.26	0.26	0.26	0.26	0.26
Delay/Veh:	0.0	0.0	0.0	14.6	14.6	14.6	8.6	8.6	8.6	8.6	8.6	8.6
User DelAdj:	1.00	1.00	1.00	1.00	1.00	1.00	1.00	1.00	1.00	1.00	1.00	1.00
AdjDel/Veh:	0.0	0.0	0.0	14.6	14.6	14.6	8.6	8.6	8.6	8.6	8.6	8.6
LOS by Move:	A	A	A	B	B	B	A	A	A	A	A	A
HCM2k95thQ:	0	0	0	6	6	6	6	6	6	6	6	6

Note: Queue reported is the number of cars per lane.

BART Phase II Extension Project

Level Of Service Computation Report
 2000 HCM Operations (Future Volume Alternative)
 PM - 2025 No Project Conditions

Intersection #3985: DELMAS/SAN FERNANDO

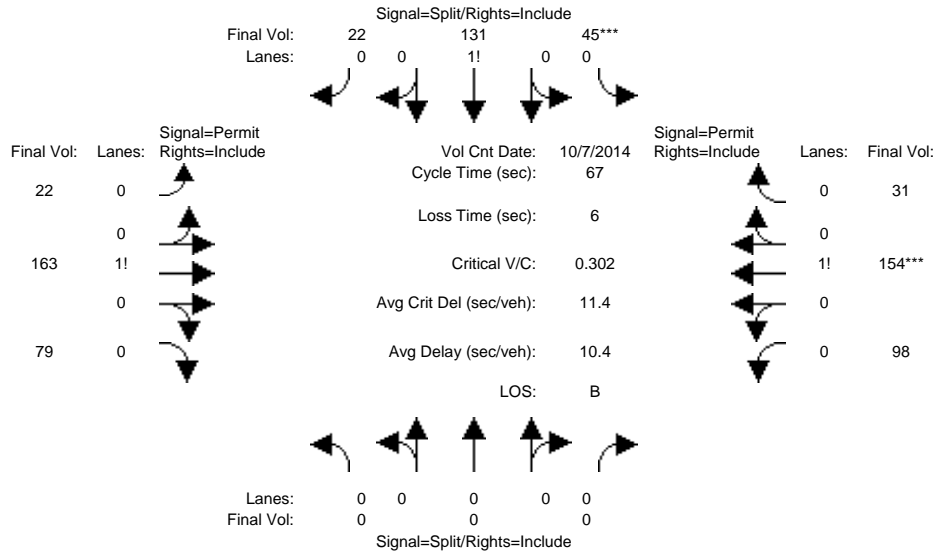

Approach:	North Bound			South Bound			East Bound			West Bound		
	L	T	R	L	T	R	L	T	R	L	T	R
Min. Green:	0	0	0	10	10	10	10	10	10	10	10	10
Y+R:	4.0	4.0	4.0	4.0	4.0	4.0	4.0	4.0	4.0	4.0	4.0	4.0
Volume Module: >> Count Date: 7 Oct 2014 <<												
Base Vol:	0	0	0	45	131	22	22	163	79	98	154	31
Growth Adj:	1.00	1.00	1.00	1.00	1.00	1.00	1.00	1.00	1.00	1.00	1.00	1.00
Initial Bse:	0	0	0	45	131	22	22	163	79	98	154	31
Added Vol:	0	0	0	0	0	0	0	0	0	0	0	0
PasserByVol:	0	0	0	0	0	0	0	0	0	0	0	0
Initial Fut:	0	0	0	45	131	22	22	163	79	98	154	31
User Adj:	1.00	1.00	1.00	1.00	1.00	1.00	1.00	1.00	1.00	1.00	1.00	1.00
PHF Adj:	1.00	1.00	1.00	1.00	1.00	1.00	1.00	1.00	1.00	1.00	1.00	1.00
PHF Volume:	0	0	0	45	131	22	22	163	79	98	154	31
Reduct Vol:	0	0	0	0	0	0	0	0	0	0	0	0
Reduced Vol:	0	0	0	45	131	22	22	163	79	98	154	31
PCE Adj:	1.00	1.00	1.00	1.00	1.00	1.00	1.00	1.00	1.00	1.00	1.00	1.00
MLF Adj:	1.00	1.00	1.00	1.00	1.00	1.00	1.00	1.00	1.00	1.00	1.00	1.00
FinalVolume:	0	0	0	45	131	22	22	163	79	98	154	31
Saturation Flow Module:												
Sat/Lane:	1900	1900	1900	1900	1900	1900	1900	1900	1900	1900	1900	1900
Adjustment:	0.92	1.00	0.92	0.92	0.92	0.92	0.92	0.92	0.92	0.92	0.92	0.92
Lanes:	0.00	0.00	0.00	0.23	0.66	0.11	0.08	0.62	0.30	0.35	0.54	0.11
Final Sat.:	0	0	0	398	1158	194	146	1080	524	606	952	192
Capacity Analysis Module:												
Vol/Sat:	0.00	0.00	0.00	0.11	0.11	0.11	0.15	0.15	0.15	0.16	0.16	0.16
Crit Moves:	****											
Green Time:	0.0	0.0	0.0	25.1	25.1	25.1	35.9	35.9	35.9	35.9	35.9	35.9
Volume/Cap:	0.00	0.00	0.00	0.30	0.30	0.30	0.28	0.28	0.28	0.30	0.30	0.30
Delay/Veh:	0.0	0.0	0.0	15.0	15.0	15.0	8.7	8.7	8.7	8.8	8.8	8.8
User DelAdj:	1.00	1.00	1.00	1.00	1.00	1.00	1.00	1.00	1.00	1.00	1.00	1.00
AdjDel/Veh:	0.0	0.0	0.0	15.0	15.0	15.0	8.7	8.7	8.7	8.8	8.8	8.8
LOS by Move:	A	A	A	B	B	B	A	A	A	A	A	A
HCM2k95thQ:	0	0	0	7	7	7	6	6	6	7	7	7

Note: Queue reported is the number of cars per lane.

BART Phase II Extension Project

Level Of Service Computation Report
 2000 HCM Operations (Future Volume Alternative)
 AM - 2025 Project Conditions

Intersection #3013: 87/JULIAN (E) *

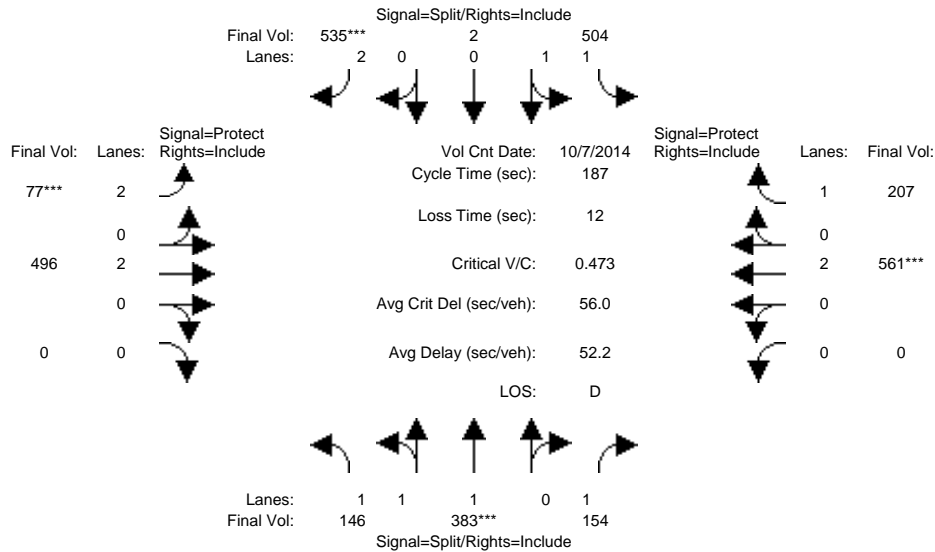

Approach:	North Bound			South Bound			East Bound			West Bound		
	L	T	R	L	T	R	L	T	R	L	T	R
Movement:												
Min. Green:	10	10	10	10	10	10	7	10	0	0	10	10
Y+R:	4.0	4.0	4.0	4.0	4.0	4.0	4.0	4.0	4.0	4.0	4.0	4.0

Volume Module:	>> Count Date: 7 Oct 2014 <<											
Base Vol:	146	383	154	504	2	535	77	496	0	0	561	207
Growth Adj:	1.00	1.00	1.00	1.00	1.00	1.00	1.00	1.00	1.00	1.00	1.00	1.00
Initial Bse:	146	383	154	504	2	535	77	496	0	0	561	207
Added Vol:	0	0	0	0	0	0	0	0	0	0	0	0
PasserByVol:	0	0	0	0	0	0	0	0	0	0	0	0
Initial Fut:	146	383	154	504	2	535	77	496	0	0	561	207
User Adj:	1.00	1.00	1.00	1.00	1.00	1.00	1.00	1.00	1.00	1.00	1.00	1.00
PHF Adj:	1.00	1.00	1.00	1.00	1.00	1.00	1.00	1.00	1.00	1.00	1.00	1.00
PHF Volume:	146	383	154	504	2	535	77	496	0	0	561	207
Reduct Vol:	0	0	0	0	0	0	0	0	0	0	0	0
Reduced Vol:	146	383	154	504	2	535	77	496	0	0	561	207
PCE Adj:	1.00	1.00	1.00	1.00	1.00	1.00	1.00	1.00	1.00	1.00	1.00	1.00
MLF Adj:	1.00	1.00	1.00	1.00	1.00	1.00	1.00	1.00	1.00	1.00	1.00	1.00
Final Volume:	146	383	154	504	2	535	77	496	0	0	561	207

Saturation Flow Module:												
Sat/Lane:	1900	1900	1900	1900	1900	1900	1900	1900	1900	1900	1900	1900
Adjustment:	0.92	1.00	0.92	0.93	0.95	0.83	0.83	1.00	0.92	0.92	1.00	0.92
Lanes:	1.00	2.00	1.00	1.99	0.01	2.00	2.00	2.00	0.00	0.00	2.00	1.00
Final Sat.:	1750	3800	1750	3536	14	3150	3150	3800	0	0	3800	1750

Capacity Analysis Module:												
Vol/Sat:	0.08	0.10	0.09	0.14	0.14	0.17	0.02	0.13	0.00	0.00	0.15	0.12
Crit Moves:	****			****			****			****		
Green Time:	39.8	39.8	39.8	67.1	67.1	67.1	9.7	68.0	0.0	0.0	58.4	58.4
Volume/Cap:	0.39	0.47	0.41	0.40	0.40	0.47	0.47	0.36	0.00	0.00	0.47	0.38
Delay/Veh:	63.4	64.7	64.2	45.0	45.0	46.6	88.4	43.7	0.0	0.0	52.2	50.6
User DelAdj:	1.00	1.00	1.00	1.00	1.00	1.00	1.00	1.00	1.00	1.00	1.00	1.00
AdjDel/Veh:	63.4	64.7	64.2	45.0	45.0	46.6	88.4	43.7	0.0	0.0	52.2	50.6
LOS by Move:	E	E	E	D	D	D	F	D	A	A	D	D
HCM2k95thQ:	14	17	15	20	20	25	5	18	0	0	23	18

Note: Queue reported is the number of cars per lane.

BART Phase II Extension Project

Level Of Service Computation Report
2000 HCM Operations (Future Volume Alternative)
PM - 2025 Project Conditions

Intersection #3013: 87/JULIAN (E) *

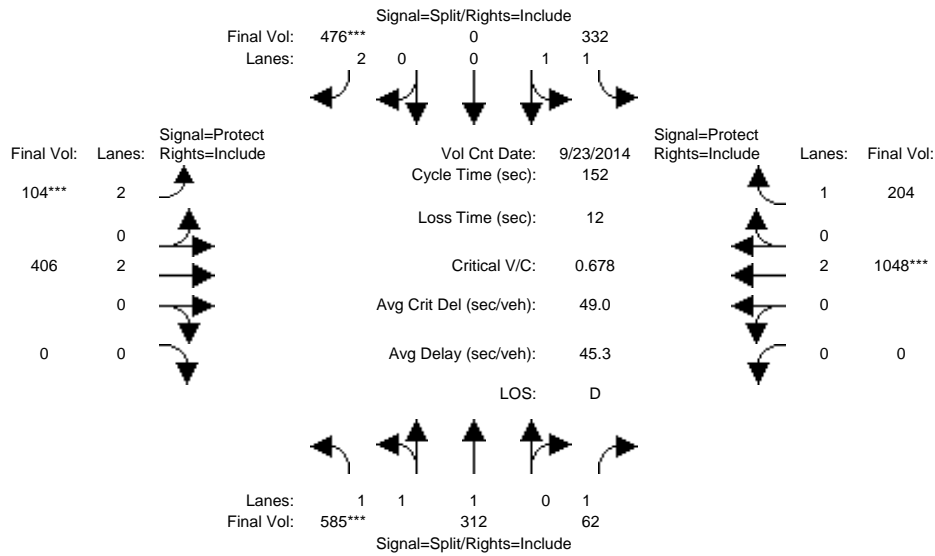

Approach:	North Bound			South Bound			East Bound			West Bound		
Movement:	L	T	R	L	T	R	L	T	R	L	T	R
Min. Green:	10	10	10	10	10	10	7	10	0	0	10	10
Y+R:	4.0	4.0	4.0	4.0	4.0	4.0	4.0	4.0	4.0	4.0	4.0	4.0
Volume Module: >> Count Date: 23 Sep 2014 <<												
Base Vol:	585	312	62	332	0	476	104	406	0	0	1048	204
Growth Adj:	1.00	1.00	1.00	1.00	1.00	1.00	1.00	1.00	1.00	1.00	1.00	1.00
Initial Bse:	585	312	62	332	0	476	104	406	0	0	1048	204
Added Vol:	0	0	0	0	0	0	0	0	0	0	0	0
PasserByVol:	0	0	0	0	0	0	0	0	0	0	0	0
Initial Fut:	585	312	62	332	0	476	104	406	0	0	1048	204
User Adj:	1.00	1.00	1.00	1.00	1.00	1.00	1.00	1.00	1.00	1.00	1.00	1.00
PHF Adj:	1.00	1.00	1.00	1.00	1.00	1.00	1.00	1.00	1.00	1.00	1.00	1.00
PHF Volume:	585	312	62	332	0	476	104	406	0	0	1048	204
Reduct Vol:	0	0	0	0	0	0	0	0	0	0	0	0
Reduced Vol:	585	312	62	332	0	476	104	406	0	0	1048	204
PCE Adj:	1.00	1.00	1.00	1.00	1.00	1.00	1.00	1.00	1.00	1.00	1.00	1.00
MLF Adj:	1.00	1.00	1.00	1.00	1.00	1.00	1.00	1.00	1.00	1.00	1.00	1.00
FinalVolume:	585	312	62	332	0	476	104	406	0	0	1048	204
Saturation Flow Module:												
Sat/Lane:	1900	1900	1900	1900	1900	1900	1900	1900	1900	1900	1900	1900
Adjustment:	0.93	1.00	0.92	0.93	1.00	0.83	0.83	1.00	0.92	0.92	1.00	0.92
Lanes:	2.00	1.00	1.00	2.00	0.00	2.00	2.00	2.00	0.00	0.00	2.00	1.00
Final Sat.:	3549	1896	1750	3550	0	3150	3150	3800	0	0	3800	1750
Capacity Analysis Module:												
Vol/Sat:	0.16	0.16	0.04	0.09	0.00	0.15	0.03	0.11	0.00	0.00	0.28	0.12
Crit Moves:	****					****	****			****		
Green Time:	36.9	36.9	36.9	33.9	0.0	33.9	7.4	69.2	0.0	0.0	61.8	61.8
Volume/Cap:	0.68	0.68	0.15	0.42	0.00	0.68	0.68	0.23	0.00	0.00	0.68	0.29
Delay/Veh:	53.6	53.6	45.3	51.0	0.0	56.8	82.7	25.3	0.0	0.0	38.2	30.5
User DelAdj:	1.00	1.00	1.00	1.00	1.00	1.00	1.00	1.00	1.00	1.00	1.00	1.00
AdjDel/Veh:	53.6	53.6	45.3	51.0	0.0	56.8	82.7	25.3	0.0	0.0	38.2	30.5
LOS by Move:	D	D	D	D	A	E	F	C	A	A	D	C
HCM2k95thQ:	24	24	5	14	0	23	6	11	0	0	34	13

Note: Queue reported is the number of cars per lane.

BART Phase II Extension Project

Level Of Service Computation Report
 2000 HCM Operations (Future Volume Alternative)
 AM - 2025 Project Conditions

Intersection #3014: 87/JULIAN (W)

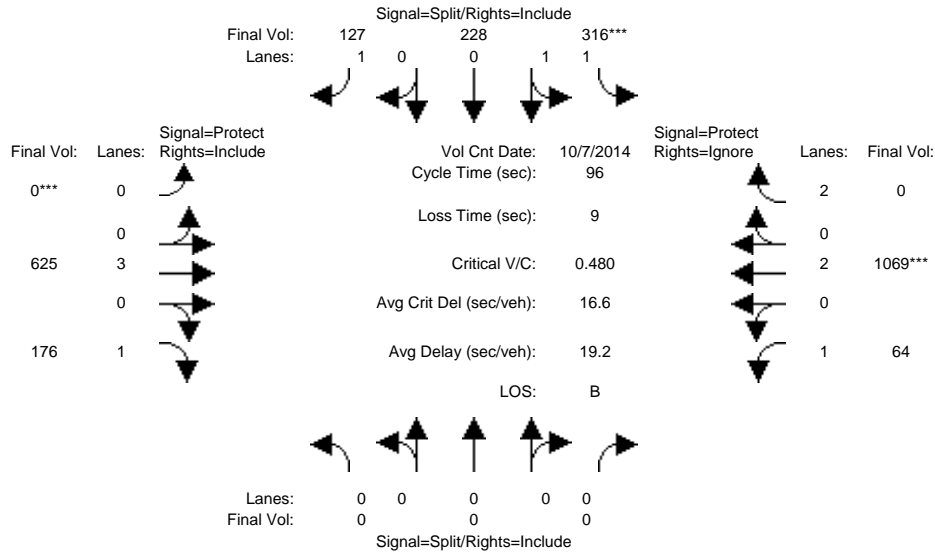

Approach:	North Bound			South Bound			East Bound			West Bound		
	L	T	R	L	T	R	L	T	R	L	T	R
Min. Green:	0	0	0	10	10	10	0	10	10	7	10	10
Y+R:	4.0	4.0	4.0	4.0	4.0	4.0	4.0	4.0	4.0	4.0	4.0	4.0
Volume Module: >> Count Date: 7 Oct 2014 <<												
Base Vol:	0	0	0	316	228	127	0	625	176	64	1069	0
Growth Adj:	1.00	1.00	1.00	1.00	1.00	1.00	1.00	1.00	1.00	1.00	1.00	1.00
Initial Bse:	0	0	0	316	228	127	0	625	176	64	1069	0
Added Vol:	0	0	0	0	0	0	0	0	0	0	0	0
PasserByVol:	0	0	0	0	0	0	0	0	0	0	0	0
Initial Fut:	0	0	0	316	228	127	0	625	176	64	1069	0
User Adj:	1.00	1.00	1.00	1.00	1.00	1.00	1.00	1.00	1.00	1.00	1.00	0.00
PHF Adj:	1.00	1.00	1.00	1.00	1.00	1.00	1.00	1.00	1.00	1.00	1.00	0.00
PHF Volume:	0	0	0	316	228	127	0	625	176	64	1069	0
Reduct Vol:	0	0	0	0	0	0	0	0	0	0	0	0
Reduced Vol:	0	0	0	316	228	127	0	625	176	64	1069	0
PCE Adj:	1.00	1.00	1.00	1.00	1.00	1.00	1.00	1.00	1.00	1.00	1.00	0.00
MLF Adj:	1.00	1.00	1.00	1.00	1.00	1.00	1.00	1.00	1.00	1.00	1.00	0.00
FinalVolume:	0	0	0	316	228	127	0	625	176	64	1069	0
Saturation Flow Module:												
Sat/Lane:	1900	1900	1900	1900	1900	1900	1900	1900	1900	1900	1900	1900
Adjustment:	0.92	1.00	0.92	0.92	0.95	0.92	0.92	1.00	0.92	0.92	1.00	0.83
Lanes:	0.00	0.00	0.00	1.17	0.83	1.00	0.00	3.00	1.00	1.00	2.00	2.00
Final Sat.:	0	0	0	2062	1488	1750	0	5700	1750	1750	3800	3150
Capacity Analysis Module:												
Vol/Sat:	0.00	0.00	0.00	0.15	0.15	0.07	0.00	0.11	0.10	0.04	0.28	0.00
Crit Moves:				****				****				****
Green Time:	0.0	0.0	0.0	30.7	30.7	30.7	0.0	33.8	33.8	22.5	56.3	0.0
Volume/Cap:	0.00	0.00	0.00	0.48	0.48	0.23	0.00	0.31	0.29	0.16	0.48	0.00
Delay/Veh:	0.0	0.0	0.0	26.6	26.6	24.2	0.0	22.7	22.6	29.4	11.6	0.0
User DelAdj:	1.00	1.00	1.00	1.00	1.00	1.00	1.00	1.00	1.00	1.00	1.00	1.00
AdjDel/Veh:	0.0	0.0	0.0	26.6	26.6	24.2	0.0	22.7	22.6	29.4	11.6	0.0
LOS by Move:	A	A	A	C	C	C	A	C	C	C	B	A
HCM2k95thQ:	0	0	0	14	14	6	0	8	8	3	16	0

Note: Queue reported is the number of cars per lane.

BART Phase II Extension Project

Level Of Service Computation Report
2000 HCM Operations (Future Volume Alternative)
PM - 2025 Project Conditions

Intersection #3014: 87/JULIAN (W)

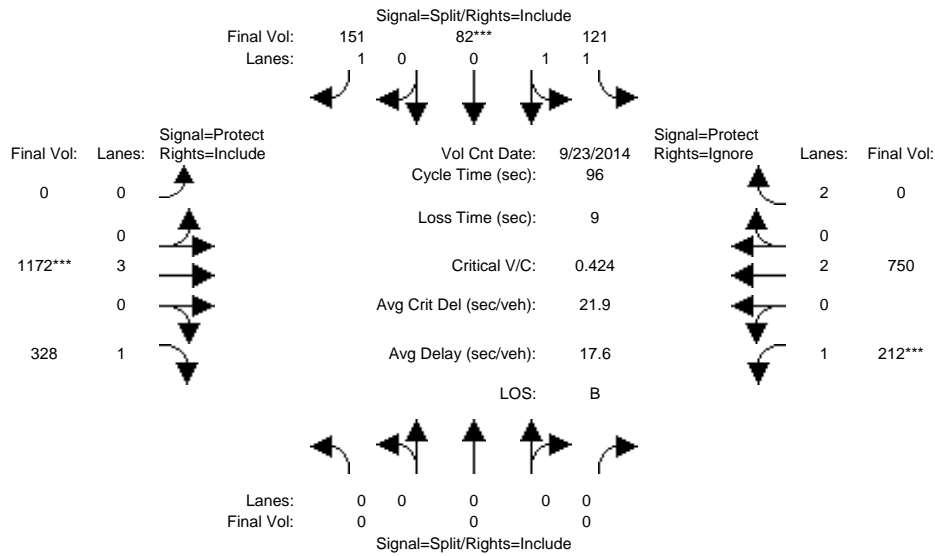

Approach:	North Bound			South Bound			East Bound			West Bound		
	L	T	R	L	T	R	L	T	R	L	T	R
Min. Green:	0	0	0	10	10	10	0	10	10	7	10	10
Y+R:	4.0	4.0	4.0	4.0	4.0	4.0	4.0	4.0	4.0	4.0	4.0	4.0

Volume Module:	>>	Count	Date:	23 Sep 2014	<<							
Base Vol:	0	0	0	121	82	151	0	1172	328	212	750	0
Growth Adj:	1.00	1.00	1.00	1.00	1.00	1.00	1.00	1.00	1.00	1.00	1.00	1.00
Initial Bse:	0	0	0	121	82	151	0	1172	328	212	750	0
Added Vol:	0	0	0	0	0	0	0	0	0	0	0	0
PasserByVol:	0	0	0	0	0	0	0	0	0	0	0	0
Initial Fut:	0	0	0	121	82	151	0	1172	328	212	750	0
User Adj:	1.00	1.00	1.00	1.00	1.00	1.00	1.00	1.00	1.00	1.00	1.00	0.00
PHF Adj:	1.00	1.00	1.00	1.00	1.00	1.00	1.00	1.00	1.00	1.00	1.00	0.00
PHF Volume:	0	0	0	121	82	151	0	1172	328	212	750	0
Reduct Vol:	0	0	0	0	0	0	0	0	0	0	0	0
Reduced Vol:	0	0	0	121	82	151	0	1172	328	212	750	0
PCE Adj:	1.00	1.00	1.00	1.00	1.00	1.00	1.00	1.00	1.00	1.00	1.00	0.00
MLF Adj:	1.00	1.00	1.00	1.00	1.00	1.00	1.00	1.00	1.00	1.00	1.00	0.00
FinalVolume:	0	0	0	121	82	151	0	1172	328	212	750	0

Saturation Flow Module:												
Sat/Lane:	1900	1900	1900	1900	1900	1900	1900	1900	1900	1900	1900	1900
Adjustment:	0.92	1.00	0.92	0.93	0.95	0.92	0.92	1.00	0.92	0.92	1.00	0.83
Lanes:	0.00	0.00	0.00	1.20	0.80	1.00	0.00	3.00	1.00	1.00	2.00	2.00
Final Sat.:	0	0	0	2116	1434	1750	0	5700	1750	1750	3800	3150

Capacity Analysis Module:												
Vol/Sat:	0.00	0.00	0.00	0.06	0.06	0.09	0.00	0.21	0.19	0.12	0.20	0.00
Crit Moves:				****	****	****		****	****	****	****	****
Green Time:	0.0	0.0	0.0	18.2	18.2	18.2	0.0	43.3	43.3	25.5	68.8	0.0
Volume/Cap:	0.00	0.00	0.00	0.30	0.30	0.46	0.00	0.46	0.42	0.46	0.28	0.00
Delay/Veh:	0.0	0.0	0.0	33.7	33.7	35.5	0.0	18.3	18.2	30.2	4.8	0.0
User DelAdj:	1.00	1.00	1.00	1.00	1.00	1.00	1.00	1.00	1.00	1.00	1.00	1.00
AdjDel/Veh:	0.0	0.0	0.0	33.7	33.7	35.5	0.0	18.3	18.2	30.2	4.8	0.0
LOS by Move:	A	A	A	C	C	D	A	B	B	C	A	A
HCM2k95thQ:	0	0	0	6	6	9	0	14	13	10	7	0

Note: Queue reported is the number of cars per lane.

BART Phase II Extension Project

Level Of Service Computation Report
 2000 HCM Operations (Future Volume Alternative)
 AM - 2025 Project Conditions

Intersection #3015: 87/SANTA CLARA

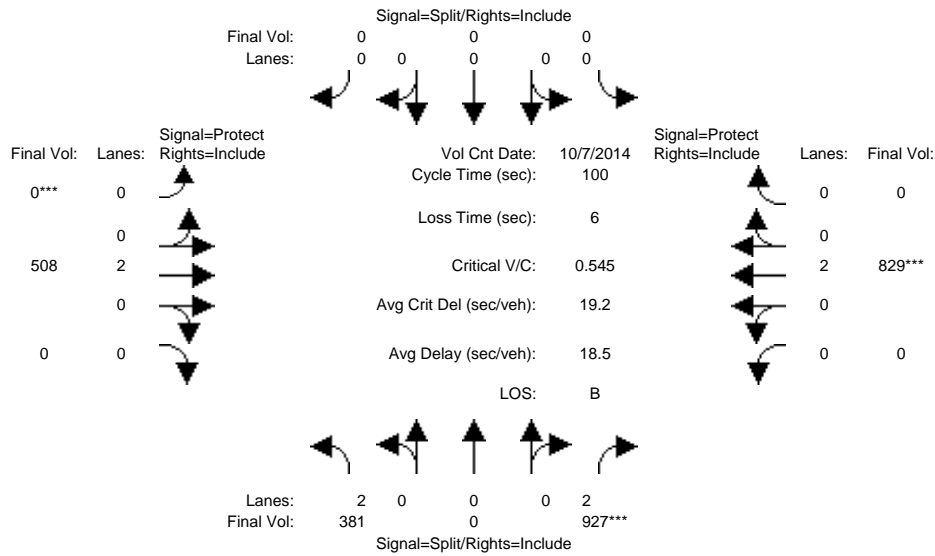

Approach:	North Bound			South Bound			East Bound			West Bound		
	L	T	R	L	T	R	L	T	R	L	T	R
Min. Green:	10	0	10	0	0	0	0	10	0	0	10	0
Y+R:	4.0	4.0	4.0	4.0	4.0	4.0	4.0	4.0	4.0	4.0	4.0	4.0

Volume Module:	>> Count Date: 7 Oct 2014 <<											
Base Vol:	381	0	927	0	0	0	0	508	0	0	829	0
Growth Adj:	1.00	1.00	1.00	1.00	1.00	1.00	1.00	1.00	1.00	1.00	1.00	1.00
Initial Bse:	381	0	927	0	0	0	0	508	0	0	829	0
Added Vol:	0	0	0	0	0	0	0	0	0	0	0	0
PasserByVol:	0	0	0	0	0	0	0	0	0	0	0	0
Initial Fut:	381	0	927	0	0	0	0	508	0	0	829	0
User Adj:	1.00	1.00	1.00	1.00	1.00	1.00	1.00	1.00	1.00	1.00	1.00	1.00
PHF Adj:	1.00	1.00	1.00	1.00	1.00	1.00	1.00	1.00	1.00	1.00	1.00	1.00
PHF Volume:	381	0	927	0	0	0	0	508	0	0	829	0
Reduct Vol:	0	0	0	0	0	0	0	0	0	0	0	0
Reduced Vol:	381	0	927	0	0	0	0	508	0	0	829	0
PCE Adj:	1.00	1.00	1.00	1.00	1.00	1.00	1.00	1.00	1.00	1.00	1.00	1.00
MLF Adj:	1.00	1.00	1.00	1.00	1.00	1.00	1.00	1.00	1.00	1.00	1.00	1.00
FinalVolume:	381	0	927	0	0	0	0	508	0	0	829	0

Saturation Flow Module:												
Sat/Lane:	1900	1900	1900	1900	1900	1900	1900	1900	1900	1900	1900	1900
Adjustment:	0.83	1.00	0.83	0.92	1.00	0.92	0.92	1.00	0.92	0.92	1.00	0.92
Lanes:	2.00	0.00	2.00	0.00	0.00	0.00	0.00	2.00	0.00	0.00	2.00	0.00
Final Sat.:	3150	0	3150	0	0	0	0	3800	0	0	3800	0

Capacity Analysis Module:												
Vol/Sat:	0.12	0.00	0.29	0.00	0.00	0.00	0.00	0.13	0.00	0.00	0.22	0.00
Crit Moves:			****					****			****	
Green Time:	54.0	0.0	54.0	0.0	0.0	0.0	0.0	40.0	0.0	0.0	40.0	0.0
Volume/Cap:	0.22	0.00	0.55	0.00	0.00	0.00	0.00	0.33	0.00	0.00	0.55	0.00
Delay/Veh:	12.1	0.0	15.4	0.0	0.0	0.0	0.0	20.9	0.0	0.0	23.4	0.0
User DelAdj:	1.00	1.00	1.00	1.00	1.00	1.00	1.00	1.00	1.00	1.00	1.00	1.00
AdjDel/Veh:	12.1	0.0	15.4	0.0	0.0	0.0	0.0	20.9	0.0	0.0	23.4	0.0
LOS by Move:	B	A	B	A	A	A	A	C	A	A	C	A
HCM2k95thQ:	7	0	21	0	0	0	0	10	0	0	18	0

Note: Queue reported is the number of cars per lane.

BART Phase II Extension Project

Level Of Service Computation Report
 2000 HCM Operations (Future Volume Alternative)
 PM - 2025 Project Conditions

Intersection #3015: 87/SANTA CLARA

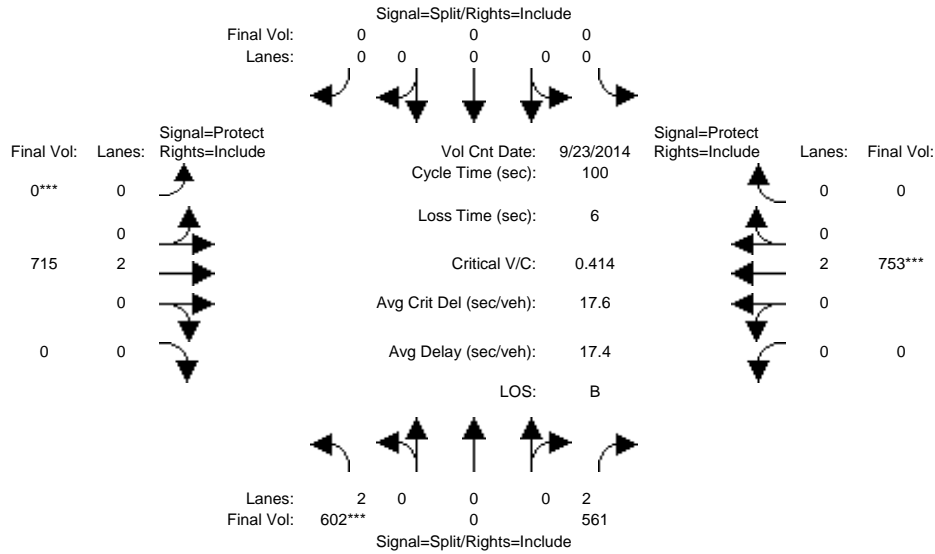

Approach:	North Bound			South Bound			East Bound			West Bound		
	L	T	R	L	T	R	L	T	R	L	T	R
Min. Green:	10	0	10	0	0	0	0	10	0	0	10	0
Y+R:	4.0	4.0	4.0	4.0	4.0	4.0	4.0	4.0	4.0	4.0	4.0	4.0

Volume Module: >> Count Date: 23 Sep 2014 <<

Base Vol:	602	0	561	0	0	0	0	715	0	0	753	0
Growth Adj:	1.00	1.00	1.00	1.00	1.00	1.00	1.00	1.00	1.00	1.00	1.00	1.00
Initial Bse:	602	0	561	0	0	0	0	715	0	0	753	0
Added Vol:	0	0	0	0	0	0	0	0	0	0	0	0
PasserByVol:	0	0	0	0	0	0	0	0	0	0	0	0
Initial Fut:	602	0	561	0	0	0	0	715	0	0	753	0
User Adj:	1.00	1.00	1.00	1.00	1.00	1.00	1.00	1.00	1.00	1.00	1.00	1.00
PHF Adj:	1.00	1.00	1.00	1.00	1.00	1.00	1.00	1.00	1.00	1.00	1.00	1.00
PHF Volume:	602	0	561	0	0	0	0	715	0	0	753	0
Reduct Vol:	0	0	0	0	0	0	0	0	0	0	0	0
Reduced Vol:	602	0	561	0	0	0	0	715	0	0	753	0
PCE Adj:	1.00	1.00	1.00	1.00	1.00	1.00	1.00	1.00	1.00	1.00	1.00	1.00
MLF Adj:	1.00	1.00	1.00	1.00	1.00	1.00	1.00	1.00	1.00	1.00	1.00	1.00
FinalVolume:	602	0	561	0	0	0	0	715	0	0	753	0

Saturation Flow Module:

Sat/Lane:	1900	1900	1900	1900	1900	1900	1900	1900	1900	1900	1900	1900
Adjustment:	0.83	1.00	0.83	0.92	1.00	0.92	0.92	1.00	0.92	0.92	1.00	0.92
Lanes:	2.00	0.00	2.00	0.00	0.00	0.00	0.00	2.00	0.00	0.00	2.00	0.00
Final Sat.:	3150	0	3150	0	0	0	0	3800	0	0	3800	0

Capacity Analysis Module:

Vol/Sat:	0.19	0.00	0.18	0.00	0.00	0.00	0.00	0.19	0.00	0.00	0.20	0.00
Crit Moves:	****						****				****	
Green Time:	46.1	0.0	46.1	0.0	0.0	0.0	0.0	47.9	0.0	0.0	47.9	0.0
Volume/Cap:	0.41	0.00	0.39	0.00	0.00	0.00	0.00	0.39	0.00	0.00	0.41	0.00
Delay/Veh:	18.1	0.0	17.8	0.0	0.0	0.0	0.0	16.9	0.0	0.0	17.1	0.0
User DelAdj:	1.00	1.00	1.00	1.00	1.00	1.00	1.00	1.00	1.00	1.00	1.00	1.00
AdjDel/Veh:	18.1	0.0	17.8	0.0	0.0	0.0	0.0	16.9	0.0	0.0	17.1	0.0
LOS by Move:	B	A	B	A	A	A	A	B	A	A	B	A
HCM2k95thQ:	14	0	13	0	0	0	0	13	0	0	14	0

Note: Queue reported is the number of cars per lane.

BART Phase II Extension Project

Level Of Service Computation Report
2000 HCM Operations (Future Volume Alternative)
AM - 2025 Project Conditions

Intersection #3032: 280/BIRD (N)

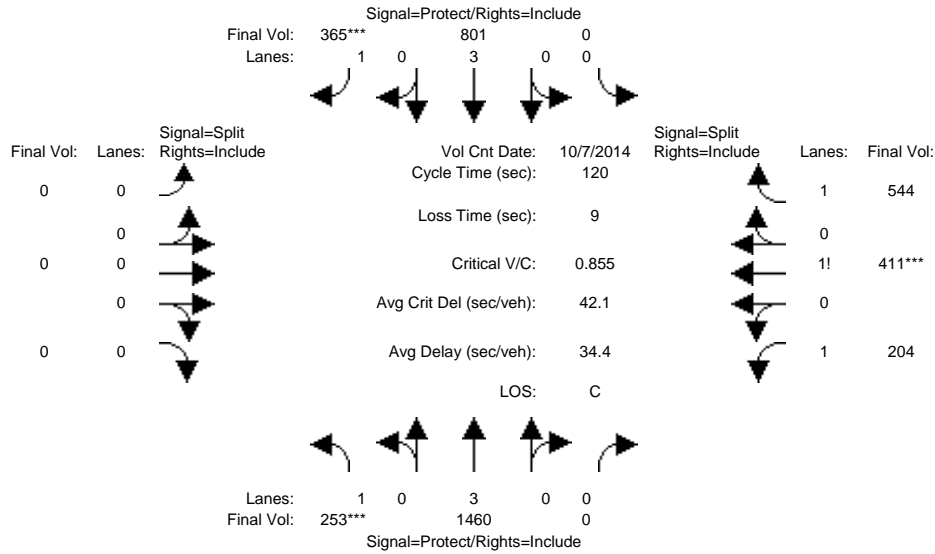

Approach:	North Bound			South Bound			East Bound			West Bound		
Movement:	L	T	R	L	T	R	L	T	R	L	T	R
Min. Green:	7	10	0	0	10	10	0	0	0	10	10	10
Y+R:	4.0	4.0	4.0	4.0	4.0	4.0	4.0	4.0	4.0	4.0	4.0	4.0
Volume Module: >> Count Date: 7 Oct 2014 <<												
Base Vol:	253	1460	0	0	801	365	0	0	0	204	411	544
Growth Adj:	1.00	1.00	1.00	1.00	1.00	1.00	1.00	1.00	1.00	1.00	1.00	1.00
Initial Bse:	253	1460	0	0	801	365	0	0	0	204	411	544
Added Vol:	0	0	0	0	0	0	0	0	0	0	0	0
PasserByVol:	0	0	0	0	0	0	0	0	0	0	0	0
Initial Fut:	253	1460	0	0	801	365	0	0	0	204	411	544
User Adj:	1.00	1.00	1.00	1.00	1.00	1.00	1.00	1.00	1.00	1.00	1.00	1.00
PHF Adj:	1.00	1.00	1.00	1.00	1.00	1.00	1.00	1.00	1.00	1.00	1.00	1.00
PHF Volume:	253	1460	0	0	801	365	0	0	0	204	411	544
Reduct Vol:	0	0	0	0	0	0	0	0	0	0	0	0
Reduced Vol:	253	1460	0	0	801	365	0	0	0	204	411	544
PCE Adj:	1.00	1.00	1.00	1.00	1.00	1.00	1.00	1.00	1.00	1.00	1.00	1.00
MLF Adj:	1.00	1.00	1.00	1.00	1.00	1.00	1.00	1.00	1.00	1.00	1.00	1.00
FinalVolume:	253	1460	0	0	801	365	0	0	0	204	411	544
Saturation Flow Module:												
Sat/Lane:	1900	1900	1900	1900	1900	1900	1900	1900	1900	1900	1900	1900
Adjustment:	0.92	1.00	0.92	0.92	1.00	0.92	0.92	1.00	0.92	0.92	0.95	0.95
Lanes:	1.00	3.00	0.00	0.00	3.00	1.00	0.00	0.00	0.00	1.13	0.52	1.35
Final Sat.:	1750	5700	0	0	5700	1750	0	0	0	1983	939	2421
Capacity Analysis Module:												
Vol/Sat:	0.14	0.26	0.00	0.00	0.14	0.21	0.00	0.00	0.00	0.10	0.44	0.22
Crit Moves:	****				****					****		
Green Time:	20.3	49.6	0.0	0.0	29.3	29.3	0.0	0.0	0.0	61.4	61.4	61.4
Volume/Cap:	0.85	0.62	0.00	0.00	0.58	0.85	0.00	0.00	0.00	0.20	0.85	0.44
Delay/Veh:	69.3	28.3	0.0	0.0	40.5	58.8	0.0	0.0	0.0	15.9	31.0	18.5
User DelAdj:	1.00	1.00	1.00	1.00	1.00	1.00	1.00	1.00	1.00	1.00	1.00	1.00
AdjDel/Veh:	69.3	28.3	0.0	0.0	40.5	58.8	0.0	0.0	0.0	15.9	31.0	18.5
LOS by Move:	E	C	A	A	D	E	A	A	A	B	C	B
HCM2k95thQ:	23	25	0	0	16	26	0	0	0	8	47	18

Note: Queue reported is the number of cars per lane.

BART Phase II Extension Project

Level Of Service Computation Report
2000 HCM Operations (Future Volume Alternative)
PM - 2025 Project Conditions

Intersection #3032: 280/BIRD (N)

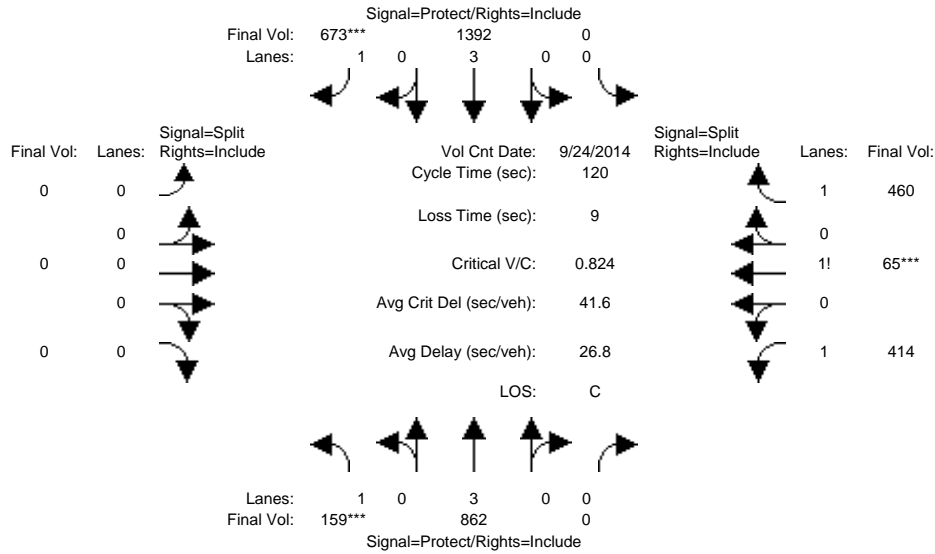

Approach:	North Bound			South Bound			East Bound			West Bound		
Movement:	L	T	R	L	T	R	L	T	R	L	T	R
Min. Green:	7	10	0	0	10	10	0	0	0	10	10	10
Y+R:	4.0	4.0	4.0	4.0	4.0	4.0	4.0	4.0	4.0	4.0	4.0	4.0
Volume Module: >> Count Date: 24 Sep 2014 <<												
Base Vol:	159	862	0	0	1392	673	0	0	0	414	65	460
Growth Adj:	1.00	1.00	1.00	1.00	1.00	1.00	1.00	1.00	1.00	1.00	1.00	1.00
Initial Bse:	159	862	0	0	1392	673	0	0	0	414	65	460
Added Vol:	0	0	0	0	0	0	0	0	0	0	0	0
PasserByVol:	0	0	0	0	0	0	0	0	0	0	0	0
Initial Fut:	159	862	0	0	1392	673	0	0	0	414	65	460
User Adj:	1.00	1.00	1.00	1.00	1.00	1.00	1.00	1.00	1.00	1.00	1.00	1.00
PHF Adj:	1.00	1.00	1.00	1.00	1.00	1.00	1.00	1.00	1.00	1.00	1.00	1.00
PHF Volume:	159	862	0	0	1392	673	0	0	0	414	65	460
Reduct Vol:	0	0	0	0	0	0	0	0	0	0	0	0
Reduced Vol:	159	862	0	0	1392	673	0	0	0	414	65	460
PCE Adj:	1.00	1.00	1.00	1.00	1.00	1.00	1.00	1.00	1.00	1.00	1.00	1.00
MLF Adj:	1.00	1.00	1.00	1.00	1.00	1.00	1.00	1.00	1.00	1.00	1.00	1.00
FinalVolume:	159	862	0	0	1392	673	0	0	0	414	65	460
Saturation Flow Module:												
Sat/Lane:	1900	1900	1900	1900	1900	1900	1900	1900	1900	1900	1900	1900
Adjustment:	0.92	1.00	0.92	0.92	1.00	0.92	0.92	1.00	0.92	0.92	0.92	0.92
Lanes:	1.00	3.00	0.00	0.00	3.00	1.00	0.00	0.00	0.00	1.41	0.13	1.46
Final Sat.:	1750	5700	0	0	5700	1750	0	0	0	2472	227	2552
Capacity Analysis Module:												
Vol/Sat:	0.09	0.15	0.00	0.00	0.24	0.38	0.00	0.00	0.00	0.17	0.29	0.18
Crit Moves:	****					****					****	
Green Time:	13.2	69.2	0.0	0.0	56.0	56.0	0.0	0.0	0.0	41.8	41.8	41.8
Volume/Cap:	0.82	0.26	0.00	0.00	0.52	0.82	0.00	0.00	0.00	0.48	0.82	0.52
Delay/Veh:	76.3	12.7	0.0	0.0	22.8	34.6	0.0	0.0	0.0	30.8	40.8	31.4
User DelAdj:	1.00	1.00	1.00	1.00	1.00	1.00	1.00	1.00	1.00	1.00	1.00	1.00
AdjDel/Veh:	76.3	12.7	0.0	0.0	22.8	34.6	0.0	0.0	0.0	30.8	40.8	31.4
LOS by Move:	E	B	A	A	C	C	A	A	A	C	D	C
HCM2k95thQ:	16	10	0	0	21	39	0	0	0	17	34	19

Note: Queue reported is the number of cars per lane.

BART Phase II Extension Project

Level Of Service Computation Report
 2000 HCM Operations (Future Volume Alternative)
 AM - 2025 Project Conditions

Intersection #3033: 280/BIRD (S)

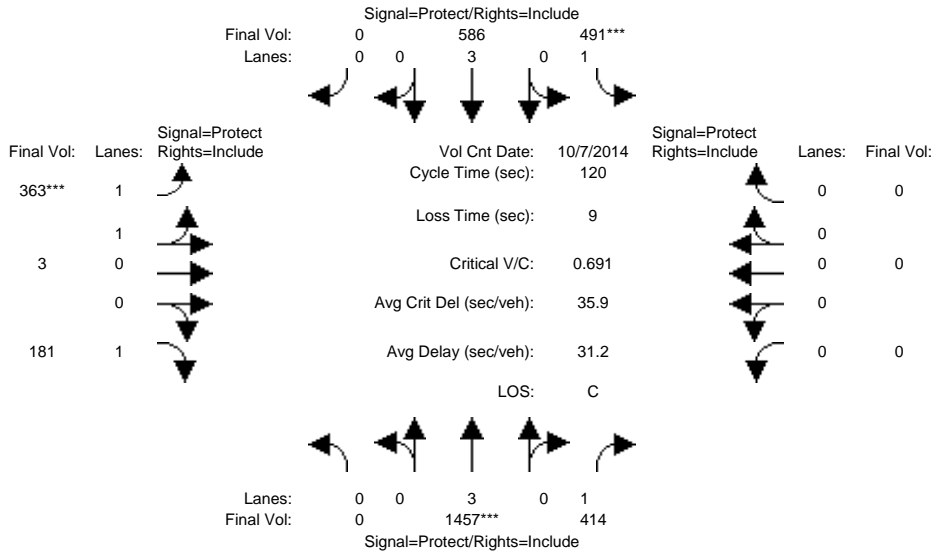

Approach:	North Bound			South Bound			East Bound			West Bound		
Movement:	L	T	R	L	T	R	L	T	R	L	T	R
Min. Green:	0	10	10	7	10	0	10	10	10	0	0	0
Y+R:	4.0	4.0	4.0	4.0	4.0	4.0	4.0	4.0	4.0	4.0	4.0	4.0
Volume Module: >> Count Date: 7 Oct 2014 <<												
Base Vol:	0	1457	414	491	586	0	363	3	181	0	0	0
Growth Adj:	1.00	1.00	1.00	1.00	1.00	1.00	1.00	1.00	1.00	1.00	1.00	1.00
Initial Bse:	0	1457	414	491	586	0	363	3	181	0	0	0
Added Vol:	0	0	0	0	0	0	0	0	0	0	0	0
PasserByVol:	0	0	0	0	0	0	0	0	0	0	0	0
Initial Fut:	0	1457	414	491	586	0	363	3	181	0	0	0
User Adj:	1.00	1.00	1.00	1.00	1.00	1.00	1.00	1.00	1.00	1.00	1.00	1.00
PHF Adj:	1.00	1.00	1.00	1.00	1.00	1.00	1.00	1.00	1.00	1.00	1.00	1.00
PHF Volume:	0	1457	414	491	586	0	363	3	181	0	0	0
Reduct Vol:	0	0	0	0	0	0	0	0	0	0	0	0
Reduced Vol:	0	1457	414	491	586	0	363	3	181	0	0	0
PCE Adj:	1.00	1.00	1.00	1.00	1.00	1.00	1.00	1.00	1.00	1.00	1.00	1.00
MLF Adj:	1.00	1.00	1.00	1.00	1.00	1.00	1.00	1.00	1.00	1.00	1.00	1.00
Final Volume:	0	1457	414	491	586	0	363	3	181	0	0	0
Saturation Flow Module:												
Sat/Lane:	1900	1900	1900	1900	1900	1900	1900	1900	1900	1900	1900	1900
Adjustment:	0.92	1.00	0.92	0.92	1.00	0.92	0.93	0.95	0.92	0.92	1.00	0.92
Lanes:	0.00	3.00	1.00	1.00	3.00	0.00	1.98	0.02	1.00	0.00	0.00	0.00
Final Sat.:	0	5700	1750	1750	5700	0	3521	29	1750	0	0	0
Capacity Analysis Module:												
Vol/Sat:	0.00	0.26	0.24	0.28	0.10	0.00	0.10	0.10	0.10	0.00	0.00	0.00
Crit Moves:	****			****			****					
Green Time:	0.0	44.4	44.4	48.7	93.1	0.0	17.9	17.9	17.9	0.0	0.0	0.0
Volume/Cap:	0.00	0.69	0.64	0.69	0.13	0.00	0.69	0.69	0.69	0.00	0.00	0.00
Delay/Veh:	0.0	33.0	33.4	32.3	3.4	0.0	52.3	52.3	56.3	0.0	0.0	0.0
User DelAdj:	1.00	1.00	1.00	1.00	1.00	1.00	1.00	1.00	1.00	1.00	1.00	1.00
AdjDel/Veh:	0.0	33.0	33.4	32.3	3.4	0.0	52.3	52.3	56.3	0.0	0.0	0.0
LOS by Move:	A	C	C	C	A	A	D	D	E	A	A	A
HCM2k95thQ:	0	27	24	29	4	0	15	15	15	0	0	0

Note: Queue reported is the number of cars per lane.

BART Phase II Extension Project

Level Of Service Computation Report
2000 HCM Operations (Future Volume Alternative)
PM - 2025 Project Conditions

Intersection #3033: 280/BIRD (S)

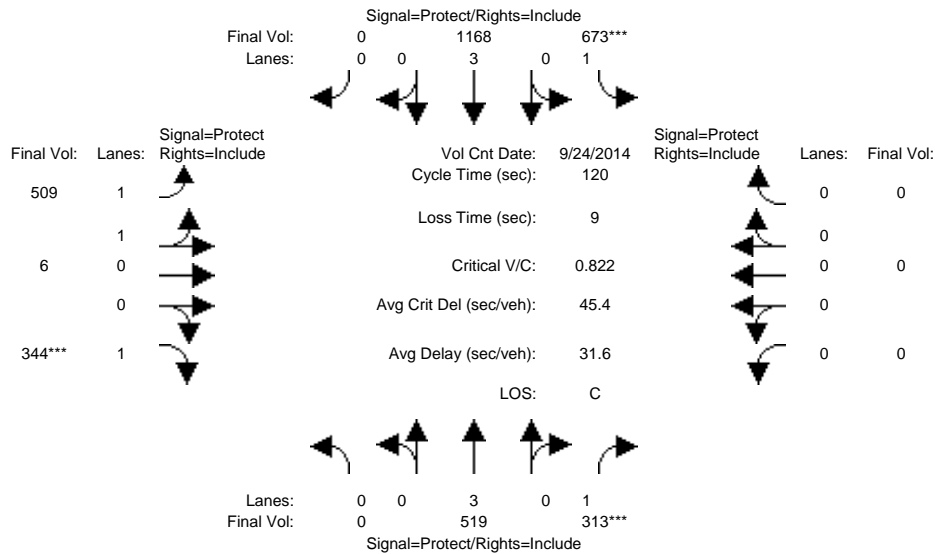

Approach:	North Bound			South Bound			East Bound			West Bound		
	L	T	R	L	T	R	L	T	R	L	T	R
Min. Green:	0	10	10	7	10	0	10	10	10	0	0	0
Y+R:	4.0	4.0	4.0	4.0	4.0	4.0	4.0	4.0	4.0	4.0	4.0	4.0
Volume Module: >> Count Date: 24 Sep 2014 <<												
Base Vol:	0	519	313	673	1168	0	509	6	344	0	0	0
Growth Adj:	1.00	1.00	1.00	1.00	1.00	1.00	1.00	1.00	1.00	1.00	1.00	1.00
Initial Bse:	0	519	313	673	1168	0	509	6	344	0	0	0
Added Vol:	0	0	0	0	0	0	0	0	0	0	0	0
PasserByVol:	0	0	0	0	0	0	0	0	0	0	0	0
Initial Fut:	0	519	313	673	1168	0	509	6	344	0	0	0
User Adj:	1.00	1.00	1.00	1.00	1.00	1.00	1.00	1.00	1.00	1.00	1.00	1.00
PHF Adj:	1.00	1.00	1.00	1.00	1.00	1.00	1.00	1.00	1.00	1.00	1.00	1.00
PHF Volume:	0	519	313	673	1168	0	509	6	344	0	0	0
Reduct Vol:	0	0	0	0	0	0	0	0	0	0	0	0
Reduced Vol:	0	519	313	673	1168	0	509	6	344	0	0	0
PCE Adj:	1.00	1.00	1.00	1.00	1.00	1.00	1.00	1.00	1.00	1.00	1.00	1.00
MLF Adj:	1.00	1.00	1.00	1.00	1.00	1.00	1.00	1.00	1.00	1.00	1.00	1.00
FinalVolume:	0	519	313	673	1168	0	509	6	344	0	0	0
Saturation Flow Module:												
Sat/Lane:	1900	1900	1900	1900	1900	1900	1900	1900	1900	1900	1900	1900
Adjustment:	0.92	1.00	0.92	0.92	1.00	0.92	0.93	0.95	0.92	0.92	1.00	0.92
Lanes:	0.00	3.00	1.00	1.00	3.00	0.00	1.98	0.02	1.00	0.00	0.00	0.00
Final Sat.:	0	5700	1750	1750	5700	0	3509	41	1750	0	0	0
Capacity Analysis Module:												
Vol/Sat:	0.00	0.09	0.18	0.38	0.20	0.00	0.15	0.15	0.20	0.00	0.00	0.00
Crit Moves:			****	****					****			
Green Time:	0.0	26.1	26.1	56.2	82.3	0.0	28.7	28.7	28.7	0.0	0.0	0.0
Volume/Cap:	0.00	0.42	0.82	0.82	0.30	0.00	0.61	0.61	0.82	0.00	0.00	0.00
Delay/Veh:	0.0	40.6	58.1	34.3	7.5	0.0	41.9	41.9	55.5	0.0	0.0	0.0
User DelAdj:	1.00	1.00	1.00	1.00	1.00	1.00	1.00	1.00	1.00	1.00	1.00	1.00
AdjDel/Veh:	0.0	40.6	58.1	34.3	7.5	0.0	41.9	41.9	55.5	0.0	0.0	0.0
LOS by Move:	A	D	E	C	A	A	D	D	E	A	A	A
HCM2k95thQ:	0	10	23	41	11	0	18	18	27	0	0	0

Note: Queue reported is the number of cars per lane.

BART Phase II Extension Project

Level Of Service Computation Report
2000 HCM Operations (Future Volume Alternative)
AM - 2025 Project Conditions

Intersection #3058: ALAMEDA/NAGLEE

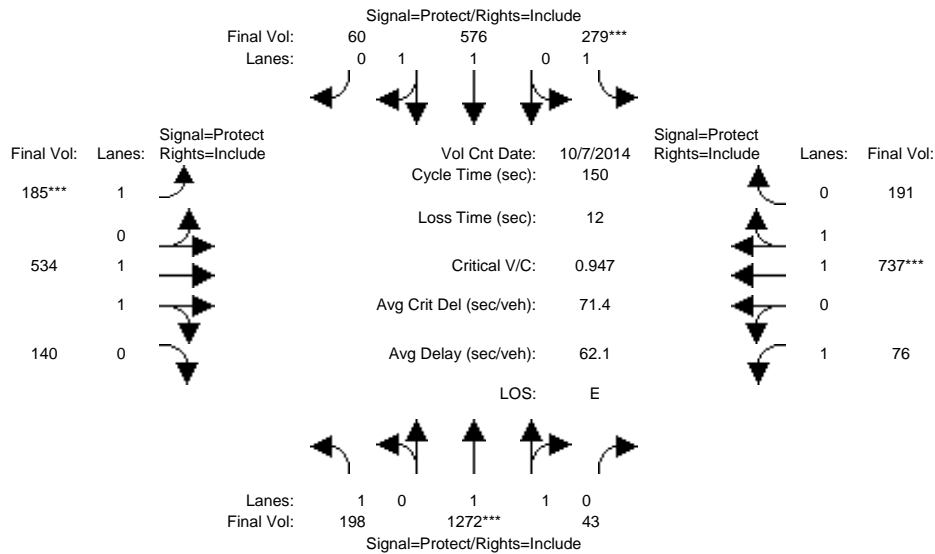

Approach:	North Bound			South Bound			East Bound			West Bound		
	L	T	R	L	T	R	L	T	R	L	T	R
Min. Green:	7	10	10	7	10	10	7	10	10	7	10	10
Y+R:	4.0	4.0	4.0	4.0	4.0	4.0	4.0	4.0	4.0	4.0	4.0	4.0
Volume Module: >> Count Date: 7 Oct 2014 <<												
Base Vol:	198	1272	43	279	576	60	185	534	140	76	737	191
Growth Adj:	1.00	1.00	1.00	1.00	1.00	1.00	1.00	1.00	1.00	1.00	1.00	1.00
Initial Bse:	198	1272	43	279	576	60	185	534	140	76	737	191
Added Vol:	0	0	0	0	0	0	0	0	0	0	0	0
PasserByVol:	0	0	0	0	0	0	0	0	0	0	0	0
Initial Fut:	198	1272	43	279	576	60	185	534	140	76	737	191
User Adj:	1.00	1.00	1.00	1.00	1.00	1.00	1.00	1.00	1.00	1.00	1.00	1.00
PHF Adj:	1.00	1.00	1.00	1.00	1.00	1.00	1.00	1.00	1.00	1.00	1.00	1.00
PHF Volume:	198	1272	43	279	576	60	185	534	140	76	737	191
Reduct Vol:	0	0	0	0	0	0	0	0	0	0	0	0
Reduced Vol:	198	1272	43	279	576	60	185	534	140	76	737	191
PCE Adj:	1.00	1.00	1.00	1.00	1.00	1.00	1.00	1.00	1.00	1.00	1.00	1.00
MLF Adj:	1.00	1.00	1.00	1.00	1.00	1.00	1.00	1.00	1.00	1.00	1.00	1.00
FinalVolume:	198	1272	43	279	576	60	185	534	140	76	737	191
Saturation Flow Module:												
Sat/Lane:	1900	1900	1900	1900	1900	1900	1900	1900	1900	1900	1900	1900
Adjustment:	0.92	0.97	0.95	0.92	0.98	0.95	0.92	0.98	0.95	0.92	0.98	0.95
Lanes:	1.00	1.93	0.07	1.00	1.81	0.19	1.00	1.57	0.43	1.00	1.58	0.42
Final Sat.:	1750	3579	121	1750	3351	349	1750	2931	768	1750	2938	761
Capacity Analysis Module:												
Vol/Sat:	0.11	0.36	0.36	0.16	0.17	0.17	0.11	0.18	0.18	0.04	0.25	0.25
Crit Moves:	****			****			****			****		
Green Time:	32.4	56.3	56.3	25.2	49.2	49.2	16.7	45.0	45.0	11.5	39.7	39.7
Volume/Cap:	0.52	0.95	0.95	0.95	0.52	0.52	0.95	0.61	0.61	0.57	0.95	0.95
Delay/Veh:	53.4	59.0	59.0	100.1	41.3	41.3	115.4	46.0	46.0	72.4	71.5	71.5
User DelAdj:	1.00	1.00	1.00	1.00	1.00	1.00	1.00	1.00	1.00	1.00	1.00	1.00
AdjDel/Veh:	53.4	59.0	59.0	100.1	41.3	41.3	115.4	46.0	46.0	72.4	71.5	71.5
LOS by Move:	D	E	E	F	D	D	F	D	D	E	E	E
HCM2k95thQ:	17	55	55	28	21	21	23	25	25	7	40	40

Note: Queue reported is the number of cars per lane.

BART Phase II Extension Project

Level Of Service Computation Report
2000 HCM Operations (Future Volume Alternative)
PM - 2025 Project Conditions

Intersection #3058: ALAMEDA/NAGLEE

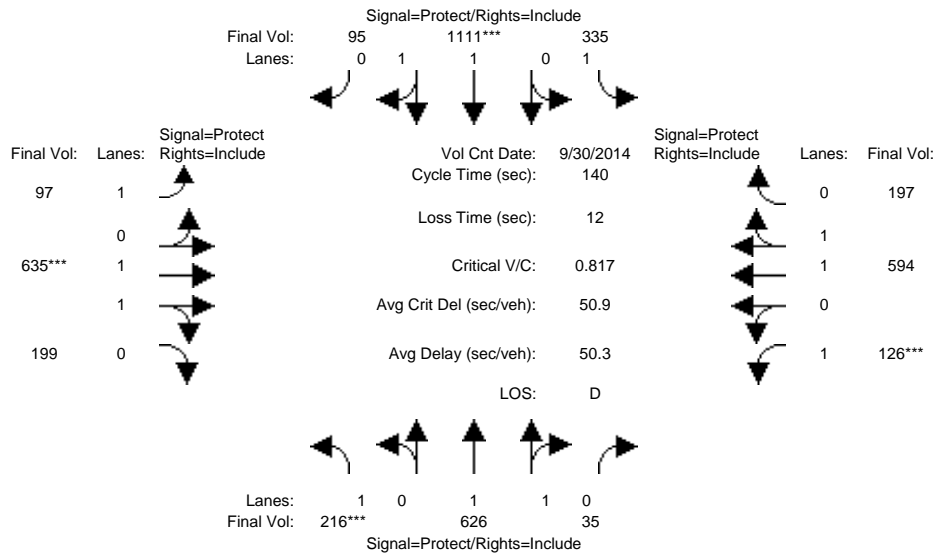

Approach:	North Bound			South Bound			East Bound			West Bound		
	L	T	R	L	T	R	L	T	R	L	T	R
Min. Green:	7	10	10	7	10	10	7	10	10	7	10	10
Y+R:	4.0	4.0	4.0	4.0	4.0	4.0	4.0	4.0	4.0	4.0	4.0	4.0

Volume Module:	>>	Count	Date:	30 Sep 2014	<<							
Base Vol:	216	626	35	335	1111	95	97	635	199	126	594	197
Growth Adj:	1.00	1.00	1.00	1.00	1.00	1.00	1.00	1.00	1.00	1.00	1.00	1.00
Initial Bse:	216	626	35	335	1111	95	97	635	199	126	594	197
Added Vol:	0	0	0	0	0	0	0	0	0	0	0	0
PasserByVol:	0	0	0	0	0	0	0	0	0	0	0	0
Initial Fut:	216	626	35	335	1111	95	97	635	199	126	594	197
User Adj:	1.00	1.00	1.00	1.00	1.00	1.00	1.00	1.00	1.00	1.00	1.00	1.00
PHF Adj:	1.00	1.00	1.00	1.00	1.00	1.00	1.00	1.00	1.00	1.00	1.00	1.00
PHF Volume:	216	626	35	335	1111	95	97	635	199	126	594	197
Reduct Vol:	0	0	0	0	0	0	0	0	0	0	0	0
Reduced Vol:	216	626	35	335	1111	95	97	635	199	126	594	197
PCE Adj:	1.00	1.00	1.00	1.00	1.00	1.00	1.00	1.00	1.00	1.00	1.00	1.00
MLF Adj:	1.00	1.00	1.00	1.00	1.00	1.00	1.00	1.00	1.00	1.00	1.00	1.00
FinalVolume:	216	626	35	335	1111	95	97	635	199	126	594	197

Saturation Flow Module:												
Sat/Lane:	1900	1900	1900	1900	1900	1900	1900	1900	1900	1900	1900	1900
Adjustment:	0.92	0.98	0.95	0.92	0.98	0.95	0.92	0.98	0.95	0.92	0.98	0.95
Lanes:	1.00	1.89	0.11	1.00	1.84	0.16	1.00	1.51	0.49	1.00	1.49	0.51
Final Sat.:	1750	3504	196	1750	3408	291	1750	2816	883	1750	2778	921

Capacity Analysis Module:												
Vol/Sat:	0.12	0.18	0.18	0.19	0.33	0.33	0.06	0.23	0.23	0.07	0.21	0.21
Crit Moves:	****				****			****			****	
Green Time:	21.2	37.2	37.2	39.8	55.9	55.9	10.5	38.6	38.6	12.3	40.5	40.5
Volume/Cap:	0.82	0.67	0.67	0.67	0.82	0.82	0.74	0.82	0.82	0.82	0.74	0.74
Delay/Veh:	75.2	47.8	47.8	47.9	41.2	41.2	83.2	52.6	52.6	90.3	47.8	47.8
User DelAdj:	1.00	1.00	1.00	1.00	1.00	1.00	1.00	1.00	1.00	1.00	1.00	1.00
AdjDel/Veh:	75.2	47.8	47.8	47.9	41.2	41.2	83.2	52.6	52.6	90.3	47.8	47.8
LOS by Move:	E	D	D	D	D	D	F	D	D	F	D	D
HCM2k95thQ:	22	24	24	24	40	40	12	33	33	12	28	28

Note: Queue reported is the number of cars per lane.

BART Phase II Extension Project

Level Of Service Computation Report
2000 HCM Operations (Future Volume Alternative)
AM - 2025 Project Conditions

Intersection #3059: ALAMEDA/RACE *

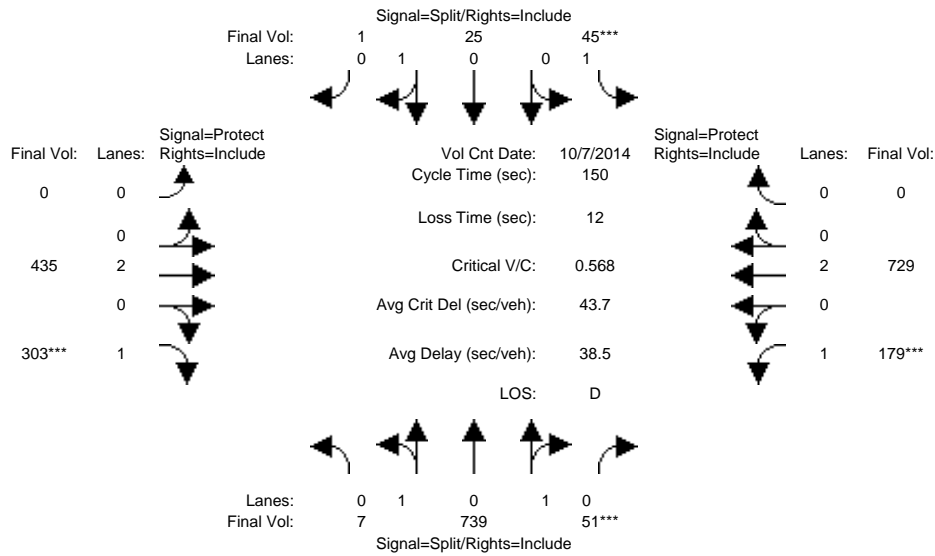

Approach:	North Bound			South Bound			East Bound			West Bound		
	L	T	R	L	T	R	L	T	R	L	T	R
Min. Green:	10	10	10	10	10	10	0	10	10	7	10	0
Y+R:	4.0	4.0	4.0	4.0	4.0	4.0	4.0	4.0	4.0	4.0	4.0	4.0
Volume Module: >> Count Date: 7 Oct 2014 <<												
Base Vol:	7	739	51	45	25	1	0	435	303	179	729	0
Growth Adj:	1.00	1.00	1.00	1.00	1.00	1.00	1.00	1.00	1.00	1.00	1.00	1.00
Initial Bse:	7	739	51	45	25	1	0	435	303	179	729	0
Added Vol:	0	0	0	0	0	0	0	0	0	0	0	0
PasserByVol:	0	0	0	0	0	0	0	0	0	0	0	0
Initial Fut:	7	739	51	45	25	1	0	435	303	179	729	0
User Adj:	1.00	1.00	1.00	1.00	1.00	1.00	1.00	1.00	1.00	1.00	1.00	1.00
PHF Adj:	1.00	1.00	1.00	1.00	1.00	1.00	1.00	1.00	1.00	1.00	1.00	1.00
PHF Volume:	7	739	51	45	25	1	0	435	303	179	729	0
Reduct Vol:	0	0	0	0	0	0	0	0	0	0	0	0
Reduced Vol:	7	739	51	45	25	1	0	435	303	179	729	0
PCE Adj:	1.00	1.00	1.00	1.00	1.00	1.00	1.00	1.00	1.00	1.00	1.00	1.00
MLF Adj:	1.00	1.00	1.00	1.00	1.00	1.00	1.00	1.00	1.00	1.00	1.00	1.00
Final Volume:	7	739	51	45	25	1	0	435	303	179	729	0
Saturation Flow Module:												
Sat/Lane:	1900	1900	1900	1900	1900	1900	1900	1900	1900	1900	1900	1900
Adjustment:	0.95	0.95	0.95	0.92	0.95	0.95	0.92	1.00	0.92	0.92	1.00	0.92
Lanes:	0.02	1.85	0.13	1.00	0.96	0.04	0.00	2.00	1.00	1.00	2.00	0.00
Final Sat.:	32	3338	230	1750	1731	69	0	3800	1750	1750	3800	0
Capacity Analysis Module:												
Vol/Sat:	0.22	0.22	0.22	0.03	0.01	0.01	0.00	0.11	0.17	0.10	0.19	0.00
Crit Moves:			****	****					****	****		
Green Time:	57.0	57.0	57.0	10.0	10.0	10.0	0.0	44.6	44.6	26.4	71.0	0.0
Volume/Cap:	0.58	0.58	0.58	0.39	0.22	0.22	0.00	0.38	0.58	0.58	0.41	0.00
Delay/Veh:	37.6	37.6	37.6	69.2	67.2	67.2	0.0	42.0	46.5	59.6	25.9	0.0
User DelAdj:	1.00	1.00	1.00	1.00	1.00	1.00	1.00	1.00	1.00	1.00	1.00	1.00
AdjDel/Veh:	37.6	37.6	37.6	69.2	67.2	67.2	0.0	42.0	46.5	59.6	25.9	0.0
LOS by Move:	D	D	D	E	E	E	A	D	D	E	C	A
HCM2k95thQ:	26	26	26	5	3	3	0	14	23	15	19	0

Note: Queue reported is the number of cars per lane.

BART Phase II Extension Project

Level Of Service Computation Report
 2000 HCM Operations (Future Volume Alternative)
 PM - 2025 Project Conditions

Intersection #3059: ALAMEDA/RACE *

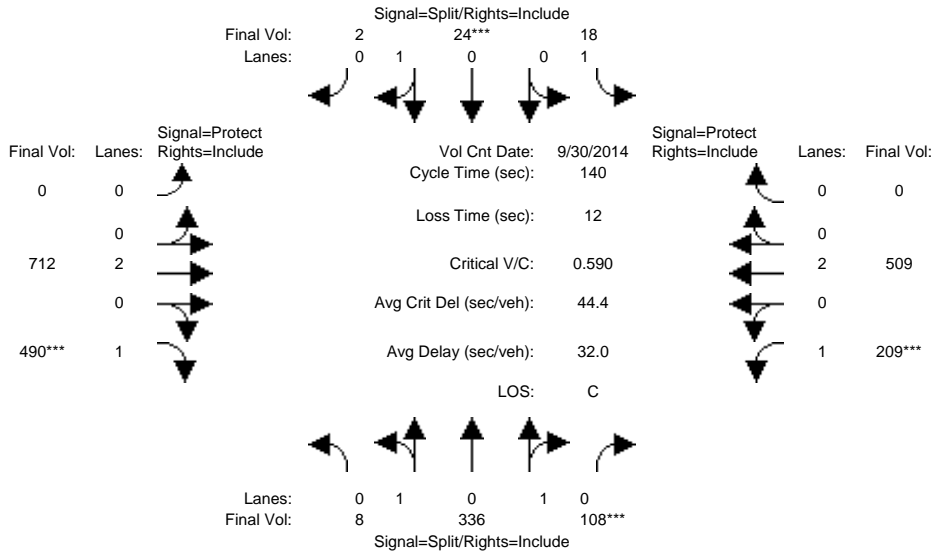

Approach:	North Bound			South Bound			East Bound			West Bound		
	L	T	R	L	T	R	L	T	R	L	T	R
Min. Green:	10	10	10	10	10	10	0	10	10	7	10	0
Y+R:	4.0	4.0	4.0	4.0	4.0	4.0	4.0	4.0	4.0	4.0	4.0	4.0

Volume Module:	>> Count Date: 30 Sep 2014 <<											
Base Vol:	8	336	108	18	24	2	0	712	490	209	509	0
Growth Adj:	1.00	1.00	1.00	1.00	1.00	1.00	1.00	1.00	1.00	1.00	1.00	1.00
Initial Bse:	8	336	108	18	24	2	0	712	490	209	509	0
Added Vol:	0	0	0	0	0	0	0	0	0	0	0	0
PasserByVol:	0	0	0	0	0	0	0	0	0	0	0	0
Initial Fut:	8	336	108	18	24	2	0	712	490	209	509	0
User Adj:	1.00	1.00	1.00	1.00	1.00	1.00	1.00	1.00	1.00	1.00	1.00	1.00
PHF Adj:	1.00	1.00	1.00	1.00	1.00	1.00	1.00	1.00	1.00	1.00	1.00	1.00
PHF Volume:	8	336	108	18	24	2	0	712	490	209	509	0
Reduct Vol:	0	0	0	0	0	0	0	0	0	0	0	0
Reduced Vol:	8	336	108	18	24	2	0	712	490	209	509	0
PCE Adj:	1.00	1.00	1.00	1.00	1.00	1.00	1.00	1.00	1.00	1.00	1.00	1.00
MLF Adj:	1.00	1.00	1.00	1.00	1.00	1.00	1.00	1.00	1.00	1.00	1.00	1.00
FinalVolume:	8	336	108	18	24	2	0	712	490	209	509	0

Saturation Flow Module:												
Sat/Lane:	1900	1900	1900	1900	1900	1900	1900	1900	1900	1900	1900	1900
Adjustment:	0.95	0.95	0.95	0.92	0.95	0.95	0.92	1.00	0.92	0.92	1.00	0.92
Lanes:	0.03	1.49	0.48	1.00	0.92	0.08	0.00	2.00	1.00	1.00	2.00	0.00
Final Sat.:	64	2676	860	1750	1662	138	0	3800	1750	1750	3800	0

Capacity Analysis Module:												
Vol/Sat:	0.13	0.13	0.13	0.01	0.01	0.01	0.00	0.19	0.28	0.12	0.13	0.00
Crit Moves:			****			****			****		****	
Green Time:	28.2	28.2	28.2	10.0	10.0	10.0	0.0	62.9	62.9	26.8	89.8	0.0
Volume/Cap:	0.62	0.62	0.62	0.14	0.20	0.20	0.00	0.42	0.62	0.62	0.21	0.00
Delay/Veh:	52.7	52.7	52.7	61.5	62.0	62.0	0.0	26.3	31.0	55.5	10.4	0.0
User DelAdj:	1.00	1.00	1.00	1.00	1.00	1.00	1.00	1.00	1.00	1.00	1.00	1.00
AdjDel/Veh:	52.7	52.7	52.7	61.5	62.0	62.0	0.0	26.3	31.0	55.5	10.4	0.0
LOS by Move:	D	D	D	E	E	E	A	C	C	E	B	A
HCM2k95thQ:	17	17	17	2	3	3	0	18	30	17	9	0

Note: Queue reported is the number of cars per lane.

BART Phase II Extension Project

Level Of Service Computation Report
2000 HCM Operations (Future Volume Alternative)
AM - 2025 Project Conditions

Intersection #3066: AUTUMN/SANTA CLARA

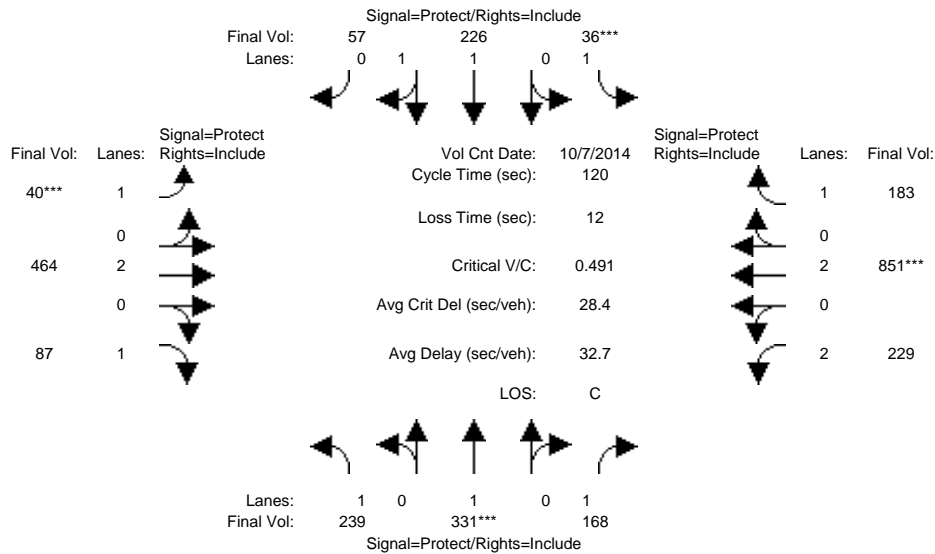

Approach:	North Bound			South Bound			East Bound			West Bound		
	L	T	R	L	T	R	L	T	R	L	T	R
Min. Green:	7	10	10	7	10	10	7	10	10	7	10	10
Y+R:	4.0	4.0	4.0	4.0	4.0	4.0	4.0	4.0	4.0	4.0	4.0	4.0
Volume Module: >> Count Date: 7 Oct 2014 <<												
Base Vol:	239	331	168	36	226	57	40	464	87	229	851	183
Growth Adj:	1.00	1.00	1.00	1.00	1.00	1.00	1.00	1.00	1.00	1.00	1.00	1.00
Initial Bse:	239	331	168	36	226	57	40	464	87	229	851	183
Added Vol:	0	0	0	0	0	0	0	0	0	0	0	0
PasserByVol:	0	0	0	0	0	0	0	0	0	0	0	0
Initial Fut:	239	331	168	36	226	57	40	464	87	229	851	183
User Adj:	1.00	1.00	1.00	1.00	1.00	1.00	1.00	1.00	1.00	1.00	1.00	1.00
PHF Adj:	1.00	1.00	1.00	1.00	1.00	1.00	1.00	1.00	1.00	1.00	1.00	1.00
PHF Volume:	239	331	168	36	226	57	40	464	87	229	851	183
Reduct Vol:	0	0	0	0	0	0	0	0	0	0	0	0
Reduced Vol:	239	331	168	36	226	57	40	464	87	229	851	183
PCE Adj:	1.00	1.00	1.00	1.00	1.00	1.00	1.00	1.00	1.00	1.00	1.00	1.00
MLF Adj:	1.00	1.00	1.00	1.00	1.00	1.00	1.00	1.00	1.00	1.00	1.00	1.00
Final Volume:	239	331	168	36	226	57	40	464	87	229	851	183
Saturation Flow Module:												
Sat/Lane:	1900	1900	1900	1900	1900	1900	1900	1900	1900	1900	1900	1900
Adjustment:	0.92	1.00	0.92	0.92	0.98	0.95	0.92	1.00	0.92	0.83	1.00	0.92
Lanes:	1.00	1.00	1.00	1.00	1.59	0.41	1.00	2.00	1.00	2.00	2.00	1.00
Final Sat.:	1750	1900	1750	1750	2954	745	1750	3800	1750	3150	3800	1750
Capacity Analysis Module:												
Vol/Sat:	0.14	0.17	0.10	0.02	0.08	0.08	0.02	0.12	0.05	0.07	0.22	0.10
Crit Moves:	****	****	****	****	****	****	****	****	****	****	****	****
Green Time:	29.9	41.1	41.1	7.0	18.2	18.2	7.0	37.5	37.5	22.3	52.9	52.9
Volume/Cap:	0.55	0.51	0.28	0.35	0.50	0.50	0.39	0.39	0.16	0.39	0.51	0.24
Delay/Veh:	40.7	32.1	28.9	56.4	47.5	47.5	56.9	32.5	30.0	43.3	24.5	21.1
User DelAdj:	1.00	1.00	1.00	1.00	1.00	1.00	1.00	1.00	1.00	1.00	1.00	1.00
AdjDel/Veh:	40.7	32.1	28.9	56.4	47.5	47.5	56.9	32.5	30.0	43.3	24.5	21.1
LOS by Move:	D	C	C	E	D	D	E	C	C	D	C	C
HCM2k95thQ:	15	17	9	3	9	9	3	12	5	9	20	9

Note: Queue reported is the number of cars per lane.

BART Phase II Extension Project

Level Of Service Computation Report
 2000 HCM Operations (Future Volume Alternative)
 PM - 2025 Project Conditions

Intersection #3066: AUTUMN/SANTA CLARA

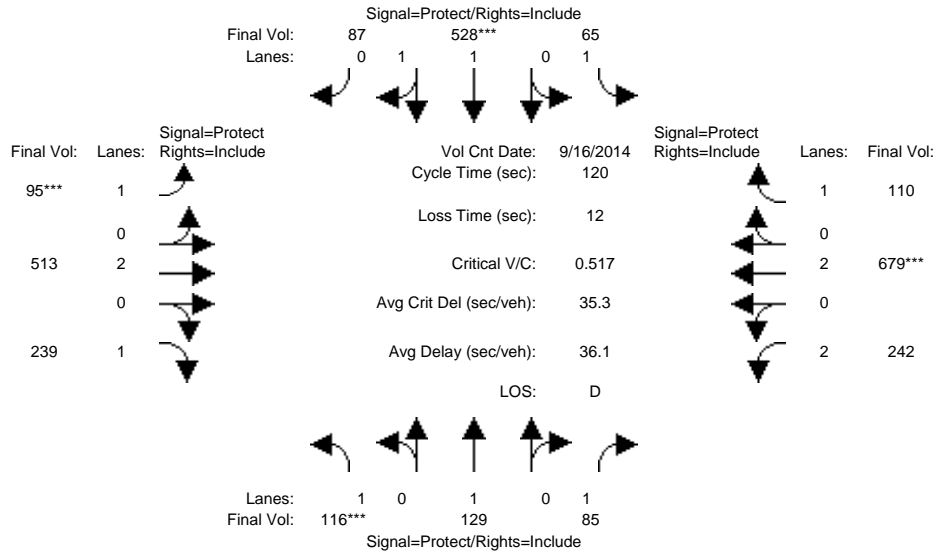

Approach:	North Bound			South Bound			East Bound			West Bound		
Movement:	L	T	R	L	T	R	L	T	R	L	T	R
Min. Green:	7	10	10	7	10	10	7	10	10	7	10	10
Y+R:	4.0	4.0	4.0	4.0	4.0	4.0	4.0	4.0	4.0	4.0	4.0	4.0
Volume Module: >> Count Date: 16 Sep 2014 <<												
Base Vol:	116	129	85	65	528	87	95	513	239	242	679	110
Growth Adj:	1.00	1.00	1.00	1.00	1.00	1.00	1.00	1.00	1.00	1.00	1.00	1.00
Initial Bse:	116	129	85	65	528	87	95	513	239	242	679	110
Added Vol:	0	0	0	0	0	0	0	0	0	0	0	0
PasserByVol:	0	0	0	0	0	0	0	0	0	0	0	0
Initial Fut:	116	129	85	65	528	87	95	513	239	242	679	110
User Adj:	1.00	1.00	1.00	1.00	1.00	1.00	1.00	1.00	1.00	1.00	1.00	1.00
PHF Adj:	1.00	1.00	1.00	1.00	1.00	1.00	1.00	1.00	1.00	1.00	1.00	1.00
PHF Volume:	116	129	85	65	528	87	95	513	239	242	679	110
Reduct Vol:	0	0	0	0	0	0	0	0	0	0	0	0
Reduced Vol:	116	129	85	65	528	87	95	513	239	242	679	110
PCE Adj:	1.00	1.00	1.00	1.00	1.00	1.00	1.00	1.00	1.00	1.00	1.00	1.00
MLF Adj:	1.00	1.00	1.00	1.00	1.00	1.00	1.00	1.00	1.00	1.00	1.00	1.00
Final Volume:	116	129	85	65	528	87	95	513	239	242	679	110
Saturation Flow Module:												
Sat/Lane:	1900	1900	1900	1900	1900	1900	1900	1900	1900	1900	1900	1900
Adjustment:	0.92	1.00	0.92	0.92	0.98	0.95	0.92	1.00	0.92	0.83	1.00	0.92
Lanes:	1.00	1.00	1.00	1.00	1.71	0.29	1.00	2.00	1.00	2.00	2.00	1.00
Final Sat.:	1750	1900	1750	1750	3176	523	1750	3800	1750	3150	3800	1750
Capacity Analysis Module:												
Vol/Sat:	0.07	0.07	0.05	0.04	0.17	0.17	0.05	0.14	0.14	0.08	0.18	0.06
Crit Moves:	****				****		****				****	
Green Time:	15.4	31.7	31.7	22.2	38.6	38.6	12.6	34.6	34.6	19.5	41.5	41.5
Volume/Cap:	0.52	0.26	0.18	0.20	0.52	0.52	0.52	0.47	0.47	0.47	0.52	0.18
Delay/Veh:	51.0	35.1	34.3	41.7	33.5	33.5	53.4	35.5	35.9	46.3	31.7	27.6
User DelAdj:	1.00	1.00	1.00	1.00	1.00	1.00	1.00	1.00	1.00	1.00	1.00	1.00
AdjDel/Veh:	51.0	35.1	34.3	41.7	33.5	33.5	53.4	35.5	35.9	46.3	31.7	27.6
LOS by Move:	D	D	C	D	C	C	D	D	D	D	C	C
HCM2k95thQ:	8	7	5	4	17	17	7	14	14	9	18	6

Note: Queue reported is the number of cars per lane.

BART Phase II Extension Project

Level Of Service Computation Report
2000 HCM Operations (Future Volume Alternative)
AM - 2025 Project Conditions

Intersection #3077: BIRD/SAN CARLOS

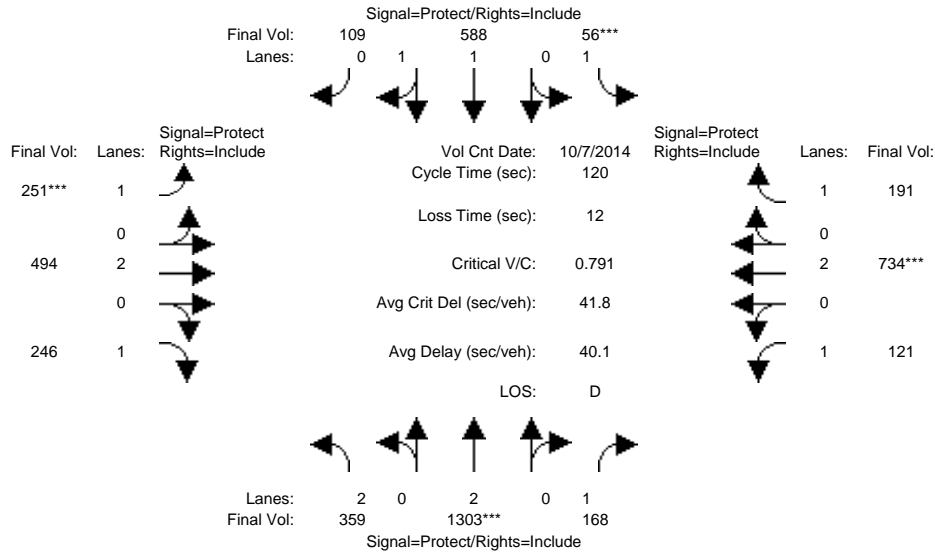

Approach:	North Bound			South Bound			East Bound			West Bound		
	L	T	R	L	T	R	L	T	R	L	T	R
Min. Green:	7	10	10	7	10	10	7	10	10	7	10	10
Y+R:	4.0	4.0	4.0	4.0	4.0	4.0	4.0	4.0	4.0	4.0	4.0	4.0
Volume Module: >> Count Date: 7 Oct 2014 <<												
Base Vol:	359	1303	168	56	588	109	251	494	246	121	734	191
Growth Adj:	1.00	1.00	1.00	1.00	1.00	1.00	1.00	1.00	1.00	1.00	1.00	1.00
Initial Bse:	359	1303	168	56	588	109	251	494	246	121	734	191
Added Vol:	0	0	0	0	0	0	0	0	0	0	0	0
PasserByVol:	0	0	0	0	0	0	0	0	0	0	0	0
Initial Fut:	359	1303	168	56	588	109	251	494	246	121	734	191
User Adj:	1.00	1.00	1.00	1.00	1.00	1.00	1.00	1.00	1.00	1.00	1.00	1.00
PHF Adj:	1.00	1.00	1.00	1.00	1.00	1.00	1.00	1.00	1.00	1.00	1.00	1.00
PHF Volume:	359	1303	168	56	588	109	251	494	246	121	734	191
Reduct Vol:	0	0	0	0	0	0	0	0	0	0	0	0
Reduced Vol:	359	1303	168	56	588	109	251	494	246	121	734	191
PCE Adj:	1.00	1.00	1.00	1.00	1.00	1.00	1.00	1.00	1.00	1.00	1.00	1.00
MLF Adj:	1.00	1.00	1.00	1.00	1.00	1.00	1.00	1.00	1.00	1.00	1.00	1.00
FinalVolume:	359	1303	168	56	588	109	251	494	246	121	734	191
Saturation Flow Module:												
Sat/Lane:	1900	1900	1900	1900	1900	1900	1900	1900	1900	1900	1900	1900
Adjustment:	0.83	1.00	0.92	0.92	0.98	0.95	0.92	1.00	0.92	0.92	1.00	0.92
Lanes:	2.00	2.00	1.00	1.00	1.68	0.32	1.00	2.00	1.00	1.00	2.00	1.00
Final Sat.:	3150	3800	1750	1750	3121	579	1750	3800	1750	1750	3800	1750
Capacity Analysis Module:												
Vol/Sat:	0.11	0.34	0.10	0.03	0.19	0.19	0.14	0.13	0.14	0.07	0.19	0.11
Crit Moves:	****	****	****	****	****	****	****	****	****	****	****	****
Green Time:	21.8	51.0	51.0	7.0	36.1	36.1	21.3	33.5	33.5	16.5	28.7	28.7
Volume/Cap:	0.63	0.81	0.23	0.55	0.63	0.63	0.81	0.47	0.50	0.50	0.81	0.46
Delay/Veh:	47.5	33.3	22.1	61.2	37.3	37.3	61.8	36.1	37.1	49.6	48.4	39.8
User DelAdj:	1.00	1.00	1.00	1.00	1.00	1.00	1.00	1.00	1.00	1.00	1.00	1.00
AdjDel/Veh:	47.5	33.3	22.1	61.2	37.3	37.3	61.8	36.1	37.1	49.6	48.4	39.8
LOS by Move:	D	C	C	E	D	D	E	D	D	D	D	D
HCM2k95thQ:	14	36	8	5	20	20	19	14	15	9	24	12

Note: Queue reported is the number of cars per lane.

BART Phase II Extension Project

Level Of Service Computation Report
2000 HCM Operations (Future Volume Alternative)
PM - 2025 Project Conditions

Intersection #3077: BIRD/SAN CARLOS

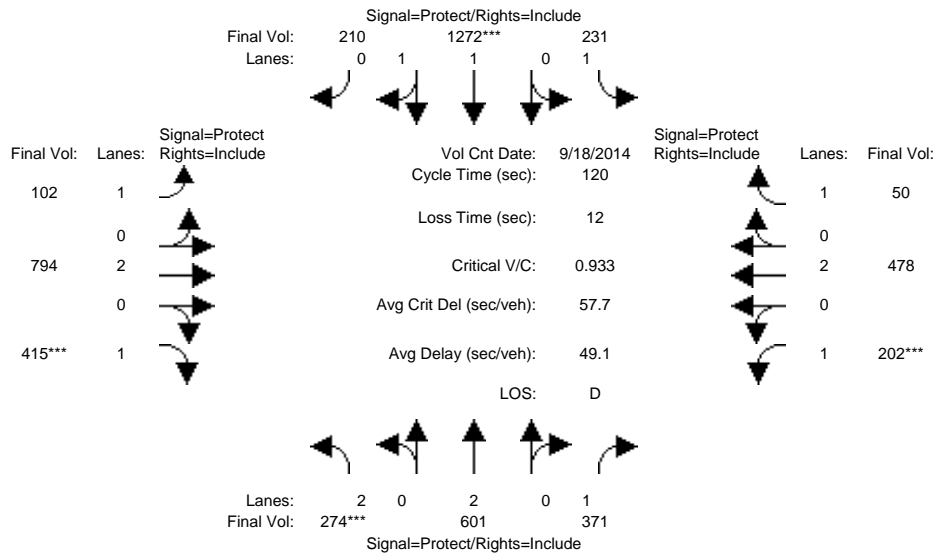

Approach:	North Bound			South Bound			East Bound			West Bound		
	L	T	R	L	T	R	L	T	R	L	T	R
Min. Green:	7	10	10	7	10	10	7	10	10	7	10	10
Y+R:	4.0	4.0	4.0	4.0	4.0	4.0	4.0	4.0	4.0	4.0	4.0	4.0

Volume Module:	>> Count Date: 18 Sep 2014 <<											
Base Vol:	274	601	371	231	1272	210	102	794	415	202	478	50
Growth Adj:	1.00	1.00	1.00	1.00	1.00	1.00	1.00	1.00	1.00	1.00	1.00	1.00
Initial Bse:	274	601	371	231	1272	210	102	794	415	202	478	50
Added Vol:	0	0	0	0	0	0	0	0	0	0	0	0
PasserByVol:	0	0	0	0	0	0	0	0	0	0	0	0
Initial Fut:	274	601	371	231	1272	210	102	794	415	202	478	50
User Adj:	1.00	1.00	1.00	1.00	1.00	1.00	1.00	1.00	1.00	1.00	1.00	1.00
PHF Adj:	1.00	1.00	1.00	1.00	1.00	1.00	1.00	1.00	1.00	1.00	1.00	1.00
PHF Volume:	274	601	371	231	1272	210	102	794	415	202	478	50
Reduct Vol:	0	0	0	0	0	0	0	0	0	0	0	0
Reduced Vol:	274	601	371	231	1272	210	102	794	415	202	478	50
PCE Adj:	1.00	1.00	1.00	1.00	1.00	1.00	1.00	1.00	1.00	1.00	1.00	1.00
MLF Adj:	1.00	1.00	1.00	1.00	1.00	1.00	1.00	1.00	1.00	1.00	1.00	1.00
FinalVolume:	274	601	371	231	1272	210	102	794	415	202	478	50

Saturation Flow Module:												
Sat/Lane:	1900	1900	1900	1900	1900	1900	1900	1900	1900	1900	1900	1900
Adjustment:	0.83	1.00	0.92	0.92	0.98	0.95	0.92	1.00	0.92	0.92	1.00	0.92
Lanes:	2.00	2.00	1.00	1.00	1.71	0.29	1.00	2.00	1.00	1.00	2.00	1.00
Final Sat.:	3150	3800	1750	1750	3175	524	1750	3800	1750	1750	3800	1750

Capacity Analysis Module:												
Vol/Sat:	0.09	0.16	0.21	0.13	0.40	0.40	0.06	0.21	0.24	0.12	0.13	0.03
Crit Moves:	****			****			****		****			
Green Time:	11.2	38.6	38.6	24.1	51.5	51.5	14.4	30.5	30.5	14.8	31.0	31.0
Volume/Cap:	0.93	0.49	0.66	0.66	0.93	0.93	0.49	0.82	0.93	0.93	0.49	0.11
Delay/Veh:	89.3	33.1	37.9	48.7	43.1	43.1	51.2	48.0	70.6	95.0	38.2	34.1
User DelAdj:	1.00	1.00	1.00	1.00	1.00	1.00	1.00	1.00	1.00	1.00	1.00	1.00
AdjDel/Veh:	89.3	33.1	37.9	48.7	43.1	43.1	51.2	48.0	70.6	95.0	38.2	34.1
LOS by Move:	F	C	D	D	D	D	D	D	E	F	D	C
HCM2k95thQ:	14	16	23	16	48	48	7	26	32	18	14	3

Note: Queue reported is the number of cars per lane.

BART Phase II Extension Project

Level Of Service Computation Report
 2000 HCM Operations (Future Volume Alternative)
 AM - 2025 Project Conditions

Intersection #3112: MONTGOMERY/SANTA CLARA

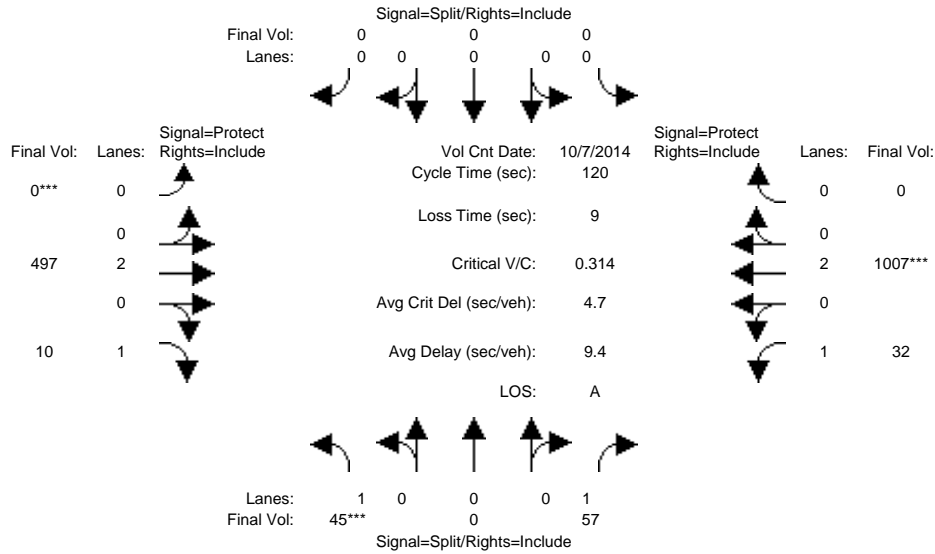

Approach:	North Bound			South Bound			East Bound			West Bound		
	L	T	R	L	T	R	L	T	R	L	T	R
Min. Green:	10	0	10	0	0	0	0	10	10	7	10	0
Y+R:	4.0	4.0	4.0	4.0	4.0	4.0	4.0	4.0	4.0	4.0	4.0	4.0
Volume Module: >> Count Date: 7 Oct 2014 <<												
Base Vol:	45	0	57	0	0	0	0	497	10	32	1007	0
Growth Adj:	1.00	1.00	1.00	1.00	1.00	1.00	1.00	1.00	1.00	1.00	1.00	1.00
Initial Bse:	45	0	57	0	0	0	0	497	10	32	1007	0
Added Vol:	0	0	0	0	0	0	0	0	0	0	0	0
PasserByVol:	0	0	0	0	0	0	0	0	0	0	0	0
Initial Fut:	45	0	57	0	0	0	0	497	10	32	1007	0
User Adj:	1.00	1.00	1.00	1.00	1.00	1.00	1.00	1.00	1.00	1.00	1.00	1.00
PHF Adj:	1.00	1.00	1.00	1.00	1.00	1.00	1.00	1.00	1.00	1.00	1.00	1.00
PHF Volume:	45	0	57	0	0	0	0	497	10	32	1007	0
Reduct Vol:	0	0	0	0	0	0	0	0	0	0	0	0
Reduced Vol:	45	0	57	0	0	0	0	497	10	32	1007	0
PCE Adj:	1.00	1.00	1.00	1.00	1.00	1.00	1.00	1.00	1.00	1.00	1.00	1.00
MLF Adj:	1.00	1.00	1.00	1.00	1.00	1.00	1.00	1.00	1.00	1.00	1.00	1.00
FinalVolume:	45	0	57	0	0	0	0	497	10	32	1007	0
Saturation Flow Module:												
Sat/Lane:	1900	1900	1900	1900	1900	1900	1900	1900	1900	1900	1900	1900
Adjustment:	0.92	1.00	0.92	0.92	1.00	0.92	0.92	1.00	0.92	0.92	1.00	0.92
Lanes:	1.00	0.00	1.00	0.00	0.00	0.00	0.00	2.00	1.00	1.00	2.00	0.00
Final Sat.:	1750	0	1750	0	0	0	0	3800	1750	1750	3800	0
Capacity Analysis Module:												
Vol/Sat:	0.03	0.00	0.03	0.00	0.00	0.00	0.00	0.13	0.01	0.02	0.27	0.00
Crit Moves:	****							****			****	
Green Time:	12.4	0.0	12.4	0.0	0.0	0.0	0.0	68.2	68.2	30.4	98.6	0.0
Volume/Cap:	0.25	0.00	0.31	0.00	0.00	0.00	0.00	0.23	0.01	0.07	0.32	0.00
Delay/Veh:	50.2	0.0	50.8	0.0	0.0	0.0	0.0	12.9	11.3	34.1	2.7	0.0
User DelAdj:	1.00	1.00	1.00	1.00	1.00	1.00	1.00	1.00	1.00	1.00	1.00	1.00
AdjDel/Veh:	50.2	0.0	50.8	0.0	0.0	0.0	0.0	12.9	11.3	34.1	2.7	0.0
LOS by Move:	D	A	D	A	A	A	A	B	B	C	A	A
HCM2k95thQ:	4	0	5	0	0	0	0	9	0	2	9	0

Note: Queue reported is the number of cars per lane.

BART Phase II Extension Project

Level Of Service Computation Report
2000 HCM Operations (Future Volume Alternative)
PM - 2025 Project Conditions

Intersection #3112: MONTGOMERY/SANTA CLARA

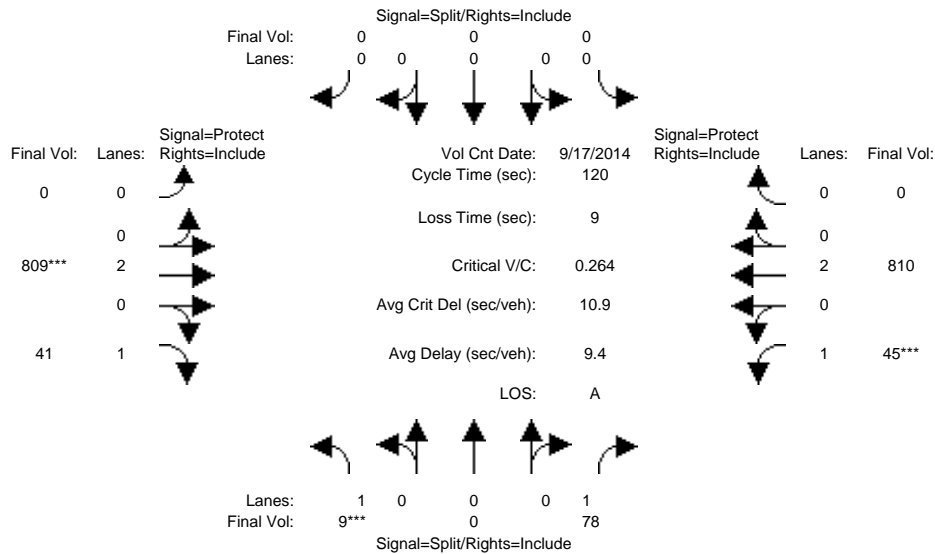

Approach:	North Bound			South Bound			East Bound			West Bound		
	L	T	R	L	T	R	L	T	R	L	T	R
Min. Green:	10	0	10	0	0	0	0	10	10	7	10	0
Y+R:	4.0	4.0	4.0	4.0	4.0	4.0	4.0	4.0	4.0	4.0	4.0	4.0
Volume Module: >> Count Date: 17 Sep 2014 <<												
Base Vol:	9	0	78	0	0	0	0	809	41	45	810	0
Growth Adj:	1.00	1.00	1.00	1.00	1.00	1.00	1.00	1.00	1.00	1.00	1.00	1.00
Initial Bse:	9	0	78	0	0	0	0	809	41	45	810	0
Added Vol:	0	0	0	0	0	0	0	0	0	0	0	0
PasserByVol:	0	0	0	0	0	0	0	0	0	0	0	0
Initial Fut:	9	0	78	0	0	0	0	809	41	45	810	0
User Adj:	1.00	1.00	1.00	1.00	1.00	1.00	1.00	1.00	1.00	1.00	1.00	1.00
PHF Adj:	1.00	1.00	1.00	1.00	1.00	1.00	1.00	1.00	1.00	1.00	1.00	1.00
PHF Volume:	9	0	78	0	0	0	0	809	41	45	810	0
Reduct Vol:	0	0	0	0	0	0	0	0	0	0	0	0
Reduced Vol:	9	0	78	0	0	0	0	809	41	45	810	0
PCE Adj:	1.00	1.00	1.00	1.00	1.00	1.00	1.00	1.00	1.00	1.00	1.00	1.00
MLF Adj:	1.00	1.00	1.00	1.00	1.00	1.00	1.00	1.00	1.00	1.00	1.00	1.00
Final Volume:	9	0	78	0	0	0	0	809	41	45	810	0
Saturation Flow Module:												
Sat/Lane:	1900	1900	1900	1900	1900	1900	1900	1900	1900	1900	1900	1900
Adjustment:	0.92	1.00	0.92	0.92	1.00	0.92	0.92	1.00	0.92	0.92	1.00	0.92
Lanes:	1.00	0.00	1.00	0.00	0.00	0.00	0.00	2.00	1.00	1.00	2.00	0.00
Final Sat.:	1750	0	1750	0	0	0	0	3800	1750	1750	3800	0
Capacity Analysis Module:												
Vol/Sat:	0.01	0.00	0.04	0.00	0.00	0.00	0.00	0.21	0.02	0.03	0.21	0.00
Crit Moves:	****							****		****		
Green Time:	20.3	0.0	20.3	0.0	0.0	0.0	0.0	80.9	80.9	9.8	90.7	0.0
Volume/Cap:	0.03	0.00	0.26	0.00	0.00	0.00	0.00	0.32	0.03	0.32	0.28	0.00
Delay/Veh:	41.7	0.0	43.8	0.0	0.0	0.0	0.0	8.2	6.5	53.2	4.6	0.0
User DelAdj:	1.00	1.00	1.00	1.00	1.00	1.00	1.00	1.00	1.00	1.00	1.00	1.00
AdjDel/Veh:	41.7	0.0	43.8	0.0	0.0	0.0	0.0	8.2	6.5	53.2	4.6	0.0
LOS by Move:	D	A	D	A	A	A	A	A	A	D	A	A
HCM2k95thQ:	1	0	6	0	0	0	0	12	1	3	9	0

Note: Queue reported is the number of cars per lane.

BART Phase II Extension Project

Level Of Service Computation Report
2000 HCM Operations (Future Volume Alternative)
AM - 2025 Project Conditions

Intersection #3227: ALAMEDA/JULIAN

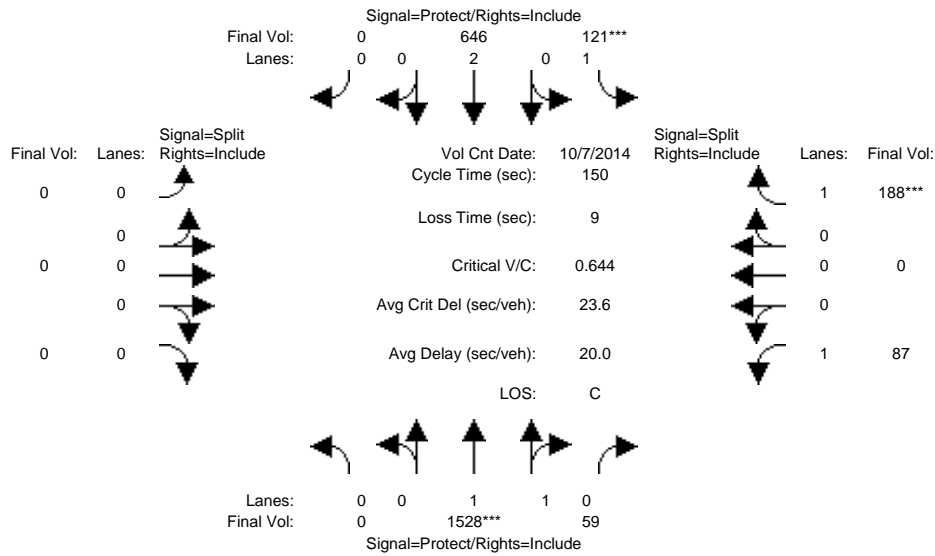

Approach:	North Bound			South Bound			East Bound			West Bound		
	L	T	R	L	T	R	L	T	R	L	T	R
Min. Green:	0	10	10	7	10	0	0	0	0	10	0	10
Y+R:	4.0	4.0	4.0	4.0	4.0	4.0	4.0	4.0	4.0	4.0	4.0	4.0

Volume Module:	>>	Count	Date:	7 Oct 2014	<<							
Base Vol:	0	1528	59	121	646	0	0	0	0	87	0	188
Growth Adj:	1.00	1.00	1.00	1.00	1.00	1.00	1.00	1.00	1.00	1.00	1.00	1.00
Initial Bse:	0	1528	59	121	646	0	0	0	0	87	0	188
Added Vol:	0	0	0	0	0	0	0	0	0	0	0	0
PasserByVol:	0	0	0	0	0	0	0	0	0	0	0	0
Initial Fut:	0	1528	59	121	646	0	0	0	0	87	0	188
User Adj:	1.00	1.00	1.00	1.00	1.00	1.00	1.00	1.00	1.00	1.00	1.00	1.00
PHF Adj:	1.00	1.00	1.00	1.00	1.00	1.00	1.00	1.00	1.00	1.00	1.00	1.00
PHF Volume:	0	1528	59	121	646	0	0	0	0	87	0	188
Reduct Vol:	0	0	0	0	0	0	0	0	0	0	0	0
Reduced Vol:	0	1528	59	121	646	0	0	0	0	87	0	188
PCE Adj:	1.00	1.00	1.00	1.00	1.00	1.00	1.00	1.00	1.00	1.00	1.00	1.00
MLF Adj:	1.00	1.00	1.00	1.00	1.00	1.00	1.00	1.00	1.00	1.00	1.00	1.00
FinalVolume:	0	1528	59	121	646	0	0	0	0	87	0	188

Saturation Flow Module:												
Sat/Lane:	1900	1900	1900	1900	1900	1900	1900	1900	1900	1900	1900	1900
Adjustment:	0.92	0.97	0.95	0.92	1.00	0.92	0.92	1.00	0.92	0.92	1.00	0.92
Lanes:	0.00	1.92	0.08	1.00	2.00	0.00	0.00	0.00	0.00	1.00	0.00	1.00
Final Sat.:	0	3562	138	1750	3800	0	0	0	0	1750	0	1750

Capacity Analysis Module:												
Vol/Sat:	0.00	0.43	0.43	0.07	0.17	0.00	0.00	0.00	0.00	0.05	0.00	0.11
Crit Moves:	****			****						****		
Green Time:	0.0	99.9	99.9	16.1	116	0.0	0.0	0.0	0.0	25.0	0.0	25.0
Volume/Cap:	0.00	0.64	0.64	0.64	0.22	0.00	0.00	0.00	0.00	0.30	0.00	0.64
Delay/Veh:	0.0	15.3	15.3	71.7	4.7	0.0	0.0	0.0	0.0	55.4	0.0	63.2
User DelAdj:	1.00	1.00	1.00	1.00	1.00	1.00	1.00	1.00	1.00	1.00	1.00	1.00
AdjDel/Veh:	0.0	15.3	15.3	71.7	4.7	0.0	0.0	0.0	0.0	55.4	0.0	63.2
LOS by Move:	A	B	B	E	A	A	A	A	A	E	A	E
HCM2k95thQ:	0	36	36	11	8	0	0	0	0	7	0	16

Note: Queue reported is the number of cars per lane.

BART Phase II Extension Project

Level Of Service Computation Report
2000 HCM Operations (Future Volume Alternative)
PM - 2025 Project Conditions

Intersection #3227: ALAMEDA/JULIAN

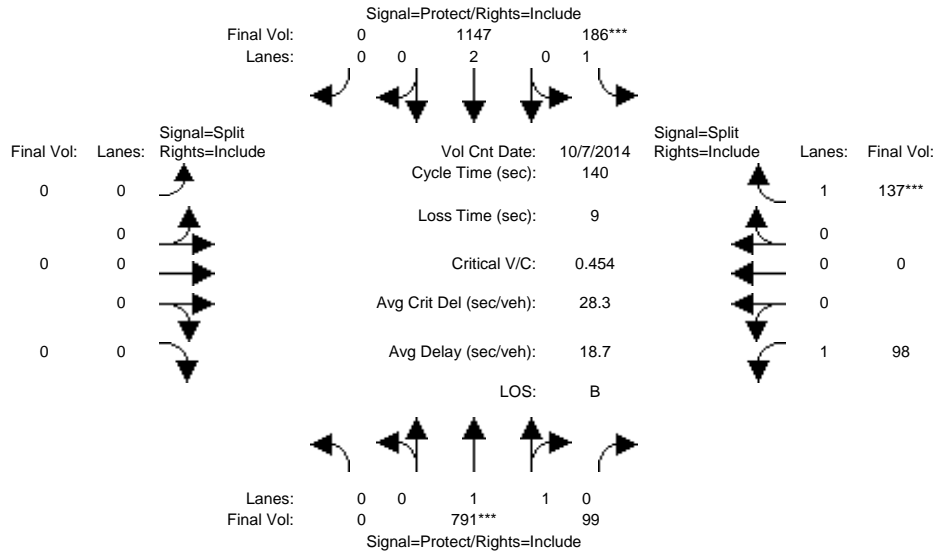

Approach:	North Bound			South Bound			East Bound			West Bound		
	L	T	R	L	T	R	L	T	R	L	T	R
Min. Green:	0	10	10	7	10	0	0	0	0	10	0	10
Y+R:	4.0	4.0	4.0	4.0	4.0	4.0	4.0	4.0	4.0	4.0	4.0	4.0
Volume Module: >> Count Date: 7 Oct 2014 <<												
Base Vol:	0	791	99	186	1147	0	0	0	0	98	0	137
Growth Adj:	1.00	1.00	1.00	1.00	1.00	1.00	1.00	1.00	1.00	1.00	1.00	1.00
Initial Bse:	0	791	99	186	1147	0	0	0	0	98	0	137
Added Vol:	0	0	0	0	0	0	0	0	0	0	0	0
PasserByVol:	0	0	0	0	0	0	0	0	0	0	0	0
Initial Fut:	0	791	99	186	1147	0	0	0	0	98	0	137
User Adj:	1.00	1.00	1.00	1.00	1.00	1.00	1.00	1.00	1.00	1.00	1.00	1.00
PHF Adj:	1.00	1.00	1.00	1.00	1.00	1.00	1.00	1.00	1.00	1.00	1.00	1.00
PHF Volume:	0	791	99	186	1147	0	0	0	0	98	0	137
Reduct Vol:	0	0	0	0	0	0	0	0	0	0	0	0
Reduced Vol:	0	791	99	186	1147	0	0	0	0	98	0	137
PCE Adj:	1.00	1.00	1.00	1.00	1.00	1.00	1.00	1.00	1.00	1.00	1.00	1.00
MLF Adj:	1.00	1.00	1.00	1.00	1.00	1.00	1.00	1.00	1.00	1.00	1.00	1.00
FinalVolume:	0	791	99	186	1147	0	0	0	0	98	0	137
Saturation Flow Module:												
Sat/Lane:	1900	1900	1900	1900	1900	1900	1900	1900	1900	1900	1900	1900
Adjustment:	0.92	0.98	0.95	0.92	1.00	0.92	0.92	1.00	0.92	0.92	1.00	0.92
Lanes:	0.00	1.77	0.23	1.00	2.00	0.00	0.00	0.00	0.00	1.00	0.00	1.00
Final Sat.:	0	3288	412	1750	3800	0	0	0	0	1750	0	1750
Capacity Analysis Module:												
Vol/Sat:	0.00	0.24	0.24	0.11	0.30	0.00	0.00	0.00	0.00	0.06	0.00	0.08
Crit Moves:	****			****						****		
Green Time:	0.0	74.1	74.1	32.8	107	0.0	0.0	0.0	0.0	24.1	0.0	24.1
Volume/Cap:	0.00	0.45	0.45	0.45	0.40	0.00	0.00	0.00	0.00	0.33	0.00	0.45
Delay/Veh:	0.0	20.6	20.6	46.8	5.7	0.0	0.0	0.0	0.0	51.4	0.0	53.1
User DelAdj:	1.00	1.00	1.00	1.00	1.00	1.00	1.00	1.00	1.00	1.00	1.00	1.00
AdjDel/Veh:	0.0	20.6	20.6	46.8	5.7	0.0	0.0	0.0	0.0	51.4	0.0	53.1
LOS by Move:	A	C	C	D	A	A	A	A	A	D	A	D
HCM2k95thQ:	0	21	21	14	16	0	0	0	0	8	0	11

Note: Queue reported is the number of cars per lane.

BART Phase II Extension Project

Level Of Service Computation Report
2000 HCM Operations (Future Volume Alternative)
AM - 2025 Project Conditions

Intersection #3230: ALAMEDA/STOCKTON

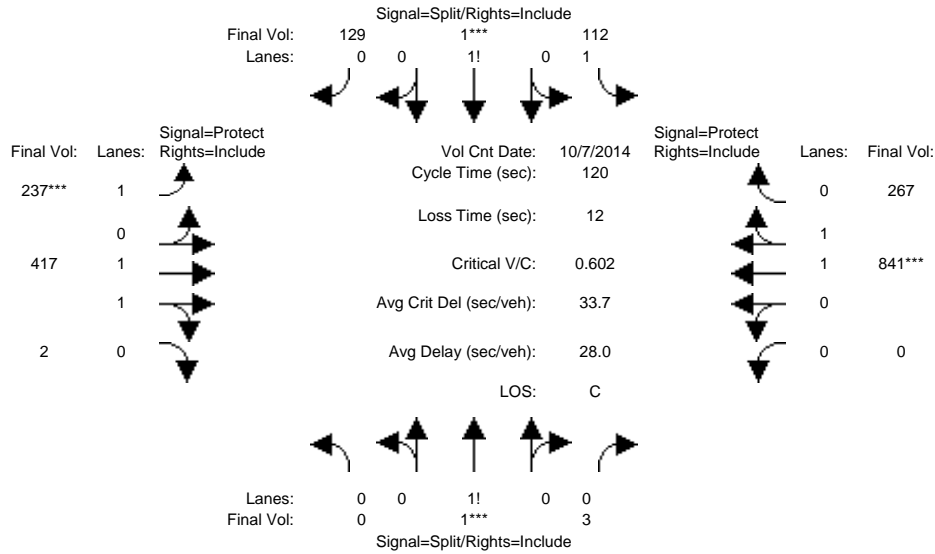

Approach:	North Bound			South Bound			East Bound			West Bound		
	L	T	R	L	T	R	L	T	R	L	T	R
Min. Green:	10	10	10	10	10	10	7	10	10	0	10	10
Y+R:	4.0	4.0	4.0	4.0	4.0	4.0	4.0	4.0	4.0	4.0	4.0	4.0

Volume Module:	>>	Count	Date:	7 Oct 2014	<<							
Base Vol:	0	1	3	112	1	129	237	417	2	0	841	267
Growth Adj:	1.00	1.00	1.00	1.00	1.00	1.00	1.00	1.00	1.00	1.00	1.00	1.00
Initial Bse:	0	1	3	112	1	129	237	417	2	0	841	267
Added Vol:	0	0	0	0	0	0	0	0	0	0	0	0
PasserByVol:	0	0	0	0	0	0	0	0	0	0	0	0
Initial Fut:	0	1	3	112	1	129	237	417	2	0	841	267
User Adj:	1.00	1.00	1.00	1.00	1.00	1.00	1.00	1.00	1.00	1.00	1.00	1.00
PHF Adj:	1.00	1.00	1.00	1.00	1.00	1.00	1.00	1.00	1.00	1.00	1.00	1.00
PHF Volume:	0	1	3	112	1	129	237	417	2	0	841	267
Reduct Vol:	0	0	0	0	0	0	0	0	0	0	0	0
Reduced Vol:	0	1	3	112	1	129	237	417	2	0	841	267
PCE Adj:	1.00	1.00	1.00	1.00	1.00	1.00	1.00	1.00	1.00	1.00	1.00	1.00
MLF Adj:	1.00	1.00	1.00	1.00	1.00	1.00	1.00	1.00	1.00	1.00	1.00	1.00
FinalVolume:	0	1	3	112	1	129	237	417	2	0	841	267

Saturation Flow Module:												
Sat/Lane:	1900	1900	1900	1900	1900	1900	1900	1900	1900	1900	1900	1900
Adjustment:	0.92	0.95	0.95	0.92	0.95	0.95	0.92	0.97	0.95	0.92	0.98	0.95
Lanes:	0.00	0.25	0.75	1.30	0.01	0.69	1.00	1.99	0.01	0.00	1.50	0.50
Final Sat.:	0	450	1350	2287	10	1238	1750	3682	18	0	2808	891

Capacity Analysis Module:												
Vol/Sat:	0.00	0.00	0.00	0.05	0.10	0.10	0.14	0.11	0.11	0.00	0.30	0.30
Crit Moves:	****			****			****			****		
Green Time:	0.0	10.0	10.0	18.9	18.9	18.9	24.6	79.1	79.1	0.0	54.4	54.4
Volume/Cap:	0.00	0.03	0.03	0.31	0.66	0.66	0.66	0.17	0.17	0.00	0.66	0.66
Delay/Veh:	0.0	50.6	50.6	45.0	51.9	51.9	48.4	7.9	7.9	0.0	26.6	26.6
User DelAdj:	1.00	1.00	1.00	1.00	1.00	1.00	1.00	1.00	1.00	1.00	1.00	1.00
AdjDel/Veh:	0.0	50.6	50.6	45.0	51.9	51.9	48.4	7.9	7.9	0.0	26.6	26.6
LOS by Move:	A	D	D	D	D	D	D	A	A	A	C	C
HCM2k95thQ:	0	0	0	6	13	13	16	6	6	0	28	28

Note: Queue reported is the number of cars per lane.

BART Phase II Extension Project

Level Of Service Computation Report
2000 HCM Operations (Future Volume Alternative)
PM - 2025 Project Conditions

Intersection #3230: ALAMEDA/STOCKTON

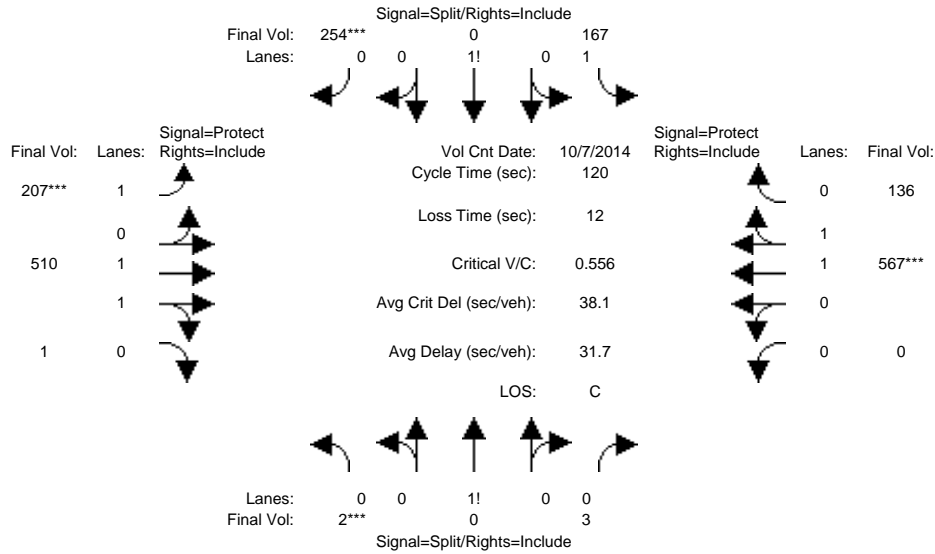

Approach:	North Bound			South Bound			East Bound			West Bound		
	L	T	R	L	T	R	L	T	R	L	T	R
Min. Green:	10	10	10	10	10	10	7	10	10	0	10	10
Y+R:	4.0	4.0	4.0	4.0	4.0	4.0	4.0	4.0	4.0	4.0	4.0	4.0
Volume Module: >> Count Date: 7 Oct 2014 <<												
Base Vol:	2	0	3	167	0	254	207	510	1	0	567	136
Growth Adj:	1.00	1.00	1.00	1.00	1.00	1.00	1.00	1.00	1.00	1.00	1.00	1.00
Initial Bse:	2	0	3	167	0	254	207	510	1	0	567	136
Added Vol:	0	0	0	0	0	0	0	0	0	0	0	0
PasserByVol:	0	0	0	0	0	0	0	0	0	0	0	0
Initial Fut:	2	0	3	167	0	254	207	510	1	0	567	136
User Adj:	1.00	1.00	1.00	1.00	1.00	1.00	1.00	1.00	1.00	1.00	1.00	1.00
PHF Adj:	1.00	1.00	1.00	1.00	1.00	1.00	1.00	1.00	1.00	1.00	1.00	1.00
PHF Volume:	2	0	3	167	0	254	207	510	1	0	567	136
Reduct Vol:	0	0	0	0	0	0	0	0	0	0	0	0
Reduced Vol:	2	0	3	167	0	254	207	510	1	0	567	136
PCE Adj:	1.00	1.00	1.00	1.00	1.00	1.00	1.00	1.00	1.00	1.00	1.00	1.00
MLF Adj:	1.00	1.00	1.00	1.00	1.00	1.00	1.00	1.00	1.00	1.00	1.00	1.00
FinalVolume:	2	0	3	167	0	254	207	510	1	0	567	136
Saturation Flow Module:												
Sat/Lane:	1900	1900	1900	1900	1900	1900	1900	1900	1900	1900	1900	1900
Adjustment:	0.92	0.92	0.92	0.92	1.00	0.95	0.92	0.97	0.95	0.92	0.98	0.95
Lanes:	0.40	0.00	0.60	1.25	0.00	0.75	1.00	1.99	0.01	0.00	1.60	0.40
Final Sat.:	700	0	1050	2192	0	1345	1750	3693	7	0	2984	716
Capacity Analysis Module:												
Vol/Sat:	0.00	0.00	0.00	0.08	0.00	0.19	0.12	0.14	0.14	0.00	0.19	0.19
Crit Moves:	****					****	****				****	
Green Time:	10.0	0.0	10.0	37.2	0.0	37.2	23.3	60.8	60.8	0.0	37.5	37.5
Volume/Cap:	0.03	0.00	0.03	0.25	0.00	0.61	0.61	0.27	0.27	0.00	0.61	0.61
Delay/Veh:	50.7	0.0	50.7	31.0	0.0	36.8	47.4	17.0	17.0	0.0	36.0	36.0
User DelAdj:	1.00	1.00	1.00	1.00	1.00	1.00	1.00	1.00	1.00	1.00	1.00	1.00
AdjDel/Veh:	50.7	0.0	50.7	31.0	0.0	36.8	47.4	17.0	17.0	0.0	36.0	36.0
LOS by Move:	D	A	D	C	A	D	D	B	B	A	D	D
HCM2k95thQ:	0	0	0	7	0	20	14	10	10	0	20	20

Note: Queue reported is the number of cars per lane.

BART Phase II Extension Project

Level Of Service Computation Report
2000 HCM Operations (Future Volume Alternative)
AM - 2025 Project Conditions

Intersection #3263: AUTUMN/JULIAN

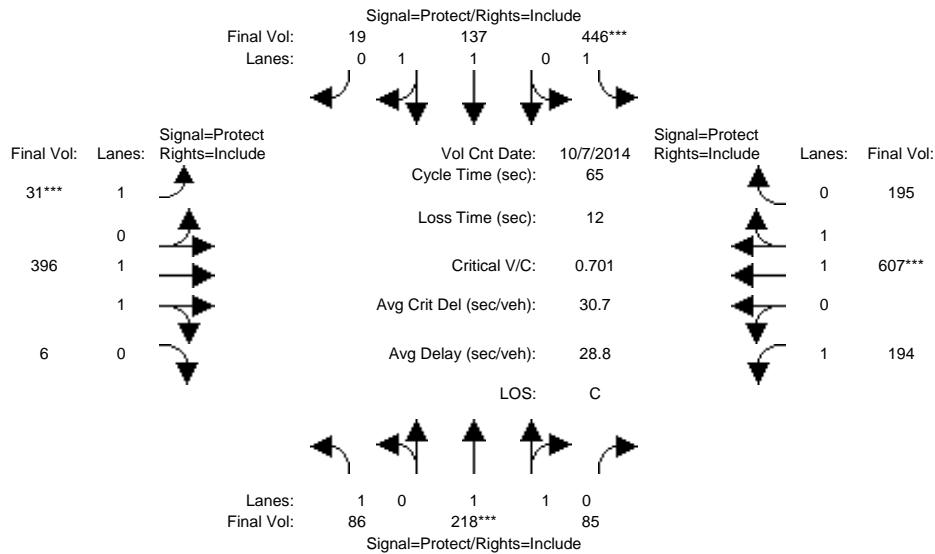

Approach:	North Bound			South Bound			East Bound			West Bound		
Movement:	L	T	R	L	T	R	L	T	R	L	T	R
Min. Green:	7	10	10	7	10	10	7	10	10	7	10	10
Y+R:	4.0	4.0	4.0	4.0	4.0	4.0	4.0	4.0	4.0	4.0	4.0	4.0
Volume Module: >> Count Date: 7 Oct 2014 <<												
Base Vol:	86	218	85	446	137	19	31	396	6	194	607	195
Growth Adj:	1.00	1.00	1.00	1.00	1.00	1.00	1.00	1.00	1.00	1.00	1.00	1.00
Initial Bse:	86	218	85	446	137	19	31	396	6	194	607	195
Added Vol:	0	0	0	0	0	0	0	0	0	0	0	0
PasserByVol:	0	0	0	0	0	0	0	0	0	0	0	0
Initial Fut:	86	218	85	446	137	19	31	396	6	194	607	195
User Adj:	1.00	1.00	1.00	1.00	1.00	1.00	1.00	1.00	1.00	1.00	1.00	1.00
PHF Adj:	1.00	1.00	1.00	1.00	1.00	1.00	1.00	1.00	1.00	1.00	1.00	1.00
PHF Volume:	86	218	85	446	137	19	31	396	6	194	607	195
Reduct Vol:	0	0	0	0	0	0	0	0	0	0	0	0
Reduced Vol:	86	218	85	446	137	19	31	396	6	194	607	195
PCE Adj:	1.00	1.00	1.00	1.00	1.00	1.00	1.00	1.00	1.00	1.00	1.00	1.00
MLF Adj:	1.00	1.00	1.00	1.00	1.00	1.00	1.00	1.00	1.00	1.00	1.00	1.00
Final Volume:	86	218	85	446	137	19	31	396	6	194	607	195
Saturation Flow Module:												
Sat/Lane:	1900	1900	1900	1900	1900	1900	1900	1900	1900	1900	1900	1900
Adjustment:	0.92	0.98	0.95	0.92	0.98	0.95	0.92	0.97	0.95	0.92	0.98	0.95
Lanes:	1.00	1.42	0.58	1.00	1.75	0.25	1.00	1.97	0.03	1.00	1.50	0.50
Final Sat.:	1750	2661	1038	1750	3249	451	1750	3645	55	1750	2800	899
Capacity Analysis Module:												
Vol/Sat:	0.05	0.08	0.08	0.25	0.04	0.04	0.02	0.11	0.11	0.11	0.22	0.22
Crit Moves:	****			****			****			****		
Green Time:	12.1	10.0	10.0	19.5	17.3	17.3	7.0	13.7	13.7	9.9	16.5	16.5
Volume/Cap:	0.26	0.53	0.53	0.85	0.16	0.16	0.16	0.52	0.52	0.73	0.85	0.85
Delay/Veh:	23.0	26.3	26.3	34.1	18.3	18.3	26.8	23.3	23.3	36.2	30.6	30.6
User DelAdj:	1.00	1.00	1.00	1.00	1.00	1.00	1.00	1.00	1.00	1.00	1.00	1.00
AdjDel/Veh:	23.0	26.3	26.3	34.1	18.3	18.3	26.8	23.3	23.3	36.2	30.6	30.6
LOS by Move:	C	C	C	C	B	B	C	C	C	D	C	C
HCM2k95thQ:	3	6	6	22	3	3	1	7	7	8	16	16

Note: Queue reported is the number of cars per lane.

BART Phase II Extension Project

Level Of Service Computation Report
2000 HCM Operations (Future Volume Alternative)
PM - 2025 Project Conditions

Intersection #3263: AUTUMN/JULIAN

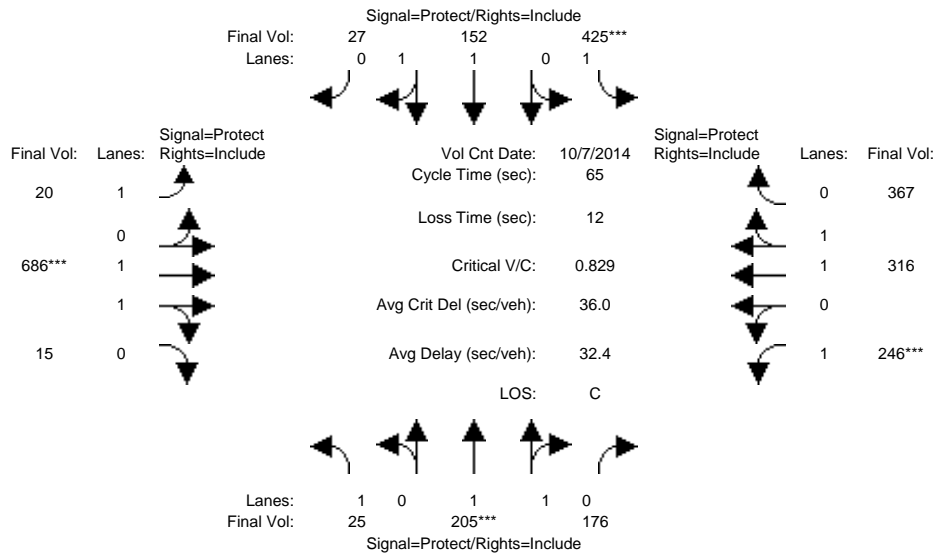

Approach:	North Bound			South Bound			East Bound			West Bound		
	L	T	R	L	T	R	L	T	R	L	T	R
Min. Green:	7	10	10	7	10	10	7	10	10	7	10	10
Y+R:	4.0	4.0	4.0	4.0	4.0	4.0	4.0	4.0	4.0	4.0	4.0	4.0
Volume Module: >> Count Date: 7 Oct 2014 <<												
Base Vol:	25	205	176	425	152	27	20	686	15	246	316	367
Growth Adj:	1.00	1.00	1.00	1.00	1.00	1.00	1.00	1.00	1.00	1.00	1.00	1.00
Initial Bse:	25	205	176	425	152	27	20	686	15	246	316	367
Added Vol:	0	0	0	0	0	0	0	0	0	0	0	0
PasserByVol:	0	0	0	0	0	0	0	0	0	0	0	0
Initial Fut:	25	205	176	425	152	27	20	686	15	246	316	367
User Adj:	1.00	1.00	1.00	1.00	1.00	1.00	1.00	1.00	1.00	1.00	1.00	1.00
PHF Adj:	1.00	1.00	1.00	1.00	1.00	1.00	1.00	1.00	1.00	1.00	1.00	1.00
PHF Volume:	25	205	176	425	152	27	20	686	15	246	316	367
Reduct Vol:	0	0	0	0	0	0	0	0	0	0	0	0
Reduced Vol:	25	205	176	425	152	27	20	686	15	246	316	367
PCE Adj:	1.00	1.00	1.00	1.00	1.00	1.00	1.00	1.00	1.00	1.00	1.00	1.00
MLF Adj:	1.00	1.00	1.00	1.00	1.00	1.00	1.00	1.00	1.00	1.00	1.00	1.00
Final Volume:	25	205	176	425	152	27	20	686	15	246	316	367
Saturation Flow Module:												
Sat/Lane:	1900	1900	1900	1900	1900	1900	1900	1900	1900	1900	1900	1900
Adjustment:	0.92	1.00	0.95	0.92	0.98	0.95	0.92	0.97	0.95	0.92	1.00	0.92
Lanes:	1.00	1.05	0.95	1.00	1.69	0.31	1.00	1.96	0.04	1.00	1.00	1.00
Final Sat.:	1750	1990	1708	1750	3141	558	1750	3621	79	1750	1900	1750
Capacity Analysis Module:												
Vol/Sat:	0.01	0.10	0.10	0.24	0.05	0.05	0.01	0.19	0.19	0.14	0.17	0.21
Crit Moves:	****			****			****			****		
Green Time:	11.6	10.0	10.0	18.2	16.6	16.6	8.4	14.2	14.2	10.6	16.4	16.4
Volume/Cap:	0.08	0.67	0.67	0.87	0.19	0.19	0.09	0.87	0.87	0.87	0.66	0.83
Delay/Veh:	22.3	29.0	29.0	37.2	19.0	19.0	25.1	34.2	34.2	49.8	23.4	30.3
User DelAdj:	1.00	1.00	1.00	1.00	1.00	1.00	1.00	1.00	1.00	1.00	1.00	1.00
AdjDel/Veh:	22.3	29.0	29.0	37.2	19.0	19.0	25.1	34.2	34.2	49.8	23.4	30.3
LOS by Move:	C	C	C	D	B	B	C	C	C	D	C	C
HCM2k95thQ:	1	8	8	22	3	3	1	15	15	12	11	16

Note: Queue reported is the number of cars per lane.

BART Phase II Extension Project

Level Of Service Computation Report
2000 HCM Operations (Future Volume Alternative)
AM - 2025 Project Conditions

Intersection #3264: AUTUMN/SAN FERNANDO

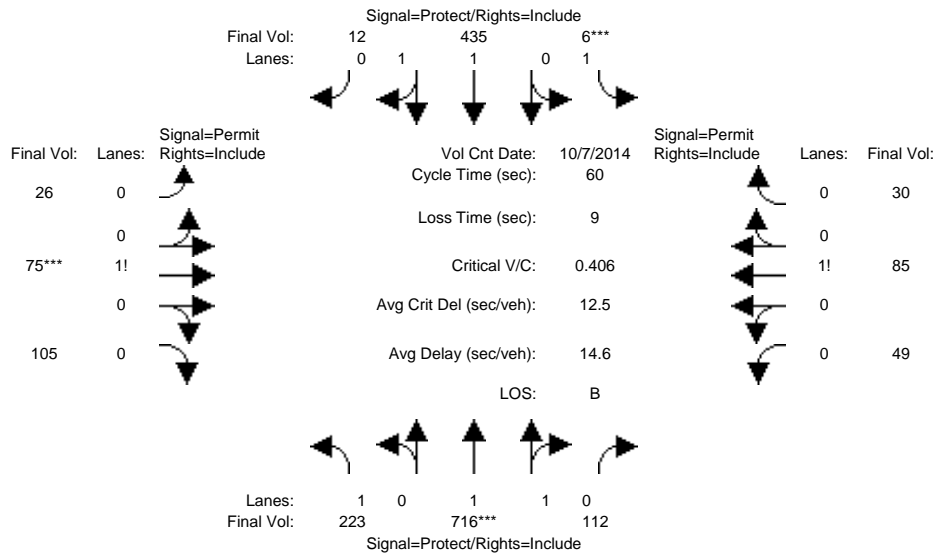

Approach:	North Bound			South Bound			East Bound			West Bound		
	L	T	R	L	T	R	L	T	R	L	T	R
Min. Green:	7	10	10	7	10	10	10	10	10	10	10	10
Y+R:	4.0	4.0	4.0	4.0	4.0	4.0	4.0	4.0	4.0	4.0	4.0	4.0
Volume Module: >> Count Date: 7 Oct 2014 <<												
Base Vol:	223	716	112	6	435	12	26	75	105	49	85	30
Growth Adj:	1.00	1.00	1.00	1.00	1.00	1.00	1.00	1.00	1.00	1.00	1.00	1.00
Initial Bse:	223	716	112	6	435	12	26	75	105	49	85	30
Added Vol:	0	0	0	0	0	0	0	0	0	0	0	0
PasserByVol:	0	0	0	0	0	0	0	0	0	0	0	0
Initial Fut:	223	716	112	6	435	12	26	75	105	49	85	30
User Adj:	1.00	1.00	1.00	1.00	1.00	1.00	1.00	1.00	1.00	1.00	1.00	1.00
PHF Adj:	1.00	1.00	1.00	1.00	1.00	1.00	1.00	1.00	1.00	1.00	1.00	1.00
PHF Volume:	223	716	112	6	435	12	26	75	105	49	85	30
Reduct Vol:	0	0	0	0	0	0	0	0	0	0	0	0
Reduced Vol:	223	716	112	6	435	12	26	75	105	49	85	30
PCE Adj:	1.00	1.00	1.00	1.00	1.00	1.00	1.00	1.00	1.00	1.00	1.00	1.00
MLF Adj:	1.00	1.00	1.00	1.00	1.00	1.00	1.00	1.00	1.00	1.00	1.00	1.00
FinalVolume:	223	716	112	6	435	12	26	75	105	49	85	30
Saturation Flow Module:												
Sat/Lane:	1900	1900	1900	1900	1900	1900	1900	1900	1900	1900	1900	1900
Adjustment:	0.92	0.98	0.95	0.92	0.97	0.95	0.92	0.92	0.92	0.92	0.92	0.92
Lanes:	1.00	1.72	0.28	1.00	1.94	0.06	0.13	0.36	0.51	0.30	0.52	0.18
Final Sat.:	1750	3199	500	1750	3601	99	221	637	892	523	907	320
Capacity Analysis Module:												
Vol/Sat:	0.13	0.22	0.22	0.00	0.12	0.12	0.12	0.12	0.12	0.09	0.09	0.09
Crit Moves:	****			****			****					
Green Time:	15.5	28.8	28.8	7.0	20.3	20.3	15.2	15.2	15.2	15.2	15.2	15.2
Volume/Cap:	0.49	0.47	0.47	0.03	0.36	0.36	0.47	0.47	0.47	0.37	0.37	0.37
Delay/Veh:	19.7	10.6	10.6	23.5	15.1	15.1	19.8	19.8	19.8	19.0	19.0	19.0
User DelAdj:	1.00	1.00	1.00	1.00	1.00	1.00	1.00	1.00	1.00	1.00	1.00	1.00
AdjDel/Veh:	19.7	10.6	10.6	23.5	15.1	15.1	19.8	19.8	19.8	19.0	19.0	19.0
LOS by Move:	B	B	B	C	B	B	B	B	B	B	B	B
HCM2k95thQ:	7	10	10	0	7	7	8	8	8	5	5	5

Note: Queue reported is the number of cars per lane.

BART Phase II Extension Project

Level Of Service Computation Report
2000 HCM Operations (Future Volume Alternative)
PM - 2025 Project Conditions

Intersection #3264: AUTUMN/SAN FERNANDO

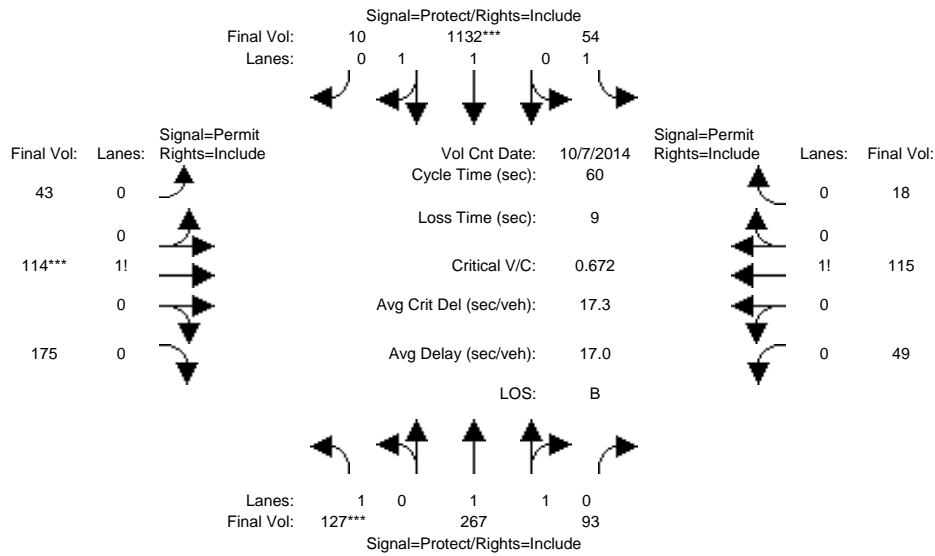

Approach:	North Bound			South Bound			East Bound			West Bound		
	L	T	R	L	T	R	L	T	R	L	T	R
Min. Green:	7	10	10	7	10	10	10	10	10	10	10	10
Y+R:	4.0	4.0	4.0	4.0	4.0	4.0	4.0	4.0	4.0	4.0	4.0	4.0
Volume Module: >> Count Date: 7 Oct 2014 <<												
Base Vol:	127	267	93	54	1132	10	43	114	175	49	115	18
Growth Adj:	1.00	1.00	1.00	1.00	1.00	1.00	1.00	1.00	1.00	1.00	1.00	1.00
Initial Bse:	127	267	93	54	1132	10	43	114	175	49	115	18
Added Vol:	0	0	0	0	0	0	0	0	0	0	0	0
PasserByVol:	0	0	0	0	0	0	0	0	0	0	0	0
Initial Fut:	127	267	93	54	1132	10	43	114	175	49	115	18
User Adj:	1.00	1.00	1.00	1.00	1.00	1.00	1.00	1.00	1.00	1.00	1.00	1.00
PHF Adj:	1.00	1.00	1.00	1.00	1.00	1.00	1.00	1.00	1.00	1.00	1.00	1.00
PHF Volume:	127	267	93	54	1132	10	43	114	175	49	115	18
Reduct Vol:	0	0	0	0	0	0	0	0	0	0	0	0
Reduced Vol:	127	267	93	54	1132	10	43	114	175	49	115	18
PCE Adj:	1.00	1.00	1.00	1.00	1.00	1.00	1.00	1.00	1.00	1.00	1.00	1.00
MLF Adj:	1.00	1.00	1.00	1.00	1.00	1.00	1.00	1.00	1.00	1.00	1.00	1.00
FinalVolume:	127	267	93	54	1132	10	43	114	175	49	115	18
Saturation Flow Module:												
Sat/Lane:	1900	1900	1900	1900	1900	1900	1900	1900	1900	1900	1900	1900
Adjustment:	0.92	0.98	0.95	0.92	0.97	0.95	0.92	0.92	0.92	0.92	0.92	0.92
Lanes:	1.00	1.47	0.53	1.00	1.98	0.02	0.13	0.34	0.53	0.27	0.63	0.10
Final Sat.:	1750	2743	956	1750	3668	32	227	601	922	471	1106	173
Capacity Analysis Module:												
Vol/Sat:	0.07	0.10	0.10	0.03	0.31	0.31	0.19	0.19	0.19	0.10	0.10	0.10
Crit Moves:	****			****			****					
Green Time:	7.0	20.1	20.1	14.1	27.3	27.3	16.7	16.7	16.7	16.7	16.7	16.7
Volume/Cap:	0.62	0.29	0.29	0.13	0.68	0.68	0.68	0.68	0.68	0.37	0.37	0.37
Delay/Veh:	31.1	14.8	14.8	18.3	14.1	14.1	23.1	23.1	23.1	17.9	17.9	17.9
User DelAdj:	1.00	1.00	1.00	1.00	1.00	1.00	1.00	1.00	1.00	1.00	1.00	1.00
AdjDel/Veh:	31.1	14.8	14.8	18.3	14.1	14.1	23.1	23.1	23.1	17.9	17.9	17.9
LOS by Move:	C	B	B	B	B	B	C	C	C	B	B	B
HCM2k95thQ:	5	5	5	2	18	18	14	14	14	6	6	6

Note: Queue reported is the number of cars per lane.

BART Phase II Extension Project

Level Of Service Computation Report
2000 HCM Operations (Future Volume Alternative)
AM - 2025 Project Conditions

Intersection #3266: AUZERAIS/BIRD

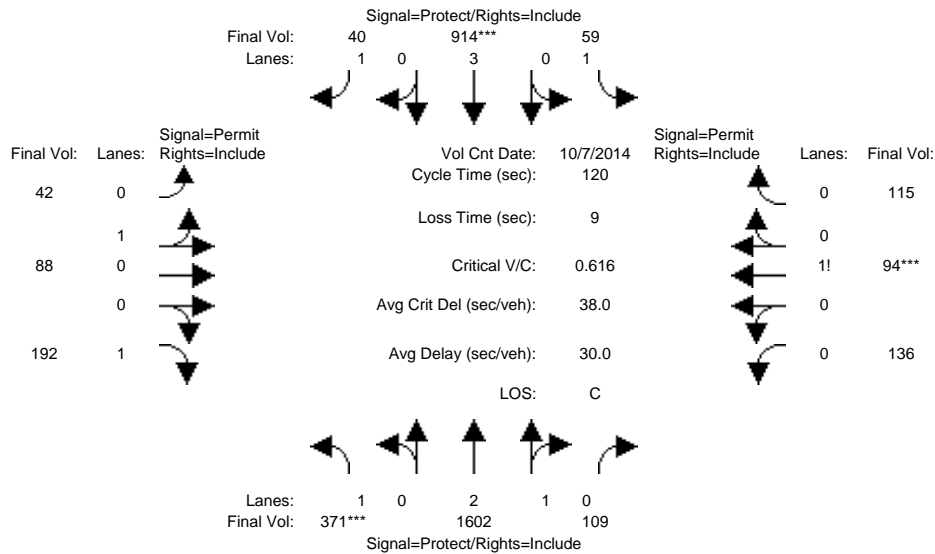

Approach:	North Bound			South Bound			East Bound			West Bound		
Movement:	L	T	R	L	T	R	L	T	R	L	T	R
Min. Green:	7	10	10	7	10	10	10	10	10	10	10	10
Y+R:	4.0	4.0	4.0	4.0	4.0	4.0	4.0	4.0	4.0	4.0	4.0	4.0
Volume Module: >> Count Date: 7 Oct 2014 <<												
Base Vol:	371	1602	109	59	914	40	42	88	192	136	94	115
Growth Adj:	1.00	1.00	1.00	1.00	1.00	1.00	1.00	1.00	1.00	1.00	1.00	1.00
Initial Bse:	371	1602	109	59	914	40	42	88	192	136	94	115
Added Vol:	0	0	0	0	0	0	0	0	0	0	0	0
PasserByVol:	0	0	0	0	0	0	0	0	0	0	0	0
Initial Fut:	371	1602	109	59	914	40	42	88	192	136	94	115
User Adj:	1.00	1.00	1.00	1.00	1.00	1.00	1.00	1.00	1.00	1.00	1.00	1.00
PHF Adj:	1.00	1.00	1.00	1.00	1.00	1.00	1.00	1.00	1.00	1.00	1.00	1.00
PHF Volume:	371	1602	109	59	914	40	42	88	192	136	94	115
Reduct Vol:	0	0	0	0	0	0	0	0	0	0	0	0
Reduced Vol:	371	1602	109	59	914	40	42	88	192	136	94	115
PCE Adj:	1.00	1.00	1.00	1.00	1.00	1.00	1.00	1.00	1.00	1.00	1.00	1.00
MLF Adj:	1.00	1.00	1.00	1.00	1.00	1.00	1.00	1.00	1.00	1.00	1.00	1.00
Final Volume:	371	1602	109	59	914	40	42	88	192	136	94	115
Saturation Flow Module:												
Sat/Lane:	1900	1900	1900	1900	1900	1900	1900	1900	1900	1900	1900	1900
Adjustment:	0.92	0.98	0.95	0.92	1.00	0.92	0.95	0.95	0.92	0.92	0.92	0.92
Lanes:	1.00	2.80	0.20	1.00	3.00	1.00	0.32	0.68	1.00	0.40	0.27	0.33
Final Sat.:	1750	5243	357	1750	5700	1750	582	1218	1750	690	477	583
Capacity Analysis Module:												
Vol/Sat:	0.21	0.31	0.31	0.03	0.16	0.02	0.07	0.07	0.11	0.20	0.20	0.20
Crit Moves:	****				****						****	
Green Time:	41.3	60.9	60.9	11.6	31.3	31.3	38.4	38.4	38.4	38.4	38.4	38.4
Volume/Cap:	0.62	0.60	0.60	0.35	0.62	0.09	0.23	0.23	0.34	0.62	0.62	0.62
Delay/Veh:	34.6	21.3	21.3	51.9	39.9	33.7	30.1	30.1	31.5	36.6	36.6	36.6
User DelAdj:	1.00	1.00	1.00	1.00	1.00	1.00	1.00	1.00	1.00	1.00	1.00	1.00
AdjDel/Veh:	34.6	21.3	21.3	51.9	39.9	33.7	30.1	30.1	31.5	36.6	36.6	36.6
LOS by Move:	C	C	C	D	D	C	C	C	C	D	D	D
HCM2k95thQ:	22	26	26	4	18	2	7	7	11	21	21	21

Note: Queue reported is the number of cars per lane.

BART Phase II Extension Project

Level Of Service Computation Report
2000 HCM Operations (Future Volume Alternative)
PM - 2025 Project Conditions

Intersection #3266: AUZERAIS/BIRD

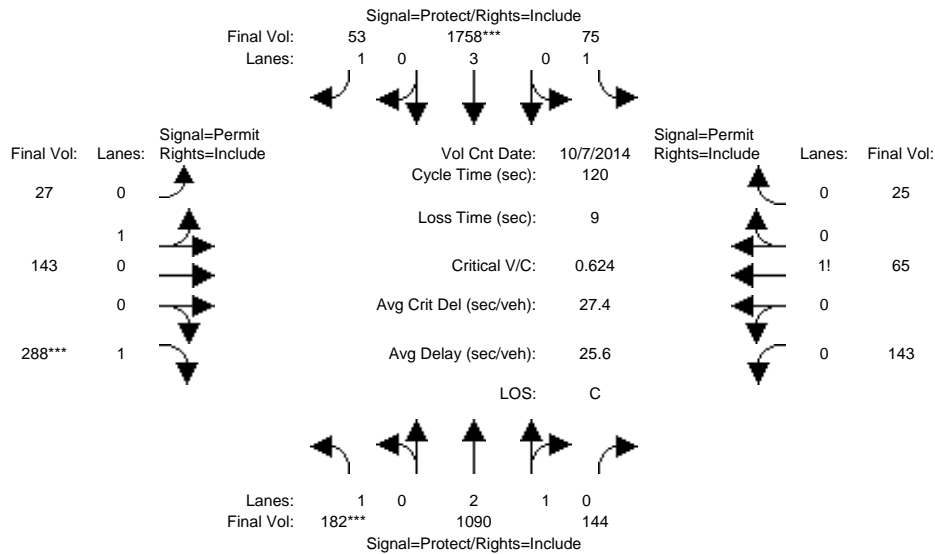

Approach:	North Bound			South Bound			East Bound			West Bound		
	L	T	R	L	T	R	L	T	R	L	T	R
Min. Green:	7	10	10	7	10	10	10	10	10	10	10	10
Y+R:	4.0	4.0	4.0	4.0	4.0	4.0	4.0	4.0	4.0	4.0	4.0	4.0
Volume Module: >> Count Date: 7 Oct 2014 <<												
Base Vol:	182	1090	144	75	1758	53	27	143	288	143	65	25
Growth Adj:	1.00	1.00	1.00	1.00	1.00	1.00	1.00	1.00	1.00	1.00	1.00	1.00
Initial Bse:	182	1090	144	75	1758	53	27	143	288	143	65	25
Added Vol:	0	0	0	0	0	0	0	0	0	0	0	0
PasserByVol:	0	0	0	0	0	0	0	0	0	0	0	0
Initial Fut:	182	1090	144	75	1758	53	27	143	288	143	65	25
User Adj:	1.00	1.00	1.00	1.00	1.00	1.00	1.00	1.00	1.00	1.00	1.00	1.00
PHF Adj:	1.00	1.00	1.00	1.00	1.00	1.00	1.00	1.00	1.00	1.00	1.00	1.00
PHF Volume:	182	1090	144	75	1758	53	27	143	288	143	65	25
Reduct Vol:	0	0	0	0	0	0	0	0	0	0	0	0
Reduced Vol:	182	1090	144	75	1758	53	27	143	288	143	65	25
PCE Adj:	1.00	1.00	1.00	1.00	1.00	1.00	1.00	1.00	1.00	1.00	1.00	1.00
MLF Adj:	1.00	1.00	1.00	1.00	1.00	1.00	1.00	1.00	1.00	1.00	1.00	1.00
Final Volume:	182	1090	144	75	1758	53	27	143	288	143	65	25
Saturation Flow Module:												
Sat/Lane:	1900	1900	1900	1900	1900	1900	1900	1900	1900	1900	1900	1900
Adjustment:	0.92	0.99	0.95	0.92	1.00	0.92	0.95	0.95	0.92	0.92	0.92	0.92
Lanes:	1.00	2.64	0.36	1.00	3.00	1.00	0.16	0.84	1.00	0.61	0.28	0.11
Final Sat.:	1750	4946	653	1750	5700	1750	286	1514	1750	1074	488	188
Capacity Analysis Module:												
Vol/Sat:	0.10	0.22	0.22	0.04	0.31	0.03	0.09	0.09	0.16	0.13	0.13	0.13
Crit Moves:	****				****				****			
Green Time:	20.0	62.7	62.7	16.6	59.3	59.3	31.7	31.7	31.7	31.7	31.7	31.7
Volume/Cap:	0.62	0.42	0.42	0.31	0.62	0.06	0.36	0.36	0.62	0.50	0.50	0.50
Delay/Veh:	50.7	17.6	17.6	47.3	22.6	15.8	36.4	36.4	41.6	38.4	38.4	38.4
User DelAdj:	1.00	1.00	1.00	1.00	1.00	1.00	1.00	1.00	1.00	1.00	1.00	1.00
AdjDel/Veh:	50.7	17.6	17.6	47.3	22.6	15.8	36.4	36.4	41.6	38.4	38.4	38.4
LOS by Move:	D	B	B	D	C	B	D	D	D	D	D	D
HCM2k95thQ:	13	17	17	5	27	2	10	10	19	15	15	15

Note: Queue reported is the number of cars per lane.

BART Phase II Extension Project

Level Of Service Computation Report
 2000 HCM Operations (Future Volume Alternative)
 AM - 2025 Project Conditions

Intersection #3363: CAHILL/SANTA CLARA

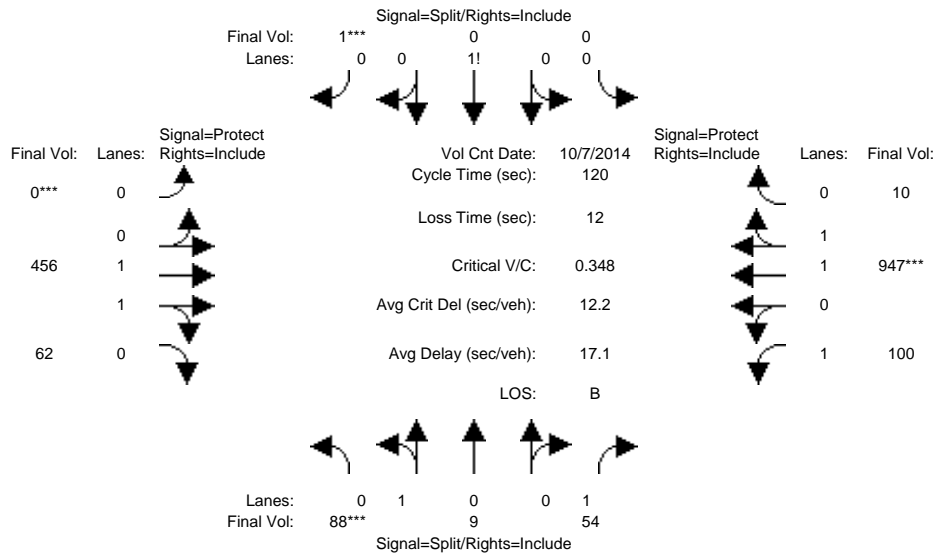

Approach:	North Bound			South Bound			East Bound			West Bound		
	L	T	R	L	T	R	L	T	R	L	T	R
Min. Green:	10	10	10	10	10	10	7	10	10	7	10	10
Y+R:	4.0	4.0	4.0	4.0	4.0	4.0	4.0	4.0	4.0	4.0	4.0	4.0
Volume Module: >> Count Date: 7 Oct 2014 <<												
Base Vol:	88	9	54	0	0	1	0	456	62	100	947	10
Growth Adj:	1.00	1.00	1.00	1.00	1.00	1.00	1.00	1.00	1.00	1.00	1.00	1.00
Initial Bse:	88	9	54	0	0	1	0	456	62	100	947	10
Added Vol:	0	0	0	0	0	0	0	0	0	0	0	0
PasserByVol:	0	0	0	0	0	0	0	0	0	0	0	0
Initial Fut:	88	9	54	0	0	1	0	456	62	100	947	10
User Adj:	1.00	1.00	1.00	1.00	1.00	1.00	1.00	1.00	1.00	1.00	1.00	1.00
PHF Adj:	1.00	1.00	1.00	1.00	1.00	1.00	1.00	1.00	1.00	1.00	1.00	1.00
PHF Volume:	88	9	54	0	0	1	0	456	62	100	947	10
Reduct Vol:	0	0	0	0	0	0	0	0	0	0	0	0
Reduced Vol:	88	9	54	0	0	1	0	456	62	100	947	10
PCE Adj:	1.00	1.00	1.00	1.00	1.00	1.00	1.00	1.00	1.00	1.00	1.00	1.00
MLF Adj:	1.00	1.00	1.00	1.00	1.00	1.00	1.00	1.00	1.00	1.00	1.00	1.00
FinalVolume:	88	9	54	0	0	1	0	456	62	100	947	10
Saturation Flow Module:												
Sat/Lane:	1900	1900	1900	1900	1900	1900	1900	1900	1900	1900	1900	1900
Adjustment:	0.95	0.95	0.92	0.92	1.00	0.92	0.92	0.98	0.95	0.92	0.97	0.95
Lanes:	0.91	0.09	1.00	0.00	0.00	1.00	0.00	1.75	0.25	1.00	1.98	0.02
Final Sat.:	1633	167	1750	0	0	1750	0	3257	443	1750	3661	39
Capacity Analysis Module:												
Vol/Sat:	0.05	0.05	0.03	0.00	0.00	0.00	0.00	0.14	0.14	0.06	0.26	0.26
Crit Moves:	****					****	****				****	
Green Time:	16.9	16.9	16.9	0.0	0.0	10.0	0.0	57.3	57.3	23.9	81.1	81.1
Volume/Cap:	0.38	0.38	0.22	0.00	0.00	0.01	0.00	0.29	0.29	0.29	0.38	0.38
Delay/Veh:	47.8	47.8	46.2	0.0	0.0	50.5	0.0	19.2	19.2	41.3	8.6	8.6
User DelAdj:	1.00	1.00	1.00	1.00	1.00	1.00	1.00	1.00	1.00	1.00	1.00	1.00
AdjDel/Veh:	47.8	47.8	46.2	0.0	0.0	50.5	0.0	19.2	19.2	41.3	8.6	8.6
LOS by Move:	D	D	D	A	A	D	A	B	B	D	A	A
HCM2k95thQ:	7	7	4	0	0	0	0	11	11	7	15	15

Note: Queue reported is the number of cars per lane.

BART Phase II Extension Project

Level Of Service Computation Report
2000 HCM Operations (Future Volume Alternative)
PM - 2025 Project Conditions

Intersection #3363: CAHILL/SANTA CLARA

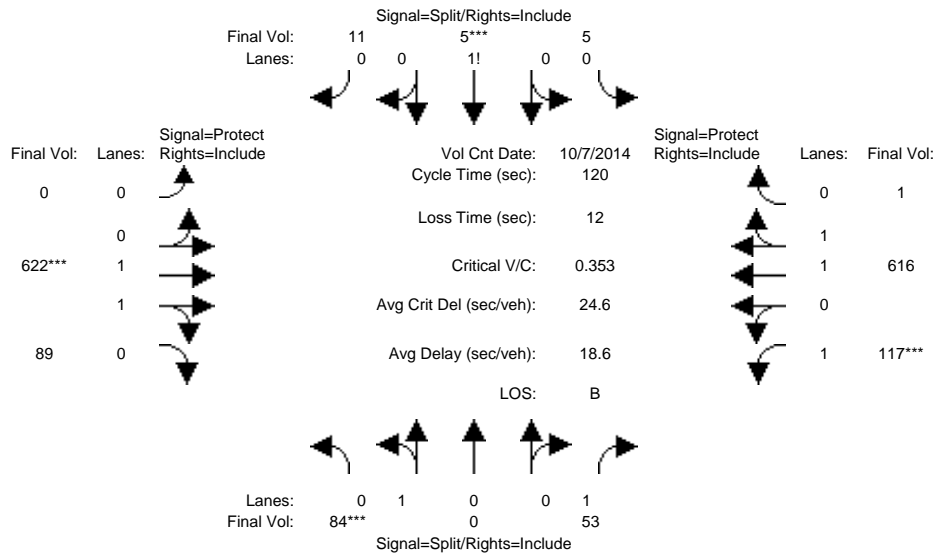

Approach:	North Bound			South Bound			East Bound			West Bound		
	L	T	R	L	T	R	L	T	R	L	T	R
Min. Green:	10	10	10	10	10	10	7	10	10	7	10	10
Y+R:	4.0	4.0	4.0	4.0	4.0	4.0	4.0	4.0	4.0	4.0	4.0	4.0
Volume Module: >> Count Date: 7 Oct 2014 <<												
Base Vol:	84	0	53	5	5	11	0	622	89	117	616	1
Growth Adj:	1.00	1.00	1.00	1.00	1.00	1.00	1.00	1.00	1.00	1.00	1.00	1.00
Initial Bse:	84	0	53	5	5	11	0	622	89	117	616	1
Added Vol:	0	0	0	0	0	0	0	0	0	0	0	0
PasserByVol:	0	0	0	0	0	0	0	0	0	0	0	0
Initial Fut:	84	0	53	5	5	11	0	622	89	117	616	1
User Adj:	1.00	1.00	1.00	1.00	1.00	1.00	1.00	1.00	1.00	1.00	1.00	1.00
PHF Adj:	1.00	1.00	1.00	1.00	1.00	1.00	1.00	1.00	1.00	1.00	1.00	1.00
PHF Volume:	84	0	53	5	5	11	0	622	89	117	616	1
Reduct Vol:	0	0	0	0	0	0	0	0	0	0	0	0
Reduced Vol:	84	0	53	5	5	11	0	622	89	117	616	1
PCE Adj:	1.00	1.00	1.00	1.00	1.00	1.00	1.00	1.00	1.00	1.00	1.00	1.00
MLF Adj:	1.00	1.00	1.00	1.00	1.00	1.00	1.00	1.00	1.00	1.00	1.00	1.00
FinalVolume:	84	0	53	5	5	11	0	622	89	117	616	1
Saturation Flow Module:												
Sat/Lane:	1900	1900	1900	1900	1900	1900	1900	1900	1900	1900	1900	1900
Adjustment:	0.95	0.95	0.92	0.92	0.92	0.92	0.92	0.98	0.95	0.92	0.97	0.95
Lanes:	1.00	0.00	1.00	0.24	0.24	0.52	0.00	1.74	0.26	1.00	1.99	0.01
Final Sat.:	1800	0	1750	417	417	917	0	3237	463	1750	3694	6
Capacity Analysis Module:												
Vol/Sat:	0.05	0.00	0.03	0.01	0.01	0.01	0.00	0.19	0.19	0.07	0.17	0.17
Crit Moves:	****			****			****			****		
Green Time:	15.0	0.0	15.0	10.0	10.0	10.0	0.0	61.6	61.6	21.4	83.0	83.0
Volume/Cap:	0.37	0.00	0.24	0.14	0.14	0.14	0.00	0.37	0.37	0.37	0.24	0.24
Delay/Veh:	49.3	0.0	48.0	51.5	51.5	51.5	0.0	17.7	17.7	44.1	6.9	6.9
User DelAdj:	1.00	1.00	1.00	1.00	1.00	1.00	1.00	1.00	1.00	1.00	1.00	1.00
AdjDel/Veh:	49.3	0.0	48.0	51.5	51.5	51.5	0.0	17.7	17.7	44.1	6.9	6.9
LOS by Move:	D	A	D	D	D	D	A	B	B	D	A	A
HCM2k95thQ:	7	0	4	2	2	2	0	15	15	8	8	8

Note: Queue reported is the number of cars per lane.

BART Phase II Extension Project

Level Of Service Computation Report
2000 HCM Operations (Future Volume Alternative)
AM - 2025 Project Conditions

Intersection #3445: DELMAS/PARK *

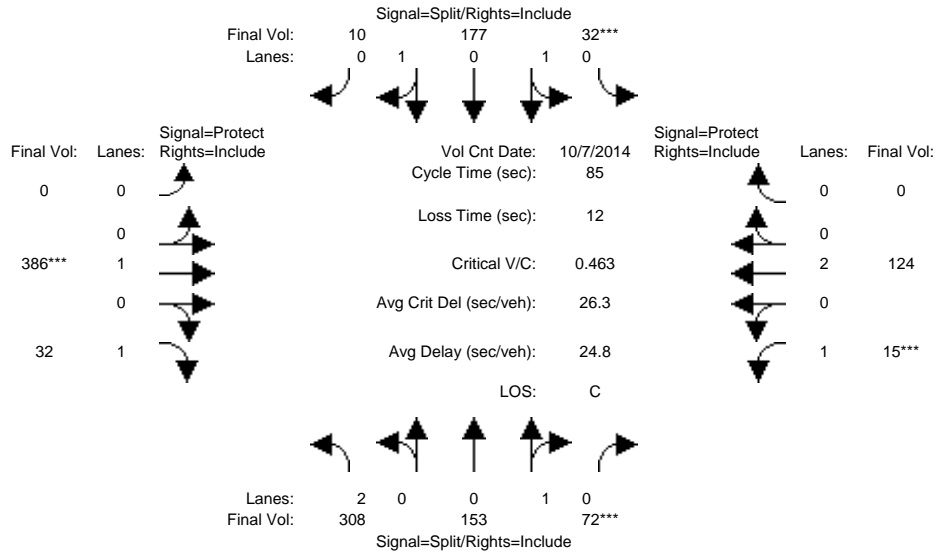

Approach:	North Bound			South Bound			East Bound			West Bound		
Movement:	L	T	R	L	T	R	L	T	R	L	T	R
Min. Green:	10	10	10	10	10	10	0	10	10	7	10	0
Y+R:	4.0	4.0	4.0	4.0	4.0	4.0	4.0	4.0	4.0	4.0	4.0	4.0
Volume Module: >> Count Date: 7 Oct 2014 <<												
Base Vol:	308	153	72	32	177	10	0	386	32	15	124	0
Growth Adj:	1.00	1.00	1.00	1.00	1.00	1.00	1.00	1.00	1.00	1.00	1.00	1.00
Initial Bse:	308	153	72	32	177	10	0	386	32	15	124	0
Added Vol:	0	0	0	0	0	0	0	0	0	0	0	0
PasserByVol:	0	0	0	0	0	0	0	0	0	0	0	0
Initial Fut:	308	153	72	32	177	10	0	386	32	15	124	0
User Adj:	1.00	1.00	1.00	1.00	1.00	1.00	1.00	1.00	1.00	1.00	1.00	1.00
PHF Adj:	1.00	1.00	1.00	1.00	1.00	1.00	1.00	1.00	1.00	1.00	1.00	1.00
PHF Volume:	308	153	72	32	177	10	0	386	32	15	124	0
Reduct Vol:	0	0	0	0	0	0	0	0	0	0	0	0
Reduced Vol:	308	153	72	32	177	10	0	386	32	15	124	0
PCE Adj:	1.00	1.00	1.00	1.00	1.00	1.00	1.00	1.00	1.00	1.00	1.00	1.00
MLF Adj:	1.00	1.00	1.00	1.00	1.00	1.00	1.00	1.00	1.00	1.00	1.00	1.00
FinalVolume:	308	153	72	32	177	10	0	386	32	15	124	0
Saturation Flow Module:												
Sat/Lane:	1900	1900	1900	1900	1900	1900	1900	1900	1900	1900	1900	1900
Adjustment:	0.83	0.95	0.95	0.95	0.95	0.95	0.92	1.00	0.92	0.92	1.00	0.92
Lanes:	2.00	0.68	0.32	0.29	1.62	0.09	0.00	1.00	1.00	1.00	2.00	0.00
Final Sat.:	3150	1224	576	526	2910	164	0	1900	1750	1750	3800	0
Capacity Analysis Module:												
Vol/Sat:	0.10	0.13	0.13	0.06	0.06	0.06	0.00	0.20	0.02	0.01	0.03	0.00
Crit Moves:			****	****				****		****		
Green Time:	21.2	21.2	21.2	10.3	10.3	10.3	0.0	34.5	34.5	7.0	41.5	0.0
Volume/Cap:	0.39	0.50	0.50	0.50	0.50	0.50	0.00	0.50	0.05	0.10	0.07	0.00
Delay/Veh:	26.9	28.2	28.2	35.8	35.8	35.8	0.0	19.4	15.3	36.4	11.5	0.0
User DelAdj:	1.00	1.00	1.00	1.00	1.00	1.00	1.00	1.00	1.00	1.00	1.00	1.00
AdjDel/Veh:	26.9	28.2	28.2	35.8	35.8	35.8	0.0	19.4	15.3	36.4	11.5	0.0
LOS by Move:	C	C	C	D	D	D	A	B	B	D	B	A
HCM2k95thQ:	8	11	11	6	6	6	0	14	1	1	2	0

Note: Queue reported is the number of cars per lane.

BART Phase II Extension Project

Level Of Service Computation Report
2000 HCM Operations (Future Volume Alternative)
PM - 2025 Project Conditions

Intersection #3445: DELMAS/PARK *

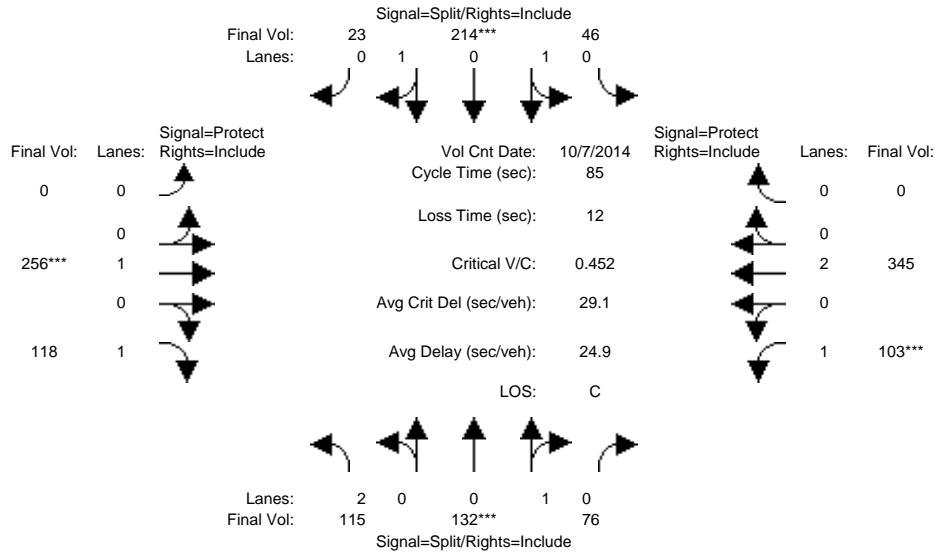

Approach:	North Bound			South Bound			East Bound			West Bound		
	L	T	R	L	T	R	L	T	R	L	T	R
Min. Green:	10	10	10	10	10	10	0	10	10	7	10	0
Y+R:	4.0	4.0	4.0	4.0	4.0	4.0	4.0	4.0	4.0	4.0	4.0	4.0
Volume Module: >> Count Date: 7 Oct 2014 <<												
Base Vol:	115	132	76	46	214	23	0	256	118	103	345	0
Growth Adj:	1.00	1.00	1.00	1.00	1.00	1.00	1.00	1.00	1.00	1.00	1.00	1.00
Initial Bse:	115	132	76	46	214	23	0	256	118	103	345	0
Added Vol:	0	0	0	0	0	0	0	0	0	0	0	0
PasserByVol:	0	0	0	0	0	0	0	0	0	0	0	0
Initial Fut:	115	132	76	46	214	23	0	256	118	103	345	0
User Adj:	1.00	1.00	1.00	1.00	1.00	1.00	1.00	1.00	1.00	1.00	1.00	1.00
PHF Adj:	1.00	1.00	1.00	1.00	1.00	1.00	1.00	1.00	1.00	1.00	1.00	1.00
PHF Volume:	115	132	76	46	214	23	0	256	118	103	345	0
Reduct Vol:	0	0	0	0	0	0	0	0	0	0	0	0
Reduced Vol:	115	132	76	46	214	23	0	256	118	103	345	0
PCE Adj:	1.00	1.00	1.00	1.00	1.00	1.00	1.00	1.00	1.00	1.00	1.00	1.00
MLF Adj:	1.00	1.00	1.00	1.00	1.00	1.00	1.00	1.00	1.00	1.00	1.00	1.00
FinalVolume:	115	132	76	46	214	23	0	256	118	103	345	0
Saturation Flow Module:												
Sat/Lane:	1900	1900	1900	1900	1900	1900	1900	1900	1900	1900	1900	1900
Adjustment:	0.83	0.95	0.95	0.95	0.95	0.95	0.92	1.00	0.92	0.92	1.00	0.92
Lanes:	2.00	0.63	0.37	0.33	1.51	0.16	0.00	1.00	1.00	1.00	2.00	0.00
Final Sat.:	3150	1142	658	585	2722	293	0	1900	1750	1750	3800	0
Capacity Analysis Module:												
Vol/Sat:	0.04	0.12	0.12	0.08	0.08	0.08	0.00	0.13	0.07	0.06	0.09	0.00
Crit Moves:	****			****			****			****		
Green Time:	21.8	21.8	21.8	14.8	14.8	14.8	0.0	25.4	25.4	11.1	36.4	0.0
Volume/Cap:	0.14	0.45	0.45	0.45	0.45	0.45	0.00	0.45	0.23	0.45	0.21	0.00
Delay/Veh:	24.5	27.3	27.3	32.0	32.0	32.0	0.0	24.8	22.7	35.6	15.3	0.0
User DelAdj:	1.00	1.00	1.00	1.00	1.00	1.00	1.00	1.00	1.00	1.00	1.00	1.00
AdjDel/Veh:	24.5	27.3	27.3	32.0	32.0	32.0	0.0	24.8	22.7	35.6	15.3	0.0
LOS by Move:	C	C	C	C	C	C	A	C	C	D	B	A
HCM2k95thQ:	3	10	10	7	7	7	0	10	5	5	5	0

Note: Queue reported is the number of cars per lane.

BART Phase II Extension Project

Level Of Service Computation Report
2000 HCM Operations (Future Volume Alternative)
AM - 2025 Project Conditions

Intersection #3552: FRUITDALE/MERIDIAN

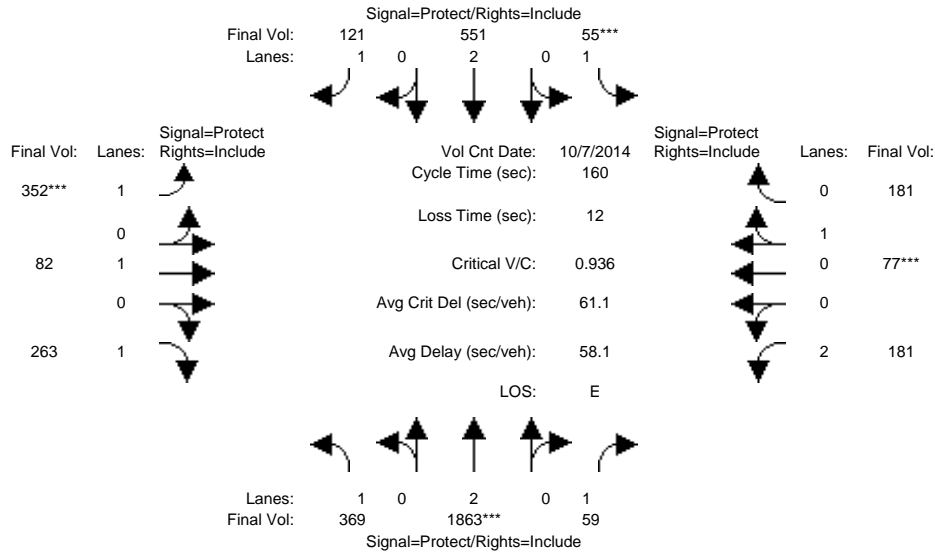

Approach:	North Bound			South Bound			East Bound			West Bound		
	L	T	R	L	T	R	L	T	R	L	T	R
Min. Green:	7	10	10	7	10	10	7	10	10	7	10	10
Y+R:	4.0	4.0	4.0	4.0	4.0	4.0	4.0	4.0	4.0	4.0	4.0	4.0
Volume Module: >> Count Date: 7 Oct 2014 <<												
Base Vol:	369	1863	59	55	551	121	352	82	263	181	77	181
Growth Adj:	1.00	1.00	1.00	1.00	1.00	1.00	1.00	1.00	1.00	1.00	1.00	1.00
Initial Bse:	369	1863	59	55	551	121	352	82	263	181	77	181
Added Vol:	0	0	0	0	0	0	0	0	0	0	0	0
PasserByVol:	0	0	0	0	0	0	0	0	0	0	0	0
Initial Fut:	369	1863	59	55	551	121	352	82	263	181	77	181
User Adj:	1.00	1.00	1.00	1.00	1.00	1.00	1.00	1.00	1.00	1.00	1.00	1.00
PHF Adj:	1.00	1.00	1.00	1.00	1.00	1.00	1.00	1.00	1.00	1.00	1.00	1.00
PHF Volume:	369	1863	59	55	551	121	352	82	263	181	77	181
Reduct Vol:	0	0	0	0	0	0	0	0	0	0	0	0
Reduced Vol:	369	1863	59	55	551	121	352	82	263	181	77	181
PCE Adj:	1.00	1.00	1.00	1.00	1.00	1.00	1.00	1.00	1.00	1.00	1.00	1.00
MLF Adj:	1.00	1.00	1.00	1.00	1.00	1.00	1.00	1.00	1.00	1.00	1.00	1.00
FinalVolume:	369	1863	59	55	551	121	352	82	263	181	77	181
Saturation Flow Module:												
Sat/Lane:	1900	1900	1900	1900	1900	1900	1900	1900	1900	1900	1900	1900
Adjustment:	0.92	1.00	0.92	0.92	1.00	0.92	0.92	1.00	0.92	0.83	0.95	0.95
Lanes:	1.00	2.00	1.00	1.00	2.00	1.00	1.00	1.00	1.00	2.00	0.30	0.70
Final Sat.:	1750	3800	1750	1750	3800	1750	1750	1900	1750	3150	537	1263
Capacity Analysis Module:												
Vol/Sat:	0.21	0.49	0.03	0.03	0.15	0.07	0.20	0.04	0.15	0.06	0.14	0.14
Crit Moves:	****			****			****			****		
Green Time:	53.2	82.8	82.8	7.0	36.6	36.6	34.0	42.1	42.1	16.1	24.2	24.2
Volume/Cap:	0.63	0.95	0.07	0.72	0.63	0.30	0.95	0.16	0.57	0.57	0.95	0.95
Delay/Veh:	47.4	47.0	19.3	103.3	57.2	51.6	95.3	45.6	52.9	71.2	108	107.5
User DelAdj:	1.00	1.00	1.00	1.00	1.00	1.00	1.00	1.00	1.00	1.00	1.00	1.00
AdjDel/Veh:	47.4	47.0	19.3	103.3	57.2	51.6	95.3	45.6	52.9	71.2	108	107.5
LOS by Move:	D	D	B	F	E	D	F	D	D	E	F	F
HCM2k95thQ:	29	73	3	6	22	10	35	6	21	11	29	29

Note: Queue reported is the number of cars per lane.

BART Phase II Extension Project

Level Of Service Computation Report
2000 HCM Operations (Future Volume Alternative)
PM - 2025 Project Conditions

Intersection #3552: FRUITDALE/MERIDIAN

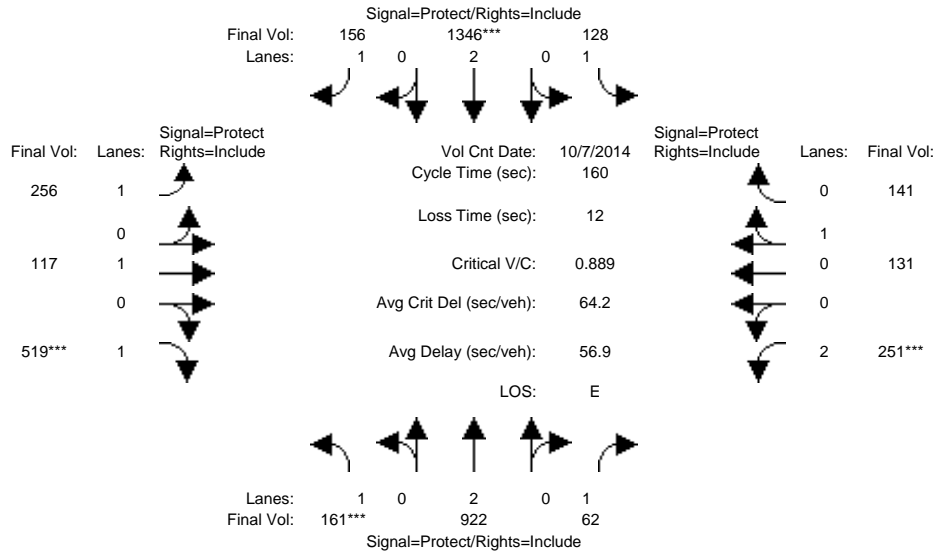

Approach:	North Bound			South Bound			East Bound			West Bound		
Movement:	L	T	R	L	T	R	L	T	R	L	T	R
Min. Green:	7	10	10	7	10	10	7	10	10	7	10	10
Y+R:	4.0	4.0	4.0	4.0	4.0	4.0	4.0	4.0	4.0	4.0	4.0	4.0
Volume Module: >> Count Date: 7 Oct 2014 <<												
Base Vol:	161	922	62	128	1346	156	256	117	519	251	131	141
Growth Adj:	1.00	1.00	1.00	1.00	1.00	1.00	1.00	1.00	1.00	1.00	1.00	1.00
Initial Bse:	161	922	62	128	1346	156	256	117	519	251	131	141
Added Vol:	0	0	0	0	0	0	0	0	0	0	0	0
PasserByVol:	0	0	0	0	0	0	0	0	0	0	0	0
Initial Fut:	161	922	62	128	1346	156	256	117	519	251	131	141
User Adj:	1.00	1.00	1.00	1.00	1.00	1.00	1.00	1.00	1.00	1.00	1.00	1.00
PHF Adj:	1.00	1.00	1.00	1.00	1.00	1.00	1.00	1.00	1.00	1.00	1.00	1.00
PHF Volume:	161	922	62	128	1346	156	256	117	519	251	131	141
Reduct Vol:	0	0	0	0	0	0	0	0	0	0	0	0
Reduced Vol:	161	922	62	128	1346	156	256	117	519	251	131	141
PCE Adj:	1.00	1.00	1.00	1.00	1.00	1.00	1.00	1.00	1.00	1.00	1.00	1.00
MLF Adj:	1.00	1.00	1.00	1.00	1.00	1.00	1.00	1.00	1.00	1.00	1.00	1.00
FinalVolume:	161	922	62	128	1346	156	256	117	519	251	131	141
Saturation Flow Module:												
Sat/Lane:	1900	1900	1900	1900	1900	1900	1900	1900	1900	1900	1900	1900
Adjustment:	0.92	1.00	0.92	0.92	1.00	0.92	0.92	1.00	0.92	0.83	0.95	0.95
Lanes:	1.00	2.00	1.00	1.00	2.00	1.00	1.00	1.00	1.00	2.00	0.48	0.52
Final Sat.:	1750	3800	1750	1750	3800	1750	1750	1900	1750	3150	867	933
Capacity Analysis Module:												
Vol/Sat:	0.09	0.24	0.04	0.07	0.35	0.09	0.15	0.06	0.30	0.08	0.15	0.15
Crit Moves:	****			****			****		****	****		
Green Time:	16.6	61.7	61.7	18.6	63.7	63.7	33.3	53.4	53.4	14.3	34.4	34.4
Volume/Cap:	0.89	0.63	0.09	0.63	0.89	0.22	0.70	0.18	0.89	0.89	0.70	0.70
Delay/Veh:	108.3	40.8	31.4	73.6	51.7	32.0	64.8	38.0	66.0	99.3	63.8	63.8
User DelAdj:	1.00	1.00	1.00	1.00	1.00	1.00	1.00	1.00	1.00	1.00	1.00	1.00
AdjDel/Veh:	108.3	40.8	31.4	73.6	51.7	32.0	64.8	38.0	66.0	99.3	63.8	63.8
LOS by Move:	F	D	C	E	D	C	E	D	E	F	E	E
HCM2k95thQ:	20	31	4	13	52	10	23	8	45	18	25	25

Note: Queue reported is the number of cars per lane.

BART Phase II Extension Project

Level Of Service Computation Report
2000 HCM Operations (Future Volume Alternative)
AM - 2025 Project Conditions

Intersection #3553: FRUITDALE/SOUTHWEST

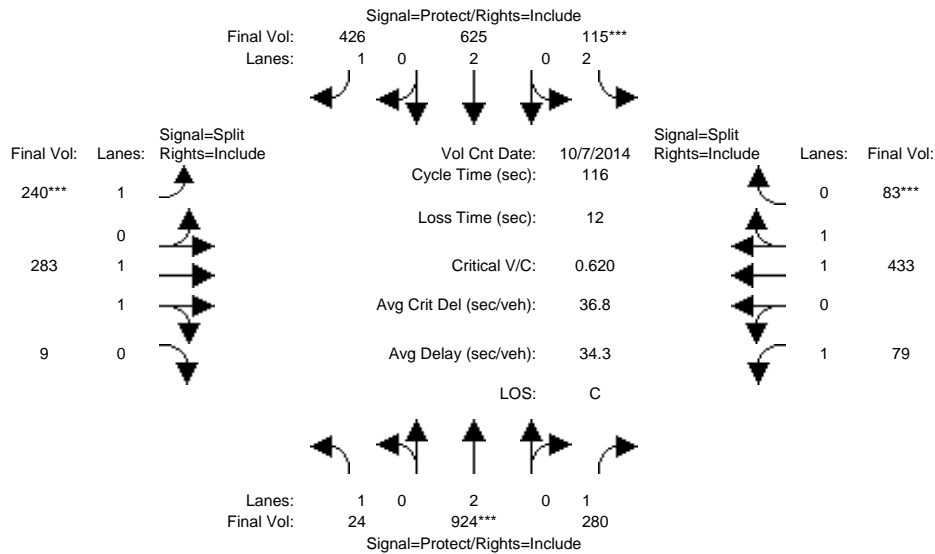

Approach:	North Bound			South Bound			East Bound			West Bound		
	L	T	R	L	T	R	L	T	R	L	T	R
Min. Green:	7	10	10	7	10	10	10	10	10	10	10	10
Y+R:	4.0	4.0	4.0	4.0	4.0	4.0	4.0	4.0	4.0	4.0	4.0	4.0
Volume Module: >> Count Date: 7 Oct 2014 <<												
Base Vol:	24	924	280	115	625	426	240	283	9	79	433	83
Growth Adj:	1.00	1.00	1.00	1.00	1.00	1.00	1.00	1.00	1.00	1.00	1.00	1.00
Initial Bse:	24	924	280	115	625	426	240	283	9	79	433	83
Added Vol:	0	0	0	0	0	0	0	0	0	0	0	0
PasserByVol:	0	0	0	0	0	0	0	0	0	0	0	0
Initial Fut:	24	924	280	115	625	426	240	283	9	79	433	83
User Adj:	1.00	1.00	1.00	1.00	1.00	1.00	1.00	1.00	1.00	1.00	1.00	1.00
PHF Adj:	1.00	1.00	1.00	1.00	1.00	1.00	1.00	1.00	1.00	1.00	1.00	1.00
PHF Volume:	24	924	280	115	625	426	240	283	9	79	433	83
Reduct Vol:	0	0	0	0	0	0	0	0	0	0	0	0
Reduced Vol:	24	924	280	115	625	426	240	283	9	79	433	83
PCE Adj:	1.00	1.00	1.00	1.00	1.00	1.00	1.00	1.00	1.00	1.00	1.00	1.00
MLF Adj:	1.00	1.00	1.00	1.00	1.00	1.00	1.00	1.00	1.00	1.00	1.00	1.00
FinalVolume:	24	924	280	115	625	426	240	283	9	79	433	83
Saturation Flow Module:												
Sat/Lane:	1900	1900	1900	1900	1900	1900	1900	1900	1900	1900	1900	1900
Adjustment:	0.92	1.00	0.92	0.83	1.00	0.92	0.92	0.97	0.95	0.92	0.98	0.95
Lanes:	1.00	2.00	1.00	2.00	2.00	1.00	1.00	1.94	0.06	1.00	1.67	0.33
Final Sat.:	1750	3800	1750	3150	3800	1750	1750	3586	114	1750	3104	595
Capacity Analysis Module:												
Vol/Sat:	0.01	0.24	0.16	0.04	0.16	0.24	0.14	0.08	0.08	0.05	0.14	0.14
Crit Moves:	****			****			****			****		
Green Time:	10.4	45.4	45.4	7.0	42.0	42.0	25.6	25.6	25.6	26.0	26.0	26.0
Volume/Cap:	0.15	0.62	0.41	0.60	0.45	0.67	0.62	0.36	0.36	0.20	0.62	0.62
Delay/Veh:	49.2	29.2	26.0	58.6	28.5	34.1	43.9	38.5	38.5	36.8	42.0	42.0
User DelAdj:	1.00	1.00	1.00	1.00	1.00	1.00	1.00	1.00	1.00	1.00	1.00	1.00
AdjDel/Veh:	49.2	29.2	26.0	58.6	28.5	34.1	43.9	38.5	38.5	36.8	42.0	42.0
LOS by Move:	D	C	C	E	C	C	D	D	D	D	D	D
HCM2k95thQ:	2	24	15	7	16	26	16	9	9	5	15	15

Note: Queue reported is the number of cars per lane.

BART Phase II Extension Project

Level Of Service Computation Report
2000 HCM Operations (Future Volume Alternative)
PM - 2025 Project Conditions

Intersection #3553: FRUITDALE/SOUTHWEST

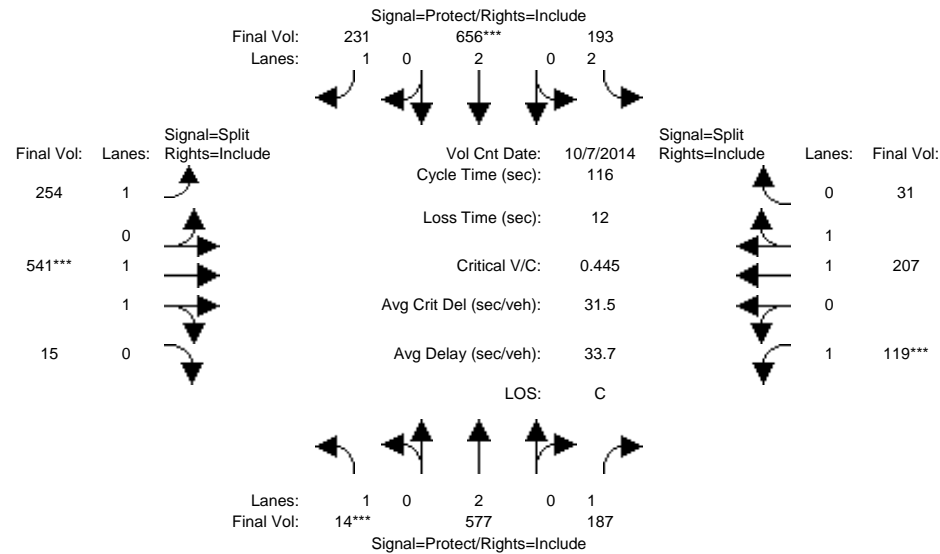

Approach:	North Bound			South Bound			East Bound			West Bound		
	L	T	R	L	T	R	L	T	R	L	T	R
Min. Green:	7	10	10	7	10	10	10	10	10	10	10	10
Y+R:	4.0	4.0	4.0	4.0	4.0	4.0	4.0	4.0	4.0	4.0	4.0	4.0
Volume Module: >> Count Date: 7 Oct 2014 <<												
Base Vol:	14	577	187	193	656	231	254	541	15	119	207	31
Growth Adj:	1.00	1.00	1.00	1.00	1.00	1.00	1.00	1.00	1.00	1.00	1.00	1.00
Initial Bse:	14	577	187	193	656	231	254	541	15	119	207	31
Added Vol:	0	0	0	0	0	0	0	0	0	0	0	0
PasserByVol:	0	0	0	0	0	0	0	0	0	0	0	0
Initial Fut:	14	577	187	193	656	231	254	541	15	119	207	31
User Adj:	1.00	1.00	1.00	1.00	1.00	1.00	1.00	1.00	1.00	1.00	1.00	1.00
PHF Adj:	1.00	1.00	1.00	1.00	1.00	1.00	1.00	1.00	1.00	1.00	1.00	1.00
PHF Volume:	14	577	187	193	656	231	254	541	15	119	207	31
Reduct Vol:	0	0	0	0	0	0	0	0	0	0	0	0
Reduced Vol:	14	577	187	193	656	231	254	541	15	119	207	31
PCE Adj:	1.00	1.00	1.00	1.00	1.00	1.00	1.00	1.00	1.00	1.00	1.00	1.00
MLF Adj:	1.00	1.00	1.00	1.00	1.00	1.00	1.00	1.00	1.00	1.00	1.00	1.00
FinalVolume:	14	577	187	193	656	231	254	541	15	119	207	31
Saturation Flow Module:												
Sat/Lane:	1900	1900	1900	1900	1900	1900	1900	1900	1900	1900	1900	1900
Adjustment:	0.92	1.00	0.92	0.83	1.00	0.92	0.92	0.97	0.95	0.92	0.98	0.95
Lanes:	1.00	2.00	1.00	2.00	2.00	1.00	1.00	1.94	0.06	1.00	1.73	0.27
Final Sat.:	1750	3800	1750	3150	3800	1750	1750	3600	100	1750	3218	482
Capacity Analysis Module:												
Vol/Sat:	0.01	0.15	0.11	0.06	0.17	0.13	0.15	0.15	0.15	0.07	0.06	0.06
Crit Moves:	****			****			****			****		
Green Time:	7.0	35.5	35.5	14.3	42.8	42.8	37.3	37.3	37.3	16.9	16.9	16.9
Volume/Cap:	0.13	0.50	0.35	0.50	0.47	0.36	0.45	0.47	0.47	0.47	0.44	0.44
Delay/Veh:	52.2	33.3	31.7	48.5	28.1	26.9	31.8	31.7	31.7	46.8	45.8	45.8
User DelAdj:	1.00	1.00	1.00	1.00	1.00	1.00	1.00	1.00	1.00	1.00	1.00	1.00
AdjDel/Veh:	52.2	33.3	31.7	48.5	28.1	26.9	31.8	31.7	31.7	46.8	45.8	45.8
LOS by Move:	D	C	C	D	C	C	C	C	C	D	D	D
HCM2k95thQ:	1	16	11	9	17	12	14	15	15	8	8	8

Note: Queue reported is the number of cars per lane.

BART Phase II Extension Project

Level Of Service Computation Report
2000 HCM Operations (Future Volume Alternative)
AM - 2025 Project Conditions

Intersection #3606: JULIAN/MONTGOMERY

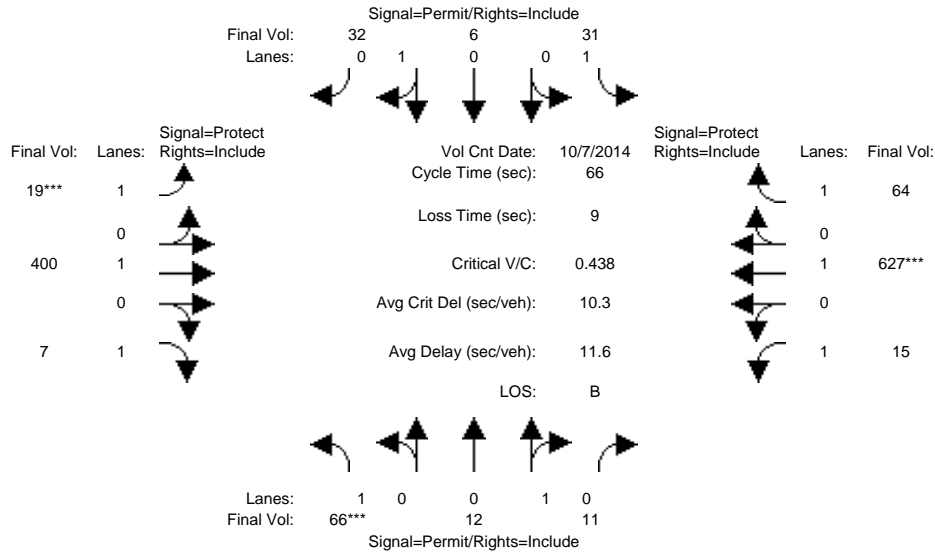

Approach:	North Bound			South Bound			East Bound			West Bound		
	L	T	R	L	T	R	L	T	R	L	T	R
Min. Green:	10	10	10	10	10	10	7	10	10	7	10	10
Y+R:	4.0	4.0	4.0	4.0	4.0	4.0	4.0	4.0	4.0	4.0	4.0	4.0
Volume Module: >> Count Date: 7 Oct 2014 <<												
Base Vol:	66	12	11	31	6	32	19	400	7	15	627	64
Growth Adj:	1.00	1.00	1.00	1.00	1.00	1.00	1.00	1.00	1.00	1.00	1.00	1.00
Initial Bse:	66	12	11	31	6	32	19	400	7	15	627	64
Added Vol:	0	0	0	0	0	0	0	0	0	0	0	0
PasserByVol:	0	0	0	0	0	0	0	0	0	0	0	0
Initial Fut:	66	12	11	31	6	32	19	400	7	15	627	64
User Adj:	1.00	1.00	1.00	1.00	1.00	1.00	1.00	1.00	1.00	1.00	1.00	1.00
PHF Adj:	1.00	1.00	1.00	1.00	1.00	1.00	1.00	1.00	1.00	1.00	1.00	1.00
PHF Volume:	66	12	11	31	6	32	19	400	7	15	627	64
Reduct Vol:	0	0	0	0	0	0	0	0	0	0	0	0
Reduced Vol:	66	12	11	31	6	32	19	400	7	15	627	64
PCE Adj:	1.00	1.00	1.00	1.00	1.00	1.00	1.00	1.00	1.00	1.00	1.00	1.00
MLF Adj:	1.00	1.00	1.00	1.00	1.00	1.00	1.00	1.00	1.00	1.00	1.00	1.00
FinalVolume:	66	12	11	31	6	32	19	400	7	15	627	64
Saturation Flow Module:												
Sat/Lane:	1900	1900	1900	1900	1900	1900	1900	1900	1900	1900	1900	1900
Adjustment:	0.92	0.95	0.95	0.92	0.95	0.95	0.92	1.00	0.92	0.92	1.00	0.92
Lanes:	1.00	0.52	0.48	1.00	0.16	0.84	1.00	1.00	1.00	1.00	1.00	1.00
Final Sat.:	1750	939	861	1750	284	1516	1750	1900	1750	1750	1900	1750
Capacity Analysis Module:												
Vol/Sat:	0.04	0.01	0.01	0.02	0.02	0.02	0.01	0.21	0.00	0.01	0.33	0.04
Crit Moves:	****						****				****	
Green Time:	10.0	10.0	10.0	10.0	10.0	10.0	7.0	31.3	31.3	15.7	40.0	40.0
Volume/Cap:	0.25	0.08	0.08	0.12	0.14	0.14	0.10	0.44	0.01	0.04	0.54	0.06
Delay/Veh:	25.2	24.2	24.2	24.4	24.5	24.5	26.9	11.9	9.2	19.3	8.2	5.3
User DelAdj:	1.00	1.00	1.00	1.00	1.00	1.00	1.00	1.00	1.00	1.00	1.00	1.00
AdjDel/Veh:	25.2	24.2	24.2	24.4	24.5	24.5	26.9	11.9	9.2	19.3	8.2	5.3
LOS by Move:	C	C	C	C	C	C	C	B	A	B	A	A
HCM2k95thQ:	3	1	1	1	2	2	1	10	0	0	13	1

Note: Queue reported is the number of cars per lane.

BART Phase II Extension Project

Level Of Service Computation Report
2000 HCM Operations (Future Volume Alternative)
PM - 2025 Project Conditions

Intersection #3606: JULIAN/MONTGOMERY

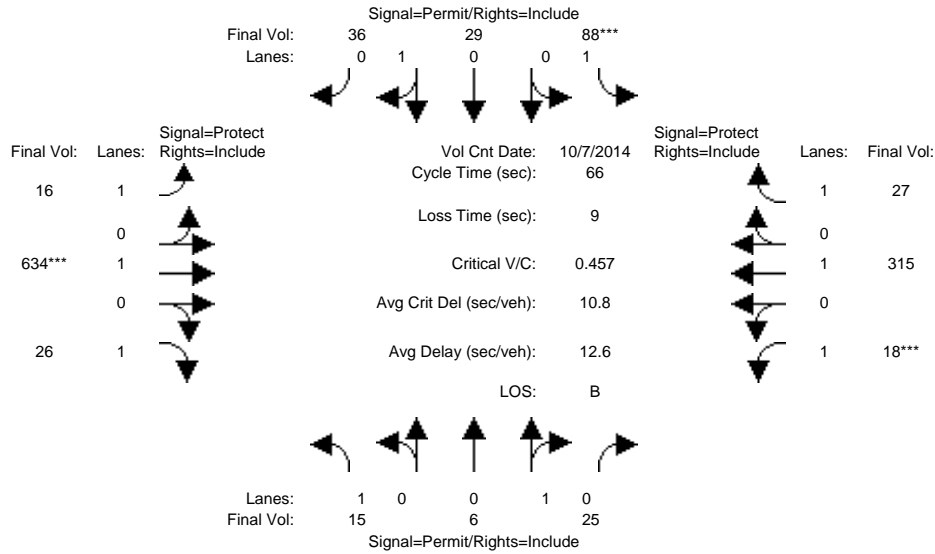

Approach:	North Bound			South Bound			East Bound			West Bound		
	L	T	R	L	T	R	L	T	R	L	T	R
Min. Green:	10	10	10	10	10	10	7	10	10	7	10	10
Y+R:	4.0	4.0	4.0	4.0	4.0	4.0	4.0	4.0	4.0	4.0	4.0	4.0

Volume Module:	>>	Count	Date:	7 Oct 2014	<<											
Base Vol:	15	6	25	88	29	36	16	634	26	18	315	27				
Growth Adj:	1.00	1.00	1.00	1.00	1.00	1.00	1.00	1.00	1.00	1.00	1.00	1.00				
Initial Bse:	15	6	25	88	29	36	16	634	26	18	315	27				
Added Vol:	0	0	0	0	0	0	0	0	0	0	0	0				
PasserByVol:	0	0	0	0	0	0	0	0	0	0	0	0				
Initial Fut:	15	6	25	88	29	36	16	634	26	18	315	27				
User Adj:	1.00	1.00	1.00	1.00	1.00	1.00	1.00	1.00	1.00	1.00	1.00	1.00				
PHF Adj:	1.00	1.00	1.00	1.00	1.00	1.00	1.00	1.00	1.00	1.00	1.00	1.00				
PHF Volume:	15	6	25	88	29	36	16	634	26	18	315	27				
Reduct Vol:	0	0	0	0	0	0	0	0	0	0	0	0				
Reduced Vol:	15	6	25	88	29	36	16	634	26	18	315	27				
PCE Adj:	1.00	1.00	1.00	1.00	1.00	1.00	1.00	1.00	1.00	1.00	1.00	1.00				
MLF Adj:	1.00	1.00	1.00	1.00	1.00	1.00	1.00	1.00	1.00	1.00	1.00	1.00				
FinalVolume:	15	6	25	88	29	36	16	634	26	18	315	27				

Saturation Flow Module:												
Sat/Lane:	1900	1900	1900	1900	1900	1900	1900	1900	1900	1900	1900	1900
Adjustment:	0.92	0.95	0.95	0.92	0.95	0.95	0.92	1.00	0.92	0.92	1.00	0.92
Lanes:	1.00	0.19	0.81	1.00	0.45	0.55	1.00	1.00	1.00	1.00	1.00	1.00
Final Sat.:	1750	348	1452	1750	803	997	1750	1900	1750	1750	1900	1750

Capacity Analysis Module:												
Vol/Sat:	0.01	0.02	0.02	0.05	0.04	0.04	0.01	0.33	0.01	0.01	0.17	0.02
Crit Moves:				****				****				****
Green Time:	10.0	10.0	10.0	10.0	10.0	10.0	18.3	40.0	40.0	7.0	28.7	28.7
Volume/Cap:	0.06	0.11	0.11	0.33	0.24	0.24	0.03	0.55	0.02	0.10	0.38	0.04
Delay/Veh:	24.1	24.4	24.4	25.8	25.1	25.1	17.4	8.3	5.2	26.9	13.0	10.7
User DelAdj:	1.00	1.00	1.00	1.00	1.00	1.00	1.00	1.00	1.00	1.00	1.00	1.00
AdjDel/Veh:	24.1	24.4	24.4	25.8	25.1	25.1	17.4	8.3	5.2	26.9	13.0	10.7
LOS by Move:	C	C	C	C	C	C	B	A	A	C	B	B
HCM2k95thQ:	1	1	1	4	3	3	1	14	0	1	8	1

Note: Queue reported is the number of cars per lane.

BART Phase II Extension Project

Level Of Service Computation Report
2000 HCM Operations (Future Volume Alternative)
AM - 2025 Project Conditions

Intersection #3608: JULIAN/STOCKTON

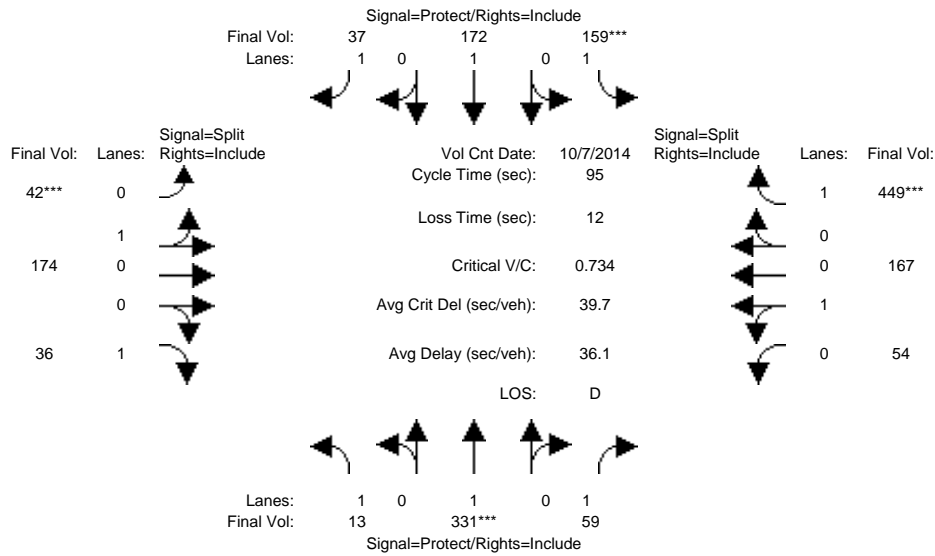

Approach:	North Bound			South Bound			East Bound			West Bound		
Movement:	L	T	R	L	T	R	L	T	R	L	T	R
Min. Green:	7	10	10	7	10	10	10	10	10	10	10	10
Y+R:	4.0	4.0	4.0	4.0	4.0	4.0	4.0	4.0	4.0	4.0	4.0	4.0
Volume Module: >> Count Date: 7 Oct 2014 <<												
Base Vol:	13	331	59	159	172	37	42	174	36	54	167	449
Growth Adj:	1.00	1.00	1.00	1.00	1.00	1.00	1.00	1.00	1.00	1.00	1.00	1.00
Initial Bse:	13	331	59	159	172	37	42	174	36	54	167	449
Added Vol:	0	0	0	0	0	0	0	0	0	0	0	0
PasserByVol:	0	0	0	0	0	0	0	0	0	0	0	0
Initial Fut:	13	331	59	159	172	37	42	174	36	54	167	449
User Adj:	1.00	1.00	1.00	1.00	1.00	1.00	1.00	1.00	1.00	1.00	1.00	1.00
PHF Adj:	1.00	1.00	1.00	1.00	1.00	1.00	1.00	1.00	1.00	1.00	1.00	1.00
PHF Volume:	13	331	59	159	172	37	42	174	36	54	167	449
Reduct Vol:	0	0	0	0	0	0	0	0	0	0	0	0
Reduced Vol:	13	331	59	159	172	37	42	174	36	54	167	449
PCE Adj:	1.00	1.00	1.00	1.00	1.00	1.00	1.00	1.00	1.00	1.00	1.00	1.00
MLF Adj:	1.00	1.00	1.00	1.00	1.00	1.00	1.00	1.00	1.00	1.00	1.00	1.00
FinalVolume:	13	331	59	159	172	37	42	174	36	54	167	449
Saturation Flow Module:												
Sat/Lane:	1900	1900	1900	1900	1900	1900	1900	1900	1900	1900	1900	1900
Adjustment:	0.92	1.00	0.92	0.92	1.00	0.92	0.95	0.95	0.92	0.95	0.95	0.92
Lanes:	1.00	1.00	1.00	1.00	1.00	1.00	0.19	0.81	1.00	0.24	0.76	1.00
Final Sat.:	1750	1900	1750	1750	1900	1750	350	1450	1750	440	1360	1750
Capacity Analysis Module:												
Vol/Sat:	0.01	0.17	0.03	0.09	0.09	0.02	0.12	0.12	0.02	0.12	0.12	0.26
Crit Moves:	****			****			****			****		
Green Time:	14.1	22.5	22.5	11.8	20.2	20.2	15.5	15.5	15.5	33.2	33.2	33.2
Volume/Cap:	0.05	0.73	0.14	0.73	0.43	0.10	0.73	0.73	0.13	0.35	0.35	0.73
Delay/Veh:	34.8	39.6	28.8	52.4	33.1	30.2	47.0	47.0	34.1	23.3	23.3	31.7
User DelAdj:	1.00	1.00	1.00	1.00	1.00	1.00	1.00	1.00	1.00	1.00	1.00	1.00
AdjDel/Veh:	34.8	39.6	28.8	52.4	33.1	30.2	47.0	47.0	34.1	23.3	23.3	31.7
LOS by Move:	C	D	C	D	C	C	D	D	C	C	C	C
HCM2k95thQ:	1	17	3	10	8	2	13	13	2	9	9	22

Note: Queue reported is the number of cars per lane.

BART Phase II Extension Project

Level Of Service Computation Report
2000 HCM Operations (Future Volume Alternative)
PM - 2025 Project Conditions

Intersection #3608: JULIAN/STOCKTON

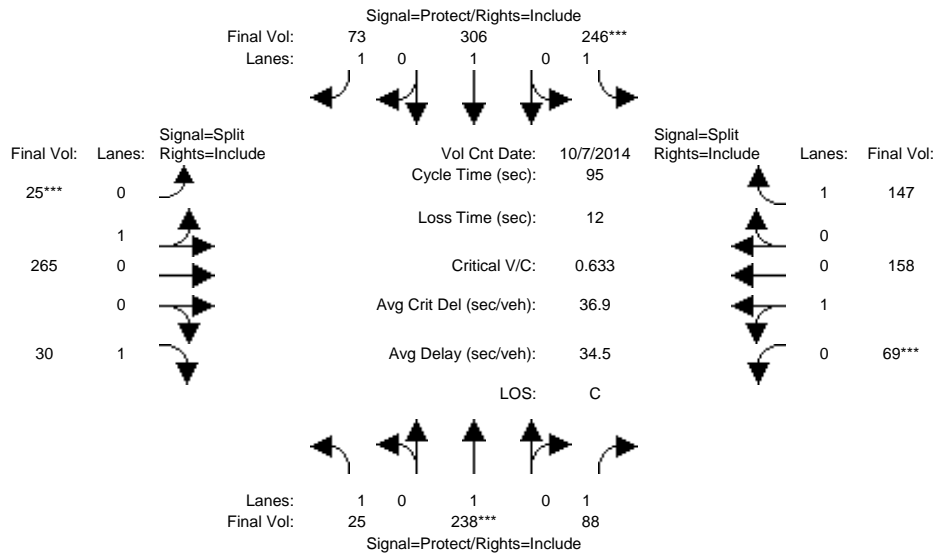

Approach:	North Bound			South Bound			East Bound			West Bound		
	L	T	R	L	T	R	L	T	R	L	T	R
Min. Green:	7	10	10	7	10	10	10	10	10	10	10	10
Y+R:	4.0	4.0	4.0	4.0	4.0	4.0	4.0	4.0	4.0	4.0	4.0	4.0

Volume Module:	>>	Count	Date:	7 Oct 2014	<<							
Base Vol:	25	238	88	246	306	73	25	265	30	69	158	147
Growth Adj:	1.00	1.00	1.00	1.00	1.00	1.00	1.00	1.00	1.00	1.00	1.00	1.00
Initial Bse:	25	238	88	246	306	73	25	265	30	69	158	147
Added Vol:	0	0	0	0	0	0	0	0	0	0	0	0
PasserByVol:	0	0	0	0	0	0	0	0	0	0	0	0
Initial Fut:	25	238	88	246	306	73	25	265	30	69	158	147
User Adj:	1.00	1.00	1.00	1.00	1.00	1.00	1.00	1.00	1.00	1.00	1.00	1.00
PHF Adj:	1.00	1.00	1.00	1.00	1.00	1.00	1.00	1.00	1.00	1.00	1.00	1.00
PHF Volume:	25	238	88	246	306	73	25	265	30	69	158	147
Reduct Vol:	0	0	0	0	0	0	0	0	0	0	0	0
Reduced Vol:	25	238	88	246	306	73	25	265	30	69	158	147
PCE Adj:	1.00	1.00	1.00	1.00	1.00	1.00	1.00	1.00	1.00	1.00	1.00	1.00
MLF Adj:	1.00	1.00	1.00	1.00	1.00	1.00	1.00	1.00	1.00	1.00	1.00	1.00
FinalVolume:	25	238	88	246	306	73	25	265	30	69	158	147

Saturation Flow Module:												
Sat/Lane:	1900	1900	1900	1900	1900	1900	1900	1900	1900	1900	1900	1900
Adjustment:	0.92	1.00	0.92	0.92	1.00	0.92	0.95	0.95	0.92	0.95	0.95	0.92
Lanes:	1.00	1.00	1.00	1.00	1.00	1.00	0.09	0.91	1.00	0.30	0.70	1.00
Final Sat.:	1750	1900	1750	1750	1900	1750	155	1645	1750	547	1253	1750

Capacity Analysis Module:												
Vol/Sat:	0.01	0.13	0.05	0.14	0.16	0.04	0.16	0.16	0.02	0.13	0.13	0.08
Crit Moves:	****	****	****	****	****	****	****	****	****	****	****	****
Green Time:	12.5	18.8	18.8	21.1	27.4	27.4	24.2	24.2	24.2	18.9	18.9	18.9
Volume/Cap:	0.11	0.63	0.25	0.63	0.56	0.14	0.63	0.63	0.07	0.63	0.63	0.42
Delay/Veh:	36.5	38.4	32.6	36.8	30.0	25.3	34.4	34.4	26.9	38.5	38.5	34.1
User DelAdj:	1.00	1.00	1.00	1.00	1.00	1.00	1.00	1.00	1.00	1.00	1.00	1.00
AdjDel/Veh:	36.5	38.4	32.6	36.8	30.0	25.3	34.4	34.4	26.9	38.5	38.5	34.1
LOS by Move:	D	D	C	D	C	C	C	C	C	D	D	C
HCM2k95thQ:	1	12	5	13	14	3	15	15	1	12	12	8

Note: Queue reported is the number of cars per lane.

BART Phase II Extension Project

Level Of Service Computation Report
 2000 HCM Operations (Future Volume Alternative)
 AM - 2025 Project Conditions

Intersection #3651: LINCOLN/PARKMOOR

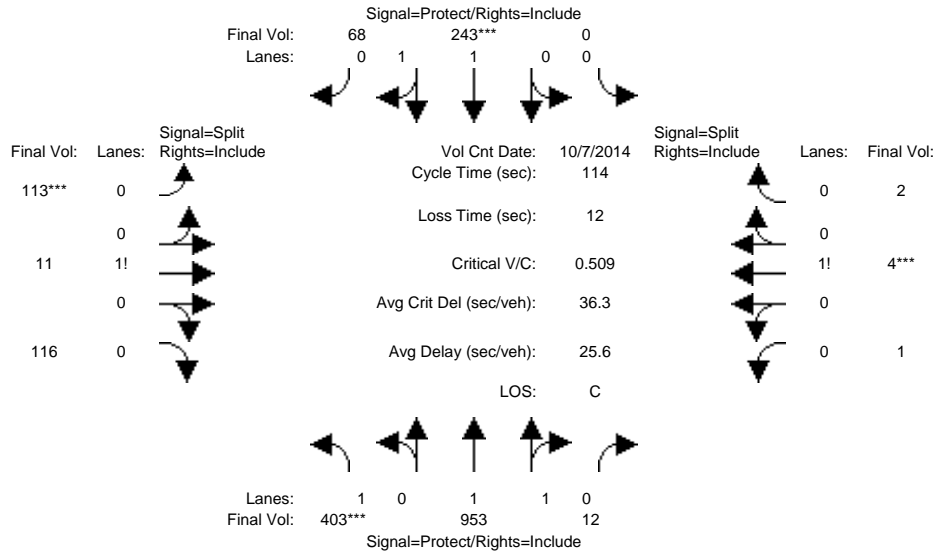

Approach:	North Bound			South Bound			East Bound			West Bound		
	L	T	R	L	T	R	L	T	R	L	T	R
Min. Green:	7	10	10	0	10	10	10	10	10	10	10	10
Y+R:	4.0	4.0	4.0	4.0	4.0	4.0	4.0	4.0	4.0	4.0	4.0	4.0
Volume Module: >> Count Date: 7 Oct 2014 <<												
Base Vol:	403	953	12	0	243	68	113	11	116	1	4	2
Growth Adj:	1.00	1.00	1.00	1.00	1.00	1.00	1.00	1.00	1.00	1.00	1.00	1.00
Initial Bse:	403	953	12	0	243	68	113	11	116	1	4	2
Added Vol:	0	0	0	0	0	0	0	0	0	0	0	0
PasserByVol:	0	0	0	0	0	0	0	0	0	0	0	0
Initial Fut:	403	953	12	0	243	68	113	11	116	1	4	2
User Adj:	1.00	1.00	1.00	1.00	1.00	1.00	1.00	1.00	1.00	1.00	1.00	1.00
PHF Adj:	1.00	1.00	1.00	1.00	1.00	1.00	1.00	1.00	1.00	1.00	1.00	1.00
PHF Volume:	403	953	12	0	243	68	113	11	116	1	4	2
Reduct Vol:	0	0	0	0	0	0	0	0	0	0	0	0
Reduced Vol:	403	953	12	0	243	68	113	11	116	1	4	2
PCE Adj:	1.00	1.00	1.00	1.00	1.00	1.00	1.00	1.00	1.00	1.00	1.00	1.00
MLF Adj:	1.00	1.00	1.00	1.00	1.00	1.00	1.00	1.00	1.00	1.00	1.00	1.00
FinalVolume:	403	953	12	0	243	68	113	11	116	1	4	2
Saturation Flow Module:												
Sat/Lane:	1900	1900	1900	1900	1900	1900	1900	1900	1900	1900	1900	1900
Adjustment:	0.92	0.97	0.95	0.92	0.98	0.95	0.92	0.92	0.92	0.92	0.92	0.92
Lanes:	1.00	1.97	0.03	0.00	1.55	0.45	0.47	0.05	0.48	0.14	0.57	0.29
Final Sat.:	1750	3654	46	0	2890	809	824	80	846	250	1000	500
Capacity Analysis Module:												
Vol/Sat:	0.23	0.26	0.26	0.00	0.08	0.08	0.14	0.14	0.14	0.00	0.00	0.00
Crit Moves:	****				****		****				****	
Green Time:	46.9	64.1	64.1	0.0	17.1	17.1	27.9	27.9	27.9	10.0	10.0	10.0
Volume/Cap:	0.56	0.46	0.46	0.00	0.56	0.56	0.56	0.56	0.56	0.05	0.05	0.05
Delay/Veh:	26.6	15.0	15.0	0.0	46.2	46.2	39.3	39.3	39.3	47.8	47.8	47.8
User DelAdj:	1.00	1.00	1.00	1.00	1.00	1.00	1.00	1.00	1.00	1.00	1.00	1.00
AdjDel/Veh:	26.6	15.0	15.0	0.0	46.2	46.2	39.3	39.3	39.3	47.8	47.8	47.8
LOS by Move:	C	B	B	A	D	D	D	D	D	D	D	D
HCM2k95thQ:	21	18	18	0	10	10	15	15	15	1	1	1

Note: Queue reported is the number of cars per lane.

BART Phase II Extension Project

Level Of Service Computation Report
 2000 HCM Operations (Future Volume Alternative)
 PM - 2025 Project Conditions

Intersection #3651: LINCOLN/PARKMOOR

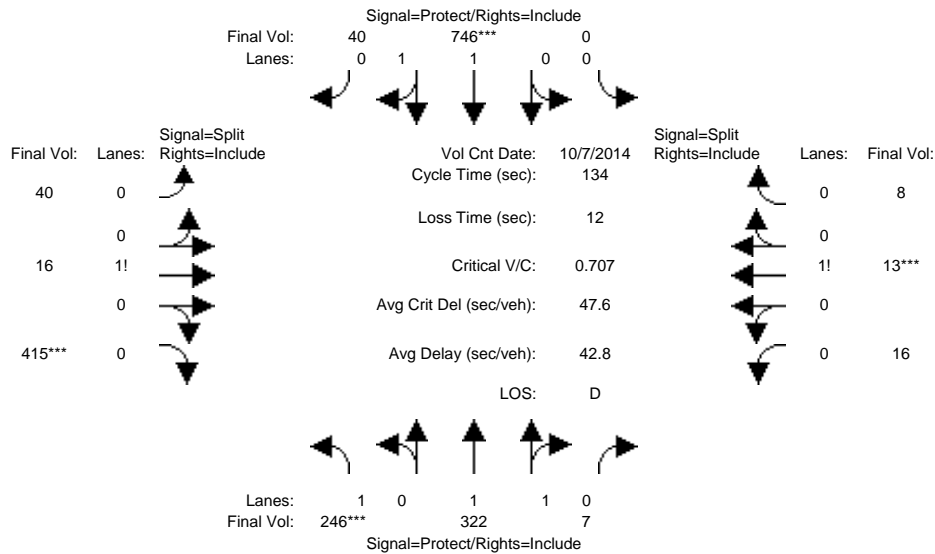

Approach:	North Bound			South Bound			East Bound			West Bound		
Movement:	L	T	R	L	T	R	L	T	R	L	T	R
Min. Green:	7	10	10	0	10	10	10	10	10	10	10	10
Y+R:	4.0	4.0	4.0	4.0	4.0	4.0	4.0	4.0	4.0	4.0	4.0	4.0
Volume Module: >> Count Date: 7 Oct 2014 <<												
Base Vol:	246	322	7	0	746	40	40	16	415	16	13	8
Growth Adj:	1.00	1.00	1.00	1.00	1.00	1.00	1.00	1.00	1.00	1.00	1.00	1.00
Initial Bse:	246	322	7	0	746	40	40	16	415	16	13	8
Added Vol:	0	0	0	0	0	0	0	0	0	0	0	0
PasserByVol:	0	0	0	0	0	0	0	0	0	0	0	0
Initial Fut:	246	322	7	0	746	40	40	16	415	16	13	8
User Adj:	1.00	1.00	1.00	1.00	1.00	1.00	1.00	1.00	1.00	1.00	1.00	1.00
PHF Adj:	1.00	1.00	1.00	1.00	1.00	1.00	1.00	1.00	1.00	1.00	1.00	1.00
PHF Volume:	246	322	7	0	746	40	40	16	415	16	13	8
Reduct Vol:	0	0	0	0	0	0	0	0	0	0	0	0
Reduced Vol:	246	322	7	0	746	40	40	16	415	16	13	8
PCE Adj:	1.00	1.00	1.00	1.00	1.00	1.00	1.00	1.00	1.00	1.00	1.00	1.00
MLF Adj:	1.00	1.00	1.00	1.00	1.00	1.00	1.00	1.00	1.00	1.00	1.00	1.00
FinalVolume:	246	322	7	0	746	40	40	16	415	16	13	8
Saturation Flow Module:												
Sat/Lane:	1900	1900	1900	1900	1900	1900	1900	1900	1900	1900	1900	1900
Adjustment:	0.92	0.97	0.95	0.92	0.98	0.95	0.92	0.92	0.92	0.92	0.92	0.92
Lanes:	1.00	1.96	0.04	0.00	1.90	0.10	0.08	0.03	0.89	0.43	0.35	0.22
Final Sat.:	1750	3621	79	0	3512	188	149	59	1542	757	615	378
Capacity Analysis Module:												
Vol/Sat:	0.14	0.09	0.09	0.00	0.21	0.21	0.27	0.27	0.27	0.02	0.02	0.02
Crit Moves:	****				****				****			****
Green Time:	25.3	63.5	63.5	0.0	38.2	38.2	48.5	48.5	48.5	10.0	10.0	10.0
Volume/Cap:	0.74	0.19	0.19	0.00	0.74	0.74	0.74	0.74	0.74	0.28	0.28	0.28
Delay/Veh:	60.2	20.4	20.4	0.0	46.4	46.4	42.2	42.2	42.2	59.8	59.8	59.8
User DelAdj:	1.00	1.00	1.00	1.00	1.00	1.00	1.00	1.00	1.00	1.00	1.00	1.00
AdjDel/Veh:	60.2	20.4	20.4	0.0	46.4	46.4	42.2	42.2	42.2	59.8	59.8	59.8
LOS by Move:	E	C	C	A	D	D	D	D	D	E	E	E
HCM2k95thQ:	19	8	8	0	27	27	32	32	32	4	4	4

Note: Queue reported is the number of cars per lane.

BART Phase II Extension Project

Level Of Service Computation Report
 2000 HCM Operations (Future Volume Alternative)
 AM - 2025 Project Conditions

Intersection #3653: LINCOLN/SAN CARLOS

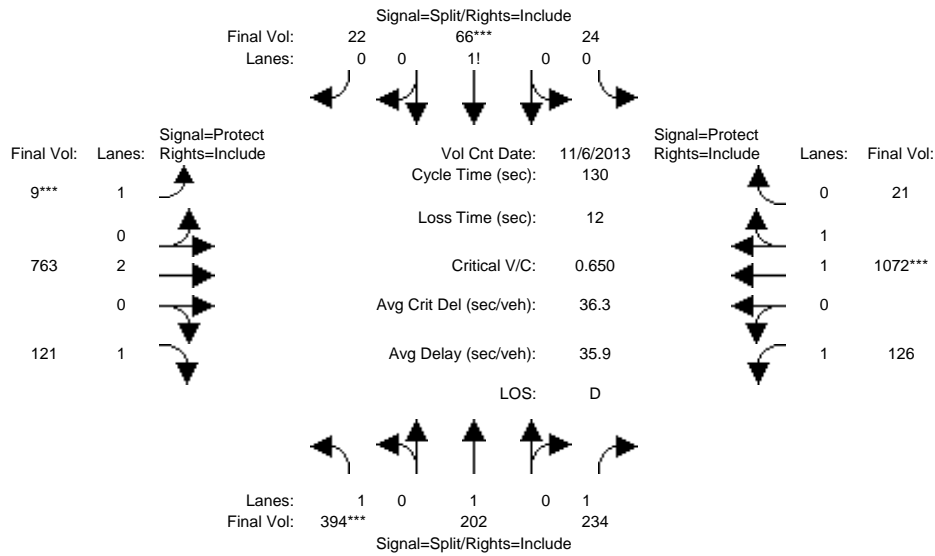

Approach:	North Bound			South Bound			East Bound			West Bound		
	L	T	R	L	T	R	L	T	R	L	T	R
Min. Green:	10	10	10	10	10	10	7	10	10	7	10	10
Y+R:	4.0	4.0	4.0	4.0	4.0	4.0	4.0	4.0	4.0	4.0	4.0	4.0

Volume Module: >> Count Date: 6 Nov 2013 <<

Base Vol:	394	202	234	24	66	22	9	763	121	126	1072	21
Growth Adj:	1.00	1.00	1.00	1.00	1.00	1.00	1.00	1.00	1.00	1.00	1.00	1.00
Initial Bse:	394	202	234	24	66	22	9	763	121	126	1072	21
Added Vol:	0	0	0	0	0	0	0	0	0	0	0	0
PasserByVol:	0	0	0	0	0	0	0	0	0	0	0	0
Initial Fut:	394	202	234	24	66	22	9	763	121	126	1072	21
User Adj:	1.00	1.00	1.00	1.00	1.00	1.00	1.00	1.00	1.00	1.00	1.00	1.00
PHF Adj:	1.00	1.00	1.00	1.00	1.00	1.00	1.00	1.00	1.00	1.00	1.00	1.00
PHF Volume:	394	202	234	24	66	22	9	763	121	126	1072	21
Reduct Vol:	0	0	0	0	0	0	0	0	0	0	0	0
Reduced Vol:	394	202	234	24	66	22	9	763	121	126	1072	21
PCE Adj:	1.00	1.00	1.00	1.00	1.00	1.00	1.00	1.00	1.00	1.00	1.00	1.00
MLF Adj:	1.00	1.00	1.00	1.00	1.00	1.00	1.00	1.00	1.00	1.00	1.00	1.00
FinalVolume:	394	202	234	24	66	22	9	763	121	126	1072	21

Saturation Flow Module:

Sat/Lane:	1900	1900	1900	1900	1900	1900	1900	1900	1900	1900	1900	1900
Adjustment:	0.92	1.00	0.92	0.92	0.92	0.92	0.92	1.00	0.92	0.92	0.97	0.95
Lanes:	1.00	1.00	1.00	0.21	0.59	0.20	1.00	2.00	1.00	1.00	1.96	0.04
Final Sat.:	1750	1900	1750	375	1031	344	1750	3800	1750	1750	3629	71

Capacity Analysis Module:

Vol/Sat:	0.23	0.11	0.13	0.06	0.06	0.06	0.01	0.20	0.07	0.07	0.30	0.30
Crit Moves:	****				****		****				****	
Green Time:	42.8	42.8	42.8	12.2	12.2	12.2	7.0	46.4	46.4	16.7	56.1	56.1
Volume/Cap:	0.68	0.32	0.41	0.68	0.68	0.68	0.10	0.56	0.19	0.56	0.68	0.68
Delay/Veh:	41.2	33.1	34.3	68.5	68.5	68.5	58.9	34.1	29.0	56.5	31.1	31.1
User DelAdj:	1.00	1.00	1.00	1.00	1.00	1.00	1.00	1.00	1.00	1.00	1.00	1.00
AdjDel/Veh:	41.2	33.1	34.3	68.5	68.5	68.5	58.9	34.1	29.0	56.5	31.1	31.1
LOS by Move:	D	C	C	E	E	E	E	C	C	E	C	C
HCM2k95thQ:	26	11	14	12	12	12	1	22	7	10	31	31

Note: Queue reported is the number of cars per lane.

BART Phase II Extension Project

Level Of Service Computation Report
 2000 HCM Operations (Future Volume Alternative)
 PM - 2025 Project Conditions

Intersection #3653: LINCOLN/SAN CARLOS

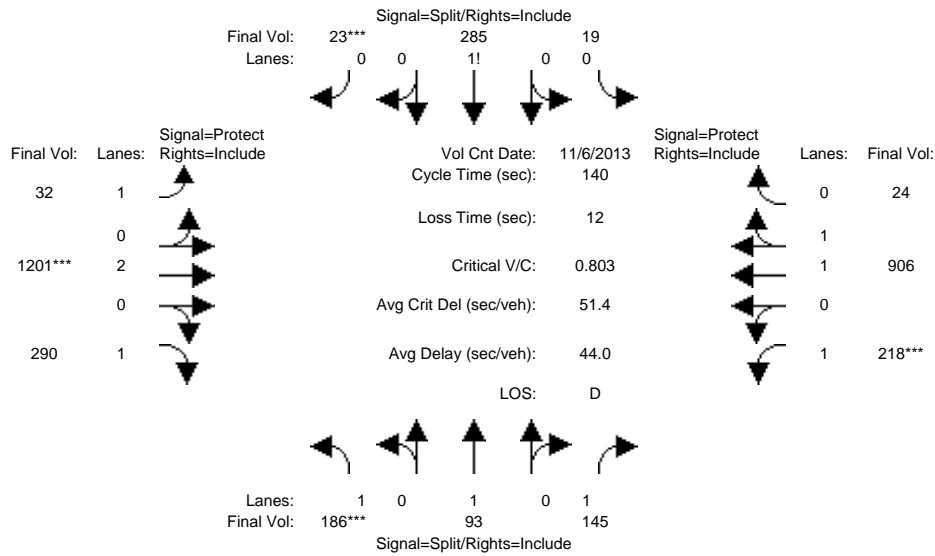

Approach:	North Bound			South Bound			East Bound			West Bound		
	L	T	R	L	T	R	L	T	R	L	T	R
Min. Green:	10	10	10	10	10	10	7	10	10	7	10	10
Y+R:	4.0	4.0	4.0	4.0	4.0	4.0	4.0	4.0	4.0	4.0	4.0	4.0

Volume Module: >> Count Date: 6 Nov 2013 <<

Base Vol:	186	93	145	19	285	23	32	1201	290	218	906	24
Growth Adj:	1.00	1.00	1.00	1.00	1.00	1.00	1.00	1.00	1.00	1.00	1.00	1.00
Initial Bse:	186	93	145	19	285	23	32	1201	290	218	906	24
Added Vol:	0	0	0	0	0	0	0	0	0	0	0	0
PasserByVol:	0	0	0	0	0	0	0	0	0	0	0	0
Initial Fut:	186	93	145	19	285	23	32	1201	290	218	906	24
User Adj:	1.00	1.00	1.00	1.00	1.00	1.00	1.00	1.00	1.00	1.00	1.00	1.00
PHF Adj:	1.00	1.00	1.00	1.00	1.00	1.00	1.00	1.00	1.00	1.00	1.00	1.00
PHF Volume:	186	93	145	19	285	23	32	1201	290	218	906	24
Reduct Vol:	0	0	0	0	0	0	0	0	0	0	0	0
Reduced Vol:	186	93	145	19	285	23	32	1201	290	218	906	24
PCE Adj:	1.00	1.00	1.00	1.00	1.00	1.00	1.00	1.00	1.00	1.00	1.00	1.00
MLF Adj:	1.00	1.00	1.00	1.00	1.00	1.00	1.00	1.00	1.00	1.00	1.00	1.00
FinalVolume:	186	93	145	19	285	23	32	1201	290	218	906	24

Saturation Flow Module:

Sat/Lane:	1900	1900	1900	1900	1900	1900	1900	1900	1900	1900	1900	1900
Adjustment:	0.92	1.00	0.92	0.92	0.92	0.92	0.92	1.00	0.92	0.92	0.97	0.95
Lanes:	1.00	1.00	1.00	0.06	0.87	0.07	1.00	2.00	1.00	1.00	1.95	0.05
Final Sat.:	1750	1900	1750	102	1525	123	1750	3800	1750	1750	3604	95

Capacity Analysis Module:

Vol/Sat:	0.11	0.05	0.08	0.19	0.19	0.19	0.02	0.32	0.17	0.12	0.25	0.25
Crit Moves:	****					****		****		****		
Green Time:	18.5	18.5	18.5	32.6	32.6	32.6	12.8	55.1	55.1	21.7	64.1	64.1
Volume/Cap:	0.80	0.37	0.63	0.80	0.80	0.80	0.20	0.80	0.42	0.80	0.55	0.55
Delay/Veh:	76.9	56.3	62.7	61.6	61.6	61.6	59.5	40.8	31.2	72.7	27.9	27.9
User DelAdj:	1.00	1.00	1.00	1.00	1.00	1.00	1.00	1.00	1.00	1.00	1.00	1.00
AdjDel/Veh:	76.9	56.3	62.7	61.6	61.6	61.6	59.5	40.8	31.2	72.7	27.9	27.9
LOS by Move:	E	E	E	E	E	E	E	D	C	E	C	C
HCM2k95thQ:	17	7	12	28	28	28	3	39	18	19	26	26

Note: Queue reported is the number of cars per lane.

BART Phase II Extension Project

Level Of Service Computation Report
2000 HCM Operations (Future Volume Alternative)
AM - 2025 Project Conditions

Intersection #3690: MERIDIAN/PARKMOOR

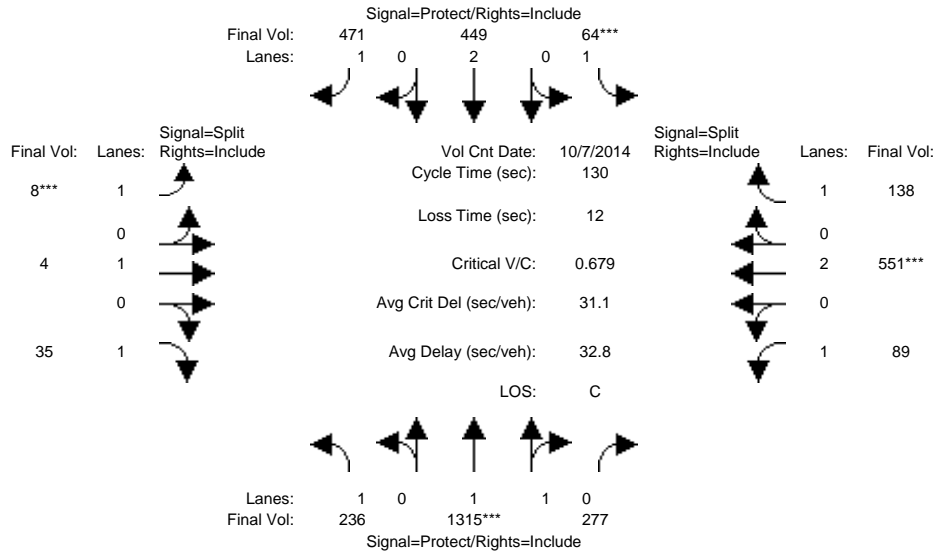

Approach:	North Bound			South Bound			East Bound			West Bound		
	L	T	R	L	T	R	L	T	R	L	T	R
Min. Green:	7	10	10	7	10	10	10	10	10	10	10	10
Y+R:	4.0	4.0	4.0	4.0	4.0	4.0	4.0	4.0	4.0	4.0	4.0	4.0
Volume Module: >> Count Date: 7 Oct 2014 <<												
Base Vol:	236	1315	277	64	449	471	8	4	35	89	551	138
Growth Adj:	1.00	1.00	1.00	1.00	1.00	1.00	1.00	1.00	1.00	1.00	1.00	1.00
Initial Bse:	236	1315	277	64	449	471	8	4	35	89	551	138
Added Vol:	0	0	0	0	0	0	0	0	0	0	0	0
PasserByVol:	0	0	0	0	0	0	0	0	0	0	0	0
Initial Fut:	236	1315	277	64	449	471	8	4	35	89	551	138
User Adj:	1.00	1.00	1.00	1.00	1.00	1.00	1.00	1.00	1.00	1.00	1.00	1.00
PHF Adj:	1.00	1.00	1.00	1.00	1.00	1.00	1.00	1.00	1.00	1.00	1.00	1.00
PHF Volume:	236	1315	277	64	449	471	8	4	35	89	551	138
Reduct Vol:	0	0	0	0	0	0	0	0	0	0	0	0
Reduced Vol:	236	1315	277	64	449	471	8	4	35	89	551	138
PCE Adj:	1.00	1.00	1.00	1.00	1.00	1.00	1.00	1.00	1.00	1.00	1.00	1.00
MLF Adj:	1.00	1.00	1.00	1.00	1.00	1.00	1.00	1.00	1.00	1.00	1.00	1.00
FinalVolume:	236	1315	277	64	449	471	8	4	35	89	551	138
Saturation Flow Module:												
Sat/Lane:	1900	1900	1900	1900	1900	1900	1900	1900	1900	1900	1900	1900
Adjustment:	0.92	0.98	0.95	0.92	1.00	0.92	0.92	1.00	0.92	0.92	1.00	0.92
Lanes:	1.00	1.64	0.36	1.00	2.00	1.00	1.00	1.00	1.00	1.00	2.00	1.00
Final Sat.:	1750	3056	644	1750	3800	1750	1750	1900	1750	1750	3800	1750
Capacity Analysis Module:												
Vol/Sat:	0.13	0.43	0.43	0.04	0.12	0.27	0.00	0.00	0.02	0.05	0.15	0.08
Crit Moves:	****			****			****			****		
Green Time:	27.6	75.5	75.5	7.0	55.0	55.0	10.0	10.0	10.0	25.5	25.5	25.5
Volume/Cap:	0.64	0.74	0.74	0.68	0.28	0.64	0.06	0.03	0.26	0.26	0.74	0.40
Delay/Veh:	50.3	21.4	21.4	78.6	24.6	31.5	55.8	55.6	57.5	44.7	53.2	46.4
User DelAdj:	1.00	1.00	1.00	1.00	1.00	1.00	1.00	1.00	1.00	1.00	1.00	1.00
AdjDel/Veh:	50.3	21.4	21.4	78.6	24.6	31.5	55.8	55.6	57.5	44.7	53.2	46.4
LOS by Move:	D	C	C	E	C	C	E	E	E	D	D	D
HCM2k95thQ:	19	40	40	6	11	28	1	0	3	6	19	10

Note: Queue reported is the number of cars per lane.

BART Phase II Extension Project

Level Of Service Computation Report
2000 HCM Operations (Future Volume Alternative)
PM - 2025 Project Conditions

Intersection #3690: MERIDIAN/PARKMOOR

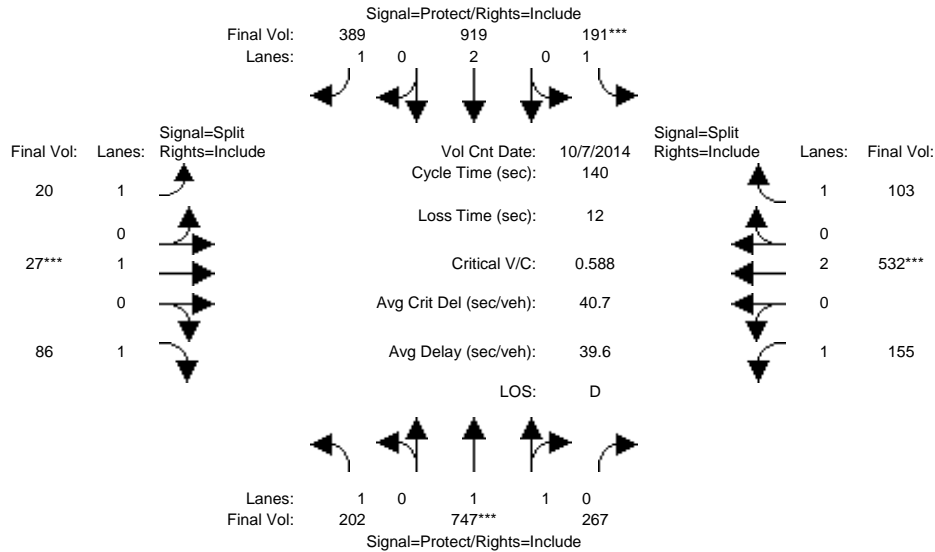

Approach:	North Bound			South Bound			East Bound			West Bound		
	L	T	R	L	T	R	L	T	R	L	T	R
Min. Green:	7	10	10	7	10	10	10	10	10	10	10	10
Y+R:	4.0	4.0	4.0	4.0	4.0	4.0	4.0	4.0	4.0	4.0	4.0	4.0
Volume Module: >> Count Date: 7 Oct 2014 <<												
Base Vol:	202	747	267	191	919	389	20	27	86	155	532	103
Growth Adj:	1.00	1.00	1.00	1.00	1.00	1.00	1.00	1.00	1.00	1.00	1.00	1.00
Initial Bse:	202	747	267	191	919	389	20	27	86	155	532	103
Added Vol:	0	0	0	0	0	0	0	0	0	0	0	0
PasserByVol:	0	0	0	0	0	0	0	0	0	0	0	0
Initial Fut:	202	747	267	191	919	389	20	27	86	155	532	103
User Adj:	1.00	1.00	1.00	1.00	1.00	1.00	1.00	1.00	1.00	1.00	1.00	1.00
PHF Adj:	1.00	1.00	1.00	1.00	1.00	1.00	1.00	1.00	1.00	1.00	1.00	1.00
PHF Volume:	202	747	267	191	919	389	20	27	86	155	532	103
Reduct Vol:	0	0	0	0	0	0	0	0	0	0	0	0
Reduced Vol:	202	747	267	191	919	389	20	27	86	155	532	103
PCE Adj:	1.00	1.00	1.00	1.00	1.00	1.00	1.00	1.00	1.00	1.00	1.00	1.00
MLF Adj:	1.00	1.00	1.00	1.00	1.00	1.00	1.00	1.00	1.00	1.00	1.00	1.00
FinalVolume:	202	747	267	191	919	389	20	27	86	155	532	103
Saturation Flow Module:												
Sat/Lane:	1900	1900	1900	1900	1900	1900	1900	1900	1900	1900	1900	1900
Adjustment:	0.92	0.98	0.95	0.92	1.00	0.92	0.92	1.00	0.92	0.92	1.00	0.92
Lanes:	1.00	1.46	0.54	1.00	2.00	1.00	1.00	1.00	1.00	1.00	2.00	1.00
Final Sat.:	1750	2725	974	1750	3800	1750	1750	1900	1750	1750	3800	1750
Capacity Analysis Module:												
Vol/Sat:	0.12	0.27	0.27	0.11	0.24	0.22	0.01	0.01	0.05	0.09	0.14	0.06
Crit Moves:	****			****			****			****		
Green Time:	27.5	60.9	60.9	24.3	57.7	57.7	11.7	11.7	11.7	31.1	31.1	31.1
Volume/Cap:	0.59	0.63	0.63	0.63	0.59	0.54	0.14	0.17	0.59	0.40	0.63	0.26
Delay/Veh:	53.7	31.6	31.6	57.9	32.5	32.0	59.9	60.1	68.0	47.1	50.8	45.4
User DelAdj:	1.00	1.00	1.00	1.00	1.00	1.00	1.00	1.00	1.00	1.00	1.00	1.00
AdjDel/Veh:	53.7	31.6	31.6	57.9	32.5	32.0	59.9	60.1	68.0	47.1	50.8	45.4
LOS by Move:	D	C	C	E	C	C	E	E	E	D	D	D
HCM2k95thQ:	17	30	30	15	26	24	2	2	8	11	19	8

Note: Queue reported is the number of cars per lane.

BART Phase II Extension Project

Level Of Service Computation Report
2000 HCM Operations (Future Volume Alternative)
AM - 2025 Project Conditions

Intersection #3693: MERIDIAN/SAN CARLOS

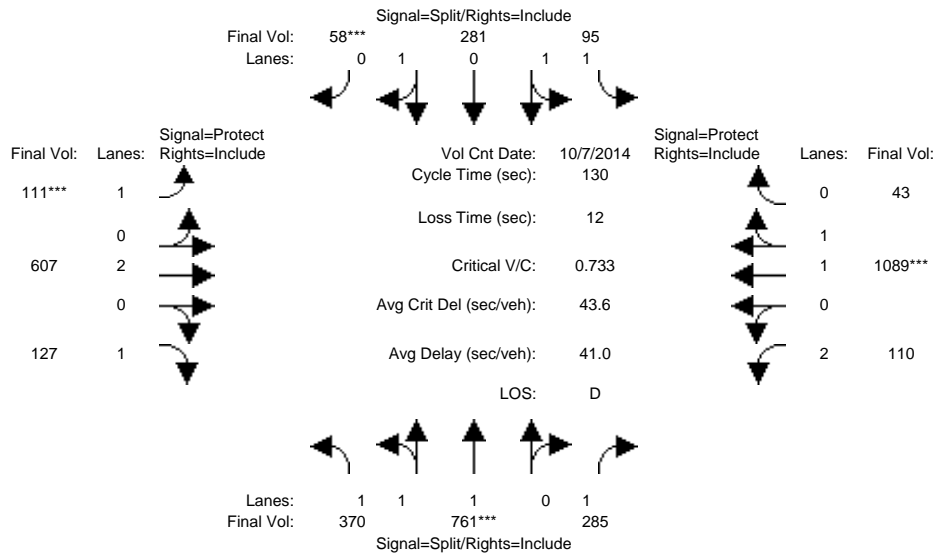

Approach:	North Bound			South Bound			East Bound			West Bound		
	L	T	R	L	T	R	L	T	R	L	T	R
Min. Green:	10	10	10	10	10	10	7	10	10	7	10	10
Y+R:	4.0	4.0	4.0	4.0	4.0	4.0	4.0	4.0	4.0	4.0	4.0	4.0

Volume Module:	>> Count Date: 7 Oct 2014 <<											
Base Vol:	370	761	285	95	281	58	111	607	127	110	1089	43
Growth Adj:	1.00	1.00	1.00	1.00	1.00	1.00	1.00	1.00	1.00	1.00	1.00	1.00
Initial Bse:	370	761	285	95	281	58	111	607	127	110	1089	43
Added Vol:	0	0	0	0	0	0	0	0	0	0	0	0
PasserByVol:	0	0	0	0	0	0	0	0	0	0	0	0
Initial Fut:	370	761	285	95	281	58	111	607	127	110	1089	43
User Adj:	1.00	1.00	1.00	1.00	1.00	1.00	1.00	1.00	1.00	1.00	1.00	1.00
PHF Adj:	1.00	1.00	1.00	1.00	1.00	1.00	1.00	1.00	1.00	1.00	1.00	1.00
PHF Volume:	370	761	285	95	281	58	111	607	127	110	1089	43
Reduct Vol:	0	0	0	0	0	0	0	0	0	0	0	0
Reduced Vol:	370	761	285	95	281	58	111	607	127	110	1089	43
PCE Adj:	1.00	1.00	1.00	1.00	1.00	1.00	1.00	1.00	1.00	1.00	1.00	1.00
MLF Adj:	1.00	1.00	1.00	1.00	1.00	1.00	1.00	1.00	1.00	1.00	1.00	1.00
FinalVolume:	370	761	285	95	281	58	111	607	127	110	1089	43

Saturation Flow Module:												
Sat/Lane:	1900	1900	1900	1900	1900	1900	1900	1900	1900	1900	1900	1900
Adjustment:	0.92	1.00	0.92	0.92	0.98	0.95	0.92	1.00	0.92	0.83	0.97	0.95
Lanes:	1.04	1.96	1.00	1.00	1.65	0.35	1.00	2.00	1.00	2.00	1.92	0.08
Final Sat.:	1814	3731	1750	1750	3066	633	1750	3800	1750	3150	3559	141

Capacity Analysis Module:												
Vol/Sat:	0.20	0.20	0.16	0.05	0.09	0.09	0.06	0.16	0.07	0.03	0.31	0.31
Crit Moves:	****					****	****			****		
Green Time:	36.2	36.2	36.2	16.3	16.3	16.3	11.3	49.0	49.0	16.5	54.3	54.3
Volume/Cap:	0.73	0.73	0.58	0.43	0.73	0.73	0.73	0.42	0.19	0.27	0.73	0.73
Delay/Veh:	44.4	44.4	42.3	52.9	59.5	59.5	74.6	30.2	27.3	51.7	33.6	33.6
User DelAdj:	1.00	1.00	1.00	1.00	1.00	1.00	1.00	1.00	1.00	1.00	1.00	1.00
AdjDel/Veh:	44.4	44.4	42.3	52.9	59.5	59.5	74.6	30.2	27.3	51.7	33.6	33.6
LOS by Move:	D	D	D	D	E	E	E	C	C	D	C	C
HCM2k95thQ:	25	25	19	7	13	13	10	16	7	5	33	33

Note: Queue reported is the number of cars per lane.

BART Phase II Extension Project

Level Of Service Computation Report
2000 HCM Operations (Future Volume Alternative)
PM - 2025 Project Conditions

Intersection #3693: MERIDIAN/SAN CARLOS

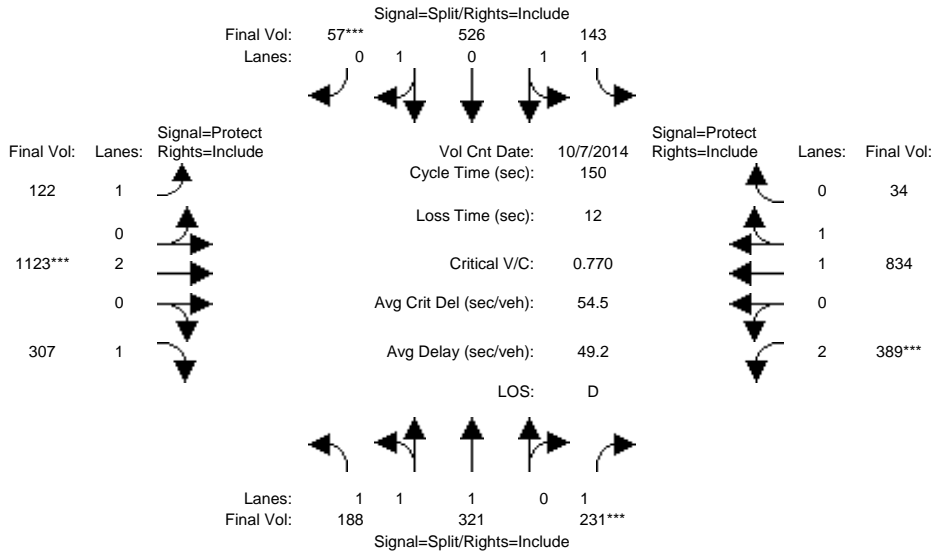

Approach:	North Bound			South Bound			East Bound			West Bound		
	L	T	R	L	T	R	L	T	R	L	T	R
Min. Green:	10	10	10	10	10	10	7	10	10	7	10	10
Y+R:	4.0	4.0	4.0	4.0	4.0	4.0	4.0	4.0	4.0	4.0	4.0	4.0
Volume Module: >> Count Date: 7 Oct 2014 <<												
Base Vol:	188	321	231	143	526	57	122	1123	307	389	834	34
Growth Adj:	1.00	1.00	1.00	1.00	1.00	1.00	1.00	1.00	1.00	1.00	1.00	1.00
Initial Bse:	188	321	231	143	526	57	122	1123	307	389	834	34
Added Vol:	0	0	0	0	0	0	0	0	0	0	0	0
PasserByVol:	0	0	0	0	0	0	0	0	0	0	0	0
Initial Fut:	188	321	231	143	526	57	122	1123	307	389	834	34
User Adj:	1.00	1.00	1.00	1.00	1.00	1.00	1.00	1.00	1.00	1.00	1.00	1.00
PHF Adj:	1.00	1.00	1.00	1.00	1.00	1.00	1.00	1.00	1.00	1.00	1.00	1.00
PHF Volume:	188	321	231	143	526	57	122	1123	307	389	834	34
Reduct Vol:	0	0	0	0	0	0	0	0	0	0	0	0
Reduced Vol:	188	321	231	143	526	57	122	1123	307	389	834	34
PCE Adj:	1.00	1.00	1.00	1.00	1.00	1.00	1.00	1.00	1.00	1.00	1.00	1.00
MLF Adj:	1.00	1.00	1.00	1.00	1.00	1.00	1.00	1.00	1.00	1.00	1.00	1.00
FinalVolume:	188	321	231	143	526	57	122	1123	307	389	834	34
Saturation Flow Module:												
Sat/Lane:	1900	1900	1900	1900	1900	1900	1900	1900	1900	1900	1900	1900
Adjustment:	0.92	0.98	0.92	0.92	0.98	0.95	0.92	1.00	0.92	0.83	0.97	0.95
Lanes:	1.15	1.85	1.00	1.00	1.80	0.20	1.00	2.00	1.00	2.00	1.92	0.08
Final Sat.:	2012	3435	1750	1750	3338	362	1750	3800	1750	3150	3555	145
Capacity Analysis Module:												
Vol/Sat:	0.09	0.09	0.13	0.08	0.16	0.16	0.07	0.30	0.18	0.12	0.23	0.23
Crit Moves:			****			****		****		****		
Green Time:	25.7	25.7	25.7	30.7	30.7	30.7	18.7	57.6	57.6	24.1	62.9	62.9
Volume/Cap:	0.55	0.55	0.77	0.40	0.77	0.77	0.56	0.77	0.46	0.77	0.56	0.56
Delay/Veh:	57.5	57.5	70.9	51.8	60.3	60.3	65.0	43.0	35.0	67.5	33.5	33.5
User DelAdj:	1.00	1.00	1.00	1.00	1.00	1.00	1.00	1.00	1.00	1.00	1.00	1.00
AdjDel/Veh:	57.5	57.5	70.9	51.8	60.3	60.3	65.0	43.0	35.0	67.5	33.5	33.5
LOS by Move:	E	E	E	D	E	E	E	D	D	E	C	C
HCM2k95thQ:	14	14	21	11	24	24	11	38	20	20	27	27

Note: Queue reported is the number of cars per lane.

BART Phase II Extension Project

Level Of Service Computation Report
2000 HCM Operations (Future Volume Alternative)
AM - 2025 Project Conditions

Intersection #3709: MONTGOMERY/PARK

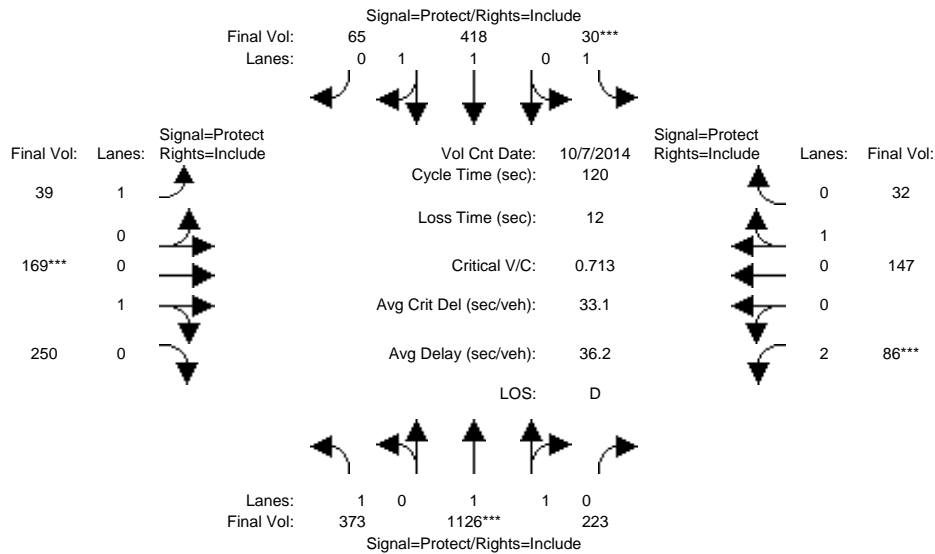

Approach:	North Bound			South Bound			East Bound			West Bound		
	L	T	R	L	T	R	L	T	R	L	T	R
Min. Green:	7	10	10	7	10	10	7	10	10	7	10	10
Y+R:	4.0	4.0	4.0	4.0	4.0	4.0	4.0	4.0	4.0	4.0	4.0	4.0

Volume Module:	>> Count Date: 7 Oct 2014 <<											
Base Vol:	373	1126	223	30	418	65	39	169	250	86	147	32
Growth Adj:	1.00	1.00	1.00	1.00	1.00	1.00	1.00	1.00	1.00	1.00	1.00	1.00
Initial Bse:	373	1126	223	30	418	65	39	169	250	86	147	32
Added Vol:	0	0	0	0	0	0	0	0	0	0	0	0
PasserByVol:	0	0	0	0	0	0	0	0	0	0	0	0
Initial Fut:	373	1126	223	30	418	65	39	169	250	86	147	32
User Adj:	1.00	1.00	1.00	1.00	1.00	1.00	1.00	1.00	1.00	1.00	1.00	1.00
PHF Adj:	1.00	1.00	1.00	1.00	1.00	1.00	1.00	1.00	1.00	1.00	1.00	1.00
PHF Volume:	373	1126	223	30	418	65	39	169	250	86	147	32
Reduct Vol:	0	0	0	0	0	0	0	0	0	0	0	0
Reduced Vol:	373	1126	223	30	418	65	39	169	250	86	147	32
PCE Adj:	1.00	1.00	1.00	1.00	1.00	1.00	1.00	1.00	1.00	1.00	1.00	1.00
MLF Adj:	1.00	1.00	1.00	1.00	1.00	1.00	1.00	1.00	1.00	1.00	1.00	1.00
FinalVolume:	373	1126	223	30	418	65	39	169	250	86	147	32

Saturation Flow Module:												
Sat/Lane:	1900	1900	1900	1900	1900	1900	1900	1900	1900	1900	1900	1900
Adjustment:	0.92	0.98	0.95	0.92	0.98	0.95	0.92	0.95	0.95	0.83	0.95	0.95
Lanes:	1.00	1.66	0.34	1.00	1.72	0.28	1.00	0.40	0.60	2.00	0.82	0.18
Final Sat.:	1750	3088	612	1750	3202	498	1750	726	1074	3150	1478	322

Capacity Analysis Module:												
Vol/Sat:	0.21	0.36	0.36	0.02	0.13	0.13	0.02	0.23	0.23	0.03	0.10	0.10
Crit Moves:	****	****	****	****	****	****	****	****	****	****	****	****
Green Time:	39.9	57.4	57.4	7.0	24.5	24.5	16.1	36.6	36.6	7.0	27.5	27.5
Volume/Cap:	0.64	0.76	0.76	0.29	0.64	0.64	0.17	0.76	0.76	0.47	0.43	0.43
Delay/Veh:	36.4	27.7	27.7	55.7	45.6	45.6	46.3	44.0	44.0	56.6	40.3	40.3
User DelAdj:	1.00	1.00	1.00	1.00	1.00	1.00	1.00	1.00	1.00	1.00	1.00	1.00
AdjDel/Veh:	36.4	27.7	27.7	55.7	45.6	45.6	46.3	44.0	44.0	56.6	40.3	40.3
LOS by Move:	D	C	C	E	D	D	D	D	D	E	D	D
HCM2k95thQ:	23	36	36	3	17	17	3	27	27	4	11	11

Note: Queue reported is the number of cars per lane.

BART Phase II Extension Project

Level Of Service Computation Report
2000 HCM Operations (Future Volume Alternative)
PM - 2025 Project Conditions

Intersection #3709: MONTGOMERY/PARK

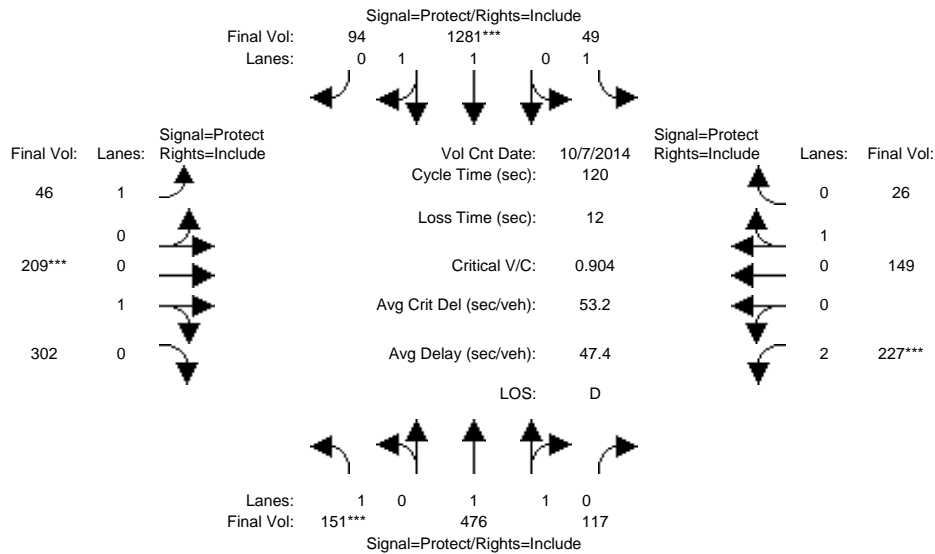

Approach:	North Bound			South Bound			East Bound			West Bound		
	L	T	R	L	T	R	L	T	R	L	T	R
Min. Green:	7	10	10	7	10	10	7	10	10	7	10	10
Y+R:	4.0	4.0	4.0	4.0	4.0	4.0	4.0	4.0	4.0	4.0	4.0	4.0

Volume Module:	>> Count Date: 7 Oct 2014 <<											
Base Vol:	151	476	117	49	1281	94	46	209	302	227	149	26
Growth Adj:	1.00	1.00	1.00	1.00	1.00	1.00	1.00	1.00	1.00	1.00	1.00	1.00
Initial Bse:	151	476	117	49	1281	94	46	209	302	227	149	26
Added Vol:	0	0	0	0	0	0	0	0	0	0	0	0
PasserByVol:	0	0	0	0	0	0	0	0	0	0	0	0
Initial Fut:	151	476	117	49	1281	94	46	209	302	227	149	26
User Adj:	1.00	1.00	1.00	1.00	1.00	1.00	1.00	1.00	1.00	1.00	1.00	1.00
PHF Adj:	1.00	1.00	1.00	1.00	1.00	1.00	1.00	1.00	1.00	1.00	1.00	1.00
PHF Volume:	151	476	117	49	1281	94	46	209	302	227	149	26
Reduct Vol:	0	0	0	0	0	0	0	0	0	0	0	0
Reduced Vol:	151	476	117	49	1281	94	46	209	302	227	149	26
PCE Adj:	1.00	1.00	1.00	1.00	1.00	1.00	1.00	1.00	1.00	1.00	1.00	1.00
MLF Adj:	1.00	1.00	1.00	1.00	1.00	1.00	1.00	1.00	1.00	1.00	1.00	1.00
FinalVolume:	151	476	117	49	1281	94	46	209	302	227	149	26

Saturation Flow Module:												
Sat/Lane:	1900	1900	1900	1900	1900	1900	1900	1900	1900	1900	1900	1900
Adjustment:	0.92	0.98	0.95	0.92	0.98	0.95	0.92	0.95	0.95	0.83	0.95	0.95
Lanes:	1.00	1.59	0.41	1.00	1.86	0.14	1.00	0.41	0.59	2.00	0.85	0.15
Final Sat.:	1750	2969	730	1750	3447	253	1750	736	1064	3150	1533	267

Capacity Analysis Module:												
Vol/Sat:	0.09	0.16	0.16	0.03	0.37	0.37	0.03	0.28	0.28	0.07	0.10	0.10
Crit Moves:	****			****			****			****		
Green Time:	11.4	44.6	44.6	16.2	49.3	49.3	17.7	37.7	37.7	9.6	29.5	29.5
Volume/Cap:	0.90	0.43	0.43	0.21	0.90	0.90	0.18	0.90	0.90	0.90	0.40	0.40
Delay/Veh:	96.8	28.5	28.5	46.6	41.1	41.1	45.1	57.4	57.4	87.4	38.4	38.4
User DelAdj:	1.00	1.00	1.00	1.00	1.00	1.00	1.00	1.00	1.00	1.00	1.00	1.00
AdjDel/Veh:	96.8	28.5	28.5	46.6	41.1	41.1	45.1	57.4	57.4	87.4	38.4	38.4
LOS by Move:	F	C	C	D	D	D	D	E	E	F	D	D
HCM2k95thQ:	13	15	15	4	45	45	3	35	35	11	11	11

Note: Queue reported is the number of cars per lane.

BART Phase II Extension Project

Level Of Service Computation Report
2000 HCM Operations (Future Volume Alternative)
AM - 2025 Project Conditions

Intersection #3710: MONTGOMERY/SAN FERNANDO

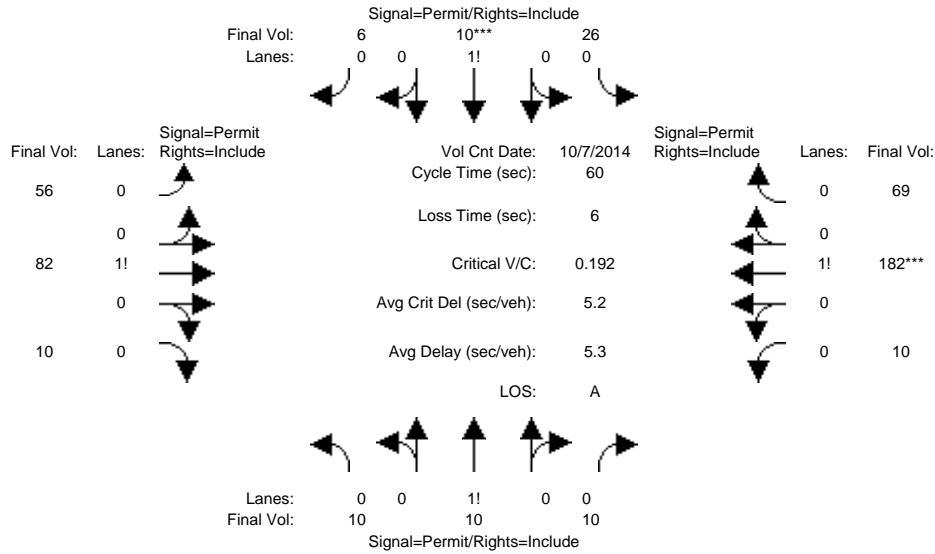

Approach:	North Bound			South Bound			East Bound			West Bound		
	L	T	R	L	T	R	L	T	R	L	T	R
Min. Green:	10	10	10	10	10	10	10	10	10	10	10	10
Y+R:	4.0	4.0	4.0	4.0	4.0	4.0	4.0	4.0	4.0	4.0	4.0	4.0

Volume Module:	>> Count Date: 7 Oct 2014 <<											
Base Vol:	10	10	10	26	10	6	56	82	10	10	182	69
Growth Adj:	1.00	1.00	1.00	1.00	1.00	1.00	1.00	1.00	1.00	1.00	1.00	1.00
Initial Bse:	10	10	10	26	10	6	56	82	10	10	182	69
Added Vol:	0	0	0	0	0	0	0	0	0	0	0	0
PasserByVol:	0	0	0	0	0	0	0	0	0	0	0	0
Initial Fut:	10	10	10	26	10	6	56	82	10	10	182	69
User Adj:	1.00	1.00	1.00	1.00	1.00	1.00	1.00	1.00	1.00	1.00	1.00	1.00
PHF Adj:	1.00	1.00	1.00	1.00	1.00	1.00	1.00	1.00	1.00	1.00	1.00	1.00
PHF Volume:	10	10	10	26	10	6	56	82	10	10	182	69
Reduct Vol:	0	0	0	0	0	0	0	0	0	0	0	0
Reduced Vol:	10	10	10	26	10	6	56	82	10	10	182	69
PCE Adj:	1.00	1.00	1.00	1.00	1.00	1.00	1.00	1.00	1.00	1.00	1.00	1.00
MLF Adj:	1.00	1.00	1.00	1.00	1.00	1.00	1.00	1.00	1.00	1.00	1.00	1.00
FinalVolume:	10	10	10	26	10	6	56	82	10	10	182	69

Saturation Flow Module:												
Sat/Lane:	1900	1900	1900	1900	1900	1900	1900	1900	1900	1900	1900	1900
Adjustment:	0.92	0.92	0.92	0.92	0.92	0.92	0.92	0.92	0.92	0.92	0.92	0.92
Lanes:	0.34	0.33	0.33	0.62	0.24	0.14	0.38	0.55	0.07	0.04	0.70	0.26
Final Sat.:	583	583	583	1083	417	250	662	970	118	67	1220	463

Capacity Analysis Module:												
Vol/Sat:	0.02	0.02	0.02	0.02	0.02	0.02	0.08	0.08	0.08	0.15	0.15	0.15
Crit Moves:				****						****		
Green Time:	10.0	10.0	10.0	10.0	10.0	10.0	44.0	44.0	44.0	44.0	44.0	44.0
Volume/Cap:	0.10	0.10	0.10	0.14	0.14	0.14	0.12	0.12	0.12	0.20	0.20	0.20
Delay/Veh:	21.4	21.4	21.4	21.6	21.6	21.6	2.4	2.4	2.4	2.6	2.6	2.6
User DelAdj:	1.00	1.00	1.00	1.00	1.00	1.00	1.00	1.00	1.00	1.00	1.00	1.00
AdjDel/Veh:	21.4	21.4	21.4	21.6	21.6	21.6	2.4	2.4	2.4	2.6	2.6	2.6
LOS by Move:	C	C	C	C	C	C	A	A	A	A	A	A
HCM2k95thQ:	1	1	1	1	1	1	2	2	2	3	3	3

Note: Queue reported is the number of cars per lane.

BART Phase II Extension Project

Level Of Service Computation Report
2000 HCM Operations (Future Volume Alternative)
PM - 2025 Project Conditions

Intersection #3710: MONTGOMERY/SAN FERNANDO

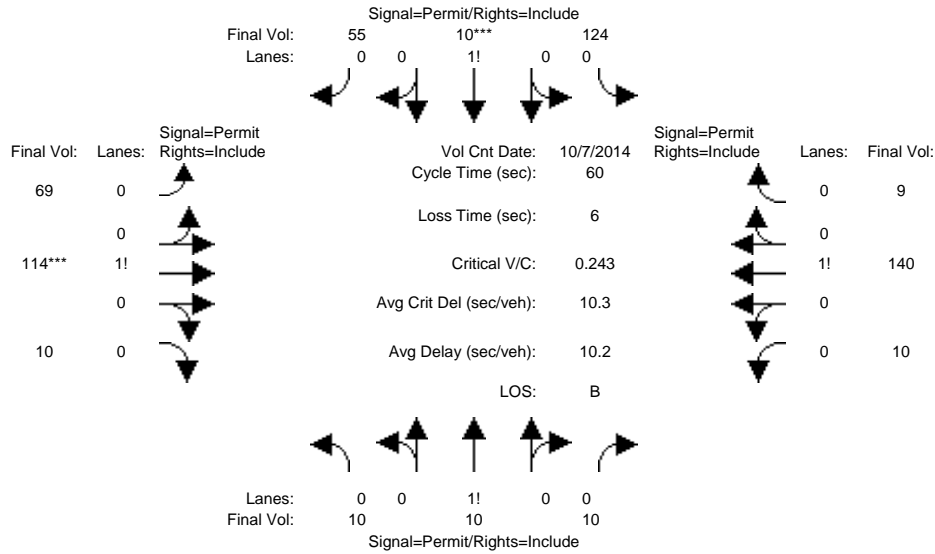

Approach:	North Bound			South Bound			East Bound			West Bound		
	L	T	R	L	T	R	L	T	R	L	T	R
Min. Green:	10	10	10	10	10	10	10	10	10	10	10	10
Y+R:	4.0	4.0	4.0	4.0	4.0	4.0	4.0	4.0	4.0	4.0	4.0	4.0
Volume Module: >> Count Date: 7 Oct 2014 <<												
Base Vol:	10	10	10	124	10	55	69	114	10	10	140	9
Growth Adj:	1.00	1.00	1.00	1.00	1.00	1.00	1.00	1.00	1.00	1.00	1.00	1.00
Initial Bse:	10	10	10	124	10	55	69	114	10	10	140	9
Added Vol:	0	0	0	0	0	0	0	0	0	0	0	0
PasserByVol:	0	0	0	0	0	0	0	0	0	0	0	0
Initial Fut:	10	10	10	124	10	55	69	114	10	10	140	9
User Adj:	1.00	1.00	1.00	1.00	1.00	1.00	1.00	1.00	1.00	1.00	1.00	1.00
PHF Adj:	1.00	1.00	1.00	1.00	1.00	1.00	1.00	1.00	1.00	1.00	1.00	1.00
PHF Volume:	10	10	10	124	10	55	69	114	10	10	140	9
Reduct Vol:	0	0	0	0	0	0	0	0	0	0	0	0
Reduced Vol:	10	10	10	124	10	55	69	114	10	10	140	9
PCE Adj:	1.00	1.00	1.00	1.00	1.00	1.00	1.00	1.00	1.00	1.00	1.00	1.00
MLF Adj:	1.00	1.00	1.00	1.00	1.00	1.00	1.00	1.00	1.00	1.00	1.00	1.00
FinalVolume:	10	10	10	124	10	55	69	114	10	10	140	9
Saturation Flow Module:												
Sat/Lane:	1900	1900	1900	1900	1900	1900	1900	1900	1900	1900	1900	1900
Adjustment:	0.92	0.92	0.92	0.92	0.92	0.92	0.92	0.92	0.92	0.92	0.92	0.92
Lanes:	0.34	0.33	0.33	0.66	0.05	0.29	0.36	0.59	0.05	0.06	0.88	0.06
Final Sat.:	583	583	583	1148	93	509	626	1034	91	110	1541	99
Capacity Analysis Module:												
Vol/Sat:	0.02	0.02	0.02	0.11	0.11	0.11	0.11	0.11	0.11	0.09	0.09	0.09
Crit Moves:				****				****				
Green Time:	26.7	26.7	26.7	26.7	26.7	26.7	27.3	27.3	27.3	27.3	27.3	27.3
Volume/Cap:	0.04	0.04	0.04	0.24	0.24	0.24	0.24	0.24	0.24	0.20	0.20	0.20
Delay/Veh:	9.4	9.4	9.4	10.5	10.5	10.5	10.2	10.2	10.2	9.9	9.9	9.9
User DelAdj:	1.00	1.00	1.00	1.00	1.00	1.00	1.00	1.00	1.00	1.00	1.00	1.00
AdjDel/Veh:	9.4	9.4	9.4	10.5	10.5	10.5	10.2	10.2	10.2	9.9	9.9	9.9
LOS by Move:	A	A	A	B	B	B	B	B	B	A	A	A
HCM2k95thQ:	1	1	1	5	5	5	5	5	5	4	4	4

Note: Queue reported is the number of cars per lane.

BART Phase II Extension Project

Level Of Service Computation Report
 2000 HCM Operations (Future Volume Alternative)
 AM - 2025 Project Conditions

Intersection #3748: RACE/SAN CARLOS

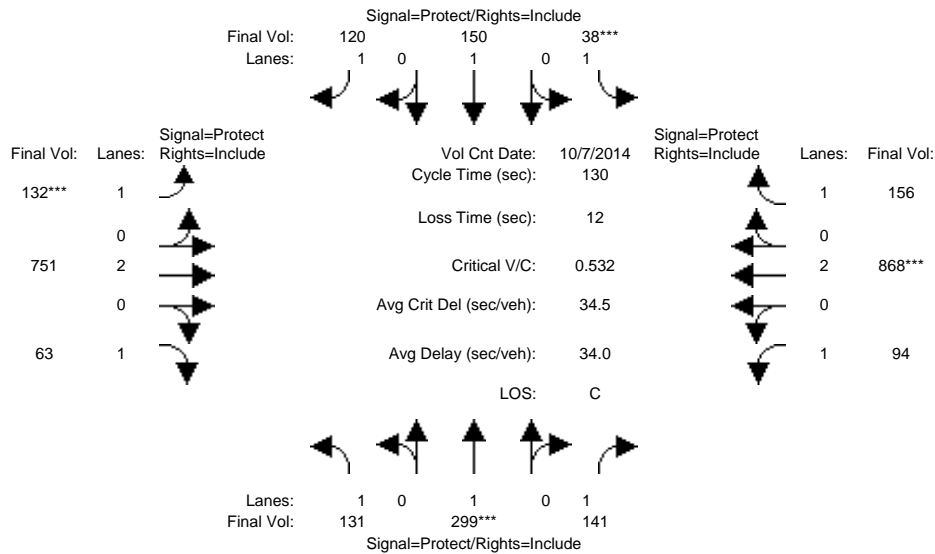

Approach:	North Bound			South Bound			East Bound			West Bound		
Movement:	L	T	R	L	T	R	L	T	R	L	T	R
Min. Green:	7	10	10	7	10	10	7	10	10	7	10	10
Y+R:	4.0	4.0	4.0	4.0	4.0	4.0	4.0	4.0	4.0	4.0	4.0	4.0
Volume Module: >> Count Date: 7 Oct 2014 <<												
Base Vol:	131	299	141	38	150	120	132	751	63	94	868	156
Growth Adj:	1.00	1.00	1.00	1.00	1.00	1.00	1.00	1.00	1.00	1.00	1.00	1.00
Initial Bse:	131	299	141	38	150	120	132	751	63	94	868	156
Added Vol:	0	0	0	0	0	0	0	0	0	0	0	0
PasserByVol:	0	0	0	0	0	0	0	0	0	0	0	0
Initial Fut:	131	299	141	38	150	120	132	751	63	94	868	156
User Adj:	1.00	1.00	1.00	1.00	1.00	1.00	1.00	1.00	1.00	1.00	1.00	1.00
PHF Adj:	1.00	1.00	1.00	1.00	1.00	1.00	1.00	1.00	1.00	1.00	1.00	1.00
PHF Volume:	131	299	141	38	150	120	132	751	63	94	868	156
Reduct Vol:	0	0	0	0	0	0	0	0	0	0	0	0
Reduced Vol:	131	299	141	38	150	120	132	751	63	94	868	156
PCE Adj:	1.00	1.00	1.00	1.00	1.00	1.00	1.00	1.00	1.00	1.00	1.00	1.00
MLF Adj:	1.00	1.00	1.00	1.00	1.00	1.00	1.00	1.00	1.00	1.00	1.00	1.00
FinalVolume:	131	299	141	38	150	120	132	751	63	94	868	156
Saturation Flow Module:												
Sat/Lane:	1900	1900	1900	1900	1900	1900	1900	1900	1900	1900	1900	1900
Adjustment:	0.92	1.00	0.92	0.92	1.00	0.92	0.92	1.00	0.92	0.92	1.00	0.92
Lanes:	1.00	1.00	1.00	1.00	1.00	1.00	1.00	2.00	1.00	1.00	2.00	1.00
Final Sat.:	1750	1900	1750	1750	1900	1750	1750	3800	1750	1750	3800	1750
Capacity Analysis Module:												
Vol/Sat:	0.07	0.16	0.08	0.02	0.08	0.07	0.08	0.20	0.04	0.05	0.23	0.09
Crit Moves:	****	****	****	****	****	****	****	****	****	****	****	****
Green Time:	21.8	37.9	37.9	7.0	23.0	23.0	18.2	57.5	57.5	15.7	55.0	55.0
Volume/Cap:	0.45	0.54	0.28	0.40	0.45	0.39	0.54	0.45	0.08	0.45	0.54	0.21
Delay/Veh:	49.7	39.8	35.8	62.3	48.7	48.1	54.5	25.4	21.0	54.6	28.4	23.9
User DelAdj:	1.00	1.00	1.00	1.00	1.00	1.00	1.00	1.00	1.00	1.00	1.00	1.00
AdjDel/Veh:	49.7	39.8	35.8	62.3	48.7	48.1	54.5	25.4	21.0	54.6	28.4	23.9
LOS by Move:	D	D	D	E	D	D	D	C	C	D	C	C
HCM2k95thQ:	10	18	9	3	10	9	10	19	3	7	23	8

Note: Queue reported is the number of cars per lane.

BART Phase II Extension Project

Level Of Service Computation Report
2000 HCM Operations (Future Volume Alternative)
PM - 2025 Project Conditions

Intersection #3748: RACE/SAN CARLOS

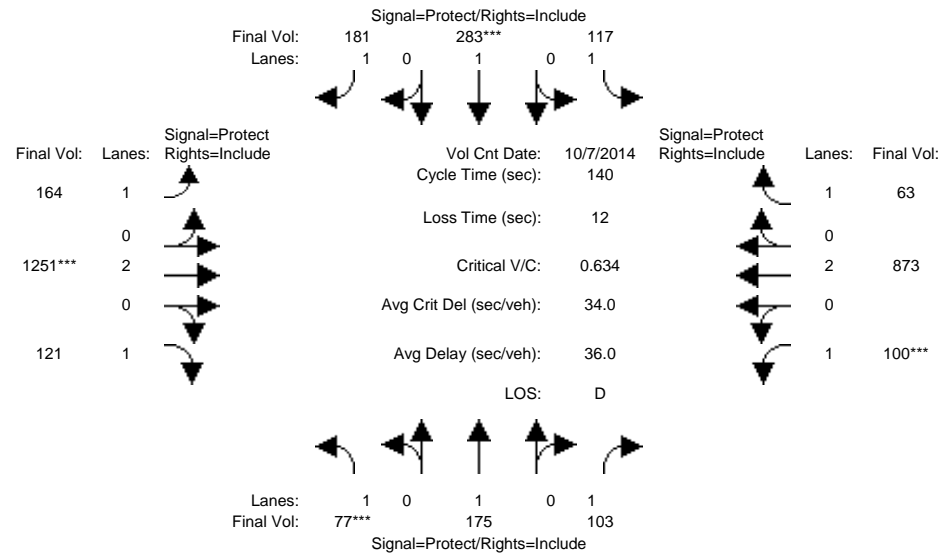

Approach:	North Bound			South Bound			East Bound			West Bound		
	L	T	R	L	T	R	L	T	R	L	T	R
Min. Green:	7	10	10	7	10	10	7	10	10	7	10	10
Y+R:	4.0	4.0	4.0	4.0	4.0	4.0	4.0	4.0	4.0	4.0	4.0	4.0
Volume Module: >> Count Date: 7 Oct 2014 <<												
Base Vol:	77	175	103	117	283	181	164	1251	121	100	873	63
Growth Adj:	1.00	1.00	1.00	1.00	1.00	1.00	1.00	1.00	1.00	1.00	1.00	1.00
Initial Bse:	77	175	103	117	283	181	164	1251	121	100	873	63
Added Vol:	0	0	0	0	0	0	0	0	0	0	0	0
PasserByVol:	0	0	0	0	0	0	0	0	0	0	0	0
Initial Fut:	77	175	103	117	283	181	164	1251	121	100	873	63
User Adj:	1.00	1.00	1.00	1.00	1.00	1.00	1.00	1.00	1.00	1.00	1.00	1.00
PHF Adj:	1.00	1.00	1.00	1.00	1.00	1.00	1.00	1.00	1.00	1.00	1.00	1.00
PHF Volume:	77	175	103	117	283	181	164	1251	121	100	873	63
Reduct Vol:	0	0	0	0	0	0	0	0	0	0	0	0
Reduced Vol:	77	175	103	117	283	181	164	1251	121	100	873	63
PCE Adj:	1.00	1.00	1.00	1.00	1.00	1.00	1.00	1.00	1.00	1.00	1.00	1.00
MLF Adj:	1.00	1.00	1.00	1.00	1.00	1.00	1.00	1.00	1.00	1.00	1.00	1.00
FinalVolume:	77	175	103	117	283	181	164	1251	121	100	873	63
Saturation Flow Module:												
Sat/Lane:	1900	1900	1900	1900	1900	1900	1900	1900	1900	1900	1900	1900
Adjustment:	0.92	1.00	0.92	0.92	1.00	0.92	0.92	1.00	0.92	0.92	1.00	0.92
Lanes:	1.00	1.00	1.00	1.00	1.00	1.00	1.00	2.00	1.00	1.00	2.00	1.00
Final Sat.:	1750	1900	1750	1750	1900	1750	1750	3800	1750	1750	3800	1750
Capacity Analysis Module:												
Vol/Sat:	0.04	0.09	0.06	0.07	0.15	0.10	0.09	0.33	0.07	0.06	0.23	0.04
Crit Moves:	****				****			****			****	
Green Time:	9.7	24.7	24.7	17.9	32.9	32.9	24.7	72.7	72.7	12.6	60.6	60.6
Volume/Cap:	0.63	0.52	0.33	0.52	0.63	0.44	0.53	0.63	0.13	0.63	0.53	0.08
Delay/Veh:	73.9	53.8	51.1	59.2	51.1	46.4	54.1	24.8	17.4	69.6	29.5	23.4
User DelAdj:	1.00	1.00	1.00	1.00	1.00	1.00	1.00	1.00	1.00	1.00	1.00	1.00
AdjDel/Veh:	73.9	53.8	51.1	59.2	51.1	46.4	54.1	24.8	17.4	69.6	29.5	23.4
LOS by Move:	E	D	D	E	D	D	D	C	B	E	C	C
HCM2k95thQ:	7	13	8	10	20	13	13	32	6	9	24	3

Note: Queue reported is the number of cars per lane.

BART Phase II Extension Project

Level Of Service Computation Report
 2000 HCM Operations (Future Volume Alternative)
 AM - 2025 Project Conditions

Intersection #3985: DELMAS/SAN FERNANDO

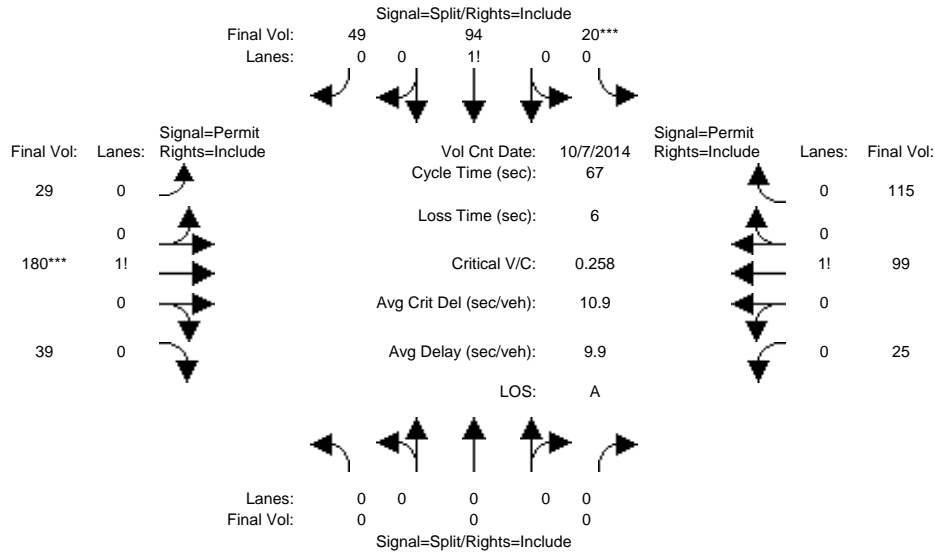

Approach:	North Bound			South Bound			East Bound			West Bound		
	L	T	R	L	T	R	L	T	R	L	T	R
Min. Green:	0	0	0	10	10	10	10	10	10	10	10	10
Y+R:	4.0	4.0	4.0	4.0	4.0	4.0	4.0	4.0	4.0	4.0	4.0	4.0

Volume Module:	>>	Count	Date:	7 Oct 2014	<<							
Base Vol:	0	0	0	20	94	49	29	180	39	25	99	115
Growth Adj:	1.00	1.00	1.00	1.00	1.00	1.00	1.00	1.00	1.00	1.00	1.00	1.00
Initial Bse:	0	0	0	20	94	49	29	180	39	25	99	115
Added Vol:	0	0	0	0	0	0	0	0	0	0	0	0
PasserByVol:	0	0	0	0	0	0	0	0	0	0	0	0
Initial Fut:	0	0	0	20	94	49	29	180	39	25	99	115
User Adj:	1.00	1.00	1.00	1.00	1.00	1.00	1.00	1.00	1.00	1.00	1.00	1.00
PHF Adj:	1.00	1.00	1.00	1.00	1.00	1.00	1.00	1.00	1.00	1.00	1.00	1.00
PHF Volume:	0	0	0	20	94	49	29	180	39	25	99	115
Reduct Vol:	0	0	0	0	0	0	0	0	0	0	0	0
Reduced Vol:	0	0	0	20	94	49	29	180	39	25	99	115
PCE Adj:	1.00	1.00	1.00	1.00	1.00	1.00	1.00	1.00	1.00	1.00	1.00	1.00
MLF Adj:	1.00	1.00	1.00	1.00	1.00	1.00	1.00	1.00	1.00	1.00	1.00	1.00
FinalVolume:	0	0	0	20	94	49	29	180	39	25	99	115

Saturation Flow Module:	Sat/Lane:	1900	1900	1900	1900	1900	1900	1900	1900	1900	1900	1900
Adjustment:	0.92	1.00	0.92	0.92	0.92	0.92	0.92	0.92	0.92	0.92	0.92	0.92
Lanes:	0.00	0.00	0.00	0.12	0.58	0.30	0.12	0.72	0.16	0.10	0.41	0.49
Final Sat.:	0	0	0	215	1009	526	205	1270	275	183	725	842

Capacity Analysis Module:	Vol/Sat:	0.00	0.00	0.00	0.09	0.09	0.09	0.14	0.14	0.14	0.14	0.14
Crit Moves:				****				****				
Green Time:	0.0	0.0	0.0	24.2	24.2	24.2	36.8	36.8	36.8	36.8	36.8	36.8
Volume/Cap:	0.00	0.00	0.00	0.26	0.26	0.26	0.26	0.26	0.26	0.25	0.25	0.25
Delay/Veh:	0.0	0.0	0.0	15.3	15.3	15.3	8.1	8.1	8.1	8.0	8.0	8.0
User DelAdj:	1.00	1.00	1.00	1.00	1.00	1.00	1.00	1.00	1.00	1.00	1.00	1.00
AdjDel/Veh:	0.0	0.0	0.0	15.3	15.3	15.3	8.1	8.1	8.1	8.0	8.0	8.0
LOS by Move:	A	A	A	B	B	B	A	A	A	A	A	A
HCM2k95thQ:	0	0	0	5	5	5	6	6	6	5	5	5

Note: Queue reported is the number of cars per lane.

BART Phase II Extension Project

Level Of Service Computation Report
2000 HCM Operations (Future Volume Alternative)
PM - 2025 Project Conditions

Intersection #3985: DELMAS/SAN FERNANDO

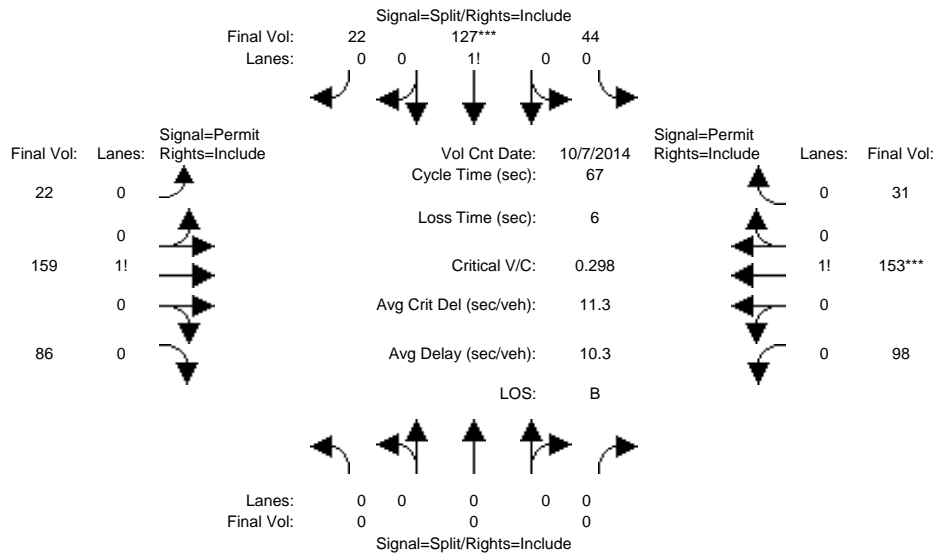

Approach:	North Bound			South Bound			East Bound			West Bound		
	L	T	R	L	T	R	L	T	R	L	T	R
Min. Green:	0	0	0	10	10	10	10	10	10	10	10	10
Y+R:	4.0	4.0	4.0	4.0	4.0	4.0	4.0	4.0	4.0	4.0	4.0	4.0
Volume Module: >> Count Date: 7 Oct 2014 <<												
Base Vol:	0	0	0	44	127	22	22	159	86	98	153	31
Growth Adj:	1.00	1.00	1.00	1.00	1.00	1.00	1.00	1.00	1.00	1.00	1.00	1.00
Initial Bse:	0	0	0	44	127	22	22	159	86	98	153	31
Added Vol:	0	0	0	0	0	0	0	0	0	0	0	0
PasserByVol:	0	0	0	0	0	0	0	0	0	0	0	0
Initial Fut:	0	0	0	44	127	22	22	159	86	98	153	31
User Adj:	1.00	1.00	1.00	1.00	1.00	1.00	1.00	1.00	1.00	1.00	1.00	1.00
PHF Adj:	1.00	1.00	1.00	1.00	1.00	1.00	1.00	1.00	1.00	1.00	1.00	1.00
PHF Volume:	0	0	0	44	127	22	22	159	86	98	153	31
Reduct Vol:	0	0	0	0	0	0	0	0	0	0	0	0
Reduced Vol:	0	0	0	44	127	22	22	159	86	98	153	31
PCE Adj:	1.00	1.00	1.00	1.00	1.00	1.00	1.00	1.00	1.00	1.00	1.00	1.00
MLF Adj:	1.00	1.00	1.00	1.00	1.00	1.00	1.00	1.00	1.00	1.00	1.00	1.00
FinalVolume:	0	0	0	44	127	22	22	159	86	98	153	31
Saturation Flow Module:												
Sat/Lane:	1900	1900	1900	1900	1900	1900	1900	1900	1900	1900	1900	1900
Adjustment:	0.92	1.00	0.92	0.92	0.92	0.92	0.92	0.92	0.92	0.92	0.92	0.92
Lanes:	0.00	0.00	0.00	0.23	0.66	0.11	0.08	0.60	0.32	0.35	0.54	0.11
Final Sat.:	0	0	0	399	1152	199	144	1042	564	608	949	192
Capacity Analysis Module:												
Vol/Sat:	0.00	0.00	0.00	0.11	0.11	0.11	0.15	0.15	0.15	0.16	0.16	0.16
Crit Moves:				****						****		
Green Time:	0.0	0.0	0.0	24.8	24.8	24.8	36.2	36.2	36.2	36.2	36.2	36.2
Volume/Cap:	0.00	0.00	0.00	0.30	0.30	0.30	0.28	0.28	0.28	0.30	0.30	0.30
Delay/Veh:	0.0	0.0	0.0	15.2	15.2	15.2	8.5	8.5	8.5	8.6	8.6	8.6
User DelAdj:	1.00	1.00	1.00	1.00	1.00	1.00	1.00	1.00	1.00	1.00	1.00	1.00
AdjDel/Veh:	0.0	0.0	0.0	15.2	15.2	15.2	8.5	8.5	8.5	8.6	8.6	8.6
LOS by Move:	A	A	A	B	B	B	A	A	A	A	A	A
HCM2k95thQ:	0	0	0	6	6	6	6	6	6	7	7	7

Note: Queue reported is the number of cars per lane.

BART Phase II Extension Project

Level Of Service Computation Report
 2000 HCM Operations (Future Volume Alternative)
 AM - 2035 No Project Conditions

Intersection #3013: 87/JULIAN (E) *

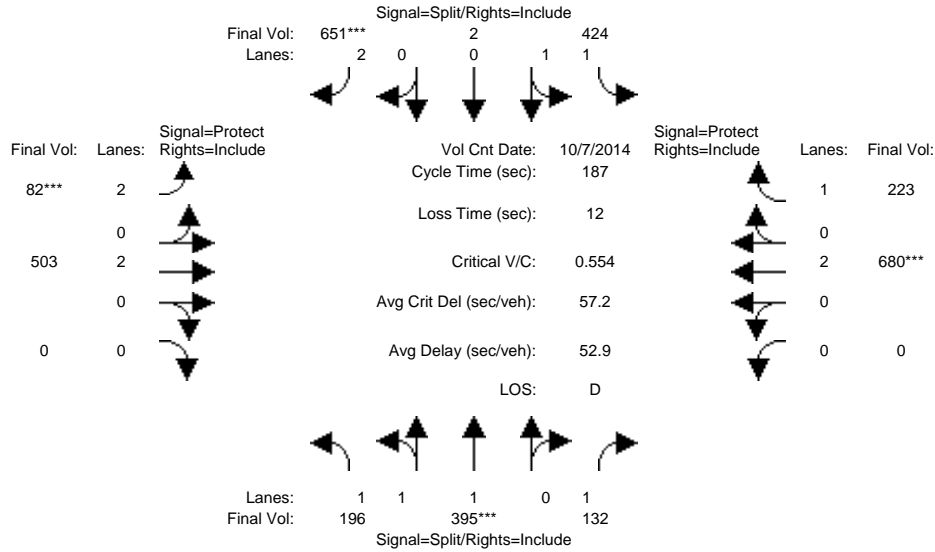

Approach:	North Bound			South Bound			East Bound			West Bound		
	L	T	R	L	T	R	L	T	R	L	T	R
Min. Green:	10	10	10	10	10	10	7	10	0	0	10	10
Y+R:	4.0	4.0	4.0	4.0	4.0	4.0	4.0	4.0	4.0	4.0	4.0	4.0

Volume Module:	>>	Count	Date:	7 Oct 2014	<<							
Base Vol:	196	395	132	424	2	651	82	503	0	0	680	223
Growth Adj:	1.00	1.00	1.00	1.00	1.00	1.00	1.00	1.00	1.00	1.00	1.00	1.00
Initial Bse:	196	395	132	424	2	651	82	503	0	0	680	223
Added Vol:	0	0	0	0	0	0	0	0	0	0	0	0
PasserByVol:	0	0	0	0	0	0	0	0	0	0	0	0
Initial Fut:	196	395	132	424	2	651	82	503	0	0	680	223
User Adj:	1.00	1.00	1.00	1.00	1.00	1.00	1.00	1.00	1.00	1.00	1.00	1.00
PHF Adj:	1.00	1.00	1.00	1.00	1.00	1.00	1.00	1.00	1.00	1.00	1.00	1.00
PHF Volume:	196	395	132	424	2	651	82	503	0	0	680	223
Reduct Vol:	0	0	0	0	0	0	0	0	0	0	0	0
Reduced Vol:	196	395	132	424	2	651	82	503	0	0	680	223
PCE Adj:	1.00	1.00	1.00	1.00	1.00	1.00	1.00	1.00	1.00	1.00	1.00	1.00
MLF Adj:	1.00	1.00	1.00	1.00	1.00	1.00	1.00	1.00	1.00	1.00	1.00	1.00
Final Volume:	196	395	132	424	2	651	82	503	0	0	680	223

Saturation Flow Module:												
Sat/Lane:	1900	1900	1900	1900	1900	1900	1900	1900	1900	1900	1900	1900
Adjustment:	0.92	1.00	0.92	0.93	0.95	0.83	0.83	1.00	0.92	0.92	1.00	0.92
Lanes:	1.05	1.95	1.00	1.99	0.01	2.00	2.00	2.00	0.00	0.00	2.00	1.00
Final Sat.:	1838	3704	1750	3533	17	3150	3150	3800	0	0	3800	1750

Capacity Analysis Module:												
Vol/Sat:	0.11	0.11	0.08	0.12	0.12	0.21	0.03	0.13	0.00	0.00	0.18	0.13
Crit Moves:	****			****			****			****		
Green Time:	36.0	36.0	36.0	69.8	69.8	69.8	8.8	69.2	0.0	0.0	60.4	60.4
Volume/Cap:	0.55	0.55	0.39	0.32	0.32	0.55	0.55	0.36	0.00	0.00	0.55	0.39
Delay/Veh:	68.9	68.9	66.7	41.9	41.9	46.9	91.7	42.9	0.0	0.0	52.7	49.6
User DelAdj:	1.00	1.00	1.00	1.00	1.00	1.00	1.00	1.00	1.00	1.00	1.00	1.00
AdjDel/Veh:	68.9	68.9	66.7	41.9	41.9	46.9	91.7	42.9	0.0	0.0	52.7	49.6
LOS by Move:	E	E	E	D	D	D	F	D	A	A	D	D
HCM2k95thQ:	19	19	13	17	17	30	6	18	0	0	28	19

Note: Queue reported is the number of cars per lane.

BART Phase II Extension Project

Level Of Service Computation Report
2000 HCM Operations (Future Volume Alternative)
PM - 2035 No Project Conditions

Intersection #3013: 87/JULIAN (E) *

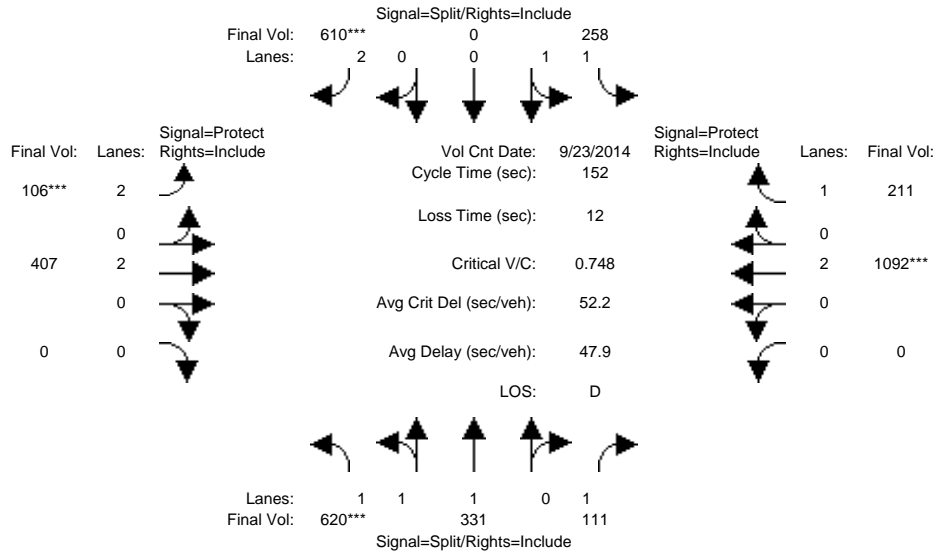

Approach:	North Bound			South Bound			East Bound			West Bound		
	L	T	R	L	T	R	L	T	R	L	T	R
Min. Green:	10	10	10	10	10	10	7	10	0	0	10	10
Y+R:	4.0	4.0	4.0	4.0	4.0	4.0	4.0	4.0	4.0	4.0	4.0	4.0
Volume Module: >> Count Date: 23 Sep 2014 <<												
Base Vol:	620	331	111	258	0	610	106	407	0	0	1092	211
Growth Adj:	1.00	1.00	1.00	1.00	1.00	1.00	1.00	1.00	1.00	1.00	1.00	1.00
Initial Bse:	620	331	111	258	0	610	106	407	0	0	1092	211
Added Vol:	0	0	0	0	0	0	0	0	0	0	0	0
PasserByVol:	0	0	0	0	0	0	0	0	0	0	0	0
Initial Fut:	620	331	111	258	0	610	106	407	0	0	1092	211
User Adj:	1.00	1.00	1.00	1.00	1.00	1.00	1.00	1.00	1.00	1.00	1.00	1.00
PHF Adj:	1.00	1.00	1.00	1.00	1.00	1.00	1.00	1.00	1.00	1.00	1.00	1.00
PHF Volume:	620	331	111	258	0	610	106	407	0	0	1092	211
Reduct Vol:	0	0	0	0	0	0	0	0	0	0	0	0
Reduced Vol:	620	331	111	258	0	610	106	407	0	0	1092	211
PCE Adj:	1.00	1.00	1.00	1.00	1.00	1.00	1.00	1.00	1.00	1.00	1.00	1.00
MLF Adj:	1.00	1.00	1.00	1.00	1.00	1.00	1.00	1.00	1.00	1.00	1.00	1.00
FinalVolume:	620	331	111	258	0	610	106	407	0	0	1092	211
Saturation Flow Module:												
Sat/Lane:	1900	1900	1900	1900	1900	1900	1900	1900	1900	1900	1900	1900
Adjustment:	0.93	1.00	0.92	0.93	1.00	0.83	0.83	1.00	0.92	0.92	1.00	0.92
Lanes:	2.00	1.00	1.00	2.00	0.00	2.00	2.00	2.00	0.00	0.00	2.00	1.00
Final Sat.:	3549	1896	1750	3550	0	3150	3150	3800	0	0	3800	1750
Capacity Analysis Module:												
Vol/Sat:	0.17	0.17	0.06	0.07	0.00	0.19	0.03	0.11	0.00	0.00	0.29	0.12
Crit Moves:	****					****	****				****	
Green Time:	35.4	35.4	35.4	39.3	0.0	39.3	7.0	65.3	0.0	0.0	58.3	58.3
Volume/Cap:	0.75	0.75	0.27	0.28	0.00	0.75	0.73	0.25	0.00	0.00	0.75	0.31
Delay/Veh:	56.7	56.7	48.1	45.2	0.0	55.7	88.8	27.8	0.0	0.0	42.7	33.1
User DelAdj:	1.00	1.00	1.00	1.00	1.00	1.00	1.00	1.00	1.00	1.00	1.00	1.00
AdjDel/Veh:	56.7	56.7	48.1	45.2	0.0	55.7	88.8	27.8	0.0	0.0	42.7	33.1
LOS by Move:	E	E	D	D	A	E	F	C	A	A	D	C
HCM2k95thQ:	26	26	9	10	0	29	6	11	0	0	38	14

Note: Queue reported is the number of cars per lane.

BART Phase II Extension Project

Level Of Service Computation Report
 2000 HCM Operations (Future Volume Alternative)
 AM - 2035 No Project Conditions

Intersection #3014: 87/JULIAN (W)

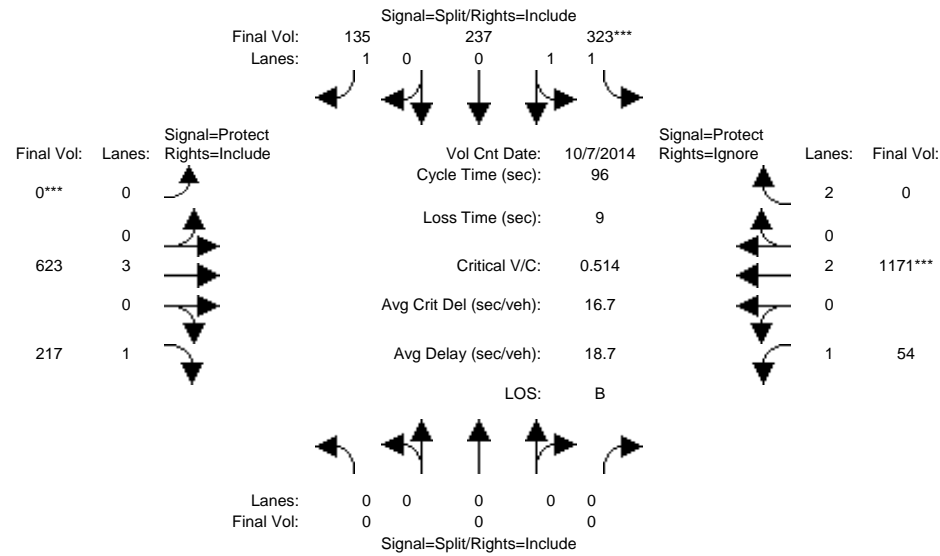

Approach:	North Bound			South Bound			East Bound			West Bound		
	L	T	R	L	T	R	L	T	R	L	T	R
Min. Green:	0	0	0	10	10	10	0	10	10	7	10	10
Y+R:	4.0	4.0	4.0	4.0	4.0	4.0	4.0	4.0	4.0	4.0	4.0	4.0

Volume Module:	>>	Count	Date:	7 Oct 2014	<<							
Base Vol:	0	0	0	323	237	135	0	623	217	54	1171	0
Growth Adj:	1.00	1.00	1.00	1.00	1.00	1.00	1.00	1.00	1.00	1.00	1.00	1.00
Initial Bse:	0	0	0	323	237	135	0	623	217	54	1171	0
Added Vol:	0	0	0	0	0	0	0	0	0	0	0	0
PasserByVol:	0	0	0	0	0	0	0	0	0	0	0	0
Initial Fut:	0	0	0	323	237	135	0	623	217	54	1171	0
User Adj:	1.00	1.00	1.00	1.00	1.00	1.00	1.00	1.00	1.00	1.00	1.00	0.00
PHF Adj:	1.00	1.00	1.00	1.00	1.00	1.00	1.00	1.00	1.00	1.00	1.00	0.00
PHF Volume:	0	0	0	323	237	135	0	623	217	54	1171	0
Reduct Vol:	0	0	0	0	0	0	0	0	0	0	0	0
Reduced Vol:	0	0	0	323	237	135	0	623	217	54	1171	0
PCE Adj:	1.00	1.00	1.00	1.00	1.00	1.00	1.00	1.00	1.00	1.00	1.00	0.00
MLF Adj:	1.00	1.00	1.00	1.00	1.00	1.00	1.00	1.00	1.00	1.00	1.00	0.00
FinalVolume:	0	0	0	323	237	135	0	623	217	54	1171	0

Saturation Flow Module:	Sat/Lane:	1900	1900	1900	1900	1900	1900	1900	1900	1900	1900	1900
Adjustment:	0.92	1.00	0.92	0.92	0.95	0.92	0.92	1.00	0.92	0.92	1.00	0.83
Lanes:	0.00	0.00	0.00	1.17	0.83	1.00	0.00	3.00	1.00	1.00	2.00	2.00
Final Sat.:	0	0	0	2047	1502	1750	0	5700	1750	1750	3800	3150

Capacity Analysis Module:	Vol/Sat:	0.00	0.00	0.00	0.16	0.16	0.08	0.00	0.11	0.12	0.03	0.31	0.00
Crit Moves:	****	****	****	****	****	****	****	****	****	****	****	****	****
Green Time:	0.0	0.0	0.0	29.5	29.5	29.5	0.0	36.2	36.2	21.3	57.5	0.0	
Volume/Cap:	0.00	0.00	0.00	0.51	0.51	0.25	0.00	0.29	0.33	0.14	0.51	0.00	
Delay/Veh:	0.0	0.0	0.0	27.8	27.8	25.2	0.0	21.0	21.5	30.1	11.3	0.0	
User DelAdj:	1.00	1.00	1.00	1.00	1.00	1.00	1.00	1.00	1.00	1.00	1.00	1.00	
AdjDel/Veh:	0.0	0.0	0.0	27.8	27.8	25.2	0.0	21.0	21.5	30.1	11.3	0.0	
LOS by Move:	A	A	A	C	C	C	A	C	C	C	B	A	
HCM2k95thQ:	0	0	0	14	14	7	0	8	9	3	18	0	

Note: Queue reported is the number of cars per lane.

BART Phase II Extension Project

Level Of Service Computation Report
 2000 HCM Operations (Future Volume Alternative)
 PM - 2035 No Project Conditions

Intersection #3014: 87/JULIAN (W)

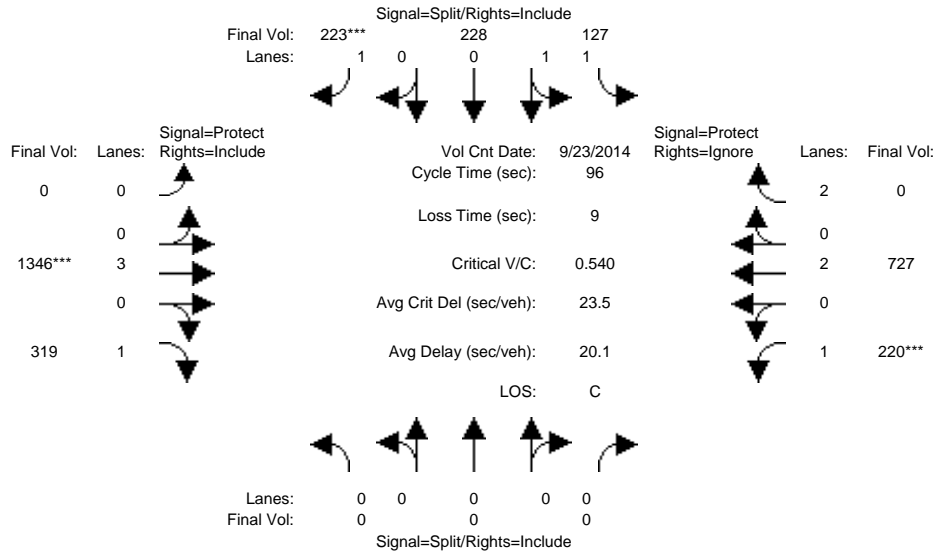

Approach:	North Bound			South Bound			East Bound			West Bound		
	L	T	R	L	T	R	L	T	R	L	T	R
Min. Green:	0	0	0	10	10	10	0	10	10	7	10	10
Y+R:	4.0	4.0	4.0	4.0	4.0	4.0	4.0	4.0	4.0	4.0	4.0	4.0

Volume Module:	>>	Count	Date:	23 Sep 2014	<<							
Base Vol:	0	0	0	127	228	223	0	1346	319	220	727	0
Growth Adj:	1.00	1.00	1.00	1.00	1.00	1.00	1.00	1.00	1.00	1.00	1.00	1.00
Initial Bse:	0	0	0	127	228	223	0	1346	319	220	727	0
Added Vol:	0	0	0	0	0	0	0	0	0	0	0	0
PasserByVol:	0	0	0	0	0	0	0	0	0	0	0	0
Initial Fut:	0	0	0	127	228	223	0	1346	319	220	727	0
User Adj:	1.00	1.00	1.00	1.00	1.00	1.00	1.00	1.00	1.00	1.00	1.00	0.00
PHF Adj:	1.00	1.00	1.00	1.00	1.00	1.00	1.00	1.00	1.00	1.00	1.00	0.00
PHF Volume:	0	0	0	127	228	223	0	1346	319	220	727	0
Reduct Vol:	0	0	0	0	0	0	0	0	0	0	0	0
Reduced Vol:	0	0	0	127	228	223	0	1346	319	220	727	0
PCE Adj:	1.00	1.00	1.00	1.00	1.00	1.00	1.00	1.00	1.00	1.00	1.00	0.00
MLF Adj:	1.00	1.00	1.00	1.00	1.00	1.00	1.00	1.00	1.00	1.00	1.00	0.00
FinalVolume:	0	0	0	127	228	223	0	1346	319	220	727	0

Saturation Flow Module:												
Sat/Lane:	1900	1900	1900	1900	1900	1900	1900	1900	1900	1900	1900	1900
Adjustment:	0.92	1.00	0.92	0.92	1.00	0.92	0.92	1.00	0.92	0.92	1.00	0.83
Lanes:	0.00	0.00	0.00	1.00	1.00	1.00	0.00	3.00	1.00	1.00	2.00	2.00
Final Sat.:	0	0	0	1750	1900	1750	0	5700	1750	1750	3800	3150

Capacity Analysis Module:												
Vol/Sat:	0.00	0.00	0.00	0.07	0.12	0.13	0.00	0.24	0.18	0.13	0.19	0.00
Crit Moves:						****		****		****		
Green Time:	0.0	0.0	0.0	22.7	22.7	22.7	0.0	42.0	42.0	22.4	64.3	0.0
Volume/Cap:	0.00	0.00	0.00	0.31	0.51	0.54	0.00	0.54	0.42	0.54	0.29	0.00
Delay/Veh:	0.0	0.0	0.0	30.4	32.5	33.5	0.0	20.1	19.0	33.8	6.5	0.0
User DelAdj:	1.00	1.00	1.00	1.00	1.00	1.00	1.00	1.00	1.00	1.00	1.00	1.00
AdjDel/Veh:	0.0	0.0	0.0	30.4	32.5	33.5	0.0	20.1	19.0	33.8	6.5	0.0
LOS by Move:	A	A	A	C	C	C	A	C	B	C	A	A
HCM2k95thQ:	0	0	0	7	12	13	0	17	12	11	8	0

Note: Queue reported is the number of cars per lane.

BART Phase II Extension Project

Level Of Service Computation Report
 2000 HCM Operations (Future Volume Alternative)
 AM - 2035 No Project Conditions

Intersection #3015: 87/SANTA CLARA

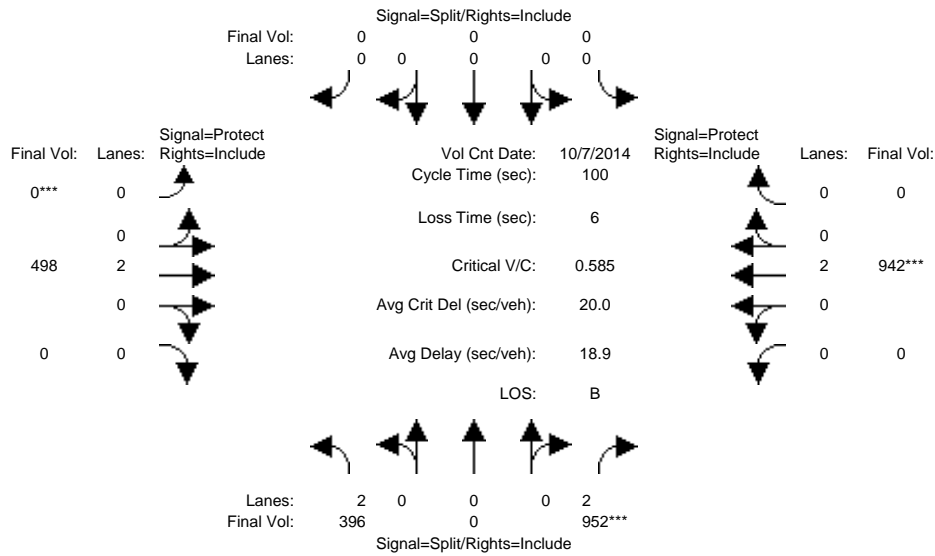

Approach:	North Bound			South Bound			East Bound			West Bound		
Movement:	L	T	R	L	T	R	L	T	R	L	T	R
Min. Green:	10	0	10	0	0	0	0	10	0	0	10	0
Y+R:	4.0	4.0	4.0	4.0	4.0	4.0	4.0	4.0	4.0	4.0	4.0	4.0
Volume Module: >> Count Date: 7 Oct 2014 <<												
Base Vol:	396	0	952	0	0	0	0	498	0	0	942	0
Growth Adj:	1.00	1.00	1.00	1.00	1.00	1.00	1.00	1.00	1.00	1.00	1.00	1.00
Initial Bse:	396	0	952	0	0	0	0	498	0	0	942	0
Added Vol:	0	0	0	0	0	0	0	0	0	0	0	0
PasserByVol:	0	0	0	0	0	0	0	0	0	0	0	0
Initial Fut:	396	0	952	0	0	0	0	498	0	0	942	0
User Adj:	1.00	1.00	1.00	1.00	1.00	1.00	1.00	1.00	1.00	1.00	1.00	1.00
PHF Adj:	1.00	1.00	1.00	1.00	1.00	1.00	1.00	1.00	1.00	1.00	1.00	1.00
PHF Volume:	396	0	952	0	0	0	0	498	0	0	942	0
Reduct Vol:	0	0	0	0	0	0	0	0	0	0	0	0
Reduced Vol:	396	0	952	0	0	0	0	498	0	0	942	0
PCE Adj:	1.00	1.00	1.00	1.00	1.00	1.00	1.00	1.00	1.00	1.00	1.00	1.00
MLF Adj:	1.00	1.00	1.00	1.00	1.00	1.00	1.00	1.00	1.00	1.00	1.00	1.00
FinalVolume:	396	0	952	0	0	0	0	498	0	0	942	0
Saturation Flow Module:												
Sat/Lane:	1900	1900	1900	1900	1900	1900	1900	1900	1900	1900	1900	1900
Adjustment:	0.83	1.00	0.83	0.92	1.00	0.92	0.92	1.00	0.92	0.92	1.00	0.92
Lanes:	2.00	0.00	2.00	0.00	0.00	0.00	0.00	2.00	0.00	0.00	2.00	0.00
Final Sat.:	3150	0	3150	0	0	0	0	3800	0	0	3800	0
Capacity Analysis Module:												
Vol/Sat:	0.13	0.00	0.30	0.00	0.00	0.00	0.00	0.13	0.00	0.00	0.25	0.00
Crit Moves:			****					****			****	
Green Time:	51.6	0.0	51.6	0.0	0.0	0.0	0.0	42.4	0.0	0.0	42.4	0.0
Volume/Cap:	0.24	0.00	0.59	0.00	0.00	0.00	0.00	0.31	0.00	0.00	0.59	0.00
Delay/Veh:	13.5	0.0	17.3	0.0	0.0	0.0	0.0	19.2	0.0	0.0	22.6	0.0
User DelAdj:	1.00	1.00	1.00	1.00	1.00	1.00	1.00	1.00	1.00	1.00	1.00	1.00
AdjDel/Veh:	13.5	0.0	17.3	0.0	0.0	0.0	0.0	19.2	0.0	0.0	22.6	0.0
LOS by Move:	B	A	B	A	A	A	A	B	A	A	C	A
HCM2k95thQ:	8	0	22	0	0	0	0	10	0	0	20	0

Note: Queue reported is the number of cars per lane.

BART Phase II Extension Project

Level Of Service Computation Report
 2000 HCM Operations (Future Volume Alternative)
 PM - 2035 No Project Conditions

Intersection #3015: 87/SANTA CLARA

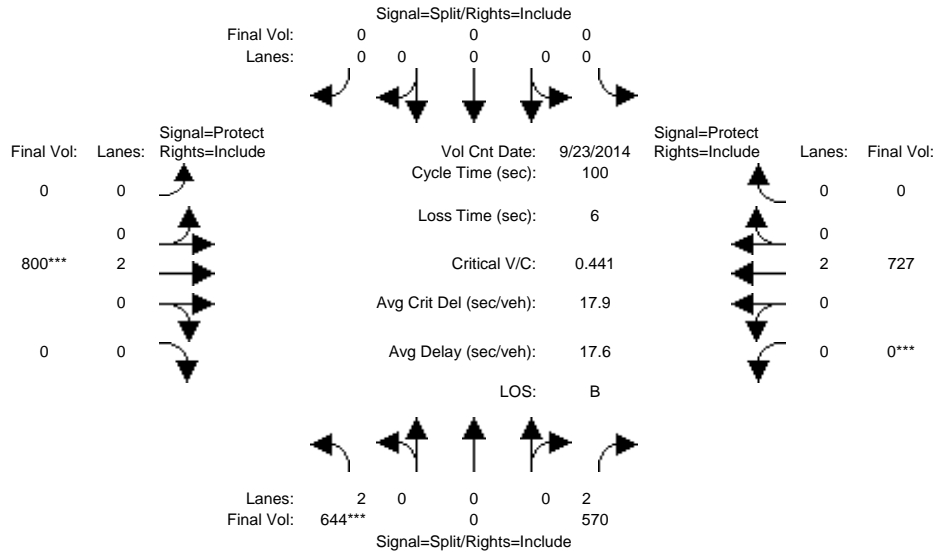

Approach:	North Bound			South Bound			East Bound			West Bound		
	L	T	R	L	T	R	L	T	R	L	T	R
Min. Green:	10	0	10	0	0	0	0	10	0	0	10	0
Y+R:	4.0	4.0	4.0	4.0	4.0	4.0	4.0	4.0	4.0	4.0	4.0	4.0
Volume Module: >> Count Date: 23 Sep 2014 <<												
Base Vol:	644	0	570	0	0	0	0	800	0	0	727	0
Growth Adj:	1.00	1.00	1.00	1.00	1.00	1.00	1.00	1.00	1.00	1.00	1.00	1.00
Initial Bse:	644	0	570	0	0	0	0	800	0	0	727	0
Added Vol:	0	0	0	0	0	0	0	0	0	0	0	0
PasserByVol:	0	0	0	0	0	0	0	0	0	0	0	0
Initial Fut:	644	0	570	0	0	0	0	800	0	0	727	0
User Adj:	1.00	1.00	1.00	1.00	1.00	1.00	1.00	1.00	1.00	1.00	1.00	1.00
PHF Adj:	1.00	1.00	1.00	1.00	1.00	1.00	1.00	1.00	1.00	1.00	1.00	1.00
PHF Volume:	644	0	570	0	0	0	0	800	0	0	727	0
Reduct Vol:	0	0	0	0	0	0	0	0	0	0	0	0
Reduced Vol:	644	0	570	0	0	0	0	800	0	0	727	0
PCE Adj:	1.00	1.00	1.00	1.00	1.00	1.00	1.00	1.00	1.00	1.00	1.00	1.00
MLF Adj:	1.00	1.00	1.00	1.00	1.00	1.00	1.00	1.00	1.00	1.00	1.00	1.00
FinalVolume:	644	0	570	0	0	0	0	800	0	0	727	0
Saturation Flow Module:												
Sat/Lane:	1900	1900	1900	1900	1900	1900	1900	1900	1900	1900	1900	1900
Adjustment:	0.83	1.00	0.83	0.92	1.00	0.92	0.92	1.00	0.92	0.92	1.00	0.92
Lanes:	2.00	0.00	2.00	0.00	0.00	0.00	0.00	2.00	0.00	0.00	2.00	0.00
Final Sat.:	3150	0	3150	0	0	0	0	3800	0	0	3800	0
Capacity Analysis Module:												
Vol/Sat:	0.20	0.00	0.18	0.00	0.00	0.00	0.00	0.21	0.00	0.00	0.19	0.00
Crit Moves:	****							****			****	
Green Time:	46.3	0.0	46.3	0.0	0.0	0.0	0.0	47.7	0.0	0.0	47.7	0.0
Volume/Cap:	0.44	0.00	0.39	0.00	0.00	0.00	0.00	0.44	0.00	0.00	0.40	0.00
Delay/Veh:	18.3	0.0	17.8	0.0	0.0	0.0	0.0	17.5	0.0	0.0	17.1	0.0
User DelAdj:	1.00	1.00	1.00	1.00	1.00	1.00	1.00	1.00	1.00	1.00	1.00	1.00
AdjDel/Veh:	18.3	0.0	17.8	0.0	0.0	0.0	0.0	17.5	0.0	0.0	17.1	0.0
LOS by Move:	B	A	B	A	A	A	A	B	A	A	B	A
HCM2k95thQ:	15	0	13	0	0	0	0	15	0	0	13	0

Note: Queue reported is the number of cars per lane.

BART Phase II Extension Project

Level Of Service Computation Report
 2000 HCM Operations (Future Volume Alternative)
 AM - 2035 No Project Conditions

Intersection #3032: 280/BIRD (N)

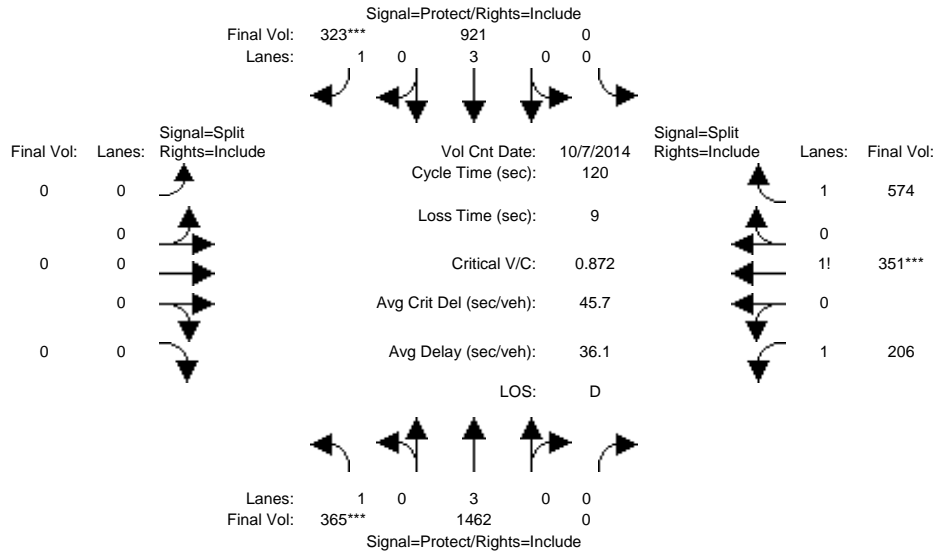

Approach:	North Bound			South Bound			East Bound			West Bound		
	L	T	R	L	T	R	L	T	R	L	T	R
Min. Green:	7	10	0	0	10	10	0	0	0	10	10	10
Y+R:	4.0	4.0	4.0	4.0	4.0	4.0	4.0	4.0	4.0	4.0	4.0	4.0
Volume Module: >> Count Date: 7 Oct 2014 <<												
Base Vol:	365	1462	0	0	921	323	0	0	0	206	351	574
Growth Adj:	1.00	1.00	1.00	1.00	1.00	1.00	1.00	1.00	1.00	1.00	1.00	1.00
Initial Bse:	365	1462	0	0	921	323	0	0	0	206	351	574
Added Vol:	0	0	0	0	0	0	0	0	0	0	0	0
PasserByVol:	0	0	0	0	0	0	0	0	0	0	0	0
Initial Fut:	365	1462	0	0	921	323	0	0	0	206	351	574
User Adj:	1.00	1.00	1.00	1.00	1.00	1.00	1.00	1.00	1.00	1.00	1.00	1.00
PHF Adj:	1.00	1.00	1.00	1.00	1.00	1.00	1.00	1.00	1.00	1.00	1.00	1.00
PHF Volume:	365	1462	0	0	921	323	0	0	0	206	351	574
Reduct Vol:	0	0	0	0	0	0	0	0	0	0	0	0
Reduced Vol:	365	1462	0	0	921	323	0	0	0	206	351	574
PCE Adj:	1.00	1.00	1.00	1.00	1.00	1.00	1.00	1.00	1.00	1.00	1.00	1.00
MLF Adj:	1.00	1.00	1.00	1.00	1.00	1.00	1.00	1.00	1.00	1.00	1.00	1.00
FinalVolume:	365	1462	0	0	921	323	0	0	0	206	351	574
Saturation Flow Module:												
Sat/Lane:	1900	1900	1900	1900	1900	1900	1900	1900	1900	1900	1900	1900
Adjustment:	0.92	1.00	0.92	0.92	1.00	0.92	0.92	1.00	0.92	0.92	0.95	0.95
Lanes:	1.00	3.00	0.00	0.00	3.00	1.00	0.00	0.00	0.00	1.14	0.47	1.39
Final Sat.:	1750	5700	0	0	5700	1750	0	0	0	1999	849	2494
Capacity Analysis Module:												
Vol/Sat:	0.21	0.26	0.00	0.00	0.16	0.18	0.00	0.00	0.00	0.10	0.41	0.23
Crit Moves:	****					****					****	
Green Time:	28.7	54.1	0.0	0.0	25.4	25.4	0.0	0.0	0.0	56.9	56.9	56.9
Volume/Cap:	0.87	0.57	0.00	0.00	0.76	0.87	0.00	0.00	0.00	0.22	0.87	0.49
Delay/Veh:	61.6	24.6	0.0	0.0	47.4	65.3	0.0	0.0	0.0	18.5	35.0	21.7
User DelAdj:	1.00	1.00	1.00	1.00	1.00	1.00	1.00	1.00	1.00	1.00	1.00	1.00
AdjDel/Veh:	61.6	24.6	0.0	0.0	47.4	65.3	0.0	0.0	0.0	18.5	35.0	21.7
LOS by Move:	E	C	A	A	D	E	A	A	A	B	D	C
HCM2k95thQ:	29	24	0	0	19	23	0	0	0	8	46	20

Note: Queue reported is the number of cars per lane.

BART Phase II Extension Project

Level Of Service Computation Report
 2000 HCM Operations (Future Volume Alternative)
 PM - 2035 No Project Conditions

Intersection #3032: 280/BIRD (N)

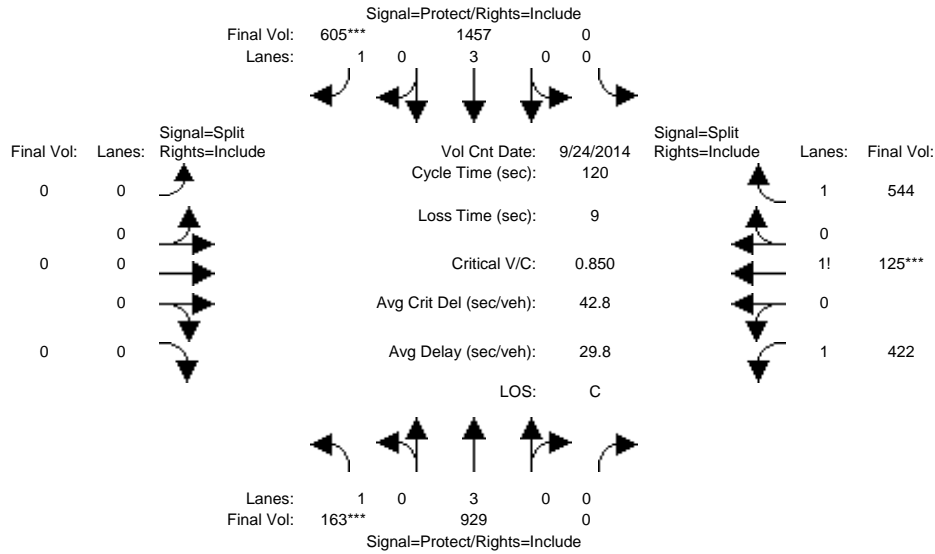

Approach:	North Bound			South Bound			East Bound			West Bound		
	L	T	R	L	T	R	L	T	R	L	T	R
Min. Green:	7	10	0	0	10	10	0	0	0	10	10	10
Y+R:	4.0	4.0	4.0	4.0	4.0	4.0	4.0	4.0	4.0	4.0	4.0	4.0

Volume Module:	>>	Count	Date:	24 Sep 2014	<<							
Base Vol:	163	929	0	0	1457	605	0	0	0	422	125	544
Growth Adj:	1.00	1.00	1.00	1.00	1.00	1.00	1.00	1.00	1.00	1.00	1.00	1.00
Initial Bse:	163	929	0	0	1457	605	0	0	0	422	125	544
Added Vol:	0	0	0	0	0	0	0	0	0	0	0	0
PasserByVol:	0	0	0	0	0	0	0	0	0	0	0	0
Initial Fut:	163	929	0	0	1457	605	0	0	0	422	125	544
User Adj:	1.00	1.00	1.00	1.00	1.00	1.00	1.00	1.00	1.00	1.00	1.00	1.00
PHF Adj:	1.00	1.00	1.00	1.00	1.00	1.00	1.00	1.00	1.00	1.00	1.00	1.00
PHF Volume:	163	929	0	0	1457	605	0	0	0	422	125	544
Reduct Vol:	0	0	0	0	0	0	0	0	0	0	0	0
Reduced Vol:	163	929	0	0	1457	605	0	0	0	422	125	544
PCE Adj:	1.00	1.00	1.00	1.00	1.00	1.00	1.00	1.00	1.00	1.00	1.00	1.00
MLF Adj:	1.00	1.00	1.00	1.00	1.00	1.00	1.00	1.00	1.00	1.00	1.00	1.00
Final Volume:	163	929	0	0	1457	605	0	0	0	422	125	544

Saturation Flow Module:	North Bound			South Bound			East Bound			West Bound		
Sat/Lane:	1900	1900	1900	1900	1900	1900	1900	1900	1900	1900	1900	1900
Adjustment:	0.92	1.00	0.92	0.92	1.00	0.92	0.92	1.00	0.92	0.92	0.92	0.92
Lanes:	1.00	3.00	0.00	0.00	3.00	1.00	0.00	0.00	0.00	1.35	0.20	1.45
Final Sat.:	1750	5700	0	0	5700	1750	0	0	0	2357	360	2533

Capacity Analysis Module:	North Bound			South Bound			East Bound			West Bound		
Vol/Sat:	0.09	0.16	0.00	0.00	0.26	0.35	0.00	0.00	0.00	0.18	0.35	0.21
Crit Moves:	****				****					****		
Green Time:	13.1	62.0	0.0	0.0	48.8	48.8	0.0	0.0	0.0	49.0	49.0	49.0
Volume/Cap:	0.85	0.32	0.00	0.00	0.63	0.85	0.00	0.00	0.00	0.44	0.85	0.53
Delay/Veh:	80.9	16.8	0.0	0.0	28.9	41.8	0.0	0.0	0.0	25.7	37.7	27.0
User DelAdj:	1.00	1.00	1.00	1.00	1.00	1.00	1.00	1.00	1.00	1.00	1.00	1.00
AdjDel/Veh:	80.9	16.8	0.0	0.0	28.9	41.8	0.0	0.0	0.0	25.7	37.7	27.0
LOS by Move:	F	B	A	A	C	D	A	A	A	C	D	C
HCM2k95thQ:	17	12	0	0	24	37	0	0	0	17	40	21

Note: Queue reported is the number of cars per lane.

BART Phase II Extension Project

Level Of Service Computation Report
 2000 HCM Operations (Future Volume Alternative)
 AM - 2035 No Project Conditions

Intersection #3033: 280/BIRD (S)

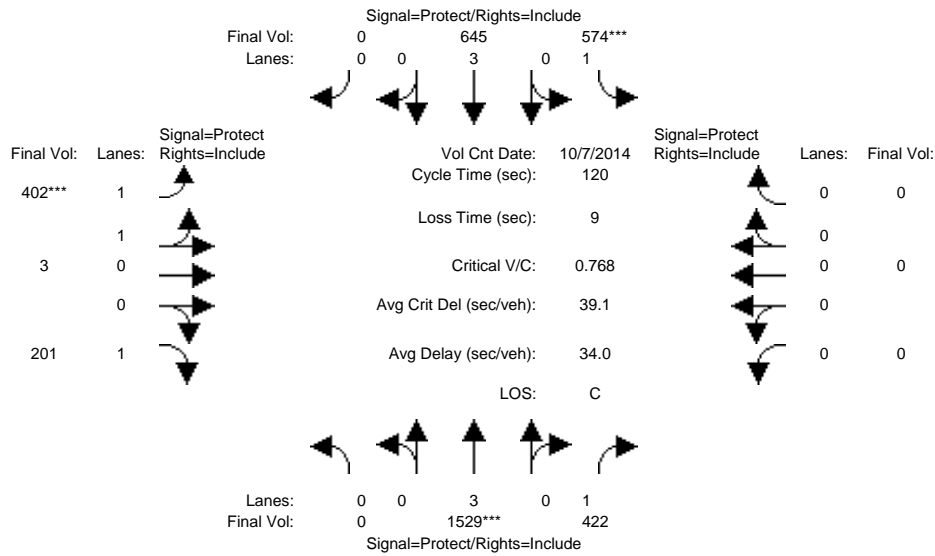

Approach:	North Bound			South Bound			East Bound			West Bound		
	L	T	R	L	T	R	L	T	R	L	T	R
Min. Green:	0	10	10	7	10	0	10	10	10	0	0	0
Y+R:	4.0	4.0	4.0	4.0	4.0	4.0	4.0	4.0	4.0	4.0	4.0	4.0

Volume Module:	>>	Count	Date:	7 Oct 2014	<<												
Base Vol:	0	1529	422	574	645	0	402	3	201	0	0	0					
Growth Adj:	1.00	1.00	1.00	1.00	1.00	1.00	1.00	1.00	1.00	1.00	1.00	1.00					
Initial Bse:	0	1529	422	574	645	0	402	3	201	0	0	0					
Added Vol:	0	0	0	0	0	0	0	0	0	0	0	0					
PasserByVol:	0	0	0	0	0	0	0	0	0	0	0	0					
Initial Fut:	0	1529	422	574	645	0	402	3	201	0	0	0					
User Adj:	1.00	1.00	1.00	1.00	1.00	1.00	1.00	1.00	1.00	1.00	1.00	1.00					
PHF Adj:	1.00	1.00	1.00	1.00	1.00	1.00	1.00	1.00	1.00	1.00	1.00	1.00					
PHF Volume:	0	1529	422	574	645	0	402	3	201	0	0	0					
Reduct Vol:	0	0	0	0	0	0	0	0	0	0	0	0					
Reduced Vol:	0	1529	422	574	645	0	402	3	201	0	0	0					
PCE Adj:	1.00	1.00	1.00	1.00	1.00	1.00	1.00	1.00	1.00	1.00	1.00	1.00					
MLF Adj:	1.00	1.00	1.00	1.00	1.00	1.00	1.00	1.00	1.00	1.00	1.00	1.00					
Final Volume:	0	1529	422	574	645	0	402	3	201	0	0	0					

Saturation Flow Module:												
Sat/Lane:	1900	1900	1900	1900	1900	1900	1900	1900	1900	1900	1900	1900
Adjustment:	0.92	1.00	0.92	0.92	1.00	0.92	0.93	0.95	0.92	0.92	1.00	0.92
Lanes:	0.00	3.00	1.00	1.00	3.00	0.00	1.99	0.01	1.00	0.00	0.00	0.00
Final Sat.:	0	5700	1750	1750	5700	0	3524	26	1750	0	0	0

Capacity Analysis Module:												
Vol/Sat:	0.00	0.27	0.24	0.33	0.11	0.00	0.11	0.11	0.11	0.00	0.00	0.00
Crit Moves:	****			****			****					
Green Time:	0.0	41.9	41.9	51.3	93.2	0.0	17.8	17.8	17.8	0.0	0.0	0.0
Volume/Cap:	0.00	0.77	0.69	0.77	0.15	0.00	0.77	0.77	0.77	0.00	0.00	0.00
Delay/Veh:	0.0	36.6	36.8	34.1	3.4	0.0	55.8	55.8	62.5	0.0	0.0	0.0
User DelAdj:	1.00	1.00	1.00	1.00	1.00	1.00	1.00	1.00	1.00	1.00	1.00	1.00
AdjDel/Veh:	0.0	36.6	36.8	34.1	3.4	0.0	55.8	55.8	62.5	0.0	0.0	0.0
LOS by Move:	A	D	D	C	A	A	E	E	E	A	A	A
HCM2k95thQ:	0	30	26	35	4	0	18	18	18	0	0	0

Note: Queue reported is the number of cars per lane.

BART Phase II Extension Project

Level Of Service Computation Report
 2000 HCM Operations (Future Volume Alternative)
 PM - 2035 No Project Conditions

Intersection #3033: 280/BIRD (S)

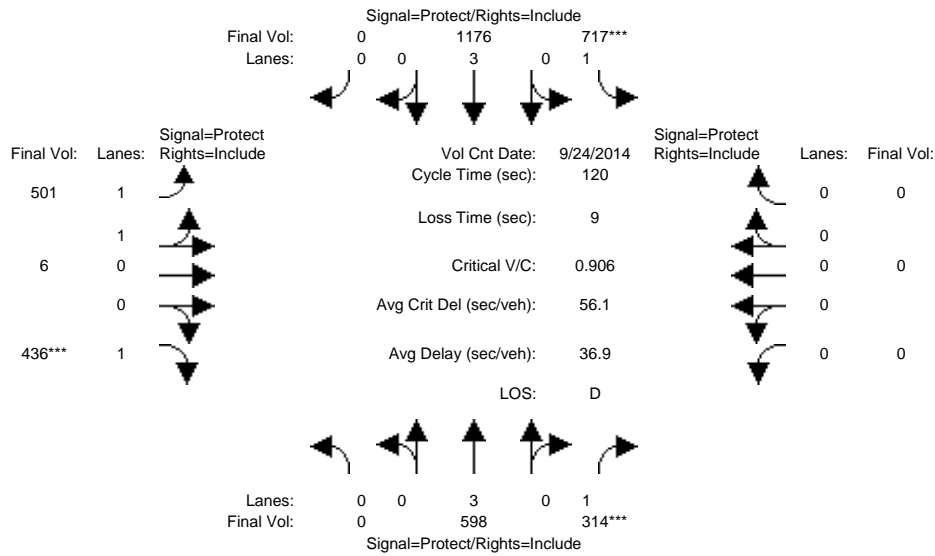

Approach:	North Bound			South Bound			East Bound			West Bound		
	L	T	R	L	T	R	L	T	R	L	T	R
Min. Green:	0	10	10	7	10	0	10	10	10	0	0	0
Y+R:	4.0	4.0	4.0	4.0	4.0	4.0	4.0	4.0	4.0	4.0	4.0	4.0

Volume Module:	>>	Count	Date:	24 Sep 2014	<<							
Base Vol:	0	598	314	717	1176	0	501	6	436	0	0	0
Growth Adj:	1.00	1.00	1.00	1.00	1.00	1.00	1.00	1.00	1.00	1.00	1.00	1.00
Initial Bse:	0	598	314	717	1176	0	501	6	436	0	0	0
Added Vol:	0	0	0	0	0	0	0	0	0	0	0	0
PasserByVol:	0	0	0	0	0	0	0	0	0	0	0	0
Initial Fut:	0	598	314	717	1176	0	501	6	436	0	0	0
User Adj:	1.00	1.00	1.00	1.00	1.00	1.00	1.00	1.00	1.00	1.00	1.00	1.00
PHF Adj:	1.00	1.00	1.00	1.00	1.00	1.00	1.00	1.00	1.00	1.00	1.00	1.00
PHF Volume:	0	598	314	717	1176	0	501	6	436	0	0	0
Reduct Vol:	0	0	0	0	0	0	0	0	0	0	0	0
Reduced Vol:	0	598	314	717	1176	0	501	6	436	0	0	0
PCE Adj:	1.00	1.00	1.00	1.00	1.00	1.00	1.00	1.00	1.00	1.00	1.00	1.00
MLF Adj:	1.00	1.00	1.00	1.00	1.00	1.00	1.00	1.00	1.00	1.00	1.00	1.00
Final Volume:	0	598	314	717	1176	0	501	6	436	0	0	0

Saturation Flow Module:												
Sat/Lane:	1900	1900	1900	1900	1900	1900	1900	1900	1900	1900	1900	1900
Adjustment:	0.92	1.00	0.92	0.92	1.00	0.92	0.93	0.95	0.92	0.92	1.00	0.92
Lanes:	0.00	3.00	1.00	1.00	3.00	0.00	1.98	0.02	1.00	0.00	0.00	0.00
Final Sat.:	0	5700	1750	1750	5700	0	3508	42	1750	0	0	0

Capacity Analysis Module:												
Vol/Sat:	0.00	0.10	0.18	0.41	0.21	0.00	0.14	0.14	0.25	0.00	0.00	0.00
Crit Moves:			****	****					****			
Green Time:	0.0	23.8	23.8	54.3	78.0	0.0	33.0	33.0	33.0	0.0	0.0	0.0
Volume/Cap:	0.00	0.53	0.91	0.91	0.32	0.00	0.52	0.52	0.91	0.00	0.00	0.00
Delay/Veh:	0.0	43.6	73.3	44.5	9.3	0.0	37.3	37.3	62.7	0.0	0.0	0.0
User DelAdj:	1.00	1.00	1.00	1.00	1.00	1.00	1.00	1.00	1.00	1.00	1.00	1.00
AdjDel/Veh:	0.0	43.6	73.3	44.5	9.3	0.0	37.3	37.3	62.7	0.0	0.0	0.0
LOS by Move:	A	D	E	D	A	A	D	D	E	A	A	A
HCM2k95thQ:	0	12	25	49	12	0	16	16	35	0	0	0

Note: Queue reported is the number of cars per lane.

BART Phase II Extension Project

Level Of Service Computation Report
 2000 HCM Operations (Future Volume Alternative)
 AM - 2035 No Project Conditions

Intersection #3058: ALAMEDA/NAGLEE

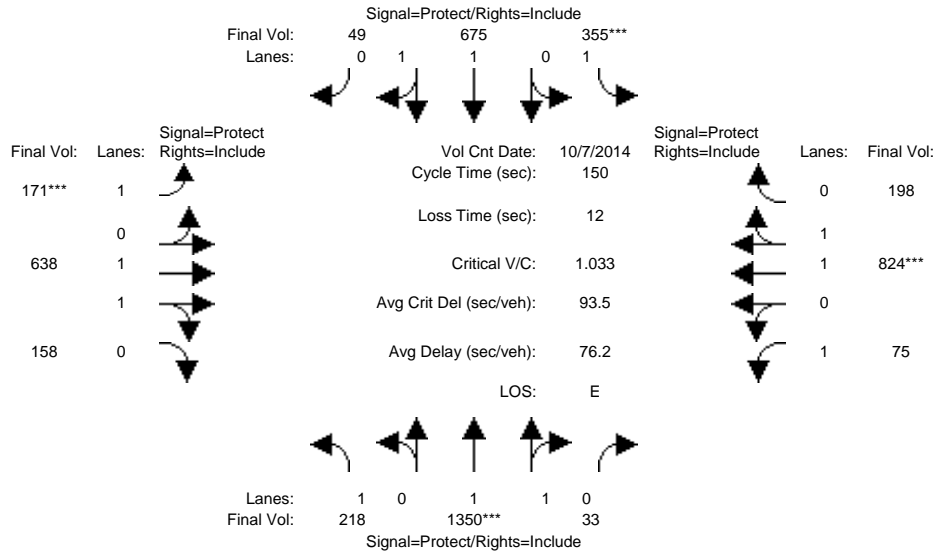

Approach:	North Bound			South Bound			East Bound			West Bound		
Movement:	L	T	R	L	T	R	L	T	R	L	T	R
Min. Green:	7	10	10	7	10	10	7	10	10	7	10	10
Y+R:	4.0	4.0	4.0	4.0	4.0	4.0	4.0	4.0	4.0	4.0	4.0	4.0
Volume Module: >> Count Date: 7 Oct 2014 <<												
Base Vol:	218	1350	33	355	675	49	171	638	158	75	824	198
Growth Adj:	1.00	1.00	1.00	1.00	1.00	1.00	1.00	1.00	1.00	1.00	1.00	1.00
Initial Bse:	218	1350	33	355	675	49	171	638	158	75	824	198
Added Vol:	0	0	0	0	0	0	0	0	0	0	0	0
PasserByVol:	0	0	0	0	0	0	0	0	0	0	0	0
Initial Fut:	218	1350	33	355	675	49	171	638	158	75	824	198
User Adj:	1.00	1.00	1.00	1.00	1.00	1.00	1.00	1.00	1.00	1.00	1.00	1.00
PHF Adj:	1.00	1.00	1.00	1.00	1.00	1.00	1.00	1.00	1.00	1.00	1.00	1.00
PHF Volume:	218	1350	33	355	675	49	171	638	158	75	824	198
Reduct Vol:	0	0	0	0	0	0	0	0	0	0	0	0
Reduced Vol:	218	1350	33	355	675	49	171	638	158	75	824	198
PCE Adj:	1.00	1.00	1.00	1.00	1.00	1.00	1.00	1.00	1.00	1.00	1.00	1.00
MLF Adj:	1.00	1.00	1.00	1.00	1.00	1.00	1.00	1.00	1.00	1.00	1.00	1.00
FinalVolume:	218	1350	33	355	675	49	171	638	158	75	824	198
Saturation Flow Module:												
Sat/Lane:	1900	1900	1900	1900	1900	1900	1900	1900	1900	1900	1900	1900
Adjustment:	0.92	0.97	0.95	0.92	0.98	0.95	0.92	0.98	0.95	0.92	0.98	0.95
Lanes:	1.00	1.95	0.05	1.00	1.86	0.14	1.00	1.59	0.41	1.00	1.60	0.40
Final Sat.:	1750	3612	88	1750	3449	250	1750	2965	734	1750	2983	717
Capacity Analysis Module:												
Vol/Sat:	0.12	0.37	0.37	0.20	0.20	0.20	0.10	0.22	0.22	0.04	0.28	0.28
Crit Moves:	****			****			****			****		
Green Time:	32.6	54.3	54.3	29.4	51.1	51.1	14.2	44.6	44.6	9.7	40.1	40.1
Volume/Cap:	0.57	1.03	1.03	1.03	0.57	0.57	1.03	0.72	0.72	0.66	1.03	1.03
Delay/Veh:	54.6	81.5	81.5	117.7	41.1	41.1	146.9	49.6	49.6	82.5	92.5	92.5
User DelAdj:	1.00	1.00	1.00	1.00	1.00	1.00	1.00	1.00	1.00	1.00	1.00	1.00
AdjDel/Veh:	54.6	81.5	81.5	117.7	41.1	41.1	146.9	49.6	49.6	82.5	92.5	92.5
LOS by Move:	D	F	F	F	D	D	F	D	D	F	F	F
HCM2k95thQ:	19	63	63	37	24	24	23	30	30	8	48	48

Note: Queue reported is the number of cars per lane.

BART Phase II Extension Project

Level Of Service Computation Report
 2000 HCM Operations (Future Volume Alternative)
 PM - 2035 No Project Conditions

Intersection #3058: ALAMEDA/NAGLEE

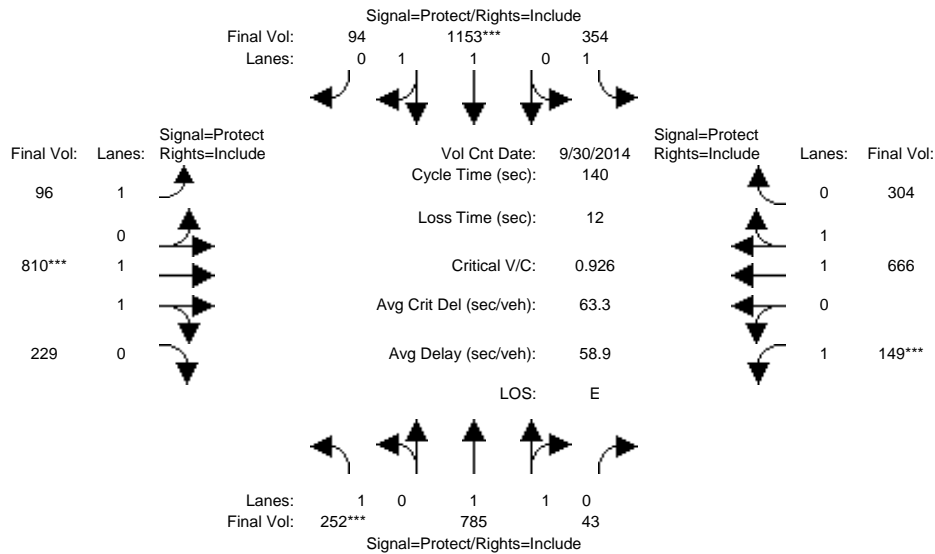

Approach:	North Bound			South Bound			East Bound			West Bound		
Movement:	L	T	R	L	T	R	L	T	R	L	T	R
Min. Green:	7	10	10	7	10	10	7	10	10	7	10	10
Y+R:	4.0	4.0	4.0	4.0	4.0	4.0	4.0	4.0	4.0	4.0	4.0	4.0
Volume Module: >> Count Date: 30 Sep 2014 <<												
Base Vol:	252	785	43	354	1153	94	96	810	229	149	666	304
Growth Adj:	1.00	1.00	1.00	1.00	1.00	1.00	1.00	1.00	1.00	1.00	1.00	1.00
Initial Bse:	252	785	43	354	1153	94	96	810	229	149	666	304
Added Vol:	0	0	0	0	0	0	0	0	0	0	0	0
PasserByVol:	0	0	0	0	0	0	0	0	0	0	0	0
Initial Fut:	252	785	43	354	1153	94	96	810	229	149	666	304
User Adj:	1.00	1.00	1.00	1.00	1.00	1.00	1.00	1.00	1.00	1.00	1.00	1.00
PHF Adj:	1.00	1.00	1.00	1.00	1.00	1.00	1.00	1.00	1.00	1.00	1.00	1.00
PHF Volume:	252	785	43	354	1153	94	96	810	229	149	666	304
Reduct Vol:	0	0	0	0	0	0	0	0	0	0	0	0
Reduced Vol:	252	785	43	354	1153	94	96	810	229	149	666	304
PCE Adj:	1.00	1.00	1.00	1.00	1.00	1.00	1.00	1.00	1.00	1.00	1.00	1.00
MLF Adj:	1.00	1.00	1.00	1.00	1.00	1.00	1.00	1.00	1.00	1.00	1.00	1.00
FinalVolume:	252	785	43	354	1153	94	96	810	229	149	666	304
Saturation Flow Module:												
Sat/Lane:	1900	1900	1900	1900	1900	1900	1900	1900	1900	1900	1900	1900
Adjustment:	0.92	0.98	0.95	0.92	0.98	0.95	0.92	0.98	0.95	0.92	0.99	0.95
Lanes:	1.00	1.89	0.11	1.00	1.85	0.15	1.00	1.55	0.45	1.00	1.36	0.64
Final Sat.:	1750	3508	192	1750	3421	279	1750	2884	815	1750	2540	1159
Capacity Analysis Module:												
Vol/Sat:	0.14	0.22	0.22	0.20	0.34	0.34	0.05	0.28	0.28	0.09	0.26	0.26
Crit Moves:	****			****			****			****		
Green Time:	21.8	38.2	38.2	34.5	50.9	50.9	9.6	42.4	42.4	12.9	45.7	45.7
Volume/Cap:	0.93	0.82	0.82	0.82	0.93	0.93	0.80	0.93	0.93	0.93	0.80	0.80
Delay/Veh:	93.8	53.2	53.2	61.7	53.9	53.9	95.3	60.1	60.1	112.8	47.0	47.0
User DelAdj:	1.00	1.00	1.00	1.00	1.00	1.00	1.00	1.00	1.00	1.00	1.00	1.00
AdjDel/Veh:	93.8	53.2	53.2	61.7	53.9	53.9	95.3	60.1	60.1	112.8	47.0	47.0
LOS by Move:	F	D	D	E	D	D	F	E	E	F	D	D
HCM2k95thQ:	27	32	32	28	47	47	12	43	43	15	34	34

Note: Queue reported is the number of cars per lane.

BART Phase II Extension Project

Level Of Service Computation Report
 2000 HCM Operations (Future Volume Alternative)
 AM - 2035 No Project Conditions

Intersection #3059: ALAMEDA/RACE *

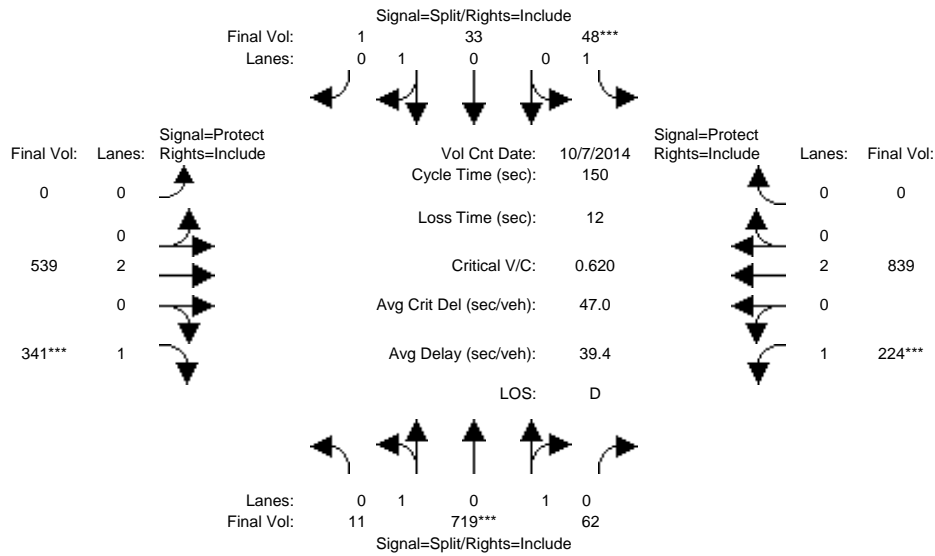

Approach:	North Bound			South Bound			East Bound			West Bound		
	L	T	R	L	T	R	L	T	R	L	T	R
Min. Green:	10	10	10	10	10	10	0	10	10	7	10	0
Y+R:	4.0	4.0	4.0	4.0	4.0	4.0	4.0	4.0	4.0	4.0	4.0	4.0

Volume Module: >> Count Date: 7 Oct 2014 <<

Base Vol:	11	719	62	48	33	1	0	539	341	224	839	0
Growth Adj:	1.00	1.00	1.00	1.00	1.00	1.00	1.00	1.00	1.00	1.00	1.00	1.00
Initial Bse:	11	719	62	48	33	1	0	539	341	224	839	0
Added Vol:	0	0	0	0	0	0	0	0	0	0	0	0
PasserByVol:	0	0	0	0	0	0	0	0	0	0	0	0
Initial Fut:	11	719	62	48	33	1	0	539	341	224	839	0
User Adj:	1.00	1.00	1.00	1.00	1.00	1.00	1.00	1.00	1.00	1.00	1.00	1.00
PHF Adj:	1.00	1.00	1.00	1.00	1.00	1.00	1.00	1.00	1.00	1.00	1.00	1.00
PHF Volume:	11	719	62	48	33	1	0	539	341	224	839	0
Reduct Vol:	0	0	0	0	0	0	0	0	0	0	0	0
Reduced Vol:	11	719	62	48	33	1	0	539	341	224	839	0
PCE Adj:	1.00	1.00	1.00	1.00	1.00	1.00	1.00	1.00	1.00	1.00	1.00	1.00
MLF Adj:	1.00	1.00	1.00	1.00	1.00	1.00	1.00	1.00	1.00	1.00	1.00	1.00
FinalVolume:	11	719	62	48	33	1	0	539	341	224	839	0

Saturation Flow Module:

Sat/Lane:	1900	1900	1900	1900	1900	1900	1900	1900	1900	1900	1900	1900
Adjustment:	0.95	0.95	0.95	0.92	0.95	0.95	0.92	1.00	0.92	0.92	1.00	0.92
Lanes:	0.03	1.81	0.16	1.00	0.97	0.03	0.00	2.00	1.00	1.00	2.00	0.00
Final Sat.:	50	3268	282	1750	1747	53	0	3800	1750	1750	3800	0

Capacity Analysis Module:

Vol/Sat:	0.22	0.22	0.22	0.03	0.02	0.02	0.00	0.14	0.19	0.13	0.22	0.00
Crit Moves:	****	****	****	****	****	****	****	****	****	****	****	****
Green Time:	51.9	51.9	51.9	10.0	10.0	10.0	0.0	45.9	45.9	30.2	76.1	0.0
Volume/Cap:	0.64	0.64	0.64	0.41	0.28	0.28	0.00	0.46	0.64	0.64	0.44	0.00
Delay/Veh:	42.2	42.2	42.2	69.5	67.9	67.9	0.0	42.3	47.4	58.7	23.5	0.0
User DelAdj:	1.00	1.00	1.00	1.00	1.00	1.00	1.00	1.00	1.00	1.00	1.00	1.00
AdjDel/Veh:	42.2	42.2	42.2	69.5	67.9	67.9	0.0	42.3	47.4	58.7	23.5	0.0
LOS by Move:	D	D	D	E	E	E	A	D	D	E	C	A
HCM2k95thQ:	28	28	28	6	4	4	0	18	26	19	21	0

Note: Queue reported is the number of cars per lane.

BART Phase II Extension Project

Level Of Service Computation Report
 2000 HCM Operations (Future Volume Alternative)
 PM - 2035 No Project Conditions

Intersection #3059: ALAMEDA/RACE *

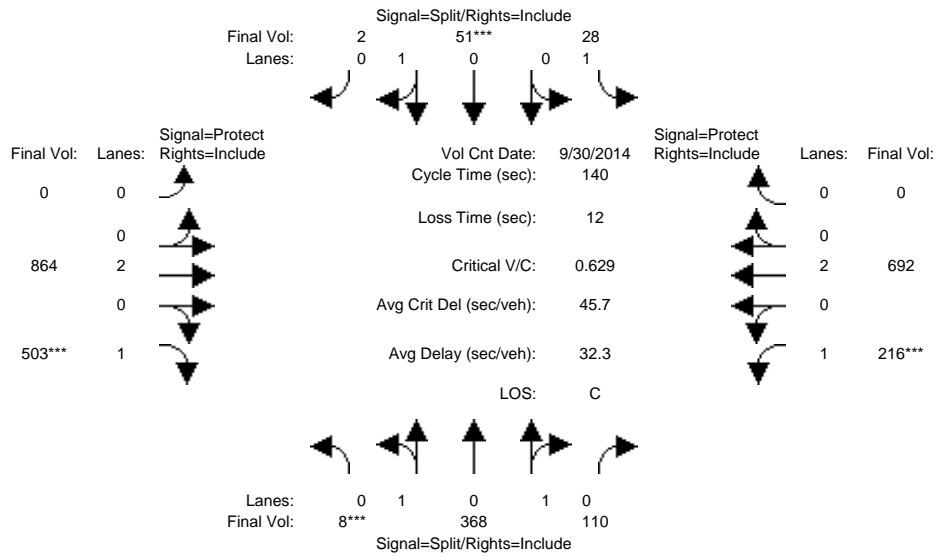

Approach:	North Bound			South Bound			East Bound			West Bound		
	L	T	R	L	T	R	L	T	R	L	T	R
Min. Green:	10	10	10	10	10	10	0	10	10	7	10	0
Y+R:	4.0	4.0	4.0	4.0	4.0	4.0	4.0	4.0	4.0	4.0	4.0	4.0

Volume Module: >> Count Date: 30 Sep 2014 <<

Base Vol:	8	368	110	28	51	2	0	864	503	216	692	0
Growth Adj:	1.00	1.00	1.00	1.00	1.00	1.00	1.00	1.00	1.00	1.00	1.00	1.00
Initial Bse:	8	368	110	28	51	2	0	864	503	216	692	0
Added Vol:	0	0	0	0	0	0	0	0	0	0	0	0
PasserByVol:	0	0	0	0	0	0	0	0	0	0	0	0
Initial Fut:	8	368	110	28	51	2	0	864	503	216	692	0
User Adj:	1.00	1.00	1.00	1.00	1.00	1.00	1.00	1.00	1.00	1.00	1.00	1.00
PHF Adj:	1.00	1.00	1.00	1.00	1.00	1.00	1.00	1.00	1.00	1.00	1.00	1.00
PHF Volume:	8	368	110	28	51	2	0	864	503	216	692	0
Reduct Vol:	0	0	0	0	0	0	0	0	0	0	0	0
Reduced Vol:	8	368	110	28	51	2	0	864	503	216	692	0
PCE Adj:	1.00	1.00	1.00	1.00	1.00	1.00	1.00	1.00	1.00	1.00	1.00	1.00
MLF Adj:	1.00	1.00	1.00	1.00	1.00	1.00	1.00	1.00	1.00	1.00	1.00	1.00
FinalVolume:	8	368	110	28	51	2	0	864	503	216	692	0

Saturation Flow Module:

Sat/Lane:	1900	1900	1900	1900	1900	1900	1900	1900	1900	1900	1900	1900
Adjustment:	0.95	0.95	0.95	0.92	0.95	0.95	0.92	1.00	0.92	0.92	1.00	0.92
Lanes:	0.03	1.52	0.45	1.00	0.96	0.04	0.00	2.00	1.00	1.00	2.00	0.00
Final Sat.:	59	2726	815	1750	1732	68	0	3800	1750	1750	3800	0

Capacity Analysis Module:

Vol/Sat:	0.14	0.14	0.14	0.02	0.03	0.03	0.00	0.23	0.29	0.12	0.18	0.00
Crit Moves:	****				****			****	****			
Green Time:	29.2	29.2	29.2	10.0	10.0	10.0	0.0	62.1	62.1	26.7	88.8	0.0
Volume/Cap:	0.65	0.65	0.65	0.22	0.41	0.41	0.00	0.51	0.65	0.65	0.29	0.00
Delay/Veh:	52.7	52.7	52.7	62.3	64.3	64.3	0.0	28.3	32.3	56.7	11.5	0.0
User DelAdj:	1.00	1.00	1.00	1.00	1.00	1.00	1.00	1.00	1.00	1.00	1.00	1.00
AdjDel/Veh:	52.7	52.7	52.7	62.3	64.3	64.3	0.0	28.3	32.3	56.7	11.5	0.0
LOS by Move:	D	D	D	E	E	E	A	C	C	E	B	A
HCM2k95thQ:	18	18	18	3	6	6	0	23	31	17	12	0

Note: Queue reported is the number of cars per lane.

BART Phase II Extension Project

Level Of Service Computation Report
 2000 HCM Operations (Future Volume Alternative)
 AM - 2035 No Project Conditions

Intersection #3066: AUTUMN/SANTA CLARA

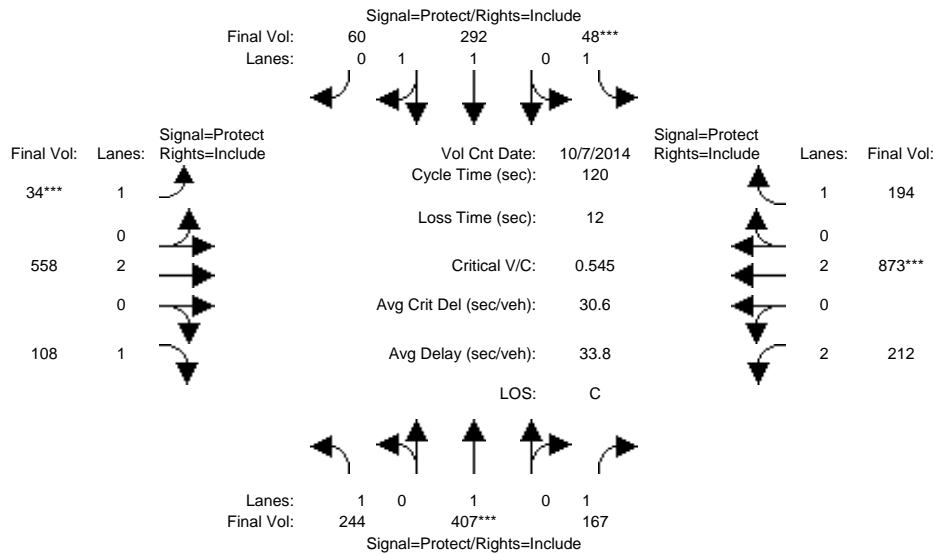

Approach:	North Bound			South Bound			East Bound			West Bound		
Movement:	L	T	R	L	T	R	L	T	R	L	T	R
Min. Green:	7	10	10	7	10	10	7	10	10	7	10	10
Y+R:	4.0	4.0	4.0	4.0	4.0	4.0	4.0	4.0	4.0	4.0	4.0	4.0
Volume Module: >> Count Date: 7 Oct 2014 <<												
Base Vol:	244	407	167	48	292	60	34	558	108	212	873	194
Growth Adj:	1.00	1.00	1.00	1.00	1.00	1.00	1.00	1.00	1.00	1.00	1.00	1.00
Initial Bse:	244	407	167	48	292	60	34	558	108	212	873	194
Added Vol:	0	0	0	0	0	0	0	0	0	0	0	0
PasserByVol:	0	0	0	0	0	0	0	0	0	0	0	0
Initial Fut:	244	407	167	48	292	60	34	558	108	212	873	194
User Adj:	1.00	1.00	1.00	1.00	1.00	1.00	1.00	1.00	1.00	1.00	1.00	1.00
PHF Adj:	1.00	1.00	1.00	1.00	1.00	1.00	1.00	1.00	1.00	1.00	1.00	1.00
PHF Volume:	244	407	167	48	292	60	34	558	108	212	873	194
Reduct Vol:	0	0	0	0	0	0	0	0	0	0	0	0
Reduced Vol:	244	407	167	48	292	60	34	558	108	212	873	194
PCE Adj:	1.00	1.00	1.00	1.00	1.00	1.00	1.00	1.00	1.00	1.00	1.00	1.00
MLF Adj:	1.00	1.00	1.00	1.00	1.00	1.00	1.00	1.00	1.00	1.00	1.00	1.00
FinalVolume:	244	407	167	48	292	60	34	558	108	212	873	194
Saturation Flow Module:												
Sat/Lane:	1900	1900	1900	1900	1900	1900	1900	1900	1900	1900	1900	1900
Adjustment:	0.92	1.00	0.92	0.92	0.98	0.95	0.92	1.00	0.92	0.83	1.00	0.92
Lanes:	1.00	1.00	1.00	1.00	1.65	0.35	1.00	2.00	1.00	2.00	2.00	1.00
Final Sat.:	1750	1900	1750	1750	3069	631	1750	3800	1750	3150	3800	1750
Capacity Analysis Module:												
Vol/Sat:	0.14	0.21	0.10	0.03	0.10	0.10	0.02	0.15	0.06	0.07	0.23	0.11
Crit Moves:	****	****	****	****	****	****	****	****	****	****	****	****
Green Time:	31.1	45.4	45.4	7.0	21.2	21.2	7.0	38.2	38.2	17.5	48.6	48.6
Volume/Cap:	0.54	0.57	0.25	0.47	0.54	0.54	0.33	0.46	0.19	0.46	0.57	0.27
Delay/Veh:	39.5	30.6	25.9	58.1	45.8	45.8	56.2	33.0	29.9	47.7	28.0	24.1
User DelAdj:	1.00	1.00	1.00	1.00	1.00	1.00	1.00	1.00	1.00	1.00	1.00	1.00
AdjDel/Veh:	39.5	30.6	25.9	58.1	45.8	45.8	56.2	33.0	29.9	47.7	28.0	24.1
LOS by Move:	D	C	C	E	D	D	E	C	C	D	C	C
HCM2k95thQ:	15	21	9	4	12	12	3	15	6	8	22	10

Note: Queue reported is the number of cars per lane.

BART Phase II Extension Project

Level Of Service Computation Report
 2000 HCM Operations (Future Volume Alternative)
 PM - 2035 No Project Conditions

Intersection #3066: AUTUMN/SANTA CLARA

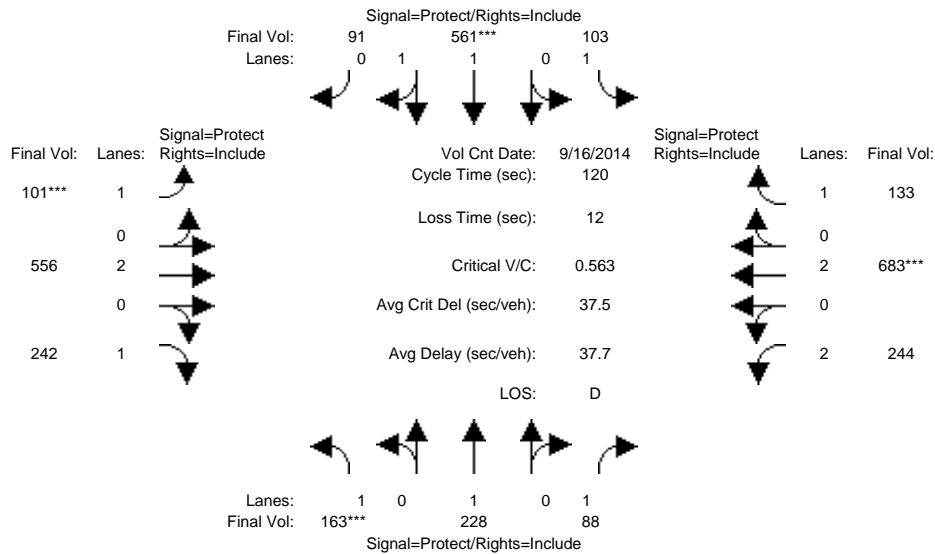

Approach:	North Bound			South Bound			East Bound			West Bound		
	L	T	R	L	T	R	L	T	R	L	T	R
Min. Green:	7	10	10	7	10	10	7	10	10	7	10	10
Y+R:	4.0	4.0	4.0	4.0	4.0	4.0	4.0	4.0	4.0	4.0	4.0	4.0

Volume Module: >> Count Date: 16 Sep 2014 <<

Base Vol:	163	228	88	103	561	91	101	556	242	244	683	133
Growth Adj:	1.00	1.00	1.00	1.00	1.00	1.00	1.00	1.00	1.00	1.00	1.00	1.00
Initial Bse:	163	228	88	103	561	91	101	556	242	244	683	133
Added Vol:	0	0	0	0	0	0	0	0	0	0	0	0
PasserByVol:	0	0	0	0	0	0	0	0	0	0	0	0
Initial Fut:	163	228	88	103	561	91	101	556	242	244	683	133
User Adj:	1.00	1.00	1.00	1.00	1.00	1.00	1.00	1.00	1.00	1.00	1.00	1.00
PHF Adj:	1.00	1.00	1.00	1.00	1.00	1.00	1.00	1.00	1.00	1.00	1.00	1.00
PHF Volume:	163	228	88	103	561	91	101	556	242	244	683	133
Reduct Vol:	0	0	0	0	0	0	0	0	0	0	0	0
Reduced Vol:	163	228	88	103	561	91	101	556	242	244	683	133
PCE Adj:	1.00	1.00	1.00	1.00	1.00	1.00	1.00	1.00	1.00	1.00	1.00	1.00
MLF Adj:	1.00	1.00	1.00	1.00	1.00	1.00	1.00	1.00	1.00	1.00	1.00	1.00
FinalVolume:	163	228	88	103	561	91	101	556	242	244	683	133

Saturation Flow Module:

Sat/Lane:	1900	1900	1900	1900	1900	1900	1900	1900	1900	1900	1900	1900
Adjustment:	0.92	1.00	0.92	0.92	0.98	0.95	0.92	1.00	0.92	0.83	1.00	0.92
Lanes:	1.00	1.00	1.00	1.00	1.71	0.29	1.00	2.00	1.00	2.00	2.00	1.00
Final Sat.:	1750	1900	1750	1750	3183	516	1750	3800	1750	3150	3800	1750

Capacity Analysis Module:

Vol/Sat:	0.09	0.12	0.05	0.06	0.18	0.18	0.06	0.15	0.14	0.08	0.18	0.08
Crit Moves:	****			****			****			****		
Green Time:	19.8	38.5	38.5	18.9	37.6	37.6	12.3	33.1	33.1	17.5	38.3	38.3
Volume/Cap:	0.56	0.37	0.16	0.37	0.56	0.56	0.56	0.53	0.50	0.53	0.56	0.24
Delay/Veh:	48.6	31.8	29.3	46.1	35.0	35.0	55.4	37.4	37.4	48.6	34.5	30.3
User DelAdj:	1.00	1.00	1.00	1.00	1.00	1.00	1.00	1.00	1.00	1.00	1.00	1.00
AdjDel/Veh:	48.6	31.8	29.3	46.1	35.0	35.0	55.4	37.4	37.4	48.6	34.5	30.3
LOS by Move:	D	C	C	D	D	D	E	D	D	D	C	C
HCM2k95thQ:	11	12	5	7	19	19	8	16	15	10	19	7

Note: Queue reported is the number of cars per lane.

BART Phase II Extension Project

Level Of Service Computation Report
 2000 HCM Operations (Future Volume Alternative)
 AM - 2035 No Project Conditions

Intersection #3077: BIRD/SAN CARLOS

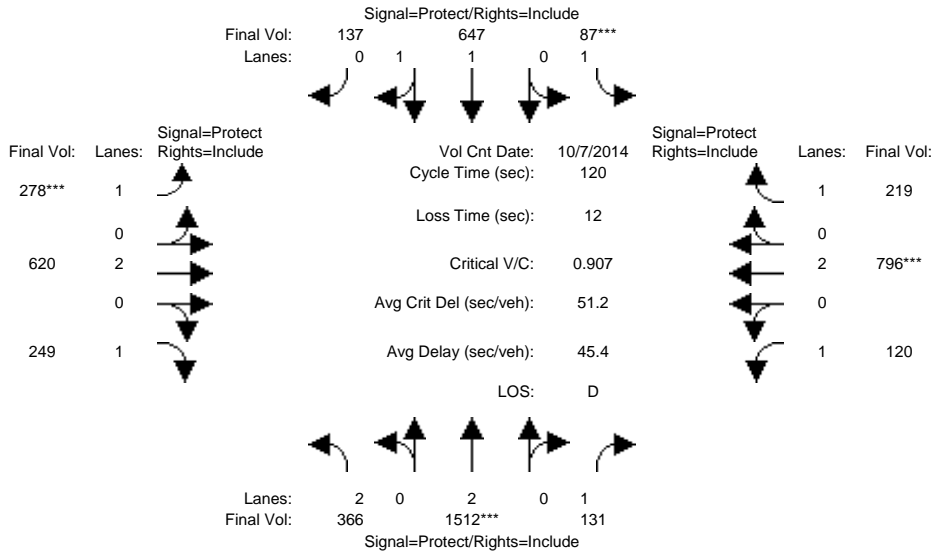

Approach:	North Bound			South Bound			East Bound			West Bound		
	L	T	R	L	T	R	L	T	R	L	T	R
Min. Green:	7	10	10	7	10	10	7	10	10	7	10	10
Y+R:	4.0	4.0	4.0	4.0	4.0	4.0	4.0	4.0	4.0	4.0	4.0	4.0
Volume Module: >> Count Date: 7 Oct 2014 <<												
Base Vol:	366	1512	131	87	647	137	278	620	249	120	796	219
Growth Adj:	1.00	1.00	1.00	1.00	1.00	1.00	1.00	1.00	1.00	1.00	1.00	1.00
Initial Bse:	366	1512	131	87	647	137	278	620	249	120	796	219
Added Vol:	0	0	0	0	0	0	0	0	0	0	0	0
PasserByVol:	0	0	0	0	0	0	0	0	0	0	0	0
Initial Fut:	366	1512	131	87	647	137	278	620	249	120	796	219
User Adj:	1.00	1.00	1.00	1.00	1.00	1.00	1.00	1.00	1.00	1.00	1.00	1.00
PHF Adj:	1.00	1.00	1.00	1.00	1.00	1.00	1.00	1.00	1.00	1.00	1.00	1.00
PHF Volume:	366	1512	131	87	647	137	278	620	249	120	796	219
Reduct Vol:	0	0	0	0	0	0	0	0	0	0	0	0
Reduced Vol:	366	1512	131	87	647	137	278	620	249	120	796	219
PCE Adj:	1.00	1.00	1.00	1.00	1.00	1.00	1.00	1.00	1.00	1.00	1.00	1.00
MLF Adj:	1.00	1.00	1.00	1.00	1.00	1.00	1.00	1.00	1.00	1.00	1.00	1.00
Final Volume:	366	1512	131	87	647	137	278	620	249	120	796	219
Saturation Flow Module:												
Sat/Lane:	1900	1900	1900	1900	1900	1900	1900	1900	1900	1900	1900	1900
Adjustment:	0.83	1.00	0.92	0.92	0.98	0.95	0.92	1.00	0.92	0.92	1.00	0.92
Lanes:	2.00	2.00	1.00	1.00	1.64	0.36	1.00	2.00	1.00	1.00	2.00	1.00
Final Sat.:	3150	3800	1750	1750	3053	646	1750	3800	1750	1750	3800	1750
Capacity Analysis Module:												
Vol/Sat:	0.12	0.40	0.07	0.05	0.21	0.21	0.16	0.16	0.14	0.07	0.21	0.13
Crit Moves:	****			****			****			****		
Green Time:	21.1	52.4	52.4	7.0	38.4	38.4	20.9	34.2	34.2	14.4	27.6	27.6
Volume/Cap:	0.66	0.91	0.17	0.85	0.66	0.66	0.91	0.57	0.50	0.57	0.91	0.54
Delay/Veh:	49.2	39.5	20.7	101.9	36.6	36.6	78.2	37.4	36.6	53.7	58.4	42.2
User DelAdj:	1.00	1.00	1.00	1.00	1.00	1.00	1.00	1.00	1.00	1.00	1.00	1.00
AdjDel/Veh:	49.2	39.5	20.7	101.9	36.6	36.6	78.2	37.4	36.6	53.7	58.4	42.2
LOS by Move:	D	D	C	F	D	D	E	D	D	D	E	D
HCM2k95thQ:	14	46	6	8	23	23	22	18	15	9	28	14

Note: Queue reported is the number of cars per lane.

BART Phase II Extension Project

Level Of Service Computation Report
2000 HCM Operations (Future Volume Alternative)
PM - 2035 No Project Conditions

Intersection #3077: BIRD/SAN CARLOS

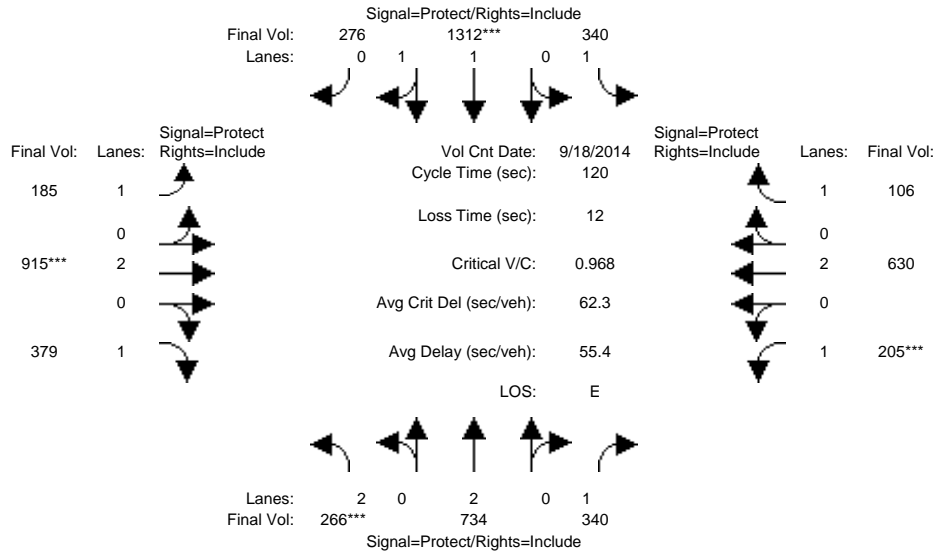

Approach:	North Bound			South Bound			East Bound			West Bound		
	L	T	R	L	T	R	L	T	R	L	T	R
Min. Green:	7	10	10	7	10	10	7	10	10	7	10	10
Y+R:	4.0	4.0	4.0	4.0	4.0	4.0	4.0	4.0	4.0	4.0	4.0	4.0
Volume Module: >> Count Date: 18 Sep 2014 <<												
Base Vol:	266	734	340	340	1312	276	185	915	379	205	630	106
Growth Adj:	1.00	1.00	1.00	1.00	1.00	1.00	1.00	1.00	1.00	1.00	1.00	1.00
Initial Bse:	266	734	340	340	1312	276	185	915	379	205	630	106
Added Vol:	0	0	0	0	0	0	0	0	0	0	0	0
PasserByVol:	0	0	0	0	0	0	0	0	0	0	0	0
Initial Fut:	266	734	340	340	1312	276	185	915	379	205	630	106
User Adj:	1.00	1.00	1.00	1.00	1.00	1.00	1.00	1.00	1.00	1.00	1.00	1.00
PHF Adj:	1.00	1.00	1.00	1.00	1.00	1.00	1.00	1.00	1.00	1.00	1.00	1.00
PHF Volume:	266	734	340	340	1312	276	185	915	379	205	630	106
Reduct Vol:	0	0	0	0	0	0	0	0	0	0	0	0
Reduced Vol:	266	734	340	340	1312	276	185	915	379	205	630	106
PCE Adj:	1.00	1.00	1.00	1.00	1.00	1.00	1.00	1.00	1.00	1.00	1.00	1.00
MLF Adj:	1.00	1.00	1.00	1.00	1.00	1.00	1.00	1.00	1.00	1.00	1.00	1.00
FinalVolume:	266	734	340	340	1312	276	185	915	379	205	630	106
Saturation Flow Module:												
Sat/Lane:	1900	1900	1900	1900	1900	1900	1900	1900	1900	1900	1900	1900
Adjustment:	0.83	1.00	0.92	0.92	0.98	0.95	0.92	1.00	0.92	0.92	1.00	0.92
Lanes:	2.00	2.00	1.00	1.00	1.64	0.36	1.00	2.00	1.00	1.00	2.00	1.00
Final Sat.:	3150	3800	1750	1750	3056	643	1750	3800	1750	1750	3800	1750
Capacity Analysis Module:												
Vol/Sat:	0.08	0.19	0.19	0.19	0.43	0.43	0.11	0.24	0.22	0.12	0.17	0.06
Crit Moves:	****				****		****			****		
Green Time:	10.5	31.8	31.8	31.8	53.2	53.2	17.3	29.8	29.8	14.5	27.1	27.1
Volume/Cap:	0.97	0.73	0.73	0.73	0.97	0.97	0.73	0.97	0.87	0.97	0.73	0.27
Delay/Veh:	100.1	42.9	46.1	46.1	48.0	48.0	59.9	66.5	60.4	105.2	46.5	38.7
User DelAdj:	1.00	1.00	1.00	1.00	1.00	1.00	1.00	1.00	1.00	1.00	1.00	1.00
AdjDel/Veh:	100.1	42.9	46.1	46.1	48.0	48.0	59.9	66.5	60.4	105.2	46.5	38.7
LOS by Move:	F	D	D	D	D	D	E	E	E	F	D	D
HCM2k95thQ:	14	22	23	23	54	54	14	34	28	19	20	7

Note: Queue reported is the number of cars per lane.

BART Phase II Extension Project

Level Of Service Computation Report
 2000 HCM Operations (Future Volume Alternative)
 AM - 2035 No Project Conditions

Intersection #3112: MONTGOMERY/SANTA CLARA

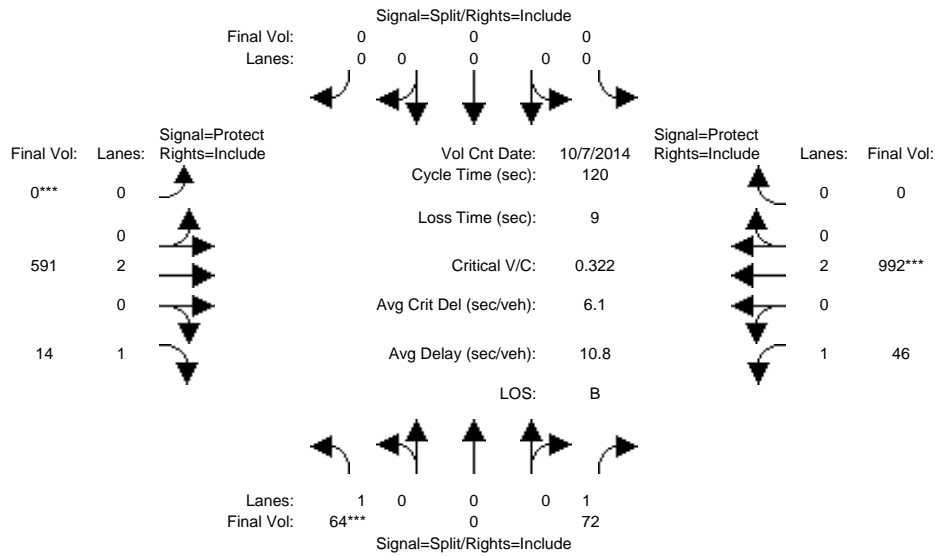

Approach:	North Bound			South Bound			East Bound			West Bound		
	L	T	R	L	T	R	L	T	R	L	T	R
Min. Green:	10	0	10	0	0	0	0	10	10	7	10	0
Y+R:	4.0	4.0	4.0	4.0	4.0	4.0	4.0	4.0	4.0	4.0	4.0	4.0

Volume Module:	>> Count Date: 7 Oct 2014 <<											
Base Vol:	64	0	72	0	0	0	0	591	14	46	992	0
Growth Adj:	1.00	1.00	1.00	1.00	1.00	1.00	1.00	1.00	1.00	1.00	1.00	1.00
Initial Bse:	64	0	72	0	0	0	0	591	14	46	992	0
Added Vol:	0	0	0	0	0	0	0	0	0	0	0	0
PasserByVol:	0	0	0	0	0	0	0	0	0	0	0	0
Initial Fut:	64	0	72	0	0	0	0	591	14	46	992	0
User Adj:	1.00	1.00	1.00	1.00	1.00	1.00	1.00	1.00	1.00	1.00	1.00	1.00
PHF Adj:	1.00	1.00	1.00	1.00	1.00	1.00	1.00	1.00	1.00	1.00	1.00	1.00
PHF Volume:	64	0	72	0	0	0	0	591	14	46	992	0
Reduct Vol:	0	0	0	0	0	0	0	0	0	0	0	0
Reduced Vol:	64	0	72	0	0	0	0	591	14	46	992	0
PCE Adj:	1.00	1.00	1.00	1.00	1.00	1.00	1.00	1.00	1.00	1.00	1.00	1.00
MLF Adj:	1.00	1.00	1.00	1.00	1.00	1.00	1.00	1.00	1.00	1.00	1.00	1.00
FinalVolume:	64	0	72	0	0	0	0	591	14	46	992	0

Saturation Flow Module:												
Sat/Lane:	1900	1900	1900	1900	1900	1900	1900	1900	1900	1900	1900	1900
Adjustment:	0.92	1.00	0.92	0.92	1.00	0.92	0.92	1.00	0.92	0.92	1.00	0.92
Lanes:	1.00	0.00	1.00	0.00	0.00	0.00	0.00	2.00	1.00	1.00	2.00	0.00
Final Sat.:	1750	0	1750	0	0	0	0	3800	1750	1750	3800	0

Capacity Analysis Module:												
Vol/Sat:	0.04	0.00	0.04	0.00	0.00	0.00	0.00	0.16	0.01	0.03	0.26	0.00
Crit Moves:	****							****			****	
Green Time:	15.1	0.0	15.1	0.0	0.0	0.0	0.0	69.7	69.7	26.2	95.9	0.0
Volume/Cap:	0.29	0.00	0.33	0.00	0.00	0.00	0.00	0.27	0.01	0.12	0.33	0.00
Delay/Veh:	48.3	0.0	48.7	0.0	0.0	0.0	0.0	12.5	10.6	37.8	3.3	0.0
User DelAdj:	1.00	1.00	1.00	1.00	1.00	1.00	1.00	1.00	1.00	1.00	1.00	1.00
AdjDel/Veh:	48.3	0.0	48.7	0.0	0.0	0.0	0.0	12.5	10.6	37.8	3.3	0.0
LOS by Move:	D	A	D	A	A	A	A	B	B	D	A	A
HCM2k95thQ:	5	0	6	0	0	0	0	10	0	3	10	0

Note: Queue reported is the number of cars per lane.

BART Phase II Extension Project

Level Of Service Computation Report
 2000 HCM Operations (Future Volume Alternative)
 PM - 2035 No Project Conditions

Intersection #3112: MONTGOMERY/SANTA CLARA

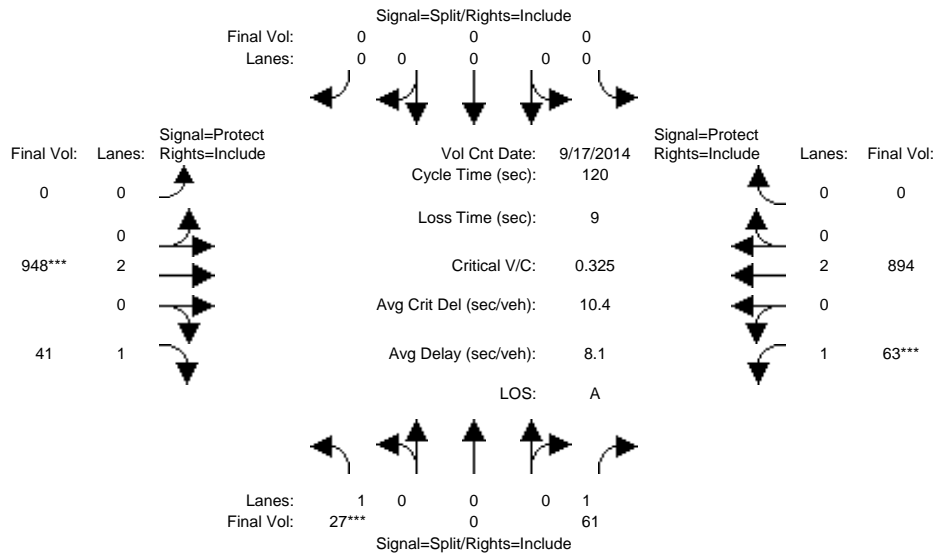

Approach:	North Bound			South Bound			East Bound			West Bound		
	L	T	R	L	T	R	L	T	R	L	T	R
Min. Green:	10	0	10	0	0	0	0	10	10	7	10	0
Y+R:	4.0	4.0	4.0	4.0	4.0	4.0	4.0	4.0	4.0	4.0	4.0	4.0
Volume Module: >> Count Date: 17 Sep 2014 <<												
Base Vol:	27	0	61	0	0	0	0	948	41	63	894	0
Growth Adj:	1.00	1.00	1.00	1.00	1.00	1.00	1.00	1.00	1.00	1.00	1.00	1.00
Initial Bse:	27	0	61	0	0	0	0	948	41	63	894	0
Added Vol:	0	0	0	0	0	0	0	0	0	0	0	0
PasserByVol:	0	0	0	0	0	0	0	0	0	0	0	0
Initial Fut:	27	0	61	0	0	0	0	948	41	63	894	0
User Adj:	1.00	1.00	1.00	1.00	1.00	1.00	1.00	1.00	1.00	1.00	1.00	1.00
PHF Adj:	1.00	1.00	1.00	1.00	1.00	1.00	1.00	1.00	1.00	1.00	1.00	1.00
PHF Volume:	27	0	61	0	0	0	0	948	41	63	894	0
Reduct Vol:	0	0	0	0	0	0	0	0	0	0	0	0
Reduced Vol:	27	0	61	0	0	0	0	948	41	63	894	0
PCE Adj:	1.00	1.00	1.00	1.00	1.00	1.00	1.00	1.00	1.00	1.00	1.00	1.00
MLF Adj:	1.00	1.00	1.00	1.00	1.00	1.00	1.00	1.00	1.00	1.00	1.00	1.00
Final Volume:	27	0	61	0	0	0	0	948	41	63	894	0
Saturation Flow Module:												
Sat/Lane:	1900	1900	1900	1900	1900	1900	1900	1900	1900	1900	1900	1900
Adjustment:	0.92	1.00	0.92	0.92	1.00	0.92	0.92	1.00	0.92	0.92	1.00	0.92
Lanes:	1.00	0.00	1.00	0.00	0.00	0.00	0.00	2.00	1.00	1.00	2.00	0.00
Final Sat.:	1750	0	1750	0	0	0	0	3800	1750	1750	3800	0
Capacity Analysis Module:												
Vol/Sat:	0.02	0.00	0.03	0.00	0.00	0.00	0.00	0.25	0.02	0.04	0.24	0.00
Crit Moves:	****							****		****		
Green Time:	12.9	0.0	12.9	0.0	0.0	0.0	0.0	85.8	85.8	12.4	98.1	0.0
Volume/Cap:	0.14	0.00	0.33	0.00	0.00	0.00	0.00	0.35	0.03	0.35	0.29	0.00
Delay/Veh:	48.9	0.0	50.6	0.0	0.0	0.0	0.0	6.6	5.0	51.2	2.7	0.0
User DelAdj:	1.00	1.00	1.00	1.00	1.00	1.00	1.00	1.00	1.00	1.00	1.00	1.00
AdjDel/Veh:	48.9	0.0	50.6	0.0	0.0	0.0	0.0	6.6	5.0	51.2	2.7	0.0
LOS by Move:	D	A	D	A	A	A	A	A	A	D	A	A
HCM2k95thQ:	2	0	5	0	0	0	0	13	1	5	8	0

Note: Queue reported is the number of cars per lane.

BART Phase II Extension Project

Level Of Service Computation Report
 2000 HCM Operations (Future Volume Alternative)
 AM - 2035 No Project Conditions

Intersection #3227: ALAMEDA/JULIAN

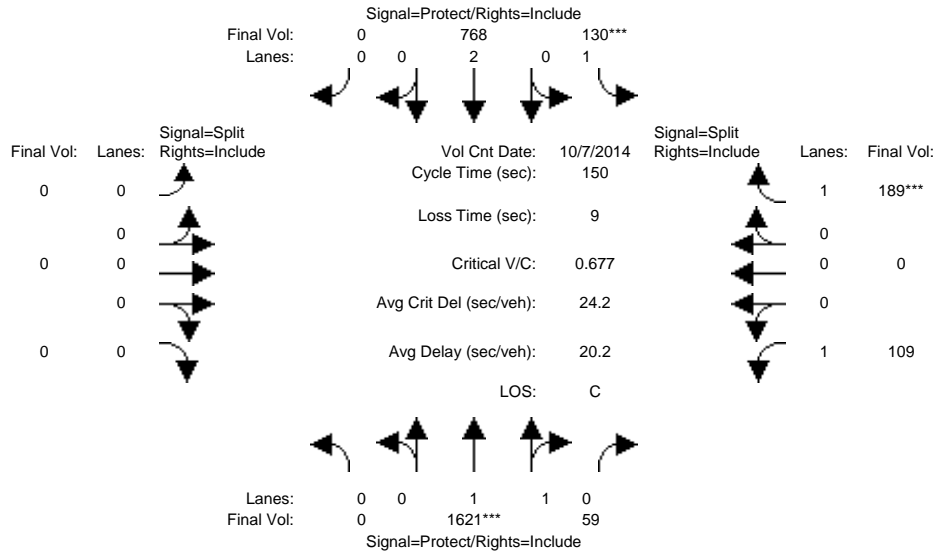

Approach:	North Bound			South Bound			East Bound			West Bound		
Movement:	L	T	R	L	T	R	L	T	R	L	T	R
Min. Green:	0	10	10	7	10	0	0	0	0	10	0	10
Y+R:	4.0	4.0	4.0	4.0	4.0	4.0	4.0	4.0	4.0	4.0	4.0	4.0
Volume Module: >> Count Date: 7 Oct 2014 <<												
Base Vol:	0	1621	59	130	768	0	0	0	0	109	0	189
Growth Adj:	1.00	1.00	1.00	1.00	1.00	1.00	1.00	1.00	1.00	1.00	1.00	1.00
Initial Bse:	0	1621	59	130	768	0	0	0	0	109	0	189
Added Vol:	0	0	0	0	0	0	0	0	0	0	0	0
PasserByVol:	0	0	0	0	0	0	0	0	0	0	0	0
Initial Fut:	0	1621	59	130	768	0	0	0	0	109	0	189
User Adj:	1.00	1.00	1.00	1.00	1.00	1.00	1.00	1.00	1.00	1.00	1.00	1.00
PHF Adj:	1.00	1.00	1.00	1.00	1.00	1.00	1.00	1.00	1.00	1.00	1.00	1.00
PHF Volume:	0	1621	59	130	768	0	0	0	0	109	0	189
Reduct Vol:	0	0	0	0	0	0	0	0	0	0	0	0
Reduced Vol:	0	1621	59	130	768	0	0	0	0	109	0	189
PCE Adj:	1.00	1.00	1.00	1.00	1.00	1.00	1.00	1.00	1.00	1.00	1.00	1.00
MLF Adj:	1.00	1.00	1.00	1.00	1.00	1.00	1.00	1.00	1.00	1.00	1.00	1.00
FinalVolume:	0	1621	59	130	768	0	0	0	0	109	0	189
Saturation Flow Module:												
Sat/Lane:	1900	1900	1900	1900	1900	1900	1900	1900	1900	1900	1900	1900
Adjustment:	0.92	0.97	0.95	0.92	1.00	0.92	0.92	1.00	0.92	0.92	1.00	0.92
Lanes:	0.00	1.93	0.07	1.00	2.00	0.00	0.00	0.00	0.00	1.00	0.00	1.00
Final Sat.:	0	3570	130	1750	3800	0	0	0	0	1750	0	1750
Capacity Analysis Module:												
Vol/Sat:	0.00	0.45	0.45	0.07	0.20	0.00	0.00	0.00	0.00	0.06	0.00	0.11
Crit Moves:	****			****						****		
Green Time:	0.0	101	100.6	16.5	117	0.0	0.0	0.0	0.0	23.9	0.0	23.9
Volume/Cap:	0.00	0.68	0.68	0.68	0.26	0.00	0.00	0.00	0.00	0.39	0.00	0.68
Delay/Veh:	0.0	15.7	15.7	73.5	4.6	0.0	0.0	0.0	0.0	57.4	0.0	65.9
User DelAdj:	1.00	1.00	1.00	1.00	1.00	1.00	1.00	1.00	1.00	1.00	1.00	1.00
AdjDel/Veh:	0.0	15.7	15.7	73.5	4.6	0.0	0.0	0.0	0.0	57.4	0.0	65.9
LOS by Move:	A	B	B	E	A	A	A	A	A	E	A	E
HCM2k95thQ:	0	39	39	12	9	0	0	0	0	9	0	17

Note: Queue reported is the number of cars per lane.

BART Phase II Extension Project

Level Of Service Computation Report
 2000 HCM Operations (Future Volume Alternative)
 PM - 2035 No Project Conditions

Intersection #3227: ALAMEDA/JULIAN

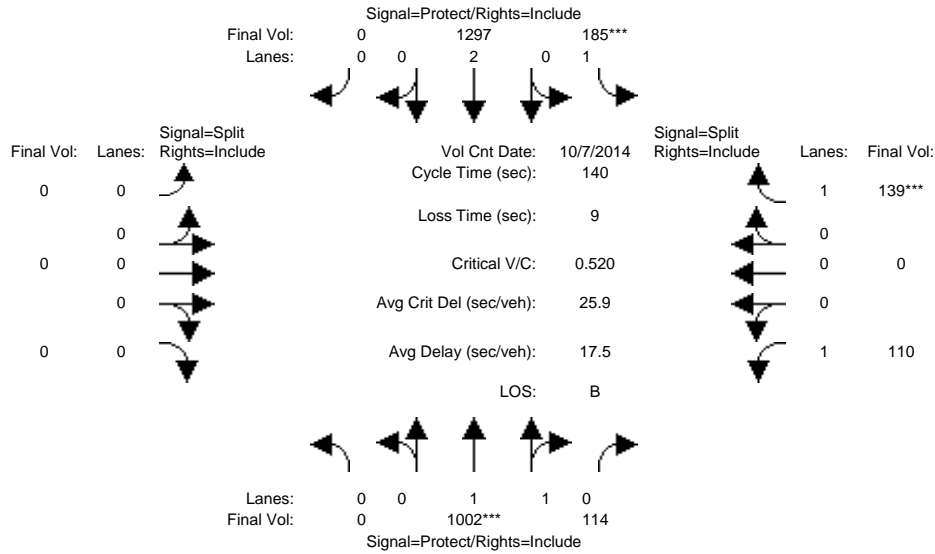

Approach:	North Bound			South Bound			East Bound			West Bound		
	L	T	R	L	T	R	L	T	R	L	T	R
Min. Green:	0	10	10	7	10	0	0	0	0	10	0	10
Y+R:	4.0	4.0	4.0	4.0	4.0	4.0	4.0	4.0	4.0	4.0	4.0	4.0
Volume Module: >> Count Date: 7 Oct 2014 <<												
Base Vol:	0	1002	114	185	1297	0	0	0	0	110	0	139
Growth Adj:	1.00	1.00	1.00	1.00	1.00	1.00	1.00	1.00	1.00	1.00	1.00	1.00
Initial Bse:	0	1002	114	185	1297	0	0	0	0	110	0	139
Added Vol:	0	0	0	0	0	0	0	0	0	0	0	0
PasserByVol:	0	0	0	0	0	0	0	0	0	0	0	0
Initial Fut:	0	1002	114	185	1297	0	0	0	0	110	0	139
User Adj:	1.00	1.00	1.00	1.00	1.00	1.00	1.00	1.00	1.00	1.00	1.00	1.00
PHF Adj:	1.00	1.00	1.00	1.00	1.00	1.00	1.00	1.00	1.00	1.00	1.00	1.00
PHF Volume:	0	1002	114	185	1297	0	0	0	0	110	0	139
Reduct Vol:	0	0	0	0	0	0	0	0	0	0	0	0
Reduced Vol:	0	1002	114	185	1297	0	0	0	0	110	0	139
PCE Adj:	1.00	1.00	1.00	1.00	1.00	1.00	1.00	1.00	1.00	1.00	1.00	1.00
MLF Adj:	1.00	1.00	1.00	1.00	1.00	1.00	1.00	1.00	1.00	1.00	1.00	1.00
FinalVolume:	0	1002	114	185	1297	0	0	0	0	110	0	139
Saturation Flow Module:												
Sat/Lane:	1900	1900	1900	1900	1900	1900	1900	1900	1900	1900	1900	1900
Adjustment:	0.92	0.98	0.95	0.92	1.00	0.92	0.92	1.00	0.92	0.92	1.00	0.92
Lanes:	0.00	1.79	0.21	1.00	2.00	0.00	0.00	0.00	0.00	1.00	0.00	1.00
Final Sat.:	0	3322	378	1750	3800	0	0	0	0	1750	0	1750
Capacity Analysis Module:												
Vol/Sat:	0.00	0.30	0.30	0.11	0.34	0.00	0.00	0.00	0.00	0.06	0.00	0.08
Crit Moves:	****			****						****		
Green Time:	0.0	81.2	81.2	28.4	110	0.0	0.0	0.0	0.0	21.4	0.0	21.4
Volume/Cap:	0.00	0.52	0.52	0.52	0.44	0.00	0.00	0.00	0.00	0.41	0.00	0.52
Delay/Veh:	0.0	17.9	17.9	51.1	5.1	0.0	0.0	0.0	0.0	54.7	0.0	56.4
User DelAdj:	1.00	1.00	1.00	1.00	1.00	1.00	1.00	1.00	1.00	1.00	1.00	1.00
AdjDel/Veh:	0.0	17.9	17.9	51.1	5.1	0.0	0.0	0.0	0.0	54.7	0.0	56.4
LOS by Move:	A	B	B	D	A	A	A	A	A	D	A	E
HCM2k95thQ:	0	25	25	14	17	0	0	0	0	9	0	11

Note: Queue reported is the number of cars per lane.

BART Phase II Extension Project

Level Of Service Computation Report
 2000 HCM Operations (Future Volume Alternative)
 AM - 2035 No Project Conditions

Intersection #3230: ALAMEDA/STOCKTON

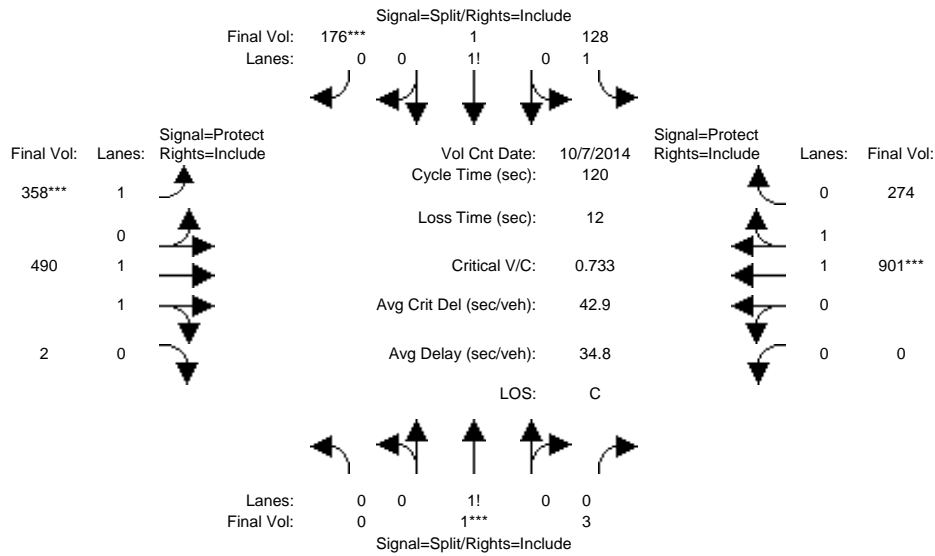

Approach:	North Bound			South Bound			East Bound			West Bound		
	L	T	R	L	T	R	L	T	R	L	T	R
Min. Green:	10	10	10	10	10	10	7	10	10	0	10	10
Y+R:	4.0	4.0	4.0	4.0	4.0	4.0	4.0	4.0	4.0	4.0	4.0	4.0
Volume Module: >> Count Date: 7 Oct 2014 <<												
Base Vol:	0	1	3	128	1	176	358	490	2	0	901	274
Growth Adj:	1.00	1.00	1.00	1.00	1.00	1.00	1.00	1.00	1.00	1.00	1.00	1.00
Initial Bse:	0	1	3	128	1	176	358	490	2	0	901	274
Added Vol:	0	0	0	0	0	0	0	0	0	0	0	0
PasserByVol:	0	0	0	0	0	0	0	0	0	0	0	0
Initial Fut:	0	1	3	128	1	176	358	490	2	0	901	274
User Adj:	1.00	1.00	1.00	1.00	1.00	1.00	1.00	1.00	1.00	1.00	1.00	1.00
PHF Adj:	1.00	1.00	1.00	1.00	1.00	1.00	1.00	1.00	1.00	1.00	1.00	1.00
PHF Volume:	0	1	3	128	1	176	358	490	2	0	901	274
Reduct Vol:	0	0	0	0	0	0	0	0	0	0	0	0
Reduced Vol:	0	1	3	128	1	176	358	490	2	0	901	274
PCE Adj:	1.00	1.00	1.00	1.00	1.00	1.00	1.00	1.00	1.00	1.00	1.00	1.00
MLF Adj:	1.00	1.00	1.00	1.00	1.00	1.00	1.00	1.00	1.00	1.00	1.00	1.00
FinalVolume:	0	1	3	128	1	176	358	490	2	0	901	274
Saturation Flow Module:												
Sat/Lane:	1900	1900	1900	1900	1900	1900	1900	1900	1900	1900	1900	1900
Adjustment:	0.92	0.95	0.95	0.92	0.95	0.95	0.92	0.97	0.95	0.92	0.98	0.95
Lanes:	0.00	0.25	0.75	1.27	0.01	0.72	1.00	1.99	0.01	0.00	1.52	0.48
Final Sat.:	0	450	1350	2224	7	1305	1750	3685	15	0	2837	863
Capacity Analysis Module:												
Vol/Sat:	0.00	0.00	0.00	0.06	0.13	0.13	0.20	0.13	0.13	0.00	0.32	0.32
Crit Moves:	****	****	****	****	****	****	****	****	****	****	****	****
Green Time:	0.0	10.0	10.0	20.1	20.1	20.1	30.5	77.9	77.9	0.0	47.4	47.4
Volume/Cap:	0.00	0.03	0.03	0.34	0.80	0.80	0.80	0.20	0.20	0.00	0.80	0.80
Delay/Veh:	0.0	50.6	50.6	44.3	59.9	59.9	52.2	8.6	8.6	0.0	35.6	35.6
User DelAdj:	1.00	1.00	1.00	1.00	1.00	1.00	1.00	1.00	1.00	1.00	1.00	1.00
AdjDel/Veh:	0.0	50.6	50.6	44.3	59.9	59.9	52.2	8.6	8.6	0.0	35.6	35.6
LOS by Move:	A	D	D	D	E	E	D	A	A	A	D	D
HCM2k95thQ:	0	0	0	7	17	17	25	7	7	0	34	34

Note: Queue reported is the number of cars per lane.

BART Phase II Extension Project

Level Of Service Computation Report
 2000 HCM Operations (Future Volume Alternative)
 PM - 2035 No Project Conditions

Intersection #3230: ALAMEDA/STOCKTON

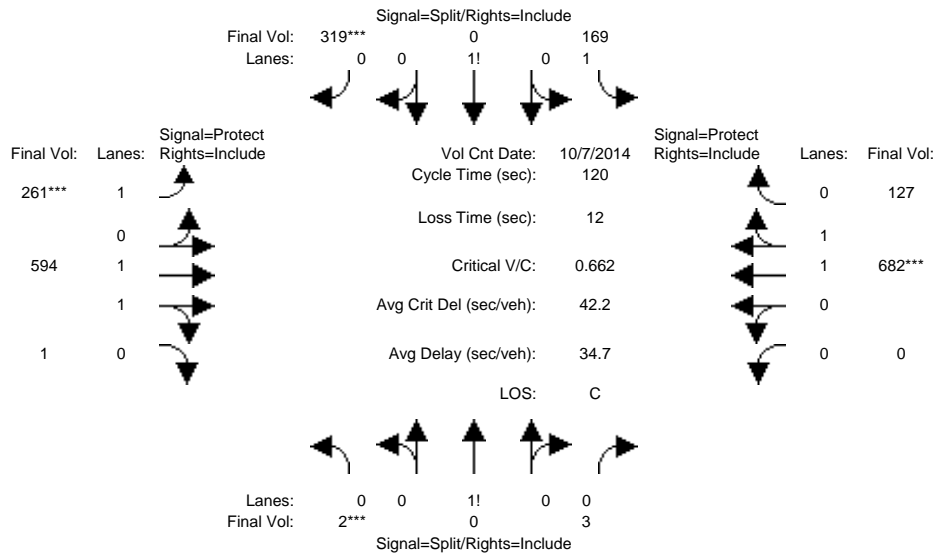

Approach:	North Bound			South Bound			East Bound			West Bound		
	L	T	R	L	T	R	L	T	R	L	T	R
Min. Green:	10	10	10	10	10	10	7	10	10	0	10	10
Y+R:	4.0	4.0	4.0	4.0	4.0	4.0	4.0	4.0	4.0	4.0	4.0	4.0

Volume Module:	>> Count Date: 7 Oct 2014 <<											
Base Vol:	2	0	3	169	0	319	261	594	1	0	682	127
Growth Adj:	1.00	1.00	1.00	1.00	1.00	1.00	1.00	1.00	1.00	1.00	1.00	1.00
Initial Bse:	2	0	3	169	0	319	261	594	1	0	682	127
Added Vol:	0	0	0	0	0	0	0	0	0	0	0	0
PasserByVol:	0	0	0	0	0	0	0	0	0	0	0	0
Initial Fut:	2	0	3	169	0	319	261	594	1	0	682	127
User Adj:	1.00	1.00	1.00	1.00	1.00	1.00	1.00	1.00	1.00	1.00	1.00	1.00
PHF Adj:	1.00	1.00	1.00	1.00	1.00	1.00	1.00	1.00	1.00	1.00	1.00	1.00
PHF Volume:	2	0	3	169	0	319	261	594	1	0	682	127
Reduct Vol:	0	0	0	0	0	0	0	0	0	0	0	0
Reduced Vol:	2	0	3	169	0	319	261	594	1	0	682	127
PCE Adj:	1.00	1.00	1.00	1.00	1.00	1.00	1.00	1.00	1.00	1.00	1.00	1.00
MLF Adj:	1.00	1.00	1.00	1.00	1.00	1.00	1.00	1.00	1.00	1.00	1.00	1.00
Final Volume:	2	0	3	169	0	319	261	594	1	0	682	127

Saturation Flow Module:												
Sat/Lane:	1900	1900	1900	1900	1900	1900	1900	1900	1900	1900	1900	1900
Adjustment:	0.92	0.92	0.92	0.92	1.00	0.95	0.92	0.97	0.95	0.92	0.98	0.95
Lanes:	0.40	0.00	0.60	1.21	0.00	0.79	1.00	1.99	0.01	0.00	1.68	0.32
Final Sat.:	700	0	1050	2125	0	1415	1750	3694	6	0	3119	581

Capacity Analysis Module:												
Vol/Sat:	0.00	0.00	0.00	0.08	0.00	0.23	0.15	0.16	0.16	0.00	0.22	0.22
Crit Moves:	****					****	****			****		
Green Time:	10.0	0.0	10.0	37.2	0.0	37.2	24.6	60.8	60.8	0.0	36.1	36.1
Volume/Cap:	0.03	0.00	0.03	0.26	0.00	0.73	0.73	0.32	0.32	0.00	0.73	0.73
Delay/Veh:	50.7	0.0	50.7	31.1	0.0	40.8	51.8	17.5	17.5	0.0	40.0	40.0
User DelAdj:	1.00	1.00	1.00	1.00	1.00	1.00	1.00	1.00	1.00	1.00	1.00	1.00
AdjDel/Veh:	50.7	0.0	50.7	31.1	0.0	40.8	51.8	17.5	17.5	0.0	40.0	40.0
LOS by Move:	D	A	D	C	A	D	D	B	B	A	D	D
HCM2k95thQ:	0	0	0	8	0	25	18	12	12	0	25	25

Note: Queue reported is the number of cars per lane.

BART Phase II Extension Project

Level Of Service Computation Report
 2000 HCM Operations (Future Volume Alternative)
 AM - 2035 No Project Conditions

Intersection #3263: AUTUMN/JULIAN

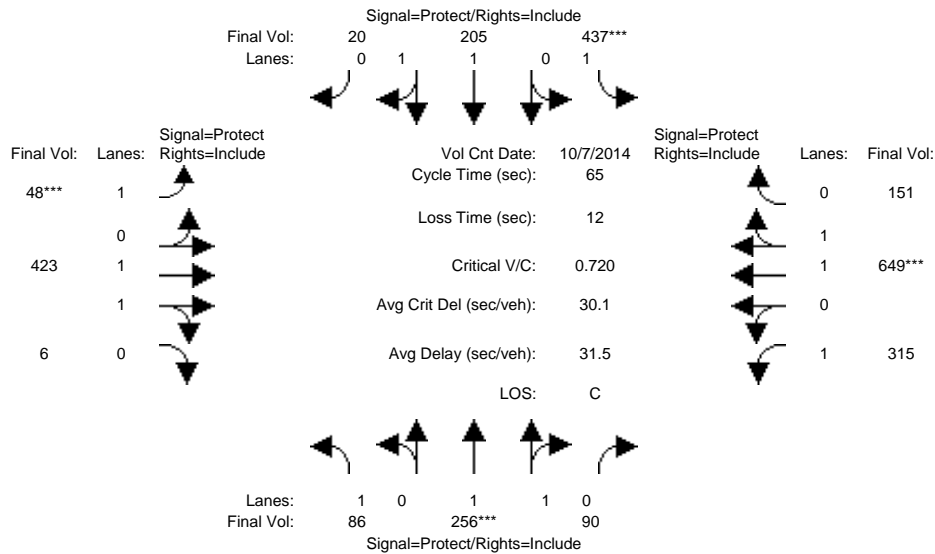

Approach:	North Bound			South Bound			East Bound			West Bound		
Movement:	L	T	R	L	T	R	L	T	R	L	T	R
Min. Green:	7	10	10	7	10	10	7	10	10	7	10	10
Y+R:	4.0	4.0	4.0	4.0	4.0	4.0	4.0	4.0	4.0	4.0	4.0	4.0
Volume Module: >> Count Date: 7 Oct 2014 <<												
Base Vol:	86	256	90	437	205	20	48	423	6	315	649	151
Growth Adj:	1.00	1.00	1.00	1.00	1.00	1.00	1.00	1.00	1.00	1.00	1.00	1.00
Initial Bse:	86	256	90	437	205	20	48	423	6	315	649	151
Added Vol:	0	0	0	0	0	0	0	0	0	0	0	0
PasserByVol:	0	0	0	0	0	0	0	0	0	0	0	0
Initial Fut:	86	256	90	437	205	20	48	423	6	315	649	151
User Adj:	1.00	1.00	1.00	1.00	1.00	1.00	1.00	1.00	1.00	1.00	1.00	1.00
PHF Adj:	1.00	1.00	1.00	1.00	1.00	1.00	1.00	1.00	1.00	1.00	1.00	1.00
PHF Volume:	86	256	90	437	205	20	48	423	6	315	649	151
Reduct Vol:	0	0	0	0	0	0	0	0	0	0	0	0
Reduced Vol:	86	256	90	437	205	20	48	423	6	315	649	151
PCE Adj:	1.00	1.00	1.00	1.00	1.00	1.00	1.00	1.00	1.00	1.00	1.00	1.00
MLF Adj:	1.00	1.00	1.00	1.00	1.00	1.00	1.00	1.00	1.00	1.00	1.00	1.00
FinalVolume:	86	256	90	437	205	20	48	423	6	315	649	151
Saturation Flow Module:												
Sat/Lane:	1900	1900	1900	1900	1900	1900	1900	1900	1900	1900	1900	1900
Adjustment:	0.92	0.98	0.95	0.92	0.98	0.95	0.92	0.97	0.95	0.92	0.98	0.95
Lanes:	1.00	1.47	0.53	1.00	1.82	0.18	1.00	1.97	0.03	1.00	1.61	0.39
Final Sat.:	1750	2737	962	1750	3371	329	1750	3648	52	1750	3001	698
Capacity Analysis Module:												
Vol/Sat:	0.05	0.09	0.09	0.25	0.06	0.06	0.03	0.12	0.12	0.18	0.22	0.22
Crit Moves:	****	****	****	****	****	****	****	****	****	****	****	****
Green Time:	12.1	10.0	10.0	19.3	17.2	17.2	7.0	10.9	10.9	12.8	16.7	16.7
Volume/Cap:	0.26	0.61	0.61	0.84	0.23	0.23	0.25	0.69	0.69	0.92	0.84	0.84
Delay/Veh:	23.1	27.6	27.6	33.2	18.8	18.8	27.3	28.7	28.7	53.7	29.7	29.7
User DelAdj:	1.00	1.00	1.00	1.00	1.00	1.00	1.00	1.00	1.00	1.00	1.00	1.00
AdjDel/Veh:	23.1	27.6	27.6	33.2	18.8	18.8	27.3	28.7	28.7	53.7	29.7	29.7
LOS by Move:	C	C	C	C	B	B	C	C	C	D	C	C
HCM2k95thQ:	3	7	7	22	4	4	2	8	8	15	16	16

Note: Queue reported is the number of cars per lane.

BART Phase II Extension Project

Level Of Service Computation Report
 2000 HCM Operations (Future Volume Alternative)
 PM - 2035 No Project Conditions

Intersection #3263: AUTUMN/JULIAN

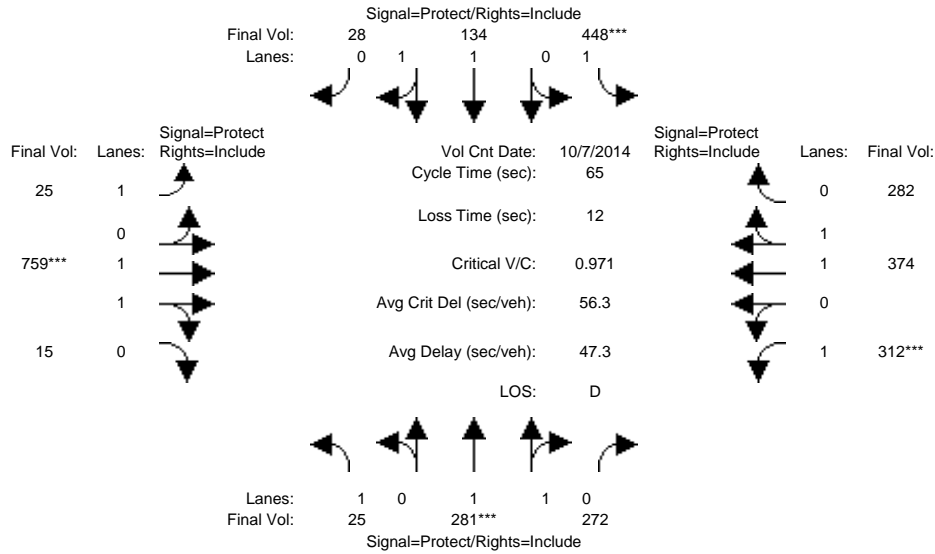

Approach:	North Bound			South Bound			East Bound			West Bound		
	L	T	R	L	T	R	L	T	R	L	T	R
Min. Green:	7	10	10	7	10	10	7	10	10	7	10	10
Y+R:	4.0	4.0	4.0	4.0	4.0	4.0	4.0	4.0	4.0	4.0	4.0	4.0
Volume Module: >> Count Date: 7 Oct 2014 <<												
Base Vol:	25	281	272	448	134	28	25	759	15	312	374	282
Growth Adj:	1.00	1.00	1.00	1.00	1.00	1.00	1.00	1.00	1.00	1.00	1.00	1.00
Initial Bse:	25	281	272	448	134	28	25	759	15	312	374	282
Added Vol:	0	0	0	0	0	0	0	0	0	0	0	0
PasserByVol:	0	0	0	0	0	0	0	0	0	0	0	0
Initial Fut:	25	281	272	448	134	28	25	759	15	312	374	282
User Adj:	1.00	1.00	1.00	1.00	1.00	1.00	1.00	1.00	1.00	1.00	1.00	1.00
PHF Adj:	1.00	1.00	1.00	1.00	1.00	1.00	1.00	1.00	1.00	1.00	1.00	1.00
PHF Volume:	25	281	272	448	134	28	25	759	15	312	374	282
Reduct Vol:	0	0	0	0	0	0	0	0	0	0	0	0
Reduced Vol:	25	281	272	448	134	28	25	759	15	312	374	282
PCE Adj:	1.00	1.00	1.00	1.00	1.00	1.00	1.00	1.00	1.00	1.00	1.00	1.00
MLF Adj:	1.00	1.00	1.00	1.00	1.00	1.00	1.00	1.00	1.00	1.00	1.00	1.00
Final Volume:	25	281	272	448	134	28	25	759	15	312	374	282
Saturation Flow Module:												
Sat/Lane:	1900	1900	1900	1900	1900	1900	1900	1900	1900	1900	1900	1900
Adjustment:	0.92	1.00	0.95	0.92	0.98	0.95	0.92	0.97	0.95	0.92	0.99	0.95
Lanes:	1.00	1.00	1.00	1.00	1.64	0.36	1.00	1.96	0.04	1.00	1.12	0.88
Final Sat.:	1750	1898	1800	1750	3060	639	1750	3628	72	1750	2108	1590
Capacity Analysis Module:												
Vol/Sat:	0.01	0.15	0.15	0.26	0.04	0.04	0.01	0.21	0.21	0.18	0.18	0.18
Crit Moves:	****			****			****			****		
Green Time:	11.2	10.0	10.0	17.1	15.9	15.9	9.8	14.0	14.0	11.9	16.1	16.1
Volume/Cap:	0.08	0.96	0.98	0.97	0.18	0.18	0.09	0.97	0.97	0.97	0.72	0.72
Delay/Veh:	22.7	55.5	60.7	58.5	19.5	19.5	24.0	50.6	50.6	69.1	25.1	25.1
User DelAdj:	1.00	1.00	1.00	1.00	1.00	1.00	1.00	1.00	1.00	1.00	1.00	1.00
AdjDel/Veh:	22.7	55.5	60.7	58.5	19.5	19.5	24.0	50.6	50.6	69.1	25.1	25.1
LOS by Move:	C	E	E	E	B	B	C	D	D	E	C	C
HCM2k95thQ:	1	14	15	27	3	3	1	19	19	17	12	12

Note: Queue reported is the number of cars per lane.

BART Phase II Extension Project

Level Of Service Computation Report
 2000 HCM Operations (Future Volume Alternative)
 AM - 2035 No Project Conditions

Intersection #3264: AUTUMN/SAN FERNANDO

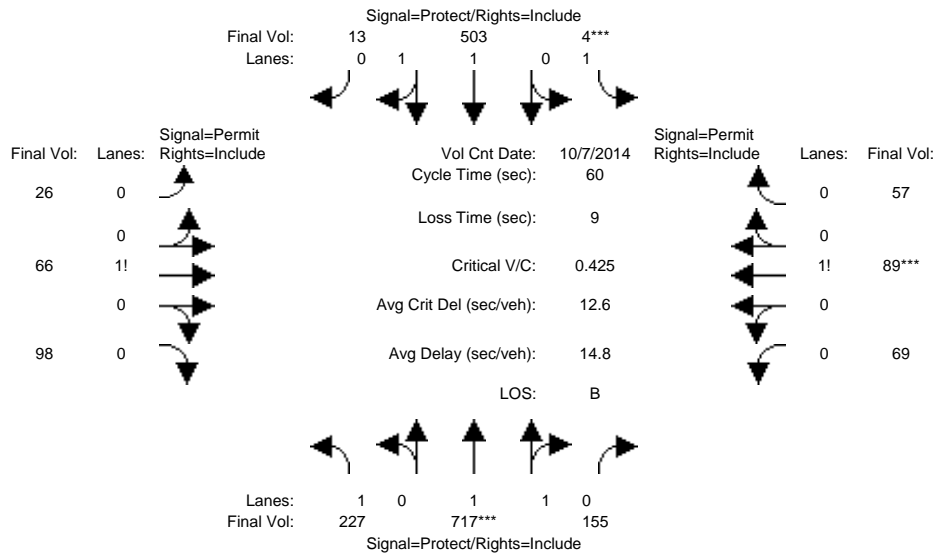

Approach:	North Bound			South Bound			East Bound			West Bound		
	L	T	R	L	T	R	L	T	R	L	T	R
Min. Green:	7	10	10	7	10	10	10	10	10	10	10	10
Y+R:	4.0	4.0	4.0	4.0	4.0	4.0	4.0	4.0	4.0	4.0	4.0	4.0
Volume Module: >> Count Date: 7 Oct 2014 <<												
Base Vol:	227	717	155	4	503	13	26	66	98	69	89	57
Growth Adj:	1.00	1.00	1.00	1.00	1.00	1.00	1.00	1.00	1.00	1.00	1.00	1.00
Initial Bse:	227	717	155	4	503	13	26	66	98	69	89	57
Added Vol:	0	0	0	0	0	0	0	0	0	0	0	0
PasserByVol:	0	0	0	0	0	0	0	0	0	0	0	0
Initial Fut:	227	717	155	4	503	13	26	66	98	69	89	57
User Adj:	1.00	1.00	1.00	1.00	1.00	1.00	1.00	1.00	1.00	1.00	1.00	1.00
PHF Adj:	1.00	1.00	1.00	1.00	1.00	1.00	1.00	1.00	1.00	1.00	1.00	1.00
PHF Volume:	227	717	155	4	503	13	26	66	98	69	89	57
Reduct Vol:	0	0	0	0	0	0	0	0	0	0	0	0
Reduced Vol:	227	717	155	4	503	13	26	66	98	69	89	57
PCE Adj:	1.00	1.00	1.00	1.00	1.00	1.00	1.00	1.00	1.00	1.00	1.00	1.00
MLF Adj:	1.00	1.00	1.00	1.00	1.00	1.00	1.00	1.00	1.00	1.00	1.00	1.00
Final Volume:	227	717	155	4	503	13	26	66	98	69	89	57
Saturation Flow Module:												
Sat/Lane:	1900	1900	1900	1900	1900	1900	1900	1900	1900	1900	1900	1900
Adjustment:	0.92	0.98	0.95	0.92	0.97	0.95	0.92	0.92	0.92	0.92	0.92	0.92
Lanes:	1.00	1.63	0.37	1.00	1.95	0.05	0.14	0.35	0.51	0.32	0.41	0.27
Final Sat.:	1750	3042	658	1750	3607	93	239	608	903	562	724	464
Capacity Analysis Module:												
Vol/Sat:	0.13	0.24	0.24	0.00	0.14	0.14	0.11	0.11	0.11	0.12	0.12	0.12
Crit Moves:	****			****						****		
Green Time:	15.7	28.9	28.9	7.0	20.2	20.2	15.1	15.1	15.1	15.1	15.1	15.1
Volume/Cap:	0.50	0.49	0.49	0.02	0.41	0.41	0.43	0.43	0.43	0.49	0.49	0.49
Delay/Veh:	19.6	10.7	10.7	23.5	15.6	15.6	19.6	19.6	19.6	20.0	20.0	20.0
User DelAdj:	1.00	1.00	1.00	1.00	1.00	1.00	1.00	1.00	1.00	1.00	1.00	1.00
AdjDel/Veh:	19.6	10.7	10.7	23.5	15.6	15.6	19.6	19.6	19.6	20.0	20.0	20.0
LOS by Move:	B	B	B	C	B	B	B	B	B	C	C	C
HCM2k95thQ:	8	11	11	0	8	8	7	7	7	7	7	7

Note: Queue reported is the number of cars per lane.

BART Phase II Extension Project

Level Of Service Computation Report
 2000 HCM Operations (Future Volume Alternative)
 PM - 2035 No Project Conditions

Intersection #3264: AUTUMN/SAN FERNANDO

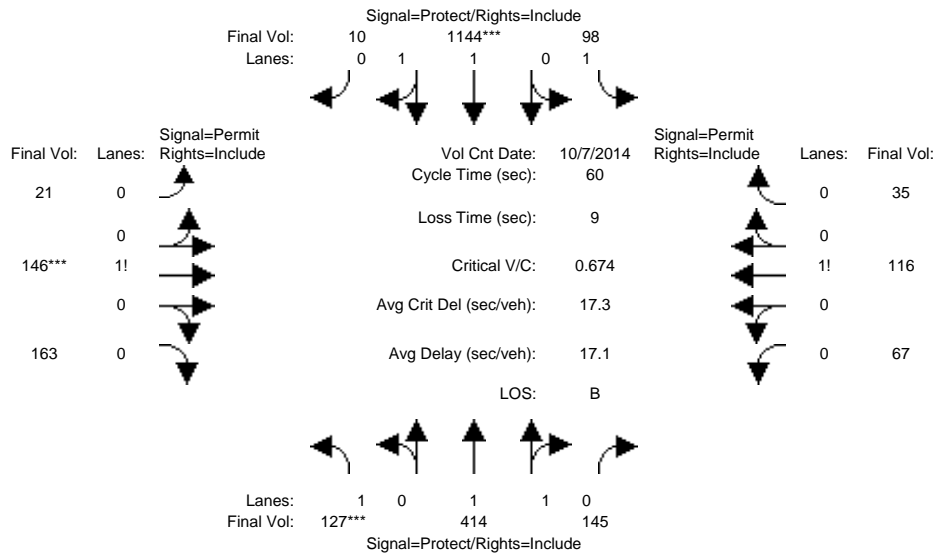

Approach:	North Bound			South Bound			East Bound			West Bound		
	L	T	R	L	T	R	L	T	R	L	T	R
Min. Green:	7	10	10	7	10	10	10	10	10	10	10	10
Y+R:	4.0	4.0	4.0	4.0	4.0	4.0	4.0	4.0	4.0	4.0	4.0	4.0

Volume Module: >> Count Date: 7 Oct 2014 <<

Base Vol:	127	414	145	98	1144	10	21	146	163	67	116	35
Growth Adj:	1.00	1.00	1.00	1.00	1.00	1.00	1.00	1.00	1.00	1.00	1.00	1.00
Initial Bse:	127	414	145	98	1144	10	21	146	163	67	116	35
Added Vol:	0	0	0	0	0	0	0	0	0	0	0	0
PasserByVol:	0	0	0	0	0	0	0	0	0	0	0	0
Initial Fut:	127	414	145	98	1144	10	21	146	163	67	116	35
User Adj:	1.00	1.00	1.00	1.00	1.00	1.00	1.00	1.00	1.00	1.00	1.00	1.00
PHF Adj:	1.00	1.00	1.00	1.00	1.00	1.00	1.00	1.00	1.00	1.00	1.00	1.00
PHF Volume:	127	414	145	98	1144	10	21	146	163	67	116	35
Reduct Vol:	0	0	0	0	0	0	0	0	0	0	0	0
Reduced Vol:	127	414	145	98	1144	10	21	146	163	67	116	35
PCE Adj:	1.00	1.00	1.00	1.00	1.00	1.00	1.00	1.00	1.00	1.00	1.00	1.00
MLF Adj:	1.00	1.00	1.00	1.00	1.00	1.00	1.00	1.00	1.00	1.00	1.00	1.00
FinalVolume:	127	414	145	98	1144	10	21	146	163	67	116	35

Saturation Flow Module:

Sat/Lane:	1900	1900	1900	1900	1900	1900	1900	1900	1900	1900	1900	1900
Adjustment:	0.92	0.98	0.95	0.92	0.97	0.95	0.92	0.92	0.92	0.92	0.92	0.92
Lanes:	1.00	1.47	0.53	1.00	1.98	0.02	0.06	0.44	0.50	0.31	0.53	0.16
Final Sat.:	1750	2740	959	1750	3668	32	111	774	864	538	931	281

Capacity Analysis Module:

Vol/Sat:	0.07	0.15	0.15	0.06	0.31	0.31	0.19	0.19	0.19	0.12	0.12	0.12
Crit Moves:	****			****			****					
Green Time:	7.0	20.2	20.2	14.2	27.4	27.4	16.6	16.6	16.6	16.6	16.6	16.6
Volume/Cap:	0.62	0.45	0.45	0.24	0.68	0.68	0.68	0.68	0.68	0.45	0.45	0.45
Delay/Veh:	31.1	15.8	15.8	18.8	14.0	14.0	23.3	23.3	23.3	18.6	18.6	18.6
User DelAdj:	1.00	1.00	1.00	1.00	1.00	1.00	1.00	1.00	1.00	1.00	1.00	1.00
AdjDel/Veh:	31.1	15.8	15.8	18.8	14.0	14.0	23.3	23.3	23.3	18.6	18.6	18.6
LOS by Move:	C	B	B	B	B	B	C	C	C	B	B	B
HCM2k95thQ:	5	8	8	4	18	18	14	14	14	7	7	7

Note: Queue reported is the number of cars per lane.

BART Phase II Extension Project

Level Of Service Computation Report
2000 HCM Operations (Future Volume Alternative)
AM - 2035 No Project Conditions

Intersection #3266: AUZERAIS/BIRD

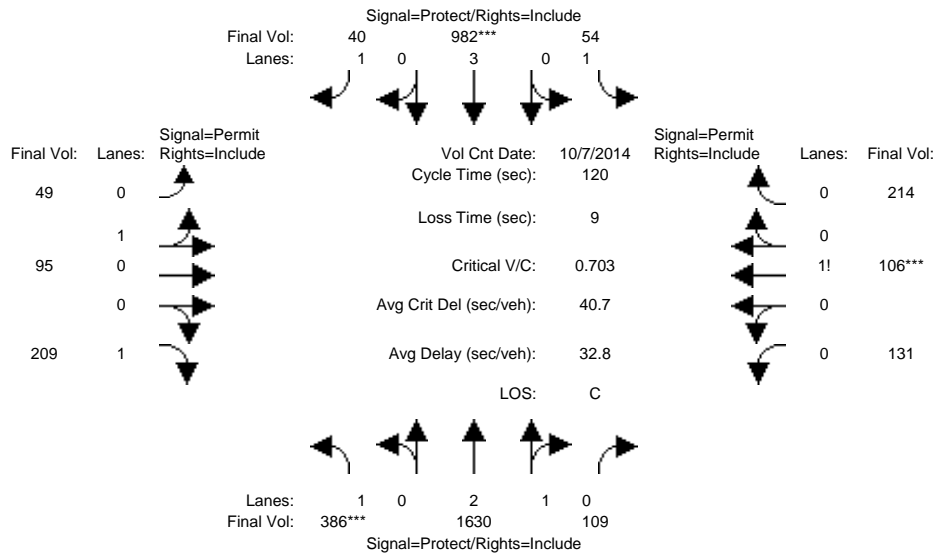

Approach:	North Bound			South Bound			East Bound			West Bound		
Movement:	L	T	R	L	T	R	L	T	R	L	T	R
Min. Green:	7	10	10	7	10	10	10	10	10	10	10	10
Y+R:	4.0	4.0	4.0	4.0	4.0	4.0	4.0	4.0	4.0	4.0	4.0	4.0
Volume Module: >> Count Date: 7 Oct 2014 <<												
Base Vol:	386	1630	109	54	982	40	49	95	209	131	106	214
Growth Adj:	1.00	1.00	1.00	1.00	1.00	1.00	1.00	1.00	1.00	1.00	1.00	1.00
Initial Bse:	386	1630	109	54	982	40	49	95	209	131	106	214
Added Vol:	0	0	0	0	0	0	0	0	0	0	0	0
PasserByVol:	0	0	0	0	0	0	0	0	0	0	0	0
Initial Fut:	386	1630	109	54	982	40	49	95	209	131	106	214
User Adj:	1.00	1.00	1.00	1.00	1.00	1.00	1.00	1.00	1.00	1.00	1.00	1.00
PHF Adj:	1.00	1.00	1.00	1.00	1.00	1.00	1.00	1.00	1.00	1.00	1.00	1.00
PHF Volume:	386	1630	109	54	982	40	49	95	209	131	106	214
Reduct Vol:	0	0	0	0	0	0	0	0	0	0	0	0
Reduced Vol:	386	1630	109	54	982	40	49	95	209	131	106	214
PCE Adj:	1.00	1.00	1.00	1.00	1.00	1.00	1.00	1.00	1.00	1.00	1.00	1.00
MLF Adj:	1.00	1.00	1.00	1.00	1.00	1.00	1.00	1.00	1.00	1.00	1.00	1.00
FinalVolume:	386	1630	109	54	982	40	49	95	209	131	106	214
Saturation Flow Module:												
Sat/Lane:	1900	1900	1900	1900	1900	1900	1900	1900	1900	1900	1900	1900
Adjustment:	0.92	0.98	0.95	0.92	1.00	0.92	0.95	0.95	0.92	0.92	0.92	0.92
Lanes:	1.00	2.81	0.19	1.00	3.00	1.00	0.34	0.66	1.00	0.29	0.24	0.47
Final Sat.:	1750	5249	351	1750	5700	1750	612	1187	1750	508	411	830
Capacity Analysis Module:												
Vol/Sat:	0.22	0.31	0.31	0.03	0.17	0.02	0.08	0.08	0.12	0.26	0.26	0.26
Crit Moves:	****				****						****	
Green Time:	37.6	56.4	56.4	10.6	29.4	29.4	44.0	44.0	44.0	44.0	44.0	44.0
Volume/Cap:	0.70	0.66	0.66	0.35	0.70	0.09	0.22	0.22	0.33	0.70	0.70	0.70
Delay/Veh:	40.4	25.1	25.1	52.8	43.0	35.1	26.3	26.3	27.6	36.0	36.0	36.0
User DelAdj:	1.00	1.00	1.00	1.00	1.00	1.00	1.00	1.00	1.00	1.00	1.00	1.00
AdjDel/Veh:	40.4	25.1	25.1	52.8	43.0	35.1	26.3	26.3	27.6	36.0	36.0	36.0
LOS by Move:	D	C	C	D	D	D	C	C	C	D	D	D
HCM2k95thQ:	24	28	28	4	20	2	7	7	11	27	27	27

Note: Queue reported is the number of cars per lane.

BART Phase II Extension Project

Level Of Service Computation Report
 2000 HCM Operations (Future Volume Alternative)
 PM - 2035 No Project Conditions

Intersection #3266: AUZERAIS/BIRD

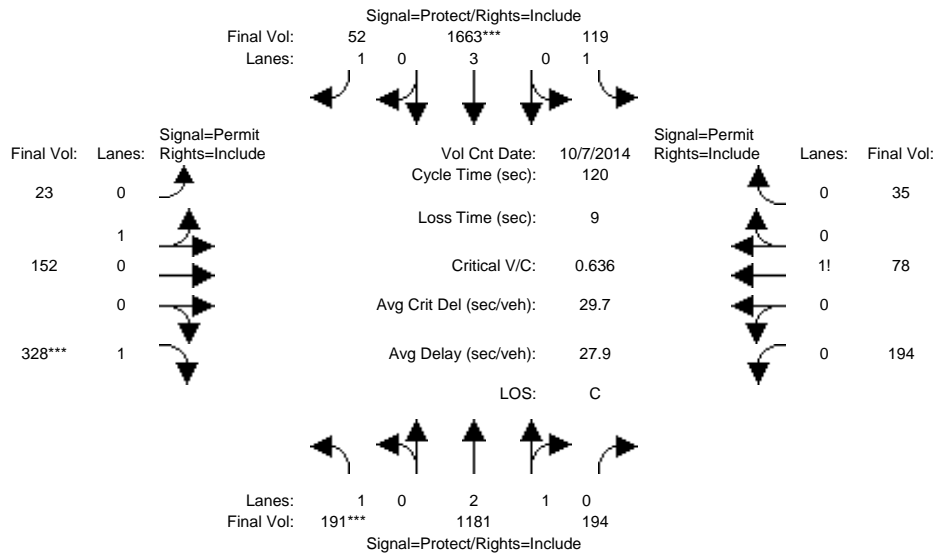

Approach:	North Bound			South Bound			East Bound			West Bound		
	L	T	R	L	T	R	L	T	R	L	T	R
Min. Green:	7	10	10	7	10	10	10	10	10	10	10	10
Y+R:	4.0	4.0	4.0	4.0	4.0	4.0	4.0	4.0	4.0	4.0	4.0	4.0
Volume Module: >> Count Date: 7 Oct 2014 <<												
Base Vol:	191	1181	194	119	1663	52	23	152	328	194	78	35
Growth Adj:	1.00	1.00	1.00	1.00	1.00	1.00	1.00	1.00	1.00	1.00	1.00	1.00
Initial Bse:	191	1181	194	119	1663	52	23	152	328	194	78	35
Added Vol:	0	0	0	0	0	0	0	0	0	0	0	0
PasserByVol:	0	0	0	0	0	0	0	0	0	0	0	0
Initial Fut:	191	1181	194	119	1663	52	23	152	328	194	78	35
User Adj:	1.00	1.00	1.00	1.00	1.00	1.00	1.00	1.00	1.00	1.00	1.00	1.00
PHF Adj:	1.00	1.00	1.00	1.00	1.00	1.00	1.00	1.00	1.00	1.00	1.00	1.00
PHF Volume:	191	1181	194	119	1663	52	23	152	328	194	78	35
Reduct Vol:	0	0	0	0	0	0	0	0	0	0	0	0
Reduced Vol:	191	1181	194	119	1663	52	23	152	328	194	78	35
PCE Adj:	1.00	1.00	1.00	1.00	1.00	1.00	1.00	1.00	1.00	1.00	1.00	1.00
MLF Adj:	1.00	1.00	1.00	1.00	1.00	1.00	1.00	1.00	1.00	1.00	1.00	1.00
FinalVolume:	191	1181	194	119	1663	52	23	152	328	194	78	35
Saturation Flow Module:												
Sat/Lane:	1900	1900	1900	1900	1900	1900	1900	1900	1900	1900	1900	1900
Adjustment:	0.92	0.99	0.95	0.92	1.00	0.92	0.95	0.95	0.92	0.92	0.92	0.92
Lanes:	1.00	2.56	0.44	1.00	3.00	1.00	0.13	0.87	1.00	0.64	0.25	0.11
Final Sat.:	1750	4809	790	1750	5700	1750	237	1563	1750	1106	445	200
Capacity Analysis Module:												
Vol/Sat:	0.11	0.25	0.25	0.07	0.29	0.03	0.10	0.10	0.19	0.18	0.18	0.18
Crit Moves:	****				****				****			
Green Time:	20.6	59.2	59.2	16.4	55.0	55.0	35.4	35.4	35.4	35.4	35.4	35.4
Volume/Cap:	0.64	0.50	0.50	0.50	0.64	0.06	0.33	0.33	0.64	0.60	0.60	0.60
Delay/Veh:	50.7	20.5	20.5	49.6	25.3	18.2	33.4	33.4	39.4	38.1	38.1	38.1
User DelAdj:	1.00	1.00	1.00	1.00	1.00	1.00	1.00	1.00	1.00	1.00	1.00	1.00
AdjDel/Veh:	50.7	20.5	20.5	49.6	25.3	18.2	33.4	33.4	39.4	38.1	38.1	38.1
LOS by Move:	D	C	C	D	C	B	C	C	D	D	D	D
HCM2k95thQ:	14	20	20	9	27	2	10	10	21	19	19	19

Note: Queue reported is the number of cars per lane.

BART Phase II Extension Project

Level Of Service Computation Report
 2000 HCM Operations (Future Volume Alternative)
 AM - 2035 No Project Conditions

Intersection #3363: CAHILL/SANTA CLARA

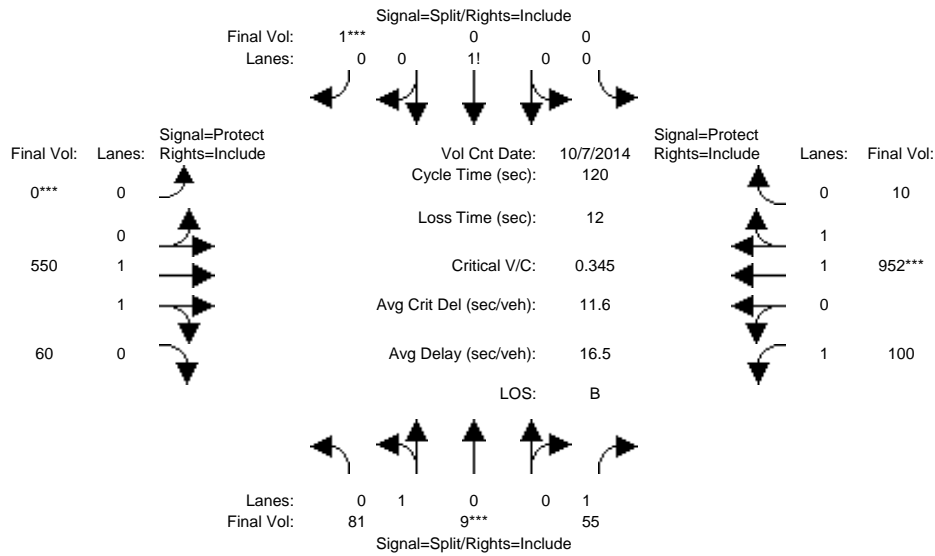

Approach:	North Bound			South Bound			East Bound			West Bound		
	L	T	R	L	T	R	L	T	R	L	T	R
Min. Green:	10	10	10	10	10	10	7	10	10	7	10	10
Y+R:	4.0	4.0	4.0	4.0	4.0	4.0	4.0	4.0	4.0	4.0	4.0	4.0

Volume Module: >> Count Date: 7 Oct 2014 <<

Base Vol:	81	9	55	0	0	1	0	550	60	100	952	10
Growth Adj:	1.00	1.00	1.00	1.00	1.00	1.00	1.00	1.00	1.00	1.00	1.00	1.00
Initial Bse:	81	9	55	0	0	1	0	550	60	100	952	10
Added Vol:	0	0	0	0	0	0	0	0	0	0	0	0
PasserByVol:	0	0	0	0	0	0	0	0	0	0	0	0
Initial Fut:	81	9	55	0	0	1	0	550	60	100	952	10
User Adj:	1.00	1.00	1.00	1.00	1.00	1.00	1.00	1.00	1.00	1.00	1.00	1.00
PHF Adj:	1.00	1.00	1.00	1.00	1.00	1.00	1.00	1.00	1.00	1.00	1.00	1.00
PHF Volume:	81	9	55	0	0	1	0	550	60	100	952	10
Reduct Vol:	0	0	0	0	0	0	0	0	0	0	0	0
Reduced Vol:	81	9	55	0	0	1	0	550	60	100	952	10
PCE Adj:	1.00	1.00	1.00	1.00	1.00	1.00	1.00	1.00	1.00	1.00	1.00	1.00
MLF Adj:	1.00	1.00	1.00	1.00	1.00	1.00	1.00	1.00	1.00	1.00	1.00	1.00
FinalVolume:	81	9	55	0	0	1	0	550	60	100	952	10

Saturation Flow Module:

Sat/Lane:	1900	1900	1900	1900	1900	1900	1900	1900	1900	1900	1900	1900
Adjustment:	0.95	0.95	0.92	0.92	1.00	0.92	0.92	0.98	0.95	0.92	0.97	0.95
Lanes:	0.90	0.10	1.00	0.00	0.00	1.00	0.00	1.80	0.20	1.00	1.98	0.02
Final Sat.:	1620	180	1750	0	0	1750	0	3336	364	1750	3662	38

Capacity Analysis Module:

Vol/Sat:	0.05	0.05	0.03	0.00	0.00	0.00	0.00	0.16	0.16	0.06	0.26	0.26
Crit Moves:	****					****	****				****	
Green Time:	15.8	15.8	15.8	0.0	0.0	10.0	0.0	60.7	60.7	21.5	82.2	82.2
Volume/Cap:	0.38	0.38	0.24	0.00	0.00	0.01	0.00	0.33	0.33	0.32	0.38	0.38
Delay/Veh:	48.6	48.6	47.2	0.0	0.0	50.5	0.0	17.6	17.6	43.5	8.1	8.1
User DelAdj:	1.00	1.00	1.00	1.00	1.00	1.00	1.00	1.00	1.00	1.00	1.00	1.00
AdjDel/Veh:	48.6	48.6	47.2	0.0	0.0	50.5	0.0	17.6	17.6	43.5	8.1	8.1
LOS by Move:	D	D	D	A	A	D	A	B	B	D	A	A
HCM2k95thQ:	7	7	4	0	0	0	0	13	13	7	14	14

Note: Queue reported is the number of cars per lane.

BART Phase II Extension Project

Level Of Service Computation Report
2000 HCM Operations (Future Volume Alternative)
PM - 2035 No Project Conditions

Intersection #3363: CAHILL/SANTA CLARA

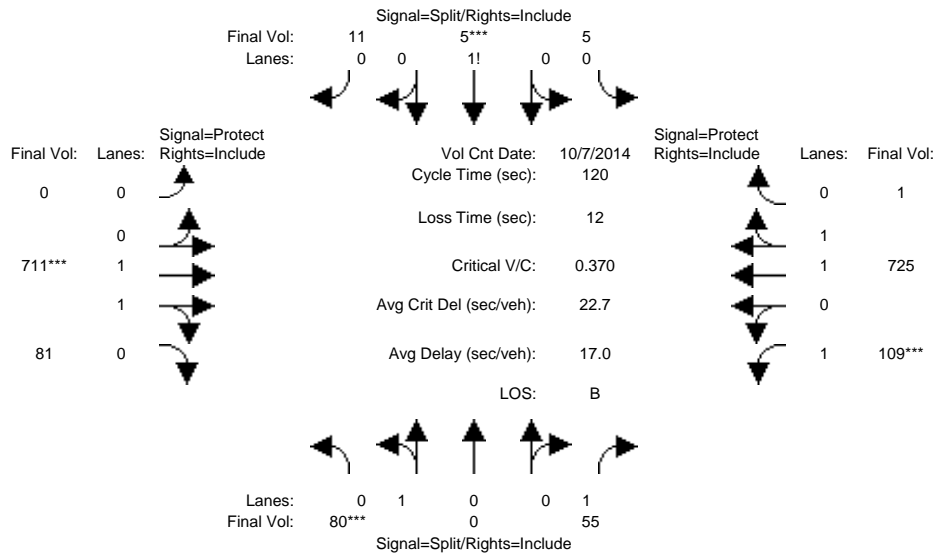

Approach:	North Bound			South Bound			East Bound			West Bound		
	L	T	R	L	T	R	L	T	R	L	T	R
Min. Green:	10	10	10	10	10	10	7	10	10	7	10	10
Y+R:	4.0	4.0	4.0	4.0	4.0	4.0	4.0	4.0	4.0	4.0	4.0	4.0
Volume Module: >> Count Date: 7 Oct 2014 <<												
Base Vol:	80	0	55	5	5	11	0	711	81	109	725	1
Growth Adj:	1.00	1.00	1.00	1.00	1.00	1.00	1.00	1.00	1.00	1.00	1.00	1.00
Initial Bse:	80	0	55	5	5	11	0	711	81	109	725	1
Added Vol:	0	0	0	0	0	0	0	0	0	0	0	0
PasserByVol:	0	0	0	0	0	0	0	0	0	0	0	0
Initial Fut:	80	0	55	5	5	11	0	711	81	109	725	1
User Adj:	1.00	1.00	1.00	1.00	1.00	1.00	1.00	1.00	1.00	1.00	1.00	1.00
PHF Adj:	1.00	1.00	1.00	1.00	1.00	1.00	1.00	1.00	1.00	1.00	1.00	1.00
PHF Volume:	80	0	55	5	5	11	0	711	81	109	725	1
Reduct Vol:	0	0	0	0	0	0	0	0	0	0	0	0
Reduced Vol:	80	0	55	5	5	11	0	711	81	109	725	1
PCE Adj:	1.00	1.00	1.00	1.00	1.00	1.00	1.00	1.00	1.00	1.00	1.00	1.00
MLF Adj:	1.00	1.00	1.00	1.00	1.00	1.00	1.00	1.00	1.00	1.00	1.00	1.00
FinalVolume:	80	0	55	5	5	11	0	711	81	109	725	1
Saturation Flow Module:												
Sat/Lane:	1900	1900	1900	1900	1900	1900	1900	1900	1900	1900	1900	1900
Adjustment:	0.95	0.95	0.92	0.92	0.92	0.92	0.92	0.98	0.95	0.92	0.97	0.95
Lanes:	1.00	0.00	1.00	0.24	0.24	0.52	0.00	1.79	0.21	1.00	1.99	0.01
Final Sat.:	1800	0	1750	417	417	917	0	3321	378	1750	3695	5
Capacity Analysis Module:												
Vol/Sat:	0.04	0.00	0.03	0.01	0.01	0.01	0.00	0.21	0.21	0.06	0.20	0.20
Crit Moves:	****			****			****			****		
Green Time:	13.6	0.0	13.6	10.0	10.0	10.0	0.0	65.4	65.4	19.0	84.4	84.4
Volume/Cap:	0.39	0.00	0.28	0.14	0.14	0.14	0.00	0.39	0.39	0.39	0.28	0.28
Delay/Veh:	50.6	0.0	49.5	51.5	51.5	51.5	0.0	15.9	15.9	46.2	6.6	6.6
User DelAdj:	1.00	1.00	1.00	1.00	1.00	1.00	1.00	1.00	1.00	1.00	1.00	1.00
AdjDel/Veh:	50.6	0.0	49.5	51.5	51.5	51.5	0.0	15.9	15.9	46.2	6.6	6.6
LOS by Move:	D	A	D	D	D	D	A	B	B	D	A	A
HCM2k95thQ:	6	0	4	2	2	2	0	16	16	8	10	10

Note: Queue reported is the number of cars per lane.

BART Phase II Extension Project

Level Of Service Computation Report
 2000 HCM Operations (Future Volume Alternative)
 AM - 2035 No Project Conditions

Intersection #3445: DELMAS/PARK *

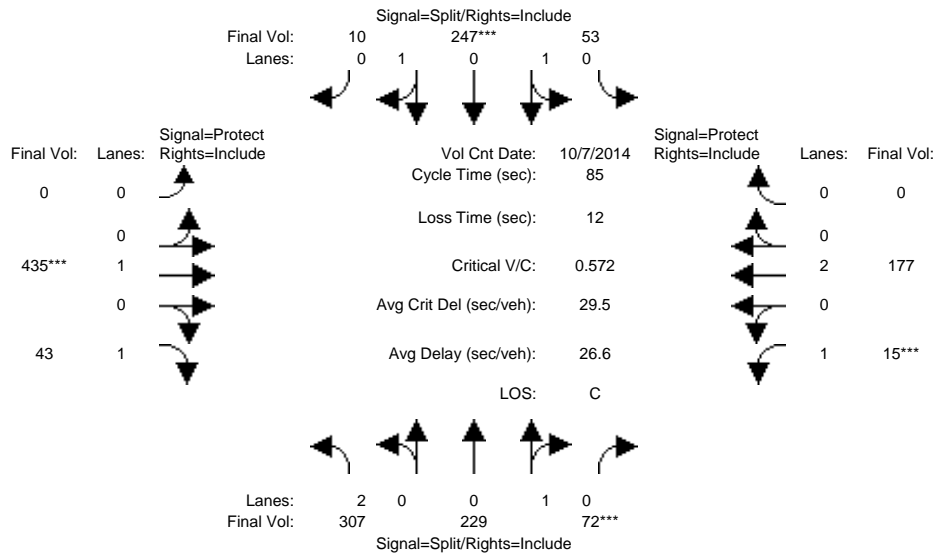

Approach:	North Bound			South Bound			East Bound			West Bound		
	L	T	R	L	T	R	L	T	R	L	T	R
Min. Green:	10	10	10	10	10	10	0	10	10	7	10	0
Y+R:	4.0	4.0	4.0	4.0	4.0	4.0	4.0	4.0	4.0	4.0	4.0	4.0

Volume Module: >> Count Date: 7 Oct 2014 <<

Base Vol:	307	229	72	53	247	10	0	435	43	15	177	0
Growth Adj:	1.00	1.00	1.00	1.00	1.00	1.00	1.00	1.00	1.00	1.00	1.00	1.00
Initial Bse:	307	229	72	53	247	10	0	435	43	15	177	0
Added Vol:	0	0	0	0	0	0	0	0	0	0	0	0
PasserByVol:	0	0	0	0	0	0	0	0	0	0	0	0
Initial Fut:	307	229	72	53	247	10	0	435	43	15	177	0
User Adj:	1.00	1.00	1.00	1.00	1.00	1.00	1.00	1.00	1.00	1.00	1.00	1.00
PHF Adj:	1.00	1.00	1.00	1.00	1.00	1.00	1.00	1.00	1.00	1.00	1.00	1.00
PHF Volume:	307	229	72	53	247	10	0	435	43	15	177	0
Reduct Vol:	0	0	0	0	0	0	0	0	0	0	0	0
Reduced Vol:	307	229	72	53	247	10	0	435	43	15	177	0
PCE Adj:	1.00	1.00	1.00	1.00	1.00	1.00	1.00	1.00	1.00	1.00	1.00	1.00
MLF Adj:	1.00	1.00	1.00	1.00	1.00	1.00	1.00	1.00	1.00	1.00	1.00	1.00
Final Volume:	307	229	72	53	247	10	0	435	43	15	177	0

Saturation Flow Module:

Sat/Lane:	1900	1900	1900	1900	1900	1900	1900	1900	1900	1900	1900	1900
Adjustment:	0.83	0.95	0.95	0.95	0.95	0.95	0.92	1.00	0.92	0.92	1.00	0.92
Lanes:	2.00	0.76	0.24	0.34	1.60	0.06	0.00	1.00	1.00	1.00	2.00	0.00
Final Sat.:	3150	1369	431	615	2868	116	0	1900	1750	1750	3800	0

Capacity Analysis Module:

Vol/Sat:	0.10	0.17	0.17	0.09	0.09	0.09	0.00	0.23	0.02	0.01	0.05	0.00
Crit Moves:			****		****			****		****		
Green Time:	22.9	22.9	22.9	11.8	11.8	11.8	0.0	31.3	31.3	7.0	38.3	0.0
Volume/Cap:	0.36	0.62	0.62	0.62	0.62	0.62	0.00	0.62	0.07	0.10	0.10	0.00
Delay/Veh:	25.4	29.7	29.7	36.9	36.9	36.9	0.0	23.7	17.4	36.4	13.5	0.0
User DelAdj:	1.00	1.00	1.00	1.00	1.00	1.00	1.00	1.00	1.00	1.00	1.00	1.00
AdjDel/Veh:	25.4	29.7	29.7	36.9	36.9	36.9	0.0	23.7	17.4	36.4	13.5	0.0
LOS by Move:	C	C	C	D	D	D	A	C	B	D	B	A
HCM2k95thQ:	8	15	15	8	8	8	0	17	2	1	3	0

Note: Queue reported is the number of cars per lane.

BART Phase II Extension Project

Level Of Service Computation Report
 2000 HCM Operations (Future Volume Alternative)
 PM - 2035 No Project Conditions

Intersection #3445: DELMAS/PARK *

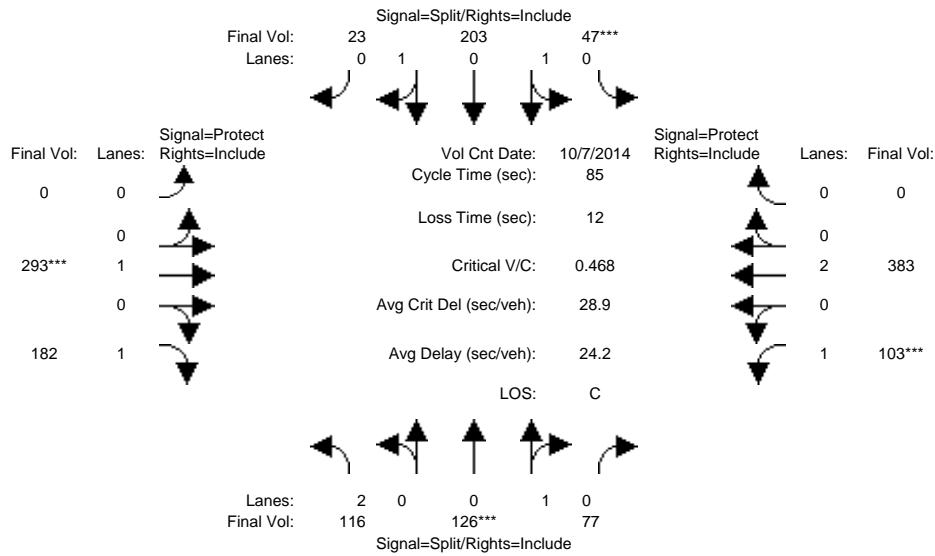

Approach:	North Bound			South Bound			East Bound			West Bound		
	L	T	R	L	T	R	L	T	R	L	T	R
Min. Green:	10	10	10	10	10	10	0	10	10	7	10	0
Y+R:	4.0	4.0	4.0	4.0	4.0	4.0	4.0	4.0	4.0	4.0	4.0	4.0
Volume Module: >> Count Date: 7 Oct 2014 <<												
Base Vol:	116	126	77	47	203	23	0	293	182	103	383	0
Growth Adj:	1.00	1.00	1.00	1.00	1.00	1.00	1.00	1.00	1.00	1.00	1.00	1.00
Initial Bse:	116	126	77	47	203	23	0	293	182	103	383	0
Added Vol:	0	0	0	0	0	0	0	0	0	0	0	0
PasserByVol:	0	0	0	0	0	0	0	0	0	0	0	0
Initial Fut:	116	126	77	47	203	23	0	293	182	103	383	0
User Adj:	1.00	1.00	1.00	1.00	1.00	1.00	1.00	1.00	1.00	1.00	1.00	1.00
PHF Adj:	1.00	1.00	1.00	1.00	1.00	1.00	1.00	1.00	1.00	1.00	1.00	1.00
PHF Volume:	116	126	77	47	203	23	0	293	182	103	383	0
Reduct Vol:	0	0	0	0	0	0	0	0	0	0	0	0
Reduced Vol:	116	126	77	47	203	23	0	293	182	103	383	0
PCE Adj:	1.00	1.00	1.00	1.00	1.00	1.00	1.00	1.00	1.00	1.00	1.00	1.00
MLF Adj:	1.00	1.00	1.00	1.00	1.00	1.00	1.00	1.00	1.00	1.00	1.00	1.00
FinalVolume:	116	126	77	47	203	23	0	293	182	103	383	0
Saturation Flow Module:												
Sat/Lane:	1900	1900	1900	1900	1900	1900	1900	1900	1900	1900	1900	1900
Adjustment:	0.83	0.95	0.95	0.95	0.95	0.95	0.92	1.00	0.92	0.92	1.00	0.92
Lanes:	2.00	0.62	0.38	0.34	1.49	0.17	0.00	1.00	1.00	1.00	2.00	0.00
Final Sat.:	3150	1117	683	620	2677	303	0	1900	1750	1750	3800	0
Capacity Analysis Module:												
Vol/Sat:	0.04	0.11	0.11	0.08	0.08	0.08	0.00	0.15	0.10	0.06	0.10	0.00
Crit Moves:	****	****	****	****	****	****	****	****	****	****	****	****
Green Time:	20.5	20.5	20.5	13.8	13.8	13.8	0.0	28.0	28.0	10.7	38.7	0.0
Volume/Cap:	0.15	0.47	0.47	0.47	0.47	0.47	0.00	0.47	0.32	0.47	0.22	0.00
Delay/Veh:	25.5	28.4	28.4	32.9	32.9	32.9	0.0	23.1	21.6	36.1	14.1	0.0
User DelAdj:	1.00	1.00	1.00	1.00	1.00	1.00	1.00	1.00	1.00	1.00	1.00	1.00
AdjDel/Veh:	25.5	28.4	28.4	32.9	32.9	32.9	0.0	23.1	21.6	36.1	14.1	0.0
LOS by Move:	C	C	C	C	C	C	A	C	C	D	B	A
HCM2k95thQ:	3	10	10	7	7	7	0	11	7	5	6	0

Note: Queue reported is the number of cars per lane.

BART Phase II Extension Project

Level Of Service Computation Report
 2000 HCM Operations (Future Volume Alternative)
 AM - 2035 No Project Conditions

Intersection #3552: FRUITDALE/MERIDIAN

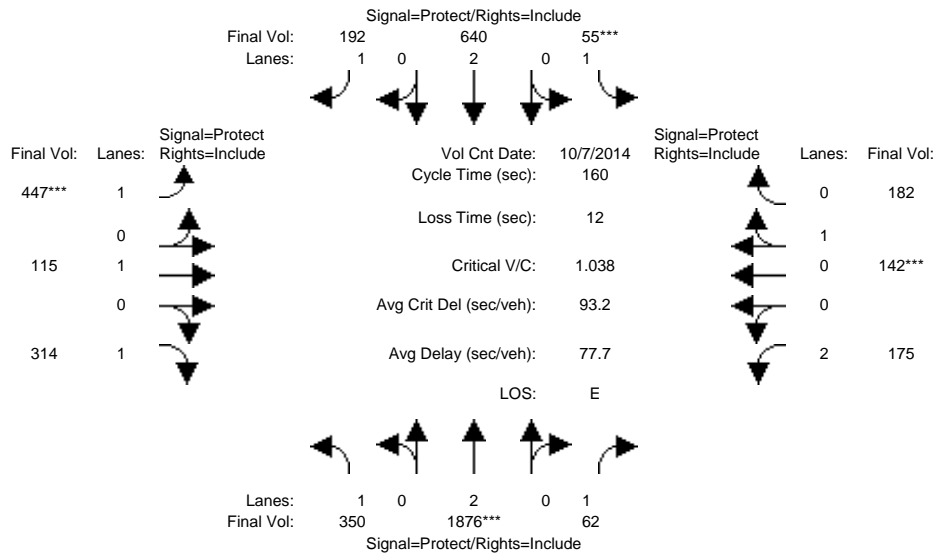

Approach:	North Bound			South Bound			East Bound			West Bound		
Movement:	L	T	R	L	T	R	L	T	R	L	T	R
Min. Green:	7	10	10	7	10	10	7	10	10	7	10	10
Y+R:	4.0	4.0	4.0	4.0	4.0	4.0	4.0	4.0	4.0	4.0	4.0	4.0
Volume Module: >> Count Date: 7 Oct 2014 <<												
Base Vol:	350	1876	62	55	640	192	447	115	314	175	142	182
Growth Adj:	1.00	1.00	1.00	1.00	1.00	1.00	1.00	1.00	1.00	1.00	1.00	1.00
Initial Bse:	350	1876	62	55	640	192	447	115	314	175	142	182
Added Vol:	0	0	0	0	0	0	0	0	0	0	0	0
PasserByVol:	0	0	0	0	0	0	0	0	0	0	0	0
Initial Fut:	350	1876	62	55	640	192	447	115	314	175	142	182
User Adj:	1.00	1.00	1.00	1.00	1.00	1.00	1.00	1.00	1.00	1.00	1.00	1.00
PHF Adj:	1.00	1.00	1.00	1.00	1.00	1.00	1.00	1.00	1.00	1.00	1.00	1.00
PHF Volume:	350	1876	62	55	640	192	447	115	314	175	142	182
Reduct Vol:	0	0	0	0	0	0	0	0	0	0	0	0
Reduced Vol:	350	1876	62	55	640	192	447	115	314	175	142	182
PCE Adj:	1.00	1.00	1.00	1.00	1.00	1.00	1.00	1.00	1.00	1.00	1.00	1.00
MLF Adj:	1.00	1.00	1.00	1.00	1.00	1.00	1.00	1.00	1.00	1.00	1.00	1.00
Final Volume:	350	1876	62	55	640	192	447	115	314	175	142	182
Saturation Flow Module:												
Sat/Lane:	1900	1900	1900	1900	1900	1900	1900	1900	1900	1900	1900	1900
Adjustment:	0.92	1.00	0.92	0.92	1.00	0.92	0.92	1.00	0.92	0.83	0.95	0.95
Lanes:	1.00	2.00	1.00	1.00	2.00	1.00	1.00	1.00	1.00	2.00	0.44	0.56
Final Sat.:	1750	3800	1750	1750	3800	1750	1750	1900	1750	3150	789	1011
Capacity Analysis Module:												
Vol/Sat:	0.20	0.49	0.04	0.03	0.17	0.11	0.26	0.06	0.18	0.06	0.18	0.18
Crit Moves:	****			****			****			****		
Green Time:	44.5	74.9	74.9	7.0	37.4	37.4	38.8	50.5	50.5	15.6	27.3	27.3
Volume/Cap:	0.72	1.05	0.08	0.72	0.72	0.47	1.05	0.19	0.57	0.57	1.05	1.05
Delay/Veh:	57.3	79.8	23.5	103.3	59.3	53.6	119.4	40.1	47.1	71.5	133	132.7
User DelAdj:	1.00	1.00	1.00	1.00	1.00	1.00	1.00	1.00	1.00	1.00	1.00	1.00
AdjDel/Veh:	57.3	79.8	23.5	103.3	59.3	53.6	119.4	40.1	47.1	71.5	133	132.7
LOS by Move:	E	E	C	F	E	D	F	D	D	E	F	F
HCM2k95thQ:	30	85	4	6	26	16	47	8	24	11	38	38

Note: Queue reported is the number of cars per lane.

BART Phase II Extension Project

Level Of Service Computation Report
 2000 HCM Operations (Future Volume Alternative)
 PM - 2035 No Project Conditions

Intersection #3552: FRUITDALE/MERIDIAN

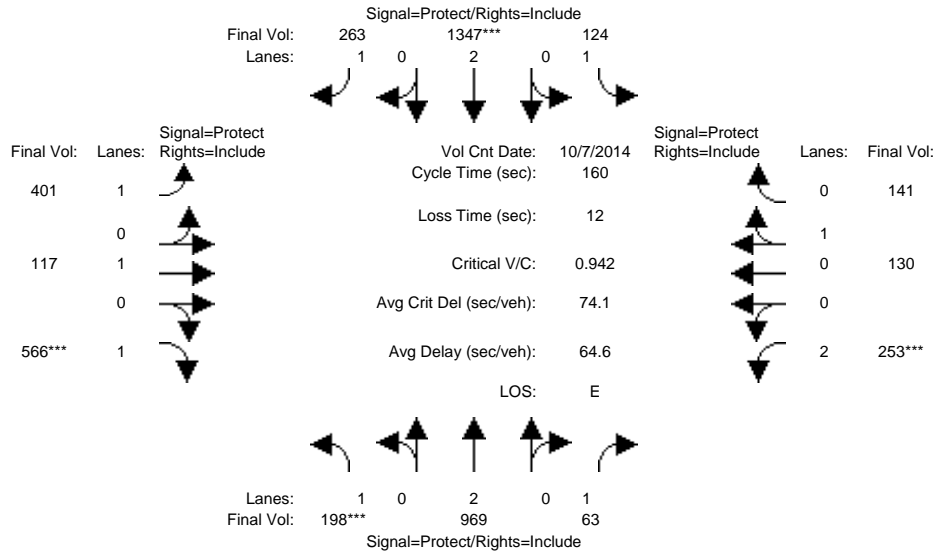

Approach:	North Bound			South Bound			East Bound			West Bound		
Movement:	L	T	R	L	T	R	L	T	R	L	T	R
Min. Green:	7	10	10	7	10	10	7	10	10	7	10	10
Y+R:	4.0	4.0	4.0	4.0	4.0	4.0	4.0	4.0	4.0	4.0	4.0	4.0
Volume Module: >> Count Date: 7 Oct 2014 <<												
Base Vol:	198	969	63	124	1347	263	401	117	566	253	130	141
Growth Adj:	1.00	1.00	1.00	1.00	1.00	1.00	1.00	1.00	1.00	1.00	1.00	1.00
Initial Bse:	198	969	63	124	1347	263	401	117	566	253	130	141
Added Vol:	0	0	0	0	0	0	0	0	0	0	0	0
PasserByVol:	0	0	0	0	0	0	0	0	0	0	0	0
Initial Fut:	198	969	63	124	1347	263	401	117	566	253	130	141
User Adj:	1.00	1.00	1.00	1.00	1.00	1.00	1.00	1.00	1.00	1.00	1.00	1.00
PHF Adj:	1.00	1.00	1.00	1.00	1.00	1.00	1.00	1.00	1.00	1.00	1.00	1.00
PHF Volume:	198	969	63	124	1347	263	401	117	566	253	130	141
Reduct Vol:	0	0	0	0	0	0	0	0	0	0	0	0
Reduced Vol:	198	969	63	124	1347	263	401	117	566	253	130	141
PCE Adj:	1.00	1.00	1.00	1.00	1.00	1.00	1.00	1.00	1.00	1.00	1.00	1.00
MLF Adj:	1.00	1.00	1.00	1.00	1.00	1.00	1.00	1.00	1.00	1.00	1.00	1.00
Final Volume:	198	969	63	124	1347	263	401	117	566	253	130	141
Saturation Flow Module:												
Sat/Lane:	1900	1900	1900	1900	1900	1900	1900	1900	1900	1900	1900	1900
Adjustment:	0.92	1.00	0.92	0.92	1.00	0.92	0.92	1.00	0.92	0.83	0.95	0.95
Lanes:	1.00	2.00	1.00	1.00	2.00	1.00	1.00	1.00	1.00	2.00	0.48	0.52
Final Sat.:	1750	3800	1750	1750	3800	1750	1750	1900	1750	3150	863	937
Capacity Analysis Module:												
Vol/Sat:	0.11	0.26	0.04	0.07	0.35	0.15	0.23	0.06	0.32	0.08	0.15	0.15
Crit Moves:	****			****			****		****	****		
Green Time:	19.2	62.2	62.2	17.3	60.2	60.2	41.4	54.9	54.9	13.6	27.2	27.2
Volume/Cap:	0.94	0.66	0.09	0.66	0.94	0.40	0.89	0.18	0.94	0.94	0.89	0.89
Delay/Veh:	115.6	41.2	31.1	76.7	60.7	37.0	75.6	36.9	74.3	112.2	90.0	90.0
User DelAdj:	1.00	1.00	1.00	1.00	1.00	1.00	1.00	1.00	1.00	1.00	1.00	1.00
AdjDel/Veh:	115.6	41.2	31.1	76.7	60.7	37.0	75.6	36.9	74.3	112.2	90.0	90.0
LOS by Move:	F	D	C	E	E	D	E	D	E	F	F	F
HCM2k95thQ:	25	33	4	12	55	18	36	7	50	19	29	29

Note: Queue reported is the number of cars per lane.

BART Phase II Extension Project

Level Of Service Computation Report
 2000 HCM Operations (Future Volume Alternative)
 AM - 2035 No Project Conditions

Intersection #3553: FRUITDALE/SOUTHWEST

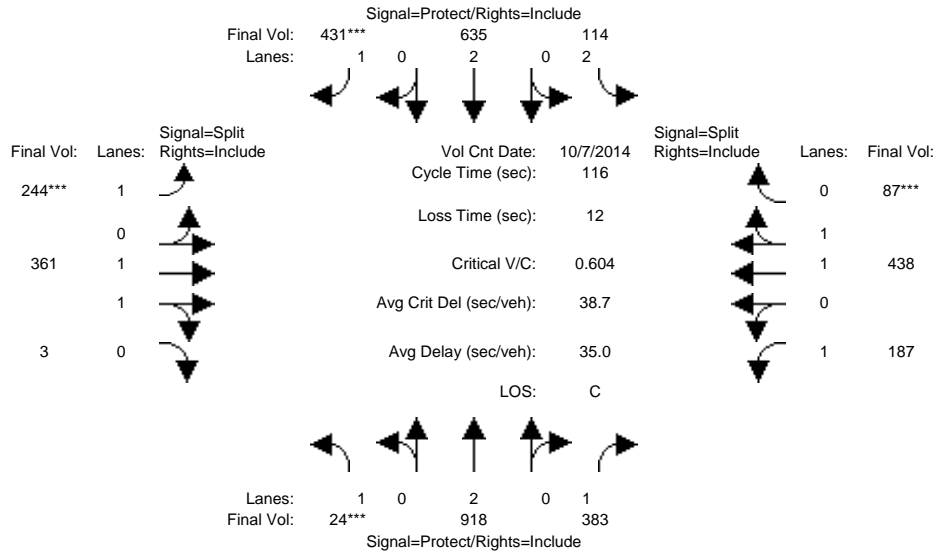

Approach:	North Bound			South Bound			East Bound			West Bound		
	L	T	R	L	T	R	L	T	R	L	T	R
Min. Green:	7	10	10	7	10	10	10	10	10	10	10	10
Y+R:	4.0	4.0	4.0	4.0	4.0	4.0	4.0	4.0	4.0	4.0	4.0	4.0

Volume Module:	>>	Count	Date:	7 Oct 2014	<<							
Base Vol:	24	918	383	114	635	431	244	361	3	187	438	87
Growth Adj:	1.00	1.00	1.00	1.00	1.00	1.00	1.00	1.00	1.00	1.00	1.00	1.00
Initial Bse:	24	918	383	114	635	431	244	361	3	187	438	87
Added Vol:	0	0	0	0	0	0	0	0	0	0	0	0
PasserByVol:	0	0	0	0	0	0	0	0	0	0	0	0
Initial Fut:	24	918	383	114	635	431	244	361	3	187	438	87
User Adj:	1.00	1.00	1.00	1.00	1.00	1.00	1.00	1.00	1.00	1.00	1.00	1.00
PHF Adj:	1.00	1.00	1.00	1.00	1.00	1.00	1.00	1.00	1.00	1.00	1.00	1.00
PHF Volume:	24	918	383	114	635	431	244	361	3	187	438	87
Reduct Vol:	0	0	0	0	0	0	0	0	0	0	0	0
Reduced Vol:	24	918	383	114	635	431	244	361	3	187	438	87
PCE Adj:	1.00	1.00	1.00	1.00	1.00	1.00	1.00	1.00	1.00	1.00	1.00	1.00
MLF Adj:	1.00	1.00	1.00	1.00	1.00	1.00	1.00	1.00	1.00	1.00	1.00	1.00
FinalVolume:	24	918	383	114	635	431	244	361	3	187	438	87

Saturation Flow Module:												
Sat/Lane:	1900	1900	1900	1900	1900	1900	1900	1900	1900	1900	1900	1900
Adjustment:	0.92	1.00	0.92	0.83	1.00	0.92	0.92	0.97	0.95	0.92	0.98	0.95
Lanes:	1.00	2.00	1.00	2.00	2.00	1.00	1.00	1.98	0.02	1.00	1.66	0.34
Final Sat.:	1750	3800	1750	3150	3800	1750	1750	3669	30	1750	3086	613

Capacity Analysis Module:												
Vol/Sat:	0.01	0.24	0.22	0.04	0.17	0.25	0.14	0.10	0.10	0.11	0.14	0.14
Crit Moves:	****					****	****					****
Green Time:	7.0	41.8	41.8	10.4	45.3	45.3	25.6	25.6	25.6	26.1	26.1	26.1
Volume/Cap:	0.23	0.67	0.61	0.40	0.43	0.63	0.63	0.45	0.45	0.48	0.63	0.63
Delay/Veh:	53.0	32.6	32.1	50.8	26.1	30.5	44.3	39.4	39.4	39.9	42.2	42.2
User DelAdj:	1.00	1.00	1.00	1.00	1.00	1.00	1.00	1.00	1.00	1.00	1.00	1.00
AdjDel/Veh:	53.0	32.6	32.1	50.8	26.1	30.5	44.3	39.4	39.4	39.9	42.2	42.2
LOS by Move:	D	C	C	D	C	C	D	D	D	D	D	D
HCM2k95thQ:	2	25	22	6	15	25	16	11	11	11	15	15

Note: Queue reported is the number of cars per lane.

BART Phase II Extension Project

Level Of Service Computation Report
 2000 HCM Operations (Future Volume Alternative)
 PM - 2035 No Project Conditions

Intersection #3553: FRUITDALE/SOUTHWEST

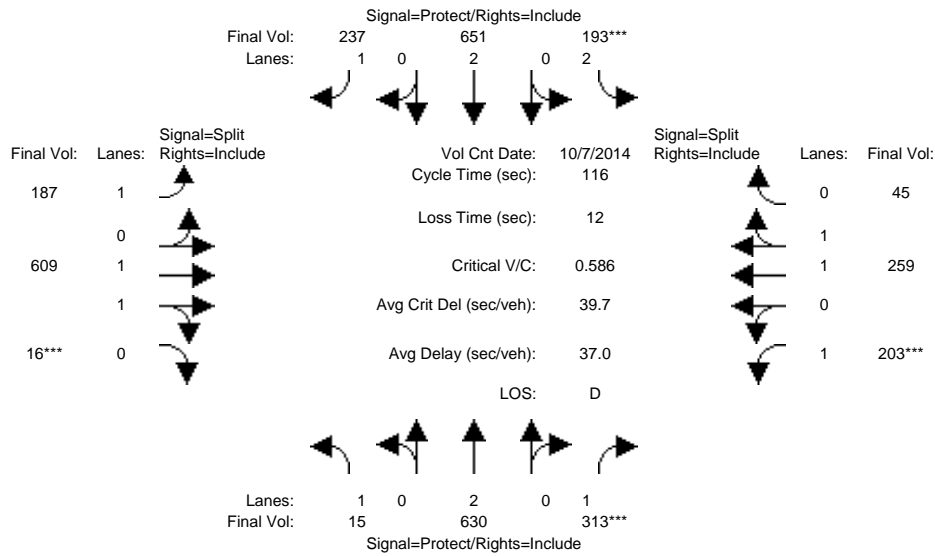

Approach:	North Bound			South Bound			East Bound			West Bound		
	L	T	R	L	T	R	L	T	R	L	T	R
Min. Green:	7	10	10	7	10	10	10	10	10	10	10	10
Y+R:	4.0	4.0	4.0	4.0	4.0	4.0	4.0	4.0	4.0	4.0	4.0	4.0

Volume Module:	>>	Count	Date:	7 Oct 2014	<<											
Base Vol:	15	630	313	193	651	237	187	609	16	203	259	45				
Growth Adj:	1.00	1.00	1.00	1.00	1.00	1.00	1.00	1.00	1.00	1.00	1.00	1.00				
Initial Bse:	15	630	313	193	651	237	187	609	16	203	259	45				
Added Vol:	0	0	0	0	0	0	0	0	0	0	0	0				
PasserByVol:	0	0	0	0	0	0	0	0	0	0	0	0				
Initial Fut:	15	630	313	193	651	237	187	609	16	203	259	45				
User Adj:	1.00	1.00	1.00	1.00	1.00	1.00	1.00	1.00	1.00	1.00	1.00	1.00				
PHF Adj:	1.00	1.00	1.00	1.00	1.00	1.00	1.00	1.00	1.00	1.00	1.00	1.00				
PHF Volume:	15	630	313	193	651	237	187	609	16	203	259	45				
Reduct Vol:	0	0	0	0	0	0	0	0	0	0	0	0				
Reduced Vol:	15	630	313	193	651	237	187	609	16	203	259	45				
PCE Adj:	1.00	1.00	1.00	1.00	1.00	1.00	1.00	1.00	1.00	1.00	1.00	1.00				
MLF Adj:	1.00	1.00	1.00	1.00	1.00	1.00	1.00	1.00	1.00	1.00	1.00	1.00				
Final Volume:	15	630	313	193	651	237	187	609	16	203	259	45				

Saturation Flow Module:												
Sat/Lane:	1900	1900	1900	1900	1900	1900	1900	1900	1900	1900	1900	1900
Adjustment:	0.92	1.00	0.92	0.83	1.00	0.92	0.92	0.97	0.95	0.92	0.98	0.95
Lanes:	1.00	2.00	1.00	2.00	2.00	1.00	1.00	1.95	0.05	1.00	1.70	0.30
Final Sat.:	1750	3800	1750	3150	3800	1750	1750	3605	95	1750	3152	548

Capacity Analysis Module:												
Vol/Sat:	0.01	0.17	0.18	0.06	0.17	0.14	0.11	0.17	0.17	0.12	0.08	0.08
Crit Moves:			****	****					****	****		
Green Time:	12.4	35.4	35.4	12.1	35.2	35.2	33.5	33.5	33.5	23.0	23.0	23.0
Volume/Cap:	0.08	0.54	0.59	0.59	0.56	0.45	0.37	0.59	0.59	0.59	0.41	0.41
Delay/Veh:	46.9	34.1	35.8	52.2	34.6	33.2	33.3	36.2	36.2	44.8	41.0	41.0
User DelAdj:	1.00	1.00	1.00	1.00	1.00	1.00	1.00	1.00	1.00	1.00	1.00	1.00
AdjDel/Veh:	46.9	34.1	35.8	52.2	34.6	33.2	33.3	36.2	36.2	44.8	41.0	41.0
LOS by Move:	D	C	D	D	C	C	C	D	D	D	D	D
HCM2k95thQ:	1	18	19	9	19	14	11	18	18	13	9	9

Note: Queue reported is the number of cars per lane.

BART Phase II Extension Project

Level Of Service Computation Report
 2000 HCM Operations (Future Volume Alternative)
 AM - 2035 No Project Conditions

Intersection #3606: JULIAN/MONTGOMERY

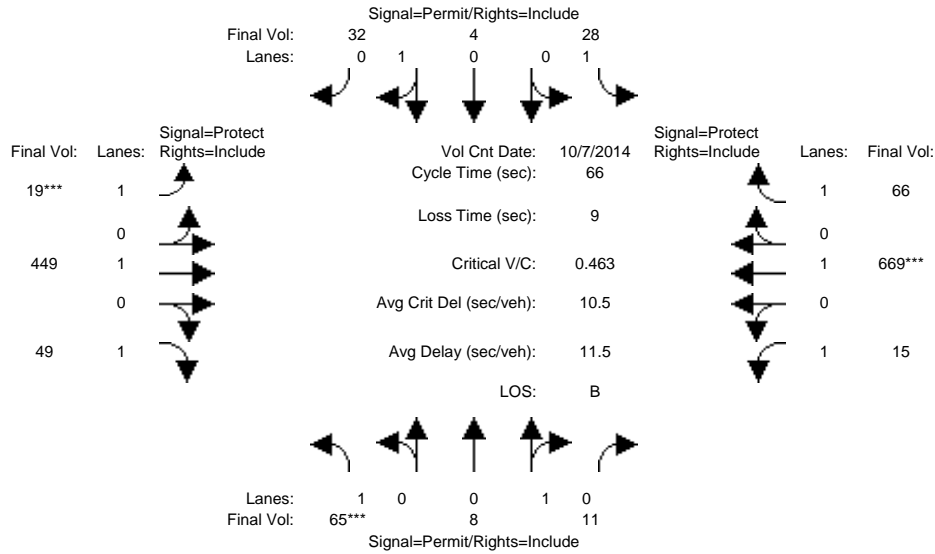

Approach:	North Bound			South Bound			East Bound			West Bound		
	L	T	R	L	T	R	L	T	R	L	T	R
Min. Green:	10	10	10	10	10	10	7	10	10	7	10	10
Y+R:	4.0	4.0	4.0	4.0	4.0	4.0	4.0	4.0	4.0	4.0	4.0	4.0
Volume Module: >> Count Date: 7 Oct 2014 <<												
Base Vol:	65	8	11	28	4	32	19	449	49	15	669	66
Growth Adj:	1.00	1.00	1.00	1.00	1.00	1.00	1.00	1.00	1.00	1.00	1.00	1.00
Initial Bse:	65	8	11	28	4	32	19	449	49	15	669	66
Added Vol:	0	0	0	0	0	0	0	0	0	0	0	0
PasserByVol:	0	0	0	0	0	0	0	0	0	0	0	0
Initial Fut:	65	8	11	28	4	32	19	449	49	15	669	66
User Adj:	1.00	1.00	1.00	1.00	1.00	1.00	1.00	1.00	1.00	1.00	1.00	1.00
PHF Adj:	1.00	1.00	1.00	1.00	1.00	1.00	1.00	1.00	1.00	1.00	1.00	1.00
PHF Volume:	65	8	11	28	4	32	19	449	49	15	669	66
Reduct Vol:	0	0	0	0	0	0	0	0	0	0	0	0
Reduced Vol:	65	8	11	28	4	32	19	449	49	15	669	66
PCE Adj:	1.00	1.00	1.00	1.00	1.00	1.00	1.00	1.00	1.00	1.00	1.00	1.00
MLF Adj:	1.00	1.00	1.00	1.00	1.00	1.00	1.00	1.00	1.00	1.00	1.00	1.00
Final Volume:	65	8	11	28	4	32	19	449	49	15	669	66
Saturation Flow Module:												
Sat/Lane:	1900	1900	1900	1900	1900	1900	1900	1900	1900	1900	1900	1900
Adjustment:	0.92	0.95	0.95	0.92	0.95	0.95	0.92	1.00	0.92	0.92	1.00	0.92
Lanes:	1.00	0.42	0.58	1.00	0.11	0.89	1.00	1.00	1.00	1.00	1.00	1.00
Final Sat.:	1750	758	1042	1750	200	1600	1750	1900	1750	1750	1900	1750
Capacity Analysis Module:												
Vol/Sat:	0.04	0.01	0.01	0.02	0.02	0.02	0.01	0.24	0.03	0.01	0.35	0.04
Crit Moves:	****						****				****	
Green Time:	10.0	10.0	10.0	10.0	10.0	10.0	7.0	32.4	32.4	14.6	40.0	40.0
Volume/Cap:	0.25	0.07	0.07	0.11	0.13	0.13	0.10	0.48	0.06	0.04	0.58	0.06
Delay/Veh:	25.2	24.1	24.1	24.3	24.5	24.5	26.9	11.6	8.8	20.3	8.7	5.3
User DelAdj:	1.00	1.00	1.00	1.00	1.00	1.00	1.00	1.00	1.00	1.00	1.00	1.00
AdjDel/Veh:	25.2	24.1	24.1	24.3	24.5	24.5	26.9	11.6	8.8	20.3	8.7	5.3
LOS by Move:	C	C	C	C	C	C	C	B	A	C	A	A
HCM2k95thQ:	3	1	1	1	2	2	1	11	1	1	15	1

Note: Queue reported is the number of cars per lane.

BART Phase II Extension Project

Level Of Service Computation Report
2000 HCM Operations (Future Volume Alternative)
PM - 2035 No Project Conditions

Intersection #3606: JULIAN/MONTGOMERY

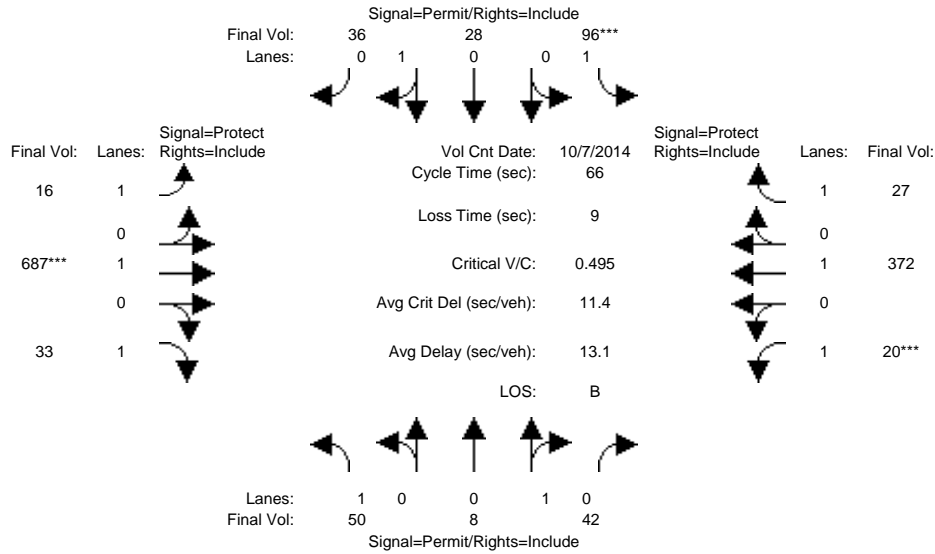

Approach:	North Bound			South Bound			East Bound			West Bound		
	L	T	R	L	T	R	L	T	R	L	T	R
Min. Green:	10	10	10	10	10	10	7	10	10	7	10	10
Y+R:	4.0	4.0	4.0	4.0	4.0	4.0	4.0	4.0	4.0	4.0	4.0	4.0

Volume Module:	>> Count Date: 7 Oct 2014 <<											
Base Vol:	50	8	42	96	28	36	16	687	33	20	372	27
Growth Adj:	1.00	1.00	1.00	1.00	1.00	1.00	1.00	1.00	1.00	1.00	1.00	1.00
Initial Bse:	50	8	42	96	28	36	16	687	33	20	372	27
Added Vol:	0	0	0	0	0	0	0	0	0	0	0	0
PasserByVol:	0	0	0	0	0	0	0	0	0	0	0	0
Initial Fut:	50	8	42	96	28	36	16	687	33	20	372	27
User Adj:	1.00	1.00	1.00	1.00	1.00	1.00	1.00	1.00	1.00	1.00	1.00	1.00
PHF Adj:	1.00	1.00	1.00	1.00	1.00	1.00	1.00	1.00	1.00	1.00	1.00	1.00
PHF Volume:	50	8	42	96	28	36	16	687	33	20	372	27
Reduct Vol:	0	0	0	0	0	0	0	0	0	0	0	0
Reduced Vol:	50	8	42	96	28	36	16	687	33	20	372	27
PCE Adj:	1.00	1.00	1.00	1.00	1.00	1.00	1.00	1.00	1.00	1.00	1.00	1.00
MLF Adj:	1.00	1.00	1.00	1.00	1.00	1.00	1.00	1.00	1.00	1.00	1.00	1.00
FinalVolume:	50	8	42	96	28	36	16	687	33	20	372	27

Saturation Flow Module:												
Sat/Lane:	1900	1900	1900	1900	1900	1900	1900	1900	1900	1900	1900	1900
Adjustment:	0.92	0.95	0.95	0.92	0.95	0.95	0.92	1.00	0.92	0.92	1.00	0.92
Lanes:	1.00	0.16	0.84	1.00	0.44	0.56	1.00	1.00	1.00	1.00	1.00	1.00
Final Sat.:	1750	288	1512	1750	787	1012	1750	1900	1750	1750	1900	1750

Capacity Analysis Module:												
Vol/Sat:	0.03	0.03	0.03	0.05	0.04	0.04	0.01	0.36	0.02	0.01	0.20	0.02
Crit Moves:				****				****			****	
Green Time:	10.0	10.0	10.0	10.0	10.0	10.0	16.5	40.0	40.0	7.0	30.5	30.5
Volume/Cap:	0.19	0.18	0.18	0.36	0.23	0.23	0.04	0.60	0.03	0.11	0.42	0.03
Delay/Veh:	24.8	24.8	24.8	26.0	25.1	25.1	18.8	8.9	5.2	26.9	12.2	9.7
User DelAdj:	1.00	1.00	1.00	1.00	1.00	1.00	1.00	1.00	1.00	1.00	1.00	1.00
AdjDel/Veh:	24.8	24.8	24.8	26.0	25.1	25.1	18.8	8.9	5.2	26.9	12.2	9.7
LOS by Move:	C	C	C	C	C	C	B	A	A	C	B	A
HCM2k95thQ:	2	2	2	5	3	3	1	16	1	1	9	1

Note: Queue reported is the number of cars per lane.

BART Phase II Extension Project

Level Of Service Computation Report
 2000 HCM Operations (Future Volume Alternative)
 AM - 2035 No Project Conditions

Intersection #3608: JULIAN/STOCKTON

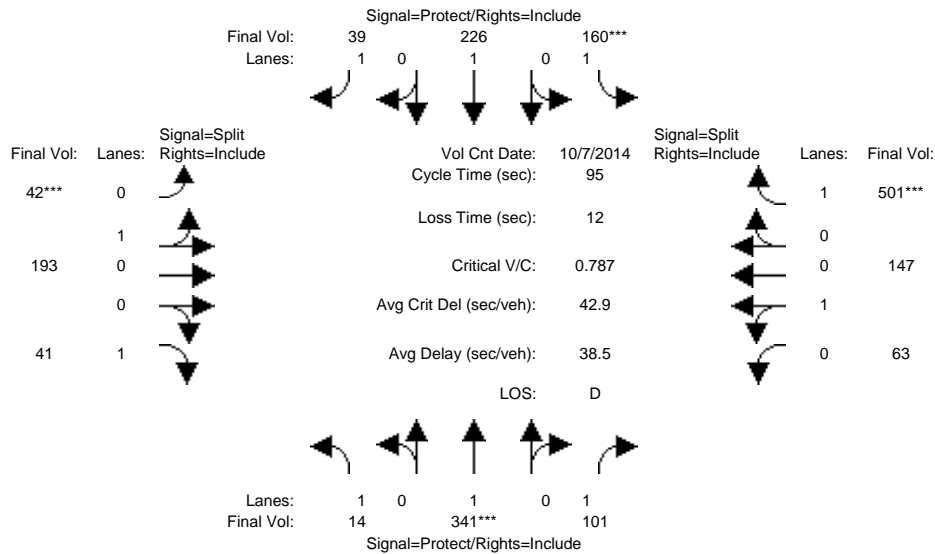

Approach:	North Bound			South Bound			East Bound			West Bound		
Movement:	L	T	R	L	T	R	L	T	R	L	T	R
Min. Green:	7	10	10	7	10	10	10	10	10	10	10	10
Y+R:	4.0	4.0	4.0	4.0	4.0	4.0	4.0	4.0	4.0	4.0	4.0	4.0
Volume Module: >> Count Date: 7 Oct 2014 <<												
Base Vol:	14	341	101	160	226	39	42	193	41	63	147	501
Growth Adj:	1.00	1.00	1.00	1.00	1.00	1.00	1.00	1.00	1.00	1.00	1.00	1.00
Initial Bse:	14	341	101	160	226	39	42	193	41	63	147	501
Added Vol:	0	0	0	0	0	0	0	0	0	0	0	0
PasserByVol:	0	0	0	0	0	0	0	0	0	0	0	0
Initial Fut:	14	341	101	160	226	39	42	193	41	63	147	501
User Adj:	1.00	1.00	1.00	1.00	1.00	1.00	1.00	1.00	1.00	1.00	1.00	1.00
PHF Adj:	1.00	1.00	1.00	1.00	1.00	1.00	1.00	1.00	1.00	1.00	1.00	1.00
PHF Volume:	14	341	101	160	226	39	42	193	41	63	147	501
Reduct Vol:	0	0	0	0	0	0	0	0	0	0	0	0
Reduced Vol:	14	341	101	160	226	39	42	193	41	63	147	501
PCE Adj:	1.00	1.00	1.00	1.00	1.00	1.00	1.00	1.00	1.00	1.00	1.00	1.00
MLF Adj:	1.00	1.00	1.00	1.00	1.00	1.00	1.00	1.00	1.00	1.00	1.00	1.00
FinalVolume:	14	341	101	160	226	39	42	193	41	63	147	501
Saturation Flow Module:												
Sat/Lane:	1900	1900	1900	1900	1900	1900	1900	1900	1900	1900	1900	1900
Adjustment:	0.92	1.00	0.92	0.92	1.00	0.92	0.95	0.95	0.92	0.95	0.95	0.92
Lanes:	1.00	1.00	1.00	1.00	1.00	1.00	0.18	0.82	1.00	0.30	0.70	1.00
Final Sat.:	1750	1900	1750	1750	1900	1750	322	1478	1750	540	1260	1750
Capacity Analysis Module:												
Vol/Sat:	0.01	0.18	0.06	0.09	0.12	0.02	0.13	0.13	0.02	0.12	0.12	0.29
Crit Moves:	****	****	****	****	****	****	****	****	****	****	****	****
Green Time:	12.5	21.7	21.7	11.0	20.2	20.2	15.8	15.8	15.8	34.6	34.6	34.6
Volume/Cap:	0.06	0.79	0.25	0.79	0.56	0.10	0.79	0.79	0.14	0.32	0.32	0.79
Delay/Veh:	36.2	43.8	30.4	59.1	35.2	30.3	51.0	51.0	34.1	22.1	22.1	33.4
User DelAdj:	1.00	1.00	1.00	1.00	1.00	1.00	1.00	1.00	1.00	1.00	1.00	1.00
AdjDel/Veh:	36.2	43.8	30.4	59.1	35.2	30.3	51.0	51.0	34.1	22.1	22.1	33.4
LOS by Move:	D	D	C	E	D	C	D	D	C	C	C	C
HCM2k95thQ:	1	18	5	10	11	2	14	14	2	9	9	25

Note: Queue reported is the number of cars per lane.

BART Phase II Extension Project

Level Of Service Computation Report
2000 HCM Operations (Future Volume Alternative)
PM - 2035 No Project Conditions

Intersection #3608: JULIAN/STOCKTON

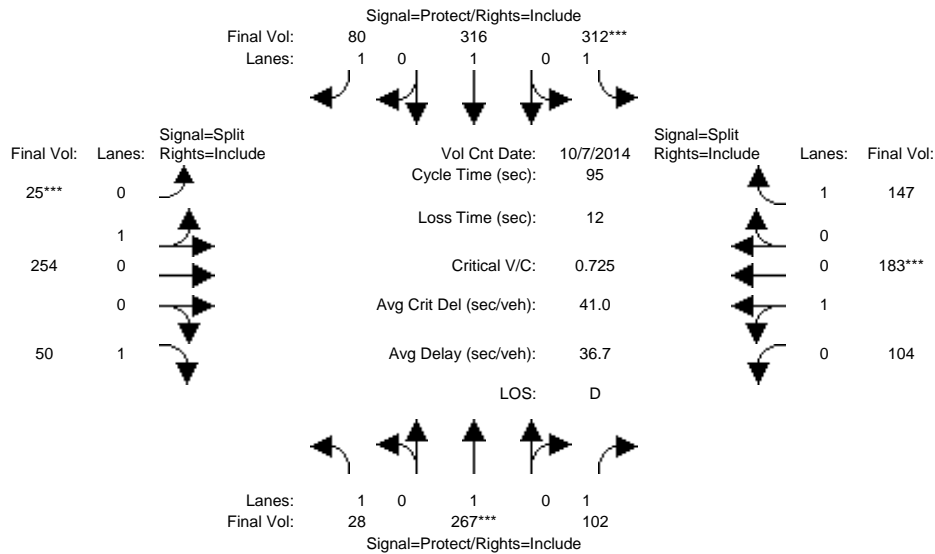

Approach:	North Bound			South Bound			East Bound			West Bound		
	L	T	R	L	T	R	L	T	R	L	T	R
Min. Green:	7	10	10	7	10	10	10	10	10	10	10	10
Y+R:	4.0	4.0	4.0	4.0	4.0	4.0	4.0	4.0	4.0	4.0	4.0	4.0
Volume Module: >> Count Date: 7 Oct 2014 <<												
Base Vol:	28	267	102	312	316	80	25	254	50	104	183	147
Growth Adj:	1.00	1.00	1.00	1.00	1.00	1.00	1.00	1.00	1.00	1.00	1.00	1.00
Initial Bse:	28	267	102	312	316	80	25	254	50	104	183	147
Added Vol:	0	0	0	0	0	0	0	0	0	0	0	0
PasserByVol:	0	0	0	0	0	0	0	0	0	0	0	0
Initial Fut:	28	267	102	312	316	80	25	254	50	104	183	147
User Adj:	1.00	1.00	1.00	1.00	1.00	1.00	1.00	1.00	1.00	1.00	1.00	1.00
PHF Adj:	1.00	1.00	1.00	1.00	1.00	1.00	1.00	1.00	1.00	1.00	1.00	1.00
PHF Volume:	28	267	102	312	316	80	25	254	50	104	183	147
Reduct Vol:	0	0	0	0	0	0	0	0	0	0	0	0
Reduced Vol:	28	267	102	312	316	80	25	254	50	104	183	147
PCE Adj:	1.00	1.00	1.00	1.00	1.00	1.00	1.00	1.00	1.00	1.00	1.00	1.00
MLF Adj:	1.00	1.00	1.00	1.00	1.00	1.00	1.00	1.00	1.00	1.00	1.00	1.00
FinalVolume:	28	267	102	312	316	80	25	254	50	104	183	147
Saturation Flow Module:												
Sat/Lane:	1900	1900	1900	1900	1900	1900	1900	1900	1900	1900	1900	1900
Adjustment:	0.92	1.00	0.92	0.92	1.00	0.92	0.95	0.95	0.92	0.95	0.95	0.92
Lanes:	1.00	1.00	1.00	1.00	1.00	1.00	0.09	0.91	1.00	0.36	0.64	1.00
Final Sat.:	1750	1900	1750	1750	1900	1750	161	1639	1750	652	1148	1750
Capacity Analysis Module:												
Vol/Sat:	0.02	0.14	0.06	0.18	0.17	0.05	0.16	0.16	0.03	0.16	0.16	0.08
Crit Moves:	****			****			****			****		
Green Time:	12.8	18.4	18.4	23.4	29.0	29.0	20.3	20.3	20.3	20.9	20.9	20.9
Volume/Cap:	0.12	0.72	0.30	0.72	0.55	0.15	0.72	0.72	0.13	0.72	0.72	0.38
Delay/Veh:	36.3	42.9	33.3	38.9	28.6	24.2	41.5	41.5	30.4	40.9	40.9	32.2
User DelAdj:	1.00	1.00	1.00	1.00	1.00	1.00	1.00	1.00	1.00	1.00	1.00	1.00
AdjDel/Veh:	36.3	42.9	33.3	38.9	28.6	24.2	41.5	41.5	30.4	40.9	40.9	32.2
LOS by Move:	D	D	C	D	C	C	D	D	C	D	D	C
HCM2k95thQ:	2	14	5	17	14	4	16	16	3	16	16	8

Note: Queue reported is the number of cars per lane.

BART Phase II Extension Project

Level Of Service Computation Report
 2000 HCM Operations (Future Volume Alternative)
 AM - 2035 No Project Conditions

Intersection #3651: LINCOLN/PARKMOOR

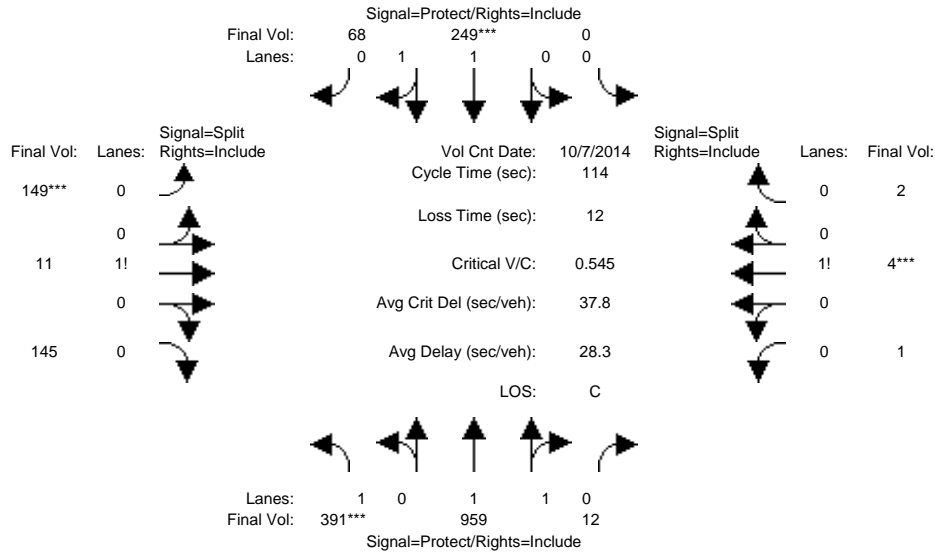

Approach:	North Bound			South Bound			East Bound			West Bound		
	L	T	R	L	T	R	L	T	R	L	T	R
Min. Green:	7	10	10	0	10	10	10	10	10	10	10	10
Y+R:	4.0	4.0	4.0	4.0	4.0	4.0	4.0	4.0	4.0	4.0	4.0	4.0
Volume Module: >> Count Date: 7 Oct 2014 <<												
Base Vol:	391	959	12	0	249	68	149	11	145	1	4	2
Growth Adj:	1.00	1.00	1.00	1.00	1.00	1.00	1.00	1.00	1.00	1.00	1.00	1.00
Initial Bse:	391	959	12	0	249	68	149	11	145	1	4	2
Added Vol:	0	0	0	0	0	0	0	0	0	0	0	0
PasserByVol:	0	0	0	0	0	0	0	0	0	0	0	0
Initial Fut:	391	959	12	0	249	68	149	11	145	1	4	2
User Adj:	1.00	1.00	1.00	1.00	1.00	1.00	1.00	1.00	1.00	1.00	1.00	1.00
PHF Adj:	1.00	1.00	1.00	1.00	1.00	1.00	1.00	1.00	1.00	1.00	1.00	1.00
PHF Volume:	391	959	12	0	249	68	149	11	145	1	4	2
Reduct Vol:	0	0	0	0	0	0	0	0	0	0	0	0
Reduced Vol:	391	959	12	0	249	68	149	11	145	1	4	2
PCE Adj:	1.00	1.00	1.00	1.00	1.00	1.00	1.00	1.00	1.00	1.00	1.00	1.00
MLF Adj:	1.00	1.00	1.00	1.00	1.00	1.00	1.00	1.00	1.00	1.00	1.00	1.00
FinalVolume:	391	959	12	0	249	68	149	11	145	1	4	2
Saturation Flow Module:												
Sat/Lane:	1900	1900	1900	1900	1900	1900	1900	1900	1900	1900	1900	1900
Adjustment:	0.92	0.97	0.95	0.92	0.98	0.95	0.92	0.92	0.92	0.92	0.92	0.92
Lanes:	1.00	1.97	0.03	0.00	1.56	0.44	0.49	0.04	0.47	0.14	0.57	0.29
Final Sat.:	1750	3654	46	0	2906	794	855	63	832	250	1000	500
Capacity Analysis Module:												
Vol/Sat:	0.22	0.26	0.26	0.00	0.09	0.09	0.17	0.17	0.17	0.00	0.00	0.00
Crit Moves:	****				****		****				****	
Green Time:	42.5	58.8	58.8	0.0	16.3	16.3	33.2	33.2	33.2	10.0	10.0	10.0
Volume/Cap:	0.60	0.51	0.51	0.00	0.60	0.60	0.60	0.60	0.60	0.05	0.05	0.05
Delay/Veh:	30.4	18.3	18.3	0.0	47.7	47.7	36.7	36.7	36.7	47.8	47.8	47.8
User DelAdj:	1.00	1.00	1.00	1.00	1.00	1.00	1.00	1.00	1.00	1.00	1.00	1.00
AdjDel/Veh:	30.4	18.3	18.3	0.0	47.7	47.7	36.7	36.7	36.7	47.8	47.8	47.8
LOS by Move:	C	B	B	A	D	D	D	D	D	D	D	D
HCM2k95thQ:	21	20	20	0	10	10	18	18	18	1	1	1

Note: Queue reported is the number of cars per lane.

BART Phase II Extension Project

Level Of Service Computation Report
 2000 HCM Operations (Future Volume Alternative)
 PM - 2035 No Project Conditions

Intersection #3651: LINCOLN/PARKMOOR

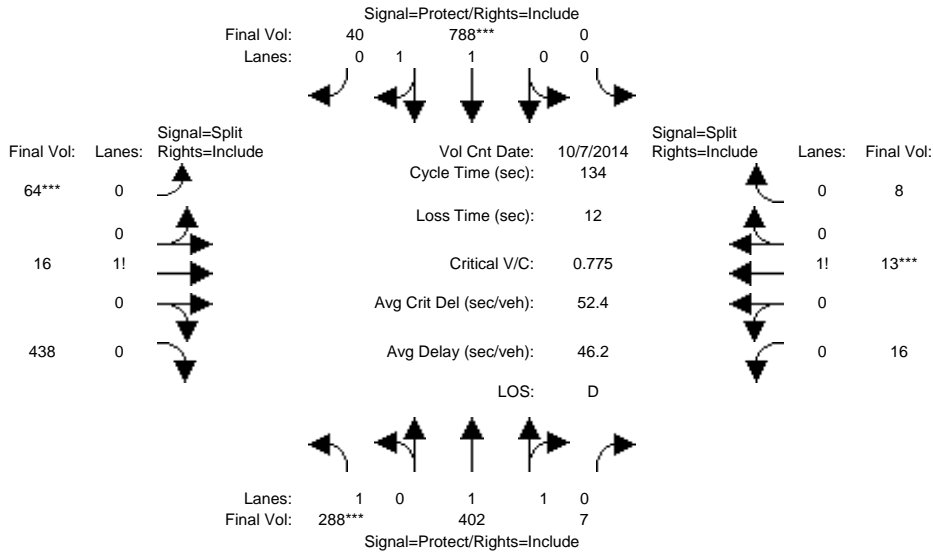

Approach:	North Bound			South Bound			East Bound			West Bound		
Movement:	L	T	R	L	T	R	L	T	R	L	T	R
Min. Green:	7	10	10	0	10	10	10	10	10	10	10	10
Y+R:	4.0	4.0	4.0	4.0	4.0	4.0	4.0	4.0	4.0	4.0	4.0	4.0
Volume Module: >> Count Date: 7 Oct 2014 <<												
Base Vol:	288	402	7	0	788	40	64	16	438	16	13	8
Growth Adj:	1.00	1.00	1.00	1.00	1.00	1.00	1.00	1.00	1.00	1.00	1.00	1.00
Initial Bse:	288	402	7	0	788	40	64	16	438	16	13	8
Added Vol:	0	0	0	0	0	0	0	0	0	0	0	0
PasserByVol:	0	0	0	0	0	0	0	0	0	0	0	0
Initial Fut:	288	402	7	0	788	40	64	16	438	16	13	8
User Adj:	1.00	1.00	1.00	1.00	1.00	1.00	1.00	1.00	1.00	1.00	1.00	1.00
PHF Adj:	1.00	1.00	1.00	1.00	1.00	1.00	1.00	1.00	1.00	1.00	1.00	1.00
PHF Volume:	288	402	7	0	788	40	64	16	438	16	13	8
Reduct Vol:	0	0	0	0	0	0	0	0	0	0	0	0
Reduced Vol:	288	402	7	0	788	40	64	16	438	16	13	8
PCE Adj:	1.00	1.00	1.00	1.00	1.00	1.00	1.00	1.00	1.00	1.00	1.00	1.00
MLF Adj:	1.00	1.00	1.00	1.00	1.00	1.00	1.00	1.00	1.00	1.00	1.00	1.00
Final Volume:	288	402	7	0	788	40	64	16	438	16	13	8
Saturation Flow Module:												
Sat/Lane:	1900	1900	1900	1900	1900	1900	1900	1900	1900	1900	1900	1900
Adjustment:	0.92	0.97	0.95	0.92	0.98	0.95	0.92	0.92	0.92	0.92	0.92	0.92
Lanes:	1.00	1.96	0.04	0.00	1.90	0.10	0.12	0.03	0.85	0.43	0.35	0.22
Final Sat.:	1750	3637	63	0	3521	179	216	54	1480	757	615	378
Capacity Analysis Module:												
Vol/Sat:	0.16	0.11	0.11	0.00	0.22	0.22	0.30	0.30	0.30	0.02	0.02	0.02
Crit Moves:	****				****		****				****	
Green Time:	26.9	63.6	63.6	0.0	36.6	36.6	48.4	48.4	48.4	10.0	10.0	10.0
Volume/Cap:	0.82	0.23	0.23	0.00	0.82	0.82	0.82	0.82	0.82	0.28	0.28	0.28
Delay/Veh:	65.2	20.9	20.9	0.0	50.9	50.9	47.1	47.1	47.1	59.8	59.8	59.8
User DelAdj:	1.00	1.00	1.00	1.00	1.00	1.00	1.00	1.00	1.00	1.00	1.00	1.00
AdjDel/Veh:	65.2	20.9	20.9	0.0	50.9	50.9	47.1	47.1	47.1	59.8	59.8	59.8
LOS by Move:	E	C	C	A	D	D	D	D	D	E	E	E
HCM2k95thQ:	23	10	10	0	30	30	36	36	36	4	4	4

Note: Queue reported is the number of cars per lane.

BART Phase II Extension Project

Level Of Service Computation Report
 2000 HCM Operations (Future Volume Alternative)
 AM - 2035 No Project Conditions

Intersection #3653: LINCOLN/SAN CARLOS

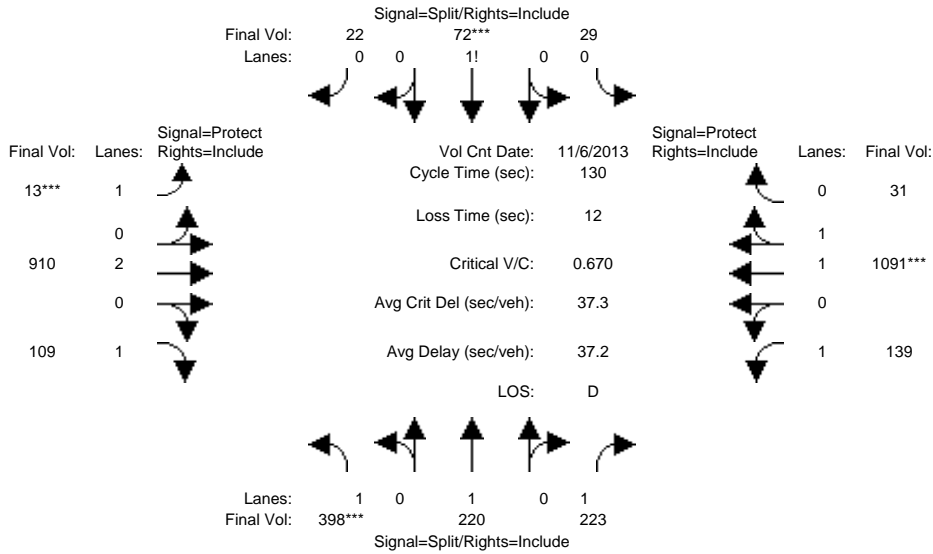

Approach:	North Bound			South Bound			East Bound			West Bound		
	L	T	R	L	T	R	L	T	R	L	T	R
Min. Green:	10	10	10	10	10	10	7	10	10	7	10	10
Y+R:	4.0	4.0	4.0	4.0	4.0	4.0	4.0	4.0	4.0	4.0	4.0	4.0

Volume Module: >> Count Date: 6 Nov 2013 <<

Base Vol:	398	220	223	29	72	22	13	910	109	139	1091	31
Growth Adj:	1.00	1.00	1.00	1.00	1.00	1.00	1.00	1.00	1.00	1.00	1.00	1.00
Initial Bse:	398	220	223	29	72	22	13	910	109	139	1091	31
Added Vol:	0	0	0	0	0	0	0	0	0	0	0	0
PasserByVol:	0	0	0	0	0	0	0	0	0	0	0	0
Initial Fut:	398	220	223	29	72	22	13	910	109	139	1091	31
User Adj:	1.00	1.00	1.00	1.00	1.00	1.00	1.00	1.00	1.00	1.00	1.00	1.00
PHF Adj:	1.00	1.00	1.00	1.00	1.00	1.00	1.00	1.00	1.00	1.00	1.00	1.00
PHF Volume:	398	220	223	29	72	22	13	910	109	139	1091	31
Reduct Vol:	0	0	0	0	0	0	0	0	0	0	0	0
Reduced Vol:	398	220	223	29	72	22	13	910	109	139	1091	31
PCE Adj:	1.00	1.00	1.00	1.00	1.00	1.00	1.00	1.00	1.00	1.00	1.00	1.00
MLF Adj:	1.00	1.00	1.00	1.00	1.00	1.00	1.00	1.00	1.00	1.00	1.00	1.00
FinalVolume:	398	220	223	29	72	22	13	910	109	139	1091	31

Saturation Flow Module:

Sat/Lane:	1900	1900	1900	1900	1900	1900	1900	1900	1900	1900	1900	1900
Adjustment:	0.92	1.00	0.92	0.92	0.92	0.92	0.92	1.00	0.92	0.92	0.97	0.95
Lanes:	1.00	1.00	1.00	0.24	0.58	0.18	1.00	2.00	1.00	1.00	1.94	0.06
Final Sat.:	1750	1900	1750	413	1024	313	1750	3800	1750	1750	3598	102

Capacity Analysis Module:

Vol/Sat:	0.23	0.12	0.13	0.07	0.07	0.07	0.01	0.24	0.06	0.08	0.30	0.30
Crit Moves:	****			****			****			****		
Green Time:	42.0	42.0	42.0	13.0	13.0	13.0	7.0	47.3	47.3	15.7	56.0	56.0
Volume/Cap:	0.70	0.36	0.39	0.70	0.70	0.70	0.14	0.66	0.17	0.66	0.70	0.70
Delay/Veh:	42.6	34.0	34.6	68.9	68.9	68.9	59.3	35.7	28.2	62.0	31.7	31.7
User DelAdj:	1.00	1.00	1.00	1.00	1.00	1.00	1.00	1.00	1.00	1.00	1.00	1.00
AdjDel/Veh:	42.6	34.0	34.6	68.9	68.9	68.9	59.3	35.7	28.2	62.0	31.7	31.7
LOS by Move:	D	C	C	E	E	E	E	D	C	E	C	C
HCM2k95thQ:	27	12	14	13	13	13	1	26	6	11	32	32

Note: Queue reported is the number of cars per lane.

BART Phase II Extension Project

Level Of Service Computation Report
 2000 HCM Operations (Future Volume Alternative)
 PM - 2035 No Project Conditions

Intersection #3653: LINCOLN/SAN CARLOS

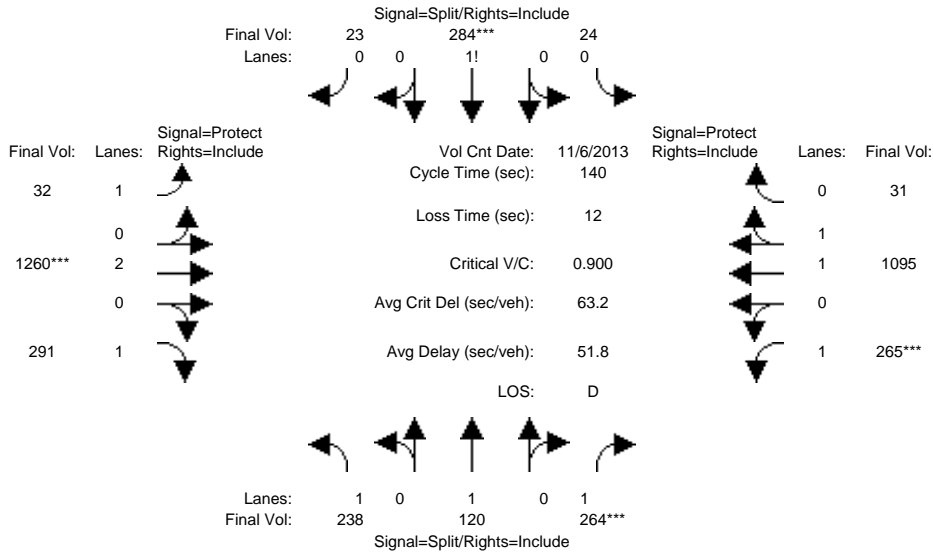

Approach:	North Bound			South Bound			East Bound			West Bound		
	L	T	R	L	T	R	L	T	R	L	T	R
Min. Green:	10	10	10	10	10	10	7	10	10	7	10	10
Y+R:	4.0	4.0	4.0	4.0	4.0	4.0	4.0	4.0	4.0	4.0	4.0	4.0

Volume Module:	>>	Count	Date:	6 Nov 2013	<<							
Base Vol:	238	120	264	24	284	23	32	1260	291	265	1095	31
Growth Adj:	1.00	1.00	1.00	1.00	1.00	1.00	1.00	1.00	1.00	1.00	1.00	1.00
Initial Bse:	238	120	264	24	284	23	32	1260	291	265	1095	31
Added Vol:	0	0	0	0	0	0	0	0	0	0	0	0
PasserByVol:	0	0	0	0	0	0	0	0	0	0	0	0
Initial Fut:	238	120	264	24	284	23	32	1260	291	265	1095	31
User Adj:	1.00	1.00	1.00	1.00	1.00	1.00	1.00	1.00	1.00	1.00	1.00	1.00
PHF Adj:	1.00	1.00	1.00	1.00	1.00	1.00	1.00	1.00	1.00	1.00	1.00	1.00
PHF Volume:	238	120	264	24	284	23	32	1260	291	265	1095	31
Reduct Vol:	0	0	0	0	0	0	0	0	0	0	0	0
Reduced Vol:	238	120	264	24	284	23	32	1260	291	265	1095	31
PCE Adj:	1.00	1.00	1.00	1.00	1.00	1.00	1.00	1.00	1.00	1.00	1.00	1.00
MLF Adj:	1.00	1.00	1.00	1.00	1.00	1.00	1.00	1.00	1.00	1.00	1.00	1.00
FinalVolume:	238	120	264	24	284	23	32	1260	291	265	1095	31

Saturation Flow Module:												
Sat/Lane:	1900	1900	1900	1900	1900	1900	1900	1900	1900	1900	1900	1900
Adjustment:	0.92	1.00	0.92	0.92	0.92	0.92	0.92	1.00	0.92	0.92	0.97	0.95
Lanes:	1.00	1.00	1.00	0.07	0.86	0.07	1.00	2.00	1.00	1.00	1.94	0.06
Final Sat.:	1750	1900	1750	127	1502	122	1750	3800	1750	1750	3598	102

Capacity Analysis Module:												
Vol/Sat:	0.14	0.06	0.15	0.19	0.19	0.19	0.02	0.33	0.17	0.15	0.30	0.30
Crit Moves:			****		****			****		****		
Green Time:	23.5	23.5	23.5	29.4	29.4	29.4	10.6	51.6	51.6	23.6	64.5	64.5
Volume/Cap:	0.81	0.38	0.90	0.90	0.90	0.90	0.24	0.90	0.45	0.90	0.66	0.66
Delay/Veh:	71.7	52.5	85.6	78.0	78.0	78.0	61.9	50.0	34.0	85.5	30.2	30.2
User DelAdj:	1.00	1.00	1.00	1.00	1.00	1.00	1.00	1.00	1.00	1.00	1.00	1.00
AdjDel/Veh:	71.7	52.5	85.6	78.0	78.0	78.0	61.9	50.0	34.0	85.5	30.2	30.2
LOS by Move:	E	D	F	E	E	E	E	D	C	F	C	C
HCM2k95thQ:	21	9	24	31	31	31	3	45	18	24	32	32

Note: Queue reported is the number of cars per lane.

BART Phase II Extension Project

Level Of Service Computation Report
 2000 HCM Operations (Future Volume Alternative)
 AM - 2035 No Project Conditions

Intersection #3690: MERIDIAN/PARKMOOR

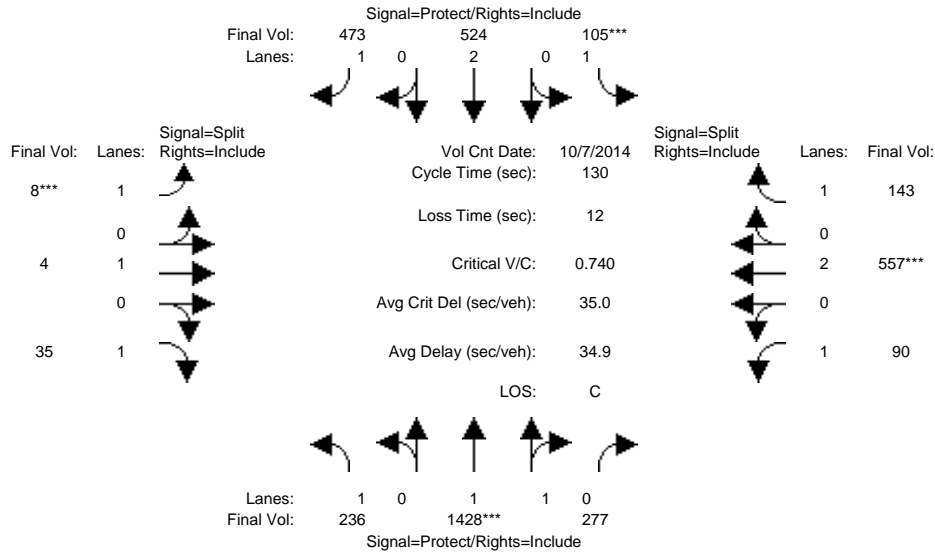

Approach:	North Bound			South Bound			East Bound			West Bound		
Movement:	L	T	R	L	T	R	L	T	R	L	T	R
Min. Green:	7	10	10	7	10	10	10	10	10	10	10	10
Y+R:	4.0	4.0	4.0	4.0	4.0	4.0	4.0	4.0	4.0	4.0	4.0	4.0
Volume Module: >> Count Date: 7 Oct 2014 <<												
Base Vol:	236	1428	277	105	524	473	8	4	35	90	557	143
Growth Adj:	1.00	1.00	1.00	1.00	1.00	1.00	1.00	1.00	1.00	1.00	1.00	1.00
Initial Bse:	236	1428	277	105	524	473	8	4	35	90	557	143
Added Vol:	0	0	0	0	0	0	0	0	0	0	0	0
PasserByVol:	0	0	0	0	0	0	0	0	0	0	0	0
Initial Fut:	236	1428	277	105	524	473	8	4	35	90	557	143
User Adj:	1.00	1.00	1.00	1.00	1.00	1.00	1.00	1.00	1.00	1.00	1.00	1.00
PHF Adj:	1.00	1.00	1.00	1.00	1.00	1.00	1.00	1.00	1.00	1.00	1.00	1.00
PHF Volume:	236	1428	277	105	524	473	8	4	35	90	557	143
Reduct Vol:	0	0	0	0	0	0	0	0	0	0	0	0
Reduced Vol:	236	1428	277	105	524	473	8	4	35	90	557	143
PCE Adj:	1.00	1.00	1.00	1.00	1.00	1.00	1.00	1.00	1.00	1.00	1.00	1.00
MLF Adj:	1.00	1.00	1.00	1.00	1.00	1.00	1.00	1.00	1.00	1.00	1.00	1.00
FinalVolume:	236	1428	277	105	524	473	8	4	35	90	557	143
Saturation Flow Module:												
Sat/Lane:	1900	1900	1900	1900	1900	1900	1900	1900	1900	1900	1900	1900
Adjustment:	0.92	0.98	0.95	0.92	1.00	0.92	0.92	1.00	0.92	0.92	1.00	0.92
Lanes:	1.00	1.67	0.33	1.00	2.00	1.00	1.00	1.00	1.00	1.00	2.00	1.00
Final Sat.:	1750	3098	601	1750	3800	1750	1750	1900	1750	1750	3800	1750
Capacity Analysis Module:												
Vol/Sat:	0.13	0.46	0.46	0.06	0.14	0.27	0.00	0.00	0.02	0.05	0.15	0.08
Crit Moves:	****	****	****	****	****	****	****	****	****	****	****	****
Green Time:	28.1	74.6	74.6	9.7	56.2	56.2	10.0	10.0	10.0	23.7	23.7	23.7
Volume/Cap:	0.62	0.80	0.80	0.80	0.32	0.62	0.06	0.03	0.26	0.28	0.80	0.45
Delay/Veh:	49.5	24.2	24.2	88.3	24.4	30.3	55.8	55.6	57.5	46.3	57.7	48.3
User DelAdj:	1.00	1.00	1.00	1.00	1.00	1.00	1.00	1.00	1.00	1.00	1.00	1.00
AdjDel/Veh:	49.5	24.2	24.2	88.3	24.4	30.3	55.8	55.6	57.5	46.3	57.7	48.3
LOS by Move:	D	C	C	F	C	C	E	E	E	D	E	D
HCM2k95thQ:	18	46	46	10	13	27	1	0	3	6	20	10

Note: Queue reported is the number of cars per lane.

BART Phase II Extension Project

Level Of Service Computation Report
 2000 HCM Operations (Future Volume Alternative)
 PM - 2035 No Project Conditions

Intersection #3690: MERIDIAN/PARKMOOR

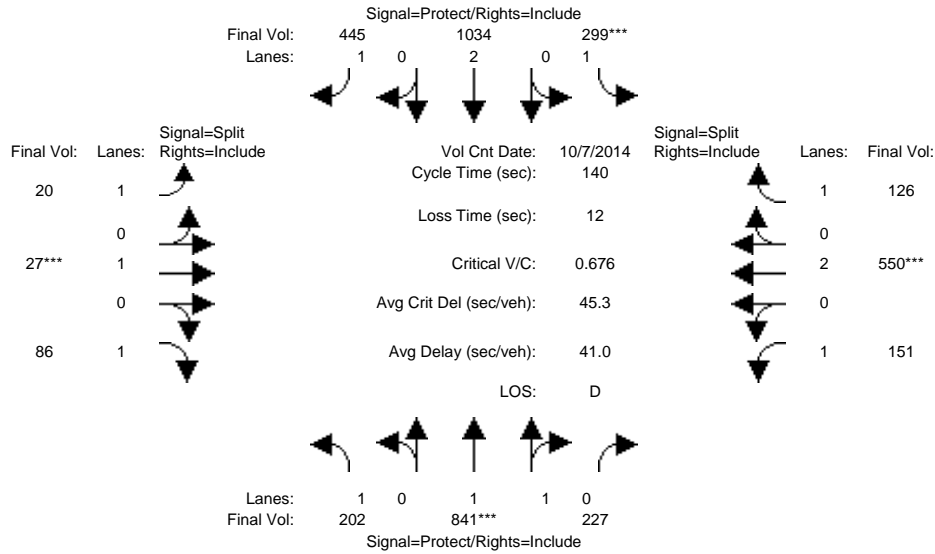

Approach:	North Bound			South Bound			East Bound			West Bound		
	L	T	R	L	T	R	L	T	R	L	T	R
Min. Green:	7	10	10	7	10	10	10	10	10	10	10	10
Y+R:	4.0	4.0	4.0	4.0	4.0	4.0	4.0	4.0	4.0	4.0	4.0	4.0
Volume Module: >> Count Date: 7 Oct 2014 <<												
Base Vol:	202	841	227	299	1034	445	20	27	86	151	550	126
Growth Adj:	1.00	1.00	1.00	1.00	1.00	1.00	1.00	1.00	1.00	1.00	1.00	1.00
Initial Bse:	202	841	227	299	1034	445	20	27	86	151	550	126
Added Vol:	0	0	0	0	0	0	0	0	0	0	0	0
PasserByVol:	0	0	0	0	0	0	0	0	0	0	0	0
Initial Fut:	202	841	227	299	1034	445	20	27	86	151	550	126
User Adj:	1.00	1.00	1.00	1.00	1.00	1.00	1.00	1.00	1.00	1.00	1.00	1.00
PHF Adj:	1.00	1.00	1.00	1.00	1.00	1.00	1.00	1.00	1.00	1.00	1.00	1.00
PHF Volume:	202	841	227	299	1034	445	20	27	86	151	550	126
Reduct Vol:	0	0	0	0	0	0	0	0	0	0	0	0
Reduced Vol:	202	841	227	299	1034	445	20	27	86	151	550	126
PCE Adj:	1.00	1.00	1.00	1.00	1.00	1.00	1.00	1.00	1.00	1.00	1.00	1.00
MLF Adj:	1.00	1.00	1.00	1.00	1.00	1.00	1.00	1.00	1.00	1.00	1.00	1.00
FinalVolume:	202	841	227	299	1034	445	20	27	86	151	550	126
Saturation Flow Module:												
Sat/Lane:	1900	1900	1900	1900	1900	1900	1900	1900	1900	1900	1900	1900
Adjustment:	0.92	0.98	0.95	0.92	1.00	0.92	0.92	1.00	0.92	0.92	1.00	0.92
Lanes:	1.00	1.56	0.44	1.00	2.00	1.00	1.00	1.00	1.00	1.00	2.00	1.00
Final Sat.:	1750	2913	786	1750	3800	1750	1750	1900	1750	1750	3800	1750
Capacity Analysis Module:												
Vol/Sat:	0.12	0.29	0.29	0.17	0.27	0.25	0.01	0.01	0.05	0.09	0.14	0.07
Crit Moves:	****			****			****			****		
Green Time:	26.7	56.3	56.3	33.3	62.9	62.9	10.2	10.2	10.2	28.2	28.2	28.2
Volume/Cap:	0.61	0.72	0.72	0.72	0.61	0.57	0.16	0.20	0.68	0.43	0.72	0.36
Delay/Veh:	55.0	36.9	36.9	55.0	29.8	29.4	61.5	61.8	76.9	49.7	55.5	48.7
User DelAdj:	1.00	1.00	1.00	1.00	1.00	1.00	1.00	1.00	1.00	1.00	1.00	1.00
AdjDel/Veh:	55.0	36.9	36.9	55.0	29.8	29.4	61.5	61.8	76.9	49.7	55.5	48.7
LOS by Move:	D	D	D	D	C	C	E	E	E	D	E	D
HCM2k95thQ:	17	34	34	23	29	26	2	2	8	11	20	10

Note: Queue reported is the number of cars per lane.

BART Phase II Extension Project

Level Of Service Computation Report
 2000 HCM Operations (Future Volume Alternative)
 AM - 2035 No Project Conditions

Intersection #3693: MERIDIAN/SAN CARLOS

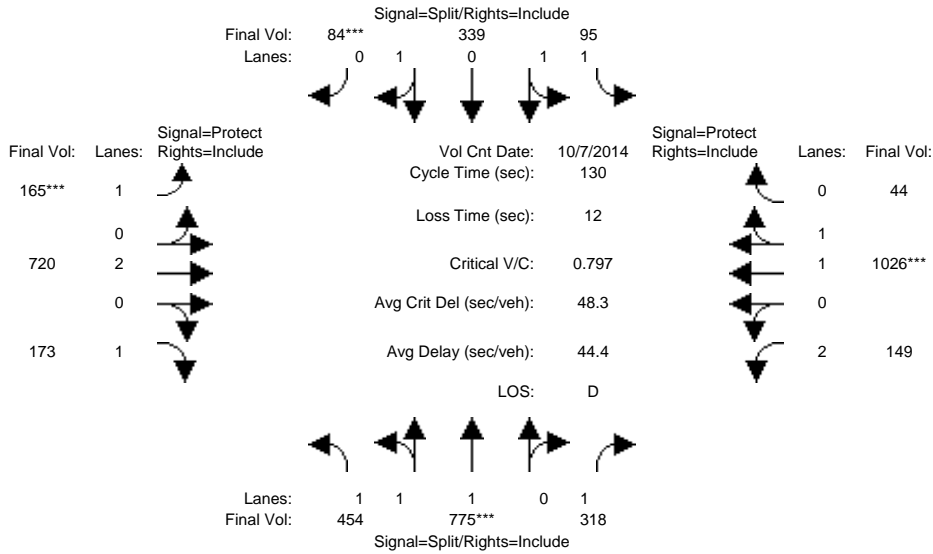

Approach:	North Bound			South Bound			East Bound			West Bound		
	L	T	R	L	T	R	L	T	R	L	T	R
Min. Green:	10	10	10	10	10	10	7	10	10	7	10	10
Y+R:	4.0	4.0	4.0	4.0	4.0	4.0	4.0	4.0	4.0	4.0	4.0	4.0
Volume Module: >> Count Date: 7 Oct 2014 <<												
Base Vol:	454	775	318	95	339	84	165	720	173	149	1026	44
Growth Adj:	1.00	1.00	1.00	1.00	1.00	1.00	1.00	1.00	1.00	1.00	1.00	1.00
Initial Bse:	454	775	318	95	339	84	165	720	173	149	1026	44
Added Vol:	0	0	0	0	0	0	0	0	0	0	0	0
PasserByVol:	0	0	0	0	0	0	0	0	0	0	0	0
Initial Fut:	454	775	318	95	339	84	165	720	173	149	1026	44
User Adj:	1.00	1.00	1.00	1.00	1.00	1.00	1.00	1.00	1.00	1.00	1.00	1.00
PHF Adj:	1.00	1.00	1.00	1.00	1.00	1.00	1.00	1.00	1.00	1.00	1.00	1.00
PHF Volume:	454	775	318	95	339	84	165	720	173	149	1026	44
Reduct Vol:	0	0	0	0	0	0	0	0	0	0	0	0
Reduced Vol:	454	775	318	95	339	84	165	720	173	149	1026	44
PCE Adj:	1.00	1.00	1.00	1.00	1.00	1.00	1.00	1.00	1.00	1.00	1.00	1.00
MLF Adj:	1.00	1.00	1.00	1.00	1.00	1.00	1.00	1.00	1.00	1.00	1.00	1.00
FinalVolume:	454	775	318	95	339	84	165	720	173	149	1026	44
Saturation Flow Module:												
Sat/Lane:	1900	1900	1900	1900	1900	1900	1900	1900	1900	1900	1900	1900
Adjustment:	0.92	0.98	0.92	0.92	0.98	0.95	0.92	1.00	0.92	0.83	0.97	0.95
Lanes:	1.15	1.85	1.00	1.00	1.59	0.41	1.00	2.00	1.00	2.00	1.92	0.08
Final Sat.:	2012	3434	1750	1750	2965	735	1750	3800	1750	3150	3548	152
Capacity Analysis Module:												
Vol/Sat:	0.23	0.23	0.18	0.05	0.11	0.11	0.09	0.19	0.10	0.05	0.29	0.29
Crit Moves:	****	****	****	****	****	****	****	****	****	****	****	****
Green Time:	36.8	36.8	36.8	18.6	18.6	18.6	15.4	48.7	48.7	13.8	47.2	47.2
Volume/Cap:	0.80	0.80	0.64	0.38	0.80	0.80	0.80	0.51	0.26	0.44	0.80	0.80
Delay/Veh:	46.1	46.1	43.7	50.6	60.7	60.7	74.9	31.7	28.4	55.4	40.6	40.6
User DelAdj:	1.00	1.00	1.00	1.00	1.00	1.00	1.00	1.00	1.00	1.00	1.00	1.00
AdjDel/Veh:	46.1	46.1	43.7	50.6	60.7	60.7	74.9	31.7	28.4	55.4	40.6	40.6
LOS by Move:	D	D	D	D	E	E	E	C	C	E	D	D
HCM2k95thQ:	28	28	22	7	17	17	14	20	10	7	34	34

Note: Queue reported is the number of cars per lane.

BART Phase II Extension Project

Level Of Service Computation Report
 2000 HCM Operations (Future Volume Alternative)
 PM - 2035 No Project Conditions

Intersection #3693: MERIDIAN/SAN CARLOS

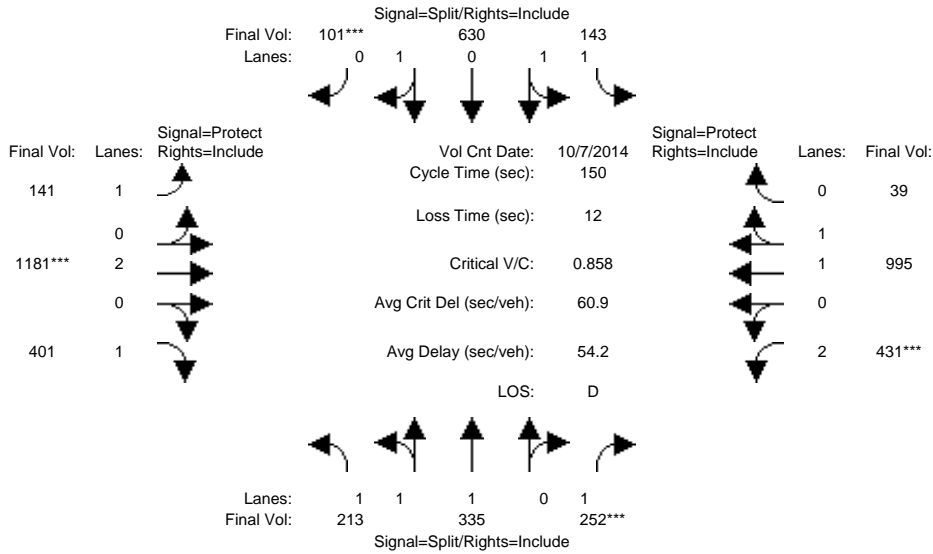

Approach:	North Bound			South Bound			East Bound			West Bound		
Movement:	L	T	R	L	T	R	L	T	R	L	T	R
Min. Green:	10	10	10	10	10	10	7	10	10	7	10	10
Y+R:	4.0	4.0	4.0	4.0	4.0	4.0	4.0	4.0	4.0	4.0	4.0	4.0
Volume Module: >> Count Date: 7 Oct 2014 <<												
Base Vol:	213	335	252	143	630	101	141	1181	401	431	995	39
Growth Adj:	1.00	1.00	1.00	1.00	1.00	1.00	1.00	1.00	1.00	1.00	1.00	1.00
Initial Bse:	213	335	252	143	630	101	141	1181	401	431	995	39
Added Vol:	0	0	0	0	0	0	0	0	0	0	0	0
PasserByVol:	0	0	0	0	0	0	0	0	0	0	0	0
Initial Fut:	213	335	252	143	630	101	141	1181	401	431	995	39
User Adj:	1.00	1.00	1.00	1.00	1.00	1.00	1.00	1.00	1.00	1.00	1.00	1.00
PHF Adj:	1.00	1.00	1.00	1.00	1.00	1.00	1.00	1.00	1.00	1.00	1.00	1.00
PHF Volume:	213	335	252	143	630	101	141	1181	401	431	995	39
Reduct Vol:	0	0	0	0	0	0	0	0	0	0	0	0
Reduced Vol:	213	335	252	143	630	101	141	1181	401	431	995	39
PCE Adj:	1.00	1.00	1.00	1.00	1.00	1.00	1.00	1.00	1.00	1.00	1.00	1.00
MLF Adj:	1.00	1.00	1.00	1.00	1.00	1.00	1.00	1.00	1.00	1.00	1.00	1.00
Final Volume:	213	335	252	143	630	101	141	1181	401	431	995	39
Saturation Flow Module:												
Sat/Lane:	1900	1900	1900	1900	1900	1900	1900	1900	1900	1900	1900	1900
Adjustment:	0.92	0.98	0.92	0.92	0.98	0.95	0.92	1.00	0.92	0.83	0.97	0.95
Lanes:	1.20	1.80	1.00	1.00	1.72	0.28	1.00	2.00	1.00	2.00	1.92	0.08
Final Sat.:	2117	3329	1750	1750	3188	511	1750	3800	1750	3150	3560	140
Capacity Analysis Module:												
Vol/Sat:	0.10	0.10	0.14	0.08	0.20	0.08	0.31	0.23	0.14	0.28	0.28	
Crit Moves:			****			****			****			
Green Time:	25.2	25.2	25.2	34.6	34.6	34.6	17.5	54.3	54.3	23.9	60.8	60.8
Volume/Cap:	0.60	0.60	0.86	0.35	0.86	0.86	0.69	0.86	0.63	0.86	0.69	0.69
Delay/Veh:	58.9	58.9	82.1	48.5	62.8	62.8	73.2	49.9	41.7	75.1	38.2	38.2
User DelAdj:	1.00	1.00	1.00	1.00	1.00	1.00	1.00	1.00	1.00	1.00	1.00	1.00
AdjDel/Veh:	58.9	58.9	82.1	48.5	62.8	62.8	73.2	49.9	41.7	75.1	38.2	38.2
LOS by Move:	E	E	F	D	E	E	E	D	D	E	D	D
HCM2k95thQ:	15	15	24	11	30	30	13	43	28	23	34	34

Note: Queue reported is the number of cars per lane.

BART Phase II Extension Project

Level Of Service Computation Report
 2000 HCM Operations (Future Volume Alternative)
 AM - 2035 No Project Conditions

Intersection #3709: MONTGOMERY/PARK

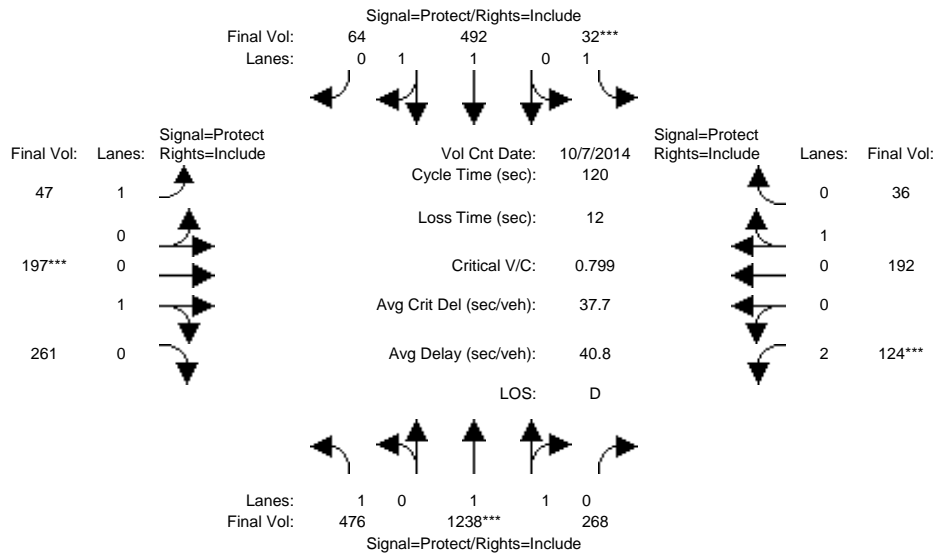

Approach:	North Bound			South Bound			East Bound			West Bound		
	L	T	R	L	T	R	L	T	R	L	T	R
Min. Green:	7	10	10	7	10	10	7	10	10	7	10	10
Y+R:	4.0	4.0	4.0	4.0	4.0	4.0	4.0	4.0	4.0	4.0	4.0	4.0
Volume Module: >> Count Date: 7 Oct 2014 <<												
Base Vol:	476	1238	268	32	492	64	47	197	261	124	192	36
Growth Adj:	1.00	1.00	1.00	1.00	1.00	1.00	1.00	1.00	1.00	1.00	1.00	1.00
Initial Bse:	476	1238	268	32	492	64	47	197	261	124	192	36
Added Vol:	0	0	0	0	0	0	0	0	0	0	0	0
PasserByVol:	0	0	0	0	0	0	0	0	0	0	0	0
Initial Fut:	476	1238	268	32	492	64	47	197	261	124	192	36
User Adj:	1.00	1.00	1.00	1.00	1.00	1.00	1.00	1.00	1.00	1.00	1.00	1.00
PHF Adj:	1.00	1.00	1.00	1.00	1.00	1.00	1.00	1.00	1.00	1.00	1.00	1.00
PHF Volume:	476	1238	268	32	492	64	47	197	261	124	192	36
Reduct Vol:	0	0	0	0	0	0	0	0	0	0	0	0
Reduced Vol:	476	1238	268	32	492	64	47	197	261	124	192	36
PCE Adj:	1.00	1.00	1.00	1.00	1.00	1.00	1.00	1.00	1.00	1.00	1.00	1.00
MLF Adj:	1.00	1.00	1.00	1.00	1.00	1.00	1.00	1.00	1.00	1.00	1.00	1.00
Final Volume:	476	1238	268	32	492	64	47	197	261	124	192	36
Saturation Flow Module:												
Sat/Lane:	1900	1900	1900	1900	1900	1900	1900	1900	1900	1900	1900	1900
Adjustment:	0.92	0.98	0.95	0.92	0.98	0.95	0.92	0.95	0.95	0.83	0.95	0.95
Lanes:	1.00	1.63	0.37	1.00	1.76	0.24	1.00	0.43	0.57	2.00	0.84	0.16
Final Sat.:	1750	3041	658	1750	3274	426	1750	774	1026	3150	1516	284
Capacity Analysis Module:												
Vol/Sat:	0.27	0.41	0.41	0.02	0.15	0.15	0.03	0.25	0.25	0.04	0.13	0.13
Crit Moves:	****			****			****			****		
Green Time:	41.8	57.8	57.8	7.0	23.1	23.1	13.6	36.2	36.2	7.0	29.5	29.5
Volume/Cap:	0.78	0.84	0.84	0.31	0.78	0.78	0.24	0.84	0.84	0.67	0.51	0.51
Delay/Veh:	41.5	31.0	31.0	56.0	51.7	51.7	49.1	50.9	50.9	64.9	40.1	40.1
User DelAdj:	1.00	1.00	1.00	1.00	1.00	1.00	1.00	1.00	1.00	1.00	1.00	1.00
AdjDel/Veh:	41.5	31.0	31.0	56.0	51.7	51.7	49.1	50.9	50.9	64.9	40.1	40.1
LOS by Move:	D	C	C	E	D	D	D	D	D	E	D	D
HCM2k95thQ:	30	43	43	3	21	21	3	31	31	6	14	14

Note: Queue reported is the number of cars per lane.

BART Phase II Extension Project

Level Of Service Computation Report
 2000 HCM Operations (Future Volume Alternative)
 PM - 2035 No Project Conditions

Intersection #3709: MONTGOMERY/PARK

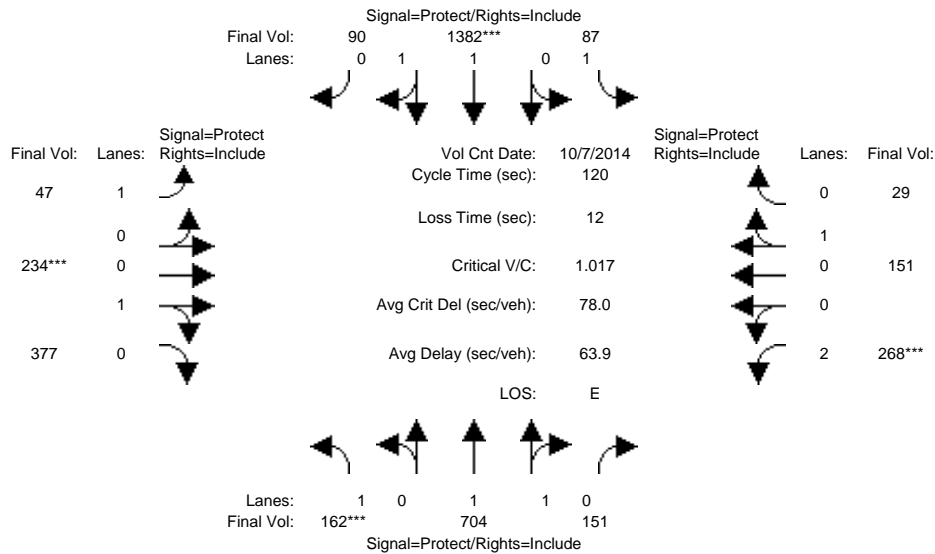

Approach:	North Bound			South Bound			East Bound			West Bound		
	L	T	R	L	T	R	L	T	R	L	T	R
Min. Green:	7	10	10	7	10	10	7	10	10	7	10	10
Y+R:	4.0	4.0	4.0	4.0	4.0	4.0	4.0	4.0	4.0	4.0	4.0	4.0
Volume Module: >> Count Date: 7 Oct 2014 <<												
Base Vol:	162	704	151	87	1382	90	47	234	377	268	151	29
Growth Adj:	1.00	1.00	1.00	1.00	1.00	1.00	1.00	1.00	1.00	1.00	1.00	1.00
Initial Bse:	162	704	151	87	1382	90	47	234	377	268	151	29
Added Vol:	0	0	0	0	0	0	0	0	0	0	0	0
PasserByVol:	0	0	0	0	0	0	0	0	0	0	0	0
Initial Fut:	162	704	151	87	1382	90	47	234	377	268	151	29
User Adj:	1.00	1.00	1.00	1.00	1.00	1.00	1.00	1.00	1.00	1.00	1.00	1.00
PHF Adj:	1.00	1.00	1.00	1.00	1.00	1.00	1.00	1.00	1.00	1.00	1.00	1.00
PHF Volume:	162	704	151	87	1382	90	47	234	377	268	151	29
Reduct Vol:	0	0	0	0	0	0	0	0	0	0	0	0
Reduced Vol:	162	704	151	87	1382	90	47	234	377	268	151	29
PCE Adj:	1.00	1.00	1.00	1.00	1.00	1.00	1.00	1.00	1.00	1.00	1.00	1.00
MLF Adj:	1.00	1.00	1.00	1.00	1.00	1.00	1.00	1.00	1.00	1.00	1.00	1.00
Final Volume:	162	704	151	87	1382	90	47	234	377	268	151	29
Saturation Flow Module:												
Sat/Lane:	1900	1900	1900	1900	1900	1900	1900	1900	1900	1900	1900	1900
Adjustment:	0.92	0.98	0.95	0.92	0.98	0.95	0.92	0.95	0.95	0.83	0.95	0.95
Lanes:	1.00	1.64	0.36	1.00	1.87	0.13	1.00	0.38	0.62	2.00	0.84	0.16
Final Sat.:	1750	3046	653	1750	3474	226	1750	689	1111	3150	1510	290
Capacity Analysis Module:												
Vol/Sat:	0.09	0.23	0.23	0.05	0.40	0.40	0.03	0.34	0.34	0.09	0.10	0.10
Crit Moves:	****			****			****			****		
Green Time:	10.9	46.2	46.2	11.7	47.0	47.0	18.5	40.1	40.1	10.0	31.6	31.6
Volume/Cap:	1.02	0.60	0.60	0.51	1.02	1.02	0.17	1.02	1.02	1.02	0.38	0.38
Delay/Veh:	130.3	30.2	30.2	54.1	64.4	64.4	44.5	80.9	80.9	114.7	36.6	36.6
User DelAdj:	1.00	1.00	1.00	1.00	1.00	1.00	1.00	1.00	1.00	1.00	1.00	1.00
AdjDel/Veh:	130.3	30.2	30.2	54.1	64.4	64.4	44.5	80.9	80.9	114.7	36.6	36.6
LOS by Move:	F	C	C	D	E	E	D	F	F	F	D	D
HCM2k95thQ:	16	23	23	8	57	57	3	47	47	15	11	11

Note: Queue reported is the number of cars per lane.

BART Phase II Extension Project

Level Of Service Computation Report
 2000 HCM Operations (Future Volume Alternative)
 AM - 2035 No Project Conditions

Intersection #3710: MONTGOMERY/SAN FERNANDO

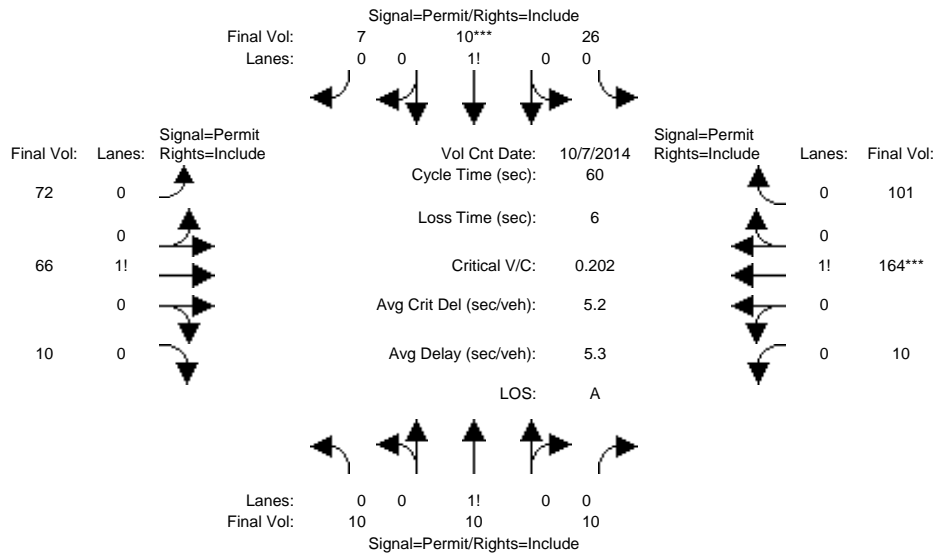

Approach:	North Bound			South Bound			East Bound			West Bound		
	L	T	R	L	T	R	L	T	R	L	T	R
Min. Green:	10	10	10	10	10	10	10	10	10	10	10	10
Y+R:	4.0	4.0	4.0	4.0	4.0	4.0	4.0	4.0	4.0	4.0	4.0	4.0

Volume Module:	>> Count Date: 7 Oct 2014 <<											
Base Vol:	10	10	10	26	10	7	72	66	10	10	164	101
Growth Adj:	1.00	1.00	1.00	1.00	1.00	1.00	1.00	1.00	1.00	1.00	1.00	1.00
Initial Bse:	10	10	10	26	10	7	72	66	10	10	164	101
Added Vol:	0	0	0	0	0	0	0	0	0	0	0	0
PasserByVol:	0	0	0	0	0	0	0	0	0	0	0	0
Initial Fut:	10	10	10	26	10	7	72	66	10	10	164	101
User Adj:	1.00	1.00	1.00	1.00	1.00	1.00	1.00	1.00	1.00	1.00	1.00	1.00
PHF Adj:	1.00	1.00	1.00	1.00	1.00	1.00	1.00	1.00	1.00	1.00	1.00	1.00
PHF Volume:	10	10	10	26	10	7	72	66	10	10	164	101
Reduct Vol:	0	0	0	0	0	0	0	0	0	0	0	0
Reduced Vol:	10	10	10	26	10	7	72	66	10	10	164	101
PCE Adj:	1.00	1.00	1.00	1.00	1.00	1.00	1.00	1.00	1.00	1.00	1.00	1.00
MLF Adj:	1.00	1.00	1.00	1.00	1.00	1.00	1.00	1.00	1.00	1.00	1.00	1.00
FinalVolume:	10	10	10	26	10	7	72	66	10	10	164	101

Saturation Flow Module:												
Sat/Lane:	1900	1900	1900	1900	1900	1900	1900	1900	1900	1900	1900	1900
Adjustment:	0.92	0.92	0.92	0.92	0.92	0.92	0.92	0.92	0.92	0.92	0.92	0.92
Lanes:	0.34	0.33	0.33	0.61	0.23	0.16	0.49	0.44	0.07	0.04	0.59	0.37
Final Sat.:	583	583	583	1058	407	285	851	780	118	64	1044	643

Capacity Analysis Module:												
Vol/Sat:	0.02	0.02	0.02	0.02	0.02	0.02	0.08	0.08	0.08	0.16	0.16	0.16
Crit Moves:				****						****		
Green Time:	10.0	10.0	10.0	10.0	10.0	10.0	44.0	44.0	44.0	44.0	44.0	44.0
Volume/Cap:	0.10	0.10	0.10	0.15	0.15	0.15	0.12	0.12	0.12	0.21	0.21	0.21
Delay/Veh:	21.4	21.4	21.4	21.6	21.6	21.6	2.4	2.4	2.4	2.6	2.6	2.6
User DelAdj:	1.00	1.00	1.00	1.00	1.00	1.00	1.00	1.00	1.00	1.00	1.00	1.00
AdjDel/Veh:	21.4	21.4	21.4	21.6	21.6	21.6	2.4	2.4	2.4	2.6	2.6	2.6
LOS by Move:	C	C	C	C	C	C	A	A	A	A	A	A
HCM2k95thQ:	1	1	1	1	1	1	2	2	2	4	4	4

Note: Queue reported is the number of cars per lane.

BART Phase II Extension Project

Level Of Service Computation Report
 2000 HCM Operations (Future Volume Alternative)
 PM - 2035 No Project Conditions

Intersection #3710: MONTGOMERY/SAN FERNANDO

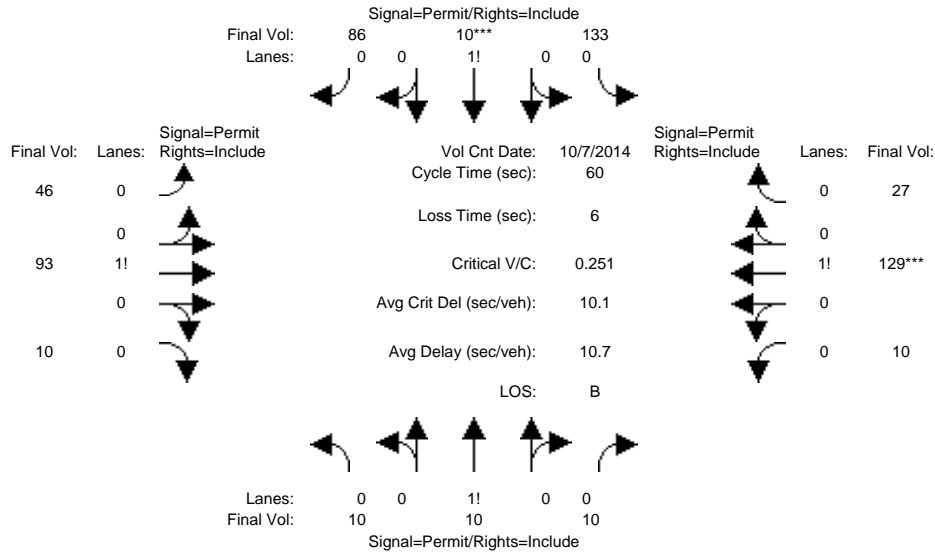

Approach:	North Bound			South Bound			East Bound			West Bound		
Movement:	L	T	R	L	T	R	L	T	R	L	T	R
Min. Green:	10	10	10	10	10	10	10	10	10	10	10	10
Y+R:	4.0	4.0	4.0	4.0	4.0	4.0	4.0	4.0	4.0	4.0	4.0	4.0
Volume Module: >> Count Date: 7 Oct 2014 <<												
Base Vol:	10	10	10	133	10	86	46	93	10	10	129	27
Growth Adj:	1.00	1.00	1.00	1.00	1.00	1.00	1.00	1.00	1.00	1.00	1.00	1.00
Initial Bse:	10	10	10	133	10	86	46	93	10	10	129	27
Added Vol:	0	0	0	0	0	0	0	0	0	0	0	0
PasserByVol:	0	0	0	0	0	0	0	0	0	0	0	0
Initial Fut:	10	10	10	133	10	86	46	93	10	10	129	27
User Adj:	1.00	1.00	1.00	1.00	1.00	1.00	1.00	1.00	1.00	1.00	1.00	1.00
PHF Adj:	1.00	1.00	1.00	1.00	1.00	1.00	1.00	1.00	1.00	1.00	1.00	1.00
PHF Volume:	10	10	10	133	10	86	46	93	10	10	129	27
Reduct Vol:	0	0	0	0	0	0	0	0	0	0	0	0
Reduced Vol:	10	10	10	133	10	86	46	93	10	10	129	27
PCE Adj:	1.00	1.00	1.00	1.00	1.00	1.00	1.00	1.00	1.00	1.00	1.00	1.00
MLF Adj:	1.00	1.00	1.00	1.00	1.00	1.00	1.00	1.00	1.00	1.00	1.00	1.00
FinalVolume:	10	10	10	133	10	86	46	93	10	10	129	27
Saturation Flow Module:												
Sat/Lane:	1900	1900	1900	1900	1900	1900	1900	1900	1900	1900	1900	1900
Adjustment:	0.92	0.92	0.92	0.92	0.92	0.92	0.92	0.92	0.92	0.92	0.92	0.92
Lanes:	0.34	0.33	0.33	0.58	0.04	0.38	0.31	0.62	0.07	0.06	0.78	0.16
Final Sat.:	583	583	583	1016	76	657	540	1092	117	105	1360	285
Capacity Analysis Module:												
Vol/Sat:	0.02	0.02	0.02	0.13	0.13	0.13	0.09	0.09	0.09	0.09	0.09	0.09
Crit Moves:	*****											
Green Time:	31.3	31.3	31.3	31.3	31.3	31.3	22.7	22.7	22.7	22.7	22.7	22.7
Volume/Cap:	0.03	0.03	0.03	0.25	0.25	0.25	0.23	0.23	0.23	0.25	0.25	0.25
Delay/Veh:	7.0	7.0	7.0	8.0	8.0	8.0	12.9	12.9	12.9	13.0	13.0	13.0
User DelAdj:	1.00	1.00	1.00	1.00	1.00	1.00	1.00	1.00	1.00	1.00	1.00	1.00
AdjDel/Veh:	7.0	7.0	7.0	8.0	8.0	8.0	12.9	12.9	12.9	13.0	13.0	13.0
LOS by Move:	A	A	A	A	A	A	B	B	B	B	B	B
HCM2k95thQ:	1	1	1	5	5	5	4	4	4	4	4	4

Note: Queue reported is the number of cars per lane.

BART Phase II Extension Project

Level Of Service Computation Report
 2000 HCM Operations (Future Volume Alternative)
 AM - 2035 No Project Conditions

Intersection #3748: RACE/SAN CARLOS

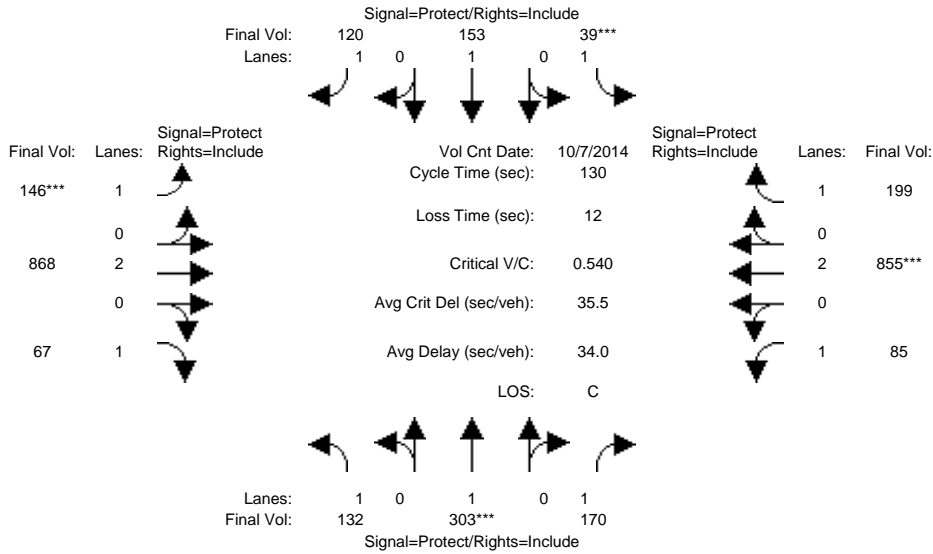

Approach:	North Bound			South Bound			East Bound			West Bound		
	L	T	R	L	T	R	L	T	R	L	T	R
Min. Green:	7	10	10	7	10	10	7	10	10	7	10	10
Y+R:	4.0	4.0	4.0	4.0	4.0	4.0	4.0	4.0	4.0	4.0	4.0	4.0
Volume Module: >> Count Date: 7 Oct 2014 <<												
Base Vol:	132	303	170	39	153	120	146	868	67	85	855	199
Growth Adj:	1.00	1.00	1.00	1.00	1.00	1.00	1.00	1.00	1.00	1.00	1.00	1.00
Initial Bse:	132	303	170	39	153	120	146	868	67	85	855	199
Added Vol:	0	0	0	0	0	0	0	0	0	0	0	0
PasserByVol:	0	0	0	0	0	0	0	0	0	0	0	0
Initial Fut:	132	303	170	39	153	120	146	868	67	85	855	199
User Adj:	1.00	1.00	1.00	1.00	1.00	1.00	1.00	1.00	1.00	1.00	1.00	1.00
PHF Adj:	1.00	1.00	1.00	1.00	1.00	1.00	1.00	1.00	1.00	1.00	1.00	1.00
PHF Volume:	132	303	170	39	153	120	146	868	67	85	855	199
Reduct Vol:	0	0	0	0	0	0	0	0	0	0	0	0
Reduced Vol:	132	303	170	39	153	120	146	868	67	85	855	199
PCE Adj:	1.00	1.00	1.00	1.00	1.00	1.00	1.00	1.00	1.00	1.00	1.00	1.00
MLF Adj:	1.00	1.00	1.00	1.00	1.00	1.00	1.00	1.00	1.00	1.00	1.00	1.00
Final Volume:	132	303	170	39	153	120	146	868	67	85	855	199
Saturation Flow Module:												
Sat/Lane:	1900	1900	1900	1900	1900	1900	1900	1900	1900	1900	1900	1900
Adjustment:	0.92	1.00	0.92	0.92	1.00	0.92	0.92	1.00	0.92	0.92	1.00	0.92
Lanes:	1.00	1.00	1.00	1.00	1.00	1.00	1.00	2.00	1.00	1.00	2.00	1.00
Final Sat.:	1750	1900	1750	1750	1900	1750	1750	3800	1750	1750	3800	1750
Capacity Analysis Module:												
Vol/Sat:	0.08	0.16	0.10	0.02	0.08	0.07	0.08	0.23	0.04	0.05	0.23	0.11
Crit Moves:	****			****			****			****		
Green Time:	21.7	37.8	37.8	7.0	23.1	23.1	19.8	59.2	59.2	14.0	53.4	53.4
Volume/Cap:	0.45	0.55	0.33	0.41	0.45	0.39	0.55	0.50	0.08	0.45	0.55	0.28
Delay/Veh:	49.9	40.0	36.6	62.4	48.7	47.9	53.4	25.2	20.1	56.2	29.6	25.7
User DelAdj:	1.00	1.00	1.00	1.00	1.00	1.00	1.00	1.00	1.00	1.00	1.00	1.00
AdjDel/Veh:	49.9	40.0	36.6	62.4	48.7	47.9	53.4	25.2	20.1	56.2	29.6	25.7
LOS by Move:	D	D	D	E	D	D	D	C	C	E	C	C
HCM2k95thQ:	10	18	11	3	10	9	11	21	3	7	23	11

Note: Queue reported is the number of cars per lane.

BART Phase II Extension Project

Level Of Service Computation Report
 2000 HCM Operations (Future Volume Alternative)
 PM - 2035 No Project Conditions

Intersection #3748: RACE/SAN CARLOS

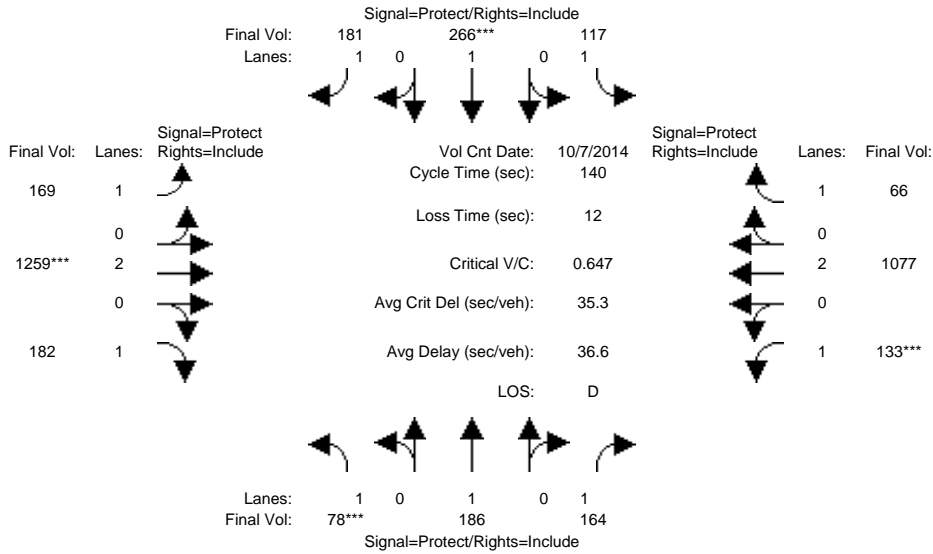

Approach:	North Bound			South Bound			East Bound			West Bound		
Movement:	L	T	R	L	T	R	L	T	R	L	T	R
Min. Green:	7	10	10	7	10	10	7	10	10	7	10	10
Y+R:	4.0	4.0	4.0	4.0	4.0	4.0	4.0	4.0	4.0	4.0	4.0	4.0
Volume Module: >> Count Date: 7 Oct 2014 <<												
Base Vol:	78	186	164	117	266	181	169	1259	182	133	1077	66
Growth Adj:	1.00	1.00	1.00	1.00	1.00	1.00	1.00	1.00	1.00	1.00	1.00	1.00
Initial Bse:	78	186	164	117	266	181	169	1259	182	133	1077	66
Added Vol:	0	0	0	0	0	0	0	0	0	0	0	0
PasserByVol:	0	0	0	0	0	0	0	0	0	0	0	0
Initial Fut:	78	186	164	117	266	181	169	1259	182	133	1077	66
User Adj:	1.00	1.00	1.00	1.00	1.00	1.00	1.00	1.00	1.00	1.00	1.00	1.00
PHF Adj:	1.00	1.00	1.00	1.00	1.00	1.00	1.00	1.00	1.00	1.00	1.00	1.00
PHF Volume:	78	186	164	117	266	181	169	1259	182	133	1077	66
Reduct Vol:	0	0	0	0	0	0	0	0	0	0	0	0
Reduced Vol:	78	186	164	117	266	181	169	1259	182	133	1077	66
PCE Adj:	1.00	1.00	1.00	1.00	1.00	1.00	1.00	1.00	1.00	1.00	1.00	1.00
MLF Adj:	1.00	1.00	1.00	1.00	1.00	1.00	1.00	1.00	1.00	1.00	1.00	1.00
FinalVolume:	78	186	164	117	266	181	169	1259	182	133	1077	66
Saturation Flow Module:												
Sat/Lane:	1900	1900	1900	1900	1900	1900	1900	1900	1900	1900	1900	1900
Adjustment:	0.92	1.00	0.92	0.92	1.00	0.92	0.92	1.00	0.92	0.92	1.00	0.92
Lanes:	1.00	1.00	1.00	1.00	1.00	1.00	1.00	2.00	1.00	1.00	2.00	1.00
Final Sat.:	1750	1900	1750	1750	1900	1750	1750	3800	1750	1750	3800	1750
Capacity Analysis Module:												
Vol/Sat:	0.04	0.10	0.09	0.07	0.14	0.10	0.10	0.33	0.10	0.08	0.28	0.04
Crit Moves:	****			****			****			****		
Green Time:	9.6	23.7	23.7	16.2	30.3	30.3	22.4	71.6	71.6	16.4	65.7	65.7
Volume/Cap:	0.65	0.58	0.55	0.58	0.65	0.48	0.60	0.65	0.20	0.65	0.60	0.08
Delay/Veh:	75.2	56.1	55.6	62.8	53.6	48.9	58.4	25.7	18.7	66.0	28.1	20.5
User DelAdj:	1.00	1.00	1.00	1.00	1.00	1.00	1.00	1.00	1.00	1.00	1.00	1.00
AdjDel/Veh:	75.2	56.1	55.6	62.8	53.6	48.9	58.4	25.7	18.7	66.0	28.1	20.5
LOS by Move:	E	E	E	E	D	D	E	C	B	E	C	C
HCM2k95thQ:	7	14	13	10	19	14	14	33	9	12	29	3

Note: Queue reported is the number of cars per lane.

BART Phase II Extension Project

Level Of Service Computation Report
 2000 HCM Operations (Future Volume Alternative)
 AM - 2035 No Project Conditions

Intersection #3985: DELMAS/SAN FERNANDO

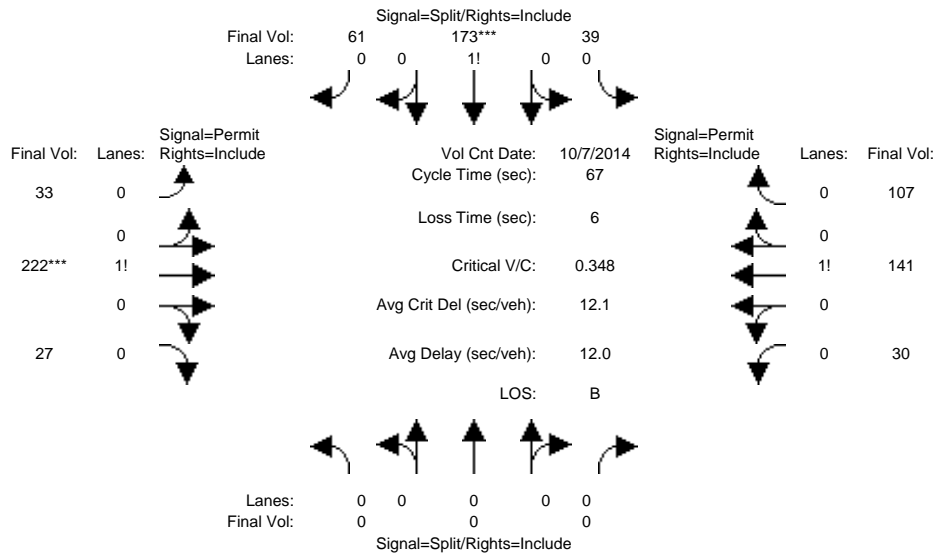

Approach:	North Bound			South Bound			East Bound			West Bound		
	L	T	R	L	T	R	L	T	R	L	T	R
Min. Green:	0	0	0	10	10	10	10	10	10	10	10	10
Y+R:	4.0	4.0	4.0	4.0	4.0	4.0	4.0	4.0	4.0	4.0	4.0	4.0
Volume Module: >> Count Date: 7 Oct 2014 <<												
Base Vol:	0	0	0	39	173	61	33	222	27	30	141	107
Growth Adj:	1.00	1.00	1.00	1.00	1.00	1.00	1.00	1.00	1.00	1.00	1.00	1.00
Initial Bse:	0	0	0	39	173	61	33	222	27	30	141	107
Added Vol:	0	0	0	0	0	0	0	0	0	0	0	0
PasserByVol:	0	0	0	0	0	0	0	0	0	0	0	0
Initial Fut:	0	0	0	39	173	61	33	222	27	30	141	107
User Adj:	1.00	1.00	1.00	1.00	1.00	1.00	1.00	1.00	1.00	1.00	1.00	1.00
PHF Adj:	1.00	1.00	1.00	1.00	1.00	1.00	1.00	1.00	1.00	1.00	1.00	1.00
PHF Volume:	0	0	0	39	173	61	33	222	27	30	141	107
Reduct Vol:	0	0	0	0	0	0	0	0	0	0	0	0
Reduced Vol:	0	0	0	39	173	61	33	222	27	30	141	107
PCE Adj:	1.00	1.00	1.00	1.00	1.00	1.00	1.00	1.00	1.00	1.00	1.00	1.00
MLF Adj:	1.00	1.00	1.00	1.00	1.00	1.00	1.00	1.00	1.00	1.00	1.00	1.00
FinalVolume:	0	0	0	39	173	61	33	222	27	30	141	107
Saturation Flow Module:												
Sat/Lane:	1900	1900	1900	1900	1900	1900	1900	1900	1900	1900	1900	1900
Adjustment:	0.92	1.00	0.92	0.92	0.92	0.92	0.92	0.92	0.92	0.92	0.92	0.92
Lanes:	0.00	0.00	0.00	0.14	0.64	0.22	0.12	0.79	0.09	0.11	0.51	0.38
Final Sat.:	0	0	0	250	1109	391	205	1378	168	189	888	674
Capacity Analysis Module:												
Vol/Sat:	0.00	0.00	0.00	0.16	0.16	0.16	0.16	0.16	0.16	0.16	0.16	0.16
Crit Moves:				****			****					
Green Time:	0.0	0.0	0.0	30.0	30.0	30.0	31.0	31.0	31.0	31.0	31.0	31.0
Volume/Cap:	0.00	0.00	0.00	0.35	0.35	0.35	0.35	0.35	0.35	0.34	0.34	0.34
Delay/Veh:	0.0	0.0	0.0	12.4	12.4	12.4	11.8	11.8	11.8	11.8	11.8	11.8
User DelAdj:	1.00	1.00	1.00	1.00	1.00	1.00	1.00	1.00	1.00	1.00	1.00	1.00
AdjDel/Veh:	0.0	0.0	0.0	12.4	12.4	12.4	11.8	11.8	11.8	11.8	11.8	11.8
LOS by Move:	A	A	A	B	B	B	B	B	B	B	B	B
HCM2k95thQ:	0	0	0	8	8	8	8	8	8	8	8	8

Note: Queue reported is the number of cars per lane.

BART Phase II Extension Project

Level Of Service Computation Report
 2000 HCM Operations (Future Volume Alternative)
 PM - 2035 No Project Conditions

Intersection #3985: DELMAS/SAN FERNANDO

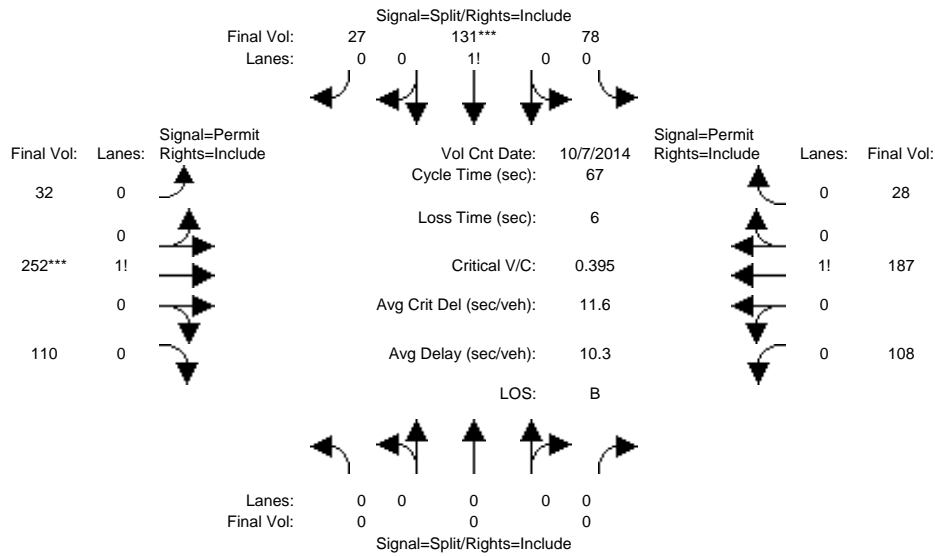

Approach:	North Bound			South Bound			East Bound			West Bound		
	L	T	R	L	T	R	L	T	R	L	T	R
Min. Green:	0	0	0	10	10	10	10	10	10	10	10	10
Y+R:	4.0	4.0	4.0	4.0	4.0	4.0	4.0	4.0	4.0	4.0	4.0	4.0
Volume Module: >> Count Date: 7 Oct 2014 <<												
Base Vol:	0	0	0	78	131	27	32	252	110	108	187	28
Growth Adj:	1.00	1.00	1.00	1.00	1.00	1.00	1.00	1.00	1.00	1.00	1.00	1.00
Initial Bse:	0	0	0	78	131	27	32	252	110	108	187	28
Added Vol:	0	0	0	0	0	0	0	0	0	0	0	0
PasserByVol:	0	0	0	0	0	0	0	0	0	0	0	0
Initial Fut:	0	0	0	78	131	27	32	252	110	108	187	28
User Adj:	1.00	1.00	1.00	1.00	1.00	1.00	1.00	1.00	1.00	1.00	1.00	1.00
PHF Adj:	1.00	1.00	1.00	1.00	1.00	1.00	1.00	1.00	1.00	1.00	1.00	1.00
PHF Volume:	0	0	0	78	131	27	32	252	110	108	187	28
Reduct Vol:	0	0	0	0	0	0	0	0	0	0	0	0
Reduced Vol:	0	0	0	78	131	27	32	252	110	108	187	28
PCE Adj:	1.00	1.00	1.00	1.00	1.00	1.00	1.00	1.00	1.00	1.00	1.00	1.00
MLF Adj:	1.00	1.00	1.00	1.00	1.00	1.00	1.00	1.00	1.00	1.00	1.00	1.00
FinalVolume:	0	0	0	78	131	27	32	252	110	108	187	28
Saturation Flow Module:												
Sat/Lane:	1900	1900	1900	1900	1900	1900	1900	1900	1900	1900	1900	1900
Adjustment:	0.92	1.00	0.92	0.92	0.92	0.92	0.92	0.92	0.92	0.92	0.92	0.92
Lanes:	0.00	0.00	0.00	0.33	0.56	0.11	0.08	0.64	0.28	0.33	0.58	0.09
Final Sat.:	0	0	0	578	971	200	142	1119	489	585	1013	152
Capacity Analysis Module:												
Vol/Sat:	0.00	0.00	0.00	0.13	0.13	0.13	0.23	0.23	0.23	0.18	0.18	0.18
Crit Moves:				****			****					
Green Time:	0.0	0.0	0.0	22.9	22.9	22.9	38.1	38.1	38.1	38.1	38.1	38.1
Volume/Cap:	0.00	0.00	0.00	0.40	0.40	0.40	0.40	0.40	0.40	0.32	0.32	0.32
Delay/Veh:	0.0	0.0	0.0	17.2	17.2	17.2	8.3	8.3	8.3	7.8	7.8	7.8
User DelAdj:	1.00	1.00	1.00	1.00	1.00	1.00	1.00	1.00	1.00	1.00	1.00	1.00
AdjDel/Veh:	0.0	0.0	0.0	17.2	17.2	17.2	8.3	8.3	8.3	7.8	7.8	7.8
LOS by Move:	A	A	A	B	B	B	A	A	A	A	A	A
HCM2k95thQ:	0	0	0	8	8	8	9	9	9	7	7	7

Note: Queue reported is the number of cars per lane.

BART Phase II Extension Project

Level Of Service Computation Report
 2000 HCM Operations (Future Volume Alternative)
 AM - 2035 Project Conditions

Intersection #3013: 87/JULIAN (E) *

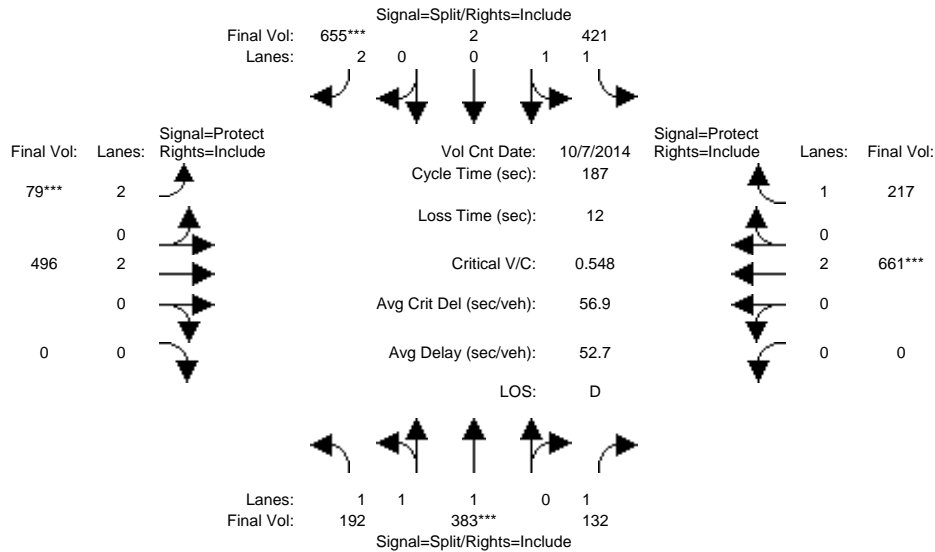

Approach:	North Bound			South Bound			East Bound			West Bound		
	L	T	R	L	T	R	L	T	R	L	T	R
Min. Green:	10	10	10	10	10	10	7	10	0	0	10	10
Y+R:	4.0	4.0	4.0	4.0	4.0	4.0	4.0	4.0	4.0	4.0	4.0	4.0

Volume Module:	>>	Count	Date:	7 Oct 2014	<<												
Base Vol:	192	383	132	421	2	655	79	496	0	0	661	217					
Growth Adj:	1.00	1.00	1.00	1.00	1.00	1.00	1.00	1.00	1.00	1.00	1.00	1.00					
Initial Bse:	192	383	132	421	2	655	79	496	0	0	661	217					
Added Vol:	0	0	0	0	0	0	0	0	0	0	0	0					
PasserByVol:	0	0	0	0	0	0	0	0	0	0	0	0					
Initial Fut:	192	383	132	421	2	655	79	496	0	0	661	217					
User Adj:	1.00	1.00	1.00	1.00	1.00	1.00	1.00	1.00	1.00	1.00	1.00	1.00					
PHF Adj:	1.00	1.00	1.00	1.00	1.00	1.00	1.00	1.00	1.00	1.00	1.00	1.00					
PHF Volume:	192	383	132	421	2	655	79	496	0	0	661	217					
Reduct Vol:	0	0	0	0	0	0	0	0	0	0	0	0					
Reduced Vol:	192	383	132	421	2	655	79	496	0	0	661	217					
PCE Adj:	1.00	1.00	1.00	1.00	1.00	1.00	1.00	1.00	1.00	1.00	1.00	1.00					
MLF Adj:	1.00	1.00	1.00	1.00	1.00	1.00	1.00	1.00	1.00	1.00	1.00	1.00					
Final Volume:	192	383	132	421	2	655	79	496	0	0	661	217					

Saturation Flow Module:												
Sat/Lane:	1900	1900	1900	1900	1900	1900	1900	1900	1900	1900	1900	1900
Adjustment:	0.92	0.97	0.92	0.93	0.95	0.83	0.83	1.00	0.92	0.92	1.00	0.92
Lanes:	1.04	1.96	1.00	1.99	0.01	2.00	2.00	2.00	0.00	0.00	2.00	1.00
Final Sat.:	1819	3628	1750	3533	17	3150	3150	3800	0	0	3800	1750

Capacity Analysis Module:												
Vol/Sat:	0.11	0.11	0.08	0.12	0.12	0.21	0.03	0.13	0.00	0.00	0.17	0.12
Crit Moves:	****			****			****			****		
Green Time:	36.0	36.0	36.0	71.0	71.0	71.0	8.6	68.0	0.0	0.0	59.4	59.4
Volume/Cap:	0.55	0.55	0.39	0.31	0.31	0.55	0.55	0.36	0.00	0.00	0.55	0.39
Delay/Veh:	68.7	68.7	66.6	41.0	41.0	46.0	91.7	43.7	0.0	0.0	53.2	50.2
User DelAdj:	1.00	1.00	1.00	1.00	1.00	1.00	1.00	1.00	1.00	1.00	1.00	1.00
AdjDel/Veh:	68.7	68.7	66.6	41.0	41.0	46.0	91.7	43.7	0.0	0.0	53.2	50.2
LOS by Move:	E	E	E	D	D	D	F	D	A	A	D	D
HCM2k95thQ:	19	19	13	16	16	30	5	18	0	0	27	19

Note: Queue reported is the number of cars per lane.

BART Phase II Extension Project

Level Of Service Computation Report
2000 HCM Operations (Future Volume Alternative)
PM - 2035 Project Conditions

Intersection #3013: 87/JULIAN (E) *

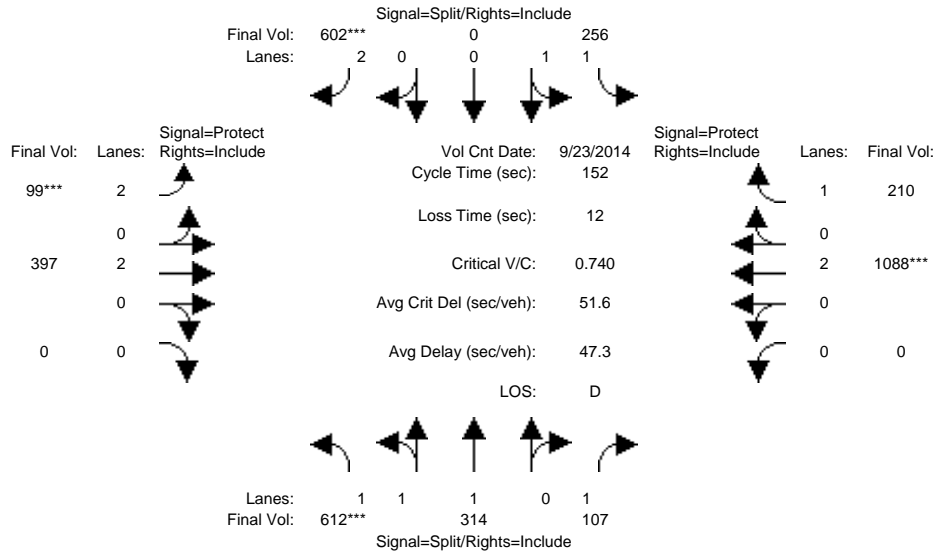

Approach:	North Bound			South Bound			East Bound			West Bound		
Movement:	L	T	R	L	T	R	L	T	R	L	T	R
Min. Green:	10	10	10	10	10	10	7	10	0	0	10	10
Y+R:	4.0	4.0	4.0	4.0	4.0	4.0	4.0	4.0	4.0	4.0	4.0	4.0
Volume Module: >> Count Date: 23 Sep 2014 <<												
Base Vol:	612	314	107	256	0	602	99	397	0	0	1088	210
Growth Adj:	1.00	1.00	1.00	1.00	1.00	1.00	1.00	1.00	1.00	1.00	1.00	1.00
Initial Bse:	612	314	107	256	0	602	99	397	0	0	1088	210
Added Vol:	0	0	0	0	0	0	0	0	0	0	0	0
PasserByVol:	0	0	0	0	0	0	0	0	0	0	0	0
Initial Fut:	612	314	107	256	0	602	99	397	0	0	1088	210
User Adj:	1.00	1.00	1.00	1.00	1.00	1.00	1.00	1.00	1.00	1.00	1.00	1.00
PHF Adj:	1.00	1.00	1.00	1.00	1.00	1.00	1.00	1.00	1.00	1.00	1.00	1.00
PHF Volume:	612	314	107	256	0	602	99	397	0	0	1088	210
Reduct Vol:	0	0	0	0	0	0	0	0	0	0	0	0
Reduced Vol:	612	314	107	256	0	602	99	397	0	0	1088	210
PCE Adj:	1.00	1.00	1.00	1.00	1.00	1.00	1.00	1.00	1.00	1.00	1.00	1.00
MLF Adj:	1.00	1.00	1.00	1.00	1.00	1.00	1.00	1.00	1.00	1.00	1.00	1.00
FinalVolume:	612	314	107	256	0	602	99	397	0	0	1088	210
Saturation Flow Module:												
Sat/Lane:	1900	1900	1900	1900	1900	1900	1900	1900	1900	1900	1900	1900
Adjustment:	0.93	1.00	0.92	0.93	1.00	0.83	0.83	1.00	0.92	0.92	1.00	0.92
Lanes:	2.00	1.00	1.00	2.00	0.00	2.00	2.00	2.00	0.00	0.00	2.00	1.00
Final Sat.:	3550	1898	1750	3550	0	3150	3150	3800	0	0	3800	1750
Capacity Analysis Module:												
Vol/Sat:	0.17	0.17	0.06	0.07	0.00	0.19	0.03	0.10	0.00	0.00	0.29	0.12
Crit Moves:	****					****	****			****		
Green Time:	35.3	35.3	35.3	39.1	0.0	39.1	7.0	65.6	0.0	0.0	58.6	58.6
Volume/Cap:	0.74	0.71	0.26	0.28	0.00	0.74	0.68	0.24	0.00	0.00	0.74	0.31
Delay/Veh:	56.6	55.6	48.1	45.3	0.0	55.5	84.0	27.5	0.0	0.0	42.3	32.9
User DelAdj:	1.00	1.00	1.00	1.00	1.00	1.00	1.00	1.00	1.00	1.00	1.00	1.00
AdjDel/Veh:	56.6	55.6	48.1	45.3	0.0	55.5	84.0	27.5	0.0	0.0	42.3	32.9
LOS by Move:	E	E	D	D	A	E	F	C	A	A	D	C
HCM2k95thQ:	25	24	8	10	0	29	6	11	0	0	37	14

Note: Queue reported is the number of cars per lane.

BART Phase II Extension Project

Level Of Service Computation Report
 2000 HCM Operations (Future Volume Alternative)
 AM - 2035 Project Conditions

Intersection #3014: 87/JULIAN (W)

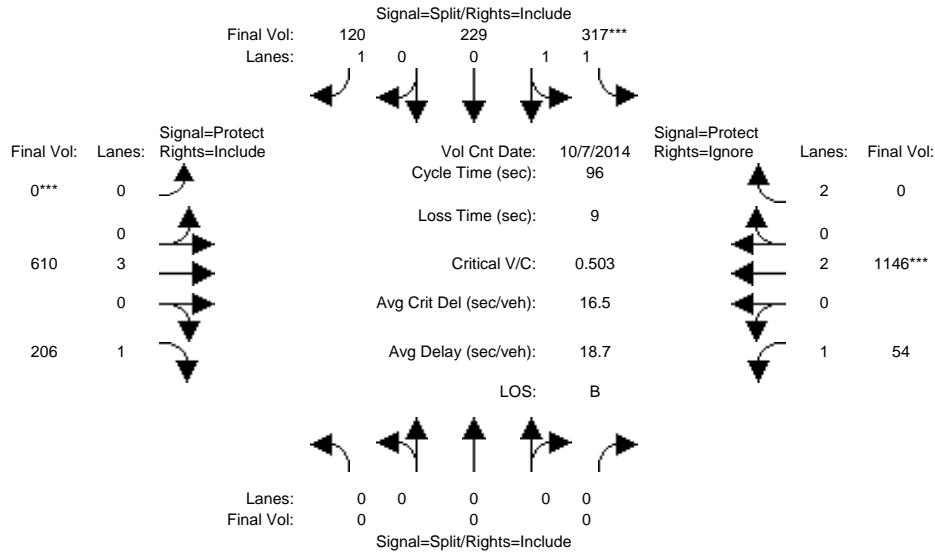

Approach:	North Bound			South Bound			East Bound			West Bound		
	L	T	R	L	T	R	L	T	R	L	T	R
Min. Green:	0	0	0	10	10	10	0	10	10	7	10	10
Y+R:	4.0	4.0	4.0	4.0	4.0	4.0	4.0	4.0	4.0	4.0	4.0	4.0
Volume Module: >> Count Date: 7 Oct 2014 <<												
Base Vol:	0	0	0	317	229	120	0	610	206	54	1146	0
Growth Adj:	1.00	1.00	1.00	1.00	1.00	1.00	1.00	1.00	1.00	1.00	1.00	1.00
Initial Bse:	0	0	0	317	229	120	0	610	206	54	1146	0
Added Vol:	0	0	0	0	0	0	0	0	0	0	0	0
PasserByVol:	0	0	0	0	0	0	0	0	0	0	0	0
Initial Fut:	0	0	0	317	229	120	0	610	206	54	1146	0
User Adj:	1.00	1.00	1.00	1.00	1.00	1.00	1.00	1.00	1.00	1.00	1.00	0.00
PHF Adj:	1.00	1.00	1.00	1.00	1.00	1.00	1.00	1.00	1.00	1.00	1.00	0.00
PHF Volume:	0	0	0	317	229	120	0	610	206	54	1146	0
Reduct Vol:	0	0	0	0	0	0	0	0	0	0	0	0
Reduced Vol:	0	0	0	317	229	120	0	610	206	54	1146	0
PCE Adj:	1.00	1.00	1.00	1.00	1.00	1.00	1.00	1.00	1.00	1.00	1.00	0.00
MLF Adj:	1.00	1.00	1.00	1.00	1.00	1.00	1.00	1.00	1.00	1.00	1.00	0.00
FinalVolume:	0	0	0	317	229	120	0	610	206	54	1146	0
Saturation Flow Module:												
Sat/Lane:	1900	1900	1900	1900	1900	1900	1900	1900	1900	1900	1900	1900
Adjustment:	0.92	1.00	0.92	0.92	0.95	0.92	0.92	1.00	0.92	0.92	1.00	0.83
Lanes:	0.00	0.00	0.00	1.17	0.83	1.00	0.00	3.00	1.00	1.00	2.00	2.00
Final Sat.:	0	0	0	2061	1489	1750	0	5700	1750	1750	3800	3150
Capacity Analysis Module:												
Vol/Sat:	0.00	0.00	0.00	0.15	0.15	0.07	0.00	0.11	0.12	0.03	0.30	0.00
Crit Moves:				****				****				****
Green Time:	0.0	0.0	0.0	29.4	29.4	29.4	0.0	35.6	35.6	22.0	57.6	0.0
Volume/Cap:	0.00	0.00	0.00	0.50	0.50	0.22	0.00	0.29	0.32	0.13	0.50	0.00
Delay/Veh:	0.0	0.0	0.0	27.7	27.7	25.0	0.0	21.4	21.8	29.6	11.2	0.0
User DelAdj:	1.00	1.00	1.00	1.00	1.00	1.00	1.00	1.00	1.00	1.00	1.00	1.00
AdjDel/Veh:	0.0	0.0	0.0	27.7	27.7	25.0	0.0	21.4	21.8	29.6	11.2	0.0
LOS by Move:	A	A	A	C	C	C	A	C	C	C	B	A
HCM2k95thQ:	0	0	0	14	14	6	0	8	9	3	17	0

Note: Queue reported is the number of cars per lane.

BART Phase II Extension Project

Level Of Service Computation Report
 2000 HCM Operations (Future Volume Alternative)
 PM - 2035 Project Conditions

Intersection #3014: 87/JULIAN (W)

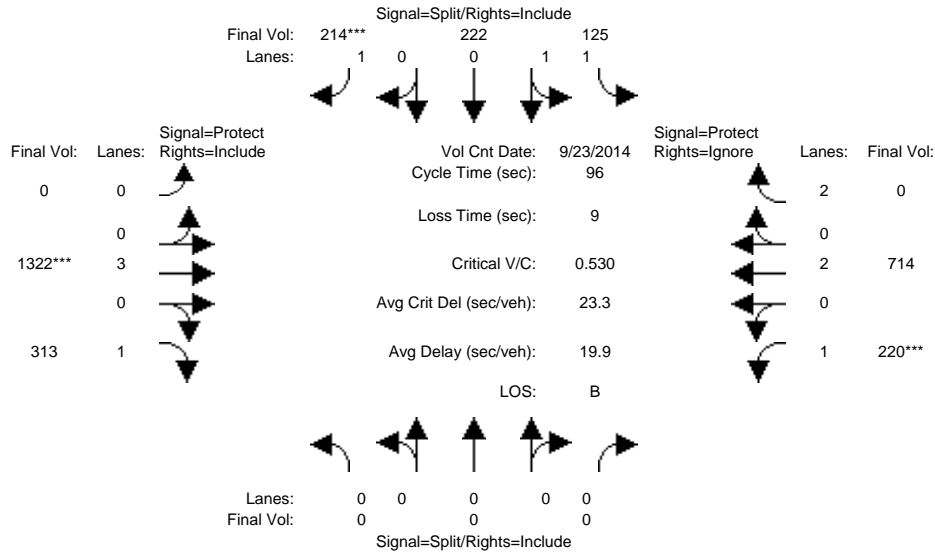

Approach:	North Bound			South Bound			East Bound			West Bound		
Movement:	L	T	R	L	T	R	L	T	R	L	T	R
Min. Green:	0	0	0	10	10	10	0	10	10	7	10	10
Y+R:	4.0	4.0	4.0	4.0	4.0	4.0	4.0	4.0	4.0	4.0	4.0	4.0
Volume Module: >> Count Date: 23 Sep 2014 <<												
Base Vol:	0	0	0	125	222	214	0	1322	313	220	714	0
Growth Adj:	1.00	1.00	1.00	1.00	1.00	1.00	1.00	1.00	1.00	1.00	1.00	1.00
Initial Bse:	0	0	0	125	222	214	0	1322	313	220	714	0
Added Vol:	0	0	0	0	0	0	0	0	0	0	0	0
PasserByVol:	0	0	0	0	0	0	0	0	0	0	0	0
Initial Fut:	0	0	0	125	222	214	0	1322	313	220	714	0
User Adj:	1.00	1.00	1.00	1.00	1.00	1.00	1.00	1.00	1.00	1.00	1.00	0.00
PHF Adj:	1.00	1.00	1.00	1.00	1.00	1.00	1.00	1.00	1.00	1.00	1.00	0.00
PHF Volume:	0	0	0	125	222	214	0	1322	313	220	714	0
Reduct Vol:	0	0	0	0	0	0	0	0	0	0	0	0
Reduced Vol:	0	0	0	125	222	214	0	1322	313	220	714	0
PCE Adj:	1.00	1.00	1.00	1.00	1.00	1.00	1.00	1.00	1.00	1.00	1.00	0.00
MLF Adj:	1.00	1.00	1.00	1.00	1.00	1.00	1.00	1.00	1.00	1.00	1.00	0.00
FinalVolume:	0	0	0	125	222	214	0	1322	313	220	714	0
Saturation Flow Module:												
Sat/Lane:	1900	1900	1900	1900	1900	1900	1900	1900	1900	1900	1900	1900
Adjustment:	0.92	1.00	0.92	0.92	1.00	0.92	0.92	1.00	0.92	0.92	1.00	0.83
Lanes:	0.00	0.00	0.00	1.00	1.00	1.00	0.00	3.00	1.00	1.00	2.00	2.00
Final Sat.:	0	0	0	1750	1900	1750	0	5700	1750	1750	3800	3150
Capacity Analysis Module:												
Vol/Sat:	0.00	0.00	0.00	0.07	0.12	0.12	0.00	0.23	0.18	0.13	0.19	0.00
Crit Moves:				****			****			****		
Green Time:	0.0	0.0	0.0	22.2	22.2	22.2	0.0	42.0	42.0	22.8	64.8	0.0
Volume/Cap:	0.00	0.00	0.00	0.31	0.51	0.53	0.00	0.53	0.41	0.53	0.28	0.00
Delay/Veh:	0.0	0.0	0.0	30.7	32.8	33.7	0.0	20.0	18.8	33.2	6.3	0.0
User DelAdj:	1.00	1.00	1.00	1.00	1.00	1.00	1.00	1.00	1.00	1.00	1.00	1.00
AdjDel/Veh:	0.0	0.0	0.0	30.7	32.8	33.7	0.0	20.0	18.8	33.2	6.3	0.0
LOS by Move:	A	A	A	C	C	C	A	B	B	C	A	A
HCM2k95thQ:	0	0	0	7	12	12	0	16	12	11	8	0

Note: Queue reported is the number of cars per lane.

BART Phase II Extension Project

Level Of Service Computation Report
2000 HCM Operations (Future Volume Alternative)
AM - 2035 Project Conditions

Intersection #3015: 87/SANTA CLARA

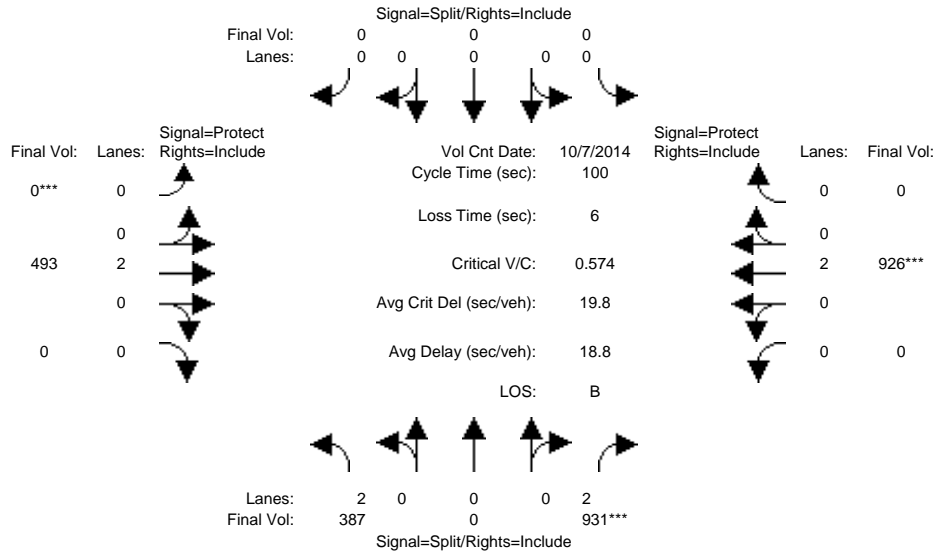

Approach:	North Bound			South Bound			East Bound			West Bound		
	L	T	R	L	T	R	L	T	R	L	T	R
Min. Green:	10	0	10	0	0	0	0	10	0	0	10	0
Y+R:	4.0	4.0	4.0	4.0	4.0	4.0	4.0	4.0	4.0	4.0	4.0	4.0

Volume Module:	>> Count Date: 7 Oct 2014 <<											
Base Vol:	387	0	931	0	0	0	0	493	0	0	926	0
Growth Adj:	1.00	1.00	1.00	1.00	1.00	1.00	1.00	1.00	1.00	1.00	1.00	1.00
Initial Bse:	387	0	931	0	0	0	0	493	0	0	926	0
Added Vol:	0	0	0	0	0	0	0	0	0	0	0	0
PasserByVol:	0	0	0	0	0	0	0	0	0	0	0	0
Initial Fut:	387	0	931	0	0	0	0	493	0	0	926	0
User Adj:	1.00	1.00	1.00	1.00	1.00	1.00	1.00	1.00	1.00	1.00	1.00	1.00
PHF Adj:	1.00	1.00	1.00	1.00	1.00	1.00	1.00	1.00	1.00	1.00	1.00	1.00
PHF Volume:	387	0	931	0	0	0	0	493	0	0	926	0
Reduct Vol:	0	0	0	0	0	0	0	0	0	0	0	0
Reduced Vol:	387	0	931	0	0	0	0	493	0	0	926	0
PCE Adj:	1.00	1.00	1.00	1.00	1.00	1.00	1.00	1.00	1.00	1.00	1.00	1.00
MLF Adj:	1.00	1.00	1.00	1.00	1.00	1.00	1.00	1.00	1.00	1.00	1.00	1.00
FinalVolume:	387	0	931	0	0	0	0	493	0	0	926	0

Saturation Flow Module:												
Sat/Lane:	1900	1900	1900	1900	1900	1900	1900	1900	1900	1900	1900	1900
Adjustment:	0.83	1.00	0.83	0.92	1.00	0.92	0.92	1.00	0.92	0.92	1.00	0.92
Lanes:	2.00	0.00	2.00	0.00	0.00	0.00	0.00	2.00	0.00	0.00	2.00	0.00
Final Sat.:	3150	0	3150	0	0	0	0	3800	0	0	3800	0

Capacity Analysis Module:												
Vol/Sat:	0.12	0.00	0.30	0.00	0.00	0.00	0.00	0.13	0.00	0.00	0.24	0.00
Crit Moves:			****					****			****	
Green Time:	51.5	0.0	51.5	0.0	0.0	0.0	0.0	42.5	0.0	0.0	42.5	0.0
Volume/Cap:	0.24	0.00	0.57	0.00	0.00	0.00	0.00	0.31	0.00	0.00	0.57	0.00
Delay/Veh:	13.5	0.0	17.2	0.0	0.0	0.0	0.0	19.1	0.0	0.0	22.4	0.0
User DelAdj:	1.00	1.00	1.00	1.00	1.00	1.00	1.00	1.00	1.00	1.00	1.00	1.00
AdjDel/Veh:	13.5	0.0	17.2	0.0	0.0	0.0	0.0	19.1	0.0	0.0	22.4	0.0
LOS by Move:	B	A	B	A	A	A	A	B	A	A	C	A
HCM2k95thQ:	8	0	22	0	0	0	0	9	0	0	19	0

Note: Queue reported is the number of cars per lane.

BART Phase II Extension Project

Level Of Service Computation Report
2000 HCM Operations (Future Volume Alternative)
PM - 2035 Project Conditions

Intersection #3015: 87/SANTA CLARA

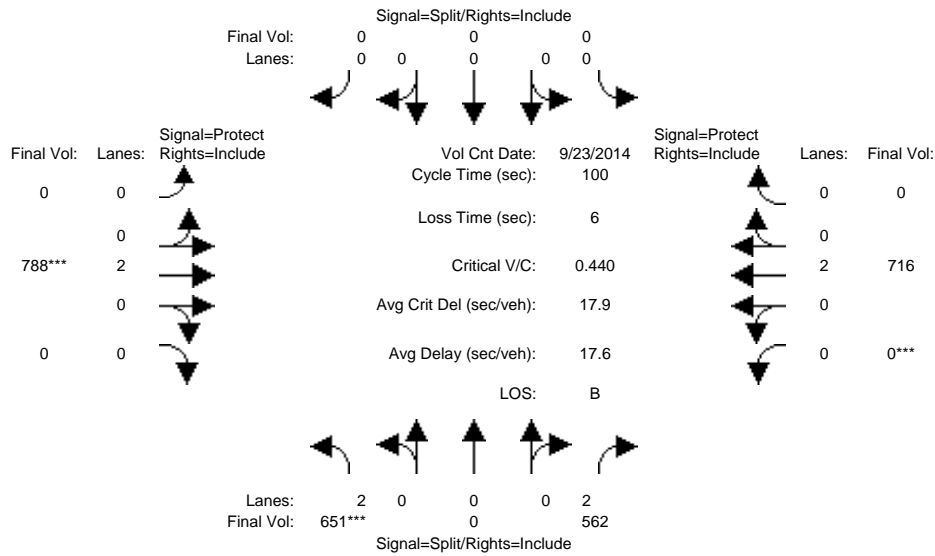

Approach:	North Bound			South Bound			East Bound			West Bound		
	L	T	R	L	T	R	L	T	R	L	T	R
Min. Green:	10	0	10	0	0	0	0	10	0	0	10	0
Y+R:	4.0	4.0	4.0	4.0	4.0	4.0	4.0	4.0	4.0	4.0	4.0	4.0

Volume Module:	>> Count Date: 23 Sep 2014 <<											
Base Vol:	651	0	562	0	0	0	0	788	0	0	716	0
Growth Adj:	1.00	1.00	1.00	1.00	1.00	1.00	1.00	1.00	1.00	1.00	1.00	1.00
Initial Bse:	651	0	562	0	0	0	0	788	0	0	716	0
Added Vol:	0	0	0	0	0	0	0	0	0	0	0	0
PasserByVol:	0	0	0	0	0	0	0	0	0	0	0	0
Initial Fut:	651	0	562	0	0	0	0	788	0	0	716	0
User Adj:	1.00	1.00	1.00	1.00	1.00	1.00	1.00	1.00	1.00	1.00	1.00	1.00
PHF Adj:	1.00	1.00	1.00	1.00	1.00	1.00	1.00	1.00	1.00	1.00	1.00	1.00
PHF Volume:	651	0	562	0	0	0	0	788	0	0	716	0
Reduct Vol:	0	0	0	0	0	0	0	0	0	0	0	0
Reduced Vol:	651	0	562	0	0	0	0	788	0	0	716	0
PCE Adj:	1.00	1.00	1.00	1.00	1.00	1.00	1.00	1.00	1.00	1.00	1.00	1.00
MLF Adj:	1.00	1.00	1.00	1.00	1.00	1.00	1.00	1.00	1.00	1.00	1.00	1.00
Final Volume:	651	0	562	0	0	0	0	788	0	0	716	0

Saturation Flow Module:												
Sat/Lane:	1900	1900	1900	1900	1900	1900	1900	1900	1900	1900	1900	1900
Adjustment:	0.83	1.00	0.83	0.92	1.00	0.92	0.92	1.00	0.92	0.92	1.00	0.92
Lanes:	2.00	0.00	2.00	0.00	0.00	0.00	0.00	2.00	0.00	0.00	2.00	0.00
Final Sat.:	3150	0	3150	0	0	0	0	3800	0	0	3800	0

Capacity Analysis Module:												
Vol/Sat:	0.21	0.00	0.18	0.00	0.00	0.00	0.00	0.21	0.00	0.00	0.19	0.00
Crit Moves:	****							****			****	
Green Time:	46.9	0.0	46.9	0.0	0.0	0.0	0.0	47.1	0.0	0.0	47.1	0.0
Volume/Cap:	0.44	0.00	0.38	0.00	0.00	0.00	0.00	0.44	0.00	0.00	0.40	0.00
Delay/Veh:	18.0	0.0	17.3	0.0	0.0	0.0	0.0	17.8	0.0	0.0	17.4	0.0
User DelAdj:	1.00	1.00	1.00	1.00	1.00	1.00	1.00	1.00	1.00	1.00	1.00	1.00
AdjDel/Veh:	18.0	0.0	17.3	0.0	0.0	0.0	0.0	17.8	0.0	0.0	17.4	0.0
LOS by Move:	B	A	B	A	A	A	A	B	A	A	B	A
HCM2k95thQ:	15	0	13	0	0	0	0	15	0	0	13	0

Note: Queue reported is the number of cars per lane.

BART Phase II Extension Project

Level Of Service Computation Report
2000 HCM Operations (Future Volume Alternative)
AM - 2035 Project Conditions

Intersection #3032: 280/BIRD (N)

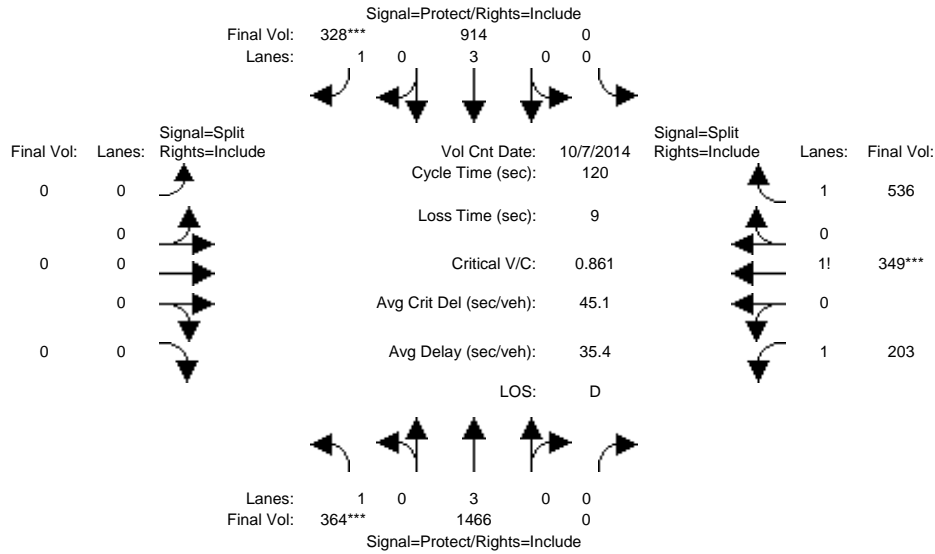

Approach:	North Bound			South Bound			East Bound			West Bound		
Movement:	L	T	R	L	T	R	L	T	R	L	T	R
Min. Green:	7	10	0	0	10	10	0	0	0	10	10	10
Y+R:	4.0	4.0	4.0	4.0	4.0	4.0	4.0	4.0	4.0	4.0	4.0	4.0
Volume Module: >> Count Date: 7 Oct 2014 <<												
Base Vol:	364	1466	0	0	914	328	0	0	0	203	349	536
Growth Adj:	1.00	1.00	1.00	1.00	1.00	1.00	1.00	1.00	1.00	1.00	1.00	1.00
Initial Bse:	364	1466	0	0	914	328	0	0	0	203	349	536
Added Vol:	0	0	0	0	0	0	0	0	0	0	0	0
PasserByVol:	0	0	0	0	0	0	0	0	0	0	0	0
Initial Fut:	364	1466	0	0	914	328	0	0	0	203	349	536
User Adj:	1.00	1.00	1.00	1.00	1.00	1.00	1.00	1.00	1.00	1.00	1.00	1.00
PHF Adj:	1.00	1.00	1.00	1.00	1.00	1.00	1.00	1.00	1.00	1.00	1.00	1.00
PHF Volume:	364	1466	0	0	914	328	0	0	0	203	349	536
Reduct Vol:	0	0	0	0	0	0	0	0	0	0	0	0
Reduced Vol:	364	1466	0	0	914	328	0	0	0	203	349	536
PCE Adj:	1.00	1.00	1.00	1.00	1.00	1.00	1.00	1.00	1.00	1.00	1.00	1.00
MLF Adj:	1.00	1.00	1.00	1.00	1.00	1.00	1.00	1.00	1.00	1.00	1.00	1.00
FinalVolume:	364	1466	0	0	914	328	0	0	0	203	349	536
Saturation Flow Module:												
Sat/Lane:	1900	1900	1900	1900	1900	1900	1900	1900	1900	1900	1900	1900
Adjustment:	0.92	1.00	0.92	0.92	1.00	0.92	0.92	1.00	0.92	0.92	0.95	0.95
Lanes:	1.00	3.00	0.00	0.00	3.00	1.00	0.00	0.00	0.00	1.14	0.48	1.38
Final Sat.:	1750	5700	0	0	5700	1750	0	0	0	2003	871	2469
Capacity Analysis Module:												
Vol/Sat:	0.21	0.26	0.00	0.00	0.16	0.19	0.00	0.00	0.00	0.10	0.40	0.22
Crit Moves:	****					****					****	
Green Time:	29.0	55.1	0.0	0.0	26.1	26.1	0.0	0.0	0.0	55.9	55.9	55.9
Volume/Cap:	0.86	0.56	0.00	0.00	0.74	0.86	0.00	0.00	0.00	0.22	0.86	0.47
Delay/Veh:	59.8	23.9	0.0	0.0	46.1	62.9	0.0	0.0	0.0	19.1	34.8	22.0
User DelAdj:	1.00	1.00	1.00	1.00	1.00	1.00	1.00	1.00	1.00	1.00	1.00	1.00
AdjDel/Veh:	59.8	23.9	0.0	0.0	46.1	62.9	0.0	0.0	0.0	19.1	34.8	22.0
LOS by Move:	E	C	A	A	D	E	A	A	A	B	C	C
HCM2k95thQ:	29	23	0	0	19	23	0	0	0	8	45	19

Note: Queue reported is the number of cars per lane.

BART Phase II Extension Project

Level Of Service Computation Report
2000 HCM Operations (Future Volume Alternative)
PM - 2035 Project Conditions

Intersection #3032: 280/BIRD (N)

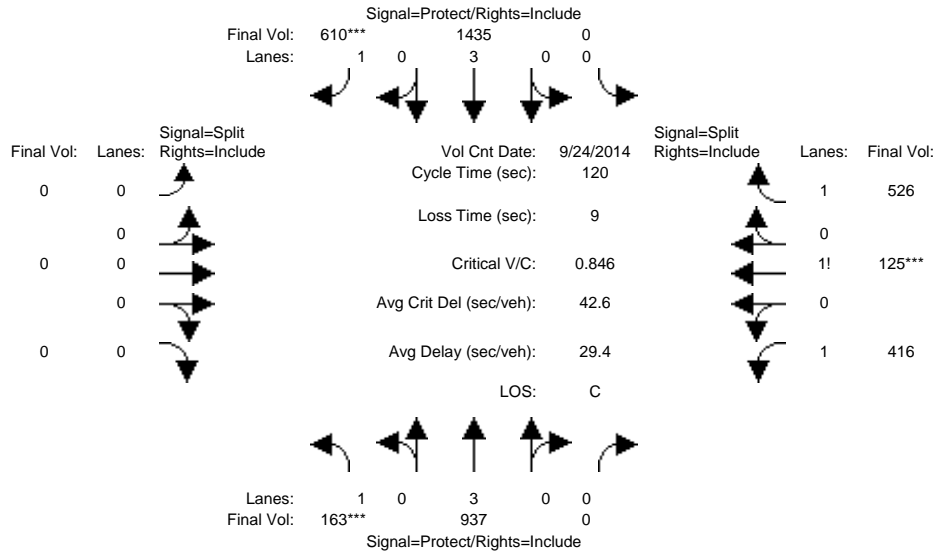

Approach:	North Bound			South Bound			East Bound			West Bound		
	L	T	R	L	T	R	L	T	R	L	T	R
Min. Green:	7	10	0	0	10	10	0	0	0	10	10	10
Y+R:	4.0	4.0	4.0	4.0	4.0	4.0	4.0	4.0	4.0	4.0	4.0	4.0

Volume Module:	>>	Count	Date:	24 Sep 2014	<<							
Base Vol:	163	937	0	0	1435	610	0	0	0	416	125	526
Growth Adj:	1.00	1.00	1.00	1.00	1.00	1.00	1.00	1.00	1.00	1.00	1.00	1.00
Initial Bse:	163	937	0	0	1435	610	0	0	0	416	125	526
Added Vol:	0	0	0	0	0	0	0	0	0	0	0	0
PasserByVol:	0	0	0	0	0	0	0	0	0	0	0	0
Initial Fut:	163	937	0	0	1435	610	0	0	0	416	125	526
User Adj:	1.00	1.00	1.00	1.00	1.00	1.00	1.00	1.00	1.00	1.00	1.00	1.00
PHF Adj:	1.00	1.00	1.00	1.00	1.00	1.00	1.00	1.00	1.00	1.00	1.00	1.00
PHF Volume:	163	937	0	0	1435	610	0	0	0	416	125	526
Reduct Vol:	0	0	0	0	0	0	0	0	0	0	0	0
Reduced Vol:	163	937	0	0	1435	610	0	0	0	416	125	526
PCE Adj:	1.00	1.00	1.00	1.00	1.00	1.00	1.00	1.00	1.00	1.00	1.00	1.00
MLF Adj:	1.00	1.00	1.00	1.00	1.00	1.00	1.00	1.00	1.00	1.00	1.00	1.00
FinalVolume:	163	937	0	0	1435	610	0	0	0	416	125	526

Saturation Flow Module:	North Bound			South Bound			East Bound			West Bound		
Sat/Lane:	1900	1900	1900	1900	1900	1900	1900	1900	1900	1900	1900	1900
Adjustment:	0.92	1.00	0.92	0.92	1.00	0.92	0.92	1.00	0.92	0.92	0.92	0.92
Lanes:	1.00	3.00	0.00	0.00	3.00	1.00	0.00	0.00	0.00	1.35	0.21	1.44
Final Sat.:	1750	5700	0	0	5700	1750	0	0	0	2361	367	2522

Capacity Analysis Module:	North Bound			South Bound			East Bound			West Bound		
Vol/Sat:	0.09	0.16	0.00	0.00	0.25	0.35	0.00	0.00	0.00	0.18	0.34	0.21
Crit Moves:	****					****					****	
Green Time:	13.2	62.7	0.0	0.0	49.5	49.5	0.0	0.0	0.0	48.3	48.3	48.3
Volume/Cap:	0.85	0.31	0.00	0.00	0.61	0.85	0.00	0.00	0.00	0.44	0.85	0.52
Delay/Veh:	80.0	16.4	0.0	0.0	28.2	40.9	0.0	0.0	0.0	26.1	37.9	27.3
User DelAdj:	1.00	1.00	1.00	1.00	1.00	1.00	1.00	1.00	1.00	1.00	1.00	1.00
AdjDel/Veh:	80.0	16.4	0.0	0.0	28.2	40.9	0.0	0.0	0.0	26.1	37.9	27.3
LOS by Move:	E	B	A	A	C	D	A	A	A	C	D	C
HCM2k95thQ:	17	12	0	0	24	37	0	0	0	17	39	20

Note: Queue reported is the number of cars per lane.

BART Phase II Extension Project

Level Of Service Computation Report
2000 HCM Operations (Future Volume Alternative)
AM - 2035 Project Conditions

Intersection #3033: 280/BIRD (S)

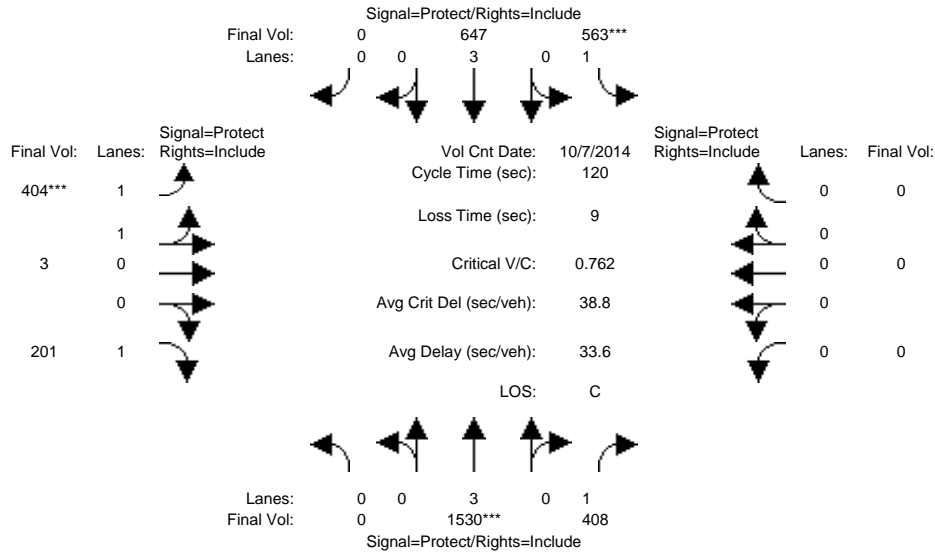

Approach:	North Bound			South Bound			East Bound			West Bound		
	L	T	R	L	T	R	L	T	R	L	T	R
Min. Green:	0	10	10	7	10	0	10	10	10	0	0	0
Y+R:	4.0	4.0	4.0	4.0	4.0	4.0	4.0	4.0	4.0	4.0	4.0	4.0
Volume Module: >> Count Date: 7 Oct 2014 <<												
Base Vol:	0	1530	408	563	647	0	404	3	201	0	0	0
Growth Adj:	1.00	1.00	1.00	1.00	1.00	1.00	1.00	1.00	1.00	1.00	1.00	1.00
Initial Bse:	0	1530	408	563	647	0	404	3	201	0	0	0
Added Vol:	0	0	0	0	0	0	0	0	0	0	0	0
PasserByVol:	0	0	0	0	0	0	0	0	0	0	0	0
Initial Fut:	0	1530	408	563	647	0	404	3	201	0	0	0
User Adj:	1.00	1.00	1.00	1.00	1.00	1.00	1.00	1.00	1.00	1.00	1.00	1.00
PHF Adj:	1.00	1.00	1.00	1.00	1.00	1.00	1.00	1.00	1.00	1.00	1.00	1.00
PHF Volume:	0	1530	408	563	647	0	404	3	201	0	0	0
Reduct Vol:	0	0	0	0	0	0	0	0	0	0	0	0
Reduced Vol:	0	1530	408	563	647	0	404	3	201	0	0	0
PCE Adj:	1.00	1.00	1.00	1.00	1.00	1.00	1.00	1.00	1.00	1.00	1.00	1.00
MLF Adj:	1.00	1.00	1.00	1.00	1.00	1.00	1.00	1.00	1.00	1.00	1.00	1.00
FinalVolume:	0	1530	408	563	647	0	404	3	201	0	0	0
Saturation Flow Module:												
Sat/Lane:	1900	1900	1900	1900	1900	1900	1900	1900	1900	1900	1900	1900
Adjustment:	0.92	1.00	0.92	0.92	1.00	0.92	0.93	0.95	0.92	0.92	1.00	0.92
Lanes:	0.00	3.00	1.00	1.00	3.00	0.00	1.99	0.01	1.00	0.00	0.00	0.00
Final Sat.:	0	5700	1750	1750	5700	0	3524	26	1750	0	0	0
Capacity Analysis Module:												
Vol/Sat:	0.00	0.27	0.23	0.32	0.11	0.00	0.11	0.11	0.11	0.00	0.00	0.00
Crit Moves:	****			****			****					
Green Time:	0.0	42.3	42.3	50.7	92.9	0.0	18.1	18.1	18.1	0.0	0.0	0.0
Volume/Cap:	0.00	0.76	0.66	0.76	0.15	0.00	0.76	0.76	0.76	0.00	0.00	0.00
Delay/Veh:	0.0	36.2	35.5	34.2	3.5	0.0	55.3	55.3	61.3	0.0	0.0	0.0
User DelAdj:	1.00	1.00	1.00	1.00	1.00	1.00	1.00	1.00	1.00	1.00	1.00	1.00
AdjDel/Veh:	0.0	36.2	35.5	34.2	3.5	0.0	55.3	55.3	61.3	0.0	0.0	0.0
LOS by Move:	A	D	D	C	A	A	E	E	E	A	A	A
HCM2k95thQ:	0	29	24	34	4	0	18	18	18	0	0	0

Note: Queue reported is the number of cars per lane.

BART Phase II Extension Project

Level Of Service Computation Report
2000 HCM Operations (Future Volume Alternative)
PM - 2035 Project Conditions

Intersection #3033: 280/BIRD (S)

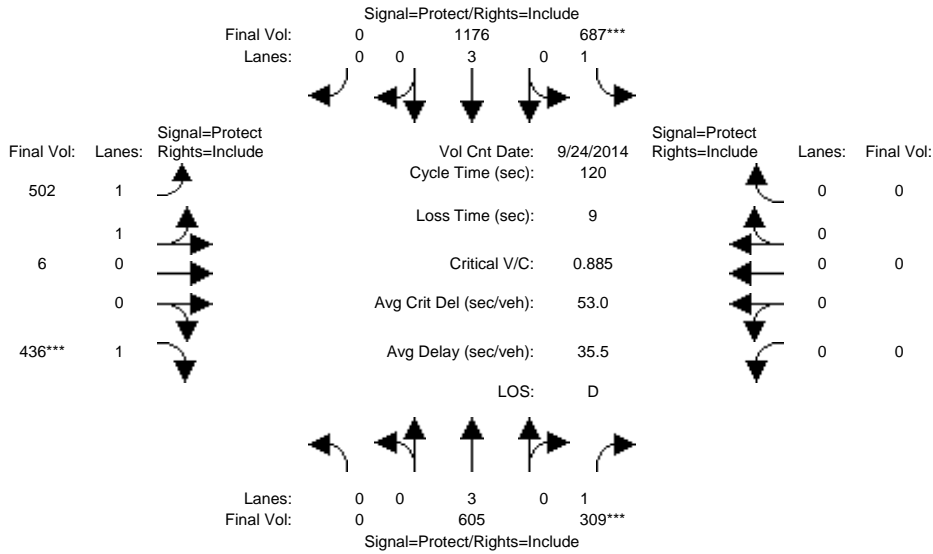

Approach:	North Bound			South Bound			East Bound			West Bound		
	L	T	R	L	T	R	L	T	R	L	T	R
Min. Green:	0	10	10	7	10	0	10	10	10	0	0	0
Y+R:	4.0	4.0	4.0	4.0	4.0	4.0	4.0	4.0	4.0	4.0	4.0	4.0

Volume Module:	>>	Count	Date:	24 Sep 2014	<<							
Base Vol:	0	605	309	687	1176	0	502	6	436	0	0	0
Growth Adj:	1.00	1.00	1.00	1.00	1.00	1.00	1.00	1.00	1.00	1.00	1.00	1.00
Initial Bse:	0	605	309	687	1176	0	502	6	436	0	0	0
Added Vol:	0	0	0	0	0	0	0	0	0	0	0	0
PasserByVol:	0	0	0	0	0	0	0	0	0	0	0	0
Initial Fut:	0	605	309	687	1176	0	502	6	436	0	0	0
User Adj:	1.00	1.00	1.00	1.00	1.00	1.00	1.00	1.00	1.00	1.00	1.00	1.00
PHF Adj:	1.00	1.00	1.00	1.00	1.00	1.00	1.00	1.00	1.00	1.00	1.00	1.00
PHF Volume:	0	605	309	687	1176	0	502	6	436	0	0	0
Reduct Vol:	0	0	0	0	0	0	0	0	0	0	0	0
Reduced Vol:	0	605	309	687	1176	0	502	6	436	0	0	0
PCE Adj:	1.00	1.00	1.00	1.00	1.00	1.00	1.00	1.00	1.00	1.00	1.00	1.00
MLF Adj:	1.00	1.00	1.00	1.00	1.00	1.00	1.00	1.00	1.00	1.00	1.00	1.00
Final Volume:	0	605	309	687	1176	0	502	6	436	0	0	0

Saturation Flow Module:												
Sat/Lane:	1900	1900	1900	1900	1900	1900	1900	1900	1900	1900	1900	1900
Adjustment:	0.92	1.00	0.92	0.92	1.00	0.92	0.93	0.95	0.92	0.92	1.00	0.92
Lanes:	0.00	3.00	1.00	1.00	3.00	0.00	1.98	0.02	1.00	0.00	0.00	0.00
Final Sat.:	0	5700	1750	1750	5700	0	3508	42	1750	0	0	0

Capacity Analysis Module:												
Vol/Sat:	0.00	0.11	0.18	0.39	0.21	0.00	0.14	0.14	0.25	0.00	0.00	0.00
Crit Moves:			****	****					****			
Green Time:	0.0	24.0	24.0	53.3	77.2	0.0	33.8	33.8	33.8	0.0	0.0	0.0
Volume/Cap:	0.00	0.53	0.88	0.88	0.32	0.00	0.51	0.51	0.88	0.00	0.00	0.00
Delay/Veh:	0.0	43.5	69.2	42.4	9.7	0.0	36.6	36.6	58.4	0.0	0.0	0.0
User DelAdj:	1.00	1.00	1.00	1.00	1.00	1.00	1.00	1.00	1.00	1.00	1.00	1.00
AdjDel/Veh:	0.0	43.5	69.2	42.4	9.7	0.0	36.6	36.6	58.4	0.0	0.0	0.0
LOS by Move:	A	D	E	D	A	A	D	D	E	A	A	A
HCM2k95thQ:	0	13	24	46	12	0	16	16	34	0	0	0

Note: Queue reported is the number of cars per lane.

BART Phase II Extension Project

Level Of Service Computation Report
 2000 HCM Operations (Future Volume Alternative)
 AM - 2035 Project Conditions

Intersection #3058: ALAMEDA/NAGLEE

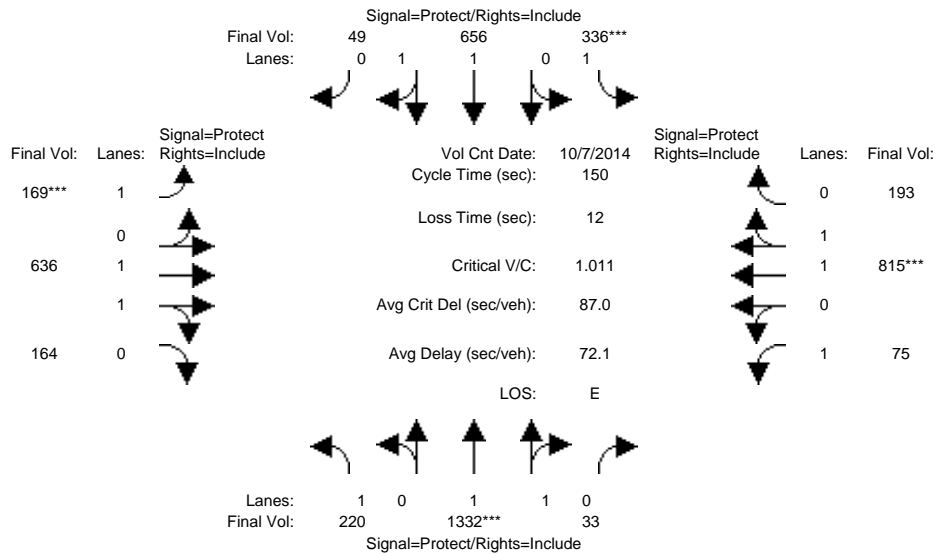

Approach:	North Bound			South Bound			East Bound			West Bound		
Movement:	L	T	R	L	T	R	L	T	R	L	T	R
Min. Green:	7	10	10	7	10	10	7	10	10	7	10	10
Y+R:	4.0	4.0	4.0	4.0	4.0	4.0	4.0	4.0	4.0	4.0	4.0	4.0
Volume Module: >> Count Date: 7 Oct 2014 <<												
Base Vol:	220	1332	33	336	656	49	169	636	164	75	815	193
Growth Adj:	1.00	1.00	1.00	1.00	1.00	1.00	1.00	1.00	1.00	1.00	1.00	1.00
Initial Bse:	220	1332	33	336	656	49	169	636	164	75	815	193
Added Vol:	0	0	0	0	0	0	0	0	0	0	0	0
PasserByVol:	0	0	0	0	0	0	0	0	0	0	0	0
Initial Fut:	220	1332	33	336	656	49	169	636	164	75	815	193
User Adj:	1.00	1.00	1.00	1.00	1.00	1.00	1.00	1.00	1.00	1.00	1.00	1.00
PHF Adj:	1.00	1.00	1.00	1.00	1.00	1.00	1.00	1.00	1.00	1.00	1.00	1.00
PHF Volume:	220	1332	33	336	656	49	169	636	164	75	815	193
Reduct Vol:	0	0	0	0	0	0	0	0	0	0	0	0
Reduced Vol:	220	1332	33	336	656	49	169	636	164	75	815	193
PCE Adj:	1.00	1.00	1.00	1.00	1.00	1.00	1.00	1.00	1.00	1.00	1.00	1.00
MLF Adj:	1.00	1.00	1.00	1.00	1.00	1.00	1.00	1.00	1.00	1.00	1.00	1.00
FinalVolume:	220	1332	33	336	656	49	169	636	164	75	815	193
Saturation Flow Module:												
Sat/Lane:	1900	1900	1900	1900	1900	1900	1900	1900	1900	1900	1900	1900
Adjustment:	0.92	0.97	0.95	0.92	0.98	0.95	0.92	0.98	0.95	0.92	0.98	0.95
Lanes:	1.00	1.95	0.05	1.00	1.86	0.14	1.00	1.58	0.42	1.00	1.61	0.39
Final Sat.:	1750	3610	89	1750	3443	257	1750	2941	758	1750	2991	708
Capacity Analysis Module:												
Vol/Sat:	0.13	0.37	0.37	0.19	0.19	0.19	0.10	0.22	0.22	0.04	0.27	0.27
Crit Moves:	****			****			****			****		
Green Time:	33.1	54.7	54.7	28.5	50.2	50.2	14.3	45.0	45.0	9.7	40.4	40.4
Volume/Cap:	0.57	1.01	1.01	1.01	0.57	0.57	1.01	0.72	0.72	0.66	1.01	1.01
Delay/Veh:	54.1	74.8	74.8	112.9	41.7	41.7	140.3	49.2	49.2	82.1	86.0	86.0
User DelAdj:	1.00	1.00	1.00	1.00	1.00	1.00	1.00	1.00	1.00	1.00	1.00	1.00
AdjDel/Veh:	54.1	74.8	74.8	112.9	41.7	41.7	140.3	49.2	49.2	82.1	86.0	86.0
LOS by Move:	D	E	E	F	D	D	F	D	D	F	F	F
HCM2k95thQ:	19	61	61	34	24	24	23	30	30	8	46	46

Note: Queue reported is the number of cars per lane.

BART Phase II Extension Project

Level Of Service Computation Report
2000 HCM Operations (Future Volume Alternative)
PM - 2035 Project Conditions

Intersection #3058: ALAMEDA/NAGLEE

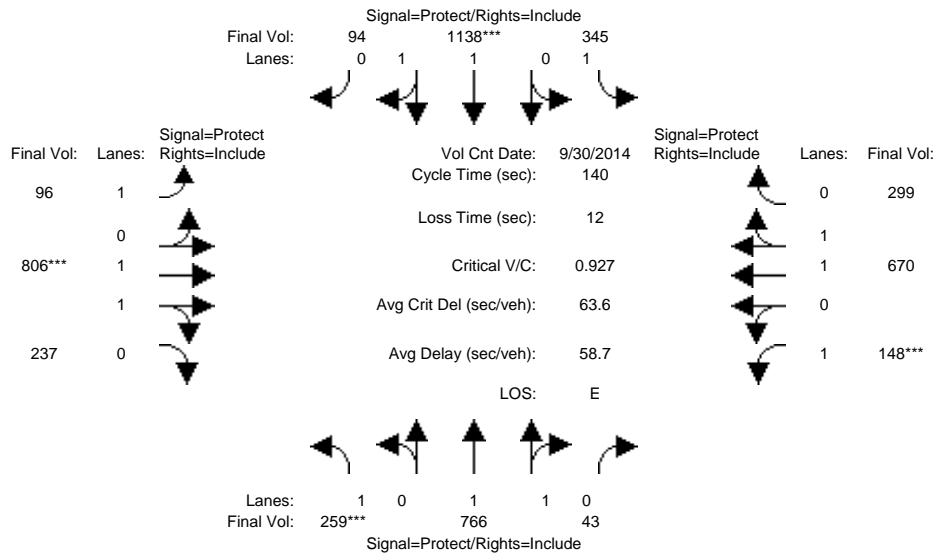

Approach:	North Bound			South Bound			East Bound			West Bound		
	L	T	R	L	T	R	L	T	R	L	T	R
Min. Green:	7	10	10	7	10	10	7	10	10	7	10	10
Y+R:	4.0	4.0	4.0	4.0	4.0	4.0	4.0	4.0	4.0	4.0	4.0	4.0

Volume Module:	>> Count Date: 30 Sep 2014 <<											
Base Vol:	259	766	43	345	1138	94	96	806	237	148	670	299
Growth Adj:	1.00	1.00	1.00	1.00	1.00	1.00	1.00	1.00	1.00	1.00	1.00	1.00
Initial Bse:	259	766	43	345	1138	94	96	806	237	148	670	299
Added Vol:	0	0	0	0	0	0	0	0	0	0	0	0
PasserByVol:	0	0	0	0	0	0	0	0	0	0	0	0
Initial Fut:	259	766	43	345	1138	94	96	806	237	148	670	299
User Adj:	1.00	1.00	1.00	1.00	1.00	1.00	1.00	1.00	1.00	1.00	1.00	1.00
PHF Adj:	1.00	1.00	1.00	1.00	1.00	1.00	1.00	1.00	1.00	1.00	1.00	1.00
PHF Volume:	259	766	43	345	1138	94	96	806	237	148	670	299
Reduct Vol:	0	0	0	0	0	0	0	0	0	0	0	0
Reduced Vol:	259	766	43	345	1138	94	96	806	237	148	670	299
PCE Adj:	1.00	1.00	1.00	1.00	1.00	1.00	1.00	1.00	1.00	1.00	1.00	1.00
MLF Adj:	1.00	1.00	1.00	1.00	1.00	1.00	1.00	1.00	1.00	1.00	1.00	1.00
FinalVolume:	259	766	43	345	1138	94	96	806	237	148	670	299

Saturation Flow Module:												
Sat/Lane:	1900	1900	1900	1900	1900	1900	1900	1900	1900	1900	1900	1900
Adjustment:	0.92	0.98	0.95	0.92	0.98	0.95	0.92	0.98	0.95	0.92	0.99	0.95
Lanes:	1.00	1.89	0.11	1.00	1.84	0.16	1.00	1.53	0.47	1.00	1.37	0.63
Final Sat.:	1750	3503	197	1750	3417	282	1750	2859	841	1750	2557	1141

Capacity Analysis Module:												
Vol/Sat:	0.15	0.22	0.22	0.20	0.33	0.33	0.05	0.28	0.28	0.08	0.26	0.26
Crit Moves:	****			****			****			****		
Green Time:	22.4	38.2	38.2	34.4	50.3	50.3	9.6	42.6	42.6	12.8	45.8	45.8
Volume/Cap:	0.93	0.80	0.80	0.80	0.93	0.93	0.80	0.93	0.93	0.93	0.80	0.80
Delay/Veh:	93.0	52.0	52.0	59.9	54.4	54.4	95.0	60.1	60.1	113.2	46.9	46.9
User DelAdj:	1.00	1.00	1.00	1.00	1.00	1.00	1.00	1.00	1.00	1.00	1.00	1.00
AdjDel/Veh:	93.0	52.0	52.0	59.9	54.4	54.4	95.0	60.1	60.1	113.2	46.9	46.9
LOS by Move:	F	D	D	E	D	D	F	E	E	F	D	D
HCM2k95thQ:	27	31	31	27	46	46	12	43	43	15	34	34

Note: Queue reported is the number of cars per lane.

BART Phase II Extension Project

Level Of Service Computation Report
2000 HCM Operations (Future Volume Alternative)
AM - 2035 Project Conditions

Intersection #3059: ALAMEDA/RACE *

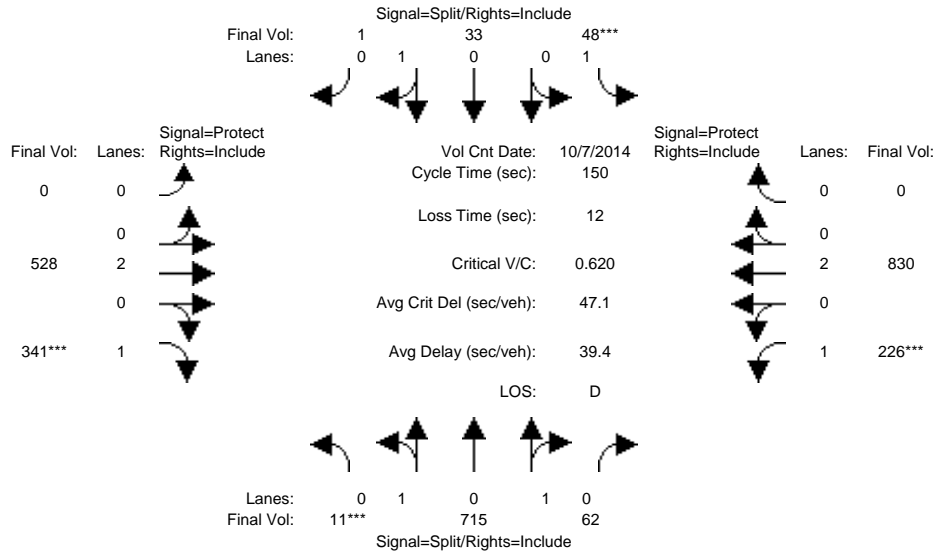

Approach:	North Bound			South Bound			East Bound			West Bound		
	L	T	R	L	T	R	L	T	R	L	T	R
Min. Green:	10	10	10	10	10	10	0	10	10	7	10	0
Y+R:	4.0	4.0	4.0	4.0	4.0	4.0	4.0	4.0	4.0	4.0	4.0	4.0

Volume Module: >> Count Date: 7 Oct 2014 <<

Base Vol:	11	715	62	48	33	1	0	528	341	226	830	0
Growth Adj:	1.00	1.00	1.00	1.00	1.00	1.00	1.00	1.00	1.00	1.00	1.00	1.00
Initial Bse:	11	715	62	48	33	1	0	528	341	226	830	0
Added Vol:	0	0	0	0	0	0	0	0	0	0	0	0
PasserByVol:	0	0	0	0	0	0	0	0	0	0	0	0
Initial Fut:	11	715	62	48	33	1	0	528	341	226	830	0
User Adj:	1.00	1.00	1.00	1.00	1.00	1.00	1.00	1.00	1.00	1.00	1.00	1.00
PHF Adj:	1.00	1.00	1.00	1.00	1.00	1.00	1.00	1.00	1.00	1.00	1.00	1.00
PHF Volume:	11	715	62	48	33	1	0	528	341	226	830	0
Reduct Vol:	0	0	0	0	0	0	0	0	0	0	0	0
Reduced Vol:	11	715	62	48	33	1	0	528	341	226	830	0
PCE Adj:	1.00	1.00	1.00	1.00	1.00	1.00	1.00	1.00	1.00	1.00	1.00	1.00
MLF Adj:	1.00	1.00	1.00	1.00	1.00	1.00	1.00	1.00	1.00	1.00	1.00	1.00
FinalVolume:	11	715	62	48	33	1	0	528	341	226	830	0

Saturation Flow Module:

Sat/Lane:	1900	1900	1900	1900	1900	1900	1900	1900	1900	1900	1900	1900
Adjustment:	0.95	0.95	0.95	0.92	0.95	0.95	0.92	1.00	0.92	0.92	1.00	0.92
Lanes:	0.03	1.81	0.16	1.00	0.97	0.03	0.00	2.00	1.00	1.00	2.00	0.00
Final Sat.:	50	3266	283	1750	1747	53	0	3800	1750	1750	3800	0

Capacity Analysis Module:

Vol/Sat:	0.22	0.22	0.22	0.03	0.02	0.02	0.00	0.14	0.19	0.13	0.22	0.00
Crit Moves:	****			****					****	****		
Green Time:	51.6	51.6	51.6	10.0	10.0	10.0	0.0	45.9	45.9	30.4	76.4	0.0
Volume/Cap:	0.64	0.64	0.64	0.41	0.28	0.28	0.00	0.45	0.64	0.64	0.43	0.00
Delay/Veh:	42.4	42.4	42.4	69.5	67.9	67.9	0.0	42.2	47.4	58.5	23.3	0.0
User DelAdj:	1.00	1.00	1.00	1.00	1.00	1.00	1.00	1.00	1.00	1.00	1.00	1.00
AdjDel/Veh:	42.4	42.4	42.4	69.5	67.9	67.9	0.0	42.2	47.4	58.5	23.3	0.0
LOS by Move:	D	D	D	E	E	E	A	D	D	E	C	A
HCM2k95thQ:	28	28	28	6	4	4	0	17	26	19	21	0

Note: Queue reported is the number of cars per lane.

BART Phase II Extension Project

Level Of Service Computation Report
2000 HCM Operations (Future Volume Alternative)
PM - 2035 Project Conditions

Intersection #3059: ALAMEDA/RACE *

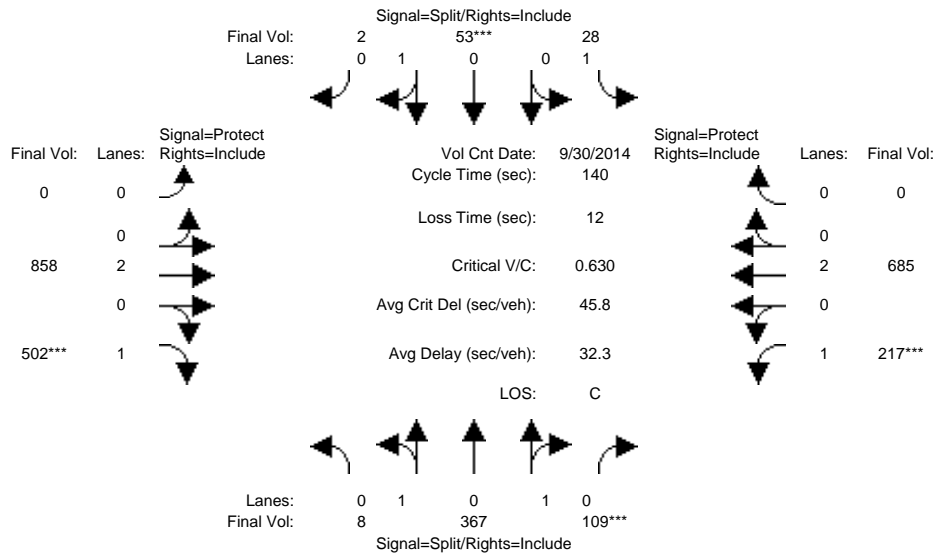

Approach:	North Bound			South Bound			East Bound			West Bound		
	L	T	R	L	T	R	L	T	R	L	T	R
Min. Green:	10	10	10	10	10	10	0	10	10	7	10	0
Y+R:	4.0	4.0	4.0	4.0	4.0	4.0	4.0	4.0	4.0	4.0	4.0	4.0

Volume Module: >> Count Date: 30 Sep 2014 <<

Base Vol:	8	367	109	28	53	2	0	858	502	217	685	0
Growth Adj:	1.00	1.00	1.00	1.00	1.00	1.00	1.00	1.00	1.00	1.00	1.00	1.00
Initial Bse:	8	367	109	28	53	2	0	858	502	217	685	0
Added Vol:	0	0	0	0	0	0	0	0	0	0	0	0
PasserByVol:	0	0	0	0	0	0	0	0	0	0	0	0
Initial Fut:	8	367	109	28	53	2	0	858	502	217	685	0
User Adj:	1.00	1.00	1.00	1.00	1.00	1.00	1.00	1.00	1.00	1.00	1.00	1.00
PHF Adj:	1.00	1.00	1.00	1.00	1.00	1.00	1.00	1.00	1.00	1.00	1.00	1.00
PHF Volume:	8	367	109	28	53	2	0	858	502	217	685	0
Reduct Vol:	0	0	0	0	0	0	0	0	0	0	0	0
Reduced Vol:	8	367	109	28	53	2	0	858	502	217	685	0
PCE Adj:	1.00	1.00	1.00	1.00	1.00	1.00	1.00	1.00	1.00	1.00	1.00	1.00
MLF Adj:	1.00	1.00	1.00	1.00	1.00	1.00	1.00	1.00	1.00	1.00	1.00	1.00
FinalVolume:	8	367	109	28	53	2	0	858	502	217	685	0

Saturation Flow Module:

Sat/Lane:	1900	1900	1900	1900	1900	1900	1900	1900	1900	1900	1900	1900
Adjustment:	0.95	0.95	0.95	0.92	0.95	0.95	0.92	1.00	0.92	0.92	1.00	0.92
Lanes:	0.03	1.52	0.45	1.00	0.96	0.04	0.00	2.00	1.00	1.00	2.00	0.00
Final Sat.:	60	2730	811	1750	1735	65	0	3800	1750	1750	3800	0

Capacity Analysis Module:

Vol/Sat:	0.13	0.13	0.13	0.02	0.03	0.03	0.00	0.23	0.29	0.12	0.18	0.00
Crit Moves:			****		****				****	****		
Green Time:	29.1	29.1	29.1	10.0	10.0	10.0	0.0	62.1	62.1	26.8	88.9	0.0
Volume/Cap:	0.65	0.65	0.65	0.22	0.43	0.43	0.00	0.51	0.65	0.65	0.28	0.00
Delay/Veh:	52.7	52.7	52.7	62.3	64.5	64.5	0.0	28.3	32.3	56.6	11.4	0.0
User DelAdj:	1.00	1.00	1.00	1.00	1.00	1.00	1.00	1.00	1.00	1.00	1.00	1.00
AdjDel/Veh:	52.7	52.7	52.7	62.3	64.5	64.5	0.0	28.3	32.3	56.6	11.4	0.0
LOS by Move:	D	D	D	E	E	E	A	C	C	E	B	A
HCM2k95thQ:	18	18	18	3	6	6	0	23	31	17	12	0

Note: Queue reported is the number of cars per lane.

BART Phase II Extension Project

Level Of Service Computation Report
2000 HCM Operations (Future Volume Alternative)
AM - 2035 Project Conditions

Intersection #3066: AUTUMN/SANTA CLARA

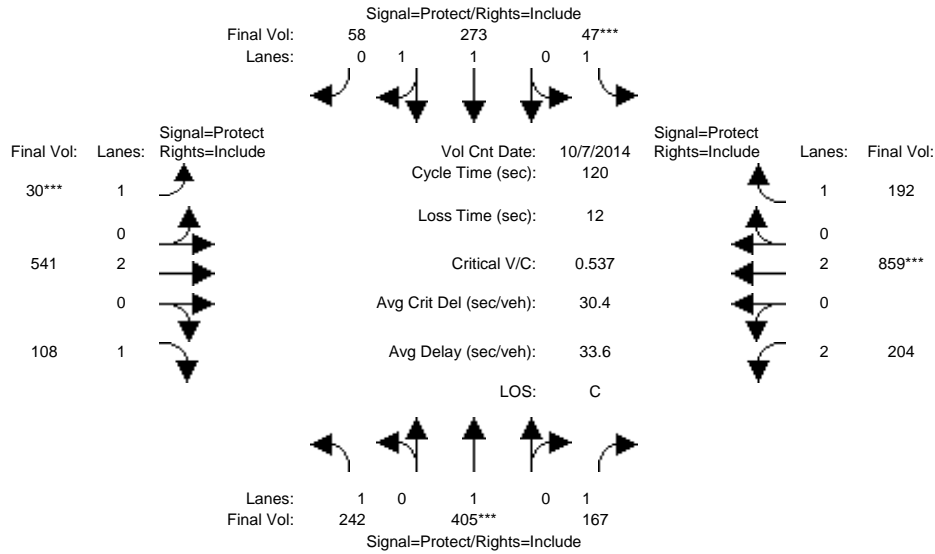

Approach:	North Bound			South Bound			East Bound			West Bound		
	L	T	R	L	T	R	L	T	R	L	T	R
Min. Green:	7	10	10	7	10	10	7	10	10	7	10	10
Y+R:	4.0	4.0	4.0	4.0	4.0	4.0	4.0	4.0	4.0	4.0	4.0	4.0

Volume Module:	>> Count Date: 7 Oct 2014 <<											
Base Vol:	242	405	167	47	273	58	30	541	108	204	859	192
Growth Adj:	1.00	1.00	1.00	1.00	1.00	1.00	1.00	1.00	1.00	1.00	1.00	1.00
Initial Bse:	242	405	167	47	273	58	30	541	108	204	859	192
Added Vol:	0	0	0	0	0	0	0	0	0	0	0	0
PasserByVol:	0	0	0	0	0	0	0	0	0	0	0	0
Initial Fut:	242	405	167	47	273	58	30	541	108	204	859	192
User Adj:	1.00	1.00	1.00	1.00	1.00	1.00	1.00	1.00	1.00	1.00	1.00	1.00
PHF Adj:	1.00	1.00	1.00	1.00	1.00	1.00	1.00	1.00	1.00	1.00	1.00	1.00
PHF Volume:	242	405	167	47	273	58	30	541	108	204	859	192
Reduct Vol:	0	0	0	0	0	0	0	0	0	0	0	0
Reduced Vol:	242	405	167	47	273	58	30	541	108	204	859	192
PCE Adj:	1.00	1.00	1.00	1.00	1.00	1.00	1.00	1.00	1.00	1.00	1.00	1.00
MLF Adj:	1.00	1.00	1.00	1.00	1.00	1.00	1.00	1.00	1.00	1.00	1.00	1.00
FinalVolume:	242	405	167	47	273	58	30	541	108	204	859	192

Saturation Flow Module:												
Sat/Lane:	1900	1900	1900	1900	1900	1900	1900	1900	1900	1900	1900	1900
Adjustment:	0.92	1.00	0.92	0.92	0.98	0.95	0.92	1.00	0.92	0.83	1.00	0.92
Lanes:	1.00	1.00	1.00	1.00	1.64	0.36	1.00	2.00	1.00	2.00	2.00	1.00
Final Sat.:	1750	1900	1750	1750	3051	648	1750	3800	1750	3150	3800	1750

Capacity Analysis Module:												
Vol/Sat:	0.14	0.21	0.10	0.03	0.09	0.09	0.02	0.14	0.06	0.06	0.23	0.11
Crit Moves:	****	****	****	****	****	****	****	****	****	****	****	****
Green Time:	31.9	45.6	45.6	7.0	20.7	20.7	7.0	38.1	38.1	17.3	48.4	48.4
Volume/Cap:	0.52	0.56	0.25	0.46	0.52	0.52	0.29	0.45	0.19	0.45	0.56	0.27
Delay/Veh:	38.5	30.3	25.7	57.9	45.9	45.9	55.7	32.9	30.0	47.7	28.1	24.2
User DelAdj:	1.00	1.00	1.00	1.00	1.00	1.00	1.00	1.00	1.00	1.00	1.00	1.00
AdjDel/Veh:	38.5	30.3	25.7	57.9	45.9	45.9	55.7	32.9	30.0	47.7	28.1	24.2
LOS by Move:	D	C	C	E	D	D	E	C	C	D	C	C
HCM2k95thQ:	15	21	9	4	11	11	2	15	6	8	22	10

Note: Queue reported is the number of cars per lane.

BART Phase II Extension Project

Level Of Service Computation Report
2000 HCM Operations (Future Volume Alternative)
PM - 2035 Project Conditions

Intersection #3066: AUTUMN/SANTA CLARA

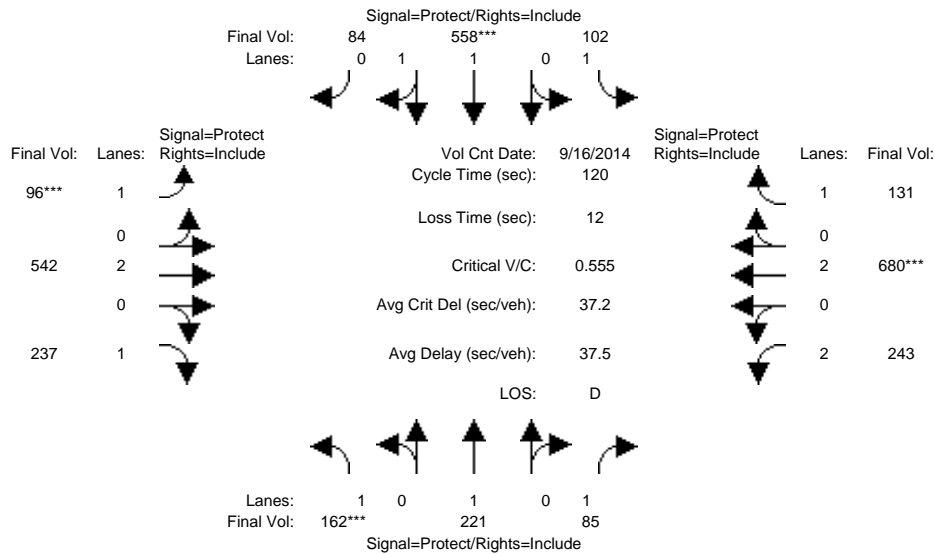

Approach:	North Bound			South Bound			East Bound			West Bound		
	L	T	R	L	T	R	L	T	R	L	T	R
Min. Green:	7	10	10	7	10	10	7	10	10	7	10	10
Y+R:	4.0	4.0	4.0	4.0	4.0	4.0	4.0	4.0	4.0	4.0	4.0	4.0
Volume Module: >> Count Date: 16 Sep 2014 <<												
Base Vol:	162	221	85	102	558	84	96	542	237	243	680	131
Growth Adj:	1.00	1.00	1.00	1.00	1.00	1.00	1.00	1.00	1.00	1.00	1.00	1.00
Initial Bse:	162	221	85	102	558	84	96	542	237	243	680	131
Added Vol:	0	0	0	0	0	0	0	0	0	0	0	0
PasserByVol:	0	0	0	0	0	0	0	0	0	0	0	0
Initial Fut:	162	221	85	102	558	84	96	542	237	243	680	131
User Adj:	1.00	1.00	1.00	1.00	1.00	1.00	1.00	1.00	1.00	1.00	1.00	1.00
PHF Adj:	1.00	1.00	1.00	1.00	1.00	1.00	1.00	1.00	1.00	1.00	1.00	1.00
PHF Volume:	162	221	85	102	558	84	96	542	237	243	680	131
Reduct Vol:	0	0	0	0	0	0	0	0	0	0	0	0
Reduced Vol:	162	221	85	102	558	84	96	542	237	243	680	131
PCE Adj:	1.00	1.00	1.00	1.00	1.00	1.00	1.00	1.00	1.00	1.00	1.00	1.00
MLF Adj:	1.00	1.00	1.00	1.00	1.00	1.00	1.00	1.00	1.00	1.00	1.00	1.00
FinalVolume:	162	221	85	102	558	84	96	542	237	243	680	131
Saturation Flow Module:												
Sat/Lane:	1900	1900	1900	1900	1900	1900	1900	1900	1900	1900	1900	1900
Adjustment:	0.92	1.00	0.92	0.92	0.98	0.95	0.92	1.00	0.92	0.83	1.00	0.92
Lanes:	1.00	1.00	1.00	1.00	1.73	0.27	1.00	2.00	1.00	2.00	2.00	1.00
Final Sat.:	1750	1900	1750	1750	3216	484	1750	3800	1750	3150	3800	1750
Capacity Analysis Module:												
Vol/Sat:	0.09	0.12	0.05	0.06	0.17	0.17	0.05	0.14	0.14	0.08	0.18	0.07
Crit Moves:	****				****		****				****	
Green Time:	20.0	38.3	38.3	19.2	37.5	37.5	11.9	32.8	32.8	17.7	38.7	38.7
Volume/Cap:	0.56	0.36	0.15	0.36	0.56	0.56	0.56	0.52	0.50	0.52	0.56	0.23
Delay/Veh:	48.3	31.9	29.4	45.8	34.9	34.9	55.5	37.5	37.5	48.3	34.1	30.0
User DelAdj:	1.00	1.00	1.00	1.00	1.00	1.00	1.00	1.00	1.00	1.00	1.00	1.00
AdjDel/Veh:	48.3	31.9	29.4	45.8	34.9	34.9	55.5	37.5	37.5	48.3	34.1	30.0
LOS by Move:	D	C	C	D	C	C	E	D	D	D	C	C
HCM2k95thQ:	11	12	5	7	18	18	7	16	15	10	19	7

Note: Queue reported is the number of cars per lane.

BART Phase II Extension Project

Level Of Service Computation Report
2000 HCM Operations (Future Volume Alternative)
AM - 2035 Project Conditions

Intersection #3077: BIRD/SAN CARLOS

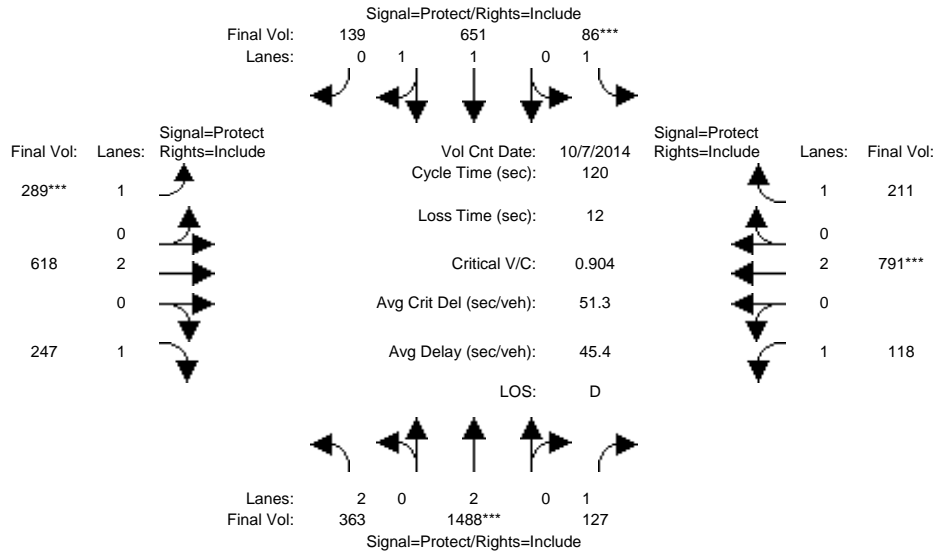

Approach:	North Bound			South Bound			East Bound			West Bound		
Movement:	L	T	R	L	T	R	L	T	R	L	T	R
Min. Green:	7	10	10	7	10	10	7	10	10	7	10	10
Y+R:	4.0	4.0	4.0	4.0	4.0	4.0	4.0	4.0	4.0	4.0	4.0	4.0
Volume Module: >> Count Date: 7 Oct 2014 <<												
Base Vol:	363	1488	127	86	651	139	289	618	247	118	791	211
Growth Adj:	1.00	1.00	1.00	1.00	1.00	1.00	1.00	1.00	1.00	1.00	1.00	1.00
Initial Bse:	363	1488	127	86	651	139	289	618	247	118	791	211
Added Vol:	0	0	0	0	0	0	0	0	0	0	0	0
PasserByVol:	0	0	0	0	0	0	0	0	0	0	0	0
Initial Fut:	363	1488	127	86	651	139	289	618	247	118	791	211
User Adj:	1.00	1.00	1.00	1.00	1.00	1.00	1.00	1.00	1.00	1.00	1.00	1.00
PHF Adj:	1.00	1.00	1.00	1.00	1.00	1.00	1.00	1.00	1.00	1.00	1.00	1.00
PHF Volume:	363	1488	127	86	651	139	289	618	247	118	791	211
Reduct Vol:	0	0	0	0	0	0	0	0	0	0	0	0
Reduced Vol:	363	1488	127	86	651	139	289	618	247	118	791	211
PCE Adj:	1.00	1.00	1.00	1.00	1.00	1.00	1.00	1.00	1.00	1.00	1.00	1.00
MLF Adj:	1.00	1.00	1.00	1.00	1.00	1.00	1.00	1.00	1.00	1.00	1.00	1.00
Final Volume:	363	1488	127	86	651	139	289	618	247	118	791	211
Saturation Flow Module:												
Sat/Lane:	1900	1900	1900	1900	1900	1900	1900	1900	1900	1900	1900	1900
Adjustment:	0.83	1.00	0.92	0.92	0.98	0.95	0.92	1.00	0.92	0.92	1.00	0.92
Lanes:	2.00	2.00	1.00	1.00	1.64	0.36	1.00	2.00	1.00	1.00	2.00	1.00
Final Sat.:	3150	3800	1750	1750	3049	651	1750	3800	1750	1750	3800	1750
Capacity Analysis Module:												
Vol/Sat:	0.12	0.39	0.07	0.05	0.21	0.21	0.17	0.16	0.14	0.07	0.21	0.12
Crit Moves:	****	****	****	****	****	****	****	****	****	****	****	****
Green Time:	20.6	51.7	51.7	7.0	38.1	38.1	21.8	34.8	34.8	14.4	27.5	27.5
Volume/Cap:	0.67	0.91	0.17	0.84	0.67	0.67	0.91	0.56	0.49	0.56	0.91	0.53
Delay/Veh:	49.9	39.8	21.1	99.6	37.0	37.0	76.6	36.7	35.9	53.2	58.3	41.9
User DelAdj:	1.00	1.00	1.00	1.00	1.00	1.00	1.00	1.00	1.00	1.00	1.00	1.00
AdjDel/Veh:	49.9	39.8	21.1	99.6	37.0	37.0	76.6	36.7	35.9	53.2	58.3	41.9
LOS by Move:	D	D	C	F	D	D	E	D	D	D	E	D
HCM2k95thQ:	14	46	6	8	23	23	23	18	15	9	28	14

Note: Queue reported is the number of cars per lane.

BART Phase II Extension Project

Level Of Service Computation Report
2000 HCM Operations (Future Volume Alternative)
PM - 2035 Project Conditions

Intersection #3077: BIRD/SAN CARLOS

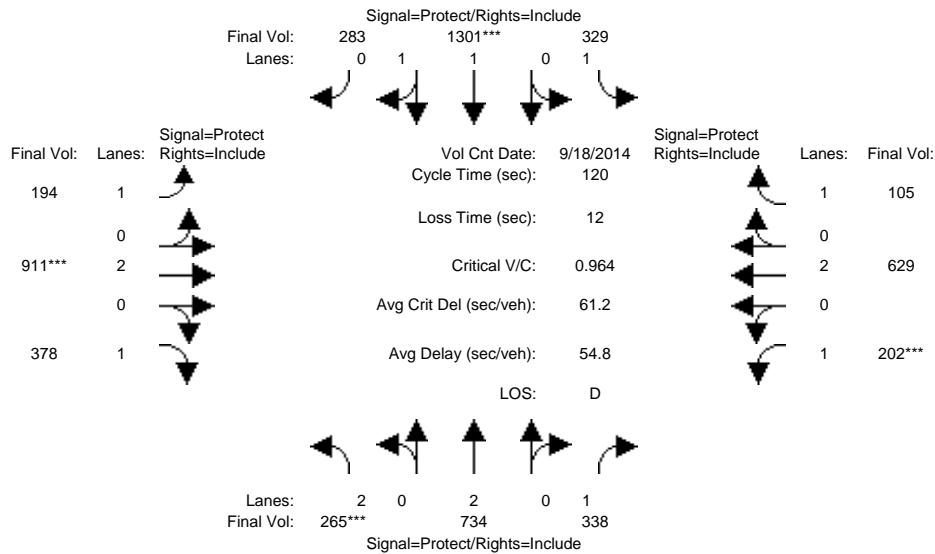

Approach:	North Bound			South Bound			East Bound			West Bound		
	L	T	R	L	T	R	L	T	R	L	T	R
Min. Green:	7	10	10	7	10	10	7	10	10	7	10	10
Y+R:	4.0	4.0	4.0	4.0	4.0	4.0	4.0	4.0	4.0	4.0	4.0	4.0
Volume Module: >> Count Date: 18 Sep 2014 <<												
Base Vol:	265	734	338	329	1301	283	194	911	378	202	629	105
Growth Adj:	1.00	1.00	1.00	1.00	1.00	1.00	1.00	1.00	1.00	1.00	1.00	1.00
Initial Bse:	265	734	338	329	1301	283	194	911	378	202	629	105
Added Vol:	0	0	0	0	0	0	0	0	0	0	0	0
PasserByVol:	0	0	0	0	0	0	0	0	0	0	0	0
Initial Fut:	265	734	338	329	1301	283	194	911	378	202	629	105
User Adj:	1.00	1.00	1.00	1.00	1.00	1.00	1.00	1.00	1.00	1.00	1.00	1.00
PHF Adj:	1.00	1.00	1.00	1.00	1.00	1.00	1.00	1.00	1.00	1.00	1.00	1.00
PHF Volume:	265	734	338	329	1301	283	194	911	378	202	629	105
Reduct Vol:	0	0	0	0	0	0	0	0	0	0	0	0
Reduced Vol:	265	734	338	329	1301	283	194	911	378	202	629	105
PCE Adj:	1.00	1.00	1.00	1.00	1.00	1.00	1.00	1.00	1.00	1.00	1.00	1.00
MLF Adj:	1.00	1.00	1.00	1.00	1.00	1.00	1.00	1.00	1.00	1.00	1.00	1.00
FinalVolume:	265	734	338	329	1301	283	194	911	378	202	629	105
Saturation Flow Module:												
Sat/Lane:	1900	1900	1900	1900	1900	1900	1900	1900	1900	1900	1900	1900
Adjustment:	0.83	1.00	0.92	0.92	0.98	0.95	0.92	1.00	0.92	0.92	1.00	0.92
Lanes:	2.00	2.00	1.00	1.00	1.63	0.37	1.00	2.00	1.00	1.00	2.00	1.00
Final Sat.:	3150	3800	1750	1750	3038	661	1750	3800	1750	1750	3800	1750
Capacity Analysis Module:												
Vol/Sat:	0.08	0.19	0.19	0.19	0.43	0.43	0.11	0.24	0.22	0.12	0.17	0.06
Crit Moves:	****				****		****			****		
Green Time:	10.5	32.3	32.3	31.5	53.3	53.3	17.7	29.8	29.8	14.4	26.5	26.5
Volume/Cap:	0.96	0.72	0.72	0.72	0.96	0.96	0.75	0.96	0.87	0.96	0.75	0.27
Delay/Veh:	98.8	42.2	44.9	45.6	46.9	46.9	60.6	65.5	60.0	104.2	47.5	39.1
User DelAdj:	1.00	1.00	1.00	1.00	1.00	1.00	1.00	1.00	1.00	1.00	1.00	1.00
AdjDel/Veh:	98.8	42.2	44.9	45.6	46.9	46.9	60.6	65.5	60.0	104.2	47.5	39.1
LOS by Move:	F	D	D	D	D	D	E	E	E	F	D	D
HCM2k95thQ:	14	22	22	22	53	53	15	33	27	18	20	7

Note: Queue reported is the number of cars per lane.

BART Phase II Extension Project

Level Of Service Computation Report
 2000 HCM Operations (Future Volume Alternative)
 AM - 2035 Project Conditions

Intersection #3112: MONTGOMERY/SANTA CLARA

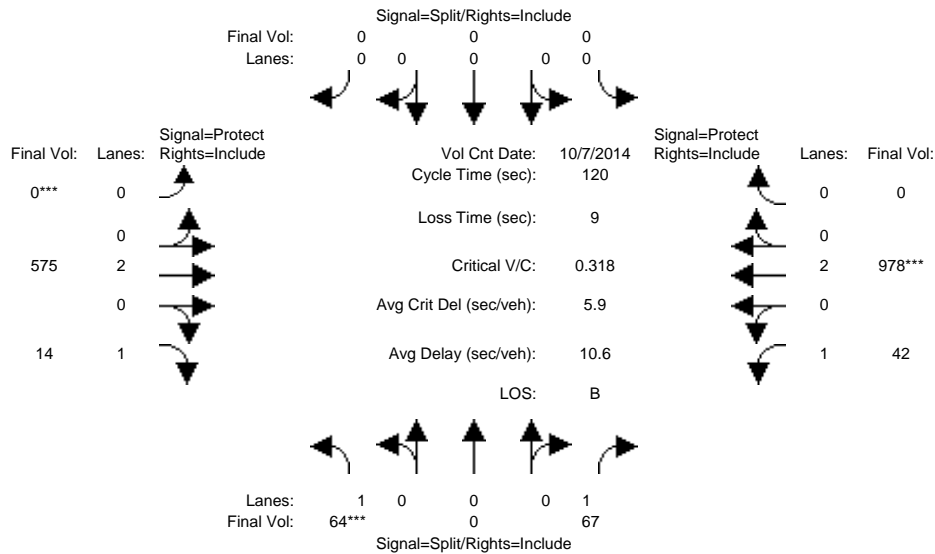

Approach:	North Bound			South Bound			East Bound			West Bound		
Movement:	L	T	R	L	T	R	L	T	R	L	T	R
Min. Green:	10	0	10	0	0	0	0	10	10	7	10	0
Y+R:	4.0	4.0	4.0	4.0	4.0	4.0	4.0	4.0	4.0	4.0	4.0	4.0
Volume Module: >> Count Date: 7 Oct 2014 <<												
Base Vol:	64	0	67	0	0	0	0	575	14	42	978	0
Growth Adj:	1.00	1.00	1.00	1.00	1.00	1.00	1.00	1.00	1.00	1.00	1.00	1.00
Initial Bse:	64	0	67	0	0	0	0	575	14	42	978	0
Added Vol:	0	0	0	0	0	0	0	0	0	0	0	0
PasserByVol:	0	0	0	0	0	0	0	0	0	0	0	0
Initial Fut:	64	0	67	0	0	0	0	575	14	42	978	0
User Adj:	1.00	1.00	1.00	1.00	1.00	1.00	1.00	1.00	1.00	1.00	1.00	1.00
PHF Adj:	1.00	1.00	1.00	1.00	1.00	1.00	1.00	1.00	1.00	1.00	1.00	1.00
PHF Volume:	64	0	67	0	0	0	0	575	14	42	978	0
Reduct Vol:	0	0	0	0	0	0	0	0	0	0	0	0
Reduced Vol:	64	0	67	0	0	0	0	575	14	42	978	0
PCE Adj:	1.00	1.00	1.00	1.00	1.00	1.00	1.00	1.00	1.00	1.00	1.00	1.00
MLF Adj:	1.00	1.00	1.00	1.00	1.00	1.00	1.00	1.00	1.00	1.00	1.00	1.00
FinalVolume:	64	0	67	0	0	0	0	575	14	42	978	0
Saturation Flow Module:												
Sat/Lane:	1900	1900	1900	1900	1900	1900	1900	1900	1900	1900	1900	1900
Adjustment:	0.92	1.00	0.92	0.92	1.00	0.92	0.92	1.00	0.92	0.92	1.00	0.92
Lanes:	1.00	0.00	1.00	0.00	0.00	0.00	0.00	2.00	1.00	1.00	2.00	0.00
Final Sat.:	1750	0	1750	0	0	0	0	3800	1750	1750	3800	0
Capacity Analysis Module:												
Vol/Sat:	0.04	0.00	0.04	0.00	0.00	0.00	0.00	0.15	0.01	0.02	0.26	0.00
Crit Moves:	****							****			****	
Green Time:	14.4	0.0	14.4	0.0	0.0	0.0	0.0	69.7	69.7	26.9	96.6	0.0
Volume/Cap:	0.31	0.00	0.32	0.00	0.00	0.00	0.00	0.26	0.01	0.11	0.32	0.00
Delay/Veh:	49.1	0.0	49.2	0.0	0.0	0.0	0.0	12.5	10.6	37.1	3.1	0.0
User DelAdj:	1.00	1.00	1.00	1.00	1.00	1.00	1.00	1.00	1.00	1.00	1.00	1.00
AdjDel/Veh:	49.1	0.0	49.2	0.0	0.0	0.0	0.0	12.5	10.6	37.1	3.1	0.0
LOS by Move:	D	A	D	A	A	A	A	B	B	D	A	A
HCM2k95thQ:	5	0	5	0	0	0	0	10	0	3	9	0

Note: Queue reported is the number of cars per lane.

BART Phase II Extension Project

Level Of Service Computation Report
2000 HCM Operations (Future Volume Alternative)
PM - 2035 Project Conditions

Intersection #3112: MONTGOMERY/SANTA CLARA

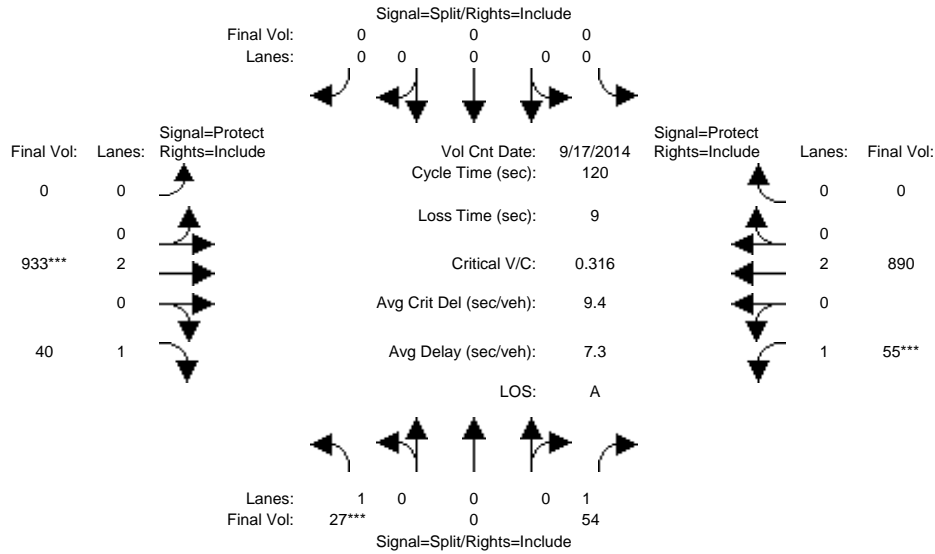

Approach:	North Bound			South Bound			East Bound			West Bound		
	L	T	R	L	T	R	L	T	R	L	T	R
Min. Green:	10	0	10	0	0	0	0	10	10	7	10	0
Y+R:	4.0	4.0	4.0	4.0	4.0	4.0	4.0	4.0	4.0	4.0	4.0	4.0
Volume Module: >> Count Date: 17 Sep 2014 <<												
Base Vol:	27	0	54	0	0	0	0	933	40	55	890	0
Growth Adj:	1.00	1.00	1.00	1.00	1.00	1.00	1.00	1.00	1.00	1.00	1.00	1.00
Initial Bse:	27	0	54	0	0	0	0	933	40	55	890	0
Added Vol:	0	0	0	0	0	0	0	0	0	0	0	0
PasserByVol:	0	0	0	0	0	0	0	0	0	0	0	0
Initial Fut:	27	0	54	0	0	0	0	933	40	55	890	0
User Adj:	1.00	1.00	1.00	1.00	1.00	1.00	1.00	1.00	1.00	1.00	1.00	1.00
PHF Adj:	1.00	1.00	1.00	1.00	1.00	1.00	1.00	1.00	1.00	1.00	1.00	1.00
PHF Volume:	27	0	54	0	0	0	0	933	40	55	890	0
Reduct Vol:	0	0	0	0	0	0	0	0	0	0	0	0
Reduced Vol:	27	0	54	0	0	0	0	933	40	55	890	0
PCE Adj:	1.00	1.00	1.00	1.00	1.00	1.00	1.00	1.00	1.00	1.00	1.00	1.00
MLF Adj:	1.00	1.00	1.00	1.00	1.00	1.00	1.00	1.00	1.00	1.00	1.00	1.00
FinalVolume:	27	0	54	0	0	0	0	933	40	55	890	0
Saturation Flow Module:												
Sat/Lane:	1900	1900	1900	1900	1900	1900	1900	1900	1900	1900	1900	1900
Adjustment:	0.92	1.00	0.92	0.92	1.00	0.92	0.92	1.00	0.92	0.92	1.00	0.92
Lanes:	1.00	0.00	1.00	0.00	0.00	0.00	0.00	2.00	1.00	1.00	2.00	0.00
Final Sat.:	1750	0	1750	0	0	0	0	3800	1750	1750	3800	0
Capacity Analysis Module:												
Vol/Sat:	0.02	0.00	0.03	0.00	0.00	0.00	0.00	0.25	0.02	0.03	0.23	0.00
Crit Moves:	****							****		****		
Green Time:	11.7	0.0	11.7	0.0	0.0	0.0	0.0	88.0	88.0	11.3	99.3	0.0
Volume/Cap:	0.16	0.00	0.32	0.00	0.00	0.00	0.00	0.33	0.03	0.33	0.28	0.00
Delay/Veh:	50.1	0.0	51.5	0.0	0.0	0.0	0.0	5.7	4.4	52.1	2.4	0.0
User DelAdj:	1.00	1.00	1.00	1.00	1.00	1.00	1.00	1.00	1.00	1.00	1.00	1.00
AdjDel/Veh:	50.1	0.0	51.5	0.0	0.0	0.0	0.0	5.7	4.4	52.1	2.4	0.0
LOS by Move:	D	A	D	A	A	A	A	A	A	D	A	A
HCM2k95thQ:	2	0	5	0	0	0	0	12	1	4	7	0

Note: Queue reported is the number of cars per lane.

BART Phase II Extension Project

Level Of Service Computation Report
2000 HCM Operations (Future Volume Alternative)
AM - 2035 Project Conditions

Intersection #3227: ALAMEDA/JULIAN

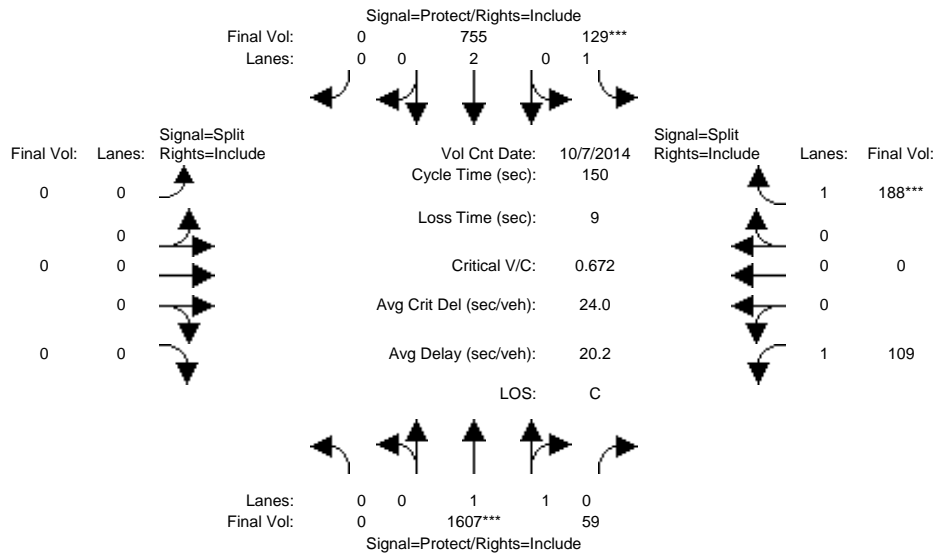

Approach:	North Bound			South Bound			East Bound			West Bound		
	L	T	R	L	T	R	L	T	R	L	T	R
Min. Green:	0	10	10	7	10	0	0	0	0	10	0	10
Y+R:	4.0	4.0	4.0	4.0	4.0	4.0	4.0	4.0	4.0	4.0	4.0	4.0
Volume Module: >> Count Date: 7 Oct 2014 <<												
Base Vol:	0	1607	59	129	755	0	0	0	0	109	0	188
Growth Adj:	1.00	1.00	1.00	1.00	1.00	1.00	1.00	1.00	1.00	1.00	1.00	1.00
Initial Bse:	0	1607	59	129	755	0	0	0	0	109	0	188
Added Vol:	0	0	0	0	0	0	0	0	0	0	0	0
PasserByVol:	0	0	0	0	0	0	0	0	0	0	0	0
Initial Fut:	0	1607	59	129	755	0	0	0	0	109	0	188
User Adj:	1.00	1.00	1.00	1.00	1.00	1.00	1.00	1.00	1.00	1.00	1.00	1.00
PHF Adj:	1.00	1.00	1.00	1.00	1.00	1.00	1.00	1.00	1.00	1.00	1.00	1.00
PHF Volume:	0	1607	59	129	755	0	0	0	0	109	0	188
Reduct Vol:	0	0	0	0	0	0	0	0	0	0	0	0
Reduced Vol:	0	1607	59	129	755	0	0	0	0	109	0	188
PCE Adj:	1.00	1.00	1.00	1.00	1.00	1.00	1.00	1.00	1.00	1.00	1.00	1.00
MLF Adj:	1.00	1.00	1.00	1.00	1.00	1.00	1.00	1.00	1.00	1.00	1.00	1.00
FinalVolume:	0	1607	59	129	755	0	0	0	0	109	0	188
Saturation Flow Module:												
Sat/Lane:	1900	1900	1900	1900	1900	1900	1900	1900	1900	1900	1900	1900
Adjustment:	0.92	0.97	0.95	0.92	1.00	0.92	0.92	1.00	0.92	0.92	1.00	0.92
Lanes:	0.00	1.93	0.07	1.00	2.00	0.00	0.00	0.00	0.00	1.00	0.00	1.00
Final Sat.:	0	3569	131	1750	3800	0	0	0	0	1750	0	1750
Capacity Analysis Module:												
Vol/Sat:	0.00	0.45	0.45	0.07	0.20	0.00	0.00	0.00	0.00	0.06	0.00	0.11
Crit Moves:	****			****						****		
Green Time:	0.0	101	100.6	16.5	117	0.0	0.0	0.0	0.0	24.0	0.0	24.0
Volume/Cap:	0.00	0.67	0.67	0.67	0.25	0.00	0.00	0.00	0.00	0.39	0.00	0.67
Delay/Veh:	0.0	15.6	15.6	73.1	4.6	0.0	0.0	0.0	0.0	57.3	0.0	65.5
User DelAdj:	1.00	1.00	1.00	1.00	1.00	1.00	1.00	1.00	1.00	1.00	1.00	1.00
AdjDel/Veh:	0.0	15.6	15.6	73.1	4.6	0.0	0.0	0.0	0.0	57.3	0.0	65.5
LOS by Move:	A	B	B	E	A	A	A	A	A	E	A	E
HCM2k95thQ:	0	38	38	12	9	0	0	0	0	9	0	17

Note: Queue reported is the number of cars per lane.

BART Phase II Extension Project

Level Of Service Computation Report
2000 HCM Operations (Future Volume Alternative)
PM - 2035 Project Conditions

Intersection #3227: ALAMEDA/JULIAN

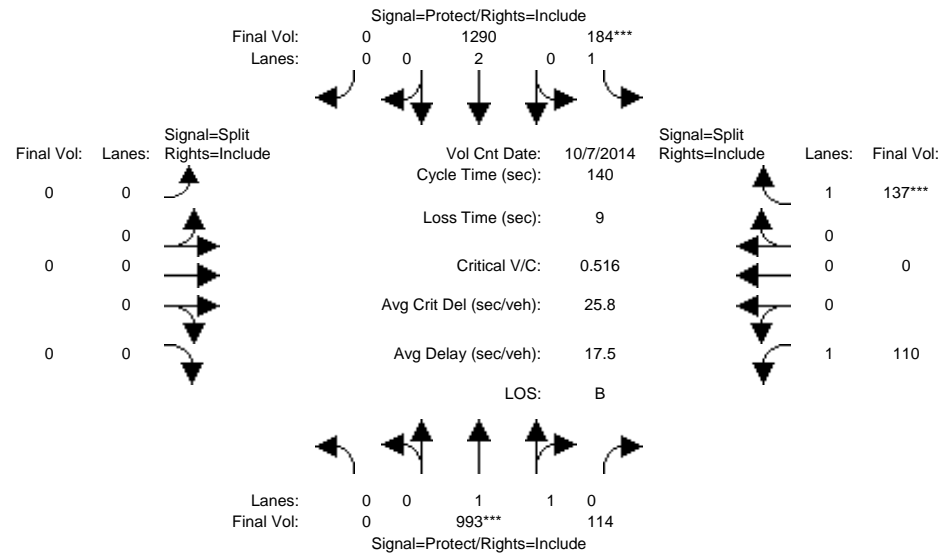

Approach:	North Bound			South Bound			East Bound			West Bound		
	L	T	R	L	T	R	L	T	R	L	T	R
Min. Green:	0	10	10	7	10	0	0	0	0	10	0	10
Y+R:	4.0	4.0	4.0	4.0	4.0	4.0	4.0	4.0	4.0	4.0	4.0	4.0
Volume Module: >> Count Date: 7 Oct 2014 <<												
Base Vol:	0	993	114	184	1290	0	0	0	0	110	0	137
Growth Adj:	1.00	1.00	1.00	1.00	1.00	1.00	1.00	1.00	1.00	1.00	1.00	1.00
Initial Bse:	0	993	114	184	1290	0	0	0	0	110	0	137
Added Vol:	0	0	0	0	0	0	0	0	0	0	0	0
PasserByVol:	0	0	0	0	0	0	0	0	0	0	0	0
Initial Fut:	0	993	114	184	1290	0	0	0	0	110	0	137
User Adj:	1.00	1.00	1.00	1.00	1.00	1.00	1.00	1.00	1.00	1.00	1.00	1.00
PHF Adj:	1.00	1.00	1.00	1.00	1.00	1.00	1.00	1.00	1.00	1.00	1.00	1.00
PHF Volume:	0	993	114	184	1290	0	0	0	0	110	0	137
Reduct Vol:	0	0	0	0	0	0	0	0	0	0	0	0
Reduced Vol:	0	993	114	184	1290	0	0	0	0	110	0	137
PCE Adj:	1.00	1.00	1.00	1.00	1.00	1.00	1.00	1.00	1.00	1.00	1.00	1.00
MLF Adj:	1.00	1.00	1.00	1.00	1.00	1.00	1.00	1.00	1.00	1.00	1.00	1.00
FinalVolume:	0	993	114	184	1290	0	0	0	0	110	0	137
Saturation Flow Module:												
Sat/Lane:	1900	1900	1900	1900	1900	1900	1900	1900	1900	1900	1900	1900
Adjustment:	0.92	0.98	0.95	0.92	1.00	0.92	0.92	1.00	0.92	0.92	1.00	0.92
Lanes:	0.00	1.79	0.21	1.00	2.00	0.00	0.00	0.00	0.00	1.00	0.00	1.00
Final Sat.:	0	3319	381	1750	3800	0	0	0	0	1750	0	1750
Capacity Analysis Module:												
Vol/Sat:	0.00	0.30	0.30	0.11	0.34	0.00	0.00	0.00	0.00	0.06	0.00	0.08
Crit Moves:	****			****						****		
Green Time:	0.0	81.2	81.2	28.5	110	0.0	0.0	0.0	0.0	21.2	0.0	21.2
Volume/Cap:	0.00	0.52	0.52	0.52	0.43	0.00	0.00	0.00	0.00	0.41	0.00	0.52
Delay/Veh:	0.0	17.8	17.8	50.9	5.0	0.0	0.0	0.0	0.0	54.8	0.0	56.4
User DelAdj:	1.00	1.00	1.00	1.00	1.00	1.00	1.00	1.00	1.00	1.00	1.00	1.00
AdjDel/Veh:	0.0	17.8	17.8	50.9	5.0	0.0	0.0	0.0	0.0	54.8	0.0	56.4
LOS by Move:	A	B	B	D	A	A	A	A	A	D	A	E
HCM2k95thQ:	0	25	25	14	17	0	0	0	0	9	0	11

Note: Queue reported is the number of cars per lane.

BART Phase II Extension Project

Level Of Service Computation Report
2000 HCM Operations (Future Volume Alternative)
AM - 2035 Project Conditions

Intersection #3230: ALAMEDA/STOCKTON

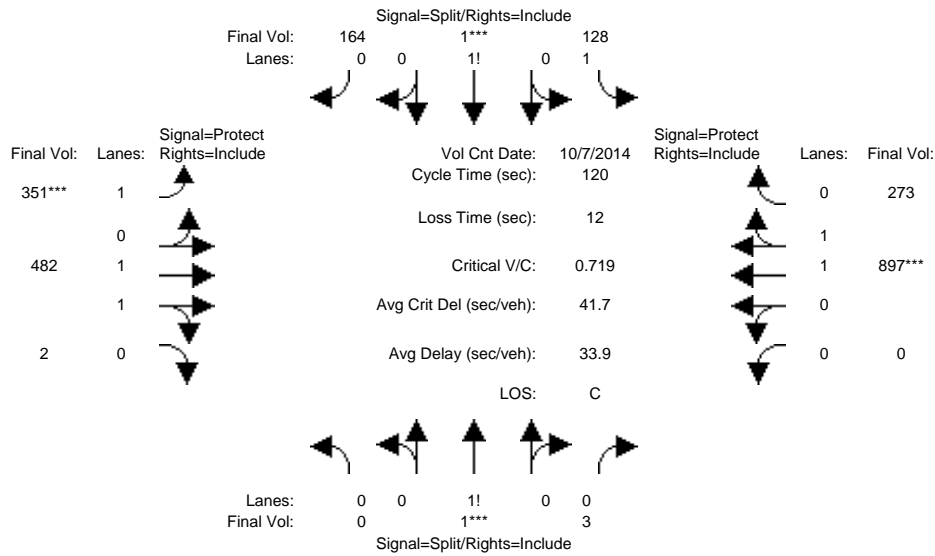

Approach:	North Bound			South Bound			East Bound			West Bound		
Movement:	L	T	R	L	T	R	L	T	R	L	T	R
Min. Green:	10	10	10	10	10	10	7	10	10	0	10	10
Y+R:	4.0	4.0	4.0	4.0	4.0	4.0	4.0	4.0	4.0	4.0	4.0	4.0
Volume Module: >> Count Date:	7 Oct 2014 <<											
Base Vol:	0	1	3	128	1	164	351	482	2	0	897	273
Growth Adj:	1.00	1.00	1.00	1.00	1.00	1.00	1.00	1.00	1.00	1.00	1.00	1.00
Initial Bse:	0	1	3	128	1	164	351	482	2	0	897	273
Added Vol:	0	0	0	0	0	0	0	0	0	0	0	0
PasserByVol:	0	0	0	0	0	0	0	0	0	0	0	0
Initial Fut:	0	1	3	128	1	164	351	482	2	0	897	273
User Adj:	1.00	1.00	1.00	1.00	1.00	1.00	1.00	1.00	1.00	1.00	1.00	1.00
PHF Adj:	1.00	1.00	1.00	1.00	1.00	1.00	1.00	1.00	1.00	1.00	1.00	1.00
PHF Volume:	0	1	3	128	1	164	351	482	2	0	897	273
Reduct Vol:	0	0	0	0	0	0	0	0	0	0	0	0
Reduced Vol:	0	1	3	128	1	164	351	482	2	0	897	273
PCE Adj:	1.00	1.00	1.00	1.00	1.00	1.00	1.00	1.00	1.00	1.00	1.00	1.00
MLF Adj:	1.00	1.00	1.00	1.00	1.00	1.00	1.00	1.00	1.00	1.00	1.00	1.00
FinalVolume:	0	1	3	128	1	164	351	482	2	0	897	273
Saturation Flow Module:												
Sat/Lane:	1900	1900	1900	1900	1900	1900	1900	1900	1900	1900	1900	1900
Adjustment:	0.92	0.95	0.95	0.92	0.95	0.95	0.92	0.97	0.95	0.92	0.98	0.95
Lanes:	0.00	0.25	0.75	1.28	0.01	0.71	1.00	1.99	0.01	0.00	1.52	0.48
Final Sat.:	0	450	1350	2249	8	1279	1750	3685	15	0	2836	863
Capacity Analysis Module:												
Vol/Sat:	0.00	0.00	0.00	0.06	0.13	0.13	0.20	0.13	0.13	0.00	0.32	0.32
Crit Moves:	****			****			****			****		
Green Time:	0.0	10.0	10.0	19.5	19.5	19.5	30.5	78.5	78.5	0.0	48.0	48.0
Volume/Cap:	0.00	0.03	0.03	0.35	0.79	0.79	0.79	0.20	0.20	0.00	0.79	0.79
Delay/Veh:	0.0	50.6	50.6	44.9	59.2	59.2	51.0	8.3	8.3	0.0	34.5	34.5
User DelAdj:	1.00	1.00	1.00	1.00	1.00	1.00	1.00	1.00	1.00	1.00	1.00	1.00
AdjDel/Veh:	0.0	50.6	50.6	44.9	59.2	59.2	51.0	8.3	8.3	0.0	34.5	34.5
LOS by Move:	A	D	D	D	E	E	D	A	A	A	C	C
HCM2k95thQ:	0	0	0	7	17	17	24	7	7	0	34	34

Note: Queue reported is the number of cars per lane.

BART Phase II Extension Project

Level Of Service Computation Report
2000 HCM Operations (Future Volume Alternative)
PM - 2035 Project Conditions

Intersection #3230: ALAMEDA/STOCKTON

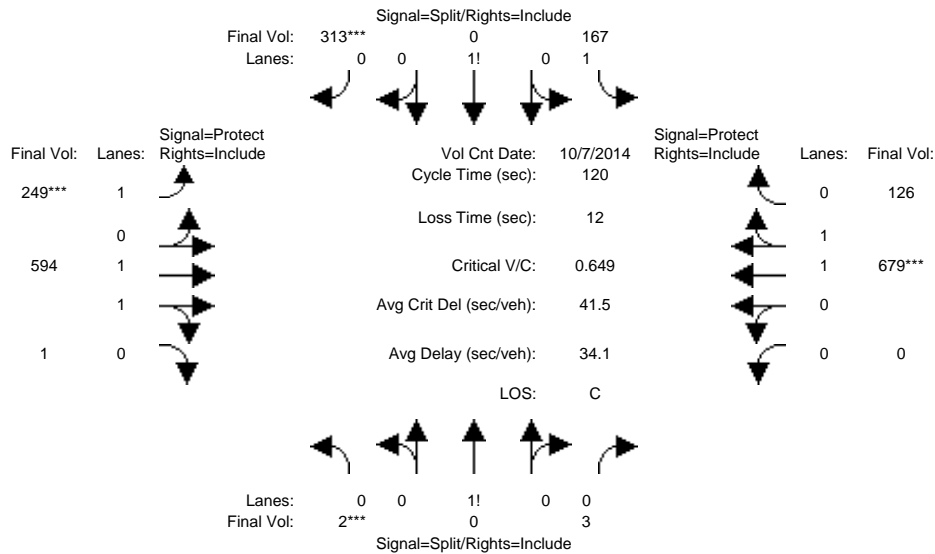

Approach:	North Bound			South Bound			East Bound			West Bound		
	L	T	R	L	T	R	L	T	R	L	T	R
Min. Green:	10	10	10	10	10	10	7	10	10	0	10	10
Y+R:	4.0	4.0	4.0	4.0	4.0	4.0	4.0	4.0	4.0	4.0	4.0	4.0
Volume Module: >> Count Date: 7 Oct 2014 <<												
Base Vol:	2	0	3	167	0	313	249	594	1	0	679	126
Growth Adj:	1.00	1.00	1.00	1.00	1.00	1.00	1.00	1.00	1.00	1.00	1.00	1.00
Initial Bse:	2	0	3	167	0	313	249	594	1	0	679	126
Added Vol:	0	0	0	0	0	0	0	0	0	0	0	0
PasserByVol:	0	0	0	0	0	0	0	0	0	0	0	0
Initial Fut:	2	0	3	167	0	313	249	594	1	0	679	126
User Adj:	1.00	1.00	1.00	1.00	1.00	1.00	1.00	1.00	1.00	1.00	1.00	1.00
PHF Adj:	1.00	1.00	1.00	1.00	1.00	1.00	1.00	1.00	1.00	1.00	1.00	1.00
PHF Volume:	2	0	3	167	0	313	249	594	1	0	679	126
Reduct Vol:	0	0	0	0	0	0	0	0	0	0	0	0
Reduced Vol:	2	0	3	167	0	313	249	594	1	0	679	126
PCE Adj:	1.00	1.00	1.00	1.00	1.00	1.00	1.00	1.00	1.00	1.00	1.00	1.00
MLF Adj:	1.00	1.00	1.00	1.00	1.00	1.00	1.00	1.00	1.00	1.00	1.00	1.00
FinalVolume:	2	0	3	167	0	313	249	594	1	0	679	126
Saturation Flow Module:												
Sat/Lane:	1900	1900	1900	1900	1900	1900	1900	1900	1900	1900	1900	1900
Adjustment:	0.92	0.92	0.92	0.92	1.00	0.95	0.92	0.97	0.95	0.92	0.98	0.95
Lanes:	0.40	0.00	0.60	1.22	0.00	0.78	1.00	1.99	0.01	0.00	1.68	0.32
Final Sat.:	700	0	1050	2127	0	1412	1750	3694	6	0	3120	579
Capacity Analysis Module:												
Vol/Sat:	0.00	0.00	0.00	0.08	0.00	0.22	0.14	0.16	0.16	0.00	0.22	0.22
Crit Moves:	****					****	****			****		
Green Time:	10.0	0.0	10.0	37.3	0.0	37.3	24.0	60.7	60.7	0.0	36.7	36.7
Volume/Cap:	0.03	0.00	0.03	0.25	0.00	0.71	0.71	0.32	0.32	0.00	0.71	0.71
Delay/Veh:	50.7	0.0	50.7	31.0	0.0	40.1	51.5	17.6	17.6	0.0	39.1	39.1
User DelAdj:	1.00	1.00	1.00	1.00	1.00	1.00	1.00	1.00	1.00	1.00	1.00	1.00
AdjDel/Veh:	50.7	0.0	50.7	31.0	0.0	40.1	51.5	17.6	17.6	0.0	39.1	39.1
LOS by Move:	D	A	D	C	A	D	D	B	B	A	D	D
HCM2k95thQ:	0	0	0	8	0	24	18	12	12	0	24	24

Note: Queue reported is the number of cars per lane.

BART Phase II Extension Project

Level Of Service Computation Report
2000 HCM Operations (Future Volume Alternative)
AM - 2035 Project Conditions

Intersection #3263: AUTUMN/JULIAN

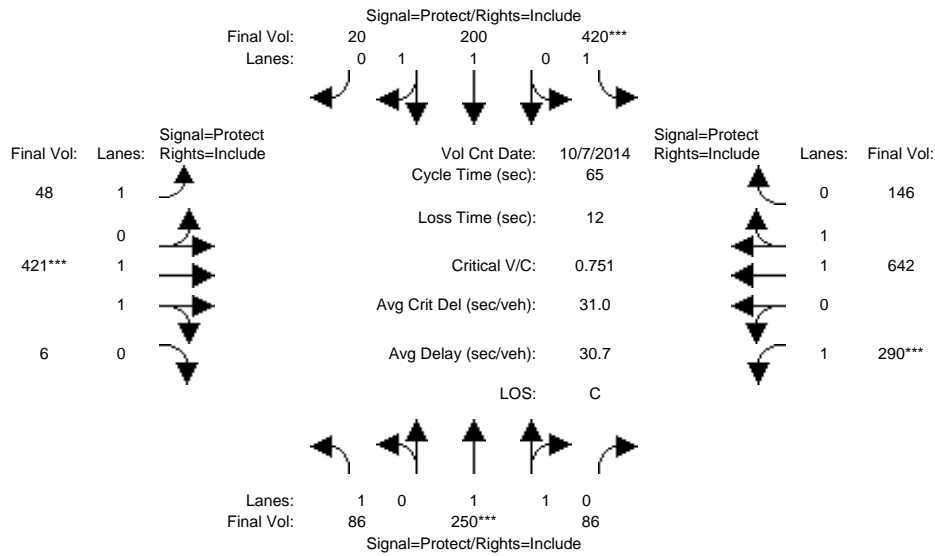

Approach:	North Bound			South Bound			East Bound			West Bound		
	L	T	R	L	T	R	L	T	R	L	T	R
Min. Green:	7	10	10	7	10	10	7	10	10	7	10	10
Y+R:	4.0	4.0	4.0	4.0	4.0	4.0	4.0	4.0	4.0	4.0	4.0	4.0
Volume Module: >> Count Date: 7 Oct 2014 <<												
Base Vol:	86	250	86	420	200	20	48	421	6	290	642	146
Growth Adj:	1.00	1.00	1.00	1.00	1.00	1.00	1.00	1.00	1.00	1.00	1.00	1.00
Initial Bse:	86	250	86	420	200	20	48	421	6	290	642	146
Added Vol:	0	0	0	0	0	0	0	0	0	0	0	0
PasserByVol:	0	0	0	0	0	0	0	0	0	0	0	0
Initial Fut:	86	250	86	420	200	20	48	421	6	290	642	146
User Adj:	1.00	1.00	1.00	1.00	1.00	1.00	1.00	1.00	1.00	1.00	1.00	1.00
PHF Adj:	1.00	1.00	1.00	1.00	1.00	1.00	1.00	1.00	1.00	1.00	1.00	1.00
PHF Volume:	86	250	86	420	200	20	48	421	6	290	642	146
Reduct Vol:	0	0	0	0	0	0	0	0	0	0	0	0
Reduced Vol:	86	250	86	420	200	20	48	421	6	290	642	146
PCE Adj:	1.00	1.00	1.00	1.00	1.00	1.00	1.00	1.00	1.00	1.00	1.00	1.00
MLF Adj:	1.00	1.00	1.00	1.00	1.00	1.00	1.00	1.00	1.00	1.00	1.00	1.00
Final Volume:	86	250	86	420	200	20	48	421	6	290	642	146
Saturation Flow Module:												
Sat/Lane:	1900	1900	1900	1900	1900	1900	1900	1900	1900	1900	1900	1900
Adjustment:	0.92	0.98	0.95	0.92	0.98	0.95	0.92	0.97	0.95	0.92	0.98	0.95
Lanes:	1.00	1.47	0.53	1.00	1.81	0.19	1.00	1.97	0.03	1.00	1.62	0.38
Final Sat.:	1750	2752	947	1750	3363	336	1750	3648	52	1750	3014	685
Capacity Analysis Module:												
Vol/Sat:	0.05	0.09	0.09	0.24	0.06	0.06	0.03	0.12	0.12	0.17	0.21	0.21
Crit Moves:	****	****	****	****	****	****	****	****	****	****	****	****
Green Time:	12.2	10.0	10.0	19.5	17.4	17.4	7.9	10.0	10.0	13.5	15.6	15.6
Volume/Cap:	0.26	0.59	0.59	0.80	0.22	0.22	0.23	0.75	0.75	0.80	0.89	0.89
Delay/Veh:	23.0	27.2	27.2	29.4	18.7	18.7	26.3	31.8	31.8	36.3	34.7	34.7
User DelAdj:	1.00	1.00	1.00	1.00	1.00	1.00	1.00	1.00	1.00	1.00	1.00	1.00
AdjDel/Veh:	23.0	27.2	27.2	29.4	18.7	18.7	26.3	31.8	31.8	36.3	34.7	34.7
LOS by Move:	C	C	C	C	B	B	C	C	C	D	C	C
HCM2k95thQ:	3	6	6	20	4	4	2	9	9	12	17	17

Note: Queue reported is the number of cars per lane.

BART Phase II Extension Project

Level Of Service Computation Report
2000 HCM Operations (Future Volume Alternative)
PM - 2035 Project Conditions

Intersection #3263: AUTUMN/JULIAN

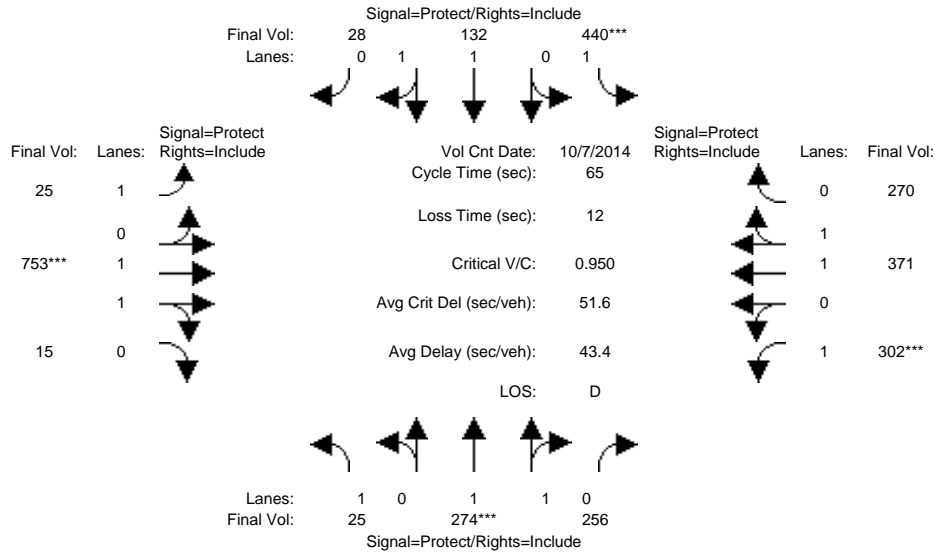

Approach:	North Bound			South Bound			East Bound			West Bound		
Movement:	L	T	R	L	T	R	L	T	R	L	T	R
Min. Green:	7	10	10	7	10	10	7	10	10	7	10	10
Y+R:	4.0	4.0	4.0	4.0	4.0	4.0	4.0	4.0	4.0	4.0	4.0	4.0
Volume Module: >> Count Date: 7 Oct 2014 <<												
Base Vol:	25	274	256	440	132	28	25	753	15	302	371	270
Growth Adj:	1.00	1.00	1.00	1.00	1.00	1.00	1.00	1.00	1.00	1.00	1.00	1.00
Initial Bse:	25	274	256	440	132	28	25	753	15	302	371	270
Added Vol:	0	0	0	0	0	0	0	0	0	0	0	0
PasserByVol:	0	0	0	0	0	0	0	0	0	0	0	0
Initial Fut:	25	274	256	440	132	28	25	753	15	302	371	270
User Adj:	1.00	1.00	1.00	1.00	1.00	1.00	1.00	1.00	1.00	1.00	1.00	1.00
PHF Adj:	1.00	1.00	1.00	1.00	1.00	1.00	1.00	1.00	1.00	1.00	1.00	1.00
PHF Volume:	25	274	256	440	132	28	25	753	15	302	371	270
Reduct Vol:	0	0	0	0	0	0	0	0	0	0	0	0
Reduced Vol:	25	274	256	440	132	28	25	753	15	302	371	270
PCE Adj:	1.00	1.00	1.00	1.00	1.00	1.00	1.00	1.00	1.00	1.00	1.00	1.00
MLF Adj:	1.00	1.00	1.00	1.00	1.00	1.00	1.00	1.00	1.00	1.00	1.00	1.00
FinalVolume:	25	274	256	440	132	28	25	753	15	302	371	270
Saturation Flow Module:												
Sat/Lane:	1900	1900	1900	1900	1900	1900	1900	1900	1900	1900	1900	1900
Adjustment:	0.92	1.00	0.95	0.92	0.98	0.95	0.92	0.97	0.95	0.92	0.99	0.95
Lanes:	1.00	1.01	0.99	1.00	1.64	0.36	1.00	1.96	0.04	1.00	1.13	0.87
Final Sat.:	1750	1912	1786	1750	3052	647	1750	3628	72	1750	2140	1558
Capacity Analysis Module:												
Vol/Sat:	0.01	0.14	0.14	0.25	0.04	0.04	0.01	0.21	0.21	0.17	0.17	0.17
Crit Moves:	****			****			****			****		
Green Time:	11.2	10.0	10.0	17.1	16.0	16.0	9.9	14.1	14.1	11.7	16.0	16.0
Volume/Cap:	0.08	0.93	0.93	0.95	0.18	0.18	0.09	0.95	0.95	0.95	0.71	0.71
Delay/Veh:	22.7	49.5	49.5	54.1	19.4	19.4	23.8	46.5	46.5	64.9	24.9	24.9
User DelAdj:	1.00	1.00	1.00	1.00	1.00	1.00	1.00	1.00	1.00	1.00	1.00	1.00
AdjDel/Veh:	22.7	49.5	49.5	54.1	19.4	19.4	23.8	46.5	46.5	64.9	24.9	24.9
LOS by Move:	C	D	D	D	B	B	C	D	D	E	C	C
HCM2k95thQ:	1	13	13	26	3	3	1	18	18	16	12	12

Note: Queue reported is the number of cars per lane.

BART Phase II Extension Project

Level Of Service Computation Report
2000 HCM Operations (Future Volume Alternative)
AM - 2035 Project Conditions

Intersection #3264: AUTUMN/SAN FERNANDO

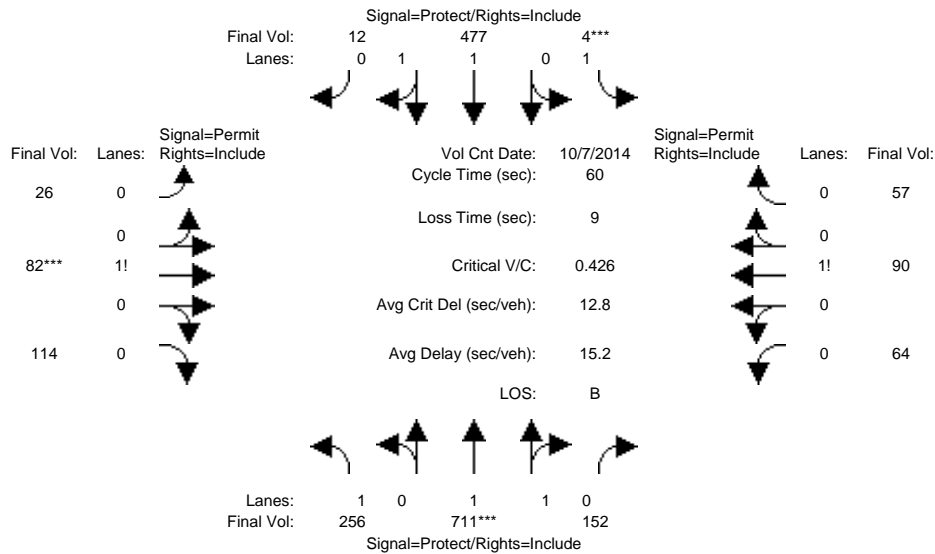

Approach:	North Bound			South Bound			East Bound			West Bound		
	L	T	R	L	T	R	L	T	R	L	T	R
Min. Green:	7	10	10	7	10	10	10	10	10	10	10	10
Y+R:	4.0	4.0	4.0	4.0	4.0	4.0	4.0	4.0	4.0	4.0	4.0	4.0

Volume Module: >> Count Date: 7 Oct 2014 <<

Base Vol:	256	711	152	4	477	12	26	82	114	64	90	57
Growth Adj:	1.00	1.00	1.00	1.00	1.00	1.00	1.00	1.00	1.00	1.00	1.00	1.00
Initial Bse:	256	711	152	4	477	12	26	82	114	64	90	57
Added Vol:	0	0	0	0	0	0	0	0	0	0	0	0
PasserByVol:	0	0	0	0	0	0	0	0	0	0	0	0
Initial Fut:	256	711	152	4	477	12	26	82	114	64	90	57
User Adj:	1.00	1.00	1.00	1.00	1.00	1.00	1.00	1.00	1.00	1.00	1.00	1.00
PHF Adj:	1.00	1.00	1.00	1.00	1.00	1.00	1.00	1.00	1.00	1.00	1.00	1.00
PHF Volume:	256	711	152	4	477	12	26	82	114	64	90	57
Reduct Vol:	0	0	0	0	0	0	0	0	0	0	0	0
Reduced Vol:	256	711	152	4	477	12	26	82	114	64	90	57
PCE Adj:	1.00	1.00	1.00	1.00	1.00	1.00	1.00	1.00	1.00	1.00	1.00	1.00
MLF Adj:	1.00	1.00	1.00	1.00	1.00	1.00	1.00	1.00	1.00	1.00	1.00	1.00
Final Volume:	256	711	152	4	477	12	26	82	114	64	90	57

Saturation Flow Module:

Sat/Lane:	1900	1900	1900	1900	1900	1900	1900	1900	1900	1900	1900	1900
Adjustment:	0.92	0.98	0.95	0.92	0.97	0.95	0.92	0.92	0.92	0.92	0.92	0.92
Lanes:	1.00	1.64	0.36	1.00	1.95	0.05	0.12	0.37	0.51	0.30	0.43	0.27
Final Sat.:	1750	3048	652	1750	3609	91	205	646	899	531	746	473

Capacity Analysis Module:

Vol/Sat:	0.15	0.23	0.23	0.00	0.13	0.13	0.13	0.13	0.13	0.12	0.12	0.12
Crit Moves:	****	****	****	****	****	****	****	****	****	****	****	****
Green Time:	16.6	28.5	28.5	7.0	18.9	18.9	15.5	15.5	15.5	15.5	15.5	15.5
Volume/Cap:	0.53	0.49	0.49	0.02	0.42	0.42	0.49	0.49	0.49	0.47	0.47	0.47
Delay/Veh:	19.5	11.0	11.0	23.5	16.5	16.5	19.7	19.7	19.7	19.5	19.5	19.5
User DelAdj:	1.00	1.00	1.00	1.00	1.00	1.00	1.00	1.00	1.00	1.00	1.00	1.00
AdjDel/Veh:	19.5	11.0	11.0	23.5	16.5	16.5	19.7	19.7	19.7	19.5	19.5	19.5
LOS by Move:	B	B	B	C	B	B	B	B	B	B	B	B
HCM2k95thQ:	9	11	11	0	8	8	9	9	9	7	7	7

Note: Queue reported is the number of cars per lane.

BART Phase II Extension Project

Level Of Service Computation Report
2000 HCM Operations (Future Volume Alternative)
PM - 2035 Project Conditions

Intersection #3264: AUTUMN/SAN FERNANDO

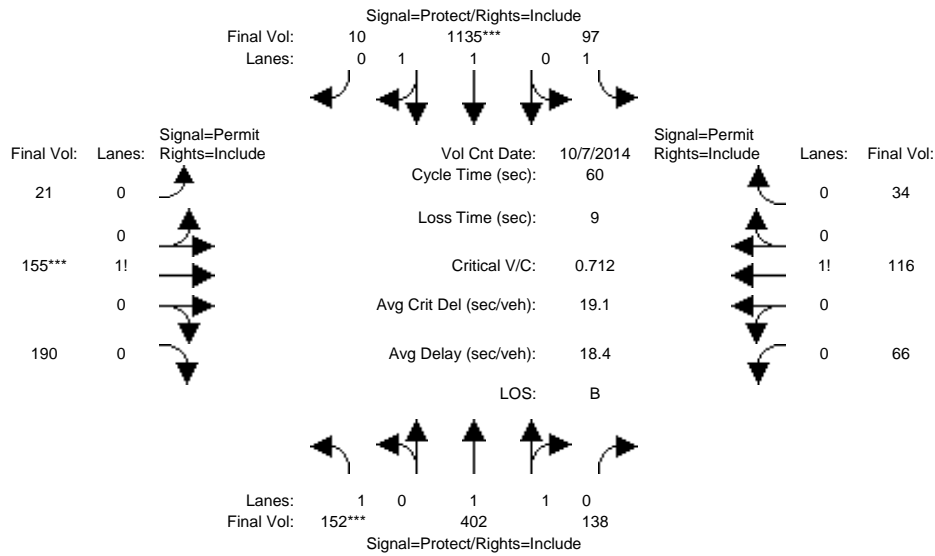

Approach:	North Bound			South Bound			East Bound			West Bound		
	L	T	R	L	T	R	L	T	R	L	T	R
Min. Green:	7	10	10	7	10	10	10	10	10	10	10	10
Y+R:	4.0	4.0	4.0	4.0	4.0	4.0	4.0	4.0	4.0	4.0	4.0	4.0

Volume Module: >> Count Date: 7 Oct 2014 <<

Base Vol:	152	402	138	97	1135	10	21	155	190	66	116	34
Growth Adj:	1.00	1.00	1.00	1.00	1.00	1.00	1.00	1.00	1.00	1.00	1.00	1.00
Initial Bse:	152	402	138	97	1135	10	21	155	190	66	116	34
Added Vol:	0	0	0	0	0	0	0	0	0	0	0	0
PasserByVol:	0	0	0	0	0	0	0	0	0	0	0	0
Initial Fut:	152	402	138	97	1135	10	21	155	190	66	116	34
User Adj:	1.00	1.00	1.00	1.00	1.00	1.00	1.00	1.00	1.00	1.00	1.00	1.00
PHF Adj:	1.00	1.00	1.00	1.00	1.00	1.00	1.00	1.00	1.00	1.00	1.00	1.00
PHF Volume:	152	402	138	97	1135	10	21	155	190	66	116	34
Reduct Vol:	0	0	0	0	0	0	0	0	0	0	0	0
Reduced Vol:	152	402	138	97	1135	10	21	155	190	66	116	34
PCE Adj:	1.00	1.00	1.00	1.00	1.00	1.00	1.00	1.00	1.00	1.00	1.00	1.00
MLF Adj:	1.00	1.00	1.00	1.00	1.00	1.00	1.00	1.00	1.00	1.00	1.00	1.00
FinalVolume:	152	402	138	97	1135	10	21	155	190	66	116	34

Saturation Flow Module:

Sat/Lane:	1900	1900	1900	1900	1900	1900	1900	1900	1900	1900	1900	1900
Adjustment:	0.92	0.98	0.95	0.92	0.97	0.95	0.92	0.92	0.92	0.92	0.92	0.92
Lanes:	1.00	1.47	0.53	1.00	1.98	0.02	0.06	0.42	0.52	0.30	0.54	0.16
Final Sat.:	1750	2754	945	1750	3668	32	100	741	908	535	940	275

Capacity Analysis Module:

Vol/Sat:	0.09	0.15	0.15	0.06	0.31	0.31	0.21	0.21	0.21	0.12	0.12	0.12
Crit Moves:	****			****			****					
Green Time:	7.3	19.6	19.6	13.7	26.1	26.1	17.6	17.6	17.6	17.6	17.6	17.6
Volume/Cap:	0.71	0.45	0.45	0.24	0.71	0.71	0.71	0.71	0.71	0.42	0.42	0.42
Delay/Veh:	36.1	16.2	16.2	19.2	15.4	15.4	23.6	23.6	23.6	17.6	17.6	17.6
User DelAdj:	1.00	1.00	1.00	1.00	1.00	1.00	1.00	1.00	1.00	1.00	1.00	1.00
AdjDel/Veh:	36.1	16.2	16.2	19.2	15.4	15.4	23.6	23.6	23.6	17.6	17.6	17.6
LOS by Move:	D	B	B	B	B	B	C	C	C	B	B	B
HCM2k95thQ:	6	8	8	4	19	19	15	15	15	7	7	7

Note: Queue reported is the number of cars per lane.

BART Phase II Extension Project

Level Of Service Computation Report
2000 HCM Operations (Future Volume Alternative)
AM - 2035 Project Conditions

Intersection #3266: AUZERAIS/BIRD

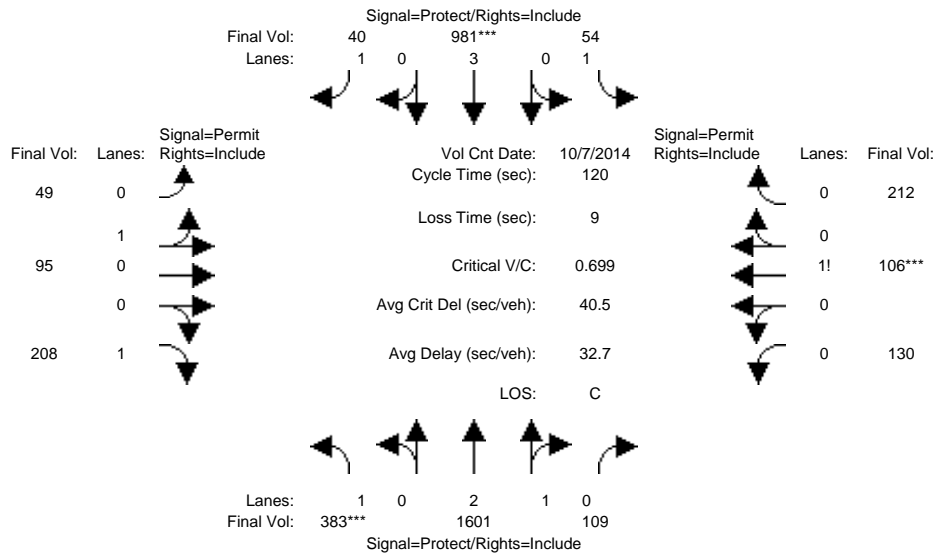

Approach:	North Bound			South Bound			East Bound			West Bound		
	L	T	R	L	T	R	L	T	R	L	T	R
Min. Green:	7	10	10	7	10	10	10	10	10	10	10	10
Y+R:	4.0	4.0	4.0	4.0	4.0	4.0	4.0	4.0	4.0	4.0	4.0	4.0
Volume Module: >> Count Date: 7 Oct 2014 <<												
Base Vol:	383	1601	109	54	981	40	49	95	208	130	106	212
Growth Adj:	1.00	1.00	1.00	1.00	1.00	1.00	1.00	1.00	1.00	1.00	1.00	1.00
Initial Bse:	383	1601	109	54	981	40	49	95	208	130	106	212
Added Vol:	0	0	0	0	0	0	0	0	0	0	0	0
PasserByVol:	0	0	0	0	0	0	0	0	0	0	0	0
Initial Fut:	383	1601	109	54	981	40	49	95	208	130	106	212
User Adj:	1.00	1.00	1.00	1.00	1.00	1.00	1.00	1.00	1.00	1.00	1.00	1.00
PHF Adj:	1.00	1.00	1.00	1.00	1.00	1.00	1.00	1.00	1.00	1.00	1.00	1.00
PHF Volume:	383	1601	109	54	981	40	49	95	208	130	106	212
Reduct Vol:	0	0	0	0	0	0	0	0	0	0	0	0
Reduced Vol:	383	1601	109	54	981	40	49	95	208	130	106	212
PCE Adj:	1.00	1.00	1.00	1.00	1.00	1.00	1.00	1.00	1.00	1.00	1.00	1.00
MLF Adj:	1.00	1.00	1.00	1.00	1.00	1.00	1.00	1.00	1.00	1.00	1.00	1.00
Final Volume:	383	1601	109	54	981	40	49	95	208	130	106	212
Saturation Flow Module:												
Sat/Lane:	1900	1900	1900	1900	1900	1900	1900	1900	1900	1900	1900	1900
Adjustment:	0.92	0.98	0.95	0.92	1.00	0.92	0.95	0.95	0.92	0.92	0.92	0.92
Lanes:	1.00	2.80	0.20	1.00	3.00	1.00	0.34	0.66	1.00	0.29	0.24	0.47
Final Sat.:	1750	5243	357	1750	5700	1750	612	1187	1750	508	414	828
Capacity Analysis Module:												
Vol/Sat:	0.22	0.31	0.31	0.03	0.17	0.02	0.08	0.08	0.12	0.26	0.26	0.26
Crit Moves:	****				****						****	
Green Time:	37.5	56.3	56.3	10.8	29.5	29.5	43.9	43.9	43.9	43.9	43.9	43.9
Volume/Cap:	0.70	0.65	0.65	0.34	0.70	0.09	0.22	0.22	0.32	0.70	0.70	0.70
Delay/Veh:	40.3	24.9	24.9	52.6	42.8	35.0	26.4	26.4	27.7	35.9	35.9	35.9
User DelAdj:	1.00	1.00	1.00	1.00	1.00	1.00	1.00	1.00	1.00	1.00	1.00	1.00
AdjDel/Veh:	40.3	24.9	24.9	52.6	42.8	35.0	26.4	26.4	27.7	35.9	35.9	35.9
LOS by Move:	D	C	C	D	D	C	C	C	C	D	D	D
HCM2k95thQ:	24	28	28	4	20	2	7	7	11	27	27	27

Note: Queue reported is the number of cars per lane.

BART Phase II Extension Project

Level Of Service Computation Report
2000 HCM Operations (Future Volume Alternative)
PM - 2035 Project Conditions

Intersection #3266: AUZERAIS/BIRD

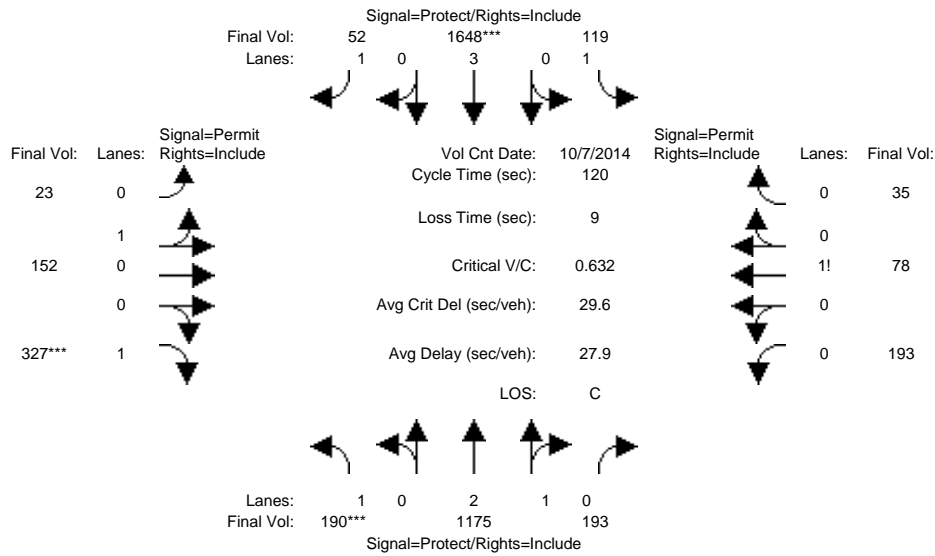

Approach:	North Bound			South Bound			East Bound			West Bound		
	L	T	R	L	T	R	L	T	R	L	T	R
Min. Green:	7	10	10	7	10	10	10	10	10	10	10	10
Y+R:	4.0	4.0	4.0	4.0	4.0	4.0	4.0	4.0	4.0	4.0	4.0	4.0

Volume Module:	>>	Count	Date:	7 Oct 2014	<<							
Base Vol:	190	1175	193	119	1648	52	23	152	327	193	78	35
Growth Adj:	1.00	1.00	1.00	1.00	1.00	1.00	1.00	1.00	1.00	1.00	1.00	1.00
Initial Bse:	190	1175	193	119	1648	52	23	152	327	193	78	35
Added Vol:	0	0	0	0	0	0	0	0	0	0	0	0
PasserByVol:	0	0	0	0	0	0	0	0	0	0	0	0
Initial Fut:	190	1175	193	119	1648	52	23	152	327	193	78	35
User Adj:	1.00	1.00	1.00	1.00	1.00	1.00	1.00	1.00	1.00	1.00	1.00	1.00
PHF Adj:	1.00	1.00	1.00	1.00	1.00	1.00	1.00	1.00	1.00	1.00	1.00	1.00
PHF Volume:	190	1175	193	119	1648	52	23	152	327	193	78	35
Reduct Vol:	0	0	0	0	0	0	0	0	0	0	0	0
Reduced Vol:	190	1175	193	119	1648	52	23	152	327	193	78	35
PCE Adj:	1.00	1.00	1.00	1.00	1.00	1.00	1.00	1.00	1.00	1.00	1.00	1.00
MLF Adj:	1.00	1.00	1.00	1.00	1.00	1.00	1.00	1.00	1.00	1.00	1.00	1.00
FinalVolume:	190	1175	193	119	1648	52	23	152	327	193	78	35

Saturation Flow Module:	Sat/Lane:	0.92	0.99	0.95	0.92	1.00	0.92	0.95	0.95	0.92	0.92	0.92	0.92
Adjustment:	0.92	0.99	0.95	0.92	1.00	0.92	0.95	0.95	0.92	0.92	0.92	0.92	0.92
Lanes:	1.00	2.56	0.44	1.00	3.00	1.00	0.13	0.87	1.00	0.64	0.25	0.11	
Final Sat.:	1750	4809	790	1750	5700	1750	237	1563	1750	1104	446	200	

Capacity Analysis Module:	Vol/Sat:	0.11	0.24	0.24	0.07	0.29	0.03	0.10	0.10	0.19	0.17	0.17	0.17
Crit Moves:	****				****					****			
Green Time:	20.6	59.1	59.1	16.4	54.9	54.9	35.5	35.5	35.5	35.5	35.5	35.5	35.5
Volume/Cap:	0.63	0.50	0.50	0.50	0.63	0.06	0.33	0.33	0.63	0.59	0.59	0.59	0.59
Delay/Veh:	50.5	20.6	20.6	49.6	25.3	18.2	33.3	33.3	39.1	37.9	37.9	37.9	37.9
User DelAdj:	1.00	1.00	1.00	1.00	1.00	1.00	1.00	1.00	1.00	1.00	1.00	1.00	1.00
AdjDel/Veh:	50.5	20.6	20.6	49.6	25.3	18.2	33.3	33.3	39.1	37.9	37.9	37.9	37.9
LOS by Move:	D	C	C	D	C	B	C	C	D	D	D	D	D
HCM2k95thQ:	13	20	20	9	27	2	10	10	20	19	19	19	19

Note: Queue reported is the number of cars per lane.

BART Phase II Extension Project

Level Of Service Computation Report
2000 HCM Operations (Future Volume Alternative)
AM - 2035 Project Conditions

Intersection #3363: CAHILL/SANTA CLARA

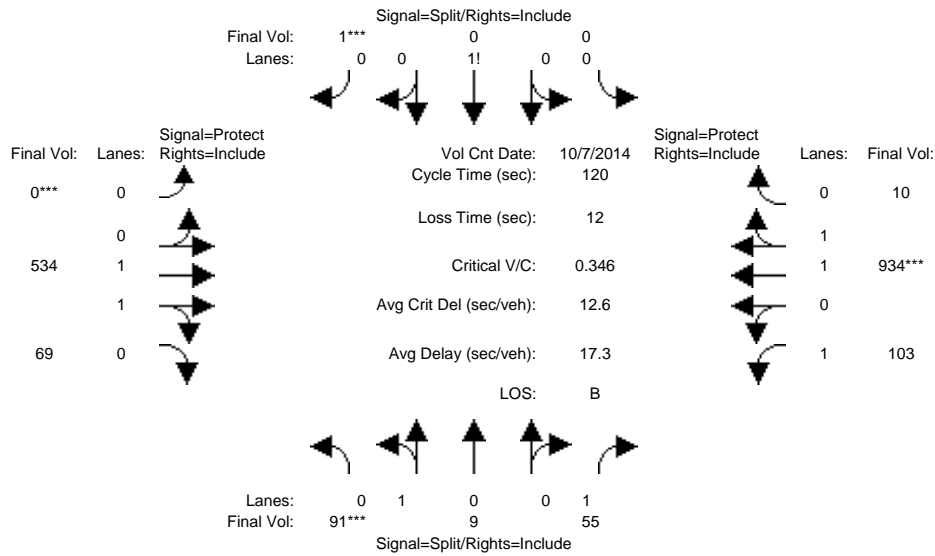

Approach:	North Bound			South Bound			East Bound			West Bound		
	L	T	R	L	T	R	L	T	R	L	T	R
Min. Green:	10	10	10	10	10	10	7	10	10	7	10	10
Y+R:	4.0	4.0	4.0	4.0	4.0	4.0	4.0	4.0	4.0	4.0	4.0	4.0
Volume Module: >> Count Date: 7 Oct 2014 <<												
Base Vol:	91	9	55	0	0	1	0	534	69	103	934	10
Growth Adj:	1.00	1.00	1.00	1.00	1.00	1.00	1.00	1.00	1.00	1.00	1.00	1.00
Initial Bse:	91	9	55	0	0	1	0	534	69	103	934	10
Added Vol:	0	0	0	0	0	0	0	0	0	0	0	0
PasserByVol:	0	0	0	0	0	0	0	0	0	0	0	0
Initial Fut:	91	9	55	0	0	1	0	534	69	103	934	10
User Adj:	1.00	1.00	1.00	1.00	1.00	1.00	1.00	1.00	1.00	1.00	1.00	1.00
PHF Adj:	1.00	1.00	1.00	1.00	1.00	1.00	1.00	1.00	1.00	1.00	1.00	1.00
PHF Volume:	91	9	55	0	0	1	0	534	69	103	934	10
Reduct Vol:	0	0	0	0	0	0	0	0	0	0	0	0
Reduced Vol:	91	9	55	0	0	1	0	534	69	103	934	10
PCE Adj:	1.00	1.00	1.00	1.00	1.00	1.00	1.00	1.00	1.00	1.00	1.00	1.00
MLF Adj:	1.00	1.00	1.00	1.00	1.00	1.00	1.00	1.00	1.00	1.00	1.00	1.00
FinalVolume:	91	9	55	0	0	1	0	534	69	103	934	10
Saturation Flow Module:												
Sat/Lane:	1900	1900	1900	1900	1900	1900	1900	1900	1900	1900	1900	1900
Adjustment:	0.95	0.95	0.92	0.92	1.00	0.92	0.92	0.98	0.95	0.92	0.97	0.95
Lanes:	0.91	0.09	1.00	0.00	0.00	1.00	0.00	1.76	0.24	1.00	1.98	0.02
Final Sat.:	1638	162	1750	0	0	1750	0	3276	423	1750	3661	39
Capacity Analysis Module:												
Vol/Sat:	0.06	0.06	0.03	0.00	0.00	0.00	0.00	0.16	0.16	0.06	0.26	0.26
Crit Moves:	****					****	****				****	
Green Time:	17.5	17.5	17.5	0.0	0.0	10.0	0.0	59.1	59.1	21.4	80.5	80.5
Volume/Cap:	0.38	0.38	0.22	0.00	0.00	0.01	0.00	0.33	0.33	0.33	0.38	0.38
Delay/Veh:	47.3	47.3	45.6	0.0	0.0	50.5	0.0	18.6	18.6	43.7	8.8	8.8
User DelAdj:	1.00	1.00	1.00	1.00	1.00	1.00	1.00	1.00	1.00	1.00	1.00	1.00
AdjDel/Veh:	47.3	47.3	45.6	0.0	0.0	50.5	0.0	18.6	18.6	43.7	8.8	8.8
LOS by Move:	D	D	D	A	A	D	A	B	B	D	A	A
HCM2k95thQ:	8	8	4	0	0	0	0	13	13	7	15	15

Note: Queue reported is the number of cars per lane.

BART Phase II Extension Project

Level Of Service Computation Report
2000 HCM Operations (Future Volume Alternative)
PM - 2035 Project Conditions

Intersection #3363: CAHILL/SANTA CLARA

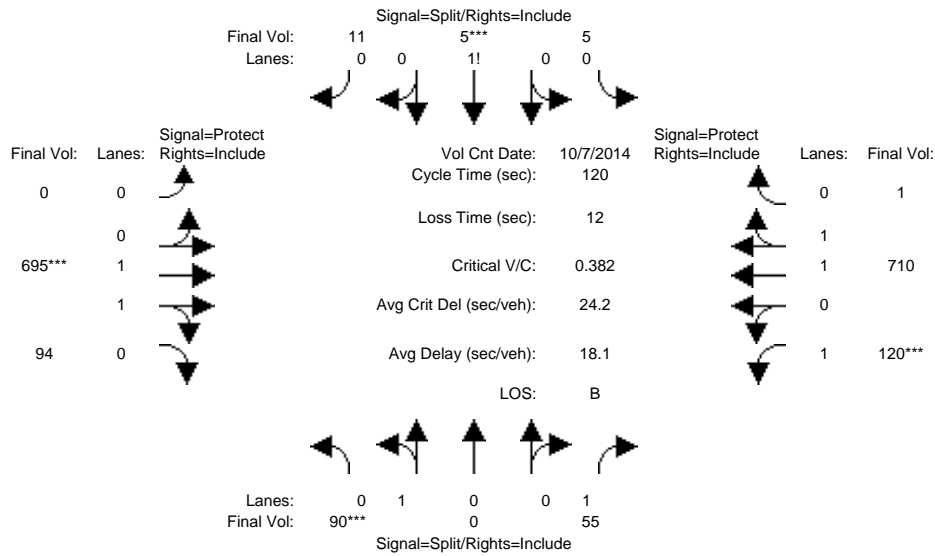

Approach:	North Bound			South Bound			East Bound			West Bound		
	L	T	R	L	T	R	L	T	R	L	T	R
Min. Green:	10	10	10	10	10	10	7	10	10	7	10	10
Y+R:	4.0	4.0	4.0	4.0	4.0	4.0	4.0	4.0	4.0	4.0	4.0	4.0
Volume Module: >> Count Date: 7 Oct 2014 <<												
Base Vol:	90	0	55	5	5	11	0	695	94	120	710	1
Growth Adj:	1.00	1.00	1.00	1.00	1.00	1.00	1.00	1.00	1.00	1.00	1.00	1.00
Initial Bse:	90	0	55	5	5	11	0	695	94	120	710	1
Added Vol:	0	0	0	0	0	0	0	0	0	0	0	0
PasserByVol:	0	0	0	0	0	0	0	0	0	0	0	0
Initial Fut:	90	0	55	5	5	11	0	695	94	120	710	1
User Adj:	1.00	1.00	1.00	1.00	1.00	1.00	1.00	1.00	1.00	1.00	1.00	1.00
PHF Adj:	1.00	1.00	1.00	1.00	1.00	1.00	1.00	1.00	1.00	1.00	1.00	1.00
PHF Volume:	90	0	55	5	5	11	0	695	94	120	710	1
Reduct Vol:	0	0	0	0	0	0	0	0	0	0	0	0
Reduced Vol:	90	0	55	5	5	11	0	695	94	120	710	1
PCE Adj:	1.00	1.00	1.00	1.00	1.00	1.00	1.00	1.00	1.00	1.00	1.00	1.00
MLF Adj:	1.00	1.00	1.00	1.00	1.00	1.00	1.00	1.00	1.00	1.00	1.00	1.00
FinalVolume:	90	0	55	5	5	11	0	695	94	120	710	1
Saturation Flow Module:												
Sat/Lane:	1900	1900	1900	1900	1900	1900	1900	1900	1900	1900	1900	1900
Adjustment:	0.95	0.95	0.92	0.92	0.92	0.92	0.92	0.98	0.95	0.92	0.97	0.95
Lanes:	1.00	0.00	1.00	0.24	0.24	0.52	0.00	1.76	0.24	1.00	1.99	0.01
Final Sat.:	1800	0	1750	417	417	917	0	3259	441	1750	3695	5
Capacity Analysis Module:												
Vol/Sat:	0.05	0.00	0.03	0.01	0.01	0.01	0.00	0.21	0.21	0.07	0.19	0.19
Crit Moves:	****			****			****			****		
Green Time:	14.8	0.0	14.8	10.0	10.0	10.0	0.0	63.0	63.0	20.3	83.2	83.2
Volume/Cap:	0.41	0.00	0.26	0.14	0.14	0.14	0.00	0.41	0.41	0.41	0.28	0.28
Delay/Veh:	49.8	0.0	48.3	51.5	51.5	51.5	0.0	17.4	17.4	45.4	7.0	7.0
User DelAdj:	1.00	1.00	1.00	1.00	1.00	1.00	1.00	1.00	1.00	1.00	1.00	1.00
AdjDel/Veh:	49.8	0.0	48.3	51.5	51.5	51.5	0.0	17.4	17.4	45.4	7.0	7.0
LOS by Move:	D	A	D	D	D	D	A	B	B	D	A	A
HCM2k95thQ:	7	0	4	2	2	2	0	16	16	8	10	10

Note: Queue reported is the number of cars per lane.

BART Phase II Extension Project

Level Of Service Computation Report
2000 HCM Operations (Future Volume Alternative)
AM - 2035 Project Conditions

Intersection #3445: DELMAS/PARK *

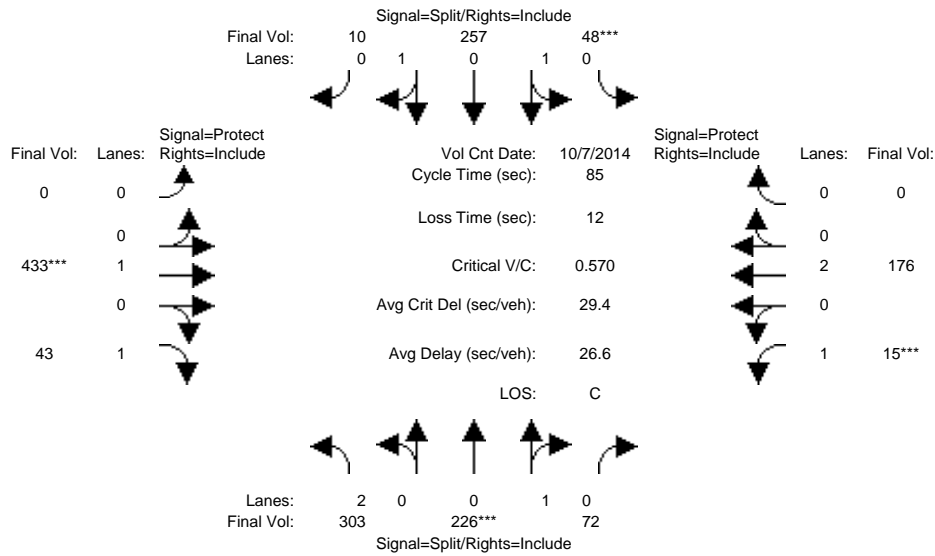

Approach:	North Bound			South Bound			East Bound			West Bound		
	L	T	R	L	T	R	L	T	R	L	T	R
Min. Green:	10	10	10	10	10	10	0	10	10	7	10	0
Y+R:	4.0	4.0	4.0	4.0	4.0	4.0	4.0	4.0	4.0	4.0	4.0	4.0
Volume Module: >> Count Date: 7 Oct 2014 <<												
Base Vol:	303	226	72	48	257	10	0	433	43	15	176	0
Growth Adj:	1.00	1.00	1.00	1.00	1.00	1.00	1.00	1.00	1.00	1.00	1.00	1.00
Initial Bse:	303	226	72	48	257	10	0	433	43	15	176	0
Added Vol:	0	0	0	0	0	0	0	0	0	0	0	0
PasserByVol:	0	0	0	0	0	0	0	0	0	0	0	0
Initial Fut:	303	226	72	48	257	10	0	433	43	15	176	0
User Adj:	1.00	1.00	1.00	1.00	1.00	1.00	1.00	1.00	1.00	1.00	1.00	1.00
PHF Adj:	1.00	1.00	1.00	1.00	1.00	1.00	1.00	1.00	1.00	1.00	1.00	1.00
PHF Volume:	303	226	72	48	257	10	0	433	43	15	176	0
Reduct Vol:	0	0	0	0	0	0	0	0	0	0	0	0
Reduced Vol:	303	226	72	48	257	10	0	433	43	15	176	0
PCE Adj:	1.00	1.00	1.00	1.00	1.00	1.00	1.00	1.00	1.00	1.00	1.00	1.00
MLF Adj:	1.00	1.00	1.00	1.00	1.00	1.00	1.00	1.00	1.00	1.00	1.00	1.00
FinalVolume:	303	226	72	48	257	10	0	433	43	15	176	0
Saturation Flow Module:												
Sat/Lane:	1900	1900	1900	1900	1900	1900	1900	1900	1900	1900	1900	1900
Adjustment:	0.83	0.95	0.95	0.95	0.95	0.95	0.92	1.00	0.92	0.92	1.00	0.92
Lanes:	2.00	0.76	0.24	0.30	1.64	0.06	0.00	1.00	1.00	1.00	2.00	0.00
Final Sat.:	3150	1365	435	549	2937	114	0	1900	1750	1750	3800	0
Capacity Analysis Module:												
Vol/Sat:	0.10	0.17	0.17	0.09	0.09	0.09	0.00	0.23	0.02	0.01	0.05	0.00
Crit Moves:	****			****			****			****		
Green Time:	22.7	22.7	22.7	12.0	12.0	12.0	0.0	31.3	31.3	7.0	38.3	0.0
Volume/Cap:	0.36	0.62	0.62	0.62	0.62	0.62	0.00	0.62	0.07	0.10	0.10	0.00
Delay/Veh:	25.5	29.8	29.8	36.7	36.7	36.7	0.0	23.7	17.5	36.4	13.5	0.0
User DelAdj:	1.00	1.00	1.00	1.00	1.00	1.00	1.00	1.00	1.00	1.00	1.00	1.00
AdjDel/Veh:	25.5	29.8	29.8	36.7	36.7	36.7	0.0	23.7	17.5	36.4	13.5	0.0
LOS by Move:	C	C	C	D	D	D	A	C	B	D	B	A
HCM2k95thQ:	8	15	15	8	8	8	0	17	2	1	3	0

Note: Queue reported is the number of cars per lane.

BART Phase II Extension Project

Level Of Service Computation Report
2000 HCM Operations (Future Volume Alternative)
PM - 2035 Project Conditions

Intersection #3445: DELMAS/PARK *

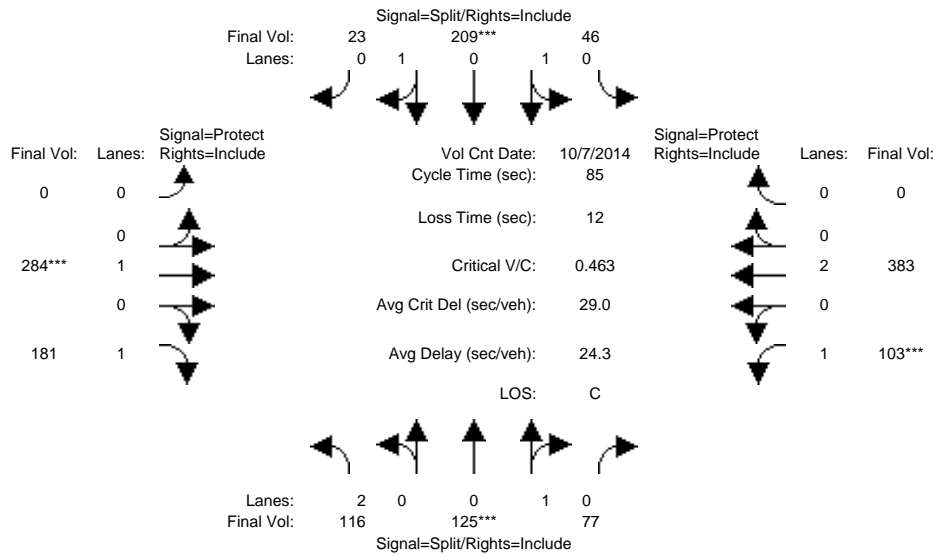

Approach:	North Bound			South Bound			East Bound			West Bound		
	L	T	R	L	T	R	L	T	R	L	T	R
Min. Green:	10	10	10	10	10	10	0	10	10	7	10	0
Y+R:	4.0	4.0	4.0	4.0	4.0	4.0	4.0	4.0	4.0	4.0	4.0	4.0
Volume Module: >> Count Date: 7 Oct 2014 <<												
Base Vol:	116	125	77	46	209	23	0	284	181	103	383	0
Growth Adj:	1.00	1.00	1.00	1.00	1.00	1.00	1.00	1.00	1.00	1.00	1.00	1.00
Initial Bse:	116	125	77	46	209	23	0	284	181	103	383	0
Added Vol:	0	0	0	0	0	0	0	0	0	0	0	0
PasserByVol:	0	0	0	0	0	0	0	0	0	0	0	0
Initial Fut:	116	125	77	46	209	23	0	284	181	103	383	0
User Adj:	1.00	1.00	1.00	1.00	1.00	1.00	1.00	1.00	1.00	1.00	1.00	1.00
PHF Adj:	1.00	1.00	1.00	1.00	1.00	1.00	1.00	1.00	1.00	1.00	1.00	1.00
PHF Volume:	116	125	77	46	209	23	0	284	181	103	383	0
Reduct Vol:	0	0	0	0	0	0	0	0	0	0	0	0
Reduced Vol:	116	125	77	46	209	23	0	284	181	103	383	0
PCE Adj:	1.00	1.00	1.00	1.00	1.00	1.00	1.00	1.00	1.00	1.00	1.00	1.00
MLF Adj:	1.00	1.00	1.00	1.00	1.00	1.00	1.00	1.00	1.00	1.00	1.00	1.00
FinalVolume:	116	125	77	46	209	23	0	284	181	103	383	0
Saturation Flow Module:												
Sat/Lane:	1900	1900	1900	1900	1900	1900	1900	1900	1900	1900	1900	1900
Adjustment:	0.83	0.95	0.95	0.95	0.95	0.95	0.92	1.00	0.92	0.92	1.00	0.92
Lanes:	2.00	0.62	0.38	0.33	1.50	0.17	0.00	1.00	1.00	1.00	2.00	0.00
Final Sat.:	3150	1114	686	596	2706	298	0	1900	1750	1750	3800	0
Capacity Analysis Module:												
Vol/Sat:	0.04	0.11	0.11	0.08	0.08	0.08	0.00	0.15	0.10	0.06	0.10	0.00
Crit Moves:	****	****	****	****	****	****	****	****	****	****	****	****
Green Time:	20.6	20.6	20.6	14.2	14.2	14.2	0.0	27.4	27.4	10.8	38.2	0.0
Volume/Cap:	0.15	0.46	0.46	0.46	0.46	0.46	0.00	0.46	0.32	0.46	0.22	0.00
Delay/Veh:	25.4	28.3	28.3	32.5	32.5	32.5	0.0	23.5	22.1	35.9	14.4	0.0
User DelAdj:	1.00	1.00	1.00	1.00	1.00	1.00	1.00	1.00	1.00	1.00	1.00	1.00
AdjDel/Veh:	25.4	28.3	28.3	32.5	32.5	32.5	0.0	23.5	22.1	35.9	14.4	0.0
LOS by Move:	C	C	C	C	C	C	A	C	C	D	B	A
HCM2k95thQ:	3	10	10	7	7	7	0	11	7	5	6	0

Note: Queue reported is the number of cars per lane.

BART Phase II Extension Project

Level Of Service Computation Report
2000 HCM Operations (Future Volume Alternative)
AM - 2035 Project Conditions

Intersection #3552: FRUITDALE/MERIDIAN

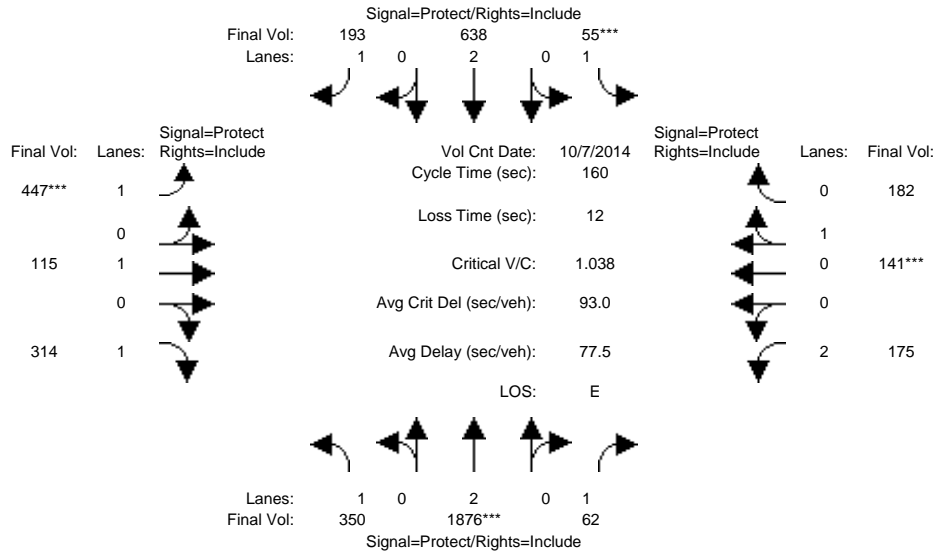

Approach:	North Bound			South Bound			East Bound			West Bound		
Movement:	L	T	R	L	T	R	L	T	R	L	T	R
Min. Green:	7	10	10	7	10	10	7	10	10	7	10	10
Y+R:	4.0	4.0	4.0	4.0	4.0	4.0	4.0	4.0	4.0	4.0	4.0	4.0
Volume Module: >> Count Date: 7 Oct 2014 <<												
Base Vol:	350	1876	62	55	638	193	447	115	314	175	141	182
Growth Adj:	1.00	1.00	1.00	1.00	1.00	1.00	1.00	1.00	1.00	1.00	1.00	1.00
Initial Bse:	350	1876	62	55	638	193	447	115	314	175	141	182
Added Vol:	0	0	0	0	0	0	0	0	0	0	0	0
PasserByVol:	0	0	0	0	0	0	0	0	0	0	0	0
Initial Fut:	350	1876	62	55	638	193	447	115	314	175	141	182
User Adj:	1.00	1.00	1.00	1.00	1.00	1.00	1.00	1.00	1.00	1.00	1.00	1.00
PHF Adj:	1.00	1.00	1.00	1.00	1.00	1.00	1.00	1.00	1.00	1.00	1.00	1.00
PHF Volume:	350	1876	62	55	638	193	447	115	314	175	141	182
Reduct Vol:	0	0	0	0	0	0	0	0	0	0	0	0
Reduced Vol:	350	1876	62	55	638	193	447	115	314	175	141	182
PCE Adj:	1.00	1.00	1.00	1.00	1.00	1.00	1.00	1.00	1.00	1.00	1.00	1.00
MLF Adj:	1.00	1.00	1.00	1.00	1.00	1.00	1.00	1.00	1.00	1.00	1.00	1.00
Final Volume:	350	1876	62	55	638	193	447	115	314	175	141	182
Saturation Flow Module:												
Sat/Lane:	1900	1900	1900	1900	1900	1900	1900	1900	1900	1900	1900	1900
Adjustment:	0.92	1.00	0.92	0.92	1.00	0.92	0.92	1.00	0.92	0.83	0.95	0.95
Lanes:	1.00	2.00	1.00	1.00	2.00	1.00	1.00	1.00	1.00	2.00	0.44	0.56
Final Sat.:	1750	3800	1750	1750	3800	1750	1750	1900	1750	3150	786	1014
Capacity Analysis Module:												
Vol/Sat:	0.20	0.49	0.04	0.03	0.17	0.11	0.26	0.06	0.18	0.06	0.18	0.18
Crit Moves:	****			****			****			****		
Green Time:	44.6	75.0	75.0	7.0	37.4	37.4	38.8	50.4	50.4	15.6	27.2	27.2
Volume/Cap:	0.72	1.05	0.08	0.72	0.72	0.47	1.05	0.19	0.57	0.57	1.05	1.05
Delay/Veh:	57.2	79.6	23.5	103.3	59.3	53.6	119.1	40.1	47.1	71.5	133	132.6
User DelAdj:	1.00	1.00	1.00	1.00	1.00	1.00	1.00	1.00	1.00	1.00	1.00	1.00
AdjDel/Veh:	57.2	79.6	23.5	103.3	59.3	53.6	119.1	40.1	47.1	71.5	133	132.6
LOS by Move:	E	E	C	F	E	D	F	D	D	E	F	F
HCM2k95thQ:	30	85	4	6	26	16	47	8	24	11	38	38

Note: Queue reported is the number of cars per lane.

BART Phase II Extension Project

Level Of Service Computation Report
 2000 HCM Operations (Future Volume Alternative)
 PM - 2035 Project Conditions

Intersection #3552: FRUITDALE/MERIDIAN

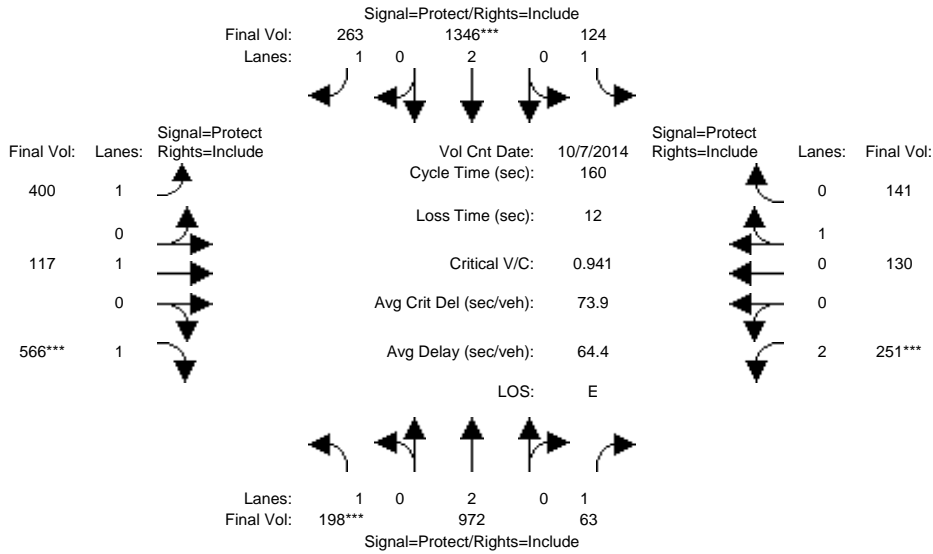

Approach:	North Bound			South Bound			East Bound			West Bound		
	L	T	R	L	T	R	L	T	R	L	T	R
Min. Green:	7	10	10	7	10	10	7	10	10	7	10	10
Y+R:	4.0	4.0	4.0	4.0	4.0	4.0	4.0	4.0	4.0	4.0	4.0	4.0

Volume Module:	>> Count Date: 7 Oct 2014 <<											
Base Vol:	198	972	63	124	1346	263	400	117	566	251	130	141
Growth Adj:	1.00	1.00	1.00	1.00	1.00	1.00	1.00	1.00	1.00	1.00	1.00	1.00
Initial Bse:	198	972	63	124	1346	263	400	117	566	251	130	141
Added Vol:	0	0	0	0	0	0	0	0	0	0	0	0
PasserByVol:	0	0	0	0	0	0	0	0	0	0	0	0
Initial Fut:	198	972	63	124	1346	263	400	117	566	251	130	141
User Adj:	1.00	1.00	1.00	1.00	1.00	1.00	1.00	1.00	1.00	1.00	1.00	1.00
PHF Adj:	1.00	1.00	1.00	1.00	1.00	1.00	1.00	1.00	1.00	1.00	1.00	1.00
PHF Volume:	198	972	63	124	1346	263	400	117	566	251	130	141
Reduct Vol:	0	0	0	0	0	0	0	0	0	0	0	0
Reduced Vol:	198	972	63	124	1346	263	400	117	566	251	130	141
PCE Adj:	1.00	1.00	1.00	1.00	1.00	1.00	1.00	1.00	1.00	1.00	1.00	1.00
MLF Adj:	1.00	1.00	1.00	1.00	1.00	1.00	1.00	1.00	1.00	1.00	1.00	1.00
FinalVolume:	198	972	63	124	1346	263	400	117	566	251	130	141

Saturation Flow Module:												
Sat/Lane:	1900	1900	1900	1900	1900	1900	1900	1900	1900	1900	1900	1900
Adjustment:	0.92	1.00	0.92	0.92	1.00	0.92	0.92	1.00	0.92	0.83	0.95	0.95
Lanes:	1.00	2.00	1.00	1.00	2.00	1.00	1.00	1.00	1.00	2.00	0.48	0.52
Final Sat.:	1750	3800	1750	1750	3800	1750	1750	1900	1750	3150	863	937

Capacity Analysis Module:												
Vol/Sat:	0.11	0.26	0.04	0.07	0.35	0.15	0.23	0.06	0.32	0.08	0.15	0.15
Crit Moves:	****				****				****	****		
Green Time:	19.2	62.2	62.2	17.2	60.2	60.2	41.3	55.0	55.0	13.5	27.2	27.2
Volume/Cap:	0.94	0.66	0.09	0.66	0.94	0.40	0.89	0.18	0.94	0.94	0.89	0.89
Delay/Veh:	115.3	41.2	31.1	76.8	60.6	37.0	75.5	36.9	74.1	112.1	89.8	89.8
User DelAdj:	1.00	1.00	1.00	1.00	1.00	1.00	1.00	1.00	1.00	1.00	1.00	1.00
AdjDel/Veh:	115.3	41.2	31.1	76.8	60.6	37.0	75.5	36.9	74.1	112.1	89.8	89.8
LOS by Move:	F	D	C	E	E	D	E	D	E	F	F	F
HCM2k95thQ:	25	33	4	12	55	18	36	7	50	19	29	29

Note: Queue reported is the number of cars per lane.

BART Phase II Extension Project

Level Of Service Computation Report
2000 HCM Operations (Future Volume Alternative)
AM - 2035 Project Conditions

Intersection #3553: FRUITDALE/SOUTHWEST

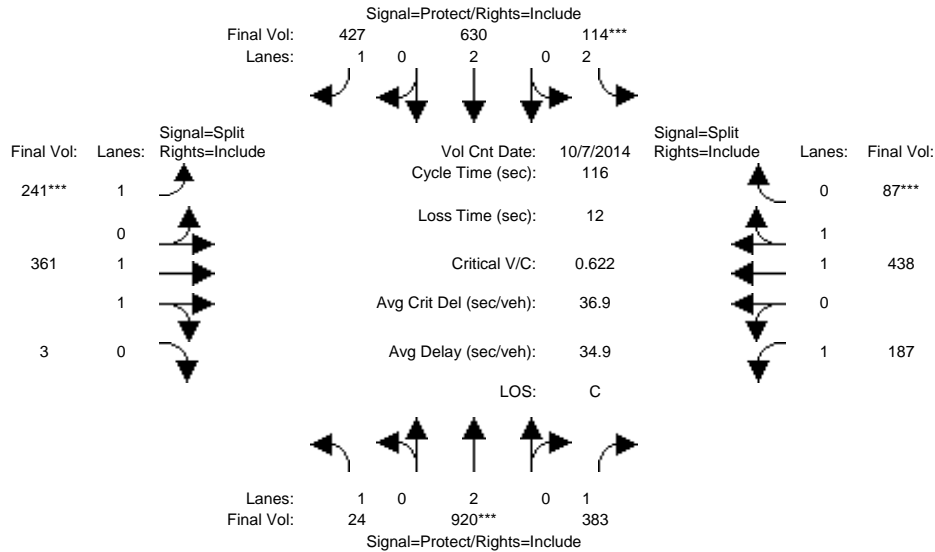

Approach:	North Bound			South Bound			East Bound			West Bound		
Movement:	L	T	R	L	T	R	L	T	R	L	T	R
Min. Green:	7	10	10	7	10	10	10	10	10	10	10	10
Y+R:	4.0	4.0	4.0	4.0	4.0	4.0	4.0	4.0	4.0	4.0	4.0	4.0
Volume Module: >> Count Date: 7 Oct 2014 <<												
Base Vol:	24	920	383	114	630	427	241	361	3	187	438	87
Growth Adj:	1.00	1.00	1.00	1.00	1.00	1.00	1.00	1.00	1.00	1.00	1.00	1.00
Initial Bse:	24	920	383	114	630	427	241	361	3	187	438	87
Added Vol:	0	0	0	0	0	0	0	0	0	0	0	0
PasserByVol:	0	0	0	0	0	0	0	0	0	0	0	0
Initial Fut:	24	920	383	114	630	427	241	361	3	187	438	87
User Adj:	1.00	1.00	1.00	1.00	1.00	1.00	1.00	1.00	1.00	1.00	1.00	1.00
PHF Adj:	1.00	1.00	1.00	1.00	1.00	1.00	1.00	1.00	1.00	1.00	1.00	1.00
PHF Volume:	24	920	383	114	630	427	241	361	3	187	438	87
Reduct Vol:	0	0	0	0	0	0	0	0	0	0	0	0
Reduced Vol:	24	920	383	114	630	427	241	361	3	187	438	87
PCE Adj:	1.00	1.00	1.00	1.00	1.00	1.00	1.00	1.00	1.00	1.00	1.00	1.00
MLF Adj:	1.00	1.00	1.00	1.00	1.00	1.00	1.00	1.00	1.00	1.00	1.00	1.00
Final Volume:	24	920	383	114	630	427	241	361	3	187	438	87
Saturation Flow Module:												
Sat/Lane:	1900	1900	1900	1900	1900	1900	1900	1900	1900	1900	1900	1900
Adjustment:	0.92	1.00	0.92	0.83	1.00	0.92	0.92	0.97	0.95	0.92	0.98	0.95
Lanes:	1.00	2.00	1.00	2.00	2.00	1.00	1.00	1.98	0.02	1.00	1.66	0.34
Final Sat.:	1750	3800	1750	3150	3800	1750	1750	3669	30	1750	3086	613
Capacity Analysis Module:												
Vol/Sat:	0.01	0.24	0.22	0.04	0.17	0.24	0.14	0.10	0.10	0.11	0.14	0.14
Crit Moves:	****			****			****			****		
Green Time:	10.3	45.0	45.0	7.0	41.7	41.7	25.6	25.6	25.6	26.4	26.4	26.4
Volume/Cap:	0.15	0.62	0.56	0.60	0.46	0.68	0.62	0.45	0.45	0.47	0.62	0.62
Delay/Veh:	49.3	29.5	28.9	58.4	28.8	34.5	44.0	39.5	39.5	39.6	41.8	41.8
User DelAdj:	1.00	1.00	1.00	1.00	1.00	1.00	1.00	1.00	1.00	1.00	1.00	1.00
AdjDel/Veh:	49.3	29.5	28.9	58.4	28.8	34.5	44.0	39.5	39.5	39.6	41.8	41.8
LOS by Move:	D	C	C	E	C	C	D	D	D	D	D	D
HCM2k95thQ:	2	24	21	7	16	26	16	11	11	11	15	15

Note: Queue reported is the number of cars per lane.

BART Phase II Extension Project

Level Of Service Computation Report
2000 HCM Operations (Future Volume Alternative)
PM - 2035 Project Conditions

Intersection #3553: FRUITDALE/SOUTHWEST

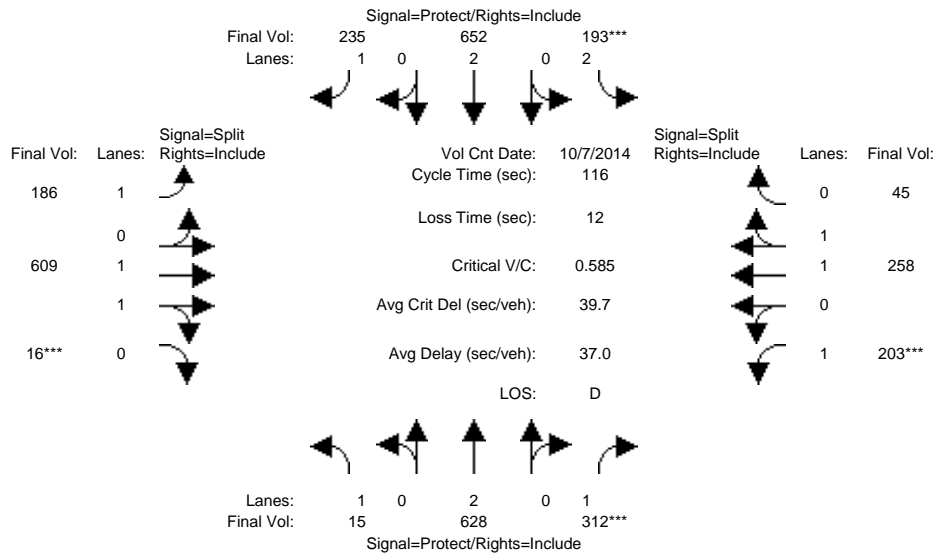

Approach:	North Bound			South Bound			East Bound			West Bound		
	L	T	R	L	T	R	L	T	R	L	T	R
Min. Green:	7	10	10	7	10	10	10	10	10	10	10	10
Y+R:	4.0	4.0	4.0	4.0	4.0	4.0	4.0	4.0	4.0	4.0	4.0	4.0
Volume Module: >> Count Date: 7 Oct 2014 <<												
Base Vol:	15	628	312	193	652	235	186	609	16	203	258	45
Growth Adj:	1.00	1.00	1.00	1.00	1.00	1.00	1.00	1.00	1.00	1.00	1.00	1.00
Initial Bse:	15	628	312	193	652	235	186	609	16	203	258	45
Added Vol:	0	0	0	0	0	0	0	0	0	0	0	0
PasserByVol:	0	0	0	0	0	0	0	0	0	0	0	0
Initial Fut:	15	628	312	193	652	235	186	609	16	203	258	45
User Adj:	1.00	1.00	1.00	1.00	1.00	1.00	1.00	1.00	1.00	1.00	1.00	1.00
PHF Adj:	1.00	1.00	1.00	1.00	1.00	1.00	1.00	1.00	1.00	1.00	1.00	1.00
PHF Volume:	15	628	312	193	652	235	186	609	16	203	258	45
Reduct Vol:	0	0	0	0	0	0	0	0	0	0	0	0
Reduced Vol:	15	628	312	193	652	235	186	609	16	203	258	45
PCE Adj:	1.00	1.00	1.00	1.00	1.00	1.00	1.00	1.00	1.00	1.00	1.00	1.00
MLF Adj:	1.00	1.00	1.00	1.00	1.00	1.00	1.00	1.00	1.00	1.00	1.00	1.00
FinalVolume:	15	628	312	193	652	235	186	609	16	203	258	45
Saturation Flow Module:												
Sat/Lane:	1900	1900	1900	1900	1900	1900	1900	1900	1900	1900	1900	1900
Adjustment:	0.92	1.00	0.92	0.83	1.00	0.92	0.92	0.97	0.95	0.92	0.98	0.95
Lanes:	1.00	2.00	1.00	2.00	2.00	1.00	1.00	1.95	0.05	1.00	1.69	0.31
Final Sat.:	1750	3800	1750	3150	3800	1750	1750	3605	95	1750	3150	549
Capacity Analysis Module:												
Vol/Sat:	0.01	0.17	0.18	0.06	0.17	0.13	0.11	0.17	0.17	0.12	0.08	0.08
Crit Moves:			****	****					****	****		
Green Time:	12.4	35.4	35.4	12.1	35.1	35.1	33.5	33.5	33.5	23.0	23.0	23.0
Volume/Cap:	0.08	0.54	0.58	0.58	0.57	0.44	0.37	0.58	0.58	0.58	0.41	0.41
Delay/Veh:	46.9	34.1	35.8	52.2	34.7	33.1	33.3	36.1	36.1	44.7	41.0	41.0
User DelAdj:	1.00	1.00	1.00	1.00	1.00	1.00	1.00	1.00	1.00	1.00	1.00	1.00
AdjDel/Veh:	46.9	34.1	35.8	52.2	34.7	33.1	33.3	36.1	36.1	44.7	41.0	41.0
LOS by Move:	D	C	D	D	C	C	C	D	D	D	D	D
HCM2k95thQ:	1	18	19	9	19	14	11	18	18	13	9	9

Note: Queue reported is the number of cars per lane.

BART Phase II Extension Project

Level Of Service Computation Report
2000 HCM Operations (Future Volume Alternative)
AM - 2035 Project Conditions

Intersection #3606: JULIAN/MONTGOMERY

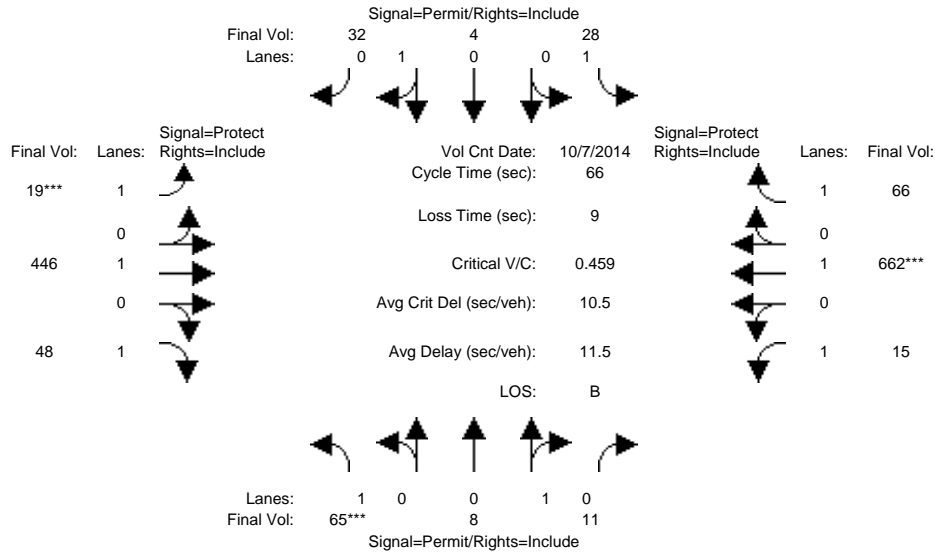

Approach:	North Bound			South Bound			East Bound			West Bound		
	L	T	R	L	T	R	L	T	R	L	T	R
Min. Green:	10	10	10	10	10	10	7	10	10	7	10	10
Y+R:	4.0	4.0	4.0	4.0	4.0	4.0	4.0	4.0	4.0	4.0	4.0	4.0
Volume Module: >> Count Date: 7 Oct 2014 <<												
Base Vol:	65	8	11	28	4	32	19	446	48	15	662	66
Growth Adj:	1.00	1.00	1.00	1.00	1.00	1.00	1.00	1.00	1.00	1.00	1.00	1.00
Initial Bse:	65	8	11	28	4	32	19	446	48	15	662	66
Added Vol:	0	0	0	0	0	0	0	0	0	0	0	0
PasserByVol:	0	0	0	0	0	0	0	0	0	0	0	0
Initial Fut:	65	8	11	28	4	32	19	446	48	15	662	66
User Adj:	1.00	1.00	1.00	1.00	1.00	1.00	1.00	1.00	1.00	1.00	1.00	1.00
PHF Adj:	1.00	1.00	1.00	1.00	1.00	1.00	1.00	1.00	1.00	1.00	1.00	1.00
PHF Volume:	65	8	11	28	4	32	19	446	48	15	662	66
Reduct Vol:	0	0	0	0	0	0	0	0	0	0	0	0
Reduced Vol:	65	8	11	28	4	32	19	446	48	15	662	66
PCE Adj:	1.00	1.00	1.00	1.00	1.00	1.00	1.00	1.00	1.00	1.00	1.00	1.00
MLF Adj:	1.00	1.00	1.00	1.00	1.00	1.00	1.00	1.00	1.00	1.00	1.00	1.00
FinalVolume:	65	8	11	28	4	32	19	446	48	15	662	66
Saturation Flow Module:												
Sat/Lane:	1900	1900	1900	1900	1900	1900	1900	1900	1900	1900	1900	1900
Adjustment:	0.92	0.95	0.95	0.92	0.95	0.95	0.92	1.00	0.92	0.92	1.00	0.92
Lanes:	1.00	0.42	0.58	1.00	0.11	0.89	1.00	1.00	1.00	1.00	1.00	1.00
Final Sat.:	1750	758	1042	1750	200	1600	1750	1900	1750	1750	1900	1750
Capacity Analysis Module:												
Vol/Sat:	0.04	0.01	0.01	0.02	0.02	0.02	0.01	0.23	0.03	0.01	0.35	0.04
Crit Moves:	****						****				****	
Green Time:	10.0	10.0	10.0	10.0	10.0	10.0	7.0	32.4	32.4	14.6	40.0	40.0
Volume/Cap:	0.25	0.07	0.07	0.11	0.13	0.13	0.10	0.48	0.06	0.04	0.57	0.06
Delay/Veh:	25.2	24.1	24.1	24.3	24.5	24.5	26.9	11.6	8.8	20.2	8.6	5.3
User DelAdj:	1.00	1.00	1.00	1.00	1.00	1.00	1.00	1.00	1.00	1.00	1.00	1.00
AdjDel/Veh:	25.2	24.1	24.1	24.3	24.5	24.5	26.9	11.6	8.8	20.2	8.6	5.3
LOS by Move:	C	C	C	C	C	C	C	B	A	C	A	A
HCM2k95thQ:	3	1	1	1	2	2	1	11	1	1	14	1

Note: Queue reported is the number of cars per lane.

BART Phase II Extension Project

Level Of Service Computation Report
2000 HCM Operations (Future Volume Alternative)
PM - 2035 Project Conditions

Intersection #3606: JULIAN/MONTGOMERY

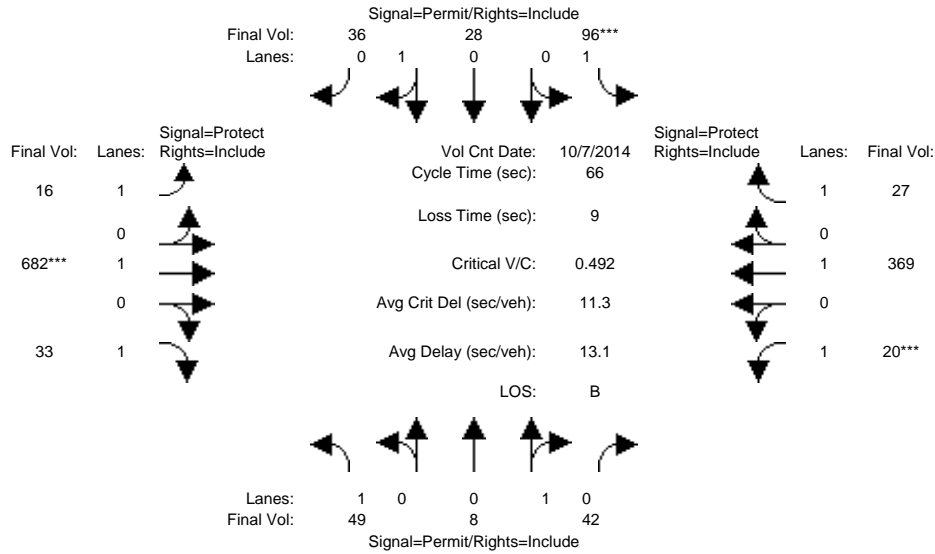

Approach:	North Bound			South Bound			East Bound			West Bound		
	L	T	R	L	T	R	L	T	R	L	T	R
Min. Green:	10	10	10	10	10	10	7	10	10	7	10	10
Y+R:	4.0	4.0	4.0	4.0	4.0	4.0	4.0	4.0	4.0	4.0	4.0	4.0
Volume Module: >> Count Date: 7 Oct 2014 <<												
Base Vol:	49	8	42	96	28	36	16	682	33	20	369	27
Growth Adj:	1.00	1.00	1.00	1.00	1.00	1.00	1.00	1.00	1.00	1.00	1.00	1.00
Initial Bse:	49	8	42	96	28	36	16	682	33	20	369	27
Added Vol:	0	0	0	0	0	0	0	0	0	0	0	0
PasserByVol:	0	0	0	0	0	0	0	0	0	0	0	0
Initial Fut:	49	8	42	96	28	36	16	682	33	20	369	27
User Adj:	1.00	1.00	1.00	1.00	1.00	1.00	1.00	1.00	1.00	1.00	1.00	1.00
PHF Adj:	1.00	1.00	1.00	1.00	1.00	1.00	1.00	1.00	1.00	1.00	1.00	1.00
PHF Volume:	49	8	42	96	28	36	16	682	33	20	369	27
Reduct Vol:	0	0	0	0	0	0	0	0	0	0	0	0
Reduced Vol:	49	8	42	96	28	36	16	682	33	20	369	27
PCE Adj:	1.00	1.00	1.00	1.00	1.00	1.00	1.00	1.00	1.00	1.00	1.00	1.00
MLF Adj:	1.00	1.00	1.00	1.00	1.00	1.00	1.00	1.00	1.00	1.00	1.00	1.00
FinalVolume:	49	8	42	96	28	36	16	682	33	20	369	27
Saturation Flow Module:												
Sat/Lane:	1900	1900	1900	1900	1900	1900	1900	1900	1900	1900	1900	1900
Adjustment:	0.92	0.95	0.95	0.92	0.95	0.95	0.92	1.00	0.92	0.92	1.00	0.92
Lanes:	1.00	0.16	0.84	1.00	0.44	0.56	1.00	1.00	1.00	1.00	1.00	1.00
Final Sat.:	1750	288	1512	1750	787	1012	1750	1900	1750	1750	1900	1750
Capacity Analysis Module:												
Vol/Sat:	0.03	0.03	0.03	0.05	0.04	0.04	0.01	0.36	0.02	0.01	0.19	0.02
Crit Moves:				****				****				****
Green Time:	10.0	10.0	10.0	10.0	10.0	10.0	16.6	40.0	40.0	7.0	30.4	30.4
Volume/Cap:	0.18	0.18	0.18	0.36	0.23	0.23	0.04	0.59	0.03	0.11	0.42	0.03
Delay/Veh:	24.8	24.8	24.8	26.0	25.1	25.1	18.7	8.8	5.2	26.9	12.2	9.8
User DelAdj:	1.00	1.00	1.00	1.00	1.00	1.00	1.00	1.00	1.00	1.00	1.00	1.00
AdjDel/Veh:	24.8	24.8	24.8	26.0	25.1	25.1	18.7	8.8	5.2	26.9	12.2	9.8
LOS by Move:	C	C	C	C	C	C	B	A	A	C	B	A
HCM2k95thQ:	2	2	2	5	3	3	1	16	1	1	9	1

Note: Queue reported is the number of cars per lane.

BART Phase II Extension Project

Level Of Service Computation Report
2000 HCM Operations (Future Volume Alternative)
AM - 2035 Project Conditions

Intersection #3608: JULIAN/STOCKTON

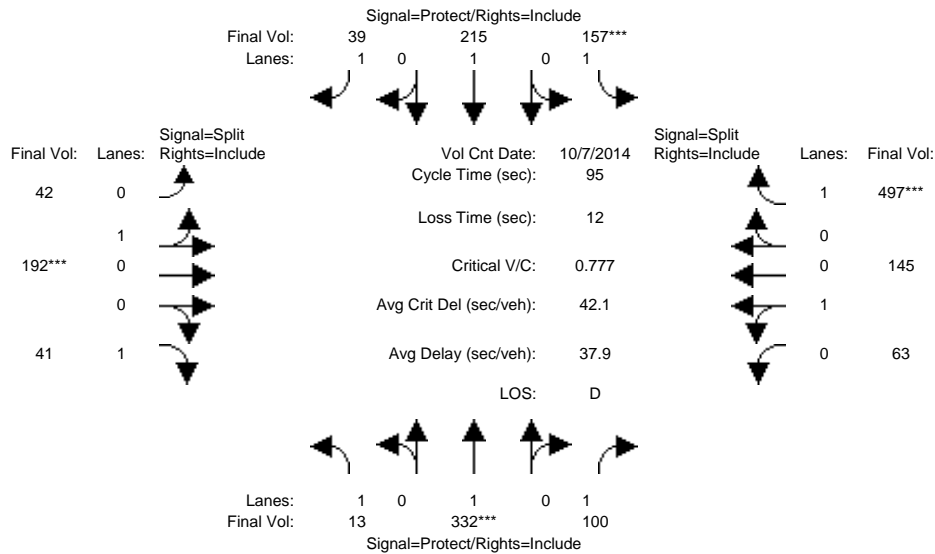

Approach:	North Bound			South Bound			East Bound			West Bound		
	L	T	R	L	T	R	L	T	R	L	T	R
Min. Green:	7	10	10	7	10	10	10	10	10	10	10	10
Y+R:	4.0	4.0	4.0	4.0	4.0	4.0	4.0	4.0	4.0	4.0	4.0	4.0
Volume Module: >> Count Date: 7 Oct 2014 <<												
Base Vol:	13	332	100	157	215	39	42	192	41	63	145	497
Growth Adj:	1.00	1.00	1.00	1.00	1.00	1.00	1.00	1.00	1.00	1.00	1.00	1.00
Initial Bse:	13	332	100	157	215	39	42	192	41	63	145	497
Added Vol:	0	0	0	0	0	0	0	0	0	0	0	0
PasserByVol:	0	0	0	0	0	0	0	0	0	0	0	0
Initial Fut:	13	332	100	157	215	39	42	192	41	63	145	497
User Adj:	1.00	1.00	1.00	1.00	1.00	1.00	1.00	1.00	1.00	1.00	1.00	1.00
PHF Adj:	1.00	1.00	1.00	1.00	1.00	1.00	1.00	1.00	1.00	1.00	1.00	1.00
PHF Volume:	13	332	100	157	215	39	42	192	41	63	145	497
Reduct Vol:	0	0	0	0	0	0	0	0	0	0	0	0
Reduced Vol:	13	332	100	157	215	39	42	192	41	63	145	497
PCE Adj:	1.00	1.00	1.00	1.00	1.00	1.00	1.00	1.00	1.00	1.00	1.00	1.00
MLF Adj:	1.00	1.00	1.00	1.00	1.00	1.00	1.00	1.00	1.00	1.00	1.00	1.00
FinalVolume:	13	332	100	157	215	39	42	192	41	63	145	497
Saturation Flow Module:												
Sat/Lane:	1900	1900	1900	1900	1900	1900	1900	1900	1900	1900	1900	1900
Adjustment:	0.92	1.00	0.92	0.92	1.00	0.92	0.95	0.95	0.92	0.95	0.95	0.92
Lanes:	1.00	1.00	1.00	1.00	1.00	1.00	0.18	0.82	1.00	0.30	0.70	1.00
Final Sat.:	1750	1900	1750	1750	1900	1750	323	1477	1750	545	1255	1750
Capacity Analysis Module:												
Vol/Sat:	0.01	0.17	0.06	0.09	0.11	0.02	0.13	0.13	0.02	0.12	0.12	0.28
Crit Moves:	****			****			****			****		
Green Time:	12.8	21.4	21.4	11.0	19.6	19.6	15.9	15.9	15.9	34.7	34.7	34.7
Volume/Cap:	0.06	0.78	0.25	0.78	0.55	0.11	0.78	0.78	0.14	0.32	0.32	0.78
Delay/Veh:	36.0	43.3	30.6	57.9	35.4	30.7	49.8	49.8	33.9	21.9	21.9	32.7
User DelAdj:	1.00	1.00	1.00	1.00	1.00	1.00	1.00	1.00	1.00	1.00	1.00	1.00
AdjDel/Veh:	36.0	43.3	30.6	57.9	35.4	30.7	49.8	49.8	33.9	21.9	21.9	32.7
LOS by Move:	D	D	C	E	D	C	D	D	C	C	C	C
HCM2k95thQ:	1	18	5	10	11	2	14	14	2	9	9	25

Note: Queue reported is the number of cars per lane.

BART Phase II Extension Project

Level Of Service Computation Report
 2000 HCM Operations (Future Volume Alternative)
 PM - 2035 Project Conditions

Intersection #3608: JULIAN/STOCKTON

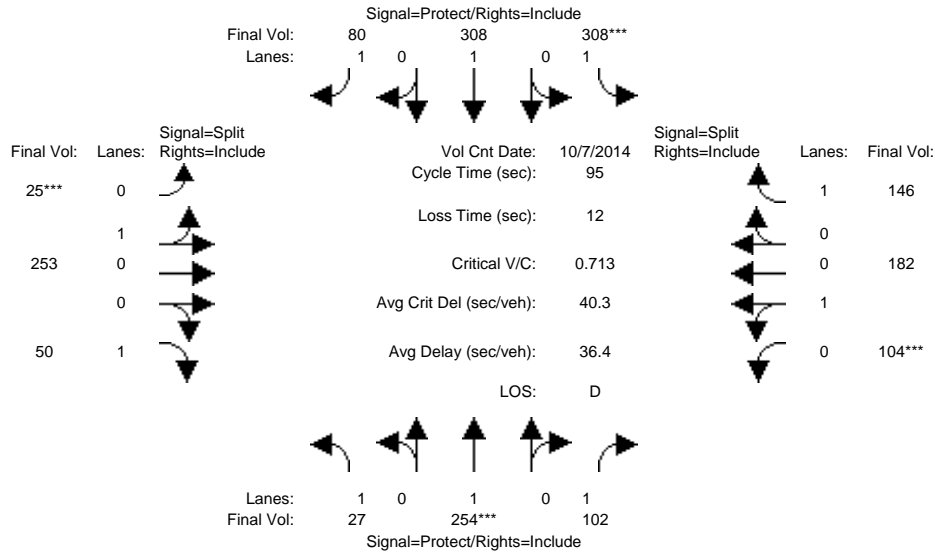

Approach:	North Bound			South Bound			East Bound			West Bound		
	L	T	R	L	T	R	L	T	R	L	T	R
Min. Green:	7	10	10	7	10	10	10	10	10	10	10	10
Y+R:	4.0	4.0	4.0	4.0	4.0	4.0	4.0	4.0	4.0	4.0	4.0	4.0
Volume Module: >> Count Date: 7 Oct 2014 <<												
Base Vol:	27	254	102	308	308	80	25	253	50	104	182	146
Growth Adj:	1.00	1.00	1.00	1.00	1.00	1.00	1.00	1.00	1.00	1.00	1.00	1.00
Initial Bse:	27	254	102	308	308	80	25	253	50	104	182	146
Added Vol:	0	0	0	0	0	0	0	0	0	0	0	0
PasserByVol:	0	0	0	0	0	0	0	0	0	0	0	0
Initial Fut:	27	254	102	308	308	80	25	253	50	104	182	146
User Adj:	1.00	1.00	1.00	1.00	1.00	1.00	1.00	1.00	1.00	1.00	1.00	1.00
PHF Adj:	1.00	1.00	1.00	1.00	1.00	1.00	1.00	1.00	1.00	1.00	1.00	1.00
PHF Volume:	27	254	102	308	308	80	25	253	50	104	182	146
Reduct Vol:	0	0	0	0	0	0	0	0	0	0	0	0
Reduced Vol:	27	254	102	308	308	80	25	253	50	104	182	146
PCE Adj:	1.00	1.00	1.00	1.00	1.00	1.00	1.00	1.00	1.00	1.00	1.00	1.00
MLF Adj:	1.00	1.00	1.00	1.00	1.00	1.00	1.00	1.00	1.00	1.00	1.00	1.00
FinalVolume:	27	254	102	308	308	80	25	253	50	104	182	146
Saturation Flow Module:												
Sat/Lane:	1900	1900	1900	1900	1900	1900	1900	1900	1900	1900	1900	1900
Adjustment:	0.92	1.00	0.92	0.92	1.00	0.92	0.95	0.95	0.92	0.95	0.95	0.92
Lanes:	1.00	1.00	1.00	1.00	1.00	1.00	0.09	0.91	1.00	0.36	0.64	1.00
Final Sat.:	1750	1900	1750	1750	1900	1750	162	1638	1750	655	1145	1750
Capacity Analysis Module:												
Vol/Sat:	0.02	0.13	0.06	0.18	0.16	0.05	0.15	0.15	0.03	0.16	0.16	0.08
Crit Moves:	****			****			****			****		
Green Time:	12.9	17.8	17.8	23.4	28.4	28.4	20.6	20.6	20.6	21.2	21.2	21.2
Volume/Cap:	0.11	0.71	0.31	0.71	0.54	0.15	0.71	0.71	0.13	0.71	0.71	0.37
Delay/Veh:	36.3	42.9	33.8	38.2	29.0	24.6	40.6	40.6	30.2	40.1	40.1	31.9
User DelAdj:	1.00	1.00	1.00	1.00	1.00	1.00	1.00	1.00	1.00	1.00	1.00	1.00
AdjDel/Veh:	36.3	42.9	33.8	38.2	29.0	24.6	40.6	40.6	30.2	40.1	40.1	31.9
LOS by Move:	D	D	C	D	C	C	D	D	C	D	D	C
HCM2k95thQ:	1	14	5	17	14	4	15	15	3	16	16	8

Note: Queue reported is the number of cars per lane.

BART Phase II Extension Project

Level Of Service Computation Report
2000 HCM Operations (Future Volume Alternative)
AM - 2035 Project Conditions

Intersection #3651: LINCOLN/PARKMOOR

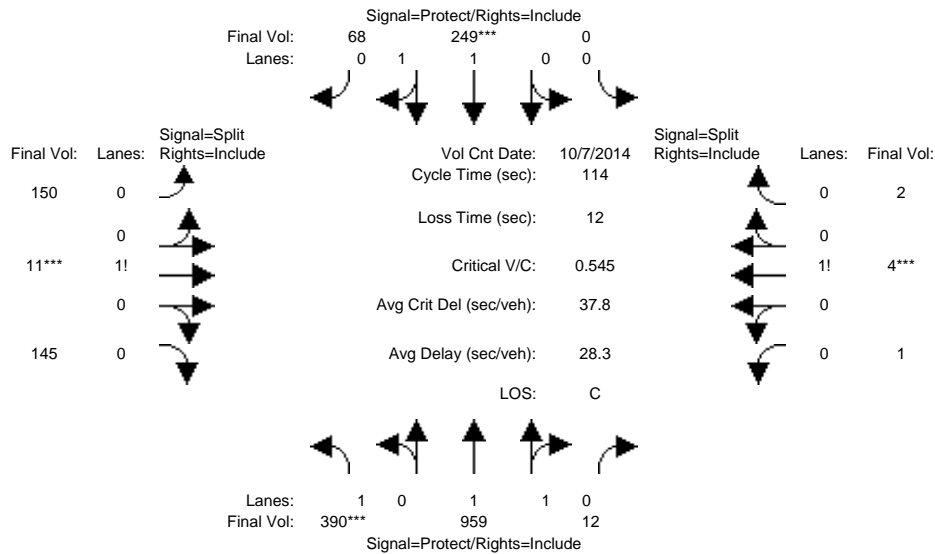

Approach:	North Bound			South Bound			East Bound			West Bound		
Movement:	L	T	R	L	T	R	L	T	R	L	T	R
Min. Green:	7	10	10	0	10	10	10	10	10	10	10	10
Y+R:	4.0	4.0	4.0	4.0	4.0	4.0	4.0	4.0	4.0	4.0	4.0	4.0
Volume Module: >> Count Date: 7 Oct 2014 <<												
Base Vol:	390	959	12	0	249	68	150	11	145	1	4	2
Growth Adj:	1.00	1.00	1.00	1.00	1.00	1.00	1.00	1.00	1.00	1.00	1.00	1.00
Initial Bse:	390	959	12	0	249	68	150	11	145	1	4	2
Added Vol:	0	0	0	0	0	0	0	0	0	0	0	0
PasserByVol:	0	0	0	0	0	0	0	0	0	0	0	0
Initial Fut:	390	959	12	0	249	68	150	11	145	1	4	2
User Adj:	1.00	1.00	1.00	1.00	1.00	1.00	1.00	1.00	1.00	1.00	1.00	1.00
PHF Adj:	1.00	1.00	1.00	1.00	1.00	1.00	1.00	1.00	1.00	1.00	1.00	1.00
PHF Volume:	390	959	12	0	249	68	150	11	145	1	4	2
Reduct Vol:	0	0	0	0	0	0	0	0	0	0	0	0
Reduced Vol:	390	959	12	0	249	68	150	11	145	1	4	2
PCE Adj:	1.00	1.00	1.00	1.00	1.00	1.00	1.00	1.00	1.00	1.00	1.00	1.00
MLF Adj:	1.00	1.00	1.00	1.00	1.00	1.00	1.00	1.00	1.00	1.00	1.00	1.00
Final Volume:	390	959	12	0	249	68	150	11	145	1	4	2
Saturation Flow Module:												
Sat/Lane:	1900	1900	1900	1900	1900	1900	1900	1900	1900	1900	1900	1900
Adjustment:	0.92	0.97	0.95	0.92	0.98	0.95	0.92	0.92	0.92	0.92	0.92	0.92
Lanes:	1.00	1.97	0.03	0.00	1.56	0.44	0.49	0.04	0.47	0.14	0.57	0.29
Final Sat.:	1750	3654	46	0	2906	794	858	63	829	250	1000	500
Capacity Analysis Module:												
Vol/Sat:	0.22	0.26	0.26	0.00	0.09	0.09	0.17	0.17	0.17	0.00	0.00	0.00
Crit Moves:	****				****			****			****	
Green Time:	42.4	58.7	58.7	0.0	16.3	16.3	33.3	33.3	33.3	10.0	10.0	10.0
Volume/Cap:	0.60	0.51	0.51	0.00	0.60	0.60	0.60	0.60	0.60	0.05	0.05	0.05
Delay/Veh:	30.5	18.4	18.4	0.0	47.7	47.7	36.6	36.6	36.6	47.8	47.8	47.8
User DelAdj:	1.00	1.00	1.00	1.00	1.00	1.00	1.00	1.00	1.00	1.00	1.00	1.00
AdjDel/Veh:	30.5	18.4	18.4	0.0	47.7	47.7	36.6	36.6	36.6	47.8	47.8	47.8
LOS by Move:	C	B	B	A	D	D	D	D	D	D	D	D
HCM2k95thQ:	21	20	20	0	10	10	18	18	18	1	1	1

Note: Queue reported is the number of cars per lane.

BART Phase II Extension Project

Level Of Service Computation Report
 2000 HCM Operations (Future Volume Alternative)
 PM - 2035 Project Conditions

Intersection #3651: LINCOLN/PARKMOOR

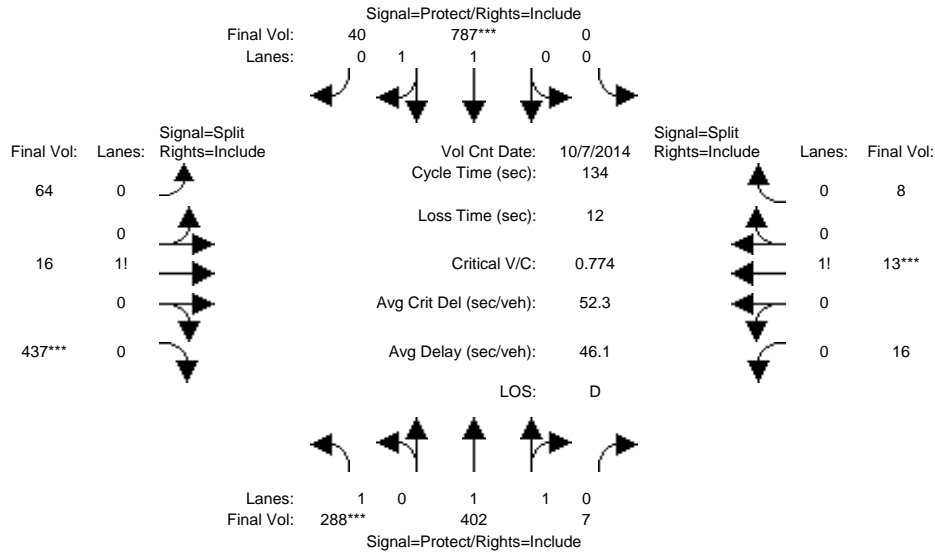

Approach:	North Bound			South Bound			East Bound			West Bound		
Movement:	L	T	R	L	T	R	L	T	R	L	T	R
Min. Green:	7	10	10	0	10	10	10	10	10	10	10	10
Y+R:	4.0	4.0	4.0	4.0	4.0	4.0	4.0	4.0	4.0	4.0	4.0	4.0
Volume Module: >> Count Date: 7 Oct 2014 <<												
Base Vol:	288	402	7	0	787	40	64	16	437	16	13	8
Growth Adj:	1.00	1.00	1.00	1.00	1.00	1.00	1.00	1.00	1.00	1.00	1.00	1.00
Initial Bse:	288	402	7	0	787	40	64	16	437	16	13	8
Added Vol:	0	0	0	0	0	0	0	0	0	0	0	0
PasserByVol:	0	0	0	0	0	0	0	0	0	0	0	0
Initial Fut:	288	402	7	0	787	40	64	16	437	16	13	8
User Adj:	1.00	1.00	1.00	1.00	1.00	1.00	1.00	1.00	1.00	1.00	1.00	1.00
PHF Adj:	1.00	1.00	1.00	1.00	1.00	1.00	1.00	1.00	1.00	1.00	1.00	1.00
PHF Volume:	288	402	7	0	787	40	64	16	437	16	13	8
Reduct Vol:	0	0	0	0	0	0	0	0	0	0	0	0
Reduced Vol:	288	402	7	0	787	40	64	16	437	16	13	8
PCE Adj:	1.00	1.00	1.00	1.00	1.00	1.00	1.00	1.00	1.00	1.00	1.00	1.00
MLF Adj:	1.00	1.00	1.00	1.00	1.00	1.00	1.00	1.00	1.00	1.00	1.00	1.00
FinalVolume:	288	402	7	0	787	40	64	16	437	16	13	8
Saturation Flow Module:												
Sat/Lane:	1900	1900	1900	1900	1900	1900	1900	1900	1900	1900	1900	1900
Adjustment:	0.92	0.97	0.95	0.92	0.98	0.95	0.92	0.92	0.92	0.92	0.92	0.92
Lanes:	1.00	1.96	0.04	0.00	1.90	0.10	0.12	0.03	0.85	0.43	0.35	0.22
Final Sat.:	1750	3637	63	0	3521	179	217	54	1479	757	615	378
Capacity Analysis Module:												
Vol/Sat:	0.16	0.11	0.11	0.00	0.22	0.22	0.30	0.30	0.30	0.02	0.02	0.02
Crit Moves:	****			****			****			****		
Green Time:	27.0	63.6	63.6	0.0	36.6	36.6	48.4	48.4	48.4	10.0	10.0	10.0
Volume/Cap:	0.82	0.23	0.23	0.00	0.82	0.82	0.82	0.82	0.82	0.28	0.28	0.28
Delay/Veh:	65.1	20.9	20.9	0.0	50.9	50.9	47.0	47.0	47.0	59.8	59.8	59.8
User DelAdj:	1.00	1.00	1.00	1.00	1.00	1.00	1.00	1.00	1.00	1.00	1.00	1.00
AdjDel/Veh:	65.1	20.9	20.9	0.0	50.9	50.9	47.0	47.0	47.0	59.8	59.8	59.8
LOS by Move:	E	C	C	A	D	D	D	D	D	E	E	E
HCM2k95thQ:	23	10	10	0	30	30	36	36	36	4	4	4

Note: Queue reported is the number of cars per lane.

BART Phase II Extension Project

Level Of Service Computation Report
 2000 HCM Operations (Future Volume Alternative)
 AM - 2035 Project Conditions

Intersection #3653: LINCOLN/SAN CARLOS

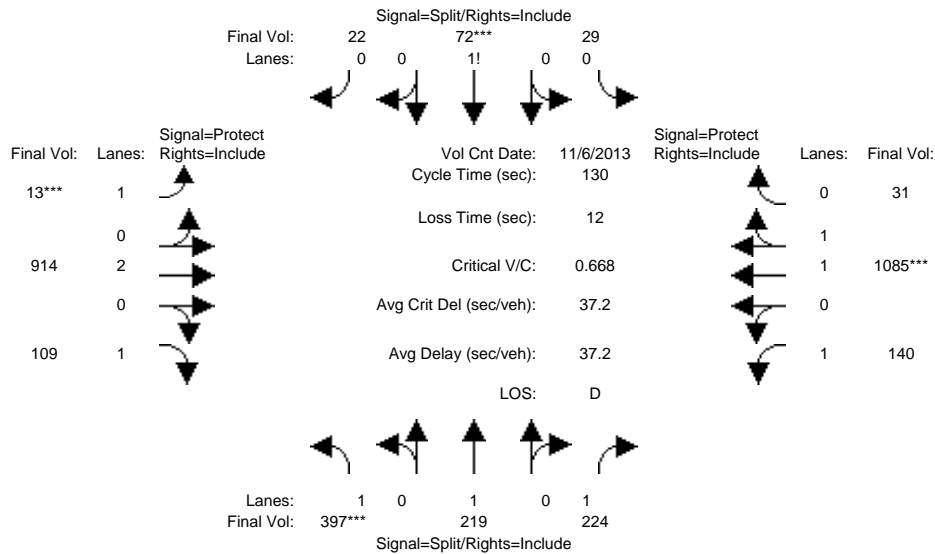

Approach:	North Bound			South Bound			East Bound			West Bound		
	L	T	R	L	T	R	L	T	R	L	T	R
Min. Green:	10	10	10	10	10	10	7	10	10	7	10	10
Y+R:	4.0	4.0	4.0	4.0	4.0	4.0	4.0	4.0	4.0	4.0	4.0	4.0
Volume Module: >> Count Date: 6 Nov 2013 <<												
Base Vol:	397	219	224	29	72	22	13	914	109	140	1085	31
Growth Adj:	1.00	1.00	1.00	1.00	1.00	1.00	1.00	1.00	1.00	1.00	1.00	1.00
Initial Bse:	397	219	224	29	72	22	13	914	109	140	1085	31
Added Vol:	0	0	0	0	0	0	0	0	0	0	0	0
PasserByVol:	0	0	0	0	0	0	0	0	0	0	0	0
Initial Fut:	397	219	224	29	72	22	13	914	109	140	1085	31
User Adj:	1.00	1.00	1.00	1.00	1.00	1.00	1.00	1.00	1.00	1.00	1.00	1.00
PHF Adj:	1.00	1.00	1.00	1.00	1.00	1.00	1.00	1.00	1.00	1.00	1.00	1.00
PHF Volume:	397	219	224	29	72	22	13	914	109	140	1085	31
Reduct Vol:	0	0	0	0	0	0	0	0	0	0	0	0
Reduced Vol:	397	219	224	29	72	22	13	914	109	140	1085	31
PCE Adj:	1.00	1.00	1.00	1.00	1.00	1.00	1.00	1.00	1.00	1.00	1.00	1.00
MLF Adj:	1.00	1.00	1.00	1.00	1.00	1.00	1.00	1.00	1.00	1.00	1.00	1.00
FinalVolume:	397	219	224	29	72	22	13	914	109	140	1085	31
Saturation Flow Module:												
Sat/Lane:	1900	1900	1900	1900	1900	1900	1900	1900	1900	1900	1900	1900
Adjustment:	0.92	1.00	0.92	0.92	0.92	0.92	0.92	1.00	0.92	0.92	0.97	0.95
Lanes:	1.00	1.00	1.00	0.24	0.58	0.18	1.00	2.00	1.00	1.00	1.94	0.06
Final Sat.:	1750	1900	1750	413	1024	313	1750	3800	1750	1750	3597	103
Capacity Analysis Module:												
Vol/Sat:	0.23	0.12	0.13	0.07	0.07	0.07	0.01	0.24	0.06	0.08	0.30	0.30
Crit Moves:	****			****			****			****		
Green Time:	42.1	42.1	42.1	13.0	13.0	13.0	7.0	47.2	47.2	15.7	55.9	55.9
Volume/Cap:	0.70	0.36	0.40	0.70	0.70	0.70	0.14	0.66	0.17	0.66	0.70	0.70
Delay/Veh:	42.4	34.0	34.6	68.6	68.6	68.6	59.3	35.9	28.2	62.2	31.7	31.7
User DelAdj:	1.00	1.00	1.00	1.00	1.00	1.00	1.00	1.00	1.00	1.00	1.00	1.00
AdjDel/Veh:	42.4	34.0	34.6	68.6	68.6	68.6	59.3	35.9	28.2	62.2	31.7	31.7
LOS by Move:	D	C	C	E	E	E	E	D	C	E	C	C
HCM2k95thQ:	26	12	14	13	13	13	1	27	6	11	32	32

Note: Queue reported is the number of cars per lane.

BART Phase II Extension Project

Level Of Service Computation Report
2000 HCM Operations (Future Volume Alternative)
PM - 2035 Project Conditions

Intersection #3653: LINCOLN/SAN CARLOS

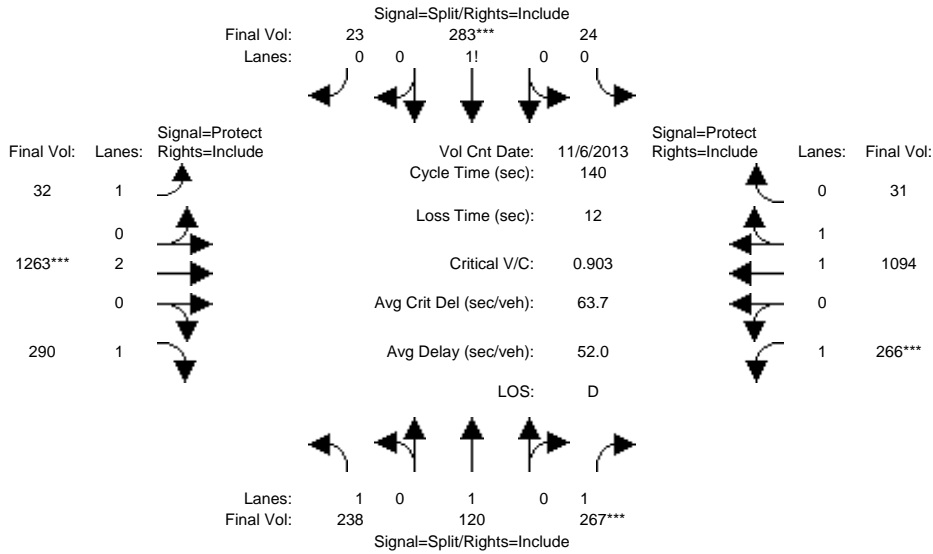

Approach:	North Bound			South Bound			East Bound			West Bound		
	L	T	R	L	T	R	L	T	R	L	T	R
Min. Green:	10	10	10	10	10	10	7	10	10	7	10	10
Y+R:	4.0	4.0	4.0	4.0	4.0	4.0	4.0	4.0	4.0	4.0	4.0	4.0
Volume Module: >> Count Date: 6 Nov 2013 <<												
Base Vol:	238	120	267	24	283	23	32	1263	290	266	1094	31
Growth Adj:	1.00	1.00	1.00	1.00	1.00	1.00	1.00	1.00	1.00	1.00	1.00	1.00
Initial Bse:	238	120	267	24	283	23	32	1263	290	266	1094	31
Added Vol:	0	0	0	0	0	0	0	0	0	0	0	0
PasserByVol:	0	0	0	0	0	0	0	0	0	0	0	0
Initial Fut:	238	120	267	24	283	23	32	1263	290	266	1094	31
User Adj:	1.00	1.00	1.00	1.00	1.00	1.00	1.00	1.00	1.00	1.00	1.00	1.00
PHF Adj:	1.00	1.00	1.00	1.00	1.00	1.00	1.00	1.00	1.00	1.00	1.00	1.00
PHF Volume:	238	120	267	24	283	23	32	1263	290	266	1094	31
Reduct Vol:	0	0	0	0	0	0	0	0	0	0	0	0
Reduced Vol:	238	120	267	24	283	23	32	1263	290	266	1094	31
PCE Adj:	1.00	1.00	1.00	1.00	1.00	1.00	1.00	1.00	1.00	1.00	1.00	1.00
MLF Adj:	1.00	1.00	1.00	1.00	1.00	1.00	1.00	1.00	1.00	1.00	1.00	1.00
FinalVolume:	238	120	267	24	283	23	32	1263	290	266	1094	31
Saturation Flow Module:												
Sat/Lane:	1900	1900	1900	1900	1900	1900	1900	1900	1900	1900	1900	1900
Adjustment:	0.92	1.00	0.92	0.92	0.92	0.92	0.92	1.00	0.92	0.92	0.97	0.95
Lanes:	1.00	1.00	1.00	0.07	0.86	0.07	1.00	2.00	1.00	1.00	1.94	0.06
Final Sat.:	1750	1900	1750	127	1501	122	1750	3800	1750	1750	3598	102
Capacity Analysis Module:												
Vol/Sat:	0.14	0.06	0.15	0.19	0.19	0.19	0.02	0.33	0.17	0.15	0.30	0.30
Crit Moves:			****		****			****		****		
Green Time:	23.7	23.7	23.7	29.2	29.2	29.2	10.6	51.5	51.5	23.6	64.5	64.5
Volume/Cap:	0.80	0.37	0.90	0.90	0.90	0.90	0.24	0.90	0.45	0.90	0.66	0.66
Delay/Veh:	70.7	52.3	85.9	78.7	78.7	78.7	61.9	50.3	34.0	86.0	30.2	30.2
User DelAdj:	1.00	1.00	1.00	1.00	1.00	1.00	1.00	1.00	1.00	1.00	1.00	1.00
AdjDel/Veh:	70.7	52.3	85.9	78.7	78.7	78.7	61.9	50.3	34.0	86.0	30.2	30.2
LOS by Move:	E	D	F	E	E	E	E	D	C	F	C	C
HCM2k95thQ:	20	9	24	31	31	31	3	45	18	24	32	32

Note: Queue reported is the number of cars per lane.

BART Phase II Extension Project

Level Of Service Computation Report
 2000 HCM Operations (Future Volume Alternative)
 AM - 2035 Project Conditions

Intersection #3690: MERIDIAN/PARKMOOR

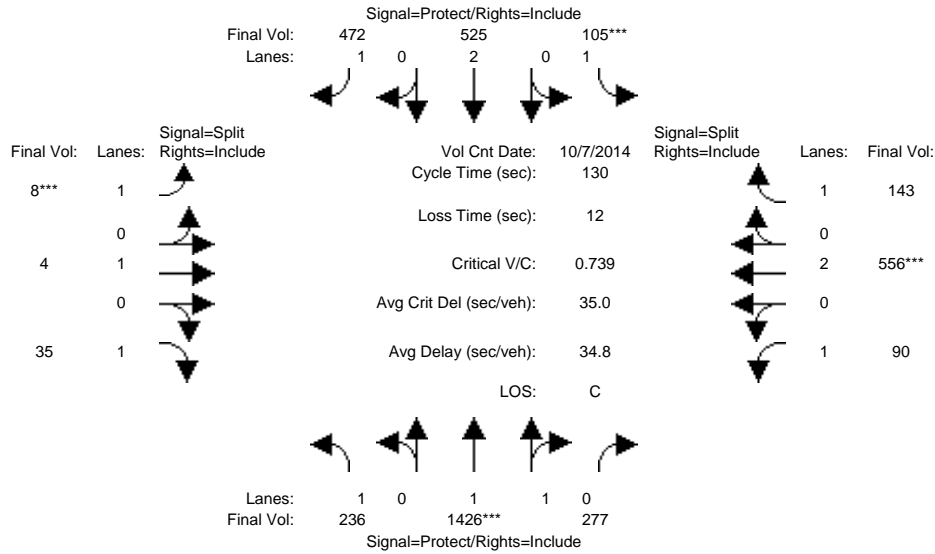

Approach:	North Bound			South Bound			East Bound			West Bound		
	L	T	R	L	T	R	L	T	R	L	T	R
Min. Green:	7	10	10	7	10	10	10	10	10	10	10	10
Y+R:	4.0	4.0	4.0	4.0	4.0	4.0	4.0	4.0	4.0	4.0	4.0	4.0

Volume Module:	>>	Count	Date:	7 Oct 2014	<<											
Base Vol:	236	1426	277	105	525	472	8	4	35	90	556	143				
Growth Adj:	1.00	1.00	1.00	1.00	1.00	1.00	1.00	1.00	1.00	1.00	1.00	1.00				
Initial Bse:	236	1426	277	105	525	472	8	4	35	90	556	143				
Added Vol:	0	0	0	0	0	0	0	0	0	0	0	0				
PasserByVol:	0	0	0	0	0	0	0	0	0	0	0	0				
Initial Fut:	236	1426	277	105	525	472	8	4	35	90	556	143				
User Adj:	1.00	1.00	1.00	1.00	1.00	1.00	1.00	1.00	1.00	1.00	1.00	1.00				
PHF Adj:	1.00	1.00	1.00	1.00	1.00	1.00	1.00	1.00	1.00	1.00	1.00	1.00				
PHF Volume:	236	1426	277	105	525	472	8	4	35	90	556	143				
Reduct Vol:	0	0	0	0	0	0	0	0	0	0	0	0				
Reduced Vol:	236	1426	277	105	525	472	8	4	35	90	556	143				
PCE Adj:	1.00	1.00	1.00	1.00	1.00	1.00	1.00	1.00	1.00	1.00	1.00	1.00				
MLF Adj:	1.00	1.00	1.00	1.00	1.00	1.00	1.00	1.00	1.00	1.00	1.00	1.00				
FinalVolume:	236	1426	277	105	525	472	8	4	35	90	556	143				

Saturation Flow Module:												
Sat/Lane:	1900	1900	1900	1900	1900	1900	1900	1900	1900	1900	1900	1900
Adjustment:	0.92	0.98	0.95	0.92	1.00	0.92	0.92	1.00	0.92	0.92	1.00	0.92
Lanes:	1.00	1.67	0.33	1.00	2.00	1.00	1.00	1.00	1.00	1.00	2.00	1.00
Final Sat.:	1750	3098	602	1750	3800	1750	1750	1900	1750	1750	3800	1750

Capacity Analysis Module:												
Vol/Sat:	0.13	0.46	0.46	0.06	0.14	0.27	0.00	0.00	0.02	0.05	0.15	0.08
Crit Moves:	****	****	****	****	****	****	****	****	****	****	****	****
Green Time:	28.1	74.6	74.6	9.7	56.2	56.2	10.0	10.0	10.0	23.7	23.7	23.7
Volume/Cap:	0.62	0.80	0.80	0.80	0.32	0.62	0.06	0.03	0.26	0.28	0.80	0.45
Delay/Veh:	49.4	24.2	24.2	88.0	24.4	30.3	55.8	55.6	57.5	46.3	57.6	48.3
User DelAdj:	1.00	1.00	1.00	1.00	1.00	1.00	1.00	1.00	1.00	1.00	1.00	1.00
AdjDel/Veh:	49.4	24.2	24.2	88.0	24.4	30.3	55.8	55.6	57.5	46.3	57.6	48.3
LOS by Move:	D	C	C	F	C	C	E	E	E	D	E	D
HCM2k95thQ:	18	46	46	10	13	27	1	0	3	6	20	10

Note: Queue reported is the number of cars per lane.

BART Phase II Extension Project

Level Of Service Computation Report
2000 HCM Operations (Future Volume Alternative)
PM - 2035 Project Conditions

Intersection #3690: MERIDIAN/PARKMOOR

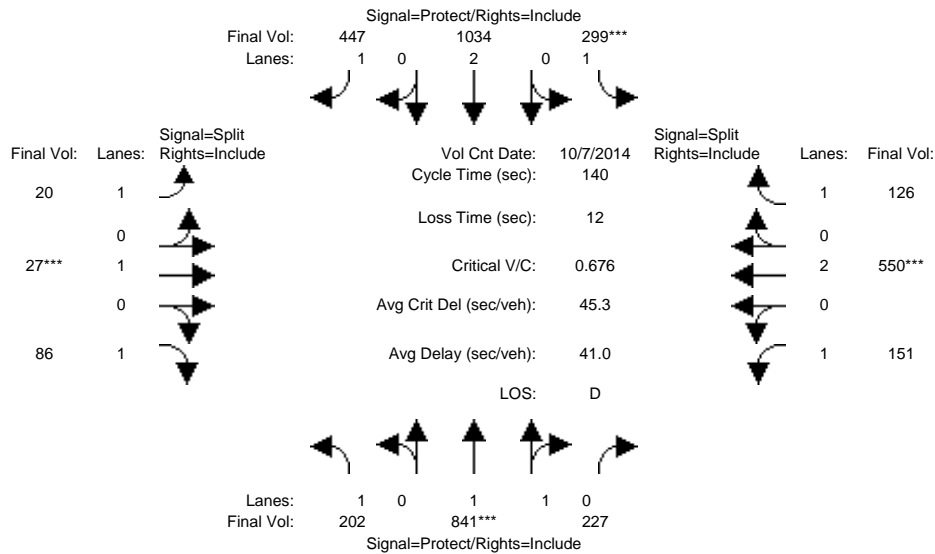

Approach:	North Bound			South Bound			East Bound			West Bound		
	L	T	R	L	T	R	L	T	R	L	T	R
Min. Green:	7	10	10	7	10	10	10	10	10	10	10	10
Y+R:	4.0	4.0	4.0	4.0	4.0	4.0	4.0	4.0	4.0	4.0	4.0	4.0
Volume Module: >> Count Date: 7 Oct 2014 <<												
Base Vol:	202	841	227	299	1034	447	20	27	86	151	550	126
Growth Adj:	1.00	1.00	1.00	1.00	1.00	1.00	1.00	1.00	1.00	1.00	1.00	1.00
Initial Bse:	202	841	227	299	1034	447	20	27	86	151	550	126
Added Vol:	0	0	0	0	0	0	0	0	0	0	0	0
PasserByVol:	0	0	0	0	0	0	0	0	0	0	0	0
Initial Fut:	202	841	227	299	1034	447	20	27	86	151	550	126
User Adj:	1.00	1.00	1.00	1.00	1.00	1.00	1.00	1.00	1.00	1.00	1.00	1.00
PHF Adj:	1.00	1.00	1.00	1.00	1.00	1.00	1.00	1.00	1.00	1.00	1.00	1.00
PHF Volume:	202	841	227	299	1034	447	20	27	86	151	550	126
Reduct Vol:	0	0	0	0	0	0	0	0	0	0	0	0
Reduced Vol:	202	841	227	299	1034	447	20	27	86	151	550	126
PCE Adj:	1.00	1.00	1.00	1.00	1.00	1.00	1.00	1.00	1.00	1.00	1.00	1.00
MLF Adj:	1.00	1.00	1.00	1.00	1.00	1.00	1.00	1.00	1.00	1.00	1.00	1.00
FinalVolume:	202	841	227	299	1034	447	20	27	86	151	550	126
Saturation Flow Module:												
Sat/Lane:	1900	1900	1900	1900	1900	1900	1900	1900	1900	1900	1900	1900
Adjustment:	0.92	0.98	0.95	0.92	1.00	0.92	0.92	1.00	0.92	0.92	1.00	0.92
Lanes:	1.00	1.56	0.44	1.00	2.00	1.00	1.00	1.00	1.00	1.00	2.00	1.00
Final Sat.:	1750	2913	786	1750	3800	1750	1750	1900	1750	1750	3800	1750
Capacity Analysis Module:												
Vol/Sat:	0.12	0.29	0.29	0.17	0.27	0.26	0.01	0.01	0.05	0.09	0.14	0.07
Crit Moves:	****			****			****			****		
Green Time:	26.7	56.3	56.3	33.3	62.9	62.9	10.2	10.2	10.2	28.2	28.2	28.2
Volume/Cap:	0.61	0.72	0.72	0.72	0.61	0.57	0.16	0.20	0.68	0.43	0.72	0.36
Delay/Veh:	55.0	36.9	36.9	55.0	29.8	29.5	61.5	61.8	76.9	49.7	55.5	48.7
User DelAdj:	1.00	1.00	1.00	1.00	1.00	1.00	1.00	1.00	1.00	1.00	1.00	1.00
AdjDel/Veh:	55.0	36.9	36.9	55.0	29.8	29.5	61.5	61.8	76.9	49.7	55.5	48.7
LOS by Move:	D	D	D	D	C	C	E	E	E	D	E	D
HCM2k95thQ:	17	34	34	23	29	26	2	2	8	11	20	10

Note: Queue reported is the number of cars per lane.

BART Phase II Extension Project

Level Of Service Computation Report
2000 HCM Operations (Future Volume Alternative)
AM - 2035 Project Conditions

Intersection #3693: MERIDIAN/SAN CARLOS

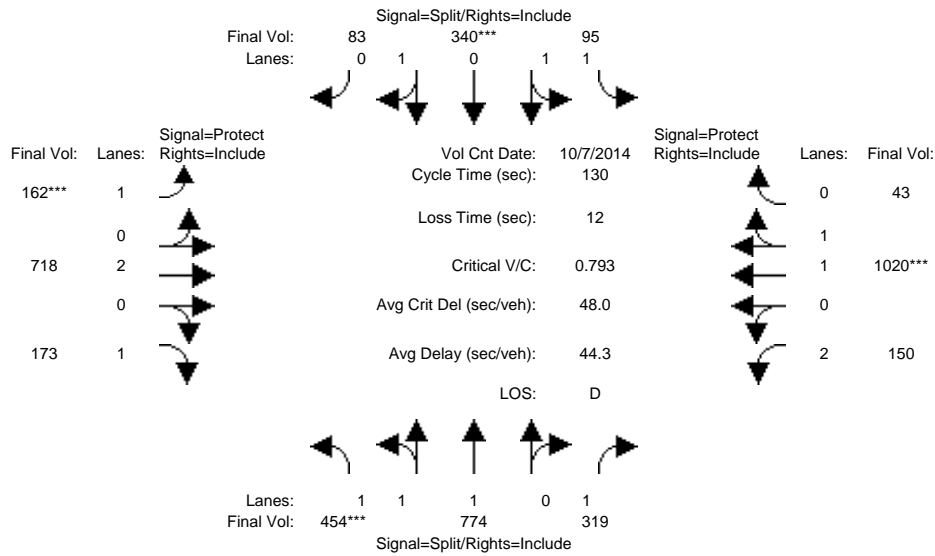

Approach:	North Bound			South Bound			East Bound			West Bound		
	L	T	R	L	T	R	L	T	R	L	T	R
Min. Green:	10	10	10	10	10	10	7	10	10	7	10	10
Y+R:	4.0	4.0	4.0	4.0	4.0	4.0	4.0	4.0	4.0	4.0	4.0	4.0
Volume Module: >> Count Date: 7 Oct 2014 <<												
Base Vol:	454	774	319	95	340	83	162	718	173	150	1020	43
Growth Adj:	1.00	1.00	1.00	1.00	1.00	1.00	1.00	1.00	1.00	1.00	1.00	1.00
Initial Bse:	454	774	319	95	340	83	162	718	173	150	1020	43
Added Vol:	0	0	0	0	0	0	0	0	0	0	0	0
PasserByVol:	0	0	0	0	0	0	0	0	0	0	0	0
Initial Fut:	454	774	319	95	340	83	162	718	173	150	1020	43
User Adj:	1.00	1.00	1.00	1.00	1.00	1.00	1.00	1.00	1.00	1.00	1.00	1.00
PHF Adj:	1.00	1.00	1.00	1.00	1.00	1.00	1.00	1.00	1.00	1.00	1.00	1.00
PHF Volume:	454	774	319	95	340	83	162	718	173	150	1020	43
Reduct Vol:	0	0	0	0	0	0	0	0	0	0	0	0
Reduced Vol:	454	774	319	95	340	83	162	718	173	150	1020	43
PCE Adj:	1.00	1.00	1.00	1.00	1.00	1.00	1.00	1.00	1.00	1.00	1.00	1.00
MLF Adj:	1.00	1.00	1.00	1.00	1.00	1.00	1.00	1.00	1.00	1.00	1.00	1.00
FinalVolume:	454	774	319	95	340	83	162	718	173	150	1020	43
Saturation Flow Module:												
Sat/Lane:	1900	1900	1900	1900	1900	1900	1900	1900	1900	1900	1900	1900
Adjustment:	0.92	0.98	0.92	0.92	0.98	0.95	0.92	1.00	0.92	0.83	0.97	0.95
Lanes:	1.15	1.85	1.00	1.00	1.60	0.40	1.00	2.00	1.00	2.00	1.92	0.08
Final Sat.:	2014	3433	1750	1750	2973	726	1750	3800	1750	3150	3550	150
Capacity Analysis Module:												
Vol/Sat:	0.23	0.23	0.18	0.05	0.11	0.11	0.09	0.19	0.10	0.05	0.29	0.29
Crit Moves:	****				****		****				****	
Green Time:	37.0	37.0	37.0	18.7	18.7	18.7	15.2	48.5	48.5	13.8	47.1	47.1
Volume/Cap:	0.79	0.79	0.64	0.38	0.79	0.79	0.79	0.51	0.27	0.45	0.79	0.79
Delay/Veh:	45.9	45.9	43.5	50.5	60.4	60.4	74.7	31.8	28.6	55.5	40.4	40.4
User DelAdj:	1.00	1.00	1.00	1.00	1.00	1.00	1.00	1.00	1.00	1.00	1.00	1.00
AdjDel/Veh:	45.9	45.9	43.5	50.5	60.4	60.4	74.7	31.8	28.6	55.5	40.4	40.4
LOS by Move:	D	D	D	D	E	E	E	C	C	E	D	D
HCM2k95thQ:	28	28	22	7	17	17	14	20	10	7	34	34

Note: Queue reported is the number of cars per lane.

BART Phase II Extension Project

Level Of Service Computation Report
 2000 HCM Operations (Future Volume Alternative)
 PM - 2035 Project Conditions

Intersection #3693: MERIDIAN/SAN CARLOS

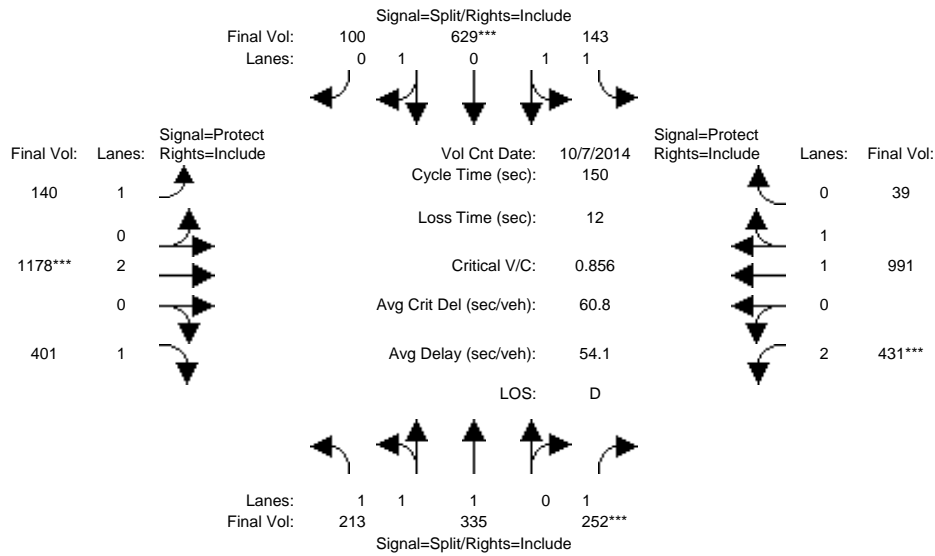

Approach:	North Bound			South Bound			East Bound			West Bound		
	L	T	R	L	T	R	L	T	R	L	T	R
Min. Green:	10	10	10	10	10	10	7	10	10	7	10	10
Y+R:	4.0	4.0	4.0	4.0	4.0	4.0	4.0	4.0	4.0	4.0	4.0	4.0

Volume Module:	>> Count Date: 7 Oct 2014 <<											
Base Vol:	213	335	252	143	629	100	140	1178	401	431	991	39
Growth Adj:	1.00	1.00	1.00	1.00	1.00	1.00	1.00	1.00	1.00	1.00	1.00	1.00
Initial Bse:	213	335	252	143	629	100	140	1178	401	431	991	39
Added Vol:	0	0	0	0	0	0	0	0	0	0	0	0
PasserByVol:	0	0	0	0	0	0	0	0	0	0	0	0
Initial Fut:	213	335	252	143	629	100	140	1178	401	431	991	39
User Adj:	1.00	1.00	1.00	1.00	1.00	1.00	1.00	1.00	1.00	1.00	1.00	1.00
PHF Adj:	1.00	1.00	1.00	1.00	1.00	1.00	1.00	1.00	1.00	1.00	1.00	1.00
PHF Volume:	213	335	252	143	629	100	140	1178	401	431	991	39
Reduct Vol:	0	0	0	0	0	0	0	0	0	0	0	0
Reduced Vol:	213	335	252	143	629	100	140	1178	401	431	991	39
PCE Adj:	1.00	1.00	1.00	1.00	1.00	1.00	1.00	1.00	1.00	1.00	1.00	1.00
MLF Adj:	1.00	1.00	1.00	1.00	1.00	1.00	1.00	1.00	1.00	1.00	1.00	1.00
FinalVolume:	213	335	252	143	629	100	140	1178	401	431	991	39

Saturation Flow Module:												
Sat/Lane:	1900	1900	1900	1900	1900	1900	1900	1900	1900	1900	1900	1900
Adjustment:	0.92	0.98	0.92	0.92	0.98	0.95	0.92	1.00	0.92	0.83	0.97	0.95
Lanes:	1.20	1.80	1.00	1.00	1.72	0.28	1.00	2.00	1.00	2.00	1.92	0.08
Final Sat.:	2117	3329	1750	1750	3192	507	1750	3800	1750	3150	3560	140

Capacity Analysis Module:												
Vol/Sat:	0.10	0.10	0.14	0.08	0.20	0.20	0.08	0.31	0.23	0.14	0.28	0.28
Crit Moves:			****		****			****		****		
Green Time:	25.2	25.2	25.2	34.5	34.5	34.5	17.5	54.3	54.3	24.0	60.8	60.8
Volume/Cap:	0.60	0.60	0.86	0.36	0.86	0.86	0.69	0.86	0.63	0.86	0.69	0.69
Delay/Veh:	58.8	58.8	81.8	48.5	62.7	62.7	73.1	49.8	41.7	74.9	38.1	38.1
User DelAdj:	1.00	1.00	1.00	1.00	1.00	1.00	1.00	1.00	1.00	1.00	1.00	1.00
AdjDel/Veh:	58.8	58.8	81.8	48.5	62.7	62.7	73.1	49.8	41.7	74.9	38.1	38.1
LOS by Move:	E	E	F	D	E	E	E	D	D	E	D	D
HCM2k95thQ:	15	15	24	11	30	30	13	43	28	23	34	34

Note: Queue reported is the number of cars per lane.

BART Phase II Extension Project

Level Of Service Computation Report
2000 HCM Operations (Future Volume Alternative)
AM - 2035 Project Conditions

Intersection #3709: MONTGOMERY/PARK

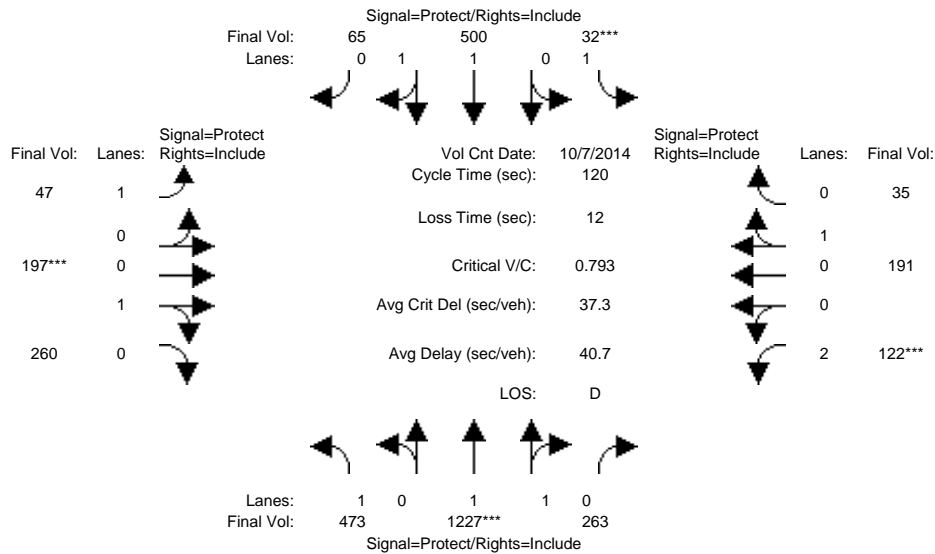

Approach:	North Bound			South Bound			East Bound			West Bound		
	L	T	R	L	T	R	L	T	R	L	T	R
Min. Green:	7	10	10	7	10	10	7	10	10	7	10	10
Y+R:	4.0	4.0	4.0	4.0	4.0	4.0	4.0	4.0	4.0	4.0	4.0	4.0
Volume Module: >> Count Date: 7 Oct 2014 <<												
Base Vol:	473	1227	263	32	500	65	47	197	260	122	191	35
Growth Adj:	1.00	1.00	1.00	1.00	1.00	1.00	1.00	1.00	1.00	1.00	1.00	1.00
Initial Bse:	473	1227	263	32	500	65	47	197	260	122	191	35
Added Vol:	0	0	0	0	0	0	0	0	0	0	0	0
PasserByVol:	0	0	0	0	0	0	0	0	0	0	0	0
Initial Fut:	473	1227	263	32	500	65	47	197	260	122	191	35
User Adj:	1.00	1.00	1.00	1.00	1.00	1.00	1.00	1.00	1.00	1.00	1.00	1.00
PHF Adj:	1.00	1.00	1.00	1.00	1.00	1.00	1.00	1.00	1.00	1.00	1.00	1.00
PHF Volume:	473	1227	263	32	500	65	47	197	260	122	191	35
Reduct Vol:	0	0	0	0	0	0	0	0	0	0	0	0
Reduced Vol:	473	1227	263	32	500	65	47	197	260	122	191	35
PCE Adj:	1.00	1.00	1.00	1.00	1.00	1.00	1.00	1.00	1.00	1.00	1.00	1.00
MLF Adj:	1.00	1.00	1.00	1.00	1.00	1.00	1.00	1.00	1.00	1.00	1.00	1.00
FinalVolume:	473	1227	263	32	500	65	47	197	260	122	191	35
Saturation Flow Module:												
Sat/Lane:	1900	1900	1900	1900	1900	1900	1900	1900	1900	1900	1900	1900
Adjustment:	0.92	0.98	0.95	0.92	0.98	0.95	0.92	0.95	0.95	0.83	0.95	0.95
Lanes:	1.00	1.64	0.36	1.00	1.76	0.24	1.00	0.43	0.57	2.00	0.85	0.15
Final Sat.:	1750	3046	653	1750	3274	426	1750	776	1024	3150	1521	279
Capacity Analysis Module:												
Vol/Sat:	0.27	0.40	0.40	0.02	0.15	0.15	0.03	0.25	0.25	0.04	0.13	0.13
Crit Moves:	****			****			****			****		
Green Time:	41.3	57.7	57.7	7.0	23.3	23.3	13.7	36.3	36.3	7.0	29.6	29.6
Volume/Cap:	0.79	0.84	0.84	0.31	0.79	0.79	0.23	0.84	0.84	0.66	0.51	0.51
Delay/Veh:	42.1	30.8	30.8	56.0	51.6	51.6	48.9	50.1	50.1	64.2	39.9	39.9
User DelAdj:	1.00	1.00	1.00	1.00	1.00	1.00	1.00	1.00	1.00	1.00	1.00	1.00
AdjDel/Veh:	42.1	30.8	30.8	56.0	51.6	51.6	48.9	50.1	50.1	64.2	39.9	39.9
LOS by Move:	D	C	C	E	D	D	D	D	D	E	D	D
HCM2k95thQ:	30	42	42	3	22	22	3	30	30	6	14	14

Note: Queue reported is the number of cars per lane.

BART Phase II Extension Project

Level Of Service Computation Report
2000 HCM Operations (Future Volume Alternative)
PM - 2035 Project Conditions

Intersection #3709: MONTGOMERY/PARK

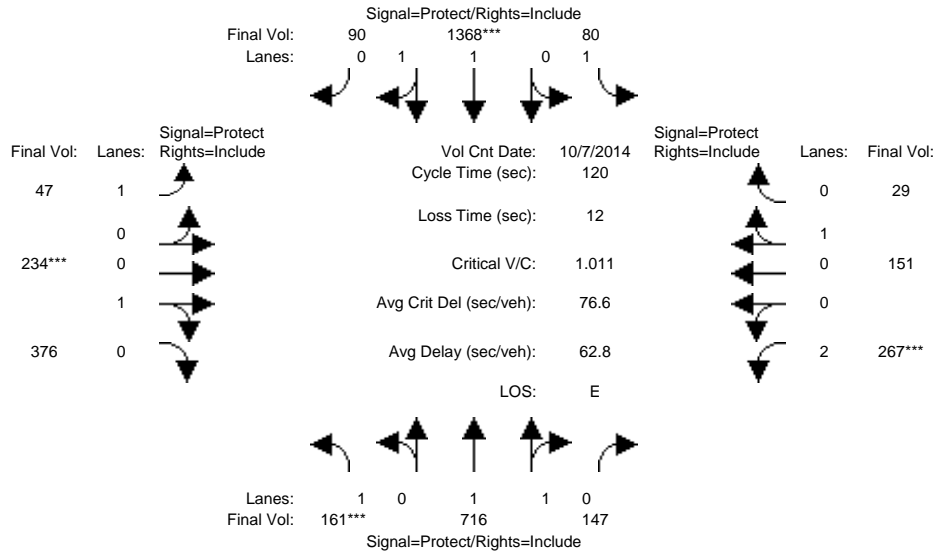

Approach:	North Bound			South Bound			East Bound			West Bound		
	L	T	R	L	T	R	L	T	R	L	T	R
Min. Green:	7	10	10	7	10	10	7	10	10	7	10	10
Y+R:	4.0	4.0	4.0	4.0	4.0	4.0	4.0	4.0	4.0	4.0	4.0	4.0

Volume Module:	>> Count Date: 7 Oct 2014 <<											
Base Vol:	161	716	147	80	1368	90	47	234	376	267	151	29
Growth Adj:	1.00	1.00	1.00	1.00	1.00	1.00	1.00	1.00	1.00	1.00	1.00	1.00
Initial Bse:	161	716	147	80	1368	90	47	234	376	267	151	29
Added Vol:	0	0	0	0	0	0	0	0	0	0	0	0
PasserByVol:	0	0	0	0	0	0	0	0	0	0	0	0
Initial Fut:	161	716	147	80	1368	90	47	234	376	267	151	29
User Adj:	1.00	1.00	1.00	1.00	1.00	1.00	1.00	1.00	1.00	1.00	1.00	1.00
PHF Adj:	1.00	1.00	1.00	1.00	1.00	1.00	1.00	1.00	1.00	1.00	1.00	1.00
PHF Volume:	161	716	147	80	1368	90	47	234	376	267	151	29
Reduct Vol:	0	0	0	0	0	0	0	0	0	0	0	0
Reduced Vol:	161	716	147	80	1368	90	47	234	376	267	151	29
PCE Adj:	1.00	1.00	1.00	1.00	1.00	1.00	1.00	1.00	1.00	1.00	1.00	1.00
MLF Adj:	1.00	1.00	1.00	1.00	1.00	1.00	1.00	1.00	1.00	1.00	1.00	1.00
Final Volume:	161	716	147	80	1368	90	47	234	376	267	151	29

Saturation Flow Module:												
Sat/Lane:	1900	1900	1900	1900	1900	1900	1900	1900	1900	1900	1900	1900
Adjustment:	0.92	0.98	0.95	0.92	0.98	0.95	0.92	0.95	0.95	0.83	0.95	0.95
Lanes:	1.00	1.65	0.35	1.00	1.87	0.13	1.00	0.38	0.62	2.00	0.84	0.16
Final Sat.:	1750	3069	630	1750	3471	228	1750	690	1110	3150	1510	290

Capacity Analysis Module:												
Vol/Sat:	0.09	0.23	0.23	0.05	0.39	0.39	0.03	0.34	0.34	0.08	0.10	0.10
Crit Moves:	****			****			****			****		
Green Time:	10.9	46.2	46.2	11.5	46.8	46.8	18.5	40.2	40.2	10.1	31.8	31.8
Volume/Cap:	1.01	0.61	0.61	0.48	1.01	1.01	0.17	1.01	1.01	1.01	0.38	0.38
Delay/Veh:	128.7	30.4	30.4	53.5	63.0	63.0	44.4	79.2	79.2	113.1	36.5	36.5
User DelAdj:	1.00	1.00	1.00	1.00	1.00	1.00	1.00	1.00	1.00	1.00	1.00	1.00
AdjDel/Veh:	128.7	30.4	30.4	53.5	63.0	63.0	44.4	79.2	79.2	113.1	36.5	36.5
LOS by Move:	F	C	C	D	E	E	D	E	E	F	D	D
HCM2k95thQ:	16	23	23	7	56	56	3	47	47	15	11	11

Note: Queue reported is the number of cars per lane.

BART Phase II Extension Project

Level Of Service Computation Report
2000 HCM Operations (Future Volume Alternative)
AM - 2035 Project Conditions

Intersection #3710: MONTGOMERY/SAN FERNANDO

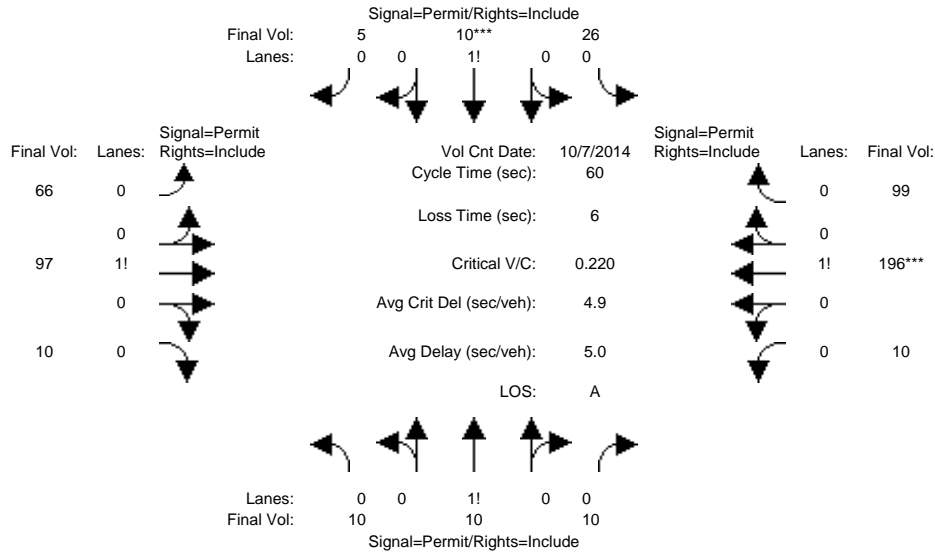

Approach:	North Bound			South Bound			East Bound			West Bound		
Movement:	L	T	R	L	T	R	L	T	R	L	T	R
Min. Green:	10	10	10	10	10	10	10	10	10	10	10	10
Y+R:	4.0	4.0	4.0	4.0	4.0	4.0	4.0	4.0	4.0	4.0	4.0	4.0
Volume Module: >> Count Date: 7 Oct 2014 <<												
Base Vol:	10	10	10	26	10	5	66	97	10	10	196	99
Growth Adj:	1.00	1.00	1.00	1.00	1.00	1.00	1.00	1.00	1.00	1.00	1.00	1.00
Initial Bse:	10	10	10	26	10	5	66	97	10	10	196	99
Added Vol:	0	0	0	0	0	0	0	0	0	0	0	0
PasserByVol:	0	0	0	0	0	0	0	0	0	0	0	0
Initial Fut:	10	10	10	26	10	5	66	97	10	10	196	99
User Adj:	1.00	1.00	1.00	1.00	1.00	1.00	1.00	1.00	1.00	1.00	1.00	1.00
PHF Adj:	1.00	1.00	1.00	1.00	1.00	1.00	1.00	1.00	1.00	1.00	1.00	1.00
PHF Volume:	10	10	10	26	10	5	66	97	10	10	196	99
Reduct Vol:	0	0	0	0	0	0	0	0	0	0	0	0
Reduced Vol:	10	10	10	26	10	5	66	97	10	10	196	99
PCE Adj:	1.00	1.00	1.00	1.00	1.00	1.00	1.00	1.00	1.00	1.00	1.00	1.00
MLF Adj:	1.00	1.00	1.00	1.00	1.00	1.00	1.00	1.00	1.00	1.00	1.00	1.00
FinalVolume:	10	10	10	26	10	5	66	97	10	10	196	99
Saturation Flow Module:												
Sat/Lane:	1900	1900	1900	1900	1900	1900	1900	1900	1900	1900	1900	1900
Adjustment:	0.92	0.92	0.92	0.92	0.92	0.92	0.92	0.92	0.92	0.92	0.92	0.92
Lanes:	0.34	0.33	0.33	0.64	0.24	0.12	0.38	0.56	0.06	0.03	0.65	0.32
Final Sat.:	583	583	583	1110	427	213	668	981	101	57	1125	568
Capacity Analysis Module:												
Vol/Sat:	0.02	0.02	0.02	0.02	0.02	0.02	0.10	0.10	0.10	0.17	0.17	0.17
Crit Moves:	****											
Green Time:	10.0	10.0	10.0	10.0	10.0	10.0	44.0	44.0	44.0	44.0	44.0	44.0
Volume/Cap:	0.10	0.10	0.10	0.14	0.14	0.14	0.13	0.13	0.13	0.24	0.24	0.24
Delay/Veh:	21.4	21.4	21.4	21.6	21.6	21.6	2.4	2.4	2.4	2.7	2.7	2.7
User DelAdj:	1.00	1.00	1.00	1.00	1.00	1.00	1.00	1.00	1.00	1.00	1.00	1.00
AdjDel/Veh:	21.4	21.4	21.4	21.6	21.6	21.6	2.4	2.4	2.4	2.7	2.7	2.7
LOS by Move:	C	C	C	C	C	C	A	A	A	A	A	A
HCM2k95thQ:	1	1	1	1	1	1	2	2	2	4	4	4

Note: Queue reported is the number of cars per lane.

BART Phase II Extension Project

Level Of Service Computation Report
2000 HCM Operations (Future Volume Alternative)
PM - 2035 Project Conditions

Intersection #3710: MONTGOMERY/SAN FERNANDO

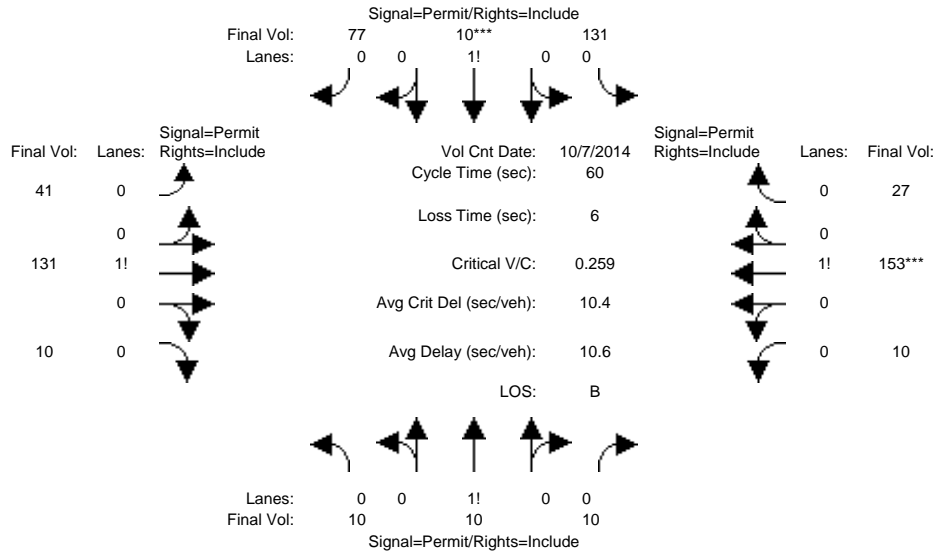

Approach:	North Bound			South Bound			East Bound			West Bound		
	L	T	R	L	T	R	L	T	R	L	T	R
Min. Green:	10	10	10	10	10	10	10	10	10	10	10	10
Y+R:	4.0	4.0	4.0	4.0	4.0	4.0	4.0	4.0	4.0	4.0	4.0	4.0
Volume Module: >> Count Date: 7 Oct 2014 <<												
Base Vol:	10	10	10	131	10	77	41	131	10	10	153	27
Growth Adj:	1.00	1.00	1.00	1.00	1.00	1.00	1.00	1.00	1.00	1.00	1.00	1.00
Initial Bse:	10	10	10	131	10	77	41	131	10	10	153	27
Added Vol:	0	0	0	0	0	0	0	0	0	0	0	0
PasserByVol:	0	0	0	0	0	0	0	0	0	0	0	0
Initial Fut:	10	10	10	131	10	77	41	131	10	10	153	27
User Adj:	1.00	1.00	1.00	1.00	1.00	1.00	1.00	1.00	1.00	1.00	1.00	1.00
PHF Adj:	1.00	1.00	1.00	1.00	1.00	1.00	1.00	1.00	1.00	1.00	1.00	1.00
PHF Volume:	10	10	10	131	10	77	41	131	10	10	153	27
Reduct Vol:	0	0	0	0	0	0	0	0	0	0	0	0
Reduced Vol:	10	10	10	131	10	77	41	131	10	10	153	27
PCE Adj:	1.00	1.00	1.00	1.00	1.00	1.00	1.00	1.00	1.00	1.00	1.00	1.00
MLF Adj:	1.00	1.00	1.00	1.00	1.00	1.00	1.00	1.00	1.00	1.00	1.00	1.00
FinalVolume:	10	10	10	131	10	77	41	131	10	10	153	27
Saturation Flow Module:												
Sat/Lane:	1900	1900	1900	1900	1900	1900	1900	1900	1900	1900	1900	1900
Adjustment:	0.92	0.92	0.92	0.92	0.92	0.92	0.92	0.92	0.92	0.92	0.92	0.92
Lanes:	0.34	0.33	0.33	0.60	0.05	0.35	0.23	0.72	0.05	0.05	0.81	0.14
Final Sat.:	583	583	583	1052	80	618	394	1260	96	92	1409	249
Capacity Analysis Module:												
Vol/Sat:	0.02	0.02	0.02	0.12	0.12	0.12	0.10	0.10	0.10	0.11	0.11	0.11
Crit Moves:	*****											
Green Time:	28.9	28.9	28.9	28.9	28.9	28.9	25.1	25.1	25.1	25.1	25.1	25.1
Volume/Cap:	0.04	0.04	0.04	0.26	0.26	0.26	0.25	0.25	0.25	0.26	0.26	0.26
Delay/Veh:	8.2	8.2	8.2	9.4	9.4	9.4	11.5	11.5	11.5	11.5	11.5	11.5
User DelAdj:	1.00	1.00	1.00	1.00	1.00	1.00	1.00	1.00	1.00	1.00	1.00	1.00
AdjDel/Veh:	8.2	8.2	8.2	9.4	9.4	9.4	11.5	11.5	11.5	11.5	11.5	11.5
LOS by Move:	A	A	A	A	A	A	B	B	B	B	B	B
HCM2k95thQ:	1	1	1	5	5	5	5	5	5	5	5	5

Note: Queue reported is the number of cars per lane.

BART Phase II Extension Project

Level Of Service Computation Report
2000 HCM Operations (Future Volume Alternative)
AM - 2035 Project Conditions

Intersection #3748: RACE/SAN CARLOS

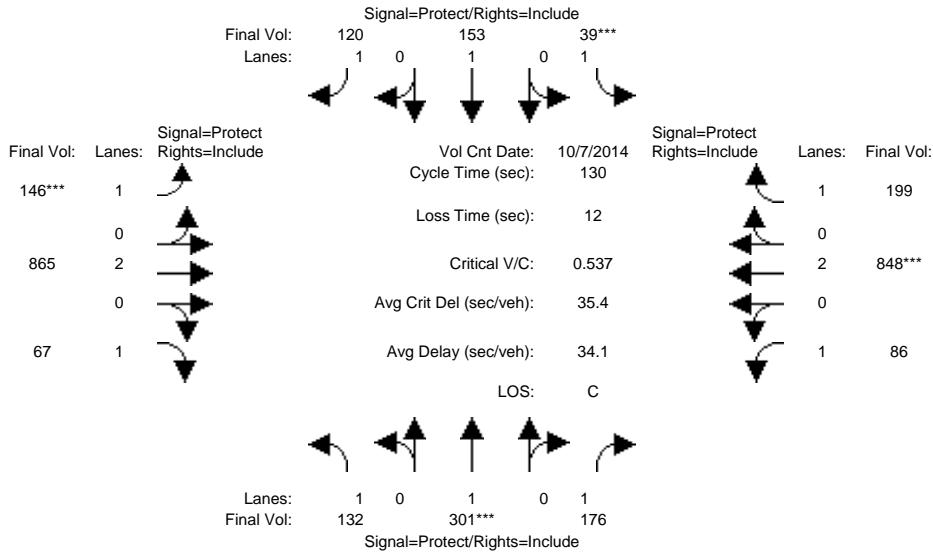

Approach:	North Bound			South Bound			East Bound			West Bound		
Movement:	L	T	R	L	T	R	L	T	R	L	T	R
Min. Green:	7	10	10	7	10	10	7	10	10	7	10	10
Y+R:	4.0	4.0	4.0	4.0	4.0	4.0	4.0	4.0	4.0	4.0	4.0	4.0
Volume Module: >> Count Date: 7 Oct 2014 <<												
Base Vol:	132	301	176	39	153	120	146	865	67	86	848	199
Growth Adj:	1.00	1.00	1.00	1.00	1.00	1.00	1.00	1.00	1.00	1.00	1.00	1.00
Initial Bse:	132	301	176	39	153	120	146	865	67	86	848	199
Added Vol:	0	0	0	0	0	0	0	0	0	0	0	0
PasserByVol:	0	0	0	0	0	0	0	0	0	0	0	0
Initial Fut:	132	301	176	39	153	120	146	865	67	86	848	199
User Adj:	1.00	1.00	1.00	1.00	1.00	1.00	1.00	1.00	1.00	1.00	1.00	1.00
PHF Adj:	1.00	1.00	1.00	1.00	1.00	1.00	1.00	1.00	1.00	1.00	1.00	1.00
PHF Volume:	132	301	176	39	153	120	146	865	67	86	848	199
Reduct Vol:	0	0	0	0	0	0	0	0	0	0	0	0
Reduced Vol:	132	301	176	39	153	120	146	865	67	86	848	199
PCE Adj:	1.00	1.00	1.00	1.00	1.00	1.00	1.00	1.00	1.00	1.00	1.00	1.00
MLF Adj:	1.00	1.00	1.00	1.00	1.00	1.00	1.00	1.00	1.00	1.00	1.00	1.00
FinalVolume:	132	301	176	39	153	120	146	865	67	86	848	199
Saturation Flow Module:												
Sat/Lane:	1900	1900	1900	1900	1900	1900	1900	1900	1900	1900	1900	1900
Adjustment:	0.92	1.00	0.92	0.92	1.00	0.92	0.92	1.00	0.92	0.92	1.00	0.92
Lanes:	1.00	1.00	1.00	1.00	1.00	1.00	1.00	2.00	1.00	1.00	2.00	1.00
Final Sat.:	1750	1900	1750	1750	1900	1750	1750	3800	1750	1750	3800	1750
Capacity Analysis Module:												
Vol/Sat:	0.08	0.16	0.10	0.02	0.08	0.07	0.08	0.23	0.04	0.05	0.22	0.11
Crit Moves:	****			****			****			****		
Green Time:	21.7	37.8	37.8	7.0	23.1	23.1	19.9	59.2	59.2	14.0	53.3	53.3
Volume/Cap:	0.45	0.54	0.35	0.41	0.45	0.39	0.54	0.50	0.08	0.46	0.54	0.28
Delay/Veh:	49.9	40.0	36.7	62.4	48.7	47.9	53.2	25.2	20.1	56.2	29.6	25.8
User DelAdj:	1.00	1.00	1.00	1.00	1.00	1.00	1.00	1.00	1.00	1.00	1.00	1.00
AdjDel/Veh:	49.9	40.0	36.7	62.4	48.7	47.9	53.2	25.2	20.1	56.2	29.6	25.8
LOS by Move:	D	D	D	E	D	D	D	C	C	E	C	C
HCM2k95thQ:	10	18	11	3	10	9	11	21	3	7	22	11

Note: Queue reported is the number of cars per lane.

BART Phase II Extension Project

Level Of Service Computation Report
2000 HCM Operations (Future Volume Alternative)
PM - 2035 Project Conditions

Intersection #3748: RACE/SAN CARLOS

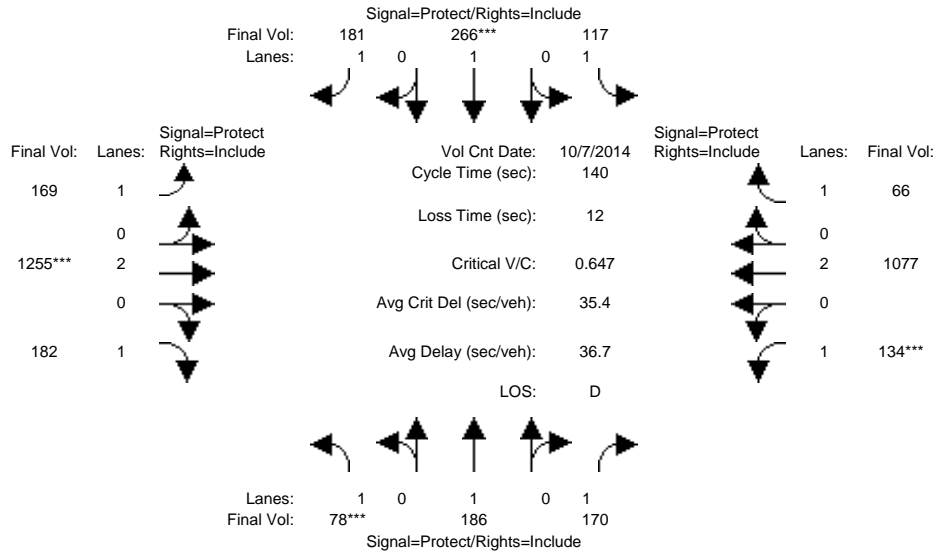

Approach:	North Bound			South Bound			East Bound			West Bound		
Movement:	L	T	R	L	T	R	L	T	R	L	T	R
Min. Green:	7	10	10	7	10	10	7	10	10	7	10	10
Y+R:	4.0	4.0	4.0	4.0	4.0	4.0	4.0	4.0	4.0	4.0	4.0	4.0
Volume Module: >> Count Date: 7 Oct 2014 <<												
Base Vol:	78	186	170	117	266	181	169	1255	182	134	1077	66
Growth Adj:	1.00	1.00	1.00	1.00	1.00	1.00	1.00	1.00	1.00	1.00	1.00	1.00
Initial Bse:	78	186	170	117	266	181	169	1255	182	134	1077	66
Added Vol:	0	0	0	0	0	0	0	0	0	0	0	0
PasserByVol:	0	0	0	0	0	0	0	0	0	0	0	0
Initial Fut:	78	186	170	117	266	181	169	1255	182	134	1077	66
User Adj:	1.00	1.00	1.00	1.00	1.00	1.00	1.00	1.00	1.00	1.00	1.00	1.00
PHF Adj:	1.00	1.00	1.00	1.00	1.00	1.00	1.00	1.00	1.00	1.00	1.00	1.00
PHF Volume:	78	186	170	117	266	181	169	1255	182	134	1077	66
Reduct Vol:	0	0	0	0	0	0	0	0	0	0	0	0
Reduced Vol:	78	186	170	117	266	181	169	1255	182	134	1077	66
PCE Adj:	1.00	1.00	1.00	1.00	1.00	1.00	1.00	1.00	1.00	1.00	1.00	1.00
MLF Adj:	1.00	1.00	1.00	1.00	1.00	1.00	1.00	1.00	1.00	1.00	1.00	1.00
FinalVolume:	78	186	170	117	266	181	169	1255	182	134	1077	66
Saturation Flow Module:												
Sat/Lane:	1900	1900	1900	1900	1900	1900	1900	1900	1900	1900	1900	1900
Adjustment:	0.92	1.00	0.92	0.92	1.00	0.92	0.92	1.00	0.92	0.92	1.00	0.92
Lanes:	1.00	1.00	1.00	1.00	1.00	1.00	1.00	2.00	1.00	1.00	2.00	1.00
Final Sat.:	1750	1900	1750	1750	1900	1750	1750	3800	1750	1750	3800	1750
Capacity Analysis Module:												
Vol/Sat:	0.04	0.10	0.10	0.07	0.14	0.10	0.10	0.33	0.10	0.08	0.28	0.04
Crit Moves:	****			****			****			****		
Green Time:	9.6	23.7	23.7	16.2	30.3	30.3	22.4	71.5	71.5	16.6	65.7	65.7
Volume/Cap:	0.65	0.58	0.57	0.58	0.65	0.48	0.60	0.65	0.20	0.65	0.60	0.08
Delay/Veh:	75.1	56.1	56.2	62.7	53.5	48.9	58.4	25.8	18.8	65.9	28.1	20.5
User DelAdj:	1.00	1.00	1.00	1.00	1.00	1.00	1.00	1.00	1.00	1.00	1.00	1.00
AdjDel/Veh:	75.1	56.1	56.2	62.7	53.5	48.9	58.4	25.8	18.8	65.9	28.1	20.5
LOS by Move:	E	E	E	E	D	D	E	C	B	E	C	C
HCM2k95thQ:	7	14	14	10	19	14	14	33	9	12	29	3

Note: Queue reported is the number of cars per lane.

BART Phase II Extension Project

Level Of Service Computation Report
2000 HCM Operations (Future Volume Alternative)
AM - 2035 Project Conditions

Intersection #3985: DELMAS/SAN FERNANDO

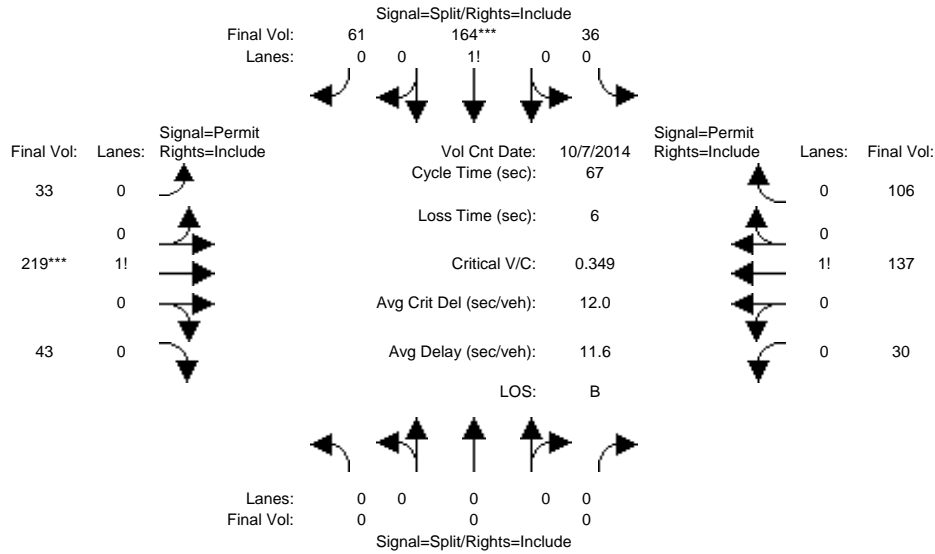

Approach:	North Bound			South Bound			East Bound			West Bound		
	L	T	R	L	T	R	L	T	R	L	T	R
Min. Green:	0	0	0	10	10	10	10	10	10	10	10	10
Y+R:	4.0	4.0	4.0	4.0	4.0	4.0	4.0	4.0	4.0	4.0	4.0	4.0
Volume Module: >> Count Date: 7 Oct 2014 <<												
Base Vol:	0	0	0	36	164	61	33	219	43	30	137	106
Growth Adj:	1.00	1.00	1.00	1.00	1.00	1.00	1.00	1.00	1.00	1.00	1.00	1.00
Initial Bse:	0	0	0	36	164	61	33	219	43	30	137	106
Added Vol:	0	0	0	0	0	0	0	0	0	0	0	0
PasserByVol:	0	0	0	0	0	0	0	0	0	0	0	0
Initial Fut:	0	0	0	36	164	61	33	219	43	30	137	106
User Adj:	1.00	1.00	1.00	1.00	1.00	1.00	1.00	1.00	1.00	1.00	1.00	1.00
PHF Adj:	1.00	1.00	1.00	1.00	1.00	1.00	1.00	1.00	1.00	1.00	1.00	1.00
PHF Volume:	0	0	0	36	164	61	33	219	43	30	137	106
Reduct Vol:	0	0	0	0	0	0	0	0	0	0	0	0
Reduced Vol:	0	0	0	36	164	61	33	219	43	30	137	106
PCE Adj:	1.00	1.00	1.00	1.00	1.00	1.00	1.00	1.00	1.00	1.00	1.00	1.00
MLF Adj:	1.00	1.00	1.00	1.00	1.00	1.00	1.00	1.00	1.00	1.00	1.00	1.00
FinalVolume:	0	0	0	36	164	61	33	219	43	30	137	106
Saturation Flow Module:												
Sat/Lane:	1900	1900	1900	1900	1900	1900	1900	1900	1900	1900	1900	1900
Adjustment:	0.92	1.00	0.92	0.92	0.92	0.92	0.92	0.92	0.92	0.92	0.92	0.92
Lanes:	0.00	0.00	0.00	0.14	0.63	0.23	0.11	0.74	0.15	0.11	0.50	0.39
Final Sat.:	0	0	0	241	1100	409	196	1299	255	192	878	679
Capacity Analysis Module:												
Vol/Sat:	0.00	0.00	0.00	0.15	0.15	0.15	0.17	0.17	0.17	0.16	0.16	0.16
Crit Moves:				****			****					
Green Time:	0.0	0.0	0.0	28.6	28.6	28.6	32.4	32.4	32.4	32.4	32.4	32.4
Volume/Cap:	0.00	0.00	0.00	0.35	0.35	0.35	0.35	0.35	0.35	0.32	0.32	0.32
Delay/Veh:	0.0	0.0	0.0	13.2	13.2	13.2	11.0	11.0	11.0	10.8	10.8	10.8
User DelAdj:	1.00	1.00	1.00	1.00	1.00	1.00	1.00	1.00	1.00	1.00	1.00	1.00
AdjDel/Veh:	0.0	0.0	0.0	13.2	13.2	13.2	11.0	11.0	11.0	10.8	10.8	10.8
LOS by Move:	A	A	A	B	B	B	B	B	B	B	B	B
HCM2k95thQ:	0	0	0	8	8	8	8	8	8	7	7	7

Note: Queue reported is the number of cars per lane.

BART Phase II Extension Project

Level Of Service Computation Report
2000 HCM Operations (Future Volume Alternative)
PM - 2035 Project Conditions

Intersection #3985: DELMAS/SAN FERNANDO

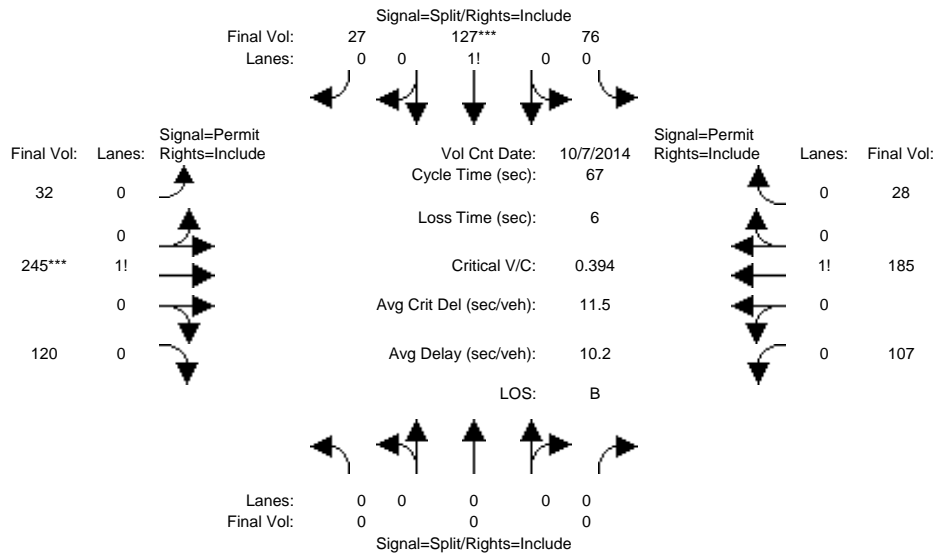

Approach:	North Bound			South Bound			East Bound			West Bound		
	L	T	R	L	T	R	L	T	R	L	T	R
Min. Green:	0	0	0	10	10	10	10	10	10	10	10	10
Y+R:	4.0	4.0	4.0	4.0	4.0	4.0	4.0	4.0	4.0	4.0	4.0	4.0
Volume Module: >> Count Date: 7 Oct 2014 <<												
Base Vol:	0	0	0	76	127	27	32	245	120	107	185	28
Growth Adj:	1.00	1.00	1.00	1.00	1.00	1.00	1.00	1.00	1.00	1.00	1.00	1.00
Initial Bse:	0	0	0	76	127	27	32	245	120	107	185	28
Added Vol:	0	0	0	0	0	0	0	0	0	0	0	0
PasserByVol:	0	0	0	0	0	0	0	0	0	0	0	0
Initial Fut:	0	0	0	76	127	27	32	245	120	107	185	28
User Adj:	1.00	1.00	1.00	1.00	1.00	1.00	1.00	1.00	1.00	1.00	1.00	1.00
PHF Adj:	1.00	1.00	1.00	1.00	1.00	1.00	1.00	1.00	1.00	1.00	1.00	1.00
PHF Volume:	0	0	0	76	127	27	32	245	120	107	185	28
Reduct Vol:	0	0	0	0	0	0	0	0	0	0	0	0
Reduced Vol:	0	0	0	76	127	27	32	245	120	107	185	28
PCE Adj:	1.00	1.00	1.00	1.00	1.00	1.00	1.00	1.00	1.00	1.00	1.00	1.00
MLF Adj:	1.00	1.00	1.00	1.00	1.00	1.00	1.00	1.00	1.00	1.00	1.00	1.00
FinalVolume:	0	0	0	76	127	27	32	245	120	107	185	28
Saturation Flow Module:												
Sat/Lane:	1900	1900	1900	1900	1900	1900	1900	1900	1900	1900	1900	1900
Adjustment:	0.92	1.00	0.92	0.92	0.92	0.92	0.92	0.92	0.92	0.92	0.92	0.92
Lanes:	0.00	0.00	0.00	0.33	0.55	0.12	0.08	0.62	0.30	0.33	0.58	0.09
Final Sat.:	0	0	0	578	966	205	141	1080	529	585	1012	153
Capacity Analysis Module:												
Vol/Sat:	0.00	0.00	0.00	0.13	0.13	0.13	0.23	0.23	0.23	0.18	0.18	0.18
Crit Moves:				****			****					
Green Time:	0.0	0.0	0.0	22.4	22.4	22.4	38.6	38.6	38.6	38.6	38.6	38.6
Volume/Cap:	0.00	0.00	0.00	0.39	0.39	0.39	0.39	0.39	0.39	0.32	0.32	0.32
Delay/Veh:	0.0	0.0	0.0	17.5	17.5	17.5	8.0	8.0	8.0	7.5	7.5	7.5
User DelAdj:	1.00	1.00	1.00	1.00	1.00	1.00	1.00	1.00	1.00	1.00	1.00	1.00
AdjDel/Veh:	0.0	0.0	0.0	17.5	17.5	17.5	8.0	8.0	8.0	7.5	7.5	7.5
LOS by Move:	A	A	A	B	B	B	A	A	A	A	A	A
HCM2k95thQ:	0	0	0	8	8	8	9	9	9	7	7	7

Note: Queue reported is the number of cars per lane.

Appendix G

Level of Service Calculations – Santa Clara Station

BART Phase II Extension Project

Level Of Service Computation Report
 2000 HCM Operations (Future Volume Alternative)
 AM - Existing Conditions

Intersection #6: DE LA CRUZ/MARTIN

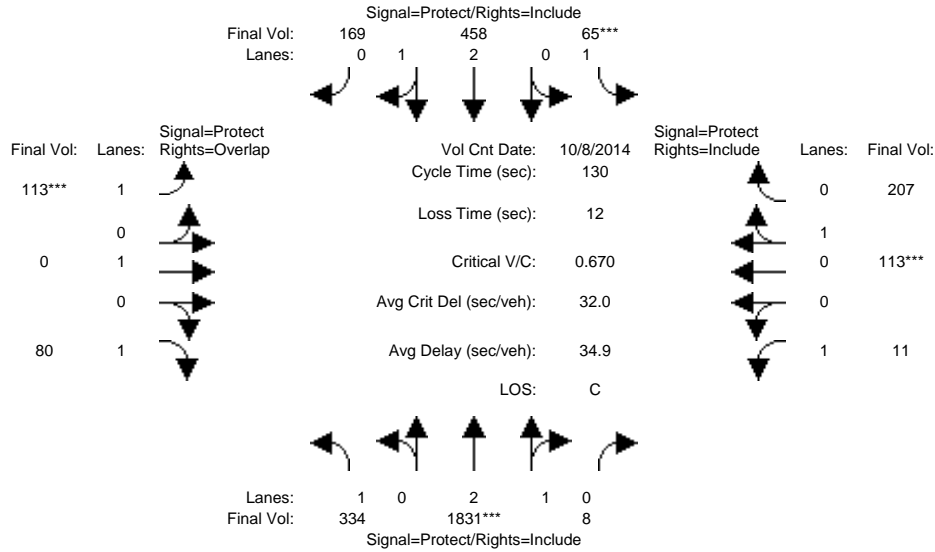

Approach:	North Bound			South Bound			East Bound			West Bound		
	L	T	R	L	T	R	L	T	R	L	T	R
Movement:												
Min. Green:	7	10	10	7	10	10	7	10	10	7	10	10
Y+R:	4.0	4.0	4.0	4.0	4.0	4.0	4.0	4.0	4.0	4.0	4.0	4.0

Volume Module:	>>	Count	Date:	8 Oct 2014	<<							
Base Vol:	334	1831	8	65	458	169	113	0	80	11	113	207
Growth Adj:	1.00	1.00	1.00	1.00	1.00	1.00	1.00	1.00	1.00	1.00	1.00	1.00
Initial Bse:	334	1831	8	65	458	169	113	0	80	11	113	207
Added Vol:	0	0	0	0	0	0	0	0	0	0	0	0
PasserByVol:	0	0	0	0	0	0	0	0	0	0	0	0
Initial Fut:	334	1831	8	65	458	169	113	0	80	11	113	207
User Adj:	1.00	1.00	1.00	1.00	1.00	1.00	1.00	1.00	1.00	1.00	1.00	1.00
PHF Adj:	1.00	1.00	1.00	1.00	1.00	1.00	1.00	1.00	1.00	1.00	1.00	1.00
PHF Volume:	334	1831	8	65	458	169	113	0	80	11	113	207
Reduct Vol:	0	0	0	0	0	0	0	0	0	0	0	0
Reduced Vol:	334	1831	8	65	458	169	113	0	80	11	113	207
PCE Adj:	1.00	1.00	1.00	1.00	1.00	1.00	1.00	1.00	1.00	1.00	1.00	1.00
MLF Adj:	1.00	1.00	1.00	1.00	1.00	1.00	1.00	1.00	1.00	1.00	1.00	1.00
Final Volume:	334	1831	8	65	458	169	113	0	80	11	113	207

Saturation Flow Module:	Sat/Lane:	1900	1900	1900	1900	1900	1900	1900	1900	1900	1900	1900
Adjustment:	0.92	0.98	0.95	0.92	1.00	0.95	0.92	1.00	0.92	0.92	0.95	0.95
Lanes:	1.00	2.99	0.01	1.00	2.16	0.84	1.00	1.00	1.00	1.00	0.35	0.65
Final Sat.:	1750	5576	24	1750	4089	1509	1750	1900	1750	1750	636	1164

Capacity Analysis Module:	Vol/Sat:	0.19	0.33	0.33	0.04	0.11	0.11	0.06	0.00	0.05	0.01	0.18	0.18
Crit Moves:	****	****	****	****	****	****	****	****	****	****	****	****	****
Green Time:	44.7	63.7	63.7	7.2	26.2	26.2	12.5	0.0	57.2	47.0	34.5	34.5	
Volume/Cap:	0.55	0.67	0.67	0.67	0.55	0.55	0.67	0.00	0.10	0.02	0.67	0.67	
Delay/Veh:	35.7	25.8	25.8	76.9	47.2	47.2	66.7	0.0	21.4	26.6	46.3	46.3	
User DelAdj:	1.00	1.00	1.00	1.00	1.00	1.00	1.00	1.00	1.00	1.00	1.00	1.00	
AdjDel/Veh:	35.7	25.8	25.8	76.9	47.2	47.2	66.7	0.0	21.4	26.6	46.3	46.3	
LOS by Move:	D	C	C	E	D	D	E	A	C	C	D	D	
HCM2k95thQ:	21	32	32	6	14	14	10	0	4	1	23	23	

Note: Queue reported is the number of cars per lane.

BART Phase II Extension Project

Level Of Service Computation Report
2000 HCM Operations (Future Volume Alternative)
PM - Existing Conditions

Intersection #6: DE LA CRUZ/MARTIN

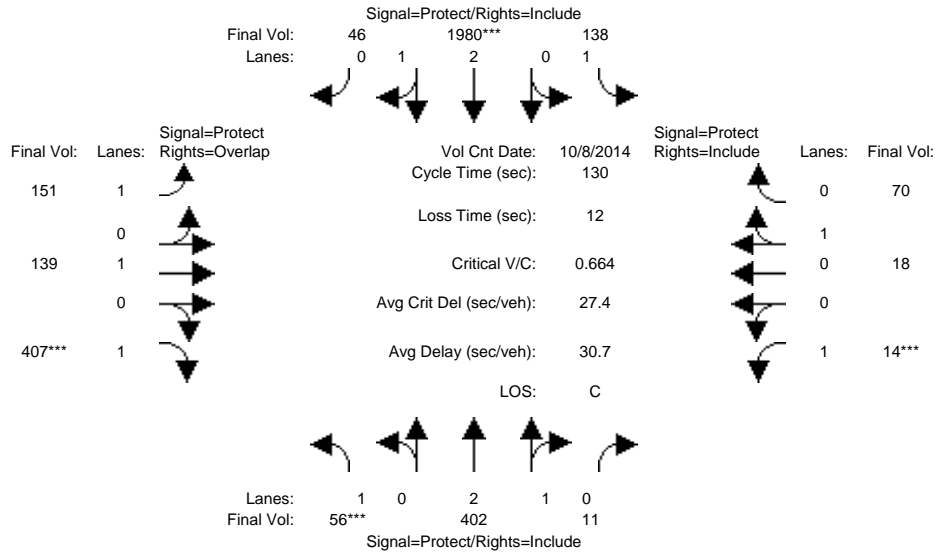

Approach:	North Bound			South Bound			East Bound			West Bound		
	L	T	R	L	T	R	L	T	R	L	T	R
Min. Green:	7	10	10	7	10	10	7	10	10	7	10	10
Y+R:	4.0	4.0	4.0	4.0	4.0	4.0	4.0	4.0	4.0	4.0	4.0	4.0

Volume Module:	>> Count Date: 8 Oct 2014 <<											
Base Vol:	56	402	11	138	1980	46	151	139	407	14	18	70
Growth Adj:	1.00	1.00	1.00	1.00	1.00	1.00	1.00	1.00	1.00	1.00	1.00	1.00
Initial Bse:	56	402	11	138	1980	46	151	139	407	14	18	70
Added Vol:	0	0	0	0	0	0	0	0	0	0	0	0
PasserByVol:	0	0	0	0	0	0	0	0	0	0	0	0
Initial Fut:	56	402	11	138	1980	46	151	139	407	14	18	70
User Adj:	1.00	1.00	1.00	1.00	1.00	1.00	1.00	1.00	1.00	1.00	1.00	1.00
PHF Adj:	1.00	1.00	1.00	1.00	1.00	1.00	1.00	1.00	1.00	1.00	1.00	1.00
PHF Volume:	56	402	11	138	1980	46	151	139	407	14	18	70
Reduct Vol:	0	0	0	0	0	0	0	0	0	0	0	0
Reduced Vol:	56	402	11	138	1980	46	151	139	407	14	18	70
PCE Adj:	1.00	1.00	1.00	1.00	1.00	1.00	1.00	1.00	1.00	1.00	1.00	1.00
MLF Adj:	1.00	1.00	1.00	1.00	1.00	1.00	1.00	1.00	1.00	1.00	1.00	1.00
FinalVolume:	56	402	11	138	1980	46	151	139	407	14	18	70

Saturation Flow Module:												
Sat/Lane:	1900	1900	1900	1900	1900	1900	1900	1900	1900	1900	1900	1900
Adjustment:	0.92	0.98	0.95	0.92	0.98	0.95	0.92	1.00	0.92	0.92	0.95	0.95
Lanes:	1.00	2.92	0.08	1.00	2.93	0.07	1.00	1.00	1.00	1.00	0.20	0.80
Final Sat.:	1750	5451	149	1750	5473	127	1750	1900	1750	1750	368	1432

Capacity Analysis Module:												
Vol/Sat:	0.03	0.07	0.07	0.08	0.36	0.36	0.09	0.07	0.23	0.01	0.05	0.05
Crit Moves:	****			****			****		****	****		
Green Time:	7.0	37.8	37.8	38.8	69.6	69.6	21.9	34.4	41.4	7.0	19.5	19.5
Volume/Cap:	0.59	0.25	0.25	0.26	0.68	0.68	0.51	0.28	0.73	0.15	0.33	0.33
Delay/Veh:	70.0	35.4	35.4	35.0	22.6	22.6	50.7	38.2	44.3	59.4	50.1	50.1
User DelAdj:	1.00	1.00	1.00	1.00	1.00	1.00	1.00	1.00	1.00	1.00	1.00	1.00
AdjDel/Veh:	70.0	35.4	35.4	35.0	22.6	22.6	50.7	38.2	44.3	59.4	50.1	50.1
LOS by Move:	E	D	D	D	C	C	D	D	D	E	D	D
HCM2k95thQ:	5	8	8	9	34	34	11	8	28	1	7	7

Note: Queue reported is the number of cars per lane.

BART Phase II Extension Project

Level Of Service Computation Report
 2000 HCM Operations (Future Volume Alternative)
 AM - Existing Conditions

Intersection #7: LAFAYETTE/REED

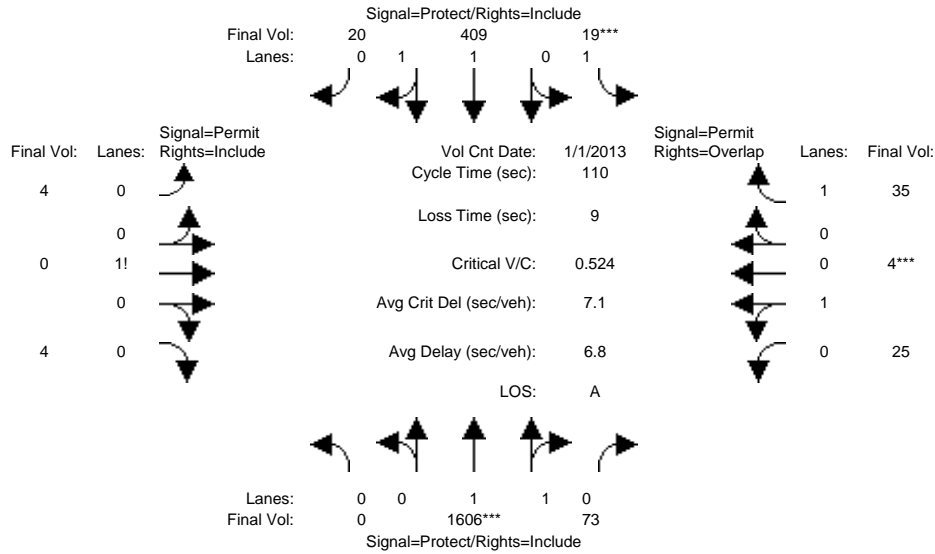

Approach:	North Bound			South Bound			East Bound			West Bound		
	L	T	R	L	T	R	L	T	R	L	T	R
Min. Green:	7	10	10	7	10	10	10	10	10	10	10	10
Y+R:	4.0	4.0	4.0	4.0	4.0	4.0	4.0	4.0	4.0	4.0	4.0	4.0
Volume Module: >> Count Date: 1 Jan 2013 <<												
Base Vol:	0	1606	73	19	409	20	4	0	4	25	4	35
Growth Adj:	1.00	1.00	1.00	1.00	1.00	1.00	1.00	1.00	1.00	1.00	1.00	1.00
Initial Bse:	0	1606	73	19	409	20	4	0	4	25	4	35
Added Vol:	0	0	0	0	0	0	0	0	0	0	0	0
PasserByVol:	0	0	0	0	0	0	0	0	0	0	0	0
Initial Fut:	0	1606	73	19	409	20	4	0	4	25	4	35
User Adj:	1.00	1.00	1.00	1.00	1.00	1.00	1.00	1.00	1.00	1.00	1.00	1.00
PHF Adj:	1.00	1.00	1.00	1.00	1.00	1.00	1.00	1.00	1.00	1.00	1.00	1.00
PHF Volume:	0	1606	73	19	409	20	4	0	4	25	4	35
Reduct Vol:	0	0	0	0	0	0	0	0	0	0	0	0
Reduced Vol:	0	1606	73	19	409	20	4	0	4	25	4	35
PCE Adj:	1.00	1.00	1.00	1.00	1.00	1.00	1.00	1.00	1.00	1.00	1.00	1.00
MLF Adj:	1.00	1.00	1.00	1.00	1.00	1.00	1.00	1.00	1.00	1.00	1.00	1.00
FinalVolume:	0	1606	73	19	409	20	4	0	4	25	4	35
Saturation Flow Module:												
Sat/Lane:	1900	1900	1900	1900	1900	1900	1900	1900	1900	1900	1900	1900
Adjustment:	0.92	0.97	0.95	0.92	0.97	0.95	0.92	0.92	0.92	0.95	0.95	0.92
Lanes:	0.00	1.91	0.09	1.00	1.90	0.10	0.50	0.00	0.50	0.86	0.14	1.00
Final Sat.:	0	3539	161	1750	3527	172	875	0	875	1552	248	1750
Capacity Analysis Module:												
Vol/Sat:	0.00	0.45	0.45	0.01	0.12	0.12	0.00	0.00	0.00	0.02	0.02	0.02
Crit Moves:	****			****						****		
Green Time:	0.0	84.0	84.0	7.0	91.0	91.0	10.0	0.0	10.0	10.0	10.0	17.0
Volume/Cap:	0.00	0.59	0.59	0.17	0.14	0.14	0.05	0.00	0.05	0.18	0.18	0.13
Delay/Veh:	0.0	6.0	6.0	49.5	1.9	1.9	45.8	0.0	45.8	46.7	46.7	40.3
User DelAdj:	1.00	1.00	1.00	1.00	1.00	1.00	1.00	1.00	1.00	1.00	1.00	1.00
AdjDel/Veh:	0.0	6.0	6.0	49.5	1.9	1.9	45.8	0.0	45.8	46.7	46.7	40.3
LOS by Move:	A	A	A	D	A	A	D	A	D	D	D	D
HCM2k95thQ:	0	23	23	1	3	3	1	0	1	2	2	2

Note: Queue reported is the number of cars per lane.

BART Phase II Extension Project

Level Of Service Computation Report
2000 HCM Operations (Future Volume Alternative)
PM - Existing Conditions

Intersection #7: LAFAYETTE/REED

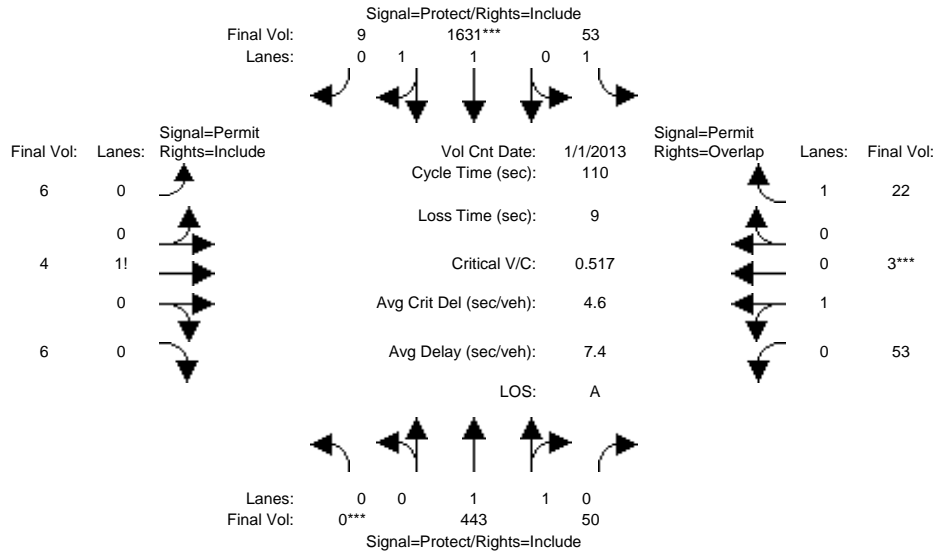

Approach:	North Bound			South Bound			East Bound			West Bound		
Movement:	L	T	R	L	T	R	L	T	R	L	T	R
Min. Green:	7	10	10	7	10	10	10	10	10	10	10	10
Y+R:	4.0	4.0	4.0	4.0	4.0	4.0	4.0	4.0	4.0	4.0	4.0	4.0
Volume Module: >> Count Date: 1 Jan 2013 <<												
Base Vol:	0	443	50	53	1631	9	6	4	6	53	3	22
Growth Adj:	1.00	1.00	1.00	1.00	1.00	1.00	1.00	1.00	1.00	1.00	1.00	1.00
Initial Bse:	0	443	50	53	1631	9	6	4	6	53	3	22
Added Vol:	0	0	0	0	0	0	0	0	0	0	0	0
PasserByVol:	0	0	0	0	0	0	0	0	0	0	0	0
Initial Fut:	0	443	50	53	1631	9	6	4	6	53	3	22
User Adj:	1.00	1.00	1.00	1.00	1.00	1.00	1.00	1.00	1.00	1.00	1.00	1.00
PHF Adj:	1.00	1.00	1.00	1.00	1.00	1.00	1.00	1.00	1.00	1.00	1.00	1.00
PHF Volume:	0	443	50	53	1631	9	6	4	6	53	3	22
Reduct Vol:	0	0	0	0	0	0	0	0	0	0	0	0
Reduced Vol:	0	443	50	53	1631	9	6	4	6	53	3	22
PCE Adj:	1.00	1.00	1.00	1.00	1.00	1.00	1.00	1.00	1.00	1.00	1.00	1.00
MLF Adj:	1.00	1.00	1.00	1.00	1.00	1.00	1.00	1.00	1.00	1.00	1.00	1.00
FinalVolume:	0	443	50	53	1631	9	6	4	6	53	3	22
Saturation Flow Module:												
Sat/Lane:	1900	1900	1900	1900	1900	1900	1900	1900	1900	1900	1900	1900
Adjustment:	0.92	0.98	0.95	0.92	0.97	0.95	0.92	0.92	0.92	0.95	0.95	0.92
Lanes:	0.00	1.79	0.21	1.00	1.99	0.01	0.37	0.25	0.38	0.95	0.05	1.00
Final Sat.:	0	3324	375	1750	3680	20	656	438	656	1704	96	1750
Capacity Analysis Module:												
Vol/Sat:	0.00	0.13	0.13	0.03	0.44	0.44	0.01	0.01	0.01	0.03	0.03	0.01
Crit Moves:	****				****						****	
Green Time:	0.0	61.6	61.6	29.4	91.0	91.0	10.0	10.0	10.0	10.0	10.0	39.4
Volume/Cap:	0.00	0.24	0.24	0.11	0.54	0.54	0.10	0.10	0.10	0.34	0.34	0.04
Delay/Veh:	0.0	12.4	12.4	30.6	3.1	3.1	46.2	46.2	46.2	48.2	48.2	23.0
User DelAdj:	1.00	1.00	1.00	1.00	1.00	1.00	1.00	1.00	1.00	1.00	1.00	1.00
AdjDel/Veh:	0.0	12.4	12.4	30.6	3.1	3.1	46.2	46.2	46.2	48.2	48.2	23.0
LOS by Move:	A	B	B	C	A	A	D	D	D	D	D	C
HCM2k95thQ:	0	8	8	3	17	17	1	1	1	4	4	1

Note: Queue reported is the number of cars per lane.

BART Phase II Extension Project

Level Of Service Computation Report
2000 HCM Operations (Future Volume Alternative)
AM - Existing Conditions

Intersection #9: Coleman/Brokaw

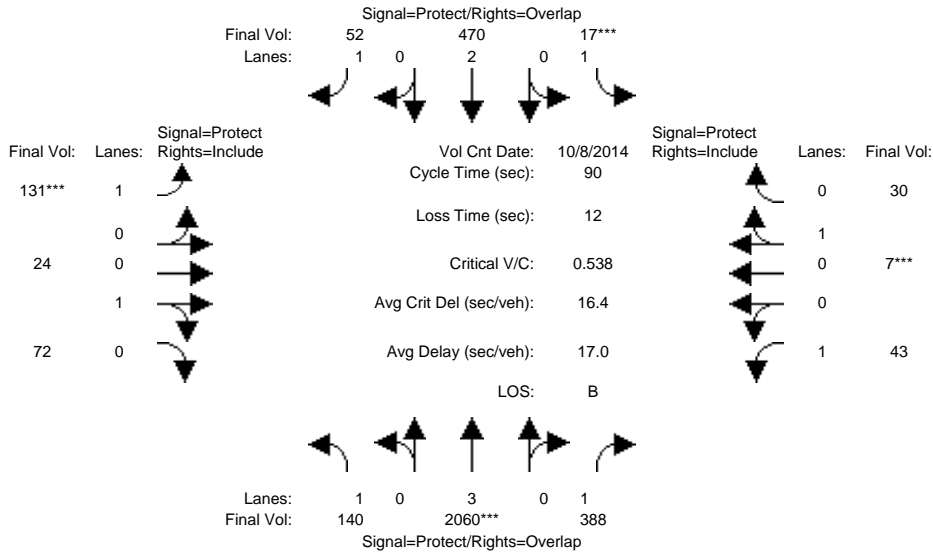

Approach:	North Bound			South Bound			East Bound			West Bound		
	L	T	R	L	T	R	L	T	R	L	T	R
Min. Green:	7	10	10	7	10	10	7	10	10	7	10	10
Y+R:	4.0	4.0	4.0	4.0	4.0	4.0	4.0	4.0	4.0	4.0	4.0	4.0
Volume Module: >> Count Date: 8 Oct 2014 <<												
Base Vol:	140	2060	388	17	470	52	131	24	72	43	7	30
Growth Adj:	1.00	1.00	1.00	1.00	1.00	1.00	1.00	1.00	1.00	1.00	1.00	1.00
Initial Bse:	140	2060	388	17	470	52	131	24	72	43	7	30
Added Vol:	0	0	0	0	0	0	0	0	0	0	0	0
PasserByVol:	0	0	0	0	0	0	0	0	0	0	0	0
Initial Fut:	140	2060	388	17	470	52	131	24	72	43	7	30
User Adj:	1.00	1.00	1.00	1.00	1.00	1.00	1.00	1.00	1.00	1.00	1.00	1.00
PHF Adj:	1.00	1.00	1.00	1.00	1.00	1.00	1.00	1.00	1.00	1.00	1.00	1.00
PHF Volume:	140	2060	388	17	470	52	131	24	72	43	7	30
Reduct Vol:	0	0	0	0	0	0	0	0	0	0	0	0
Reduced Vol:	140	2060	388	17	470	52	131	24	72	43	7	30
PCE Adj:	1.00	1.00	1.00	1.00	1.00	1.00	1.00	1.00	1.00	1.00	1.00	1.00
MLF Adj:	1.00	1.00	1.00	1.00	1.00	1.00	1.00	1.00	1.00	1.00	1.00	1.00
FinalVolume:	140	2060	388	17	470	52	131	24	72	43	7	30
Saturation Flow Module:												
Sat/Lane:	1900	1900	1900	1900	1900	1900	1900	1900	1900	1900	1900	1900
Adjustment:	0.92	1.00	0.92	0.92	1.00	0.92	0.92	0.95	0.95	0.92	0.95	0.95
Lanes:	1.00	3.00	1.00	1.00	2.00	1.00	1.00	0.25	0.75	1.00	0.19	0.81
Final Sat.:	1750	5700	1750	1750	3800	1750	1750	450	1350	1750	341	1459
Capacity Analysis Module:												
Vol/Sat:	0.08	0.36	0.22	0.01	0.12	0.03	0.07	0.05	0.05	0.02	0.02	0.02
Crit Moves:	****			****			****			****		
Green Time:	22.6	50.5	59.0	7.0	34.9	45.4	10.5	12.0	12.0	8.4	10.0	10.0
Volume/Cap:	0.32	0.64	0.34	0.12	0.32	0.06	0.64	0.40	0.40	0.26	0.19	0.19
Delay/Veh:	27.9	14.0	7.1	39.1	19.3	11.4	44.9	36.8	36.8	38.8	36.8	36.8
User DelAdj:	1.00	1.00	1.00	1.00	1.00	1.00	1.00	1.00	1.00	1.00	1.00	1.00
AdjDel/Veh:	27.9	14.0	7.1	39.1	19.3	11.4	44.9	36.8	36.8	38.8	36.8	36.8
LOS by Move:	C	B	A	D	B	B	D	D	D	D	D	D
HCM2k95thQ:	6	22	9	1	9	2	10	6	6	2	2	2

Note: Queue reported is the number of cars per lane.

BART Phase II Extension Project

Level Of Service Computation Report
2000 HCM Operations (Future Volume Alternative)
PM - Existing Conditions

Intersection #9: Coleman/Brokaw

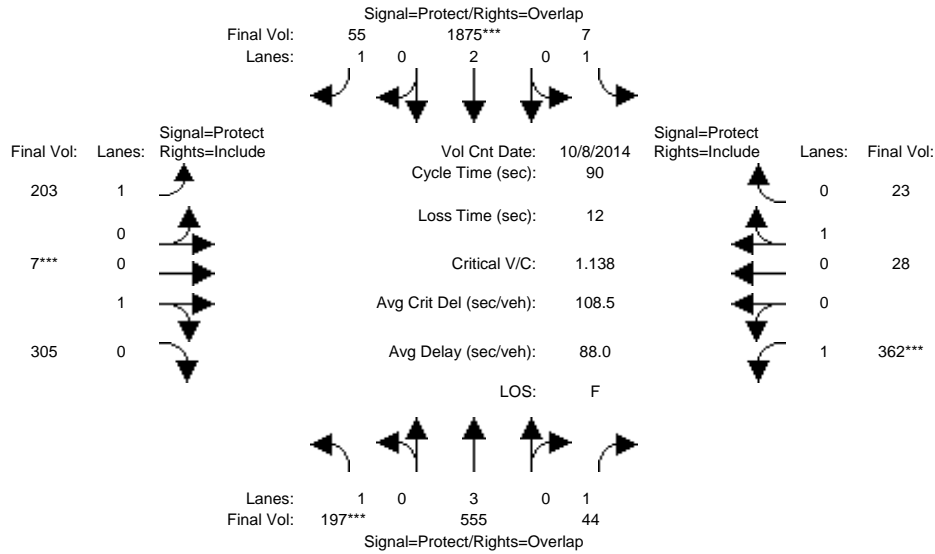

Approach:	North Bound			South Bound			East Bound			West Bound		
Movement:	L	T	R	L	T	R	L	T	R	L	T	R
Min. Green:	7	10	10	7	10	10	7	10	10	7	10	10
Y+R:	4.0	4.0	4.0	4.0	4.0	4.0	4.0	4.0	4.0	4.0	4.0	4.0
Volume Module: >> Count Date: 8 Oct 2014 <<												
Base Vol:	197	555	44	7	1875	55	203	7	305	362	28	23
Growth Adj:	1.00	1.00	1.00	1.00	1.00	1.00	1.00	1.00	1.00	1.00	1.00	1.00
Initial Bse:	197	555	44	7	1875	55	203	7	305	362	28	23
Added Vol:	0	0	0	0	0	0	0	0	0	0	0	0
PasserByVol:	0	0	0	0	0	0	0	0	0	0	0	0
Initial Fut:	197	555	44	7	1875	55	203	7	305	362	28	23
User Adj:	1.00	1.00	1.00	1.00	1.00	1.00	1.00	1.00	1.00	1.00	1.00	1.00
PHF Adj:	1.00	1.00	1.00	1.00	1.00	1.00	1.00	1.00	1.00	1.00	1.00	1.00
PHF Volume:	197	555	44	7	1875	55	203	7	305	362	28	23
Reduct Vol:	0	0	0	0	0	0	0	0	0	0	0	0
Reduced Vol:	197	555	44	7	1875	55	203	7	305	362	28	23
PCE Adj:	1.00	1.00	1.00	1.00	1.00	1.00	1.00	1.00	1.00	1.00	1.00	1.00
MLF Adj:	1.00	1.00	1.00	1.00	1.00	1.00	1.00	1.00	1.00	1.00	1.00	1.00
FinalVolume:	197	555	44	7	1875	55	203	7	305	362	28	23
Saturation Flow Module:												
Sat/Lane:	1900	1900	1900	1900	1900	1900	1900	1900	1900	1900	1900	1900
Adjustment:	0.92	1.00	0.92	0.92	1.00	0.92	0.92	0.95	0.95	0.92	0.95	0.95
Lanes:	1.00	3.00	1.00	1.00	2.00	1.00	1.00	0.02	0.98	1.00	0.55	0.45
Final Sat.:	1750	5700	1750	1750	3800	1750	1750	40	1760	1750	988	812
Capacity Analysis Module:												
Vol/Sat:	0.11	0.10	0.03	0.00	0.49	0.03	0.12	0.17	0.17	0.21	0.03	0.03
Crit Moves:	****				****			****		****		
Green Time:	8.9	28.2	44.6	19.7	39.0	54.4	15.4	13.7	13.7	16.4	14.7	14.7
Volume/Cap:	1.14	0.31	0.05	0.02	1.14	0.05	0.68	1.14	1.14	1.14	0.17	0.17
Delay/Veh:	150.9	23.6	11.8	27.6	95.5	7.3	41.2	135	134.9	130.0	32.7	32.7
User DelAdj:	1.00	1.00	1.00	1.00	1.00	1.00	1.00	1.00	1.00	1.00	1.00	1.00
AdjDel/Veh:	150.9	23.6	11.8	27.6	95.5	7.3	41.2	135	134.9	130.0	32.7	32.7
LOS by Move:	F	C	B	C	F	A	D	F	F	F	C	C
HCM2k95thQ:	18	7	1	0	65	1	13	30	30	31	3	3

Note: Queue reported is the number of cars per lane.

BART Phase II Extension Project

Level Of Service Computation Report
2000 HCM Operations (Future Volume Alternative)
AM - Existing Conditions

Intersection #106: Benton/EI Camino Real

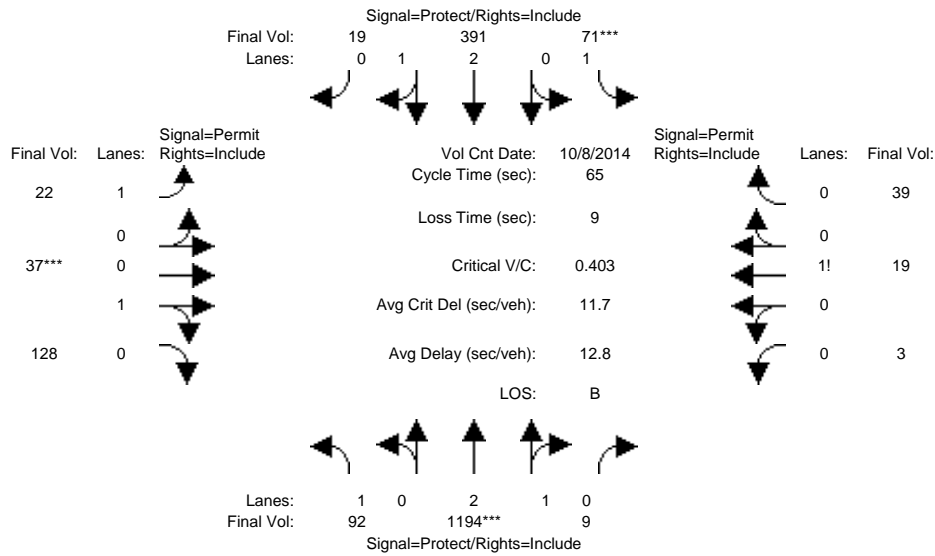

Approach:	North Bound			South Bound			East Bound			West Bound		
	L	T	R	L	T	R	L	T	R	L	T	R
Min. Green:	7	10	10	7	10	10	10	10	10	10	10	10
Y+R:	4.0	4.0	4.0	4.0	4.0	4.0	4.0	4.0	4.0	4.0	4.0	4.0

Volume Module:	>>	Count	Date:	8 Oct 2014	<<											
Base Vol:	92	1194	9	71	391	19	22	37	128	3	19	39				
Growth Adj:	1.00	1.00	1.00	1.00	1.00	1.00	1.00	1.00	1.00	1.00	1.00	1.00				
Initial Bse:	92	1194	9	71	391	19	22	37	128	3	19	39				
Added Vol:	0	0	0	0	0	0	0	0	0	0	0	0				
PasserByVol:	0	0	0	0	0	0	0	0	0	0	0	0				
Initial Fut:	92	1194	9	71	391	19	22	37	128	3	19	39				
User Adj:	1.00	1.00	1.00	1.00	1.00	1.00	1.00	1.00	1.00	1.00	1.00	1.00				
PHF Adj:	1.00	1.00	1.00	1.00	1.00	1.00	1.00	1.00	1.00	1.00	1.00	1.00				
PHF Volume:	92	1194	9	71	391	19	22	37	128	3	19	39				
Reduct Vol:	0	0	0	0	0	0	0	0	0	0	0	0				
Reduced Vol:	92	1194	9	71	391	19	22	37	128	3	19	39				
PCE Adj:	1.00	1.00	1.00	1.00	1.00	1.00	1.00	1.00	1.00	1.00	1.00	1.00				
MLF Adj:	1.00	1.00	1.00	1.00	1.00	1.00	1.00	1.00	1.00	1.00	1.00	1.00				
FinalVolume:	92	1194	9	71	391	19	22	37	128	3	19	39				

Saturation Flow Module:												
Sat/Lane:	1900	1900	1900	1900	1900	1900	1900	1900	1900	1900	1900	1900
Adjustment:	0.92	0.98	0.95	0.92	0.98	0.95	0.92	0.95	0.95	0.92	0.92	0.92
Lanes:	1.00	2.98	0.02	1.00	2.86	0.14	1.00	0.22	0.78	0.05	0.31	0.64
Final Sat.:	1750	5558	42	1750	5340	259	1750	404	1396	86	545	1119

Capacity Analysis Module:												
Vol/Sat:	0.05	0.21	0.21	0.04	0.07	0.07	0.01	0.09	0.09	0.03	0.03	0.03
Crit Moves:	****			****			****					
Green Time:	17.0	34.3	34.3	7.0	24.3	24.3	14.7	14.7	14.7	14.7	14.7	14.7
Volume/Cap:	0.20	0.41	0.41	0.38	0.20	0.20	0.06	0.41	0.41	0.15	0.15	0.15
Delay/Veh:	18.9	9.3	9.3	28.2	13.8	13.8	19.8	22.1	22.1	20.4	20.4	20.4
User DelAdj:	1.00	1.00	1.00	1.00	1.00	1.00	1.00	1.00	1.00	1.00	1.00	1.00
AdjDel/Veh:	18.9	9.3	9.3	28.2	13.8	13.8	19.8	22.1	22.1	20.4	20.4	20.4
LOS by Move:	B	A	A	C	B	B	B	C	C	C	C	C
HCM2k95thQ:	3	9	9	3	4	4	1	6	6	2	2	2

Note: Queue reported is the number of cars per lane.

BART Phase II Extension Project

Level Of Service Computation Report
2000 HCM Operations (Future Volume Alternative)
PM - Existing Conditions

Intersection #106: Benton/EI Camino Real

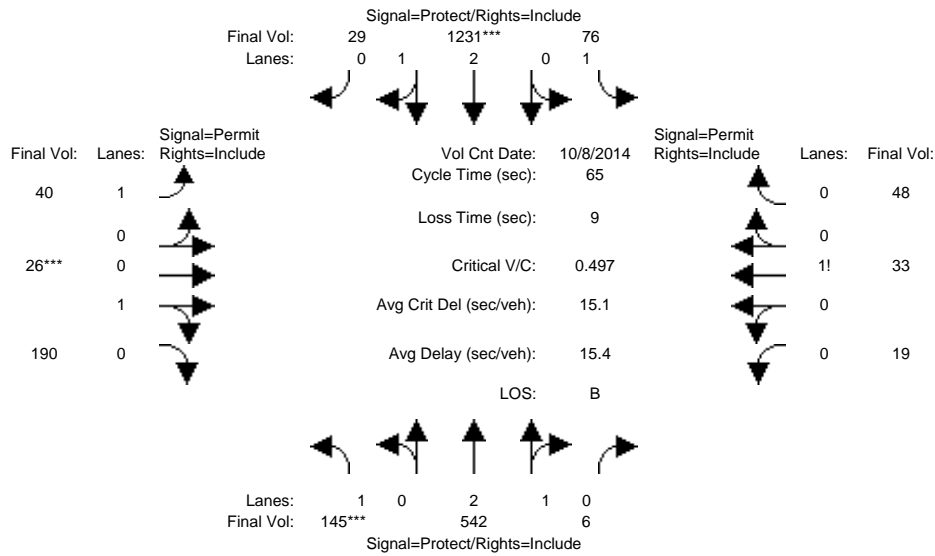

Approach:	North Bound			South Bound			East Bound			West Bound		
	L	T	R	L	T	R	L	T	R	L	T	R
Min. Green:	7	10	10	7	10	10	10	10	10	10	10	10
Y+R:	4.0	4.0	4.0	4.0	4.0	4.0	4.0	4.0	4.0	4.0	4.0	4.0

Volume Module: >> Count Date: 8 Oct 2014 <<

Base Vol:	145	542	6	76	1231	29	40	26	190	19	33	48
Growth Adj:	1.00	1.00	1.00	1.00	1.00	1.00	1.00	1.00	1.00	1.00	1.00	1.00
Initial Bse:	145	542	6	76	1231	29	40	26	190	19	33	48
Added Vol:	0	0	0	0	0	0	0	0	0	0	0	0
PasserByVol:	0	0	0	0	0	0	0	0	0	0	0	0
Initial Fut:	145	542	6	76	1231	29	40	26	190	19	33	48
User Adj:	1.00	1.00	1.00	1.00	1.00	1.00	1.00	1.00	1.00	1.00	1.00	1.00
PHF Adj:	1.00	1.00	1.00	1.00	1.00	1.00	1.00	1.00	1.00	1.00	1.00	1.00
PHF Volume:	145	542	6	76	1231	29	40	26	190	19	33	48
Reduct Vol:	0	0	0	0	0	0	0	0	0	0	0	0
Reduced Vol:	145	542	6	76	1231	29	40	26	190	19	33	48
PCE Adj:	1.00	1.00	1.00	1.00	1.00	1.00	1.00	1.00	1.00	1.00	1.00	1.00
MLF Adj:	1.00	1.00	1.00	1.00	1.00	1.00	1.00	1.00	1.00	1.00	1.00	1.00
Final Volume:	145	542	6	76	1231	29	40	26	190	19	33	48

Saturation Flow Module:

Sat/Lane:	1900	1900	1900	1900	1900	1900	1900	1900	1900	1900	1900	1900
Adjustment:	0.92	0.98	0.95	0.92	0.98	0.95	0.92	0.95	0.95	0.92	0.92	0.92
Lanes:	1.00	2.97	0.03	1.00	2.93	0.07	1.00	0.12	0.88	0.19	0.33	0.48
Final Sat.:	1750	5539	61	1750	5471	129	1750	217	1583	333	578	840

Capacity Analysis Module:

Vol/Sat:	0.08	0.10	0.10	0.04	0.23	0.23	0.02	0.12	0.12	0.06	0.06	0.06
Crit Moves:	****			****			****					
Green Time:	10.8	23.7	23.7	16.6	29.4	29.4	15.7	15.7	15.7	15.7	15.7	15.7
Volume/Cap:	0.50	0.27	0.27	0.17	0.50	0.50	0.09	0.50	0.50	0.24	0.24	0.24
Delay/Veh:	25.9	14.6	14.6	19.0	12.7	12.7	19.2	22.1	22.1	20.1	20.1	20.1
User DelAdj:	1.00	1.00	1.00	1.00	1.00	1.00	1.00	1.00	1.00	1.00	1.00	1.00
AdjDel/Veh:	25.9	14.6	14.6	19.0	12.7	12.7	19.2	22.1	22.1	20.1	20.1	20.1
LOS by Move:	C	B	B	B	B	B	B	C	C	C	C	C
HCM2k95thQ:	6	5	5	3	11	11	1	8	8	4	4	4

Note: Queue reported is the number of cars per lane.

BART Phase II Extension Project

Level Of Service Computation Report
2000 HCM Operations (Future Volume Alternative)
AM - Existing Conditions

Intersection #107: Benton/Lafayette

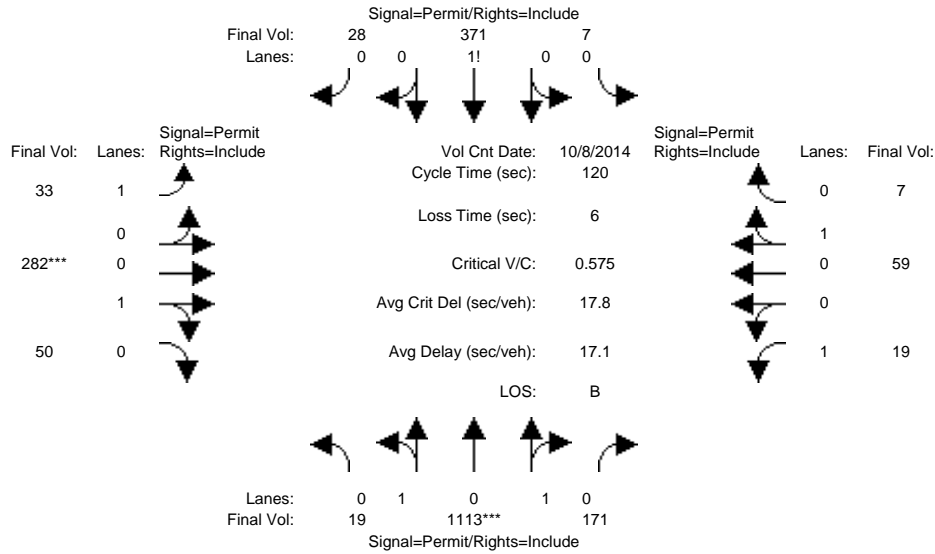

Approach:	North Bound			South Bound			East Bound			West Bound		
	L	T	R	L	T	R	L	T	R	L	T	R
Min. Green:	10	10	10	10	10	10	10	10	10	10	10	10
Y+R:	4.0	4.0	4.0	4.0	4.0	4.0	4.0	4.0	4.0	4.0	4.0	4.0
Volume Module: >> Count Date: 8 Oct 2014 <<												
Base Vol:	19	1113	171	7	371	28	33	282	50	19	59	7
Growth Adj:	1.00	1.00	1.00	1.00	1.00	1.00	1.00	1.00	1.00	1.00	1.00	1.00
Initial Bse:	19	1113	171	7	371	28	33	282	50	19	59	7
Added Vol:	0	0	0	0	0	0	0	0	0	0	0	0
PasserByVol:	0	0	0	0	0	0	0	0	0	0	0	0
Initial Fut:	19	1113	171	7	371	28	33	282	50	19	59	7
User Adj:	1.00	1.00	1.00	1.00	1.00	1.00	1.00	1.00	1.00	1.00	1.00	1.00
PHF Adj:	1.00	1.00	1.00	1.00	1.00	1.00	1.00	1.00	1.00	1.00	1.00	1.00
PHF Volume:	19	1113	171	7	371	28	33	282	50	19	59	7
Reduct Vol:	0	0	0	0	0	0	0	0	0	0	0	0
Reduced Vol:	19	1113	171	7	371	28	33	282	50	19	59	7
PCE Adj:	1.00	1.00	1.00	1.00	1.00	1.00	1.00	1.00	1.00	1.00	1.00	1.00
MLF Adj:	1.00	1.00	1.00	1.00	1.00	1.00	1.00	1.00	1.00	1.00	1.00	1.00
FinalVolume:	19	1113	171	7	371	28	33	282	50	19	59	7
Saturation Flow Module:												
Sat/Lane:	1900	1900	1900	1900	1900	1900	1900	1900	1900	1900	1900	1900
Adjustment:	0.95	0.95	0.95	0.92	0.92	0.92	0.92	0.95	0.95	0.92	0.95	0.95
Lanes:	0.03	1.71	0.26	0.02	0.91	0.07	1.00	0.85	0.15	1.00	0.89	0.11
Final Sat.:	52	3075	472	30	1599	121	1750	1529	271	1750	1609	191
Capacity Analysis Module:												
Vol/Sat:	0.36	0.36	0.36	0.23	0.23	0.23	0.02	0.18	0.18	0.01	0.04	0.04
Crit Moves:	****									****		
Green Time:	75.5	75.5	75.5	75.5	75.5	75.5	38.5	38.5	38.5	38.5	38.5	38.5
Volume/Cap:	0.58	0.58	0.58	0.37	0.37	0.37	0.06	0.58	0.58	0.03	0.11	0.11
Delay/Veh:	13.3	13.3	13.3	10.9	10.9	10.9	28.3	35.4	35.4	28.0	28.8	28.8
User DelAdj:	1.00	1.00	1.00	1.00	1.00	1.00	1.00	1.00	1.00	1.00	1.00	1.00
AdjDel/Veh:	13.3	13.3	13.3	10.9	10.9	10.9	28.3	35.4	35.4	28.0	28.8	28.8
LOS by Move:	B	B	B	B	B	B	C	D	D	C	C	C
HCM2k95thQ:	25	25	25	14	14	14	2	19	19	1	4	4

Note: Queue reported is the number of cars per lane.

BART Phase II Extension Project

Level Of Service Computation Report
2000 HCM Operations (Future Volume Alternative)
PM - Existing Conditions

Intersection #107: Benton/Lafayette

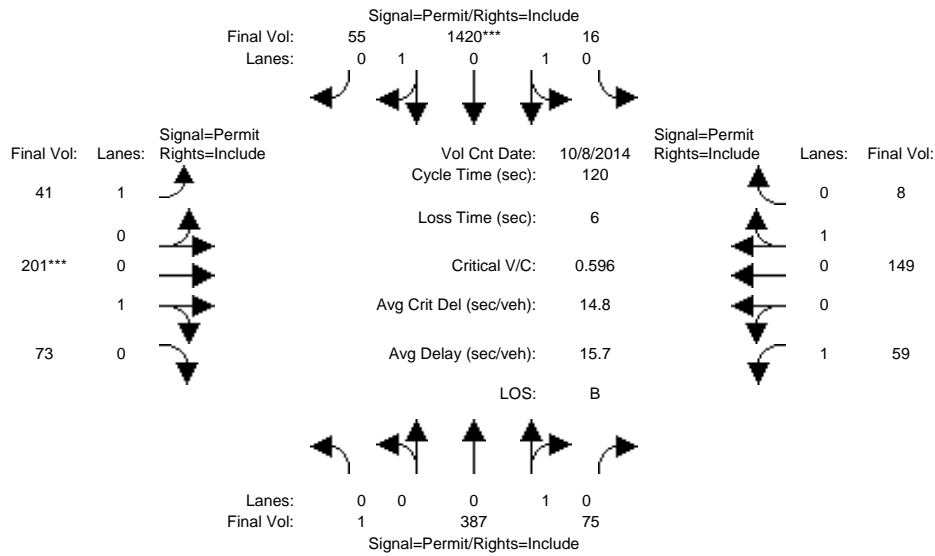

Approach:	North Bound			South Bound			East Bound			West Bound		
	L	T	R	L	T	R	L	T	R	L	T	R
Min. Green:	10	10	10	10	10	10	10	10	10	10	10	10
Y+R:	4.0	4.0	4.0	4.0	4.0	4.0	4.0	4.0	4.0	4.0	4.0	4.0

Volume Module:	>> Count Date: 8 Oct 2014 <<											
Base Vol:	1	387	75	16	1420	55	41	201	73	59	149	8
Growth Adj:	1.00	1.00	1.00	1.00	1.00	1.00	1.00	1.00	1.00	1.00	1.00	1.00
Initial Bse:	1	387	75	16	1420	55	41	201	73	59	149	8
Added Vol:	0	0	0	0	0	0	0	0	0	0	0	0
PasserByVol:	0	0	0	0	0	0	0	0	0	0	0	0
Initial Fut:	1	387	75	16	1420	55	41	201	73	59	149	8
User Adj:	1.00	1.00	1.00	1.00	1.00	1.00	1.00	1.00	1.00	1.00	1.00	1.00
PHF Adj:	1.00	1.00	1.00	1.00	1.00	1.00	1.00	1.00	1.00	1.00	1.00	1.00
PHF Volume:	1	387	75	16	1420	55	41	201	73	59	149	8
Reduct Vol:	0	0	0	0	0	0	0	0	0	0	0	0
Reduced Vol:	1	387	75	16	1420	55	41	201	73	59	149	8
PCE Adj:	1.00	1.00	1.00	1.00	1.00	1.00	1.00	1.00	1.00	1.00	1.00	1.00
MLF Adj:	1.00	1.00	1.00	1.00	1.00	1.00	1.00	1.00	1.00	1.00	1.00	1.00
FinalVolume:	1	387	75	16	1420	55	41	201	73	59	149	8

Saturation Flow Module:												
Sat/Lane:	1900	1900	1900	1900	1900	1900	1900	1900	1900	1900	1900	1900
Adjustment:	0.92	0.92	0.92	0.95	0.95	0.95	0.92	0.95	0.95	0.92	0.95	0.95
Lanes:	0.01	0.83	0.16	0.02	1.91	0.07	1.00	0.73	0.27	1.00	0.95	0.05
Final Sat.:	4	1463	283	39	3429	133	1750	1320	480	1750	1708	92

Capacity Analysis Module:												
Vol/Sat:	0.26	0.26	0.26	0.41	0.41	0.41	0.02	0.15	0.15	0.03	0.09	0.09
Crit Moves:	****						****					
Green Time:	83.4	83.4	83.4	83.4	83.4	83.4	30.6	30.6	30.6	30.6	30.6	30.6
Volume/Cap:	0.38	0.38	0.38	0.60	0.60	0.60	0.09	0.60	0.60	0.13	0.34	0.34
Delay/Veh:	7.8	7.8	7.8	9.9	9.9	9.9	34.2	41.4	41.4	34.6	36.9	36.9
User DelAdj:	1.00	1.00	1.00	1.00	1.00	1.00	1.00	1.00	1.00	1.00	1.00	1.00
AdjDel/Veh:	7.8	7.8	7.8	9.9	9.9	9.9	34.2	41.4	41.4	34.6	36.9	36.9
LOS by Move:	A	A	A	A	A	A	C	D	D	C	D	D
HCM2k95thQ:	14	14	14	25	25	25	2	17	17	4	10	10

Note: Queue reported is the number of cars per lane.

BART Phase II Extension Project

Level Of Service Computation Report
2000 HCM Operations (Future Volume Alternative)
AM - Existing Conditions

Intersection #175: Reed/De La Cruz

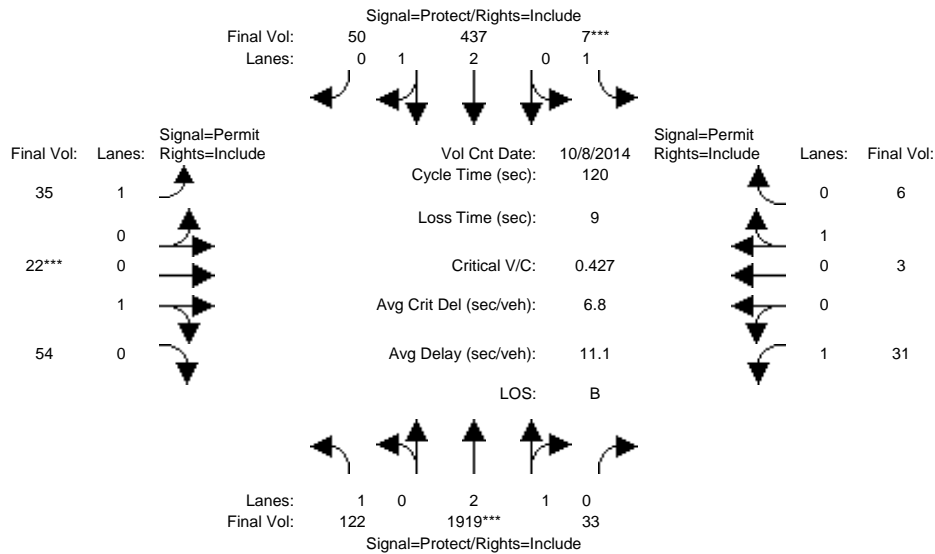

Approach:	North Bound			South Bound			East Bound			West Bound		
	L	T	R	L	T	R	L	T	R	L	T	R
Min. Green:	7	10	10	7	10	10	10	10	10	10	10	10
Y+R:	4.0	4.0	4.0	4.0	4.0	4.0	4.0	4.0	4.0	4.0	4.0	4.0
Volume Module: >> Count Date: 8 Oct 2014 <<												
Base Vol:	122	1919	33	7	437	50	35	22	54	31	3	6
Growth Adj:	1.00	1.00	1.00	1.00	1.00	1.00	1.00	1.00	1.00	1.00	1.00	1.00
Initial Bse:	122	1919	33	7	437	50	35	22	54	31	3	6
Added Vol:	0	0	0	0	0	0	0	0	0	0	0	0
PasserByVol:	0	0	0	0	0	0	0	0	0	0	0	0
Initial Fut:	122	1919	33	7	437	50	35	22	54	31	3	6
User Adj:	1.00	1.00	1.00	1.00	1.00	1.00	1.00	1.00	1.00	1.00	1.00	1.00
PHF Adj:	1.00	1.00	1.00	1.00	1.00	1.00	1.00	1.00	1.00	1.00	1.00	1.00
PHF Volume:	122	1919	33	7	437	50	35	22	54	31	3	6
Reduct Vol:	0	0	0	0	0	0	0	0	0	0	0	0
Reduced Vol:	122	1919	33	7	437	50	35	22	54	31	3	6
PCE Adj:	1.00	1.00	1.00	1.00	1.00	1.00	1.00	1.00	1.00	1.00	1.00	1.00
MLF Adj:	1.00	1.00	1.00	1.00	1.00	1.00	1.00	1.00	1.00	1.00	1.00	1.00
Final Volume:	122	1919	33	7	437	50	35	22	54	31	3	6
Saturation Flow Module:												
Sat/Lane:	1900	1900	1900	1900	1900	1900	1900	1900	1900	1900	1900	1900
Adjustment:	0.92	0.98	0.95	0.92	0.99	0.95	0.92	0.95	0.95	0.92	0.95	0.95
Lanes:	1.00	2.95	0.05	1.00	2.68	0.32	1.00	0.29	0.71	1.00	0.33	0.67
Final Sat.:	1750	5505	95	1750	5024	575	1750	521	1279	1750	600	1200
Capacity Analysis Module:												
Vol/Sat:	0.07	0.35	0.35	0.00	0.09	0.09	0.02	0.04	0.04	0.02	0.01	0.01
Crit Moves:	****			****			****			****		
Green Time:	44.4	92.8	92.8	7.0	55.4	55.4	11.2	11.2	11.2	11.2	11.2	11.2
Volume/Cap:	0.19	0.45	0.45	0.07	0.19	0.19	0.21	0.45	0.45	0.19	0.05	0.05
Delay/Veh:	25.7	4.8	4.8	53.7	19.1	19.1	51.0	53.4	53.4	50.7	49.7	49.7
User DelAdj:	1.00	1.00	1.00	1.00	1.00	1.00	1.00	1.00	1.00	1.00	1.00	1.00
AdjDel/Veh:	25.7	4.8	4.8	53.7	19.1	19.1	51.0	53.4	53.4	50.7	49.7	49.7
LOS by Move:	C	A	A	D	B	B	D	D	D	D	D	D
HCM2k95thQ:	6	16	16	1	7	7	3	6	6	3	1	1

Note: Queue reported is the number of cars per lane.

BART Phase II Extension Project

Level Of Service Computation Report
2000 HCM Operations (Future Volume Alternative)
PM - Existing Conditions

Intersection #175: Reed/De La Cruz

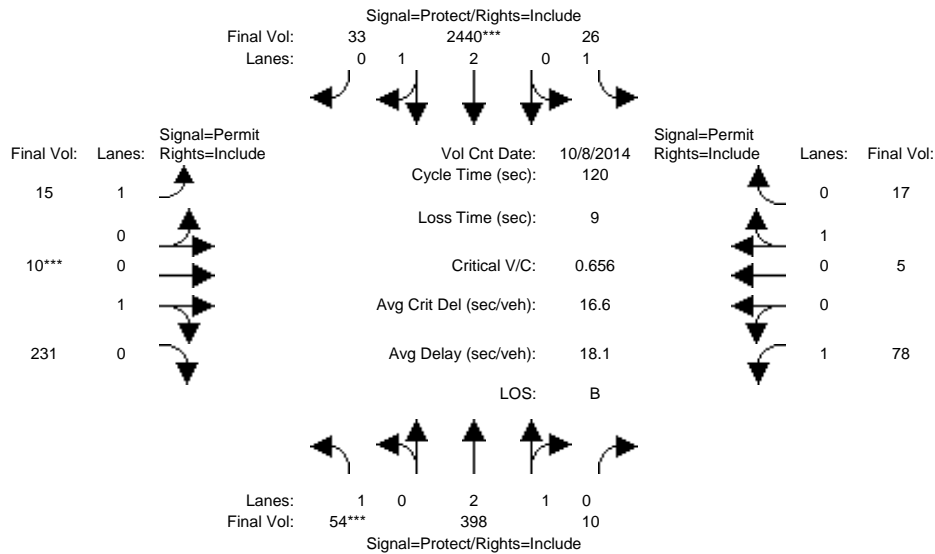

Approach:	North Bound			South Bound			East Bound			West Bound		
	L	T	R	L	T	R	L	T	R	L	T	R
Min. Green:	7	10	10	7	10	10	10	10	10	10	10	10
Y+R:	4.0	4.0	4.0	4.0	4.0	4.0	4.0	4.0	4.0	4.0	4.0	4.0

Volume Module:	>>	Count	Date:	8 Oct 2014	<<							
Base Vol:	54	398	10	26	2440	33	15	10	231	78	5	17
Growth Adj:	1.00	1.00	1.00	1.00	1.00	1.00	1.00	1.00	1.00	1.00	1.00	1.00
Initial Bse:	54	398	10	26	2440	33	15	10	231	78	5	17
Added Vol:	0	0	0	0	0	0	0	0	0	0	0	0
PasserByVol:	0	0	0	0	0	0	0	0	0	0	0	0
Initial Fut:	54	398	10	26	2440	33	15	10	231	78	5	17
User Adj:	1.00	1.00	1.00	1.00	1.00	1.00	1.00	1.00	1.00	1.00	1.00	1.00
PHF Adj:	1.00	1.00	1.00	1.00	1.00	1.00	1.00	1.00	1.00	1.00	1.00	1.00
PHF Volume:	54	398	10	26	2440	33	15	10	231	78	5	17
Reduct Vol:	0	0	0	0	0	0	0	0	0	0	0	0
Reduced Vol:	54	398	10	26	2440	33	15	10	231	78	5	17
PCE Adj:	1.00	1.00	1.00	1.00	1.00	1.00	1.00	1.00	1.00	1.00	1.00	1.00
MLF Adj:	1.00	1.00	1.00	1.00	1.00	1.00	1.00	1.00	1.00	1.00	1.00	1.00
FinalVolume:	54	398	10	26	2440	33	15	10	231	78	5	17

Saturation Flow Module:												
Sat/Lane:	1900	1900	1900	1900	1900	1900	1900	1900	1900	1900	1900	1900
Adjustment:	0.92	0.98	0.95	0.92	0.98	0.95	0.92	0.95	0.95	0.92	0.95	0.95
Lanes:	1.00	2.92	0.08	1.00	2.96	0.04	1.00	0.04	0.96	1.00	0.23	0.77
Final Sat.:	1750	5463	137	1750	5525	75	1750	75	1725	1750	409	1391

Capacity Analysis Module:												
Vol/Sat:	0.03	0.07	0.07	0.01	0.44	0.44	0.01	0.13	0.13	0.04	0.01	0.01
Crit Moves:	****			****			****					
Green Time:	7.0	51.1	51.1	35.7	79.8	79.8	24.2	24.2	24.2	24.2	24.2	24.2
Volume/Cap:	0.53	0.17	0.17	0.05	0.66	0.66	0.04	0.66	0.66	0.22	0.06	0.06
Delay/Veh:	60.0	21.4	21.4	30.1	12.5	12.5	38.6	48.7	48.7	40.3	38.8	38.8
User DelAdj:	1.00	1.00	1.00	1.00	1.00	1.00	1.00	1.00	1.00	1.00	1.00	1.00
AdjDel/Veh:	60.0	21.4	21.4	30.1	12.5	12.5	38.6	48.7	48.7	40.3	38.8	38.8
LOS by Move:	E	C	C	C	B	B	D	D	D	D	D	D
HCM2k95thQ:	6	6	6	1	32	32	1	16	16	5	1	1

Note: Queue reported is the number of cars per lane.

BART Phase II Extension Project

Level of Service Computation Report
2000 HCM Unsignalized (Future Volume Alternative)
AM - Existing Conditions

Intersection #1008: Lafayette/Harrison

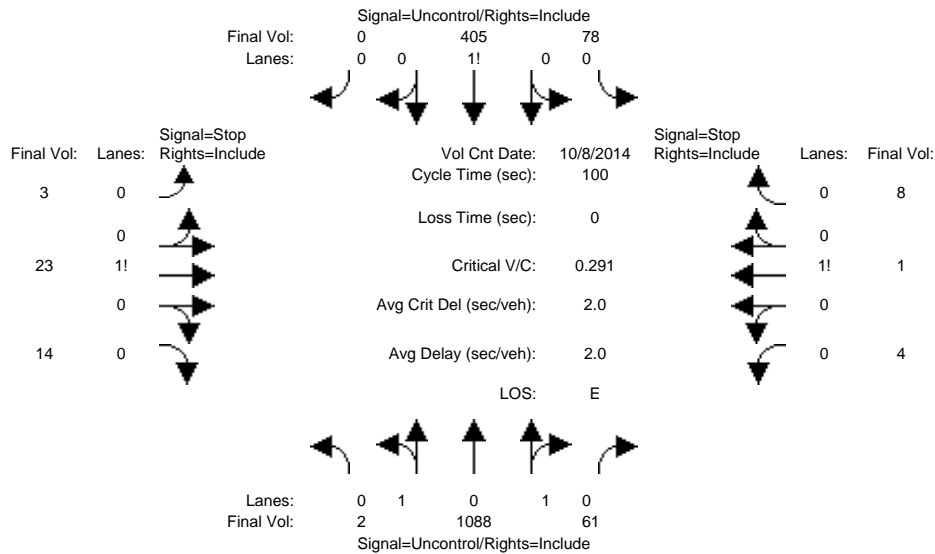

Approach:	North Bound			South Bound			East Bound			West Bound		
Movement:	L	T	R	L	T	R	L	T	R	L	T	R
Volume Module: >> Count Date: 8 Oct 2014 <<												
Base Vol:	2	1088	61	78	405	0	3	23	14	4	1	8
Growth Adj:	1.00	1.00	1.00	1.00	1.00	1.00	1.00	1.00	1.00	1.00	1.00	1.00
Initial Bse:	2	1088	61	78	405	0	3	23	14	4	1	8
Added Vol:	0	0	0	0	0	0	0	0	0	0	0	0
PasserByVol:	0	0	0	0	0	0	0	0	0	0	0	0
Initial Fut:	2	1088	61	78	405	0	3	23	14	4	1	8
User Adj:	1.00	1.00	1.00	1.00	1.00	1.00	1.00	1.00	1.00	1.00	1.00	1.00
PHF Adj:	1.00	1.00	1.00	1.00	1.00	1.00	1.00	1.00	1.00	1.00	1.00	1.00
PHF Volume:	2	1088	61	78	405	0	3	23	14	4	1	8
Reduct Vol:	0	0	0	0	0	0	0	0	0	0	0	0
FinalVolume:	2	1088	61	78	405	0	3	23	14	4	1	8
Critical Gap Module:												
Critical Gp:	4.1	xxxx	xxxxxx	4.1	xxxx	xxxxxx	7.1	6.5	6.2	7.1	6.5	6.2
FollowUpTim:	2.2	xxxx	xxxxxx	2.2	xxxx	xxxxxx	3.5	4.0	3.3	3.5	4.0	3.3
Capacity Module:												
Cnflct Vol:	405	xxxx	xxxxxx	1149	xxxx	xxxxxx	1110	1714	405	1702	1684	575
Potent Cap.:	1165	xxxx	xxxxxx	615	xxxx	xxxxxx	188	91	650	73	95	522
Move Cap.:	1165	xxxx	xxxxxx	615	xxxx	xxxxxx	165	79	650	50	82	522
Volume/Cap:	0.00	xxxx	xxxx	0.13	xxxx	xxxx	0.02	0.29	0.02	0.08	0.01	0.02
Level of Service Module:												
2Way95thQ:	0.0	xxxx	xxxxxx	0.4	xxxx	xxxxxx	xxxx	xxxx	xxxxxx	xxxx	xxxx	xxxxxx
Control Del:	8.1	xxxx	xxxxxx	11.7	xxxx	xxxxxx	xxxxxx	xxxx	xxxxxx	xxxxxx	xxxx	xxxxxx
LOS by Move:	A	*	*	B	*	*	*	*	*	*	*	*
Movement:	LT	LTR	RT	LT	LTR	RT	LT	LTR	RT	LT	LTR	RT
Shared Cap.:	xxxx	xxxx	xxxxxx	xxxx	xxxx	xxxxxx	xxxx	121	xxxxxx	xxxx	121	xxxxxx
SharedQueue:	0.0	xxxx	xxxxxx	0.4	xxxx	xxxxxx	xxxxxx	1.3	xxxxxx	xxxxxx	0.4	xxxxxx
Shrd ConDel:	8.1	xxxx	xxxxxx	11.7	xxxx	xxxxxx	xxxxxx	48.9	xxxxxx	xxxxxx	38.2	xxxxxx
Shared LOS:	A	*	*	B	*	*	*	E	*	*	E	*
ApproachDel:	xxxxxx							48.9				
ApproachLOS:	*							E				

Note: Queue reported is the number of cars per lane.

BART Phase II Extension Project

Level Of Service Computation Report
 2000 HCM Unsignalized (Future Volume Alternative)
 PM - Existing Conditions

Intersection #1008: Lafayette/Harrison

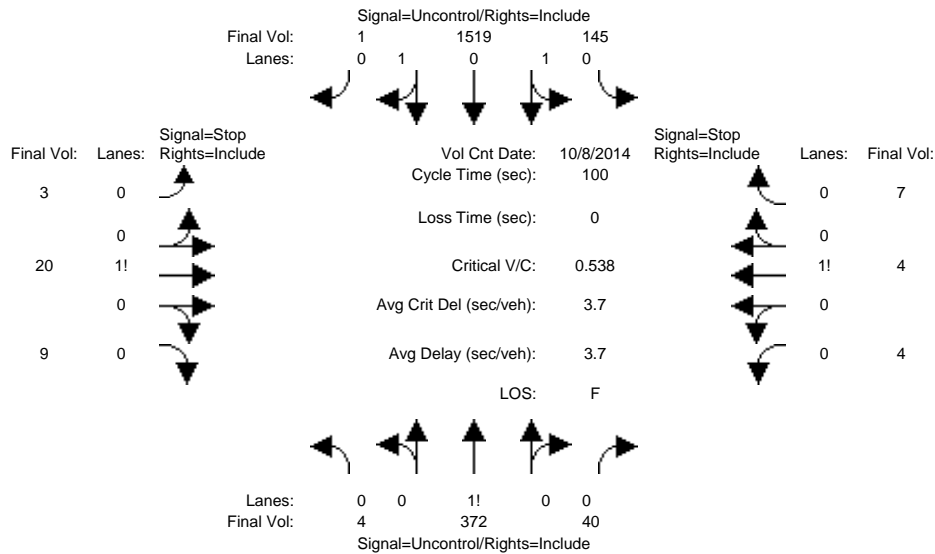

Approach:	North Bound			South Bound			East Bound			West Bound		
Movement:	L	T	R	L	T	R	L	T	R	L	T	R
Volume Module: >> Count Date: 8 Oct 2014 <<												
Base Vol:	4	372	40	145	1519	1	3	20	9	4	4	7
Growth Adj:	1.00	1.00	1.00	1.00	1.00	1.00	1.00	1.00	1.00	1.00	1.00	1.00
Initial Bse:	4	372	40	145	1519	1	3	20	9	4	4	7
Added Vol:	0	0	0	0	0	0	0	0	0	0	0	0
PasserByVol:	0	0	0	0	0	0	0	0	0	0	0	0
Initial Fut:	4	372	40	145	1519	1	3	20	9	4	4	7
User Adj:	1.00	1.00	1.00	1.00	1.00	1.00	1.00	1.00	1.00	1.00	1.00	1.00
PHF Adj:	1.00	1.00	1.00	1.00	1.00	1.00	1.00	1.00	1.00	1.00	1.00	1.00
PHF Volume:	4	372	40	145	1519	1	3	20	9	4	4	7
Reduct Vol:	0	0	0	0	0	0	0	0	0	0	0	0
FinalVolume:	4	372	40	145	1519	1	3	20	9	4	4	7
Critical Gap Module:												
Critical Gp:	4.1	xxxx	xxxxxx	4.1	xxxx	xxxxxx	7.1	6.5	6.2	7.1	6.5	6.2
FollowUpTim:	2.2	xxxx	xxxxxx	2.2	xxxx	xxxxxx	3.5	4.0	3.3	3.5	4.0	3.3
Capacity Module:												
Cnflct Vol:	1520	xxxx	xxxxxx	412	xxxx	xxxxxx	2215	2230	760	1460	2210	392
Potent Cap.:	445	xxxx	xxxxxx	1158	xxxx	xxxxxx	32	43	409	108	45	661
Move Cap.:	445	xxxx	xxxxxx	1158	xxxx	xxxxxx	26	37	409	55	38	661
Volume/Cap:	0.01	xxxx	xxxx	0.13	xxxx	xxxx	0.12	0.54	0.02	0.07	0.10	0.01
Level Of Service Module:												
2Way95thQ:	0.0	xxxx	xxxxxx	0.4	xxxx	xxxxxx	xxxx	xxxx	xxxxxx	xxxx	xxxx	xxxxxx
Control Del:	13.2	xxxx	xxxxxx	8.6	xxxx	xxxxxx	xxxxxx	xxxx	xxxxxx	xxxxxx	xxxx	xxxxxx
LOS by Move:	B	*	*	A	*	*	*	*	*	*	*	*
Movement:	LT	LTR	RT	LT	LTR	RT	LT	LTR	RT	LT	LTR	RT
Shared Cap.:	xxxx	xxxx	xxxxxx	xxxx	xxxx	xxxxxx	xxxx	47	xxxxxx	xxxx	80	xxxxxx
SharedQueue:	xxxxxx	xxxx	xxxxxx	0.4	xxxx	xxxxxx	xxxxxx	2.6	xxxxxx	xxxxxx	0.6	xxxxxx
Shrd ConDel:	xxxxxx	xxxx	xxxxxx	8.6	xxxx	xxxxxx	xxxxxx	177	xxxxxx	xxxxxx	60.3	xxxxxx
Shared LOS:	*	*	*	A	*	*	*	F	*	*	F	*
ApproachDel:	xxxxxx			xxxxxx			176.9			60.3		
ApproachLOS:	*			*			F			F		

Note: Queue reported is the number of cars per lane.

BART Phase II Extension Project

Level Of Service Computation Report
2000 HCM Operations (Future Volume Alternative)
AM - Existing Conditions

Intersection #1012: El Camino Real/Railroad Ave

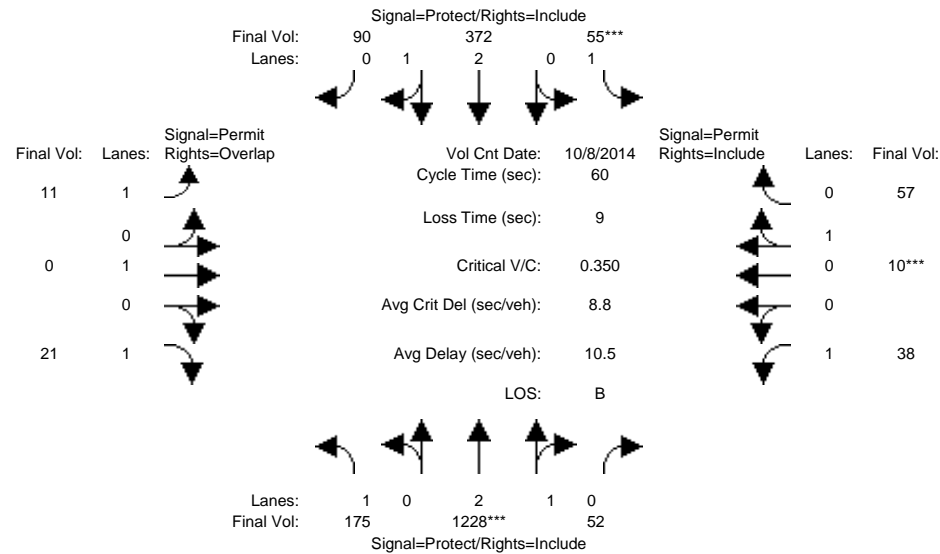

Approach:	North Bound			South Bound			East Bound			West Bound		
Movement:	L	T	R	L	T	R	L	T	R	L	T	R
Min. Green:	7	10	10	7	10	10	10	10	10	10	10	10
Y+R:	4.0	4.0	4.0	4.0	4.0	4.0	4.0	4.0	4.0	4.0	4.0	4.0
Volume Module: >> Count Date: 8 Oct 2014 <<												
Base Vol:	175	1228	52	55	372	90	11	0	21	38	10	57
Growth Adj:	1.00	1.00	1.00	1.00	1.00	1.00	1.00	1.00	1.00	1.00	1.00	1.00
Initial Bse:	175	1228	52	55	372	90	11	0	21	38	10	57
Added Vol:	0	0	0	0	0	0	0	0	0	0	0	0
PasserByVol:	0	0	0	0	0	0	0	0	0	0	0	0
Initial Fut:	175	1228	52	55	372	90	11	0	21	38	10	57
User Adj:	1.00	1.00	1.00	1.00	1.00	1.00	1.00	1.00	1.00	1.00	1.00	1.00
PHF Adj:	1.00	1.00	1.00	1.00	1.00	1.00	1.00	1.00	1.00	1.00	1.00	1.00
PHF Volume:	175	1228	52	55	372	90	11	0	21	38	10	57
Reduct Vol:	0	0	0	0	0	0	0	0	0	0	0	0
Reduced Vol:	175	1228	52	55	372	90	11	0	21	38	10	57
PCE Adj:	1.00	1.00	1.00	1.00	1.00	1.00	1.00	1.00	1.00	1.00	1.00	1.00
MLF Adj:	1.00	1.00	1.00	1.00	1.00	1.00	1.00	1.00	1.00	1.00	1.00	1.00
FinalVolume:	175	1228	52	55	372	90	11	0	21	38	10	57
Saturation Flow Module:												
Sat/Lane:	1900	1900	1900	1900	1900	1900	1900	1900	1900	1900	1900	1900
Adjustment:	0.92	0.98	0.95	0.92	0.99	0.95	0.92	1.00	0.92	0.92	0.95	0.95
Lanes:	1.00	2.87	0.13	1.00	2.39	0.61	1.00	1.00	1.00	1.00	0.15	0.85
Final Sat.:	1750	5372	227	1750	4508	1091	1750	1900	1750	1750	269	1531
Capacity Analysis Module:												
Vol/Sat:	0.10	0.23	0.23	0.03	0.08	0.08	0.01	0.00	0.01	0.02	0.04	0.04
Crit Moves:	****			****						****		
Green Time:	16.9	34.0	34.0	7.0	24.1	24.1	10.0	0.0	26.9	10.0	10.0	10.0
Volume/Cap:	0.36	0.40	0.40	0.27	0.21	0.21	0.04	0.00	0.03	0.13	0.22	0.22
Delay/Veh:	17.7	7.4	7.4	24.9	11.7	11.7	21.0	0.0	9.3	21.5	22.0	22.0
User DelAdj:	1.00	1.00	1.00	1.00	1.00	1.00	1.00	1.00	1.00	1.00	1.00	1.00
AdjDel/Veh:	17.7	7.4	7.4	24.9	11.7	11.7	21.0	0.0	9.3	21.5	22.0	22.0
LOS by Move:	B	A	A	C	B	B	C	A	A	C	C	C
HCM2k95thQ:	6	9	9	2	4	4	0	0	1	2	3	3

Note: Queue reported is the number of cars per lane.

BART Phase II Extension Project

Level Of Service Computation Report
2000 HCM Operations (Future Volume Alternative)
PM - Existing Conditions

Intersection #1012: El Camino Real/Railroad Ave

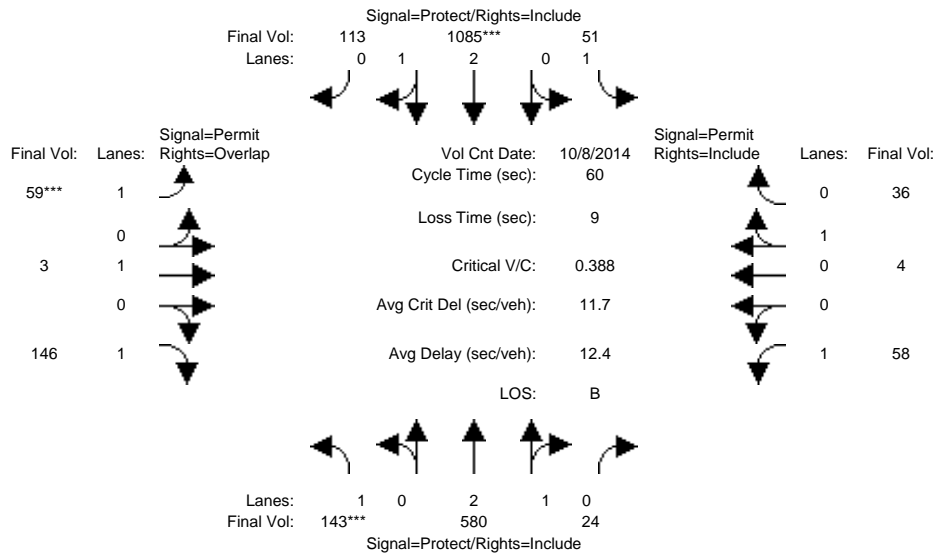

Approach:	North Bound			South Bound			East Bound			West Bound		
	L	T	R	L	T	R	L	T	R	L	T	R
Min. Green:	7	10	10	7	10	10	10	10	10	10	10	10
Y+R:	4.0	4.0	4.0	4.0	4.0	4.0	4.0	4.0	4.0	4.0	4.0	4.0

Volume Module:	>> Count Date: 8 Oct 2014 <<											
Base Vol:	143	580	24	51	1085	113	59	3	146	58	4	36
Growth Adj:	1.00	1.00	1.00	1.00	1.00	1.00	1.00	1.00	1.00	1.00	1.00	1.00
Initial Bse:	143	580	24	51	1085	113	59	3	146	58	4	36
Added Vol:	0	0	0	0	0	0	0	0	0	0	0	0
PasserByVol:	0	0	0	0	0	0	0	0	0	0	0	0
Initial Fut:	143	580	24	51	1085	113	59	3	146	58	4	36
User Adj:	1.00	1.00	1.00	1.00	1.00	1.00	1.00	1.00	1.00	1.00	1.00	1.00
PHF Adj:	1.00	1.00	1.00	1.00	1.00	1.00	1.00	1.00	1.00	1.00	1.00	1.00
PHF Volume:	143	580	24	51	1085	113	59	3	146	58	4	36
Reduct Vol:	0	0	0	0	0	0	0	0	0	0	0	0
Reduced Vol:	143	580	24	51	1085	113	59	3	146	58	4	36
PCE Adj:	1.00	1.00	1.00	1.00	1.00	1.00	1.00	1.00	1.00	1.00	1.00	1.00
MLF Adj:	1.00	1.00	1.00	1.00	1.00	1.00	1.00	1.00	1.00	1.00	1.00	1.00
Final Volume:	143	580	24	51	1085	113	59	3	146	58	4	36

Saturation Flow Module:												
Sat/Lane:	1900	1900	1900	1900	1900	1900	1900	1900	1900	1900	1900	1900
Adjustment:	0.92	0.98	0.95	0.92	0.99	0.95	0.92	1.00	0.92	0.92	0.95	0.95
Lanes:	1.00	2.88	0.12	1.00	2.71	0.29	1.00	1.00	1.00	1.00	0.10	0.90
Final Sat.:	1750	5377	223	1750	5071	528	1750	1900	1750	1750	180	1620

Capacity Analysis Module:												
Vol/Sat:	0.08	0.11	0.11	0.03	0.21	0.21	0.03	0.00	0.08	0.03	0.02	0.02
Crit Moves:	****			****			****					
Green Time:	11.3	24.1	24.1	16.9	29.7	29.7	10.0	10.0	21.3	10.0	10.0	10.0
Volume/Cap:	0.43	0.27	0.27	0.10	0.43	0.43	0.20	0.01	0.23	0.20	0.13	0.13
Delay/Veh:	22.4	12.1	12.1	16.1	9.9	9.9	21.9	20.9	13.8	21.9	21.5	21.5
User DelAdj:	1.00	1.00	1.00	1.00	1.00	1.00	1.00	1.00	1.00	1.00	1.00	1.00
AdjDel/Veh:	22.4	12.1	12.1	16.1	9.9	9.9	21.9	20.9	13.8	21.9	21.5	21.5
LOS by Move:	C	B	B	B	A	A	C	C	B	C	C	C
HCM2k95thQ:	6	5	5	1	9	9	2	0	4	2	2	2

Note: Queue reported is the number of cars per lane.

BART Phase II Extension Project

Level Of Service Computation Report
2000 HCM Operations (Future Volume Alternative)
AM - Existing Conditions

Intersection #1202: LAFAYETTE/EL CAMINO REAL

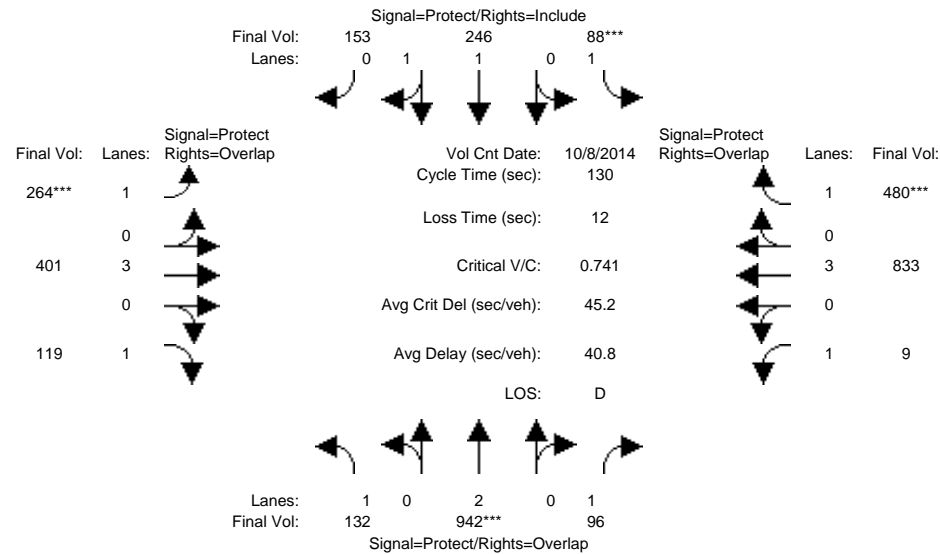

Approach:	North Bound			South Bound			East Bound			West Bound		
Movement:	L	T	R	L	T	R	L	T	R	L	T	R
Min. Green:	7	10	10	7	10	10	7	10	10	7	10	10
Y+R:	4.0	4.0	4.0	4.0	4.0	4.0	4.0	4.0	4.0	4.0	4.0	4.0
Volume Module: >> Count Date: 8 Oct 2014 <<												
Base Vol:	132	942	96	88	246	153	264	401	119	9	833	480
Growth Adj:	1.00	1.00	1.00	1.00	1.00	1.00	1.00	1.00	1.00	1.00	1.00	1.00
Initial Bse:	132	942	96	88	246	153	264	401	119	9	833	480
Added Vol:	0	0	0	0	0	0	0	0	0	0	0	0
PasserByVol:	0	0	0	0	0	0	0	0	0	0	0	0
Initial Fut:	132	942	96	88	246	153	264	401	119	9	833	480
User Adj:	1.00	1.00	1.00	1.00	1.00	1.00	1.00	1.00	1.00	1.00	1.00	1.00
PHF Adj:	1.00	1.00	1.00	1.00	1.00	1.00	1.00	1.00	1.00	1.00	1.00	1.00
PHF Volume:	132	942	96	88	246	153	264	401	119	9	833	480
Reduct Vol:	0	0	0	0	0	0	0	0	0	0	0	0
Reduced Vol:	132	942	96	88	246	153	264	401	119	9	833	480
PCE Adj:	1.00	1.00	1.00	1.00	1.00	1.00	1.00	1.00	1.00	1.00	1.00	1.00
MLF Adj:	1.00	1.00	1.00	1.00	1.00	1.00	1.00	1.00	1.00	1.00	1.00	1.00
Final Volume:	132	942	96	88	246	153	264	401	119	9	833	480
Saturation Flow Module:												
Sat/Lane:	1900	1900	1900	1900	1900	1900	1900	1900	1900	1900	1900	1900
Adjustment:	0.92	1.00	0.92	0.92	0.99	0.95	0.92	1.00	0.92	0.92	1.00	0.92
Lanes:	1.00	2.00	1.00	1.00	1.21	0.79	1.00	3.00	1.00	1.00	3.00	1.00
Final Sat.:	1750	3800	1750	1750	2280	1418	1750	5700	1750	1750	5700	1750
Capacity Analysis Module:												
Vol/Sat:	0.08	0.25	0.05	0.05	0.11	0.11	0.15	0.07	0.07	0.01	0.15	0.27
Crit Moves:	****			****			****			****		
Green Time:	21.5	43.5	70.3	8.8	30.8	30.8	26.4	38.3	59.8	26.8	38.6	47.5
Volume/Cap:	0.46	0.74	0.10	0.74	0.46	0.46	0.74	0.24	0.15	0.02	0.49	0.75
Delay/Veh:	50.1	40.7	14.6	81.4	42.8	42.8	56.7	34.9	20.4	41.2	37.8	41.1
User DelAdj:	1.00	1.00	1.00	1.00	1.00	1.00	1.00	1.00	1.00	1.00	1.00	1.00
AdjDel/Veh:	50.1	40.7	14.6	81.4	42.8	42.8	56.7	34.9	20.4	41.2	37.8	41.1
LOS by Move:	D	D	B	F	D	D	E	C	C	D	D	D
HCM2k95thQ:	10	29	4	8	13	13	20	8	6	1	17	33

Note: Queue reported is the number of cars per lane.

BART Phase II Extension Project

Level Of Service Computation Report
2000 HCM Operations (Future Volume Alternative)
PM - Existing Conditions

Intersection #1202: LAFAYETTE/EL CAMINO REAL

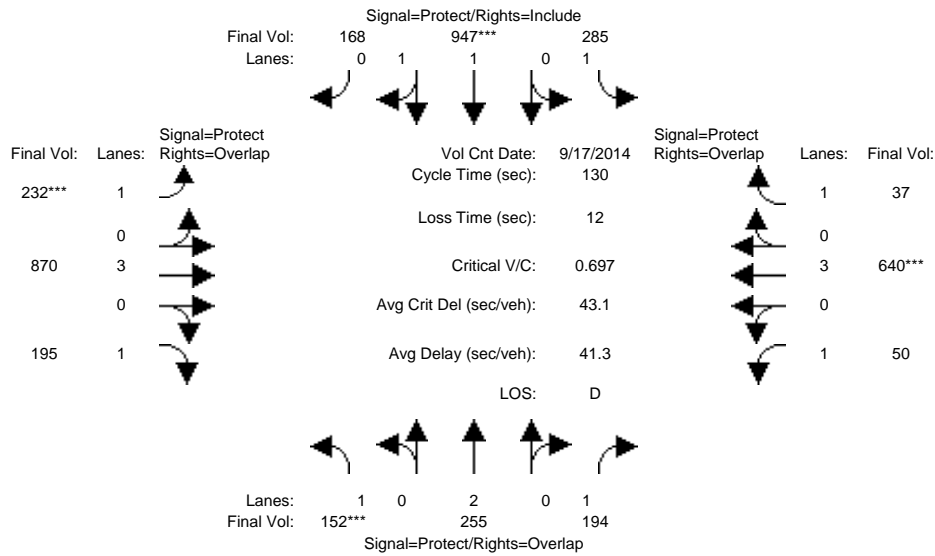

Approach:	North Bound			South Bound			East Bound			West Bound		
	L	T	R	L	T	R	L	T	R	L	T	R
Min. Green:	7	10	10	7	10	10	7	10	10	7	10	10
Y+R:	4.0	4.0	4.0	4.0	4.0	4.0	4.0	4.0	4.0	4.0	4.0	4.0

Volume Module:	>> Count Date: 17 Sep 2014 <<											
Base Vol:	152	255	194	285	947	168	232	870	195	50	640	37
Growth Adj:	1.00	1.00	1.00	1.00	1.00	1.00	1.00	1.00	1.00	1.00	1.00	1.00
Initial Bse:	152	255	194	285	947	168	232	870	195	50	640	37
Added Vol:	0	0	0	0	0	0	0	0	0	0	0	0
PasserByVol:	0	0	0	0	0	0	0	0	0	0	0	0
Initial Fut:	152	255	194	285	947	168	232	870	195	50	640	37
User Adj:	1.00	1.00	1.00	1.00	1.00	1.00	1.00	1.00	1.00	1.00	1.00	1.00
PHF Adj:	1.00	1.00	1.00	1.00	1.00	1.00	1.00	1.00	1.00	1.00	1.00	1.00
PHF Volume:	152	255	194	285	947	168	232	870	195	50	640	37
Reduct Vol:	0	0	0	0	0	0	0	0	0	0	0	0
Reduced Vol:	152	255	194	285	947	168	232	870	195	50	640	37
PCE Adj:	1.00	1.00	1.00	1.00	1.00	1.00	1.00	1.00	1.00	1.00	1.00	1.00
MLF Adj:	1.00	1.00	1.00	1.00	1.00	1.00	1.00	1.00	1.00	1.00	1.00	1.00
FinalVolume:	152	255	194	285	947	168	232	870	195	50	640	37

Saturation Flow Module:												
Sat/Lane:	1900	1900	1900	1900	1900	1900	1900	1900	1900	1900	1900	1900
Adjustment:	0.92	1.00	0.92	0.92	0.98	0.95	0.92	1.00	0.92	0.92	1.00	0.92
Lanes:	1.00	2.00	1.00	1.00	1.69	0.31	1.00	3.00	1.00	1.00	3.00	1.00
Final Sat.:	1750	3800	1750	1750	3142	557	1750	5700	1750	1750	5700	1750

Capacity Analysis Module:												
Vol/Sat:	0.09	0.07	0.11	0.16	0.30	0.30	0.13	0.15	0.11	0.03	0.11	0.02
Crit Moves:	****				****		****				****	
Green Time:	16.2	24.3	36.2	48.1	56.2	56.2	24.7	33.7	49.9	11.9	20.9	69.0
Volume/Cap:	0.70	0.36	0.40	0.44	0.70	0.70	0.70	0.59	0.29	0.31	0.70	0.04
Delay/Veh:	64.1	46.4	38.6	31.3	31.4	31.4	55.5	42.7	28.0	56.3	53.9	14.6
User DelAdj:	1.00	1.00	1.00	1.00	1.00	1.00	1.00	1.00	1.00	1.00	1.00	1.00
AdjDel/Veh:	64.1	46.4	38.6	31.3	31.4	31.4	55.5	42.7	28.0	56.3	53.9	14.6
LOS by Move:	E	D	D	C	C	C	E	D	C	E	D	B
HCM2k95thQ:	12	8	13	17	32	32	17	18	11	5	17	2

Note: Queue reported is the number of cars per lane.

BART Phase II Extension Project

Level Of Service Computation Report
 2000 HCM Operations (Future Volume Alternative)
 AM - Existing Conditions

Intersection #1204: MONROE/EL CAMINO REAL

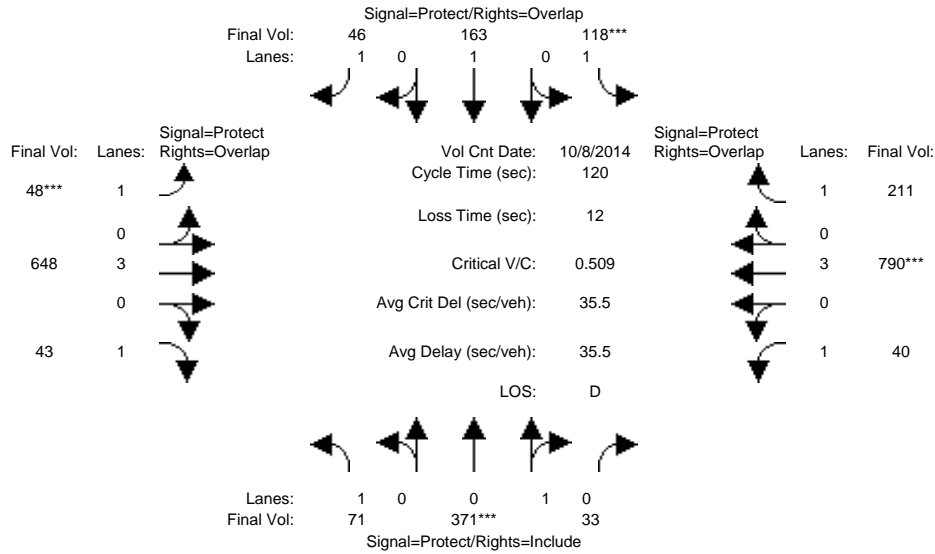

Approach:	North Bound			South Bound			East Bound			West Bound		
Movement:	L	T	R	L	T	R	L	T	R	L	T	R
Min. Green:	7	10	10	7	10	10	7	10	10	7	10	10
Y+R:	4.0	4.0	4.0	4.0	4.0	4.0	4.0	4.0	4.0	4.0	4.0	4.0
Volume Module: >> Count Date: 8 Oct 2014 <<												
Base Vol:	71	371	33	118	163	46	48	648	43	40	790	211
Growth Adj:	1.00	1.00	1.00	1.00	1.00	1.00	1.00	1.00	1.00	1.00	1.00	1.00
Initial Bse:	71	371	33	118	163	46	48	648	43	40	790	211
Added Vol:	0	0	0	0	0	0	0	0	0	0	0	0
PasserByVol:	0	0	0	0	0	0	0	0	0	0	0	0
Initial Fut:	71	371	33	118	163	46	48	648	43	40	790	211
User Adj:	1.00	1.00	1.00	1.00	1.00	1.00	1.00	1.00	1.00	1.00	1.00	1.00
PHF Adj:	1.00	1.00	1.00	1.00	1.00	1.00	1.00	1.00	1.00	1.00	1.00	1.00
PHF Volume:	71	371	33	118	163	46	48	648	43	40	790	211
Reduct Vol:	0	0	0	0	0	0	0	0	0	0	0	0
Reduced Vol:	71	371	33	118	163	46	48	648	43	40	790	211
PCE Adj:	1.00	1.00	1.00	1.00	1.00	1.00	1.00	1.00	1.00	1.00	1.00	1.00
MLF Adj:	1.00	1.00	1.00	1.00	1.00	1.00	1.00	1.00	1.00	1.00	1.00	1.00
Final Volume:	71	371	33	118	163	46	48	648	43	40	790	211
Saturation Flow Module:												
Sat/Lane:	1900	1900	1900	1900	1900	1900	1900	1900	1900	1900	1900	1900
Adjustment:	0.92	0.95	0.95	0.92	1.00	0.92	0.92	1.00	0.92	0.92	1.00	0.92
Lanes:	1.00	0.92	0.08	1.00	1.00	1.00	1.00	3.00	1.00	1.00	3.00	1.00
Final Sat.:	1750	1653	147	1750	1900	1750	1750	5700	1750	1750	5700	1750
Capacity Analysis Module:												
Vol/Sat:	0.04	0.22	0.22	0.07	0.09	0.03	0.03	0.11	0.02	0.02	0.14	0.12
Crit Moves:	****	****	****	****	****	****	****	****	****	****	****	****
Green Time:	27.7	52.7	52.7	15.8	40.8	47.8	7.0	26.1	53.8	13.4	32.5	48.3
Volume/Cap:	0.18	0.51	0.51	0.51	0.25	0.07	0.47	0.52	0.05	0.20	0.51	0.30
Delay/Veh:	37.2	24.9	24.9	50.4	28.8	22.4	58.1	41.8	18.7	49.0	37.3	24.6
User DelAdj:	1.00	1.00	1.00	1.00	1.00	1.00	1.00	1.00	1.00	1.00	1.00	1.00
AdjDel/Veh:	37.2	24.9	24.9	50.4	28.8	22.4	58.1	41.8	18.7	49.0	37.3	24.6
LOS by Move:	D	C	C	D	C	C	E	D	B	D	D	C
HCM2k95thQ:	5	21	21	9	8	2	4	13	2	3	15	11

Note: Queue reported is the number of cars per lane.

BART Phase II Extension Project

Level Of Service Computation Report
2000 HCM Operations (Future Volume Alternative)
PM - Existing Conditions

Intersection #1204: MONROE/EL CAMINO REAL

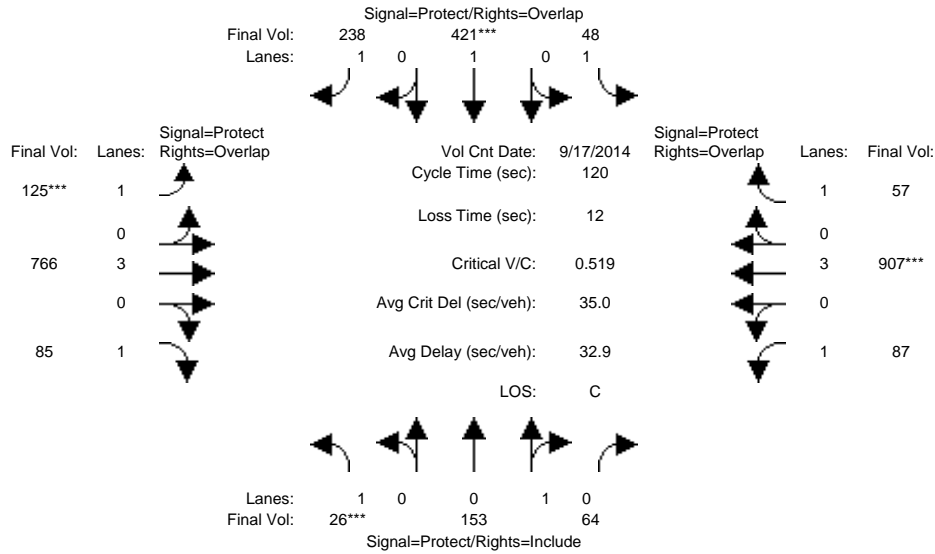

Approach:	North Bound			South Bound			East Bound			West Bound		
	L	T	R	L	T	R	L	T	R	L	T	R
Min. Green:	7	10	10	7	10	10	7	10	10	7	10	10
Y+R:	4.0	4.0	4.0	4.0	4.0	4.0	4.0	4.0	4.0	4.0	4.0	4.0

Volume Module:	>> Count Date: 17 Sep 2014 <<											
Base Vol:	26	153	64	48	421	238	125	766	85	87	907	57
Growth Adj:	1.00	1.00	1.00	1.00	1.00	1.00	1.00	1.00	1.00	1.00	1.00	1.00
Initial Bse:	26	153	64	48	421	238	125	766	85	87	907	57
Added Vol:	0	0	0	0	0	0	0	0	0	0	0	0
PasserByVol:	0	0	0	0	0	0	0	0	0	0	0	0
Initial Fut:	26	153	64	48	421	238	125	766	85	87	907	57
User Adj:	1.00	1.00	1.00	1.00	1.00	1.00	1.00	1.00	1.00	1.00	1.00	1.00
PHF Adj:	1.00	1.00	1.00	1.00	1.00	1.00	1.00	1.00	1.00	1.00	1.00	1.00
PHF Volume:	26	153	64	48	421	238	125	766	85	87	907	57
Reduct Vol:	0	0	0	0	0	0	0	0	0	0	0	0
Reduced Vol:	26	153	64	48	421	238	125	766	85	87	907	57
PCE Adj:	1.00	1.00	1.00	1.00	1.00	1.00	1.00	1.00	1.00	1.00	1.00	1.00
MLF Adj:	1.00	1.00	1.00	1.00	1.00	1.00	1.00	1.00	1.00	1.00	1.00	1.00
FinalVolume:	26	153	64	48	421	238	125	766	85	87	907	57

Saturation Flow Module:												
Sat/Lane:	1900	1900	1900	1900	1900	1900	1900	1900	1900	1900	1900	1900
Adjustment:	0.92	0.95	0.95	0.92	1.00	0.92	0.92	1.00	0.92	0.92	1.00	0.92
Lanes:	1.00	0.71	0.29	1.00	1.00	1.00	1.00	3.00	1.00	1.00	3.00	1.00
Final Sat.:	1750	1269	531	1750	1900	1750	1750	5700	1750	1750	5700	1750

Capacity Analysis Module:												
Vol/Sat:	0.01	0.12	0.12	0.03	0.22	0.14	0.07	0.13	0.05	0.05	0.16	0.03
Crit Moves:	****			****			****			****		
Green Time:	7.0	38.1	38.1	18.4	49.5	65.5	16.0	35.9	42.9	15.6	35.5	54.0
Volume/Cap:	0.25	0.38	0.38	0.18	0.54	0.25	0.54	0.45	0.14	0.38	0.54	0.07
Delay/Veh:	55.3	32.2	32.2	44.5	27.3	14.5	51.1	34.2	26.1	48.9	35.7	18.8
User DelAdj:	1.00	1.00	1.00	1.00	1.00	1.00	1.00	1.00	1.00	1.00	1.00	1.00
AdjDel/Veh:	55.3	32.2	32.2	44.5	27.3	14.5	51.1	34.2	26.1	48.9	35.7	18.8
LOS by Move:	E	C	C	D	C	B	D	C	C	D	D	B
HCM2k95thQ:	3	13	13	3	21	9	9	14	4	6	17	2

Note: Queue reported is the number of cars per lane.

BART Phase II Extension Project

Level Of Service Computation Report
 2000 HCM Operations (Future Volume Alternative)
 AM - Existing Conditions

Intersection #1205: SCOTT/EL CAMINO REAL

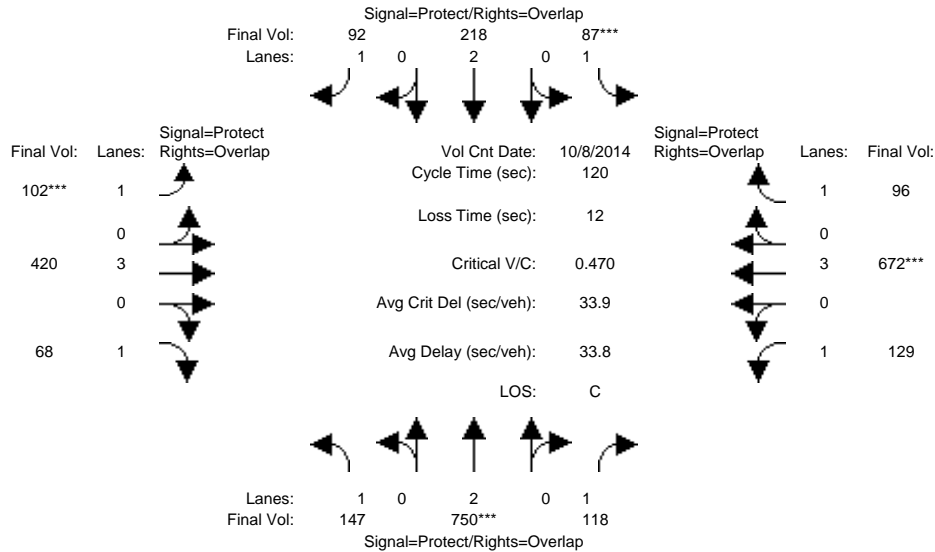

Approach:	North Bound			South Bound			East Bound			West Bound		
Movement:	L	T	R	L	T	R	L	T	R	L	T	R
Min. Green:	7	10	10	7	10	10	7	10	10	7	10	10
Y+R:	4.0	4.0	4.0	4.0	4.0	4.0	4.0	4.0	4.0	4.0	4.0	4.0
Volume Module: >> Count Date: 8 Oct 2014 <<												
Base Vol:	147	750	118	87	218	92	102	420	68	129	672	96
Growth Adj:	1.00	1.00	1.00	1.00	1.00	1.00	1.00	1.00	1.00	1.00	1.00	1.00
Initial Bse:	147	750	118	87	218	92	102	420	68	129	672	96
Added Vol:	0	0	0	0	0	0	0	0	0	0	0	0
PasserByVol:	0	0	0	0	0	0	0	0	0	0	0	0
Initial Fut:	147	750	118	87	218	92	102	420	68	129	672	96
User Adj:	1.00	1.00	1.00	1.00	1.00	1.00	1.00	1.00	1.00	1.00	1.00	1.00
PHF Adj:	1.00	1.00	1.00	1.00	1.00	1.00	1.00	1.00	1.00	1.00	1.00	1.00
PHF Volume:	147	750	118	87	218	92	102	420	68	129	672	96
Reduct Vol:	0	0	0	0	0	0	0	0	0	0	0	0
Reduced Vol:	147	750	118	87	218	92	102	420	68	129	672	96
PCE Adj:	1.00	1.00	1.00	1.00	1.00	1.00	1.00	1.00	1.00	1.00	1.00	1.00
MLF Adj:	1.00	1.00	1.00	1.00	1.00	1.00	1.00	1.00	1.00	1.00	1.00	1.00
FinalVolume:	147	750	118	87	218	92	102	420	68	129	672	96
Saturation Flow Module:												
Sat/Lane:	1900	1900	1900	1900	1900	1900	1900	1900	1900	1900	1900	1900
Adjustment:	0.92	1.00	0.92	0.92	1.00	0.92	0.92	1.00	0.92	0.92	1.00	0.92
Lanes:	1.00	2.00	1.00	1.00	2.00	1.00	1.00	3.00	1.00	1.00	3.00	1.00
Final Sat.:	1750	3800	1750	1750	3800	1750	1750	5700	1750	1750	5700	1750
Capacity Analysis Module:												
Vol/Sat:	0.08	0.20	0.07	0.05	0.06	0.05	0.06	0.07	0.04	0.07	0.12	0.05
Crit Moves:	****	****	****	****	****	****	****	****	****	****	****	****
Green Time:	31.6	50.4	71.5	12.7	31.4	46.3	14.9	23.9	55.5	21.1	30.1	42.8
Volume/Cap:	0.32	0.47	0.11	0.47	0.22	0.14	0.47	0.37	0.08	0.42	0.47	0.15
Delay/Veh:	35.9	25.4	10.6	52.4	34.8	24.0	50.5	41.8	18.1	44.9	38.4	26.4
User DelAdj:	1.00	1.00	1.00	1.00	1.00	1.00	1.00	1.00	1.00	1.00	1.00	1.00
AdjDel/Veh:	35.9	25.4	10.6	52.4	34.8	24.0	50.5	41.8	18.1	44.9	38.4	26.4
LOS by Move:	D	C	B	D	C	C	D	D	B	D	D	C
HCM2k95thQ:	9	18	4	6	6	5	7	8	3	9	13	5

Note: Queue reported is the number of cars per lane.

BART Phase II Extension Project

Level Of Service Computation Report
2000 HCM Operations (Future Volume Alternative)
PM - Existing Conditions

Intersection #1205: SCOTT/EL CAMINO REAL

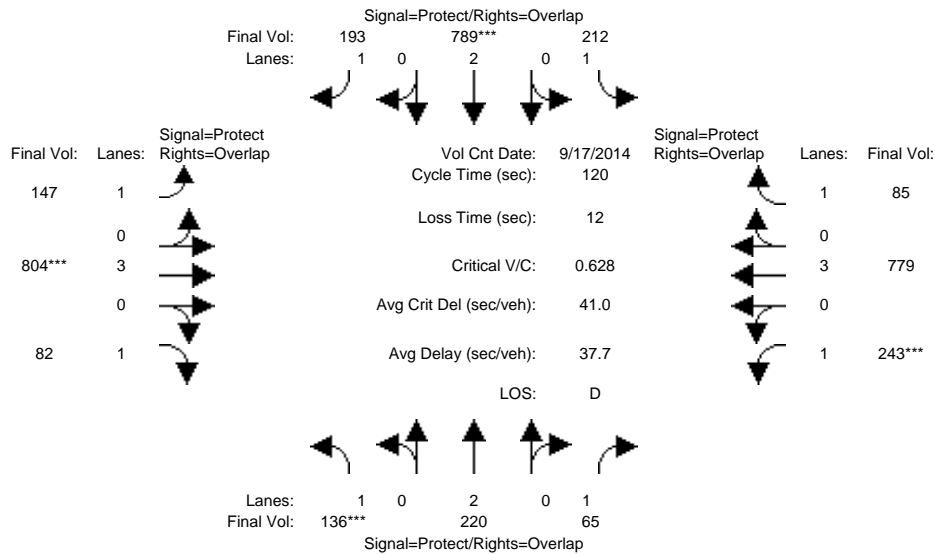

Approach:	North Bound			South Bound			East Bound			West Bound		
	L	T	R	L	T	R	L	T	R	L	T	R
Min. Green:	7	10	10	7	10	10	7	10	10	7	10	10
Y+R:	4.0	4.0	4.0	4.0	4.0	4.0	4.0	4.0	4.0	4.0	4.0	4.0
Volume Module: >> Count Date: 17 Sep 2014 <<												
Base Vol:	136	220	65	212	789	193	147	804	82	243	779	85
Growth Adj:	1.00	1.00	1.00	1.00	1.00	1.00	1.00	1.00	1.00	1.00	1.00	1.00
Initial Bse:	136	220	65	212	789	193	147	804	82	243	779	85
Added Vol:	0	0	0	0	0	0	0	0	0	0	0	0
PasserByVol:	0	0	0	0	0	0	0	0	0	0	0	0
Initial Fut:	136	220	65	212	789	193	147	804	82	243	779	85
User Adj:	1.00	1.00	1.00	1.00	1.00	1.00	1.00	1.00	1.00	1.00	1.00	1.00
PHF Adj:	1.00	1.00	1.00	1.00	1.00	1.00	1.00	1.00	1.00	1.00	1.00	1.00
PHF Volume:	136	220	65	212	789	193	147	804	82	243	779	85
Reduct Vol:	0	0	0	0	0	0	0	0	0	0	0	0
Reduced Vol:	136	220	65	212	789	193	147	804	82	243	779	85
PCE Adj:	1.00	1.00	1.00	1.00	1.00	1.00	1.00	1.00	1.00	1.00	1.00	1.00
MLF Adj:	1.00	1.00	1.00	1.00	1.00	1.00	1.00	1.00	1.00	1.00	1.00	1.00
FinalVolume:	136	220	65	212	789	193	147	804	82	243	779	85
Saturation Flow Module:												
Sat/Lane:	1900	1900	1900	1900	1900	1900	1900	1900	1900	1900	1900	1900
Adjustment:	0.92	1.00	0.92	0.92	1.00	0.92	0.92	1.00	0.92	0.92	1.00	0.92
Lanes:	1.00	2.00	1.00	1.00	2.00	1.00	1.00	3.00	1.00	1.00	3.00	1.00
Final Sat.:	1750	3800	1750	1750	3800	1750	1750	5700	1750	1750	5700	1750
Capacity Analysis Module:												
Vol/Sat:	0.08	0.06	0.04	0.12	0.21	0.11	0.08	0.14	0.05	0.14	0.14	0.05
Crit Moves:	****				****			****			****	
Green Time:	14.8	22.2	48.7	32.3	39.7	60.0	20.4	27.0	41.8	26.5	33.1	65.4
Volume/Cap:	0.63	0.31	0.09	0.45	0.63	0.22	0.50	0.63	0.13	0.63	0.50	0.09
Delay/Veh:	55.7	42.5	22.0	37.2	35.0	17.0	46.5	43.0	26.8	45.5	36.7	13.1
User DelAdj:	1.00	1.00	1.00	1.00	1.00	1.00	1.00	1.00	1.00	1.00	1.00	1.00
AdjDel/Veh:	55.7	42.5	22.0	37.2	35.0	17.0	46.5	43.0	26.8	45.5	36.7	13.1
LOS by Move:	E	D	C	D	C	B	D	D	C	D	D	B
HCM2k95thQ:	10	7	3	13	22	8	10	17	4	16	15	3

Note: Queue reported is the number of cars per lane.

BART Phase II Extension Project

Level Of Service Computation Report
2000 HCM Operations (Future Volume Alternative)
AM - Existing Conditions

Intersection #1213: THE ALAMEDA/EL CAMINO REAL

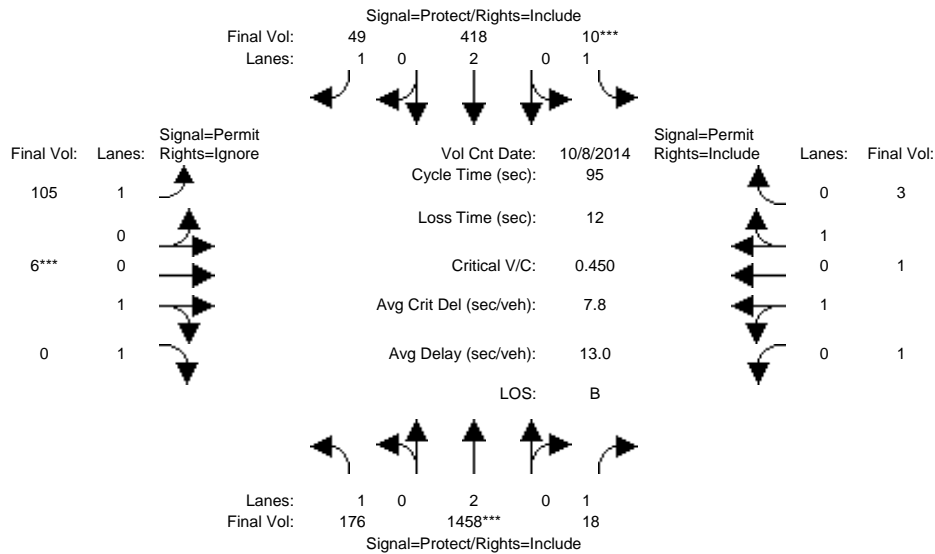

Approach:	North Bound			South Bound			East Bound			West Bound		
	L	T	R	L	T	R	L	T	R	L	T	R
Min. Green:	7	10	10	7	10	10	7	10	10	7	10	10
Y+R:	4.0	4.0	4.0	4.0	4.0	4.0	4.0	4.0	4.0	4.0	4.0	4.0
Volume Module: >> Count Date: 8 Oct 2014 <<												
Base Vol:	176	1458	18	10	418	49	105	6	108	1	1	3
Growth Adj:	1.00	1.00	1.00	1.00	1.00	1.00	1.00	1.00	1.00	1.00	1.00	1.00
Initial Bse:	176	1458	18	10	418	49	105	6	108	1	1	3
Added Vol:	0	0	0	0	0	0	0	0	0	0	0	0
PasserByVol:	0	0	0	0	0	0	0	0	0	0	0	0
Initial Fut:	176	1458	18	10	418	49	105	6	108	1	1	3
User Adj:	1.00	1.00	1.00	1.00	1.00	1.00	1.00	1.00	0.00	1.00	1.00	1.00
PHF Adj:	1.00	1.00	1.00	1.00	1.00	1.00	1.00	1.00	0.00	1.00	1.00	1.00
PHF Volume:	176	1458	18	10	418	49	105	6	0	1	1	3
Reduct Vol:	0	0	0	0	0	0	0	0	0	0	0	0
Reduced Vol:	176	1458	18	10	418	49	105	6	0	1	1	3
PCE Adj:	1.00	1.00	1.00	1.00	1.00	1.00	1.00	1.00	0.00	1.00	1.00	1.00
MLF Adj:	1.00	1.00	1.00	1.00	1.00	1.00	1.00	1.00	0.00	1.00	1.00	1.00
FinalVolume:	176	1458	18	10	418	49	105	6	0	1	1	3
Saturation Flow Module:												
Sat/Lane:	1900	1900	1900	1900	1900	1900	1900	1900	1900	1900	1900	1900
Adjustment:	0.92	1.00	0.92	0.92	1.00	0.92	0.92	0.95	0.92	0.95	0.95	0.95
Lanes:	1.00	2.00	1.00	1.00	2.00	1.00	1.00	1.00	1.00	0.50	0.50	1.00
Final Sat.:	1750	3800	1750	1750	3800	1750	1750	1800	1750	900	900	1800
Capacity Analysis Module:												
Vol/Sat:	0.10	0.38	0.01	0.01	0.11	0.03	0.06	0.00	0.00	0.00	0.00	0.00
Crit Moves:	****			****			****					
Green Time:	34.9	66.0	66.0	7.0	38.1	38.1	10.0	10.0	0.0	10.0	10.0	10.0
Volume/Cap:	0.27	0.55	0.01	0.08	0.27	0.07	0.57	0.03	0.00	0.01	0.01	0.02
Delay/Veh:	21.4	7.4	4.5	41.3	19.2	17.6	44.7	38.2	0.0	38.1	38.1	38.1
User DelAdj:	1.00	1.00	1.00	1.00	1.00	1.00	1.00	1.00	1.00	1.00	1.00	1.00
AdjDel/Veh:	21.4	7.4	4.5	41.3	19.2	17.6	44.7	38.2	0.0	38.1	38.1	38.1
LOS by Move:	C	A	A	D	B	B	D	D	A	D	D	D
HCM2k95thQ:	7	19	0	1	8	2	8	0	0	0	0	0

Note: Queue reported is the number of cars per lane.

BART Phase II Extension Project

Level Of Service Computation Report
2000 HCM Operations (Future Volume Alternative)
PM - Existing Conditions

Intersection #1213: THE ALAMEDA/EL CAMINO REAL

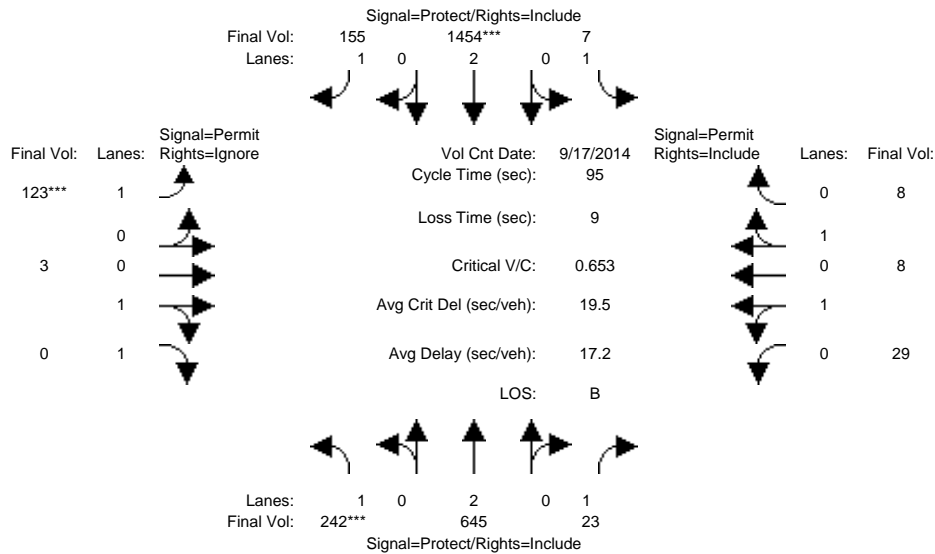

Approach:	North Bound			South Bound			East Bound			West Bound		
	L	T	R	L	T	R	L	T	R	L	T	R
Min. Green:	7	10	10	7	10	10	10	10	10	10	10	10
Y+R:	4.0	4.0	4.0	4.0	4.0	4.0	4.0	4.0	4.0	4.0	4.0	4.0

Volume Module:	>> Count Date: 17 Sep 2014 <<											
Base Vol:	242	645	23	7	1454	155	123	3	281	29	8	8
Growth Adj:	1.00	1.00	1.00	1.00	1.00	1.00	1.00	1.00	1.00	1.00	1.00	1.00
Initial Bse:	242	645	23	7	1454	155	123	3	281	29	8	8
Added Vol:	0	0	0	0	0	0	0	0	0	0	0	0
PasserByVol:	0	0	0	0	0	0	0	0	0	0	0	0
Initial Fut:	242	645	23	7	1454	155	123	3	281	29	8	8
User Adj:	1.00	1.00	1.00	1.00	1.00	1.00	1.00	1.00	0.00	1.00	1.00	1.00
PHF Adj:	1.00	1.00	1.00	1.00	1.00	1.00	1.00	1.00	0.00	1.00	1.00	1.00
PHF Volume:	242	645	23	7	1454	155	123	3	0	29	8	8
Reduct Vol:	0	0	0	0	0	0	0	0	0	0	0	0
Reduced Vol:	242	645	23	7	1454	155	123	3	0	29	8	8
PCE Adj:	1.00	1.00	1.00	1.00	1.00	1.00	1.00	1.00	0.00	1.00	1.00	1.00
MLF Adj:	1.00	1.00	1.00	1.00	1.00	1.00	1.00	1.00	0.00	1.00	1.00	1.00
FinalVolume:	242	645	23	7	1454	155	123	3	0	29	8	8

Saturation Flow Module:												
Sat/Lane:	1900	1900	1900	1900	1900	1900	1900	1900	1900	1900	1900	1900
Adjustment:	0.92	1.00	0.92	0.92	1.00	0.92	0.92	0.95	0.92	0.95	0.95	0.95
Lanes:	1.00	2.00	1.00	1.00	2.00	1.00	1.00	1.00	1.00	1.00	0.50	0.50
Final Sat.:	1750	3800	1750	1750	3800	1750	1750	1800	1750	1800	900	900

Capacity Analysis Module:												
Vol/Sat:	0.14	0.17	0.01	0.00	0.38	0.09	0.07	0.00	0.00	0.02	0.01	0.01
Crit Moves:	****				****		****					
Green Time:	20.1	52.8	52.8	22.9	55.7	55.7	10.2	10.2	0.0	10.2	10.2	10.2
Volume/Cap:	0.65	0.31	0.02	0.02	0.65	0.15	0.65	0.02	0.00	0.15	0.08	0.08
Delay/Veh:	38.4	11.4	9.5	27.5	13.9	9.0	48.6	37.9	0.0	38.7	38.2	38.2
User DelAdj:	1.00	1.00	1.00	1.00	1.00	1.00	1.00	1.00	1.00	1.00	1.00	1.00
AdjDel/Veh:	38.4	11.4	9.5	27.5	13.9	9.0	48.6	37.9	0.0	38.7	38.2	38.2
LOS by Move:	D	B	A	C	B	A	D	D	A	D	D	D
HCM2k95thQ:	13	9	1	0	26	4	10	0	0	2	1	1

Note: Queue reported is the number of cars per lane.

BART Phase II Extension Project

Level Of Service Computation Report
2000 HCM Operations (Future Volume Alternative)
AM - Existing Conditions

Intersection #3411: AVIATION/COLEMAN

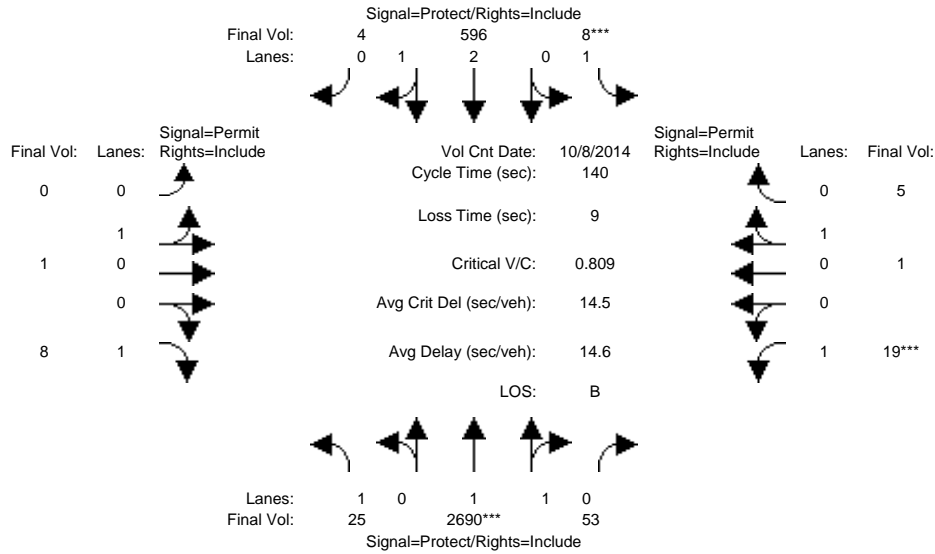

Approach:	North Bound			South Bound			East Bound			West Bound		
	L	T	R	L	T	R	L	T	R	L	T	R
Min. Green:	7	10	10	7	10	10	10	10	10	10	10	10
Y+R:	4.0	4.0	4.0	4.0	4.0	4.0	4.0	4.0	4.0	4.0	4.0	4.0
Volume Module: >> Count Date: 8 Oct 2014 <<												
Base Vol:	25	2690	53	8	596	4	0	1	8	19	1	5
Growth Adj:	1.00	1.00	1.00	1.00	1.00	1.00	1.00	1.00	1.00	1.00	1.00	1.00
Initial Bse:	25	2690	53	8	596	4	0	1	8	19	1	5
Added Vol:	0	0	0	0	0	0	0	0	0	0	0	0
PasserByVol:	0	0	0	0	0	0	0	0	0	0	0	0
Initial Fut:	25	2690	53	8	596	4	0	1	8	19	1	5
User Adj:	1.00	1.00	1.00	1.00	1.00	1.00	1.00	1.00	1.00	1.00	1.00	1.00
PHF Adj:	1.00	1.00	1.00	1.00	1.00	1.00	1.00	1.00	1.00	1.00	1.00	1.00
PHF Volume:	25	2690	53	8	596	4	0	1	8	19	1	5
Reduct Vol:	0	0	0	0	0	0	0	0	0	0	0	0
Reduced Vol:	25	2690	53	8	596	4	0	1	8	19	1	5
PCE Adj:	1.00	1.00	1.00	1.00	1.00	1.00	1.00	1.00	1.00	1.00	1.00	1.00
MLF Adj:	1.00	1.00	1.00	1.00	1.00	1.00	1.00	1.00	1.00	1.00	1.00	1.00
FinalVolume:	25	2690	53	8	596	4	0	1	8	19	1	5
Saturation Flow Module:												
Sat/Lane:	1900	1900	1900	1900	1900	1900	1900	1900	1900	1900	1900	1900
Adjustment:	0.92	0.97	0.95	0.92	0.98	0.95	0.95	0.95	0.92	0.92	0.95	0.95
Lanes:	1.00	1.96	0.04	1.00	2.98	0.02	0.00	1.00	1.00	1.00	0.17	0.83
Final Sat.:	1750	3628	71	1750	5563	37	0	1800	1750	1750	300	1500
Capacity Analysis Module:												
Vol/Sat:	0.01	0.74	0.74	0.00	0.11	0.11	0.00	0.00	0.00	0.01	0.00	0.00
Crit Moves:	****			****						****		
Green Time:	38.5	114	114.0	7.0	82.5	82.5	0.0	10.0	10.0	10.0	10.0	10.0
Volume/Cap:	0.05	0.91	0.91	0.09	0.18	0.18	0.00	0.01	0.06	0.15	0.05	0.05
Delay/Veh:	37.4	14.0	14.0	63.9	13.3	13.3	0.0	60.4	60.9	61.6	60.7	60.7
User DelAdj:	1.00	1.00	1.00	1.00	1.00	1.00	1.00	1.00	1.00	1.00	1.00	1.00
AdjDel/Veh:	37.4	14.0	14.0	63.9	13.3	13.3	0.0	60.4	60.9	61.6	60.7	60.7
LOS by Move:	D	B	B	E	B	B	A	E	E	E	E	E
HCM2k95thQ:	2	71	71	1	8	8	0	0	1	2	1	1

Note: Queue reported is the number of cars per lane.

BART Phase II Extension Project

Level Of Service Computation Report
2000 HCM Operations (Future Volume Alternative)
PM - Existing Conditions

Intersection #3411: AVIATION/COLEMAN

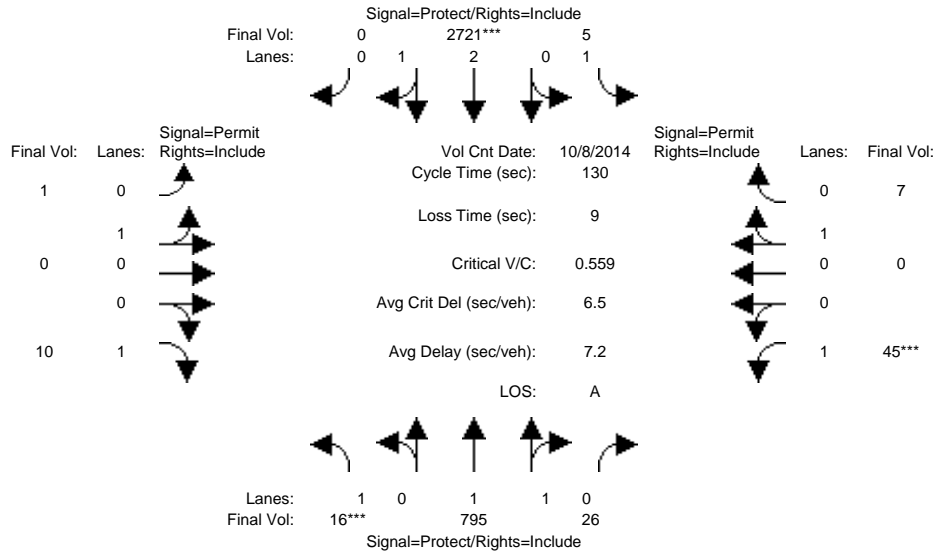

Approach:	North Bound			South Bound			East Bound			West Bound		
	L	T	R	L	T	R	L	T	R	L	T	R
Min. Green:	7	10	10	7	10	10	10	10	10	10	10	10
Y+R:	4.0	4.0	4.0	4.0	4.0	4.0	4.0	4.0	4.0	4.0	4.0	4.0
Volume Module: >> Count Date: 8 Oct 2014 <<												
Base Vol:	16	795	26	5	2721	0	1	0	10	45	0	7
Growth Adj:	1.00	1.00	1.00	1.00	1.00	1.00	1.00	1.00	1.00	1.00	1.00	1.00
Initial Bse:	16	795	26	5	2721	0	1	0	10	45	0	7
Added Vol:	0	0	0	0	0	0	0	0	0	0	0	0
PasserByVol:	0	0	0	0	0	0	0	0	0	0	0	0
Initial Fut:	16	795	26	5	2721	0	1	0	10	45	0	7
User Adj:	1.00	1.00	1.00	1.00	1.00	1.00	1.00	1.00	1.00	1.00	1.00	1.00
PHF Adj:	1.00	1.00	1.00	1.00	1.00	1.00	1.00	1.00	1.00	1.00	1.00	1.00
PHF Volume:	16	795	26	5	2721	0	1	0	10	45	0	7
Reduct Vol:	0	0	0	0	0	0	0	0	0	0	0	0
Reduced Vol:	16	795	26	5	2721	0	1	0	10	45	0	7
PCE Adj:	1.00	1.00	1.00	1.00	1.00	1.00	1.00	1.00	1.00	1.00	1.00	1.00
MLF Adj:	1.00	1.00	1.00	1.00	1.00	1.00	1.00	1.00	1.00	1.00	1.00	1.00
FinalVolume:	16	795	26	5	2721	0	1	0	10	45	0	7
Saturation Flow Module:												
Sat/Lane:	1900	1900	1900	1900	1900	1900	1900	1900	1900	1900	1900	1900
Adjustment:	0.92	0.97	0.95	0.92	0.98	0.92	0.95	0.95	0.92	0.92	1.00	0.95
Lanes:	1.00	1.93	0.07	1.00	3.00	0.00	1.00	0.00	1.00	1.00	0.00	1.00
Final Sat.:	1750	3583	117	1750	5600	0	1800	0	1750	1750	0	1800
Capacity Analysis Module:												
Vol/Sat:	0.01	0.22	0.22	0.00	0.49	0.00	0.00	0.00	0.01	0.03	0.00	0.00
Crit Moves:	****				****					****		
Green Time:	7.0	89.3	89.3	21.7	104	0.0	10.0	0.0	10.0	10.0	0.0	10.0
Volume/Cap:	0.17	0.32	0.32	0.02	0.61	0.00	0.01	0.00	0.07	0.33	0.00	0.05
Delay/Veh:	59.6	8.3	8.3	45.3	5.3	0.0	55.4	0.0	55.9	58.3	0.0	55.8
User DelAdj:	1.00	1.00	1.00	1.00	1.00	1.00	1.00	1.00	1.00	1.00	1.00	1.00
AdjDel/Veh:	59.6	8.3	8.3	45.3	5.3	0.0	55.4	0.0	55.9	58.3	0.0	55.8
LOS by Move:	E	A	A	D	A	A	E	A	E	E	A	E
HCM2k95thQ:	1	13	13	0	23	0	0	0	1	4	0	1

Note: Queue reported is the number of cars per lane.

BART Phase II Extension Project

Level Of Service Computation Report
 2000 HCM Operations (Future Volume Alternative)
 AM - Existing Conditions

Intersection #4047: COLEMAN/NEWHALL

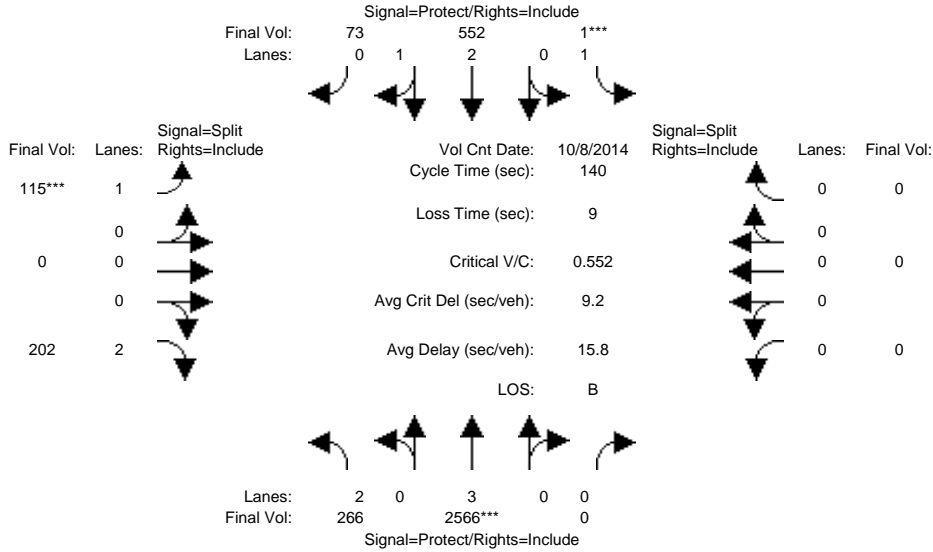

Approach:	North Bound			South Bound			East Bound			West Bound		
	L	T	R	L	T	R	L	T	R	L	T	R
Min. Green:	7	10	0	7	10	10	10	0	10	0	0	0
Y+R:	4.0	4.0	4.0	4.0	4.0	4.0	4.0	4.0	4.0	4.0	4.0	4.0
Volume Module: >> Count Date: 8 Oct 2014 <<												
Base Vol:	266	2566	0	1	552	73	115	0	202	0	0	0
Growth Adj:	1.00	1.00	1.00	1.00	1.00	1.00	1.00	1.00	1.00	1.00	1.00	1.00
Initial Bse:	266	2566	0	1	552	73	115	0	202	0	0	0
Added Vol:	0	0	0	0	0	0	0	0	0	0	0	0
PasserByVol:	0	0	0	0	0	0	0	0	0	0	0	0
Initial Fut:	266	2566	0	1	552	73	115	0	202	0	0	0
User Adj:	1.00	1.00	1.00	1.00	1.00	1.00	1.00	1.00	1.00	1.00	1.00	1.00
PHF Adj:	1.00	1.00	1.00	1.00	1.00	1.00	1.00	1.00	1.00	1.00	1.00	1.00
PHF Volume:	266	2566	0	1	552	73	115	0	202	0	0	0
Reduct Vol:	0	0	0	0	0	0	0	0	0	0	0	0
Reduced Vol:	266	2566	0	1	552	73	115	0	202	0	0	0
PCE Adj:	1.00	1.00	1.00	1.00	1.00	1.00	1.00	1.00	1.00	1.00	1.00	1.00
MLF Adj:	1.00	1.00	1.00	1.00	1.00	1.00	1.00	1.00	1.00	1.00	1.00	1.00
FinalVolume:	266	2566	0	1	552	73	115	0	202	0	0	0
Saturation Flow Module:												
Sat/Lane:	1900	1900	1900	1900	1900	1900	1900	1900	1900	1900	1900	1900
Adjustment:	0.83	1.00	0.92	0.92	0.99	0.95	0.92	1.00	0.83	0.92	1.00	0.92
Lanes:	2.00	3.00	0.00	1.00	2.64	0.36	1.00	0.00	2.00	0.00	0.00	0.00
Final Sat.:	3150	5700	0	1750	4945	654	1750	0	3150	0	0	0
Capacity Analysis Module:												
Vol/Sat:	0.08	0.45	0.00	0.00	0.11	0.11	0.07	0.00	0.06	0.00	0.00	0.00
Crit Moves:	****			****			****					
Green Time:	49.6	108	0.0	7.0	65.6	65.6	15.8	0.0	15.8	0.0	0.0	0.0
Volume/Cap:	0.24	0.58	0.00	0.01	0.24	0.24	0.58	0.00	0.57	0.00	0.00	0.00
Delay/Veh:	32.0	6.8	0.0	63.3	22.3	22.3	63.3	0.0	61.0	0.0	0.0	0.0
User DelAdj:	1.00	1.00	1.00	1.00	1.00	1.00	1.00	1.00	1.00	1.00	1.00	1.00
AdjDel/Veh:	32.0	6.8	0.0	63.3	22.3	22.3	63.3	0.0	61.0	0.0	0.0	0.0
LOS by Move:	C	A	A	E	C	C	E	A	E	A	A	A
HCM2k95thQ:	9	27	0	0	10	10	11	0	11	0	0	0

Note: Queue reported is the number of cars per lane.

BART Phase II Extension Project

Level Of Service Computation Report
2000 HCM Operations (Future Volume Alternative)
PM - Existing Conditions

Intersection #4047: COLEMAN/NEWHALL

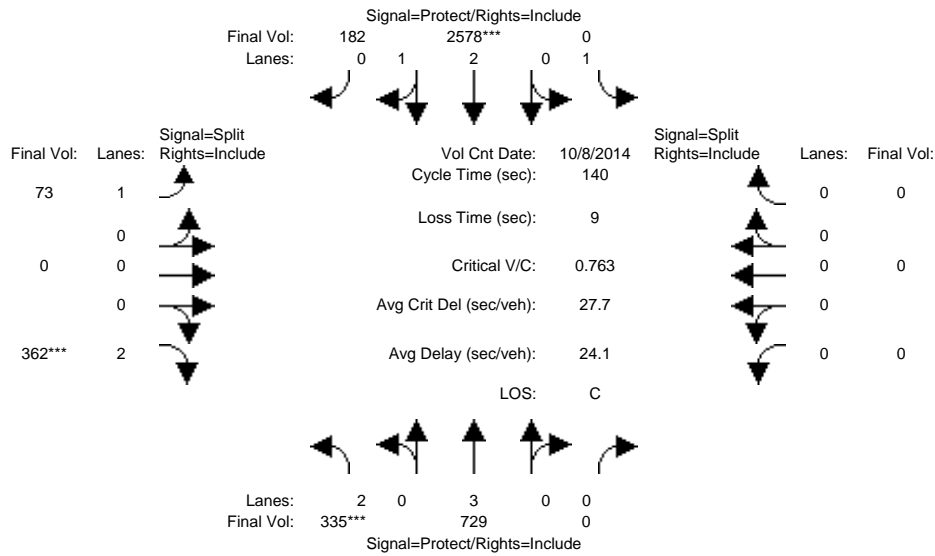

Approach:	North Bound			South Bound			East Bound			West Bound		
	L	T	R	L	T	R	L	T	R	L	T	R
Min. Green:	7	10	0	7	10	10	10	0	10	0	0	0
Y+R:	4.0	4.0	4.0	4.0	4.0	4.0	4.0	4.0	4.0	4.0	4.0	4.0
Volume Module: >> Count Date: 8 Oct 2014 <<												
Base Vol:	335	729	0	0	2578	182	73	0	362	0	0	0
Growth Adj:	1.00	1.00	1.00	1.00	1.00	1.00	1.00	1.00	1.00	1.00	1.00	1.00
Initial Bse:	335	729	0	0	2578	182	73	0	362	0	0	0
Added Vol:	0	0	0	0	0	0	0	0	0	0	0	0
PasserByVol:	0	0	0	0	0	0	0	0	0	0	0	0
Initial Fut:	335	729	0	0	2578	182	73	0	362	0	0	0
User Adj:	1.00	1.00	1.00	1.00	1.00	1.00	1.00	1.00	1.00	1.00	1.00	1.00
PHF Adj:	1.00	1.00	1.00	1.00	1.00	1.00	1.00	1.00	1.00	1.00	1.00	1.00
PHF Volume:	335	729	0	0	2578	182	73	0	362	0	0	0
Reduct Vol:	0	0	0	0	0	0	0	0	0	0	0	0
Reduced Vol:	335	729	0	0	2578	182	73	0	362	0	0	0
PCE Adj:	1.00	1.00	1.00	1.00	1.00	1.00	1.00	1.00	1.00	1.00	1.00	1.00
MLF Adj:	1.00	1.00	1.00	1.00	1.00	1.00	1.00	1.00	1.00	1.00	1.00	1.00
Final Volume:	335	729	0	0	2578	182	73	0	362	0	0	0
Saturation Flow Module:												
Sat/Lane:	1900	1900	1900	1900	1900	1900	1900	1900	1900	1900	1900	1900
Adjustment:	0.83	1.00	0.92	0.92	0.98	0.95	0.92	1.00	0.83	0.92	1.00	0.92
Lanes:	2.00	3.00	0.00	1.00	2.79	0.21	1.00	0.00	2.00	0.00	0.00	0.00
Final Sat.:	3150	5700	0	1750	5230	369	1750	0	3150	0	0	0
Capacity Analysis Module:												
Vol/Sat:	0.11	0.13	0.00	0.00	0.49	0.49	0.04	0.00	0.11	0.00	0.00	0.00
Crit Moves:	****				****				****			
Green Time:	19.5	110	0.0	0.0	90.4	90.4	21.1	0.0	21.1	0.0	0.0	0.0
Volume/Cap:	0.76	0.16	0.00	0.00	0.76	0.76	0.28	0.00	0.76	0.00	0.00	0.00
Delay/Veh:	65.8	3.7	0.0	0.0	18.3	18.3	53.3	0.0	64.3	0.0	0.0	0.0
User DelAdj:	1.00	1.00	1.00	1.00	1.00	1.00	1.00	1.00	1.00	1.00	1.00	1.00
AdjDel/Veh:	65.8	3.7	0.0	0.0	18.3	18.3	53.3	0.0	64.3	0.0	0.0	0.0
LOS by Move:	E	A	A	A	B	B	D	A	E	A	A	A
HCM2k95thQ:	18	5	0	0	45	45	6	0	19	0	0	0

Note: Queue reported is the number of cars per lane.

BART Phase II Extension Project

Level Of Service Computation Report
 2000 HCM Operations (Future Volume Alternative)
 AM - Existing Conditions

Intersection #5335: CENTRAL EXPWY/DE LA CRUZ BLVD

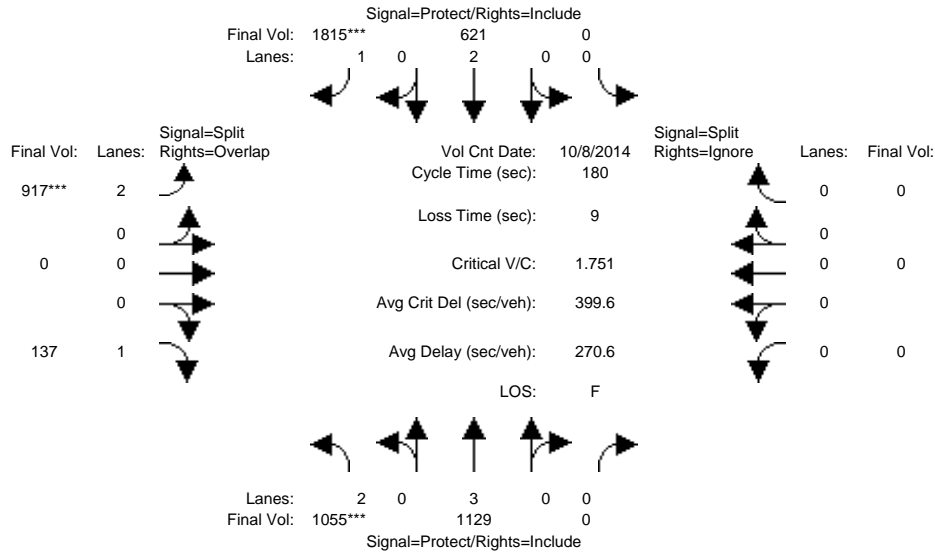

Approach:	North Bound			South Bound			East Bound			West Bound		
	L	T	R	L	T	R	L	T	R	L	T	R
Min. Green:	7	10	0	0	10	10	10	0	10	0	0	0
Y+R:	4.0	4.0	4.0	4.0	4.0	4.0	4.0	4.0	4.0	4.0	4.0	4.0
Volume Module: >> Count Date: 8 Oct 2014 <<												
Base Vol:	1055	1129	0	0	621	1815	1054	0	137	0	0	0
Growth Adj:	1.00	1.00	1.00	1.00	1.00	1.00	1.00	1.00	1.00	1.00	1.00	1.00
Initial Bse:	1055	1129	0	0	621	1815	1054	0	137	0	0	0
Added Vol:	0	0	0	0	0	0	0	0	0	0	0	0
PasserByVol:	0	0	0	0	0	0	0	0	0	0	0	0
Initial Fut:	1055	1129	0	0	621	1815	1054	0	137	0	0	0
User Adj:	1.00	1.00	1.00	1.00	1.00	1.00	0.87	1.00	1.00	1.00	1.00	0.00
PHF Adj:	1.00	1.00	1.00	1.00	1.00	1.00	1.00	1.00	1.00	1.00	1.00	0.00
PHF Volume:	1055	1129	0	0	621	1815	917	0	137	0	0	0
Reduct Vol:	0	0	0	0	0	0	0	0	0	0	0	0
Reduced Vol:	1055	1129	0	0	621	1815	917	0	137	0	0	0
PCE Adj:	1.00	1.00	1.00	1.00	1.00	1.00	1.00	1.00	1.00	1.00	1.00	0.00
MLF Adj:	1.00	1.00	1.00	1.00	1.00	1.00	1.00	1.00	1.00	1.00	1.00	0.00
FinalVolume:	1055	1129	0	0	621	1815	917	0	137	0	0	0
Saturation Flow Module:												
Sat/Lane:	1900	1900	1900	1900	1900	1900	1900	1900	1900	1900	1900	1900
Adjustment:	0.83	1.00	0.92	0.92	1.00	0.92	0.83	1.00	0.92	0.92	1.00	0.92
Lanes:	2.00	3.00	0.00	0.00	2.00	1.00	2.00	0.00	1.00	0.00	0.00	0.00
Final Sat.:	3150	5700	0	0	3800	1750	3150	0	1750	0	0	0
Capacity Analysis Module:												
Vol/Sat:	0.33	0.20	0.00	0.00	0.16	1.04	0.29	0.00	0.08	0.00	0.00	0.00
Crit Moves:	****					****	****					
Green Time:	34.4	141	0.0	0.0	107	106.6	29.9	0.0	64.4	0.0	0.0	0.0
Volume/Cap:	1.75	0.25	0.00	0.00	0.28	1.75	1.75	0.00	0.22	0.00	0.00	0.00
Delay/Veh:	417.4	5.3	0.0	0.0	17.9	378.5	420.7	0.0	37.9	0.0	0.0	0.0
User DelAdj:	1.00	1.00	1.00	1.00	1.00	1.00	1.00	1.00	1.00	1.00	1.00	1.00
AdjDel/Veh:	417.4	5.3	0.0	0.0	17.9	378.5	420.7	0.0	37.9	0.0	0.0	0.0
LOS by Move:	F	A	A	A	B	F	F	A	D	A	A	A
HCM2k95thQ:	102	11	0	0	15	310	89	0	9	0	0	0

Note: Queue reported is the number of cars per lane.

BART Phase II Extension Project

Level Of Service Computation Report
2000 HCM Operations (Future Volume Alternative)
PM - Existing Conditions

Intersection #5335: CENTRAL EXPWY/DE LA CRUZ BLVD

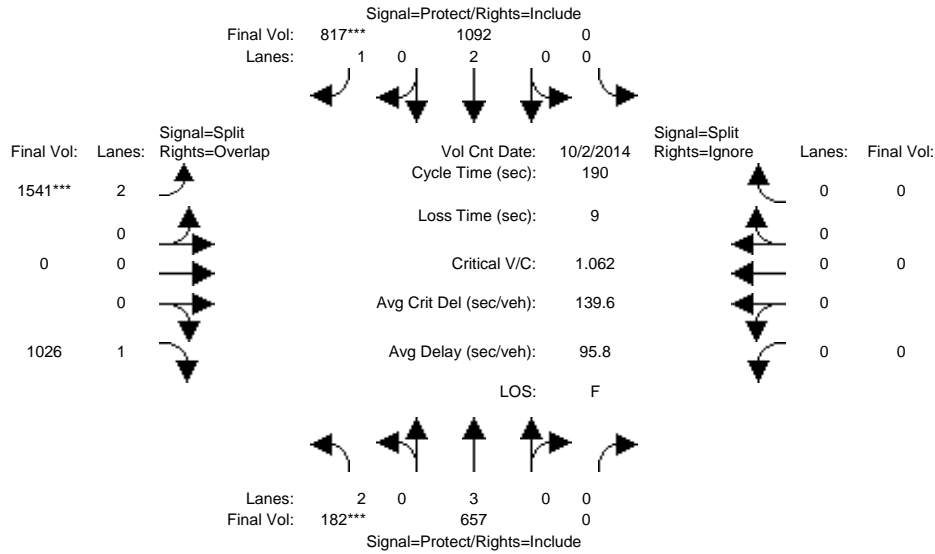

Approach:	North Bound			South Bound			East Bound			West Bound		
	L	T	R	L	T	R	L	T	R	L	T	R
Min. Green:	19	76	0	0	57	57	114	0	114	0	0	0
Y+R:	4.0	4.0	4.0	4.0	4.0	4.0	4.0	4.0	4.0	4.0	4.0	4.0

Volume Module:	>>	Count	Date:	2 Oct 2014	<<							
Base Vol:	182	657	0	0	1092	817	2083	0	1026	0	0	0
Growth Adj:	1.00	1.00	1.00	1.00	1.00	1.00	1.00	1.00	1.00	1.00	1.00	1.00
Initial Bse:	182	657	0	0	1092	817	2083	0	1026	0	0	0
Added Vol:	0	0	0	0	0	0	0	0	0	0	0	0
PasserByVol:	0	0	0	0	0	0	0	0	0	0	0	0
Initial Fut:	182	657	0	0	1092	817	2083	0	1026	0	0	0
User Adj:	1.00	1.00	1.00	1.00	1.00	1.00	0.74	1.00	1.00	1.00	1.00	0.00
PHF Adj:	1.00	1.00	1.00	1.00	1.00	1.00	1.00	1.00	1.00	1.00	1.00	0.00
PHF Volume:	182	657	0	0	1092	817	1541	0	1026	0	0	0
Reduct Vol:	0	0	0	0	0	0	0	0	0	0	0	0
Reduced Vol:	182	657	0	0	1092	817	1541	0	1026	0	0	0
PCE Adj:	1.00	1.00	1.00	1.00	1.00	1.00	1.00	1.00	1.00	1.00	1.00	0.00
MLF Adj:	1.00	1.00	1.00	1.00	1.00	1.00	1.00	1.00	1.00	1.00	1.00	0.00
FinalVolume:	182	657	0	0	1092	817	1541	0	1026	0	0	0

Saturation Flow Module:												
Sat/Lane:	1900	1900	1900	1900	1900	1900	1900	1900	1900	1900	1900	1900
Adjustment:	0.83	1.00	0.92	0.92	1.00	0.92	0.83	1.00	0.92	0.92	1.00	0.92
Lanes:	2.00	3.00	0.00	0.00	2.00	1.00	2.00	0.00	1.00	0.00	0.00	0.00
Final Sat.:	3150	5700	0	0	3800	1750	3150	0	1750	0	0	0

Capacity Analysis Module:												
Vol/Sat:	0.06	0.12	0.00	0.00	0.29	0.47	0.49	0.00	0.59	0.00	0.00	0.00
Crit Moves:	****				****	****	****					
Green Time:	18.1	72.6	0.0	0.0	54.4	54.4	108.8	0.0	127.0	0.0	0.0	0.0
Volume/Cap:	0.61	0.30	0.00	0.00	1.00	1.63	0.85	0.00	0.88	0.00	0.00	0.00
Delay/Veh:	89.9	43.0	0.0	0.0	99.1	363.5	26.8	0.0	17.7	0.0	0.0	0.0
User DelAdj:	1.00	1.00	1.00	1.00	1.00	1.00	1.00	1.00	1.00	1.00	1.00	1.00
AdjDel/Veh:	89.9	43.0	0.0	0.0	99.1	363.5	26.8	0.0	17.7	0.0	0.0	0.0
LOS by Move:	F	D	A	A	F	F	C	A	B	A	A	A
HCM2k95thQ:	12	17	0	0	59	141	63	0	58	0	0	0

Note: Queue reported is the number of cars per lane.

BART Phase II Extension Project

Level Of Service Computation Report
2000 HCM Operations (Future Volume Alternative)
AM - Existing Conditions

Intersection #5416: SAN TOMAS EXPWY/EL CAMINO REAL

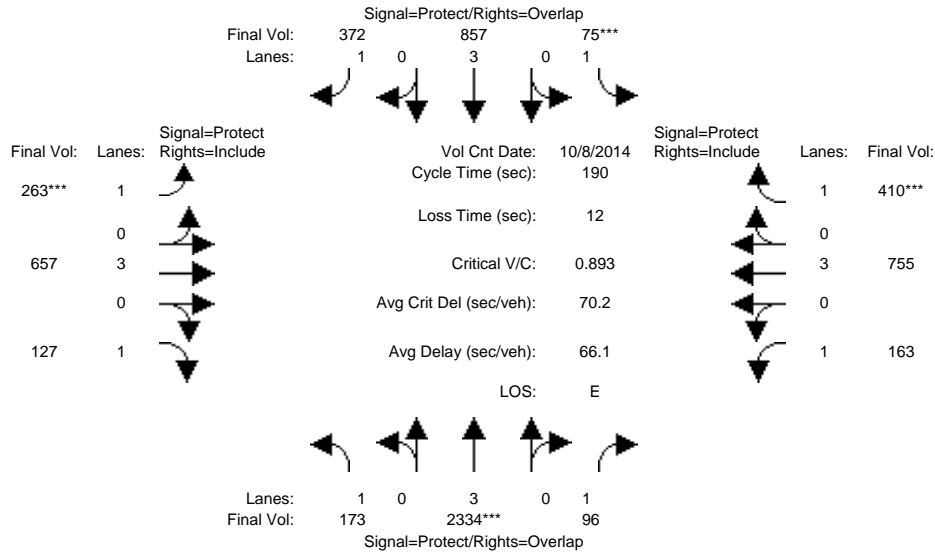

Approach:	North Bound			South Bound			East Bound			West Bound		
	L	T	R	L	T	R	L	T	R	L	T	R
Min. Green:	7	10	10	7	10	10	7	10	10	7	10	10
Y+R:	4.0	4.0	4.0	4.0	4.0	4.0	4.0	4.0	4.0	4.0	4.0	4.0
Volume Module: >> Count Date: 8 Oct 2014 <<												
Base Vol:	173	2779	96	75	1020	372	263	657	127	163	755	410
Growth Adj:	1.00	1.00	1.00	1.00	1.00	1.00	1.00	1.00	1.00	1.00	1.00	1.00
Initial Bse:	173	2779	96	75	1020	372	263	657	127	163	755	410
Added Vol:	0	0	0	0	0	0	0	0	0	0	0	0
PasserByVol:	0	0	0	0	0	0	0	0	0	0	0	0
Initial Fut:	173	2779	96	75	1020	372	263	657	127	163	755	410
User Adj:	1.00	0.84	1.00	1.00	0.84	1.00	1.00	1.00	1.00	1.00	1.00	1.00
PHF Adj:	1.00	1.00	1.00	1.00	1.00	1.00	1.00	1.00	1.00	1.00	1.00	1.00
PHF Volume:	173	2334	96	75	857	372	263	657	127	163	755	410
Reduct Vol:	0	0	0	0	0	0	0	0	0	0	0	0
Reduced Vol:	173	2334	96	75	857	372	263	657	127	163	755	410
PCE Adj:	1.00	1.00	1.00	1.00	1.00	1.00	1.00	1.00	1.00	1.00	1.00	1.00
MLF Adj:	1.00	1.00	1.00	1.00	1.00	1.00	1.00	1.00	1.00	1.00	1.00	1.00
FinalVolume:	173	2334	96	75	857	372	263	657	127	163	755	410
Saturation Flow Module:												
Sat/Lane:	1900	1900	1900	1900	1900	1900	1900	1900	1900	1900	1900	1900
Adjustment:	0.92	1.00	0.92	0.92	1.00	0.92	0.92	1.00	0.92	0.92	1.00	0.92
Lanes:	1.00	3.00	1.00	1.00	3.00	1.00	1.00	3.00	1.00	1.00	3.00	1.00
Final Sat.:	1750	5700	1750	1750	5700	1750	1750	5700	1750	1750	5700	1750
Capacity Analysis Module:												
Vol/Sat:	0.10	0.41	0.05	0.04	0.15	0.21	0.15	0.12	0.07	0.09	0.13	0.23
Crit Moves:	****	****	****	****	****	****	****	****	****	****	****	****
Green Time:	38.2	87.1	123.7	9.1	58.0	90.0	32.0	45.2	45.2	36.6	49.8	49.8
Volume/Cap:	0.49	0.89	0.08	0.89	0.49	0.45	0.89	0.48	0.30	0.48	0.51	0.89
Delay/Veh:	68.9	60.7	18.5	156.9	70.0	53.9	104.5	62.6	59.9	69.4	59.9	86.9
User DelAdj:	1.00	1.00	1.00	1.00	1.00	1.00	1.00	1.00	1.00	1.00	1.00	1.00
AdjDel/Veh:	68.9	60.7	18.5	156.9	70.0	53.9	104.5	62.6	59.9	69.4	59.9	86.9
LOS by Move:	E	E	B	F	E	D	F	E	E	E	E	F
HCM2k95thQ:	18	69	7	11	26	34	32	20	12	17	22	43

Note: Queue reported is the number of cars per lane.

BART Phase II Extension Project

Level Of Service Computation Report
2000 HCM Operations (Future Volume Alternative)
PM - Existing Conditions

Intersection #5416: SAN TOMAS EXPWY/EL CAMINO REAL

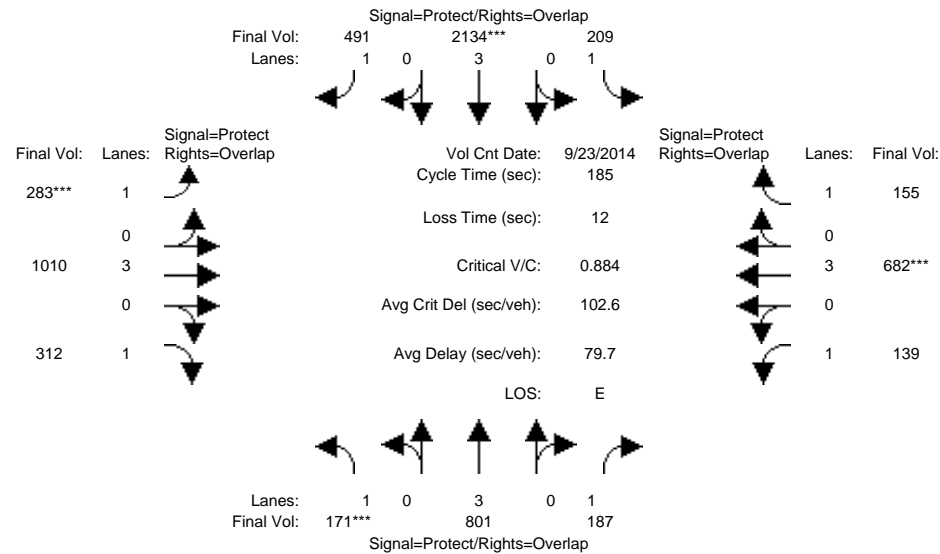

Approach:	North Bound			South Bound			East Bound			West Bound		
	L	T	R	L	T	R	L	T	R	L	T	R
Min. Green:	12	72	72	33	93	93	39	50	50	29	41	41
Y+R:	4.0	4.0	4.0	4.0	4.0	4.0	4.0	4.0	4.0	4.0	4.0	4.0

Volume Module:	>>	Count	Date:	23 Sep 2014	<<							
Base Vol:	171	1054	187	209	2771	491	283	1010	312	139	682	155
Growth Adj:	1.00	1.00	1.00	1.00	1.00	1.00	1.00	1.00	1.00	1.00	1.00	1.00
Initial Bse:	171	1054	187	209	2771	491	283	1010	312	139	682	155
Added Vol:	0	0	0	0	0	0	0	0	0	0	0	0
PasserByVol:	0	0	0	0	0	0	0	0	0	0	0	0
Initial Fut:	171	1054	187	209	2771	491	283	1010	312	139	682	155
User Adj:	1.00	0.76	1.00	1.00	0.77	1.00	1.00	1.00	1.00	1.00	1.00	1.00
PHF Adj:	1.00	1.00	1.00	1.00	1.00	1.00	1.00	1.00	1.00	1.00	1.00	1.00
PHF Volume:	171	801	187	209	2134	491	283	1010	312	139	682	155
Reduct Vol:	0	0	0	0	0	0	0	0	0	0	0	0
Reduced Vol:	171	801	187	209	2134	491	283	1010	312	139	682	155
PCE Adj:	1.00	1.00	1.00	1.00	1.00	1.00	1.00	1.00	1.00	1.00	1.00	1.00
MLF Adj:	1.00	1.00	1.00	1.00	1.00	1.00	1.00	1.00	1.00	1.00	1.00	1.00
FinalVolume:	171	801	187	209	2134	491	283	1010	312	139	682	155

Saturation Flow Module:												
Sat/Lane:	1900	1900	1900	1900	1900	1900	1900	1900	1900	1900	1900	1900
Adjustment:	0.92	1.00	0.92	0.92	0.83	0.92	0.92	1.00	0.92	0.92	1.00	0.92
Lanes:	1.00	3.00	1.00	1.00	3.00	1.00	1.00	3.00	1.00	1.00	3.00	1.00
Final Sat.:	1750	5700	1750	1750	4731	1750	1750	5700	1750	1750	5700	1750

Capacity Analysis Module:												
Vol/Sat:	0.10	0.14	0.11	0.12	0.45	0.28	0.16	0.18	0.18	0.08	0.12	0.09
Crit Moves:	****				****		****				****	
Green Time:	11.3	67.6	95.2	31.0	87.3	124.0	36.6	47.5	58.8	27.6	38.5	69.5
Volume/Cap:	1.60	0.38	0.21	0.71	0.96	0.42	0.82	0.69	0.56	0.53	0.57	0.24
Delay/Veh:	403.6	51.3	32.8	95.9	90.3	35.3	89.6	67.5	57.1	79.6	70.9	42.3
User DelAdj:	1.00	1.00	1.00	1.00	1.00	1.00	1.00	1.00	1.00	1.00	1.00	1.00
AdjDel/Veh:	403.6	51.3	32.8	95.9	90.3	35.3	89.6	67.5	57.1	79.6	70.9	42.3
LOS by Move:	F	D	C	F	F	D	F	E	E	E	E	D
HCM2k95thQ:	33	23	15	24	71	43	33	32	29	15	22	13

Note: Queue reported is the number of cars per lane.

BART Phase II Extension Project

Level Of Service Computation Report
 2000 HCM Operations (Future Volume Alternative)
 AM - Existing Conditions

Intersection #5444: Lafayette/Lewis

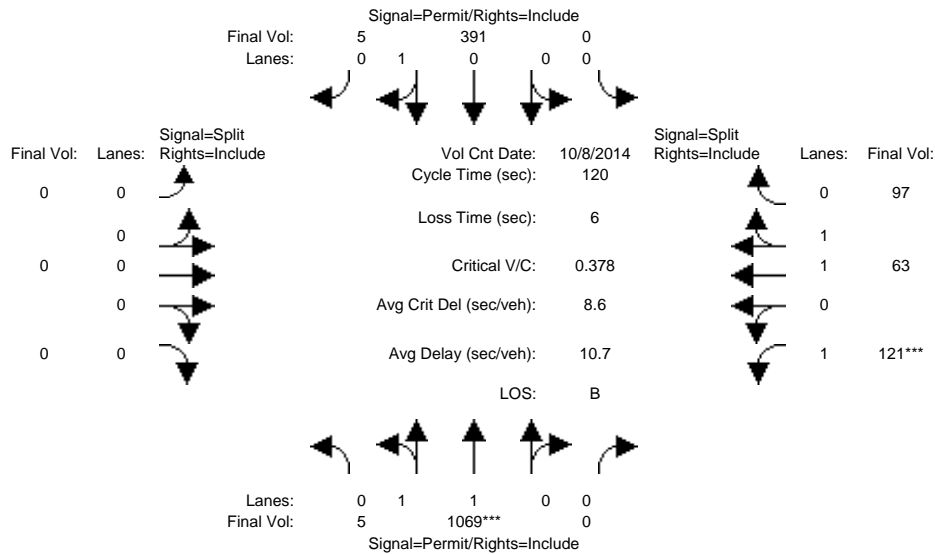

Approach:	North Bound			South Bound			East Bound			West Bound		
	L	T	R	L	T	R	L	T	R	L	T	R
Min. Green:	10	10	0	0	10	10	0	0	0	10	10	10
Y+R:	4.0	4.0	4.0	4.0	4.0	4.0	4.0	4.0	4.0	4.0	4.0	4.0
Volume Module: >> Count Date: 8 Oct 2014 <<												
Base Vol:	5	1069	0	0	391	5	0	0	0	121	63	97
Growth Adj:	1.00	1.00	1.00	1.00	1.00	1.00	1.00	1.00	1.00	1.00	1.00	1.00
Initial Bse:	5	1069	0	0	391	5	0	0	0	121	63	97
Added Vol:	0	0	0	0	0	0	0	0	0	0	0	0
PasserByVol:	0	0	0	0	0	0	0	0	0	0	0	0
Initial Fut:	5	1069	0	0	391	5	0	0	0	121	63	97
User Adj:	1.00	1.00	1.00	1.00	1.00	1.00	1.00	1.00	1.00	1.00	1.00	1.00
PHF Adj:	1.00	1.00	1.00	1.00	1.00	1.00	1.00	1.00	1.00	1.00	1.00	1.00
PHF Volume:	5	1069	0	0	391	5	0	0	0	121	63	97
Reduct Vol:	0	0	0	0	0	0	0	0	0	0	0	0
Reduced Vol:	5	1069	0	0	391	5	0	0	0	121	63	97
PCE Adj:	1.00	1.00	1.00	1.00	1.00	1.00	1.00	1.00	1.00	1.00	1.00	1.00
MLF Adj:	1.00	1.00	1.00	1.00	1.00	1.00	1.00	1.00	1.00	1.00	1.00	1.00
FinalVolume:	5	1069	0	0	391	5	0	0	0	121	63	97
Saturation Flow Module:												
Sat/Lane:	1900	1900	1900	1900	1900	1900	1900	1900	1900	1900	1900	1900
Adjustment:	0.95	0.97	0.92	0.92	0.95	0.95	0.92	1.00	0.92	0.92	1.00	0.92
Lanes:	0.01	1.99	0.00	0.00	0.99	0.01	0.00	0.00	0.00	1.00	1.00	1.00
Final Sat.:	17	3683	0	0	1777	23	0	0	0	1750	1900	1750
Capacity Analysis Module:												
Vol/Sat:	0.29	0.29	0.00	0.00	0.22	0.22	0.00	0.00	0.00	0.07	0.03	0.06
Crit Moves:	****											
Green Time:	92.1	92.1	0.0	0.0	92.1	92.1	0.0	0.0	0.0	21.9	21.9	21.9
Volume/Cap:	0.38	0.38	0.00	0.00	0.29	0.29	0.00	0.00	0.00	0.38	0.18	0.30
Delay/Veh:	4.7	4.7	0.0	0.0	4.3	4.3	0.0	0.0	0.0	43.8	41.5	42.8
User DelAdj:	1.00	1.00	1.00	1.00	1.00	1.00	1.00	1.00	1.00	1.00	1.00	1.00
AdjDel/Veh:	4.7	4.7	0.0	0.0	4.3	4.3	0.0	0.0	0.0	43.8	41.5	42.8
LOS by Move:	A	A	A	A	A	A	A	A	A	D	D	D
HCM2k95thQ:	13	13	0	0	9	9	0	0	0	9	4	7

Note: Queue reported is the number of cars per lane.

BART Phase II Extension Project

Level Of Service Computation Report
 2000 HCM Operations (Future Volume Alternative)
 PM - Existing Conditions

Intersection #5444: Lafayette/Lewis

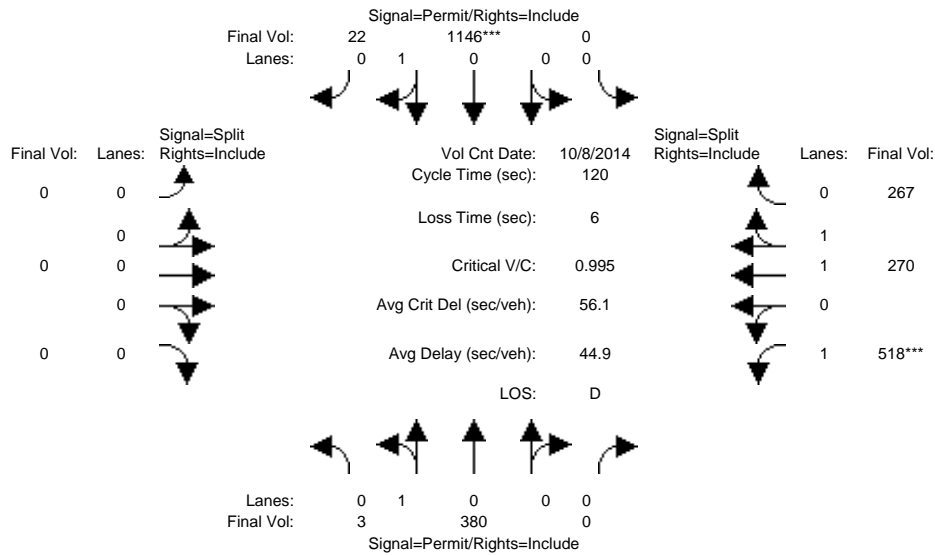

Approach:	North Bound			South Bound			East Bound			West Bound			
Movement:	L	T	R	L	T	R	L	T	R	L	T	R	
Min. Green:	10	10	0	0	10	10	0	0	0	10	10	10	
Y+R:	4.0	4.0	4.0	4.0	4.0	4.0	4.0	4.0	4.0	4.0	4.0	4.0	
Volume Module: >> Count Date: 8 Oct 2014 <<													
Base Vol:	3	380	0	0	1146	22	0	0	0	518	270	267	
Growth Adj:	1.00	1.00	1.00	1.00	1.00	1.00	1.00	1.00	1.00	1.00	1.00	1.00	
Initial Bse:	3	380	0	0	1146	22	0	0	0	518	270	267	
Added Vol:	0	0	0	0	0	0	0	0	0	0	0	0	
PasserByVol:	0	0	0	0	0	0	0	0	0	0	0	0	
Initial Fut:	3	380	0	0	1146	22	0	0	0	518	270	267	
User Adj:	1.00	1.00	1.00	1.00	1.00	1.00	1.00	1.00	1.00	1.00	1.00	1.00	
PHF Adj:	1.00	1.00	1.00	1.00	1.00	1.00	1.00	1.00	1.00	1.00	1.00	1.00	
PHF Volume:	3	380	0	0	1146	22	0	0	0	518	270	267	
Reduct Vol:	0	0	0	0	0	0	0	0	0	0	0	0	
Reduced Vol:	3	380	0	0	1146	22	0	0	0	518	270	267	
PCE Adj:	1.00	1.00	1.00	1.00	1.00	1.00	1.00	1.00	1.00	1.00	1.00	1.00	
MLF Adj:	1.00	1.00	1.00	1.00	1.00	1.00	1.00	1.00	1.00	1.00	1.00	1.00	
FinalVolume:	3	380	0	0	1146	22	0	0	0	518	270	267	
Saturation Flow Module:													
Sat/Lane:	1900	1900	1900	1900	1900	1900	1900	1900	1900	1900	1900	1900	
Adjustment:	0.95	0.95	0.92	0.92	0.95	0.95	0.92	1.00	0.92	0.92	1.00	0.95	
Lanes:	0.01	0.99	0.00	0.00	0.98	0.02	0.00	0.00	0.00	1.00	1.00	1.00	
Final Sat.:	14	1786	0	0	1766	34	0	0	0	1750	1899	1800	
Capacity Analysis Module:													
Vol/Sat:	0.21	0.21	0.00	0.00	0.65	0.65	0.00	0.00	0.00	0.30	0.14	0.15	
Crit Moves:							****						
Green Time:	78.3	78.3	0.0	0.0	78.3	78.3	0.0	0.0	0.0	35.7	35.7	35.7	
Volume/Cap:	0.33	0.33	0.00	0.00	0.99	0.99	0.00	0.00	0.00	0.99	0.48	0.50	
Delay/Veh:	9.4	9.4	0.0	0.0	45.5	45.5	0.0	0.0	0.0	80.0	34.8	35.1	
User DelAdj:	1.00	1.00	1.00	1.00	1.00	1.00	1.00	1.00	1.00	1.00	1.00	1.00	
AdjDel/Veh:	9.4	9.4	0.0	0.0	45.5	45.5	0.0	0.0	0.0	80.0	34.8	35.1	
LOS by Move:	A	A	A	A	D	D	A	A	A	F	C	D	
HCM2k95thQ:	12	12	0	0	77	77	0	0	0	44	16	16	

Note: Queue reported is the number of cars per lane.

BART Phase II Extension Project

Level Of Service Computation Report
 2000 HCM Operations (Future Volume Alternative)
 AM - 2025 No Project Conditions

Intersection #6: DE LA CRUZ/MARTIN

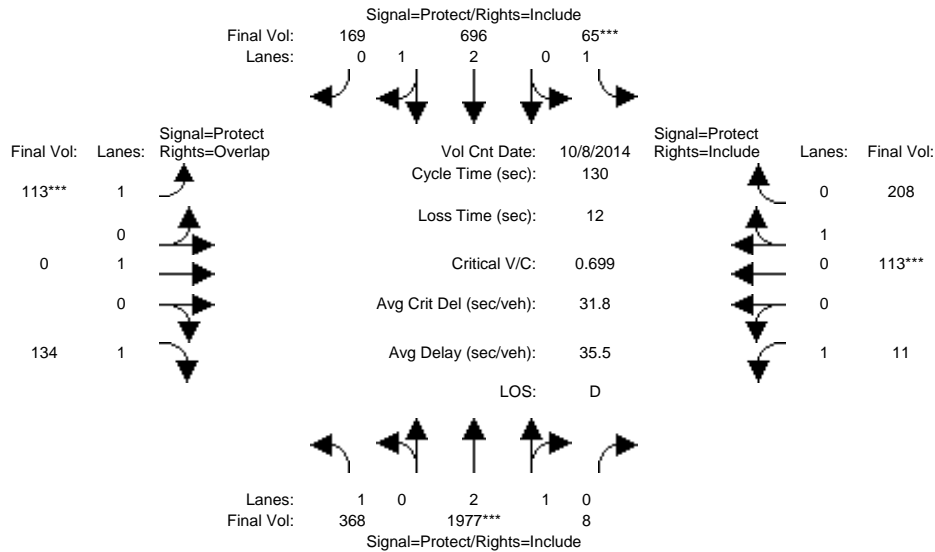

Approach:	North Bound			South Bound			East Bound			West Bound		
	L	T	R	L	T	R	L	T	R	L	T	R
Movement:												
Min. Green:	7	10	10	7	10	10	7	10	10	7	10	10
Y+R:	4.0	4.0	4.0	4.0	4.0	4.0	4.0	4.0	4.0	4.0	4.0	4.0

Volume Module:	>>	Count	Date:	8 Oct 2014	<<											
Base Vol:	368	1977	8	65	696	169	113	0	134	11	113	208				
Growth Adj:	1.00	1.00	1.00	1.00	1.00	1.00	1.00	1.00	1.00	1.00	1.00	1.00				
Initial Bse:	368	1977	8	65	696	169	113	0	134	11	113	208				
Added Vol:	0	0	0	0	0	0	0	0	0	0	0	0				
PasserByVol:	0	0	0	0	0	0	0	0	0	0	0	0				
Initial Fut:	368	1977	8	65	696	169	113	0	134	11	113	208				
User Adj:	1.00	1.00	1.00	1.00	1.00	1.00	1.00	1.00	1.00	1.00	1.00	1.00				
PHF Adj:	1.00	1.00	1.00	1.00	1.00	1.00	1.00	1.00	1.00	1.00	1.00	1.00				
PHF Volume:	368	1977	8	65	696	169	113	0	134	11	113	208				
Reduct Vol:	0	0	0	0	0	0	0	0	0	0	0	0				
Reduced Vol:	368	1977	8	65	696	169	113	0	134	11	113	208				
PCE Adj:	1.00	1.00	1.00	1.00	1.00	1.00	1.00	1.00	1.00	1.00	1.00	1.00				
MLF Adj:	1.00	1.00	1.00	1.00	1.00	1.00	1.00	1.00	1.00	1.00	1.00	1.00				
Final Volume:	368	1977	8	65	696	169	113	0	134	11	113	208				

Saturation Flow Module:												
Sat/Lane:	1900	1900	1900	1900	1900	1900	1900	1900	1900	1900	1900	1900
Adjustment:	0.92	0.98	0.95	0.92	0.99	0.95	0.92	1.00	0.92	0.92	0.95	0.95
Lanes:	1.00	2.99	0.01	1.00	2.39	0.61	1.00	1.00	1.00	1.00	0.35	0.65
Final Sat.:	1750	5577	23	1750	4504	1094	1750	1900	1750	1750	634	1166

Capacity Analysis Module:												
Vol/Sat:	0.21	0.35	0.35	0.04	0.15	0.15	0.06	0.00	0.08	0.01	0.18	0.18
Crit Moves:		****		****			****				****	
Green Time:	42.0	65.9	65.9	7.0	30.9	30.9	12.0	0.0	54.0	45.1	33.1	33.1
Volume/Cap:	0.65	0.70	0.70	0.69	0.65	0.65	0.70	0.00	0.18	0.02	0.70	0.70
Delay/Veh:	40.4	25.3	25.3	79.9	45.9	45.9	70.0	0.0	24.2	27.9	48.7	48.7
User DelAdj:	1.00	1.00	1.00	1.00	1.00	1.00	1.00	1.00	1.00	1.00	1.00	1.00
AdjDel/Veh:	40.4	25.3	25.3	79.9	45.9	45.9	70.0	0.0	24.2	27.9	48.7	48.7
LOS by Move:	D	C	C	E	D	D	E	A	C	C	D	D
HCM2k95thQ:	24	35	35	6	19	19	10	0	7	1	24	24

Note: Queue reported is the number of cars per lane.

BART Phase II Extension Project

Level Of Service Computation Report
 2000 HCM Operations (Future Volume Alternative)
 PM - 2025 No Project Conditions

Intersection #6: DE LA CRUZ/MARTIN

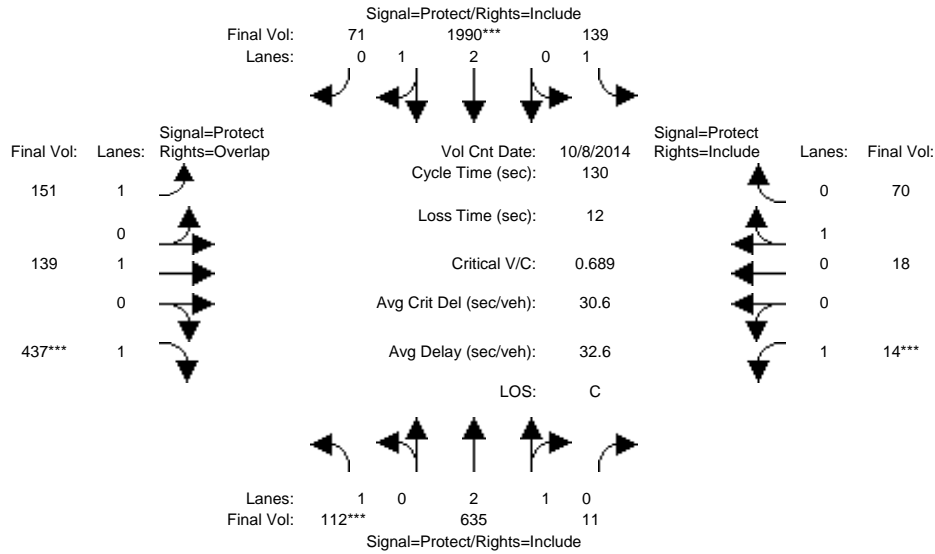

Approach:	North Bound			South Bound			East Bound			West Bound		
	L	T	R	L	T	R	L	T	R	L	T	R
Min. Green:	7	10	10	7	10	10	7	10	10	7	10	10
Y+R:	4.0	4.0	4.0	4.0	4.0	4.0	4.0	4.0	4.0	4.0	4.0	4.0

Volume Module: >> Count Date: 8 Oct 2014 <<

Base Vol:	112	635	11	139	1990	71	151	139	437	14	18	70
Growth Adj:	1.00	1.00	1.00	1.00	1.00	1.00	1.00	1.00	1.00	1.00	1.00	1.00
Initial Bse:	112	635	11	139	1990	71	151	139	437	14	18	70
Added Vol:	0	0	0	0	0	0	0	0	0	0	0	0
PasserByVol:	0	0	0	0	0	0	0	0	0	0	0	0
Initial Fut:	112	635	11	139	1990	71	151	139	437	14	18	70
User Adj:	1.00	1.00	1.00	1.00	1.00	1.00	1.00	1.00	1.00	1.00	1.00	1.00
PHF Adj:	1.00	1.00	1.00	1.00	1.00	1.00	1.00	1.00	1.00	1.00	1.00	1.00
PHF Volume:	112	635	11	139	1990	71	151	139	437	14	18	70
Reduct Vol:	0	0	0	0	0	0	0	0	0	0	0	0
Reduced Vol:	112	635	11	139	1990	71	151	139	437	14	18	70
PCE Adj:	1.00	1.00	1.00	1.00	1.00	1.00	1.00	1.00	1.00	1.00	1.00	1.00
MLF Adj:	1.00	1.00	1.00	1.00	1.00	1.00	1.00	1.00	1.00	1.00	1.00	1.00
FinalVolume:	112	635	11	139	1990	71	151	139	437	14	18	70

Saturation Flow Module:

Sat/Lane:	1900	1900	1900	1900	1900	1900	1900	1900	1900	1900	1900	1900
Adjustment:	0.92	0.98	0.95	0.92	0.98	0.95	0.92	1.00	0.92	0.92	0.95	0.95
Lanes:	1.00	2.95	0.05	1.00	2.89	0.11	1.00	1.00	1.00	1.00	0.20	0.80
Final Sat.:	1750	5505	95	1750	5407	193	1750	1900	1750	1750	368	1432

Capacity Analysis Module:

Vol/Sat:	0.06	0.12	0.12	0.08	0.37	0.37	0.09	0.07	0.25	0.01	0.05	0.05
Crit Moves:	****			****			****		****	****		
Green Time:	11.5	46.0	46.0	31.7	66.1	66.1	21.3	33.4	44.9	7.0	19.0	19.0
Volume/Cap:	0.72	0.33	0.33	0.33	0.72	0.72	0.53	0.29	0.72	0.15	0.33	0.33
Delay/Veh:	73.2	30.8	30.8	40.9	25.8	25.8	51.5	39.1	41.5	59.4	50.6	50.6
User DelAdj:	1.00	1.00	1.00	1.00	1.00	1.00	1.00	1.00	1.00	1.00	1.00	1.00
AdjDel/Veh:	73.2	30.8	30.8	40.9	25.8	25.8	51.5	39.1	41.5	59.4	50.6	50.6
LOS by Move:	E	C	C	D	C	C	D	D	D	E	D	D
HCM2k95thQ:	10	12	12	9	36	36	11	8	29	1	7	7

Note: Queue reported is the number of cars per lane.

BART Phase II Extension Project

Level Of Service Computation Report
 2000 HCM Operations (Future Volume Alternative)
 AM - 2025 No Project Conditions

Intersection #7: LAFAYETTE/REED

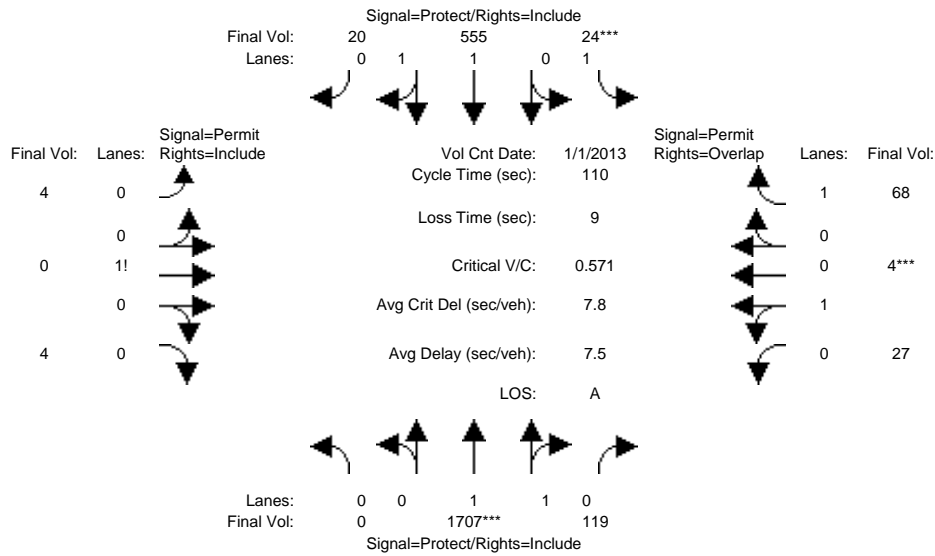

Approach:	North Bound			South Bound			East Bound			West Bound		
	L	T	R	L	T	R	L	T	R	L	T	R
Min. Green:	7	10	10	7	10	10	10	10	10	10	10	10
Y+R:	4.0	4.0	4.0	4.0	4.0	4.0	4.0	4.0	4.0	4.0	4.0	4.0

Volume Module:	>>	Count	Date:	1 Jan 2013	<<											
Base Vol:	0	1707	119	24	555	20	4	0	4	27	4	68				
Growth Adj:	1.00	1.00	1.00	1.00	1.00	1.00	1.00	1.00	1.00	1.00	1.00	1.00				
Initial Bse:	0	1707	119	24	555	20	4	0	4	27	4	68				
Added Vol:	0	0	0	0	0	0	0	0	0	0	0	0				
PasserByVol:	0	0	0	0	0	0	0	0	0	0	0	0				
Initial Fut:	0	1707	119	24	555	20	4	0	4	27	4	68				
User Adj:	1.00	1.00	1.00	1.00	1.00	1.00	1.00	1.00	1.00	1.00	1.00	1.00				
PHF Adj:	1.00	1.00	1.00	1.00	1.00	1.00	1.00	1.00	1.00	1.00	1.00	1.00				
PHF Volume:	0	1707	119	24	555	20	4	0	4	27	4	68				
Reduct Vol:	0	0	0	0	0	0	0	0	0	0	0	0				
Reduced Vol:	0	1707	119	24	555	20	4	0	4	27	4	68				
PCE Adj:	1.00	1.00	1.00	1.00	1.00	1.00	1.00	1.00	1.00	1.00	1.00	1.00				
MLF Adj:	1.00	1.00	1.00	1.00	1.00	1.00	1.00	1.00	1.00	1.00	1.00	1.00				
FinalVolume:	0	1707	119	24	555	20	4	0	4	27	4	68				

Saturation Flow Module:												
Sat/Lane:	1900	1900	1900	1900	1900	1900	1900	1900	1900	1900	1900	1900
Adjustment:	0.92	0.98	0.95	0.92	0.97	0.95	0.92	0.92	0.92	0.95	0.95	0.92
Lanes:	0.00	1.87	0.13	1.00	1.93	0.07	0.50	0.00	0.50	0.87	0.13	1.00
Final Sat.:	0	3459	241	1750	3571	129	875	0	875	1568	232	1750

Capacity Analysis Module:												
Vol/Sat:	0.00	0.49	0.49	0.01	0.16	0.16	0.00	0.00	0.00	0.02	0.02	0.04
Crit Moves:	****			****						****		
Green Time:	0.0	84.0	84.0	7.0	91.0	91.0	10.0	0.0	10.0	10.0	10.0	17.0
Volume/Cap:	0.00	0.65	0.65	0.22	0.19	0.19	0.05	0.00	0.05	0.19	0.19	0.25
Delay/Veh:	0.0	6.6	6.6	49.9	2.0	2.0	45.8	0.0	45.8	46.8	46.8	41.4
User DelAdj:	1.00	1.00	1.00	1.00	1.00	1.00	1.00	1.00	1.00	1.00	1.00	1.00
AdjDel/Veh:	0.0	6.6	6.6	49.9	2.0	2.0	45.8	0.0	45.8	46.8	46.8	41.4
LOS by Move:	A	A	A	D	A	A	D	A	D	D	D	D
HCM2k95thQ:	0	27	27	2	4	4	1	0	1	2	2	4

Note: Queue reported is the number of cars per lane.

BART Phase II Extension Project

Level Of Service Computation Report
 2000 HCM Operations (Future Volume Alternative)
 PM - 2025 No Project Conditions

Intersection #7: LAFAYETTE/REED

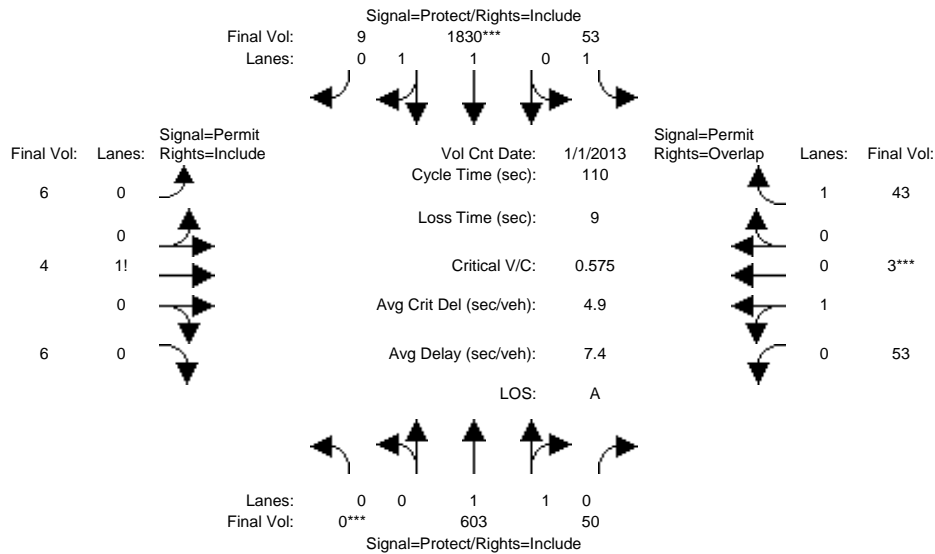

Approach:	North Bound			South Bound			East Bound			West Bound		
	L	T	R	L	T	R	L	T	R	L	T	R
Min. Green:	7	10	10	7	10	10	10	10	10	10	10	10
Y+R:	4.0	4.0	4.0	4.0	4.0	4.0	4.0	4.0	4.0	4.0	4.0	4.0
Volume Module: >> Count Date: 1 Jan 2013 <<												
Base Vol:	0	603	50	53	1830	9	6	4	6	53	3	43
Growth Adj:	1.00	1.00	1.00	1.00	1.00	1.00	1.00	1.00	1.00	1.00	1.00	1.00
Initial Bse:	0	603	50	53	1830	9	6	4	6	53	3	43
Added Vol:	0	0	0	0	0	0	0	0	0	0	0	0
PasserByVol:	0	0	0	0	0	0	0	0	0	0	0	0
Initial Fut:	0	603	50	53	1830	9	6	4	6	53	3	43
User Adj:	1.00	1.00	1.00	1.00	1.00	1.00	1.00	1.00	1.00	1.00	1.00	1.00
PHF Adj:	1.00	1.00	1.00	1.00	1.00	1.00	1.00	1.00	1.00	1.00	1.00	1.00
PHF Volume:	0	603	50	53	1830	9	6	4	6	53	3	43
Reduct Vol:	0	0	0	0	0	0	0	0	0	0	0	0
Reduced Vol:	0	603	50	53	1830	9	6	4	6	53	3	43
PCE Adj:	1.00	1.00	1.00	1.00	1.00	1.00	1.00	1.00	1.00	1.00	1.00	1.00
MLF Adj:	1.00	1.00	1.00	1.00	1.00	1.00	1.00	1.00	1.00	1.00	1.00	1.00
FinalVolume:	0	603	50	53	1830	9	6	4	6	53	3	43
Saturation Flow Module:												
Sat/Lane:	1900	1900	1900	1900	1900	1900	1900	1900	1900	1900	1900	1900
Adjustment:	0.92	0.98	0.95	0.92	0.97	0.95	0.92	0.92	0.92	0.95	0.95	0.92
Lanes:	0.00	1.84	0.16	1.00	1.99	0.01	0.37	0.25	0.38	0.95	0.05	1.00
Final Sat.:	0	3416	283	1750	3682	18	656	438	656	1704	96	1750
Capacity Analysis Module:												
Vol/Sat:	0.00	0.18	0.18	0.03	0.50	0.50	0.01	0.01	0.01	0.03	0.03	0.02
Crit Moves:	****				****						****	
Green Time:	0.0	66.9	66.9	24.1	91.0	91.0	10.0	10.0	10.0	10.0	10.0	34.1
Volume/Cap:	0.00	0.29	0.29	0.14	0.60	0.60	0.10	0.10	0.10	0.34	0.34	0.08
Delay/Veh:	0.0	10.3	10.3	34.7	3.6	3.6	46.2	46.2	46.2	48.2	48.2	26.9
User DelAdj:	1.00	1.00	1.00	1.00	1.00	1.00	1.00	1.00	1.00	1.00	1.00	1.00
AdjDel/Veh:	0.0	10.3	10.3	34.7	3.6	3.6	46.2	46.2	46.2	48.2	48.2	26.9
LOS by Move:	A	B	B	C	A	A	D	D	D	D	D	C
HCM2k95thQ:	0	10	10	3	21	21	1	1	1	4	4	2

Note: Queue reported is the number of cars per lane.

BART Phase II Extension Project

Level Of Service Computation Report
 2000 HCM Operations (Future Volume Alternative)
 AM - 2025 No Project Conditions

Intersection #9: Coleman/Brokaw

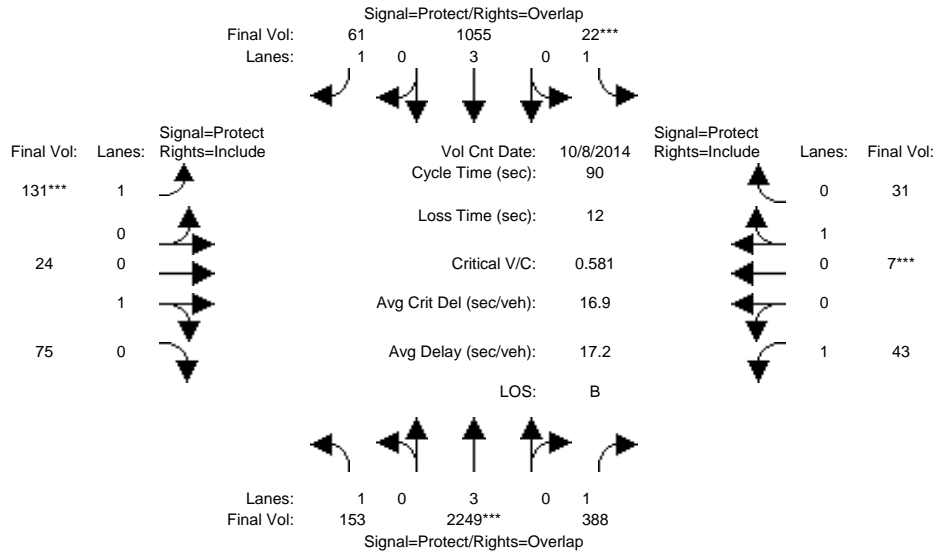

Approach:	North Bound			South Bound			East Bound			West Bound		
	L	T	R	L	T	R	L	T	R	L	T	R
Min. Green:	7	10	10	7	10	10	7	10	10	7	10	10
Y+R:	4.0	4.0	4.0	4.0	4.0	4.0	4.0	4.0	4.0	4.0	4.0	4.0
Volume Module: >> Count Date: 8 Oct 2014 <<												
Base Vol:	153	2249	388	22	1055	61	131	24	75	43	7	31
Growth Adj:	1.00	1.00	1.00	1.00	1.00	1.00	1.00	1.00	1.00	1.00	1.00	1.00
Initial Bse:	153	2249	388	22	1055	61	131	24	75	43	7	31
Added Vol:	0	0	0	0	0	0	0	0	0	0	0	0
PasserByVol:	0	0	0	0	0	0	0	0	0	0	0	0
Initial Fut:	153	2249	388	22	1055	61	131	24	75	43	7	31
User Adj:	1.00	1.00	1.00	1.00	1.00	1.00	1.00	1.00	1.00	1.00	1.00	1.00
PHF Adj:	1.00	1.00	1.00	1.00	1.00	1.00	1.00	1.00	1.00	1.00	1.00	1.00
PHF Volume:	153	2249	388	22	1055	61	131	24	75	43	7	31
Reduct Vol:	0	0	0	0	0	0	0	0	0	0	0	0
Reduced Vol:	153	2249	388	22	1055	61	131	24	75	43	7	31
PCE Adj:	1.00	1.00	1.00	1.00	1.00	1.00	1.00	1.00	1.00	1.00	1.00	1.00
MLF Adj:	1.00	1.00	1.00	1.00	1.00	1.00	1.00	1.00	1.00	1.00	1.00	1.00
FinalVolume:	153	2249	388	22	1055	61	131	24	75	43	7	31
Saturation Flow Module:												
Sat/Lane:	1900	1900	1900	1900	1900	1900	1900	1900	1900	1900	1900	1900
Adjustment:	0.92	1.00	0.92	0.92	1.00	0.92	0.92	0.95	0.95	0.92	0.95	0.95
Lanes:	1.00	3.00	1.00	1.00	3.00	1.00	1.00	0.24	0.76	1.00	0.18	0.82
Final Sat.:	1750	5700	1750	1750	5700	1750	1750	436	1364	1750	332	1468
Capacity Analysis Module:												
Vol/Sat:	0.09	0.39	0.22	0.01	0.19	0.03	0.07	0.06	0.06	0.02	0.02	0.02
Crit Moves:	****			****			****			****		
Green Time:	18.7	51.3	59.4	7.0	39.6	49.3	9.7	11.6	11.6	8.1	10.0	10.0
Volume/Cap:	0.42	0.69	0.34	0.16	0.42	0.06	0.69	0.43	0.43	0.27	0.19	0.19
Delay/Veh:	31.7	14.4	6.9	39.3	17.4	9.6	49.2	37.4	37.4	39.1	36.8	36.8
User DelAdj:	1.00	1.00	1.00	1.00	1.00	1.00	1.00	1.00	1.00	1.00	1.00	1.00
AdjDel/Veh:	31.7	14.4	6.9	39.3	17.4	9.6	49.2	37.4	37.4	39.1	36.8	36.8
LOS by Move:	C	B	A	D	B	A	D	D	D	D	D	D
HCM2k95thQ:	7	24	9	1	12	2	10	6	6	2	2	2

Note: Queue reported is the number of cars per lane.

BART Phase II Extension Project

Level Of Service Computation Report
 2000 HCM Operations (Future Volume Alternative)
 PM - 2025 No Project Conditions

Intersection #9: Coleman/Brokaw

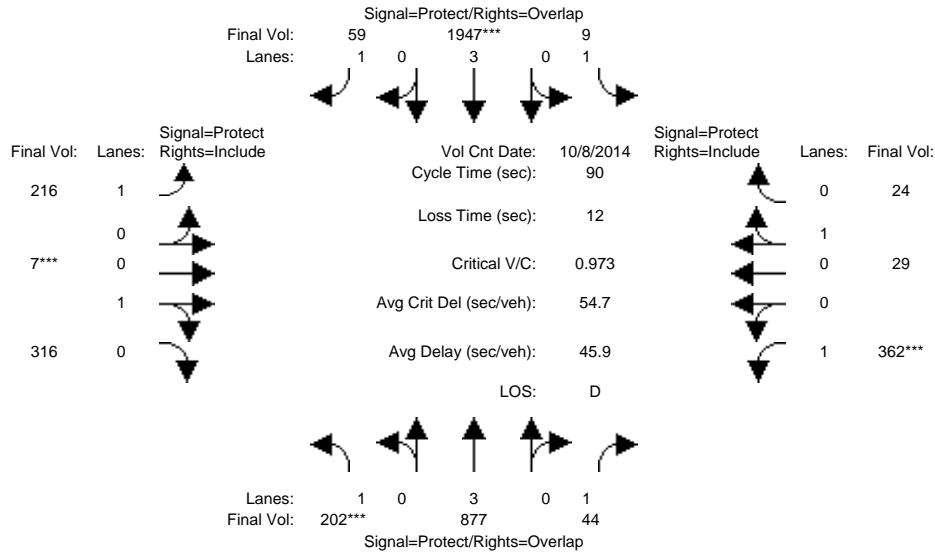

Approach:	North Bound			South Bound			East Bound			West Bound		
	L	T	R	L	T	R	L	T	R	L	T	R
Min. Green:	7	10	10	7	10	10	7	10	10	7	10	10
Y+R:	4.0	4.0	4.0	4.0	4.0	4.0	4.0	4.0	4.0	4.0	4.0	4.0
Volume Module: >> Count Date: 8 Oct 2014 <<												
Base Vol:	202	877	44	9	1947	59	216	7	316	362	29	24
Growth Adj:	1.00	1.00	1.00	1.00	1.00	1.00	1.00	1.00	1.00	1.00	1.00	1.00
Initial Bse:	202	877	44	9	1947	59	216	7	316	362	29	24
Added Vol:	0	0	0	0	0	0	0	0	0	0	0	0
PasserByVol:	0	0	0	0	0	0	0	0	0	0	0	0
Initial Fut:	202	877	44	9	1947	59	216	7	316	362	29	24
User Adj:	1.00	1.00	1.00	1.00	1.00	1.00	1.00	1.00	1.00	1.00	1.00	1.00
PHF Adj:	1.00	1.00	1.00	1.00	1.00	1.00	1.00	1.00	1.00	1.00	1.00	1.00
PHF Volume:	202	877	44	9	1947	59	216	7	316	362	29	24
Reduct Vol:	0	0	0	0	0	0	0	0	0	0	0	0
Reduced Vol:	202	877	44	9	1947	59	216	7	316	362	29	24
PCE Adj:	1.00	1.00	1.00	1.00	1.00	1.00	1.00	1.00	1.00	1.00	1.00	1.00
MLF Adj:	1.00	1.00	1.00	1.00	1.00	1.00	1.00	1.00	1.00	1.00	1.00	1.00
FinalVolume:	202	877	44	9	1947	59	216	7	316	362	29	24
Saturation Flow Module:												
Sat/Lane:	1900	1900	1900	1900	1900	1900	1900	1900	1900	1900	1900	1900
Adjustment:	0.92	1.00	0.92	0.92	1.00	0.92	0.92	0.95	0.95	0.92	0.95	0.95
Lanes:	1.00	3.00	1.00	1.00	3.00	1.00	1.00	0.02	0.98	1.00	0.55	0.45
Final Sat.:	1750	5700	1750	1750	5700	1750	1750	39	1761	1750	985	815
Capacity Analysis Module:												
Vol/Sat:	0.12	0.15	0.03	0.01	0.34	0.03	0.12	0.18	0.18	0.21	0.03	0.03
Crit Moves:	****				****			****			****	
Green Time:	10.7	28.1	47.2	14.2	31.6	50.4	18.8	16.6	16.6	19.1	16.9	16.9
Volume/Cap:	0.97	0.49	0.05	0.03	0.97	0.06	0.59	0.97	0.97	0.97	0.16	0.16
Delay/Veh:	94.0	25.4	10.5	32.1	43.1	9.0	34.7	78.5	78.5	74.5	30.8	30.8
User DelAdj:	1.00	1.00	1.00	1.00	1.00	1.00	1.00	1.00	1.00	1.00	1.00	1.00
AdjDel/Veh:	94.0	25.4	10.5	32.1	43.1	9.0	34.7	78.5	78.5	74.5	30.8	30.8
LOS by Move:	F	C	B	C	D	A	C	E	E	E	C	C
HCM2k95thQ:	15	12	1	0	36	2	13	26	26	24	3	3

Note: Queue reported is the number of cars per lane.

BART Phase II Extension Project

Level Of Service Computation Report
2000 HCM Operations (Future Volume Alternative)
AM - 2025 No Project Conditions

Intersection #106: Benton/EI Camino Real

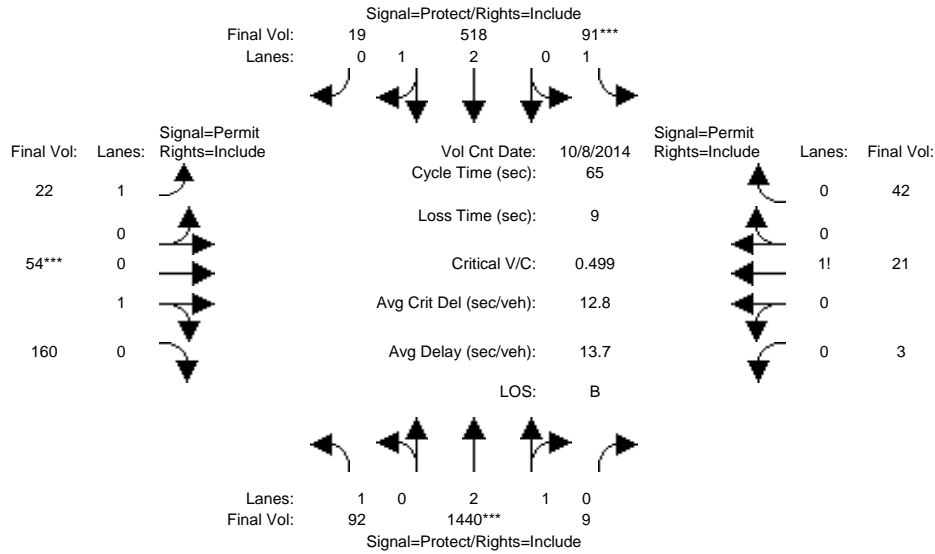

Approach:	North Bound			South Bound			East Bound			West Bound		
	L	T	R	L	T	R	L	T	R	L	T	R
Min. Green:	7	10	10	7	10	10	10	10	10	10	10	10
Y+R:	4.0	4.0	4.0	4.0	4.0	4.0	4.0	4.0	4.0	4.0	4.0	4.0
Volume Module: >> Count Date: 8 Oct 2014 <<												
Base Vol:	92	1440	9	91	518	19	22	54	160	3	21	42
Growth Adj:	1.00	1.00	1.00	1.00	1.00	1.00	1.00	1.00	1.00	1.00	1.00	1.00
Initial Bse:	92	1440	9	91	518	19	22	54	160	3	21	42
Added Vol:	0	0	0	0	0	0	0	0	0	0	0	0
PasserByVol:	0	0	0	0	0	0	0	0	0	0	0	0
Initial Fut:	92	1440	9	91	518	19	22	54	160	3	21	42
User Adj:	1.00	1.00	1.00	1.00	1.00	1.00	1.00	1.00	1.00	1.00	1.00	1.00
PHF Adj:	1.00	1.00	1.00	1.00	1.00	1.00	1.00	1.00	1.00	1.00	1.00	1.00
PHF Volume:	92	1440	9	91	518	19	22	54	160	3	21	42
Reduct Vol:	0	0	0	0	0	0	0	0	0	0	0	0
Reduced Vol:	92	1440	9	91	518	19	22	54	160	3	21	42
PCE Adj:	1.00	1.00	1.00	1.00	1.00	1.00	1.00	1.00	1.00	1.00	1.00	1.00
MLF Adj:	1.00	1.00	1.00	1.00	1.00	1.00	1.00	1.00	1.00	1.00	1.00	1.00
FinalVolume:	92	1440	9	91	518	19	22	54	160	3	21	42
Saturation Flow Module:												
Sat/Lane:	1900	1900	1900	1900	1900	1900	1900	1900	1900	1900	1900	1900
Adjustment:	0.92	0.98	0.95	0.92	0.98	0.95	0.92	0.95	0.95	0.92	0.92	0.92
Lanes:	1.00	2.98	0.02	1.00	2.89	0.11	1.00	0.25	0.75	0.04	0.32	0.64
Final Sat.:	1750	5565	35	1750	5402	198	1750	454	1346	80	557	1114
Capacity Analysis Module:												
Vol/Sat:	0.05	0.26	0.26	0.05	0.10	0.10	0.01	0.12	0.12	0.04	0.04	0.04
Crit Moves:	****			****			****					
Green Time:	16.7	33.6	33.6	7.0	23.9	23.9	15.4	15.4	15.4	15.4	15.4	15.4
Volume/Cap:	0.20	0.50	0.50	0.48	0.26	0.26	0.05	0.50	0.50	0.16	0.16	0.16
Delay/Veh:	19.2	10.4	10.4	29.2	14.5	14.5	19.2	22.4	22.4	19.8	19.8	19.8
User DelAdj:	1.00	1.00	1.00	1.00	1.00	1.00	1.00	1.00	1.00	1.00	1.00	1.00
AdjDel/Veh:	19.2	10.4	10.4	29.2	14.5	14.5	19.2	22.4	22.4	19.8	19.8	19.8
LOS by Move:	B	B	B	C	B	B	B	C	C	B	B	B
HCM2k95thQ:	3	12	12	4	5	5	1	8	8	3	3	3

Note: Queue reported is the number of cars per lane.

BART Phase II Extension Project

Level Of Service Computation Report
2000 HCM Operations (Future Volume Alternative)
PM - 2025 No Project Conditions

Intersection #106: Benton/EI Camino Real

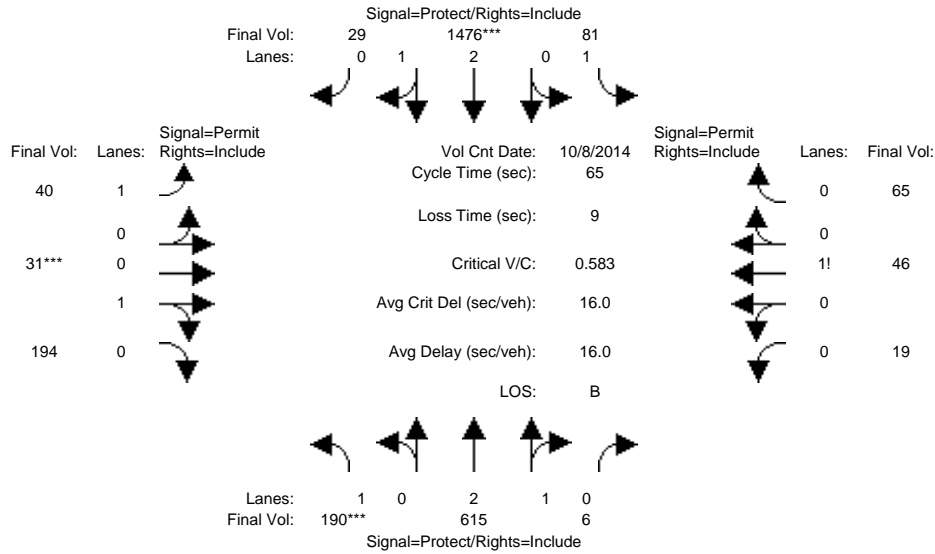

Approach:	North Bound			South Bound			East Bound			West Bound		
	L	T	R	L	T	R	L	T	R	L	T	R
Min. Green:	7	10	10	7	10	10	10	10	10	10	10	10
Y+R:	4.0	4.0	4.0	4.0	4.0	4.0	4.0	4.0	4.0	4.0	4.0	4.0
Volume Module: >> Count Date: 8 Oct 2014 <<												
Base Vol:	190	615	6	81	1476	29	40	31	194	19	46	65
Growth Adj:	1.00	1.00	1.00	1.00	1.00	1.00	1.00	1.00	1.00	1.00	1.00	1.00
Initial Bse:	190	615	6	81	1476	29	40	31	194	19	46	65
Added Vol:	0	0	0	0	0	0	0	0	0	0	0	0
PasserByVol:	0	0	0	0	0	0	0	0	0	0	0	0
Initial Fut:	190	615	6	81	1476	29	40	31	194	19	46	65
User Adj:	1.00	1.00	1.00	1.00	1.00	1.00	1.00	1.00	1.00	1.00	1.00	1.00
PHF Adj:	1.00	1.00	1.00	1.00	1.00	1.00	1.00	1.00	1.00	1.00	1.00	1.00
PHF Volume:	190	615	6	81	1476	29	40	31	194	19	46	65
Reduct Vol:	0	0	0	0	0	0	0	0	0	0	0	0
Reduced Vol:	190	615	6	81	1476	29	40	31	194	19	46	65
PCE Adj:	1.00	1.00	1.00	1.00	1.00	1.00	1.00	1.00	1.00	1.00	1.00	1.00
MLF Adj:	1.00	1.00	1.00	1.00	1.00	1.00	1.00	1.00	1.00	1.00	1.00	1.00
FinalVolume:	190	615	6	81	1476	29	40	31	194	19	46	65
Saturation Flow Module:												
Sat/Lane:	1900	1900	1900	1900	1900	1900	1900	1900	1900	1900	1900	1900
Adjustment:	0.92	0.98	0.95	0.92	0.98	0.95	0.92	0.95	0.95	0.92	0.92	0.92
Lanes:	1.00	2.97	0.03	1.00	2.94	0.06	1.00	0.14	0.86	0.15	0.35	0.50
Final Sat.:	1750	5546	54	1750	5492	108	1750	248	1552	256	619	875
Capacity Analysis Module:												
Vol/Sat:	0.11	0.11	0.11	0.05	0.27	0.27	0.02	0.13	0.13	0.07	0.07	0.07
Crit Moves:	****			****			****					
Green Time:	12.1	24.7	24.7	17.3	30.0	30.0	13.9	13.9	13.9	13.9	13.9	13.9
Volume/Cap:	0.58	0.29	0.29	0.17	0.58	0.58	0.11	0.58	0.58	0.35	0.35	0.35
Delay/Veh:	26.8	14.1	14.1	18.5	13.3	13.3	20.7	25.2	25.2	22.2	22.2	22.2
User DelAdj:	1.00	1.00	1.00	1.00	1.00	1.00	1.00	1.00	1.00	1.00	1.00	1.00
AdjDel/Veh:	26.8	14.1	14.1	18.5	13.3	13.3	20.7	25.2	25.2	22.2	22.2	22.2
LOS by Move:	C	B	B	B	B	B	C	C	C	C	C	C
HCM2k95thQ:	8	6	6	3	14	14	1	8	8	5	5	5

Note: Queue reported is the number of cars per lane.

BART Phase II Extension Project

Level Of Service Computation Report
2000 HCM Operations (Future Volume Alternative)
AM - 2025 No Project Conditions

Intersection #107: Benton/Lafayette

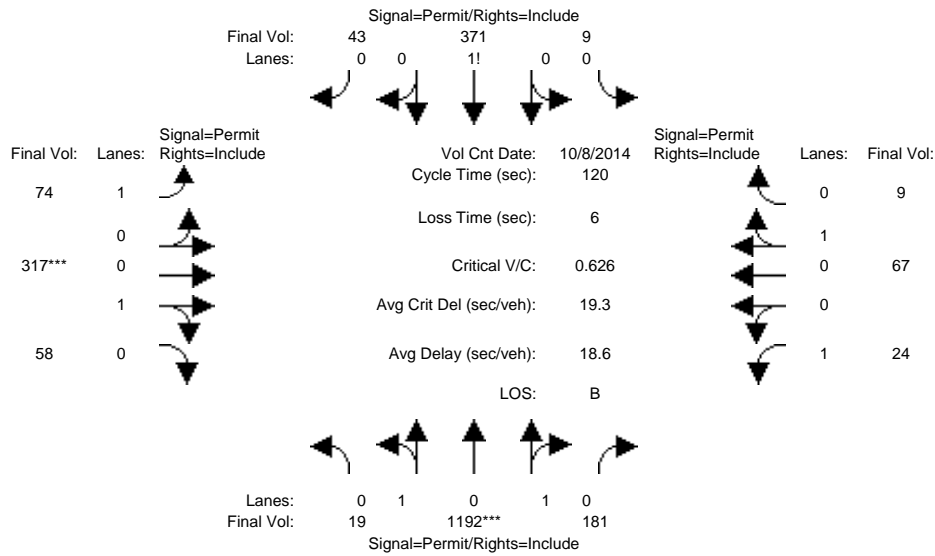

Approach:	North Bound			South Bound			East Bound			West Bound		
	L	T	R	L	T	R	L	T	R	L	T	R
Min. Green:	10	10	10	10	10	10	10	10	10	10	10	10
Y+R:	4.0	4.0	4.0	4.0	4.0	4.0	4.0	4.0	4.0	4.0	4.0	4.0
Volume Module: >> Count Date: 8 Oct 2014 <<												
Base Vol:	19	1192	181	9	371	43	74	317	58	24	67	9
Growth Adj:	1.00	1.00	1.00	1.00	1.00	1.00	1.00	1.00	1.00	1.00	1.00	1.00
Initial Bse:	19	1192	181	9	371	43	74	317	58	24	67	9
Added Vol:	0	0	0	0	0	0	0	0	0	0	0	0
PasserByVol:	0	0	0	0	0	0	0	0	0	0	0	0
Initial Fut:	19	1192	181	9	371	43	74	317	58	24	67	9
User Adj:	1.00	1.00	1.00	1.00	1.00	1.00	1.00	1.00	1.00	1.00	1.00	1.00
PHF Adj:	1.00	1.00	1.00	1.00	1.00	1.00	1.00	1.00	1.00	1.00	1.00	1.00
PHF Volume:	19	1192	181	9	371	43	74	317	58	24	67	9
Reduct Vol:	0	0	0	0	0	0	0	0	0	0	0	0
Reduced Vol:	19	1192	181	9	371	43	74	317	58	24	67	9
PCE Adj:	1.00	1.00	1.00	1.00	1.00	1.00	1.00	1.00	1.00	1.00	1.00	1.00
MLF Adj:	1.00	1.00	1.00	1.00	1.00	1.00	1.00	1.00	1.00	1.00	1.00	1.00
Final Volume:	19	1192	181	9	371	43	74	317	58	24	67	9
Saturation Flow Module:												
Sat/Lane:	1900	1900	1900	1900	1900	1900	1900	1900	1900	1900	1900	1900
Adjustment:	0.95	0.95	0.95	0.92	0.92	0.92	0.92	0.95	0.95	0.92	0.95	0.95
Lanes:	0.03	1.71	0.26	0.02	0.88	0.10	1.00	0.85	0.15	1.00	0.88	0.12
Final Sat.:	49	3083	468	37	1535	178	1750	1522	278	1750	1587	213
Capacity Analysis Module:												
Vol/Sat:	0.39	0.39	0.39	0.24	0.24	0.24	0.04	0.21	0.21	0.01	0.04	0.04
Crit Moves:	****									****		
Green Time:	74.1	74.1	74.1	74.1	74.1	74.1	39.9	39.9	39.9	39.9	39.9	39.9
Volume/Cap:	0.63	0.63	0.63	0.39	0.39	0.39	0.13	0.63	0.63	0.04	0.13	0.13
Delay/Veh:	14.9	14.9	14.9	11.8	11.8	11.8	28.0	35.9	35.9	27.1	28.0	28.0
User DelAdj:	1.00	1.00	1.00	1.00	1.00	1.00	1.00	1.00	1.00	1.00	1.00	1.00
AdjDel/Veh:	14.9	14.9	14.9	11.8	11.8	11.8	28.0	35.9	35.9	27.1	28.0	28.0
LOS by Move:	B	B	B	B	B	B	C	D	D	C	C	C
HCM2k95thQ:	28	28	28	16	16	16	4	22	22	1	4	4

Note: Queue reported is the number of cars per lane.

BART Phase II Extension Project

Level Of Service Computation Report
2000 HCM Operations (Future Volume Alternative)
PM - 2025 No Project Conditions

Intersection #107: Benton/Lafayette

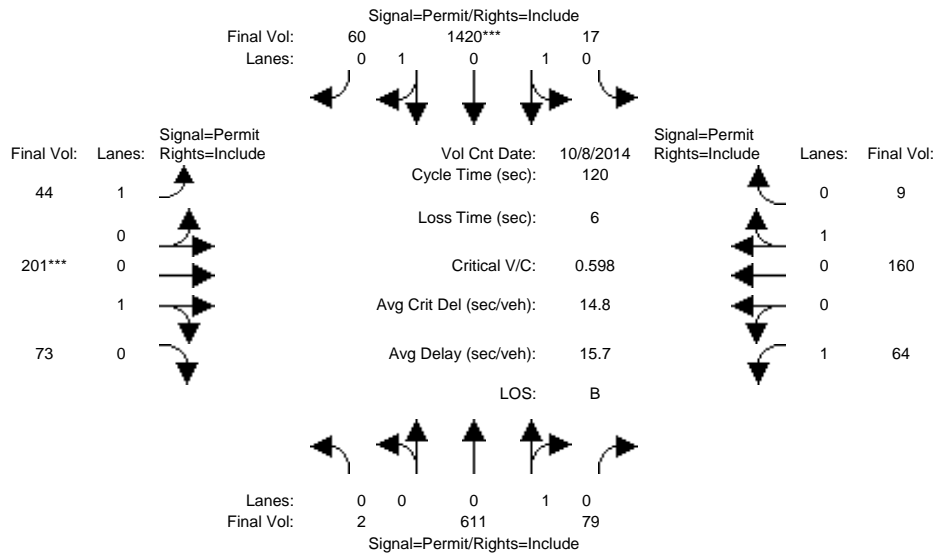

Approach:	North Bound			South Bound			East Bound			West Bound		
	L	T	R	L	T	R	L	T	R	L	T	R
Min. Green:	10	10	10	10	10	10	10	10	10	10	10	10
Y+R:	4.0	4.0	4.0	4.0	4.0	4.0	4.0	4.0	4.0	4.0	4.0	4.0

Volume Module:	>>	Count	Date:	8 Oct 2014	<<											
Base Vol:	2	611	79	17	1420	60	44	201	73	64	160	9				
Growth Adj:	1.00	1.00	1.00	1.00	1.00	1.00	1.00	1.00	1.00	1.00	1.00	1.00				
Initial Bse:	2	611	79	17	1420	60	44	201	73	64	160	9				
Added Vol:	0	0	0	0	0	0	0	0	0	0	0	0				
PasserByVol:	0	0	0	0	0	0	0	0	0	0	0	0				
Initial Fut:	2	611	79	17	1420	60	44	201	73	64	160	9				
User Adj:	1.00	1.00	1.00	1.00	1.00	1.00	1.00	1.00	1.00	1.00	1.00	1.00				
PHF Adj:	1.00	1.00	1.00	1.00	1.00	1.00	1.00	1.00	1.00	1.00	1.00	1.00				
PHF Volume:	2	611	79	17	1420	60	44	201	73	64	160	9				
Reduct Vol:	0	0	0	0	0	0	0	0	0	0	0	0				
Reduced Vol:	2	611	79	17	1420	60	44	201	73	64	160	9				
PCE Adj:	1.00	1.00	1.00	1.00	1.00	1.00	1.00	1.00	1.00	1.00	1.00	1.00				
MLF Adj:	1.00	1.00	1.00	1.00	1.00	1.00	1.00	1.00	1.00	1.00	1.00	1.00				
FinalVolume:	2	611	79	17	1420	60	44	201	73	64	160	9				

Saturation Flow Module:												
Sat/Lane:	1900	1900	1900	1900	1900	1900	1900	1900	1900	1900	1900	1900
Adjustment:	0.92	0.92	0.92	0.95	0.95	0.95	0.92	0.95	0.95	0.92	0.95	0.95
Lanes:	0.01	0.88	0.11	0.02	1.90	0.08	1.00	0.73	0.27	1.00	0.95	0.05
Final Sat.:	5	1545	200	41	3415	144	1750	1320	480	1750	1704	96

Capacity Analysis Module:												
Vol/Sat:	0.40	0.40	0.40	0.42	0.42	0.42	0.03	0.15	0.15	0.04	0.09	0.09
Crit Moves:	****						****					
Green Time:	83.5	83.5	83.5	83.5	83.5	83.5	30.5	30.5	30.5	30.5	30.5	30.5
Volume/Cap:	0.57	0.57	0.57	0.60	0.60	0.60	0.10	0.60	0.60	0.14	0.37	0.37
Delay/Veh:	9.8	9.8	9.8	9.9	9.9	9.9	34.3	41.5	41.5	34.8	37.3	37.3
User DelAdj:	1.00	1.00	1.00	1.00	1.00	1.00	1.00	1.00	1.00	1.00	1.00	1.00
AdjDel/Veh:	9.8	9.8	9.8	9.9	9.9	9.9	34.3	41.5	41.5	34.8	37.3	37.3
LOS by Move:	A	A	A	A	A	A	C	D	D	C	D	D
HCM2k95thQ:	24	24	24	25	25	25	3	17	17	4	11	11

Note: Queue reported is the number of cars per lane.

BART Phase II Extension Project

Level Of Service Computation Report
 2000 HCM Operations (Future Volume Alternative)
 AM - 2025 No Project Conditions

Intersection #175: Reed/De La Cruz

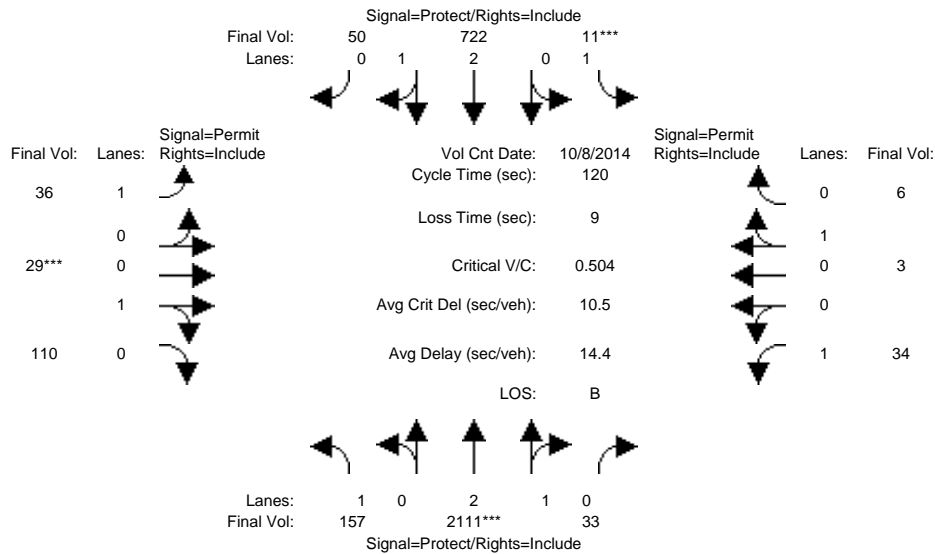

Approach:	North Bound			South Bound			East Bound			West Bound		
	L	T	R	L	T	R	L	T	R	L	T	R
Min. Green:	7	10	10	7	10	10	10	10	10	10	10	10
Y+R:	4.0	4.0	4.0	4.0	4.0	4.0	4.0	4.0	4.0	4.0	4.0	4.0
Volume Module: >> Count Date: 8 Oct 2014 <<												
Base Vol:	157	2111	33	11	722	50	36	29	110	34	3	6
Growth Adj:	1.00	1.00	1.00	1.00	1.00	1.00	1.00	1.00	1.00	1.00	1.00	1.00
Initial Bse:	157	2111	33	11	722	50	36	29	110	34	3	6
Added Vol:	0	0	0	0	0	0	0	0	0	0	0	0
PasserByVol:	0	0	0	0	0	0	0	0	0	0	0	0
Initial Fut:	157	2111	33	11	722	50	36	29	110	34	3	6
User Adj:	1.00	1.00	1.00	1.00	1.00	1.00	1.00	1.00	1.00	1.00	1.00	1.00
PHF Adj:	1.00	1.00	1.00	1.00	1.00	1.00	1.00	1.00	1.00	1.00	1.00	1.00
PHF Volume:	157	2111	33	11	722	50	36	29	110	34	3	6
Reduct Vol:	0	0	0	0	0	0	0	0	0	0	0	0
Reduced Vol:	157	2111	33	11	722	50	36	29	110	34	3	6
PCE Adj:	1.00	1.00	1.00	1.00	1.00	1.00	1.00	1.00	1.00	1.00	1.00	1.00
MLF Adj:	1.00	1.00	1.00	1.00	1.00	1.00	1.00	1.00	1.00	1.00	1.00	1.00
Final Volume:	157	2111	33	11	722	50	36	29	110	34	3	6
Saturation Flow Module:												
Sat/Lane:	1900	1900	1900	1900	1900	1900	1900	1900	1900	1900	1900	1900
Adjustment:	0.92	0.98	0.95	0.92	0.98	0.95	0.92	0.95	0.95	0.92	0.95	0.95
Lanes:	1.00	2.95	0.05	1.00	2.80	0.20	1.00	0.21	0.79	1.00	0.33	0.67
Final Sat.:	1750	5514	86	1750	5237	363	1750	376	1424	1750	600	1200
Capacity Analysis Module:												
Vol/Sat:	0.09	0.38	0.38	0.01	0.14	0.14	0.02	0.08	0.08	0.02	0.01	0.01
Crit Moves:	****			****			****					
Green Time:	36.9	86.5	86.5	7.0	56.7	56.7	17.5	17.5	17.5	17.5	17.5	17.5
Volume/Cap:	0.29	0.53	0.53	0.11	0.29	0.29	0.14	0.53	0.53	0.13	0.03	0.03
Delay/Veh:	31.9	7.7	7.7	54.0	19.4	19.4	45.0	49.6	49.6	44.9	44.1	44.1
User DelAdj:	1.00	1.00	1.00	1.00	1.00	1.00	1.00	1.00	1.00	1.00	1.00	1.00
AdjDel/Veh:	31.9	7.7	7.7	54.0	19.4	19.4	45.0	49.6	49.6	44.9	44.1	44.1
LOS by Move:	C	A	A	D	B	B	D	D	D	D	D	D
HCM2k95thQ:	9	22	22	1	11	11	2	10	10	3	1	1

Note: Queue reported is the number of cars per lane.

BART Phase II Extension Project

Level Of Service Computation Report
 2000 HCM Operations (Future Volume Alternative)
 PM - 2025 No Project Conditions

Intersection #175: Reed/De La Cruz

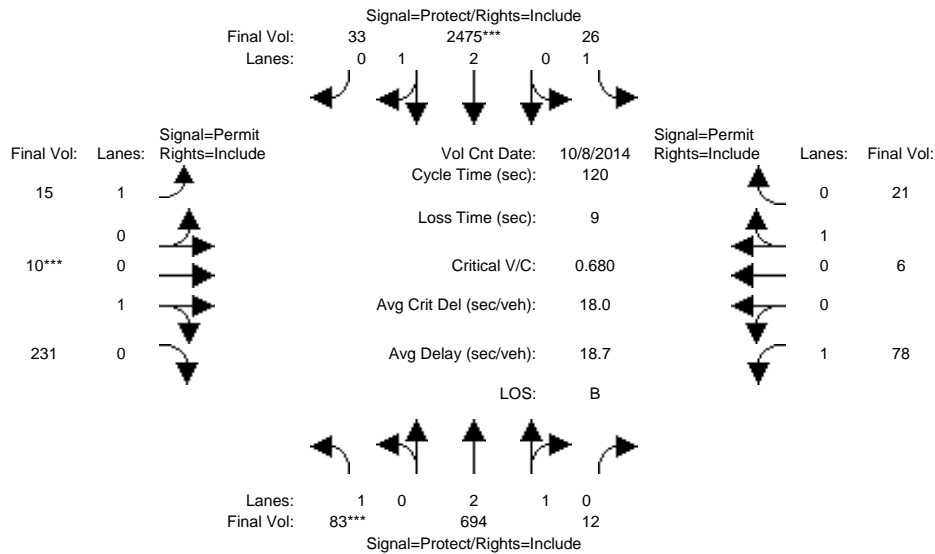

Approach:	North Bound			South Bound			East Bound			West Bound		
	L	T	R	L	T	R	L	T	R	L	T	R
Min. Green:	7	10	10	7	10	10	10	10	10	10	10	10
Y+R:	4.0	4.0	4.0	4.0	4.0	4.0	4.0	4.0	4.0	4.0	4.0	4.0
Volume Module: >> Count Date: 8 Oct 2014 <<												
Base Vol:	83	694	12	26	2475	33	15	10	231	78	6	21
Growth Adj:	1.00	1.00	1.00	1.00	1.00	1.00	1.00	1.00	1.00	1.00	1.00	1.00
Initial Bse:	83	694	12	26	2475	33	15	10	231	78	6	21
Added Vol:	0	0	0	0	0	0	0	0	0	0	0	0
PasserByVol:	0	0	0	0	0	0	0	0	0	0	0	0
Initial Fut:	83	694	12	26	2475	33	15	10	231	78	6	21
User Adj:	1.00	1.00	1.00	1.00	1.00	1.00	1.00	1.00	1.00	1.00	1.00	1.00
PHF Adj:	1.00	1.00	1.00	1.00	1.00	1.00	1.00	1.00	1.00	1.00	1.00	1.00
PHF Volume:	83	694	12	26	2475	33	15	10	231	78	6	21
Reduct Vol:	0	0	0	0	0	0	0	0	0	0	0	0
Reduced Vol:	83	694	12	26	2475	33	15	10	231	78	6	21
PCE Adj:	1.00	1.00	1.00	1.00	1.00	1.00	1.00	1.00	1.00	1.00	1.00	1.00
MLF Adj:	1.00	1.00	1.00	1.00	1.00	1.00	1.00	1.00	1.00	1.00	1.00	1.00
FinalVolume:	83	694	12	26	2475	33	15	10	231	78	6	21
Saturation Flow Module:												
Sat/Lane:	1900	1900	1900	1900	1900	1900	1900	1900	1900	1900	1900	1900
Adjustment:	0.92	0.98	0.95	0.92	0.98	0.95	0.92	0.95	0.95	0.92	0.95	0.95
Lanes:	1.00	2.95	0.05	1.00	2.96	0.04	1.00	0.04	0.96	1.00	0.22	0.78
Final Sat.:	1750	5505	95	1750	5526	74	1750	75	1725	1750	400	1400
Capacity Analysis Module:												
Vol/Sat:	0.05	0.13	0.13	0.01	0.45	0.45	0.01	0.13	0.13	0.04	0.02	0.02
Crit Moves:	****			****			****					
Green Time:	8.4	59.7	59.7	27.6	79.0	79.0	23.6	23.6	23.6	23.6	23.6	23.6
Volume/Cap:	0.68	0.25	0.25	0.06	0.68	0.68	0.04	0.68	0.68	0.23	0.08	0.08
Delay/Veh:	69.0	17.4	17.4	36.1	13.2	13.2	39.1	50.0	50.0	40.8	39.4	39.4
User DelAdj:	1.00	1.00	1.00	1.00	1.00	1.00	1.00	1.00	1.00	1.00	1.00	1.00
AdjDel/Veh:	69.0	17.4	17.4	36.1	13.2	13.2	39.1	50.0	50.0	40.8	39.4	39.4
LOS by Move:	E	B	B	D	B	B	D	D	D	D	D	D
HCM2k95thQ:	9	10	10	2	33	33	1	16	16	5	2	2

Note: Queue reported is the number of cars per lane.

BART Phase II Extension Project

Level Of Service Computation Report
2000 HCM Unsignalized (Future Volume Alternative)
AM - 2025 No Project Conditions

Intersection #1008: Lafayette/Harrison

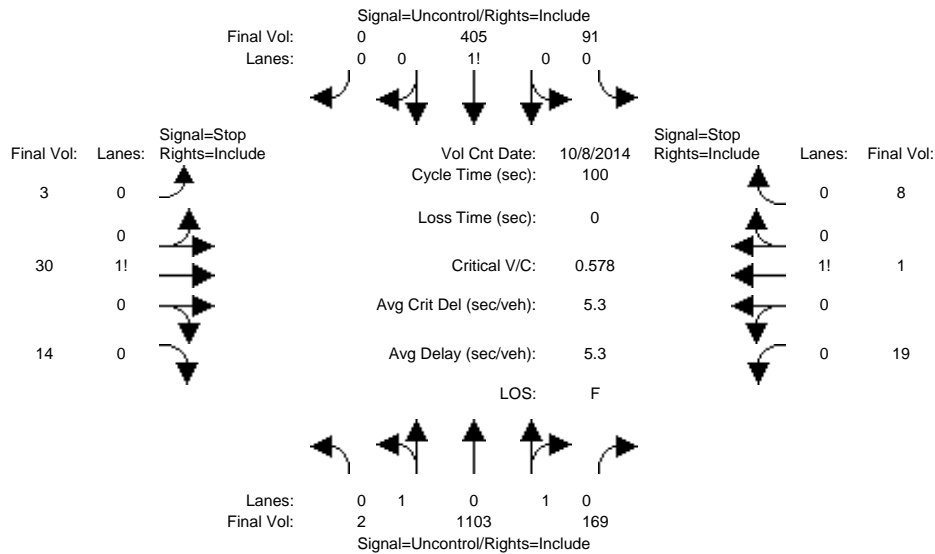

Approach:	North Bound			South Bound			East Bound			West Bound		
Movement:	L	T	R	L	T	R	L	T	R	L	T	R
Volume Module: >> Count Date: 8 Oct 2014 <<												
Base Vol:	2	1103	169	91	405	0	3	30	14	19	1	8
Growth Adj:	1.00	1.00	1.00	1.00	1.00	1.00	1.00	1.00	1.00	1.00	1.00	1.00
Initial Bse:	2	1103	169	91	405	0	3	30	14	19	1	8
Added Vol:	0	0	0	0	0	0	0	0	0	0	0	0
PasserByVol:	0	0	0	0	0	0	0	0	0	0	0	0
Initial Fut:	2	1103	169	91	405	0	3	30	14	19	1	8
User Adj:	1.00	1.00	1.00	1.00	1.00	1.00	1.00	1.00	1.00	1.00	1.00	1.00
PHF Adj:	1.00	1.00	1.00	1.00	1.00	1.00	1.00	1.00	1.00	1.00	1.00	1.00
PHF Volume:	2	1103	169	91	405	0	3	30	14	19	1	8
Reduct Vol:	0	0	0	0	0	0	0	0	0	0	0	0
FinalVolume:	2	1103	169	91	405	0	3	30	14	19	1	8
Critical Gap Module:												
Critical Gp:	4.1	xxxx	xxxxxx	4.1	xxxx	xxxxxx	7.1	6.5	6.2	7.1	6.5	6.2
FollowUpTim:	2.2	xxxx	xxxxxx	2.2	xxxx	xxxxxx	3.5	4.0	3.3	3.5	4.0	3.3
Capacity Module:												
Cnflct Vol:	405	xxxx	xxxxxx	1272	xxxx	xxxxxx	1143	1863	405	1801	1779	636
Potent Cap.:	1165	xxxx	xxxxxx	553	xxxx	xxxxxx	179	74	650	63	83	481
Move Cap.:	1165	xxxx	xxxxxx	553	xxxx	xxxxxx	151	61	650	33	69	481
Volume/Cap:	0.00	xxxx	xxxx	0.16	xxxx	xxxx	0.02	0.49	0.02	0.58	0.01	0.02
Level Of Service Module:												
2Way95thQ:	0.0	xxxx	xxxxxx	0.6	xxxx	xxxxxx	xxxx	xxxx	xxxxxx	xxxx	xxxx	xxxxxx
Control Del:	8.1	xxxx	xxxxxx	12.8	xxxx	xxxxxx	xxxxxx	xxxx	xxxxxx	xxxxxx	xxxx	xxxxxx
LOS by Move:	A	*	*	B	*	*	*	*	*	*	*	*
Movement:	LT - LTR - RT	LT - LTR - RT	LT - LTR - RT	LT - LTR - RT	LT - LTR - RT	LT - LTR - RT	LT - LTR - RT	LT - LTR - RT	LT - LTR - RT	LT - LTR - RT	LT - LTR - RT	
Shared Cap.:	xxxx	xxxx	xxxxxx	xxxx	xxxx	xxxxxx	xxxx	88	xxxxxx	xxxx	46	xxxxxx
SharedQueue:	0.0	xxxx	xxxxxx	0.6	xxxx	xxxxxx	xxxxxx	2.4	xxxxxx	xxxxxx	2.3	xxxxxx
Shrd ConDel:	8.1	xxxx	xxxxxx	12.8	xxxx	xxxxxx	xxxxxx	85.4	xxxxxx	xxxxxx	166	xxxxxx
Shared LOS:	A	*	*	B	*	*	*	F	*	*	F	*
ApproachDel:	xxxxxxx	xxxxxxx	xxxxxxx	xxxxxxx	xxxxxxx	xxxxxxx	85.4	xxxxxxx	xxxxxxx	166.1	xxxxxxx	
ApproachLOS:	*	*	*	*	*	*	F	*	*	F	*	

Note: Queue reported is the number of cars per lane.

BART Phase II Extension Project

Level Of Service Computation Report
 2000 HCM Unsignalized (Future Volume Alternative)
 PM - 2025 No Project Conditions

Intersection #1008: Lafayette/Harrison

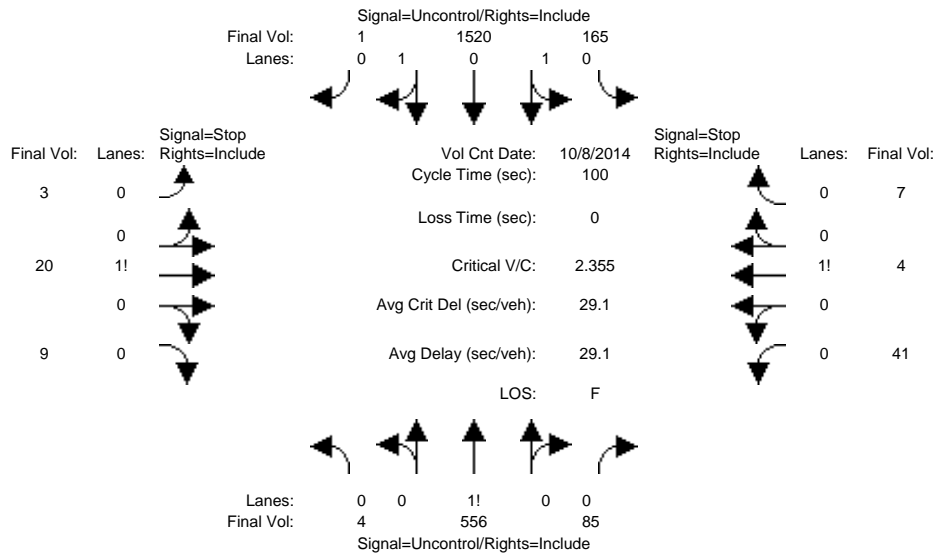

Approach:	North Bound			South Bound			East Bound			West Bound		
Movement:	L	T	R	L	T	R	L	T	R	L	T	R
Volume Module: >> Count Date: 8 Oct 2014 <<												
Base Vol:	4	556	85	165	1520	1	3	20	9	41	4	7
Growth Adj:	1.00	1.00	1.00	1.00	1.00	1.00	1.00	1.00	1.00	1.00	1.00	1.00
Initial Bse:	4	556	85	165	1520	1	3	20	9	41	4	7
Added Vol:	0	0	0	0	0	0	0	0	0	0	0	0
PasserByVol:	0	0	0	0	0	0	0	0	0	0	0	0
Initial Fut:	4	556	85	165	1520	1	3	20	9	41	4	7
User Adj:	1.00	1.00	1.00	1.00	1.00	1.00	1.00	1.00	1.00	1.00	1.00	1.00
PHF Adj:	1.00	1.00	1.00	1.00	1.00	1.00	1.00	1.00	1.00	1.00	1.00	1.00
PHF Volume:	4	556	85	165	1520	1	3	20	9	41	4	7
Reduct Vol:	0	0	0	0	0	0	0	0	0	0	0	0
FinalVolume:	4	556	85	165	1520	1	3	20	9	41	4	7
Critical Gap Module:												
Critical Gp:	4.1	xxxx	xxxxxx	4.1	xxxx	xxxxxx	7.1	6.5	6.2	7.1	6.5	6.2
FollowUpTim:	2.2	xxxx	xxxxxx	2.2	xxxx	xxxxxx	3.5	4.0	3.3	3.5	4.0	3.3
Capacity Module:												
Cnflct Vol:	1521	xxxx	xxxxxx	641	xxxx	xxxxxx	2463	2500	761	1707	2458	599
Potent Cap.:	445	xxxx	xxxxxx	953	xxxx	xxxxxx	21	29	409	73	31	506
Move Cap.:	445	xxxx	xxxxxx	953	xxxx	xxxxxx	16	23	409	17	25	506
Volume/Cap:	0.01	xxxx	xxxx	0.17	xxxx	xxxx	0.19	0.85	0.02	2.35	0.16	0.01
Level Of Service Module:												
2Way95thQ:	0.0	xxxx	xxxxxx	0.6	xxxx	xxxxxx	xxxx	xxxx	xxxxxx	xxxx	xxxx	xxxxxx
Control Del:	13.2	xxxx	xxxxxx	9.6	xxxx	xxxxxx	xxxxxx	xxxx	xxxxxx	xxxxxx	xxxx	xxxxxx
LOS by Move:	B	*	*	A	*	*	*	*	*	*	*	*
Movement:	LT	LTR	RT	LT	LTR	RT	LT	LTR	RT	LT	LTR	RT
Shared Cap.:	xxxx	xxxx	xxxxxx	xxxx	xxxx	xxxxxx	xxxx	30	xxxxxx	xxxx	21	xxxxxx
SharedQueue:	xxxxxx	xxxx	xxxxxx	0.6	xxxx	xxxxxx	xxxxxx	3.6	xxxxxx	xxxxxx	6.8	xxxxxx
Shrd ConDel:	xxxxxx	xxxx	xxxxxx	9.6	xxxx	xxxxxx	xxxxxx	382	xxxxxx	xxxxxx	1088	xxxxxx
Shared LOS:	*	*	*	A	*	*	*	F	*	*	F	*
ApproachDel:	xxxxxxx			xxxxxxx			381.6			1087.5		
ApproachLOS:	*			*			F			F		

Note: Queue reported is the number of cars per lane.

BART Phase II Extension Project

Level Of Service Computation Report
2000 HCM Operations (Future Volume Alternative)
AM - 2025 No Project Conditions

Intersection #1012: El Camino Real/Railroad Ave

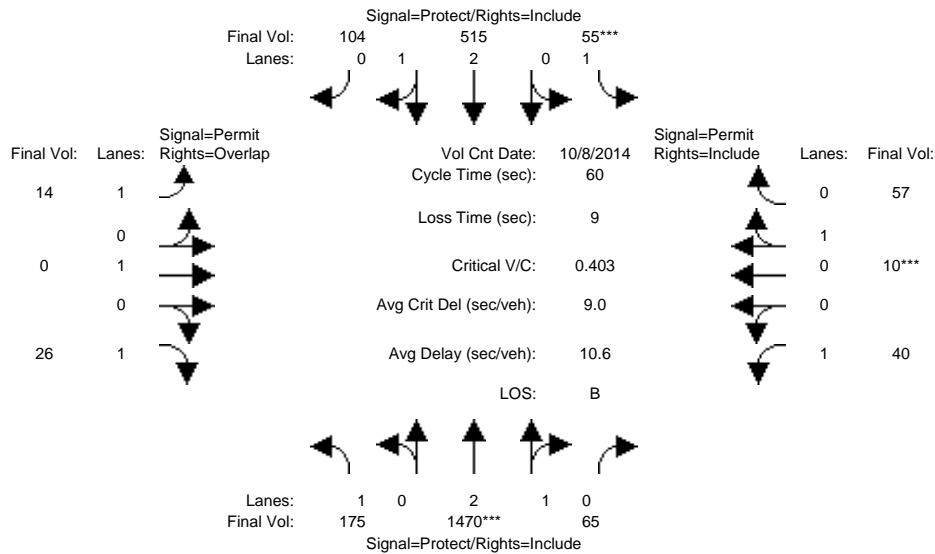

Approach:	North Bound			South Bound			East Bound			West Bound		
Movement:	L	T	R	L	T	R	L	T	R	L	T	R
Min. Green:	7	10	10	7	10	10	10	10	10	10	10	10
Y+R:	4.0	4.0	4.0	4.0	4.0	4.0	4.0	4.0	4.0	4.0	4.0	4.0
Volume Module: >> Count Date: 8 Oct 2014 <<												
Base Vol:	175	1470	65	55	515	104	14	0	26	40	10	57
Growth Adj:	1.00	1.00	1.00	1.00	1.00	1.00	1.00	1.00	1.00	1.00	1.00	1.00
Initial Bse:	175	1470	65	55	515	104	14	0	26	40	10	57
Added Vol:	0	0	0	0	0	0	0	0	0	0	0	0
PasserByVol:	0	0	0	0	0	0	0	0	0	0	0	0
Initial Fut:	175	1470	65	55	515	104	14	0	26	40	10	57
User Adj:	1.00	1.00	1.00	1.00	1.00	1.00	1.00	1.00	1.00	1.00	1.00	1.00
PHF Adj:	1.00	1.00	1.00	1.00	1.00	1.00	1.00	1.00	1.00	1.00	1.00	1.00
PHF Volume:	175	1470	65	55	515	104	14	0	26	40	10	57
Reduct Vol:	0	0	0	0	0	0	0	0	0	0	0	0
Reduced Vol:	175	1470	65	55	515	104	14	0	26	40	10	57
PCE Adj:	1.00	1.00	1.00	1.00	1.00	1.00	1.00	1.00	1.00	1.00	1.00	1.00
MLF Adj:	1.00	1.00	1.00	1.00	1.00	1.00	1.00	1.00	1.00	1.00	1.00	1.00
FinalVolume:	175	1470	65	55	515	104	14	0	26	40	10	57
Saturation Flow Module:												
Sat/Lane:	1900	1900	1900	1900	1900	1900	1900	1900	1900	1900	1900	1900
Adjustment:	0.92	0.98	0.95	0.92	0.99	0.95	0.92	1.00	0.92	0.92	0.95	0.95
Lanes:	1.00	2.87	0.13	1.00	2.48	0.52	1.00	1.00	1.00	1.00	0.15	0.85
Final Sat.:	1750	5363	237	1750	4658	941	1750	1900	1750	1750	269	1531
Capacity Analysis Module:												
Vol/Sat:	0.10	0.27	0.27	0.03	0.11	0.11	0.01	0.00	0.01	0.02	0.04	0.04
Crit Moves:	****			****						****		
Green Time:	16.9	34.0	34.0	7.0	24.1	24.1	10.0	0.0	26.9	10.0	10.0	10.0
Volume/Cap:	0.36	0.48	0.48	0.27	0.28	0.28	0.05	0.00	0.03	0.14	0.22	0.22
Delay/Veh:	17.7	7.9	7.9	24.9	12.1	12.1	21.1	0.0	9.3	21.5	22.0	22.0
User DelAdj:	1.00	1.00	1.00	1.00	1.00	1.00	1.00	1.00	1.00	1.00	1.00	1.00
AdjDel/Veh:	17.7	7.9	7.9	24.9	12.1	12.1	21.1	0.0	9.3	21.5	22.0	22.0
LOS by Move:	B	A	A	C	B	B	C	A	A	C	C	C
HCM2k95thQ:	6	12	12	2	5	5	1	0	1	2	3	3

Note: Queue reported is the number of cars per lane.

BART Phase II Extension Project

Level Of Service Computation Report
2000 HCM Operations (Future Volume Alternative)
PM - 2025 No Project Conditions

Intersection #1012: El Camino Real/Railroad Ave

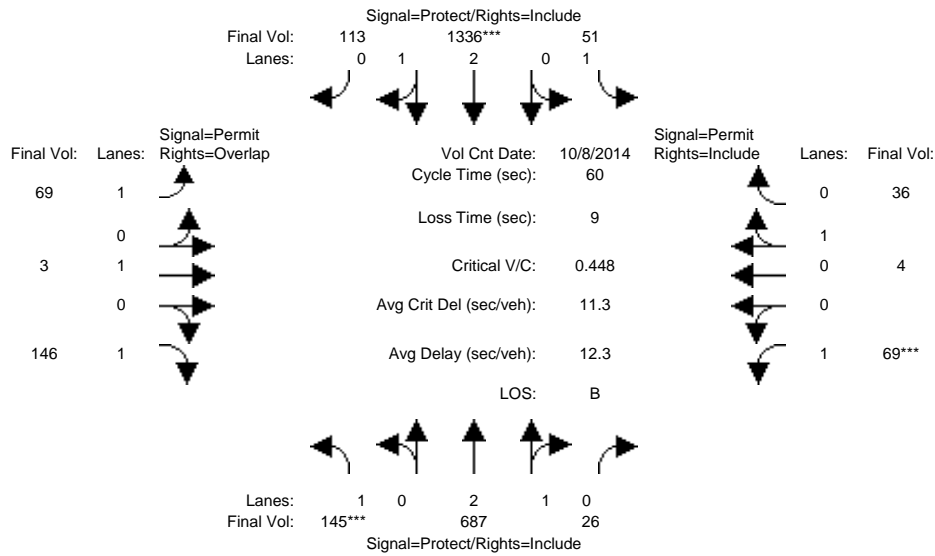

Approach:	North Bound			South Bound			East Bound			West Bound		
	L	T	R	L	T	R	L	T	R	L	T	R
Min. Green:	7	10	10	7	10	10	10	10	10	10	10	10
Y+R:	4.0	4.0	4.0	4.0	4.0	4.0	4.0	4.0	4.0	4.0	4.0	4.0
Volume Module: >> Count Date: 8 Oct 2014 <<												
Base Vol:	145	687	26	51	1336	113	69	3	146	69	4	36
Growth Adj:	1.00	1.00	1.00	1.00	1.00	1.00	1.00	1.00	1.00	1.00	1.00	1.00
Initial Bse:	145	687	26	51	1336	113	69	3	146	69	4	36
Added Vol:	0	0	0	0	0	0	0	0	0	0	0	0
PasserByVol:	0	0	0	0	0	0	0	0	0	0	0	0
Initial Fut:	145	687	26	51	1336	113	69	3	146	69	4	36
User Adj:	1.00	1.00	1.00	1.00	1.00	1.00	1.00	1.00	1.00	1.00	1.00	1.00
PHF Adj:	1.00	1.00	1.00	1.00	1.00	1.00	1.00	1.00	1.00	1.00	1.00	1.00
PHF Volume:	145	687	26	51	1336	113	69	3	146	69	4	36
Reduct Vol:	0	0	0	0	0	0	0	0	0	0	0	0
Reduced Vol:	145	687	26	51	1336	113	69	3	146	69	4	36
PCE Adj:	1.00	1.00	1.00	1.00	1.00	1.00	1.00	1.00	1.00	1.00	1.00	1.00
MLF Adj:	1.00	1.00	1.00	1.00	1.00	1.00	1.00	1.00	1.00	1.00	1.00	1.00
Final Volume:	145	687	26	51	1336	113	69	3	146	69	4	36
Saturation Flow Module:												
Sat/Lane:	1900	1900	1900	1900	1900	1900	1900	1900	1900	1900	1900	1900
Adjustment:	0.92	0.98	0.95	0.92	0.99	0.95	0.92	1.00	0.92	0.92	0.95	0.95
Lanes:	1.00	2.89	0.11	1.00	2.76	0.24	1.00	1.00	1.00	1.00	0.10	0.90
Final Sat.:	1750	5396	204	1750	5163	437	1750	1900	1750	1750	180	1620
Capacity Analysis Module:												
Vol/Sat:	0.08	0.13	0.13	0.03	0.26	0.26	0.04	0.00	0.08	0.04	0.02	0.02
Crit Moves:	****				****					****		
Green Time:	9.9	24.1	24.1	16.9	31.1	31.1	10.0	10.0	19.9	10.0	10.0	10.0
Volume/Cap:	0.50	0.32	0.32	0.10	0.50	0.50	0.24	0.01	0.25	0.24	0.13	0.13
Delay/Veh:	24.1	12.4	12.4	16.1	9.6	9.6	22.1	20.9	14.8	22.1	21.5	21.5
User DelAdj:	1.00	1.00	1.00	1.00	1.00	1.00	1.00	1.00	1.00	1.00	1.00	1.00
AdjDel/Veh:	24.1	12.4	12.4	16.1	9.6	9.6	22.1	20.9	14.8	22.1	21.5	21.5
LOS by Move:	C	B	B	B	A	A	C	C	B	C	C	C
HCM2k95thQ:	7	6	6	1	11	11	3	0	5	3	2	2

Note: Queue reported is the number of cars per lane.

BART Phase II Extension Project

Level Of Service Computation Report
 2000 HCM Operations (Future Volume Alternative)
 AM - 2025 No Project Conditions

Intersection #1202: LAFAYETTE/EL CAMINO REAL

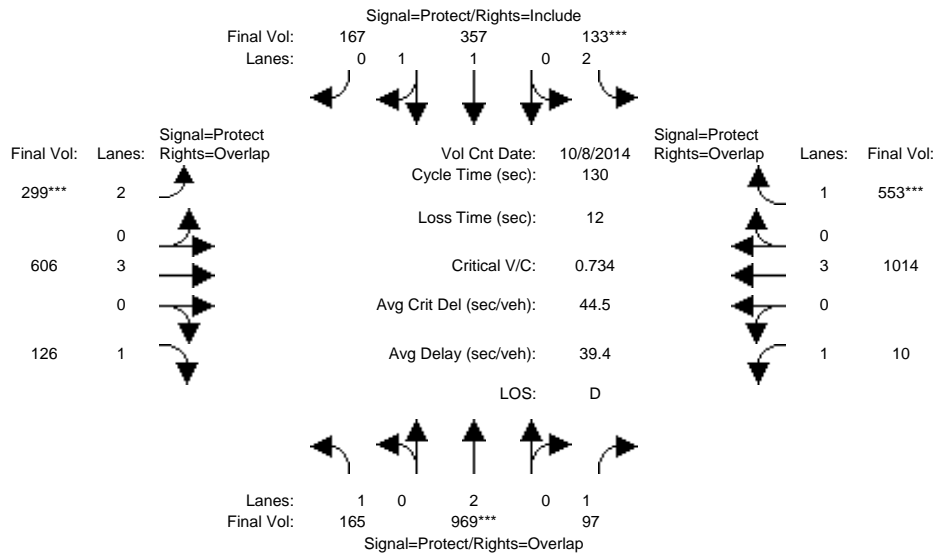

Approach:	North Bound			South Bound			East Bound			West Bound		
Movement:	L	T	R	L	T	R	L	T	R	L	T	R
Min. Green:	7	10	10	7	10	10	7	10	10	7	10	10
Y+R:	4.0	4.0	4.0	4.0	4.0	4.0	4.0	4.0	4.0	4.0	4.0	4.0
Volume Module: >> Count Date: 8 Oct 2014 <<												
Base Vol:	165	969	97	133	357	167	299	606	126	10	1014	553
Growth Adj:	1.00	1.00	1.00	1.00	1.00	1.00	1.00	1.00	1.00	1.00	1.00	1.00
Initial Bse:	165	969	97	133	357	167	299	606	126	10	1014	553
Added Vol:	0	0	0	0	0	0	0	0	0	0	0	0
PasserByVol:	0	0	0	0	0	0	0	0	0	0	0	0
Initial Fut:	165	969	97	133	357	167	299	606	126	10	1014	553
User Adj:	1.00	1.00	1.00	1.00	1.00	1.00	1.00	1.00	1.00	1.00	1.00	1.00
PHF Adj:	1.00	1.00	1.00	1.00	1.00	1.00	1.00	1.00	1.00	1.00	1.00	1.00
PHF Volume:	165	969	97	133	357	167	299	606	126	10	1014	553
Reduct Vol:	0	0	0	0	0	0	0	0	0	0	0	0
Reduced Vol:	165	969	97	133	357	167	299	606	126	10	1014	553
PCE Adj:	1.00	1.00	1.00	1.00	1.00	1.00	1.00	1.00	1.00	1.00	1.00	1.00
MLF Adj:	1.00	1.00	1.00	1.00	1.00	1.00	1.00	1.00	1.00	1.00	1.00	1.00
Final Volume:	165	969	97	133	357	167	299	606	126	10	1014	553
Saturation Flow Module:												
Sat/Lane:	1900	1900	1900	1900	1900	1900	1900	1900	1900	1900	1900	1900
Adjustment:	0.92	1.00	0.92	0.83	0.99	0.95	0.83	1.00	0.92	0.92	1.00	0.92
Lanes:	1.00	2.00	1.00	2.00	1.35	0.65	2.00	3.00	1.00	1.00	3.00	1.00
Final Sat.:	1750	3800	1750	3150	2520	1179	3150	5700	1750	1750	5700	1750
Capacity Analysis Module:												
Vol/Sat:	0.09	0.26	0.06	0.04	0.14	0.14	0.09	0.11	0.07	0.01	0.18	0.32
Crit Moves:	****			****			****			****		
Green Time:	21.0	45.2	66.5	7.5	31.6	31.6	16.8	42.0	63.0	21.3	46.5	53.9
Volume/Cap:	0.58	0.73	0.11	0.73	0.58	0.58	0.73	0.33	0.15	0.03	0.50	0.76
Delay/Veh:	53.5	39.3	16.5	74.6	44.3	44.3	61.2	33.4	18.7	45.8	32.8	37.3
User DelAdj:	1.00	1.00	1.00	1.00	1.00	1.00	1.00	1.00	1.00	1.00	1.00	1.00
AdjDel/Veh:	53.5	39.3	16.5	74.6	44.3	44.3	61.2	33.4	18.7	45.8	32.8	37.3
LOS by Move:	D	D	B	E	D	D	E	C	B	D	C	D
HCM2k95thQ:	13	29	4	7	17	17	13	11	6	1	19	36

Note: Queue reported is the number of cars per lane.

BART Phase II Extension Project

Level Of Service Computation Report
2000 HCM Operations (Future Volume Alternative)
PM - 2025 No Project Conditions

Intersection #1202: LAFAYETTE/EL CAMINO REAL

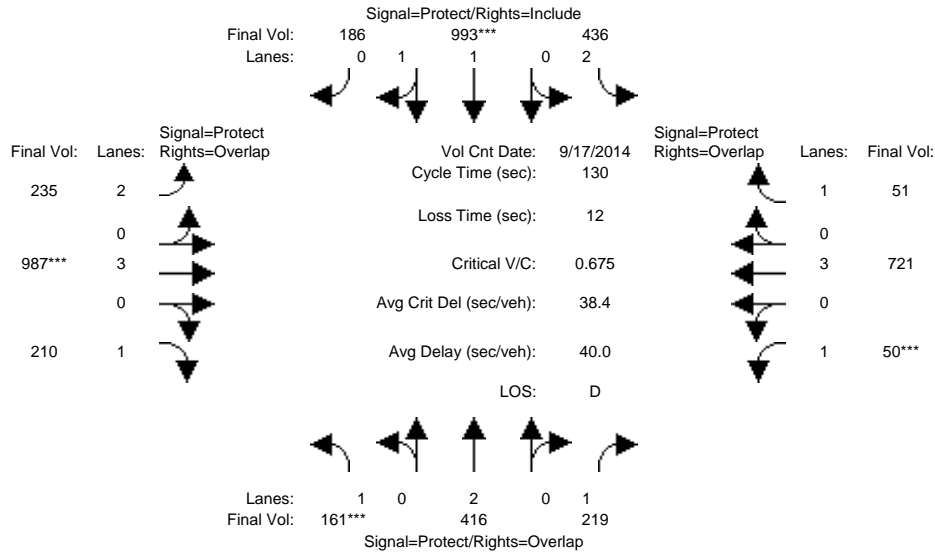

Approach:	North Bound			South Bound			East Bound			West Bound		
	L	T	R	L	T	R	L	T	R	L	T	R
Min. Green:	7	10	10	7	10	10	7	10	10	7	10	10
Y+R:	4.0	4.0	4.0	4.0	4.0	4.0	4.0	4.0	4.0	4.0	4.0	4.0
Volume Module: >> Count Date: 17 Sep 2014 <<												
Base Vol:	161	416	219	436	993	186	235	987	210	50	721	51
Growth Adj:	1.00	1.00	1.00	1.00	1.00	1.00	1.00	1.00	1.00	1.00	1.00	1.00
Initial Bse:	161	416	219	436	993	186	235	987	210	50	721	51
Added Vol:	0	0	0	0	0	0	0	0	0	0	0	0
PasserByVol:	0	0	0	0	0	0	0	0	0	0	0	0
Initial Fut:	161	416	219	436	993	186	235	987	210	50	721	51
User Adj:	1.00	1.00	1.00	1.00	1.00	1.00	1.00	1.00	1.00	1.00	1.00	1.00
PHF Adj:	1.00	1.00	1.00	1.00	1.00	1.00	1.00	1.00	1.00	1.00	1.00	1.00
PHF Volume:	161	416	219	436	993	186	235	987	210	50	721	51
Reduct Vol:	0	0	0	0	0	0	0	0	0	0	0	0
Reduced Vol:	161	416	219	436	993	186	235	987	210	50	721	51
PCE Adj:	1.00	1.00	1.00	1.00	1.00	1.00	1.00	1.00	1.00	1.00	1.00	1.00
MLF Adj:	1.00	1.00	1.00	1.00	1.00	1.00	1.00	1.00	1.00	1.00	1.00	1.00
FinalVolume:	161	416	219	436	993	186	235	987	210	50	721	51
Saturation Flow Module:												
Sat/Lane:	1900	1900	1900	1900	1900	1900	1900	1900	1900	1900	1900	1900
Adjustment:	0.92	1.00	0.92	0.83	0.98	0.95	0.83	1.00	0.92	0.92	1.00	0.92
Lanes:	1.00	2.00	1.00	2.00	1.68	0.32	2.00	3.00	1.00	1.00	3.00	1.00
Final Sat.:	1750	3800	1750	3150	3116	584	3150	5700	1750	1750	5700	1750
Capacity Analysis Module:												
Vol/Sat:	0.09	0.11	0.13	0.14	0.32	0.32	0.07	0.17	0.12	0.03	0.13	0.03
Crit Moves:	****			****			****			****		
Green Time:	17.5	34.5	41.5	43.6	60.6	60.6	14.8	32.9	50.4	7.0	25.1	68.7
Volume/Cap:	0.68	0.41	0.39	0.41	0.68	0.68	0.65	0.68	0.31	0.53	0.65	0.06
Delay/Veh:	61.7	39.7	34.9	33.6	28.3	28.3	59.5	45.2	27.9	65.6	49.9	14.9
User DelAdj:	1.00	1.00	1.00	1.00	1.00	1.00	1.00	1.00	1.00	1.00	1.00	1.00
AdjDel/Veh:	61.7	39.7	34.9	33.6	28.3	28.3	59.5	45.2	27.9	65.6	49.9	14.9
LOS by Move:	E	D	C	C	C	C	E	D	C	E	D	B
HCM2k95thQ:	13	13	13	15	32	32	11	21	12	6	18	2

Note: Queue reported is the number of cars per lane.

BART Phase II Extension Project

Level Of Service Computation Report
 2000 HCM Operations (Future Volume Alternative)
 AM - 2025 No Project Conditions

Intersection #1204: MONROE/EL CAMINO REAL

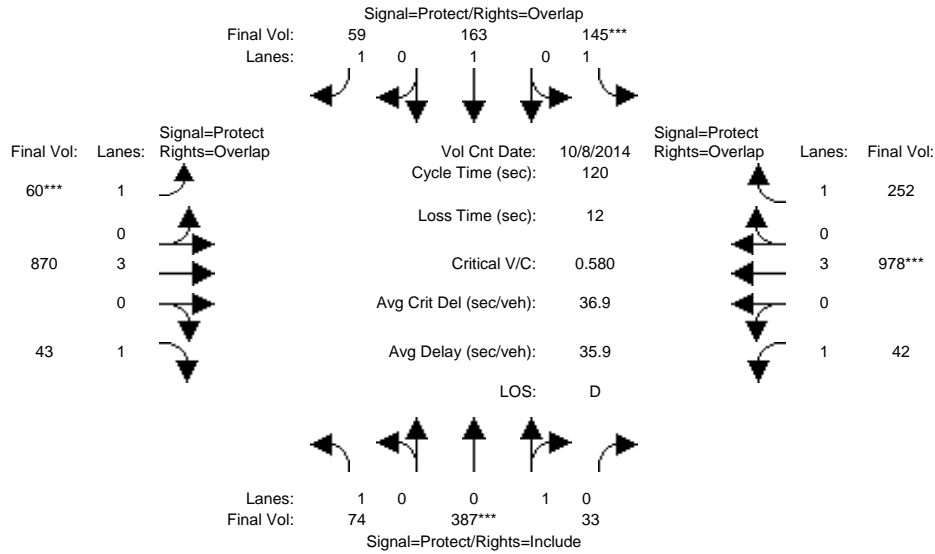

Approach:	North Bound			South Bound			East Bound			West Bound		
Movement:	L	T	R	L	T	R	L	T	R	L	T	R
Min. Green:	7	10	10	7	10	10	7	10	10	7	10	10
Y+R:	4.0	4.0	4.0	4.0	4.0	4.0	4.0	4.0	4.0	4.0	4.0	4.0
Volume Module: >> Count Date: 8 Oct 2014 <<												
Base Vol:	74	387	33	145	163	59	60	870	43	42	978	252
Growth Adj:	1.00	1.00	1.00	1.00	1.00	1.00	1.00	1.00	1.00	1.00	1.00	1.00
Initial Bse:	74	387	33	145	163	59	60	870	43	42	978	252
Added Vol:	0	0	0	0	0	0	0	0	0	0	0	0
PasserByVol:	0	0	0	0	0	0	0	0	0	0	0	0
Initial Fut:	74	387	33	145	163	59	60	870	43	42	978	252
User Adj:	1.00	1.00	1.00	1.00	1.00	1.00	1.00	1.00	1.00	1.00	1.00	1.00
PHF Adj:	1.00	1.00	1.00	1.00	1.00	1.00	1.00	1.00	1.00	1.00	1.00	1.00
PHF Volume:	74	387	33	145	163	59	60	870	43	42	978	252
Reduct Vol:	0	0	0	0	0	0	0	0	0	0	0	0
Reduced Vol:	74	387	33	145	163	59	60	870	43	42	978	252
PCE Adj:	1.00	1.00	1.00	1.00	1.00	1.00	1.00	1.00	1.00	1.00	1.00	1.00
MLF Adj:	1.00	1.00	1.00	1.00	1.00	1.00	1.00	1.00	1.00	1.00	1.00	1.00
FinalVolume:	74	387	33	145	163	59	60	870	43	42	978	252
Saturation Flow Module:												
Sat/Lane:	1900	1900	1900	1900	1900	1900	1900	1900	1900	1900	1900	1900
Adjustment:	0.92	0.95	0.95	0.92	1.00	0.92	0.92	1.00	0.92	0.92	1.00	0.92
Lanes:	1.00	0.92	0.08	1.00	1.00	1.00	1.00	3.00	1.00	1.00	3.00	1.00
Final Sat.:	1750	1659	141	1750	1900	1750	1750	5700	1750	1750	5700	1750
Capacity Analysis Module:												
Vol/Sat:	0.04	0.23	0.23	0.08	0.09	0.03	0.03	0.15	0.02	0.02	0.17	0.14
Crit Moves:	****	****	****	****	****	****	****	****	****	****	****	****
Green Time:	26.5	48.3	48.3	17.1	38.9	46.0	7.1	30.8	57.3	11.8	35.5	52.6
Volume/Cap:	0.19	0.58	0.58	0.58	0.26	0.09	0.58	0.59	0.05	0.24	0.58	0.33
Delay/Veh:	38.3	29.2	29.2	51.5	30.2	23.7	63.0	39.8	16.8	50.7	36.4	22.3
User DelAdj:	1.00	1.00	1.00	1.00	1.00	1.00	1.00	1.00	1.00	1.00	1.00	1.00
AdjDel/Veh:	38.3	29.2	29.2	51.5	30.2	23.7	63.0	39.8	16.8	50.7	36.4	22.3
LOS by Move:	D	C	C	D	C	C	E	D	B	D	D	C
HCM2k95thQ:	5	23	23	11	8	3	5	17	2	3	18	12

Note: Queue reported is the number of cars per lane.

BART Phase II Extension Project

Level Of Service Computation Report
 2000 HCM Operations (Future Volume Alternative)
 PM - 2025 No Project Conditions

Intersection #1204: MONROE/EL CAMINO REAL

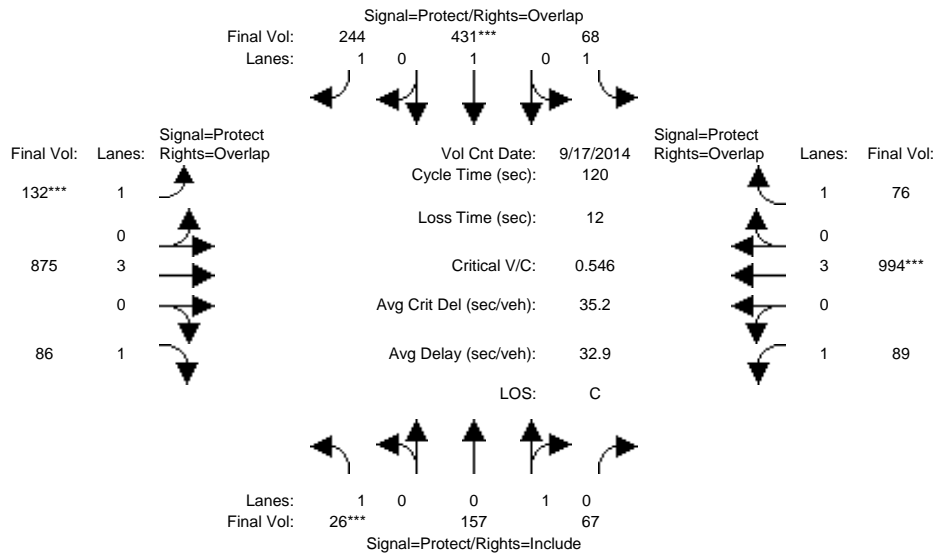

Approach:	North Bound			South Bound			East Bound			West Bound		
Movement:	L	T	R	L	T	R	L	T	R	L	T	R
Min. Green:	7	10	10	7	10	10	7	10	10	7	10	10
Y+R:	4.0	4.0	4.0	4.0	4.0	4.0	4.0	4.0	4.0	4.0	4.0	4.0
Volume Module: >> Count Date: 17 Sep 2014 <<												
Base Vol:	26	157	67	68	431	244	132	875	86	89	994	76
Growth Adj:	1.00	1.00	1.00	1.00	1.00	1.00	1.00	1.00	1.00	1.00	1.00	1.00
Initial Bse:	26	157	67	68	431	244	132	875	86	89	994	76
Added Vol:	0	0	0	0	0	0	0	0	0	0	0	0
PasserByVol:	0	0	0	0	0	0	0	0	0	0	0	0
Initial Fut:	26	157	67	68	431	244	132	875	86	89	994	76
User Adj:	1.00	1.00	1.00	1.00	1.00	1.00	1.00	1.00	1.00	1.00	1.00	1.00
PHF Adj:	1.00	1.00	1.00	1.00	1.00	1.00	1.00	1.00	1.00	1.00	1.00	1.00
PHF Volume:	26	157	67	68	431	244	132	875	86	89	994	76
Reduct Vol:	0	0	0	0	0	0	0	0	0	0	0	0
Reduced Vol:	26	157	67	68	431	244	132	875	86	89	994	76
PCE Adj:	1.00	1.00	1.00	1.00	1.00	1.00	1.00	1.00	1.00	1.00	1.00	1.00
MLF Adj:	1.00	1.00	1.00	1.00	1.00	1.00	1.00	1.00	1.00	1.00	1.00	1.00
Final Volume:	26	157	67	68	431	244	132	875	86	89	994	76
Saturation Flow Module:												
Sat/Lane:	1900	1900	1900	1900	1900	1900	1900	1900	1900	1900	1900	1900
Adjustment:	0.92	0.95	0.95	0.92	1.00	0.92	0.92	1.00	0.92	0.92	1.00	0.92
Lanes:	1.00	0.70	0.30	1.00	1.00	1.00	1.00	3.00	1.00	1.00	3.00	1.00
Final Sat.:	1750	1262	538	1750	1900	1750	1750	5700	1750	1750	5700	1750
Capacity Analysis Module:												
Vol/Sat:	0.01	0.12	0.12	0.04	0.23	0.14	0.08	0.15	0.05	0.05	0.17	0.04
Crit Moves:	****			****			****			****		
Green Time:	7.0	37.5	37.5	17.6	48.1	64.0	16.0	38.4	45.4	14.6	37.0	54.5
Volume/Cap:	0.25	0.40	0.40	0.27	0.57	0.26	0.57	0.48	0.13	0.42	0.57	0.10
Delay/Veh:	55.3	32.9	32.9	46.0	28.9	15.3	52.0	33.0	24.5	50.1	35.2	18.7
User DelAdj:	1.00	1.00	1.00	1.00	1.00	1.00	1.00	1.00	1.00	1.00	1.00	1.00
AdjDel/Veh:	55.3	32.9	32.9	46.0	28.9	15.3	52.0	33.0	24.5	50.1	35.2	18.7
LOS by Move:	E	C	C	D	C	B	D	C	C	D	D	B
HCM2k95thQ:	3	13	13	5	22	10	10	16	4	6	18	3

Note: Queue reported is the number of cars per lane.

BART Phase II Extension Project

Level Of Service Computation Report
 2000 HCM Operations (Future Volume Alternative)
 AM - 2025 No Project Conditions

Intersection #1205: SCOTT/EL CAMINO REAL

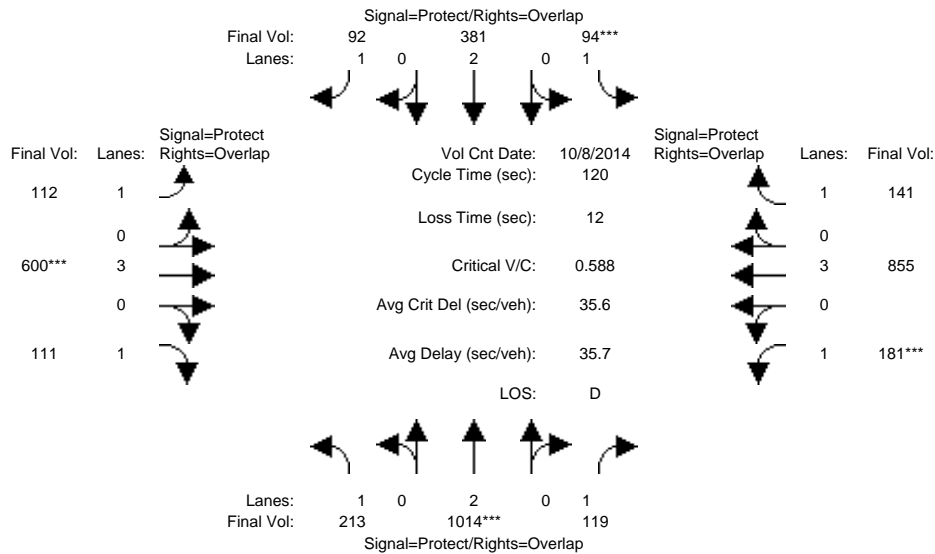

Approach:	North Bound			South Bound			East Bound			West Bound		
	L	T	R	L	T	R	L	T	R	L	T	R
Min. Green:	7	10	10	7	10	10	7	10	10	7	10	10
Y+R:	4.0	4.0	4.0	4.0	4.0	4.0	4.0	4.0	4.0	4.0	4.0	4.0
Volume Module: >> Count Date: 8 Oct 2014 <<												
Base Vol:	213	1014	119	94	381	92	112	600	111	181	855	141
Growth Adj:	1.00	1.00	1.00	1.00	1.00	1.00	1.00	1.00	1.00	1.00	1.00	1.00
Initial Bse:	213	1014	119	94	381	92	112	600	111	181	855	141
Added Vol:	0	0	0	0	0	0	0	0	0	0	0	0
PasserByVol:	0	0	0	0	0	0	0	0	0	0	0	0
Initial Fut:	213	1014	119	94	381	92	112	600	111	181	855	141
User Adj:	1.00	1.00	1.00	1.00	1.00	1.00	1.00	1.00	1.00	1.00	1.00	1.00
PHF Adj:	1.00	1.00	1.00	1.00	1.00	1.00	1.00	1.00	1.00	1.00	1.00	1.00
PHF Volume:	213	1014	119	94	381	92	112	600	111	181	855	141
Reduct Vol:	0	0	0	0	0	0	0	0	0	0	0	0
Reduced Vol:	213	1014	119	94	381	92	112	600	111	181	855	141
PCE Adj:	1.00	1.00	1.00	1.00	1.00	1.00	1.00	1.00	1.00	1.00	1.00	1.00
MLF Adj:	1.00	1.00	1.00	1.00	1.00	1.00	1.00	1.00	1.00	1.00	1.00	1.00
FinalVolume:	213	1014	119	94	381	92	112	600	111	181	855	141
Saturation Flow Module:												
Sat/Lane:	1900	1900	1900	1900	1900	1900	1900	1900	1900	1900	1900	1900
Adjustment:	0.92	1.00	0.92	0.92	1.00	0.92	0.92	1.00	0.92	0.92	1.00	0.92
Lanes:	1.00	2.00	1.00	1.00	2.00	1.00	1.00	3.00	1.00	1.00	3.00	1.00
Final Sat.:	1750	3800	1750	1750	3800	1750	1750	5700	1750	1750	5700	1750
Capacity Analysis Module:												
Vol/Sat:	0.12	0.27	0.07	0.05	0.10	0.05	0.06	0.11	0.06	0.10	0.15	0.08
Crit Moves:	****			****			****			****		
Green Time:	35.9	54.5	75.6	11.0	29.5	42.3	12.7	21.5	57.3	21.1	29.9	40.8
Volume/Cap:	0.41	0.59	0.11	0.59	0.41	0.15	0.60	0.59	0.13	0.59	0.60	0.24
Delay/Veh:	34.1	25.0	8.9	58.0	38.2	26.7	56.7	46.1	17.5	48.4	40.6	28.6
User DelAdj:	1.00	1.00	1.00	1.00	1.00	1.00	1.00	1.00	1.00	1.00	1.00	1.00
AdjDel/Veh:	34.1	25.0	8.9	58.0	38.2	26.7	56.7	46.1	17.5	48.4	40.6	28.6
LOS by Move:	C	C	A	E	D	C	E	D	B	D	D	C
HCM2k95thQ:	13	24	4	7	11	5	9	13	5	13	17	8

Note: Queue reported is the number of cars per lane.

BART Phase II Extension Project

Level Of Service Computation Report
 2000 HCM Operations (Future Volume Alternative)
 PM - 2025 No Project Conditions

Intersection #1205: SCOTT/EL CAMINO REAL

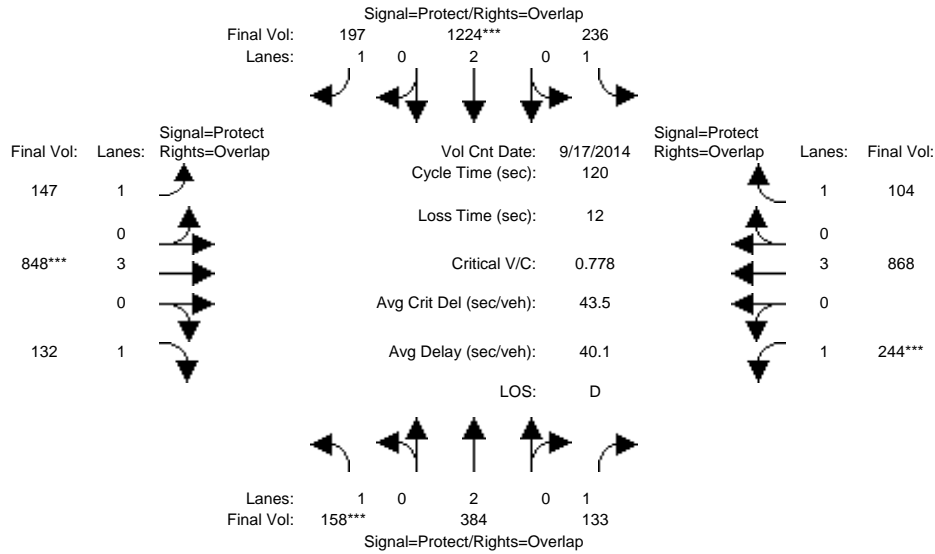

Approach:	North Bound			South Bound			East Bound			West Bound		
Movement:	L	T	R	L	T	R	L	T	R	L	T	R
Min. Green:	7	10	10	7	10	10	7	10	10	7	10	10
Y+R:	4.0	4.0	4.0	4.0	4.0	4.0	4.0	4.0	4.0	4.0	4.0	4.0
Volume Module: >> Count Date: 17 Sep 2014 <<												
Base Vol:	158	384	133	236	1224	197	147	848	132	244	868	104
Growth Adj:	1.00	1.00	1.00	1.00	1.00	1.00	1.00	1.00	1.00	1.00	1.00	1.00
Initial Bse:	158	384	133	236	1224	197	147	848	132	244	868	104
Added Vol:	0	0	0	0	0	0	0	0	0	0	0	0
PasserByVol:	0	0	0	0	0	0	0	0	0	0	0	0
Initial Fut:	158	384	133	236	1224	197	147	848	132	244	868	104
User Adj:	1.00	1.00	1.00	1.00	1.00	1.00	1.00	1.00	1.00	1.00	1.00	1.00
PHF Adj:	1.00	1.00	1.00	1.00	1.00	1.00	1.00	1.00	1.00	1.00	1.00	1.00
PHF Volume:	158	384	133	236	1224	197	147	848	132	244	868	104
Reduct Vol:	0	0	0	0	0	0	0	0	0	0	0	0
Reduced Vol:	158	384	133	236	1224	197	147	848	132	244	868	104
PCE Adj:	1.00	1.00	1.00	1.00	1.00	1.00	1.00	1.00	1.00	1.00	1.00	1.00
MLF Adj:	1.00	1.00	1.00	1.00	1.00	1.00	1.00	1.00	1.00	1.00	1.00	1.00
FinalVolume:	158	384	133	236	1224	197	147	848	132	244	868	104
Saturation Flow Module:												
Sat/Lane:	1900	1900	1900	1900	1900	1900	1900	1900	1900	1900	1900	1900
Adjustment:	0.92	1.00	0.92	0.92	1.00	0.92	0.92	1.00	0.92	0.92	1.00	0.92
Lanes:	1.00	2.00	1.00	1.00	2.00	1.00	1.00	3.00	1.00	1.00	3.00	1.00
Final Sat.:	1750	3800	1750	1750	3800	1750	1750	5700	1750	1750	5700	1750
Capacity Analysis Module:												
Vol/Sat:	0.09	0.10	0.08	0.13	0.32	0.11	0.08	0.15	0.08	0.14	0.15	0.06
Crit Moves:	****				****			****			****	
Green Time:	13.9	27.2	48.7	36.3	49.7	65.4	15.8	22.9	36.9	21.5	28.6	65.0
Volume/Cap:	0.78	0.45	0.19	0.45	0.78	0.21	0.64	0.78	0.25	0.78	0.64	0.11
Delay/Veh:	68.8	40.3	23.0	34.3	33.0	14.1	55.3	49.8	31.4	58.7	42.1	13.5
User DelAdj:	1.00	1.00	1.00	1.00	1.00	1.00	1.00	1.00	1.00	1.00	1.00	1.00
AdjDel/Veh:	68.8	40.3	23.0	34.3	33.0	14.1	55.3	49.8	31.4	58.7	42.1	13.5
LOS by Move:	E	D	C	C	C	B	E	D	C	E	D	B
HCM2k95thQ:	13	11	7	14	34	8	11	19	7	18	18	4

Note: Queue reported is the number of cars per lane.

BART Phase II Extension Project

Level Of Service Computation Report
 2000 HCM Operations (Future Volume Alternative)
 AM - 2025 No Project Conditions

Intersection #1213: THE ALAMEDA/EL CAMINO REAL

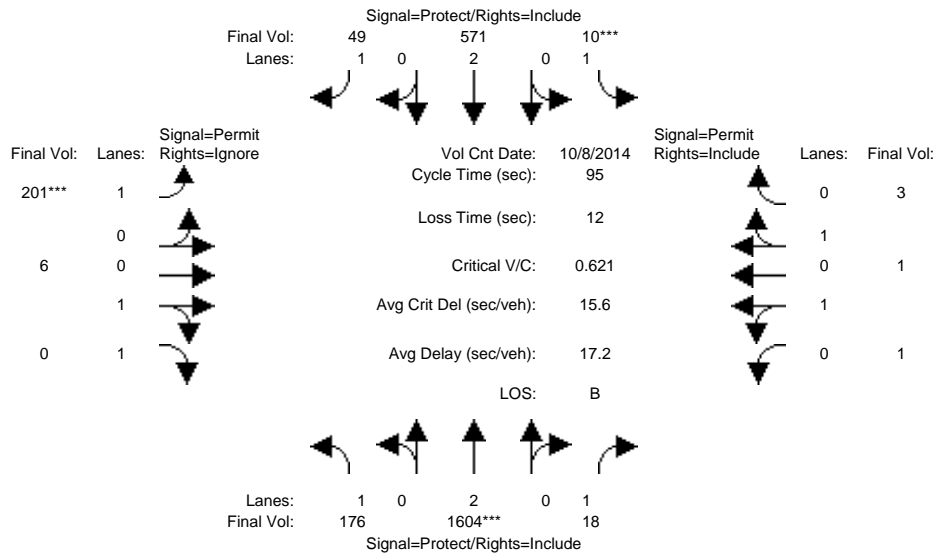

Approach:	North Bound			South Bound			East Bound			West Bound		
	L	T	R	L	T	R	L	T	R	L	T	R
Min. Green:	7	10	10	7	10	10	7	10	10	7	10	10
Y+R:	4.0	4.0	4.0	4.0	4.0	4.0	4.0	4.0	4.0	4.0	4.0	4.0
Volume Module: >> Count Date: 8 Oct 2014 <<												
Base Vol:	176	1604	18	10	571	49	201	6	207	1	1	3
Growth Adj:	1.00	1.00	1.00	1.00	1.00	1.00	1.00	1.00	1.00	1.00	1.00	1.00
Initial Bse:	176	1604	18	10	571	49	201	6	207	1	1	3
Added Vol:	0	0	0	0	0	0	0	0	0	0	0	0
PasserByVol:	0	0	0	0	0	0	0	0	0	0	0	0
Initial Fut:	176	1604	18	10	571	49	201	6	207	1	1	3
User Adj:	1.00	1.00	1.00	1.00	1.00	1.00	1.00	1.00	0.00	1.00	1.00	1.00
PHF Adj:	1.00	1.00	1.00	1.00	1.00	1.00	1.00	1.00	0.00	1.00	1.00	1.00
PHF Volume:	176	1604	18	10	571	49	201	6	0	1	1	3
Reduct Vol:	0	0	0	0	0	0	0	0	0	0	0	0
Reduced Vol:	176	1604	18	10	571	49	201	6	0	1	1	3
PCE Adj:	1.00	1.00	1.00	1.00	1.00	1.00	1.00	1.00	0.00	1.00	1.00	1.00
MLF Adj:	1.00	1.00	1.00	1.00	1.00	1.00	1.00	1.00	0.00	1.00	1.00	1.00
FinalVolume:	176	1604	18	10	571	49	201	6	0	1	1	3
Saturation Flow Module:												
Sat/Lane:	1900	1900	1900	1900	1900	1900	1900	1900	1900	1900	1900	1900
Adjustment:	0.92	1.00	0.92	0.92	1.00	0.92	0.92	0.95	0.92	0.95	0.95	0.95
Lanes:	1.00	2.00	1.00	1.00	2.00	1.00	1.00	1.00	1.00	0.50	0.50	1.00
Final Sat.:	1750	3800	1750	1750	3800	1750	1750	1800	1750	900	900	1800
Capacity Analysis Module:												
Vol/Sat:	0.10	0.42	0.01	0.01	0.15	0.03	0.11	0.00	0.00	0.00	0.00	0.00
Crit Moves:	****			****			****					
Green Time:	26.8	59.7	59.7	7.0	40.0	40.0	16.3	16.3	0.0	16.3	16.3	16.3
Volume/Cap:	0.36	0.67	0.02	0.08	0.36	0.07	0.67	0.02	0.00	0.01	0.01	0.01
Delay/Veh:	27.7	12.1	6.6	41.3	18.9	16.4	42.7	32.8	0.0	32.7	32.7	32.7
User DelAdj:	1.00	1.00	1.00	1.00	1.00	1.00	1.00	1.00	1.00	1.00	1.00	1.00
AdjDel/Veh:	27.7	12.1	6.6	41.3	18.9	16.4	42.7	32.8	0.0	32.7	32.7	32.7
LOS by Move:	C	B	A	D	B	B	D	C	A	C	C	C
HCM2k95thQ:	8	26	0	1	11	2	14	0	0	0	0	0

Note: Queue reported is the number of cars per lane.

BART Phase II Extension Project

Level Of Service Computation Report
 2000 HCM Operations (Future Volume Alternative)
 PM - 2025 No Project Conditions

Intersection #1213: THE ALAMEDA/EL CAMINO REAL

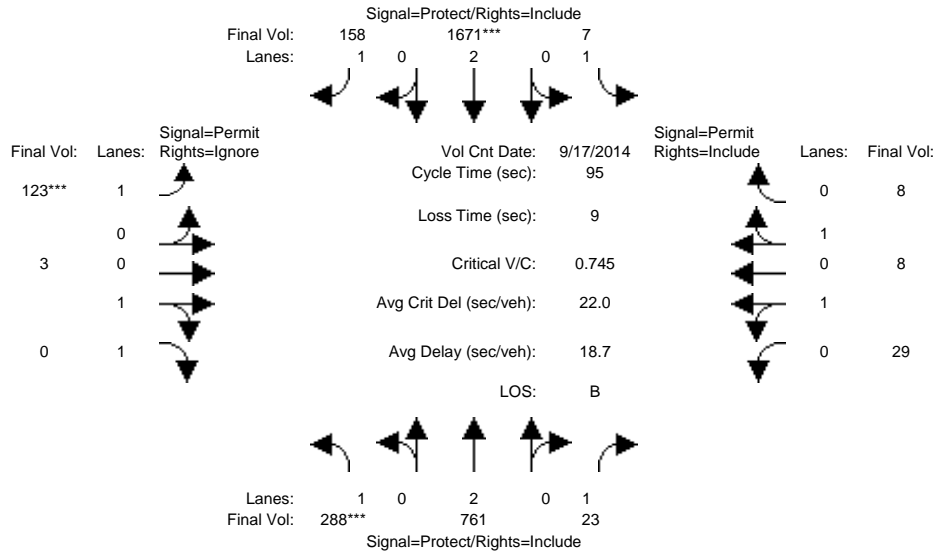

Approach:	North Bound			South Bound			East Bound			West Bound		
Movement:	L	T	R	L	T	R	L	T	R	L	T	R
Min. Green:	7	10	10	7	10	10	10	10	10	10	10	10
Y+R:	4.0	4.0	4.0	4.0	4.0	4.0	4.0	4.0	4.0	4.0	4.0	4.0
Volume Module: >> Count Date: 17 Sep 2014 <<												
Base Vol:	288	761	23	7	1671	158	123	3	281	29	8	8
Growth Adj:	1.00	1.00	1.00	1.00	1.00	1.00	1.00	1.00	1.00	1.00	1.00	1.00
Initial Bse:	288	761	23	7	1671	158	123	3	281	29	8	8
Added Vol:	0	0	0	0	0	0	0	0	0	0	0	0
PasserByVol:	0	0	0	0	0	0	0	0	0	0	0	0
Initial Fut:	288	761	23	7	1671	158	123	3	281	29	8	8
User Adj:	1.00	1.00	1.00	1.00	1.00	1.00	1.00	1.00	0.00	1.00	1.00	1.00
PHF Adj:	1.00	1.00	1.00	1.00	1.00	1.00	1.00	1.00	0.00	1.00	1.00	1.00
PHF Volume:	288	761	23	7	1671	158	123	3	0	29	8	8
Reduct Vol:	0	0	0	0	0	0	0	0	0	0	0	0
Reduced Vol:	288	761	23	7	1671	158	123	3	0	29	8	8
PCE Adj:	1.00	1.00	1.00	1.00	1.00	1.00	1.00	1.00	0.00	1.00	1.00	1.00
MLF Adj:	1.00	1.00	1.00	1.00	1.00	1.00	1.00	1.00	0.00	1.00	1.00	1.00
FinalVolume:	288	761	23	7	1671	158	123	3	0	29	8	8
Saturation Flow Module:												
Sat/Lane:	1900	1900	1900	1900	1900	1900	1900	1900	1900	1900	1900	1900
Adjustment:	0.92	1.00	0.92	0.92	1.00	0.92	0.92	0.95	0.92	0.95	0.95	0.95
Lanes:	1.00	2.00	1.00	1.00	2.00	1.00	1.00	1.00	1.00	1.00	0.50	0.50
Final Sat.:	1750	3800	1750	1750	3800	1750	1750	1800	1750	1800	900	900
Capacity Analysis Module:												
Vol/Sat:	0.16	0.20	0.01	0.00	0.44	0.09	0.07	0.00	0.00	0.02	0.01	0.01
Crit Moves:	****				****		****					
Green Time:	20.7	55.6	55.6	20.4	55.3	55.3	10.0	10.0	0.0	10.0	10.0	10.0
Volume/Cap:	0.76	0.34	0.02	0.02	0.76	0.16	0.67	0.02	0.00	0.15	0.08	0.08
Delay/Veh:	43.1	10.3	8.3	29.4	16.3	9.2	49.9	38.1	0.0	38.9	38.4	38.4
User DelAdj:	1.00	1.00	1.00	1.00	1.00	1.00	1.00	1.00	1.00	1.00	1.00	1.00
AdjDel/Veh:	43.1	10.3	8.3	29.4	16.3	9.2	49.9	38.1	0.0	38.9	38.4	38.4
LOS by Move:	D	B	A	C	B	A	D	D	A	D	D	D
HCM2k95thQ:	16	11	1	0	33	5	10	0	0	2	1	1

Note: Queue reported is the number of cars per lane.

BART Phase II Extension Project

Level Of Service Computation Report
2000 HCM Operations (Future Volume Alternative)
AM - 2025 No Project Conditions

Intersection #3411: AVIATION/COLEMAN

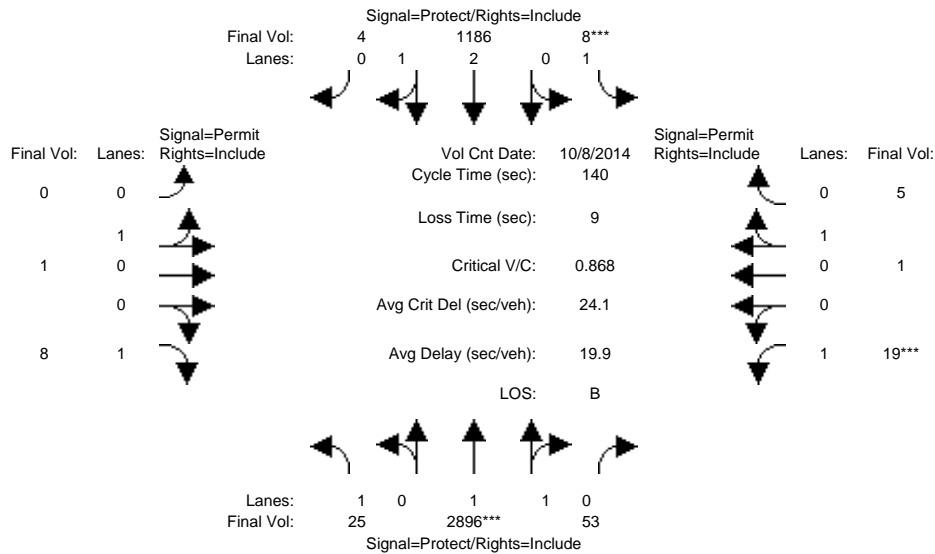

Approach:	North Bound			South Bound			East Bound			West Bound		
Movement:	L	T	R	L	T	R	L	T	R	L	T	R
Min. Green:	7	10	10	7	10	10	10	10	10	10	10	10
Y+R:	4.0	4.0	4.0	4.0	4.0	4.0	4.0	4.0	4.0	4.0	4.0	4.0
Volume Module: >> Count Date: 8 Oct 2014 <<												
Base Vol:	25	2896	53	8	1186	4	0	1	8	19	1	5
Growth Adj:	1.00	1.00	1.00	1.00	1.00	1.00	1.00	1.00	1.00	1.00	1.00	1.00
Initial Bse:	25	2896	53	8	1186	4	0	1	8	19	1	5
Added Vol:	0	0	0	0	0	0	0	0	0	0	0	0
PasserByVol:	0	0	0	0	0	0	0	0	0	0	0	0
Initial Fut:	25	2896	53	8	1186	4	0	1	8	19	1	5
User Adj:	1.00	1.00	1.00	1.00	1.00	1.00	1.00	1.00	1.00	1.00	1.00	1.00
PHF Adj:	1.00	1.00	1.00	1.00	1.00	1.00	1.00	1.00	1.00	1.00	1.00	1.00
PHF Volume:	25	2896	53	8	1186	4	0	1	8	19	1	5
Reduct Vol:	0	0	0	0	0	0	0	0	0	0	0	0
Reduced Vol:	25	2896	53	8	1186	4	0	1	8	19	1	5
PCE Adj:	1.00	1.00	1.00	1.00	1.00	1.00	1.00	1.00	1.00	1.00	1.00	1.00
MLF Adj:	1.00	1.00	1.00	1.00	1.00	1.00	1.00	1.00	1.00	1.00	1.00	1.00
FinalVolume:	25	2896	53	8	1186	4	0	1	8	19	1	5
Saturation Flow Module:												
Sat/Lane:	1900	1900	1900	1900	1900	1900	1900	1900	1900	1900	1900	1900
Adjustment:	0.92	0.97	0.95	0.92	0.98	0.95	0.95	0.95	0.92	0.92	0.95	0.95
Lanes:	1.00	1.96	0.04	1.00	2.99	0.01	0.00	1.00	1.00	1.00	0.17	0.83
Final Sat.:	1750	3633	66	1750	5581	19	0	1800	1750	1750	300	1500
Capacity Analysis Module:												
Vol/Sat:	0.01	0.80	0.80	0.00	0.21	0.21	0.00	0.00	0.00	0.01	0.00	0.00
Crit Moves:	****			****			****			****		
Green Time:	23.0	114	114.0	7.0	98.0	98.0	0.0	10.0	10.0	10.0	10.0	10.0
Volume/Cap:	0.09	0.98	0.98	0.09	0.30	0.30	0.00	0.01	0.06	0.15	0.05	0.05
Delay/Veh:	49.7	23.8	23.8	63.9	8.1	8.1	0.0	60.4	60.9	61.6	60.7	60.7
User DelAdj:	1.00	1.00	1.00	1.00	1.00	1.00	1.00	1.00	1.00	1.00	1.00	1.00
AdjDel/Veh:	49.7	23.8	23.8	63.9	8.1	8.1	0.0	60.4	60.9	61.6	60.7	60.7
LOS by Move:	D	C	C	E	A	A	A	E	E	E	E	E
HCM2k95thQ:	2	98	98	1	12	12	0	0	1	2	1	1

Note: Queue reported is the number of cars per lane.

BART Phase II Extension Project

Level Of Service Computation Report
2000 HCM Operations (Future Volume Alternative)
PM - 2025 No Project Conditions

Intersection #3411: AVIATION/COLEMAN

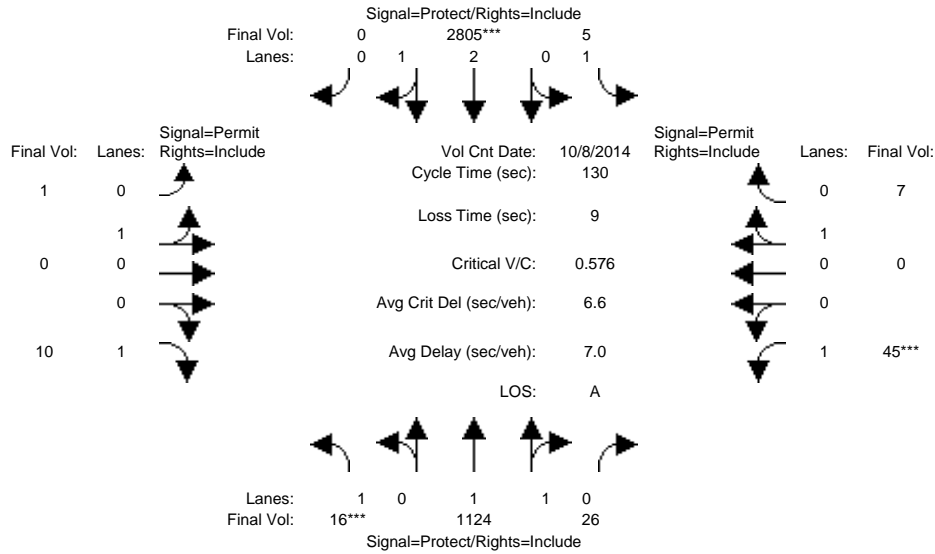

Approach:	North Bound			South Bound			East Bound			West Bound		
	L	T	R	L	T	R	L	T	R	L	T	R
Min. Green:	7	10	10	7	10	10	10	10	10	10	10	10
Y+R:	4.0	4.0	4.0	4.0	4.0	4.0	4.0	4.0	4.0	4.0	4.0	4.0
Volume Module: >> Count Date: 8 Oct 2014 <<												
Base Vol:	16	1124	26	5	2805	0	1	0	10	45	0	7
Growth Adj:	1.00	1.00	1.00	1.00	1.00	1.00	1.00	1.00	1.00	1.00	1.00	1.00
Initial Bse:	16	1124	26	5	2805	0	1	0	10	45	0	7
Added Vol:	0	0	0	0	0	0	0	0	0	0	0	0
PasserByVol:	0	0	0	0	0	0	0	0	0	0	0	0
Initial Fut:	16	1124	26	5	2805	0	1	0	10	45	0	7
User Adj:	1.00	1.00	1.00	1.00	1.00	1.00	1.00	1.00	1.00	1.00	1.00	1.00
PHF Adj:	1.00	1.00	1.00	1.00	1.00	1.00	1.00	1.00	1.00	1.00	1.00	1.00
PHF Volume:	16	1124	26	5	2805	0	1	0	10	45	0	7
Reduct Vol:	0	0	0	0	0	0	0	0	0	0	0	0
Reduced Vol:	16	1124	26	5	2805	0	1	0	10	45	0	7
PCE Adj:	1.00	1.00	1.00	1.00	1.00	1.00	1.00	1.00	1.00	1.00	1.00	1.00
MLF Adj:	1.00	1.00	1.00	1.00	1.00	1.00	1.00	1.00	1.00	1.00	1.00	1.00
FinalVolume:	16	1124	26	5	2805	0	1	0	10	45	0	7
Saturation Flow Module:												
Sat/Lane:	1900	1900	1900	1900	1900	1900	1900	1900	1900	1900	1900	1900
Adjustment:	0.92	0.97	0.95	0.92	0.98	0.92	0.95	0.95	0.92	0.92	1.00	0.95
Lanes:	1.00	1.95	0.05	1.00	3.00	0.00	1.00	0.00	1.00	1.00	0.00	1.00
Final Sat.:	1750	3616	84	1750	5600	0	1800	0	1750	1750	0	1800
Capacity Analysis Module:												
Vol/Sat:	0.01	0.31	0.31	0.00	0.50	0.00	0.00	0.00	0.01	0.03	0.00	0.00
Crit Moves:	****				****					****		
Green Time:	7.0	94.6	94.6	16.4	104	0.0	10.0	0.0	10.0	10.0	0.0	10.0
Volume/Cap:	0.17	0.43	0.43	0.02	0.63	0.00	0.01	0.00	0.07	0.33	0.00	0.05
Delay/Veh:	59.6	7.1	7.1	49.8	5.5	0.0	55.4	0.0	55.9	58.3	0.0	55.8
User DelAdj:	1.00	1.00	1.00	1.00	1.00	1.00	1.00	1.00	1.00	1.00	1.00	1.00
AdjDel/Veh:	59.6	7.1	7.1	49.8	5.5	0.0	55.4	0.0	55.9	58.3	0.0	55.8
LOS by Move:	E	A	A	D	A	A	E	A	E	E	A	E
HCM2k95thQ:	1	17	17	0	25	0	0	0	1	4	0	1

Note: Queue reported is the number of cars per lane.

BART Phase II Extension Project

Level Of Service Computation Report
 2000 HCM Operations (Future Volume Alternative)
 AM - 2025 No Project Conditions

Intersection #4047: COLEMAN/NEWHALL

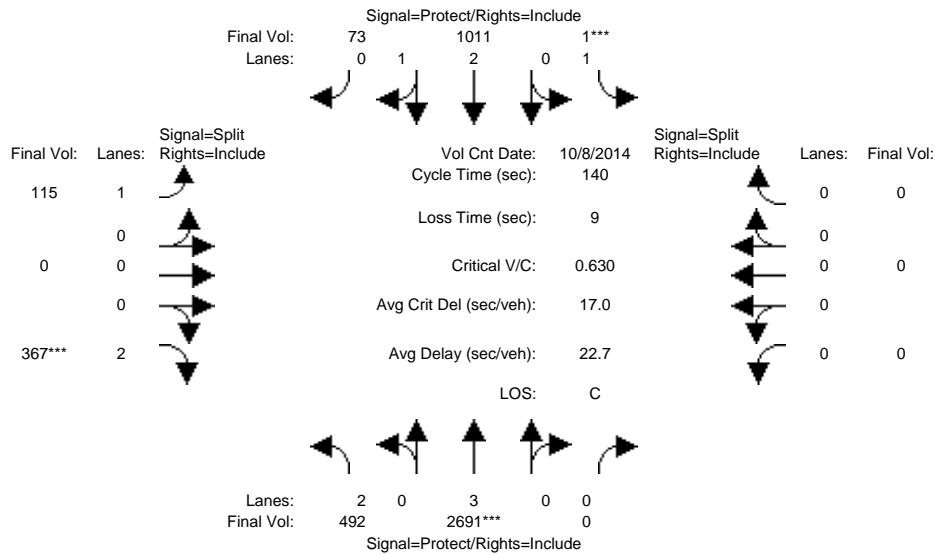

Approach:	North Bound			South Bound			East Bound			West Bound		
	L	T	R	L	T	R	L	T	R	L	T	R
Min. Green:	7	10	0	7	10	10	10	0	10	0	0	0
Y+R:	4.0	4.0	4.0	4.0	4.0	4.0	4.0	4.0	4.0	4.0	4.0	4.0
Volume Module: >> Count Date: 8 Oct 2014 <<												
Base Vol:	492	2691	0	1	1011	73	115	0	367	0	0	0
Growth Adj:	1.00	1.00	1.00	1.00	1.00	1.00	1.00	1.00	1.00	1.00	1.00	1.00
Initial Bse:	492	2691	0	1	1011	73	115	0	367	0	0	0
Added Vol:	0	0	0	0	0	0	0	0	0	0	0	0
PasserByVol:	0	0	0	0	0	0	0	0	0	0	0	0
Initial Fut:	492	2691	0	1	1011	73	115	0	367	0	0	0
User Adj:	1.00	1.00	1.00	1.00	1.00	1.00	1.00	1.00	1.00	1.00	1.00	1.00
PHF Adj:	1.00	1.00	1.00	1.00	1.00	1.00	1.00	1.00	1.00	1.00	1.00	1.00
PHF Volume:	492	2691	0	1	1011	73	115	0	367	0	0	0
Reduct Vol:	0	0	0	0	0	0	0	0	0	0	0	0
Reduced Vol:	492	2691	0	1	1011	73	115	0	367	0	0	0
PCE Adj:	1.00	1.00	1.00	1.00	1.00	1.00	1.00	1.00	1.00	1.00	1.00	1.00
MLF Adj:	1.00	1.00	1.00	1.00	1.00	1.00	1.00	1.00	1.00	1.00	1.00	1.00
FinalVolume:	492	2691	0	1	1011	73	115	0	367	0	0	0
Saturation Flow Module:												
Sat/Lane:	1900	1900	1900	1900	1900	1900	1900	1900	1900	1900	1900	1900
Adjustment:	0.83	1.00	0.92	0.92	0.98	0.95	0.92	1.00	0.83	0.92	1.00	0.92
Lanes:	2.00	3.00	0.00	1.00	2.79	0.21	1.00	0.00	2.00	0.00	0.00	0.00
Final Sat.:	3150	5700	0	1750	5222	377	1750	0	3150	0	0	0
Capacity Analysis Module:												
Vol/Sat:	0.16	0.47	0.00	0.00	0.19	0.19	0.07	0.00	0.12	0.00	0.00	0.00
Crit Moves:	****			****			****			****		
Green Time:	47.5	99.5	0.0	7.0	58.9	58.9	24.5	0.0	24.5	0.0	0.0	0.0
Volume/Cap:	0.46	0.66	0.00	0.01	0.46	0.46	0.37	0.00	0.66	0.00	0.00	0.00
Delay/Veh:	36.5	11.5	0.0	63.3	29.3	29.3	51.7	0.0	56.9	0.0	0.0	0.0
User DelAdj:	1.00	1.00	1.00	1.00	1.00	1.00	1.00	1.00	1.00	1.00	1.00	1.00
AdjDel/Veh:	36.5	11.5	0.0	63.3	29.3	29.3	51.7	0.0	56.9	0.0	0.0	0.0
LOS by Move:	D	B	A	E	C	C	D	A	E	A	A	A
HCM2k95thQ:	18	36	0	0	20	20	10	0	18	0	0	0

Note: Queue reported is the number of cars per lane.

BART Phase II Extension Project

Level Of Service Computation Report
 2000 HCM Operations (Future Volume Alternative)
 PM - 2025 No Project Conditions

Intersection #4047: COLEMAN/NEWHALL

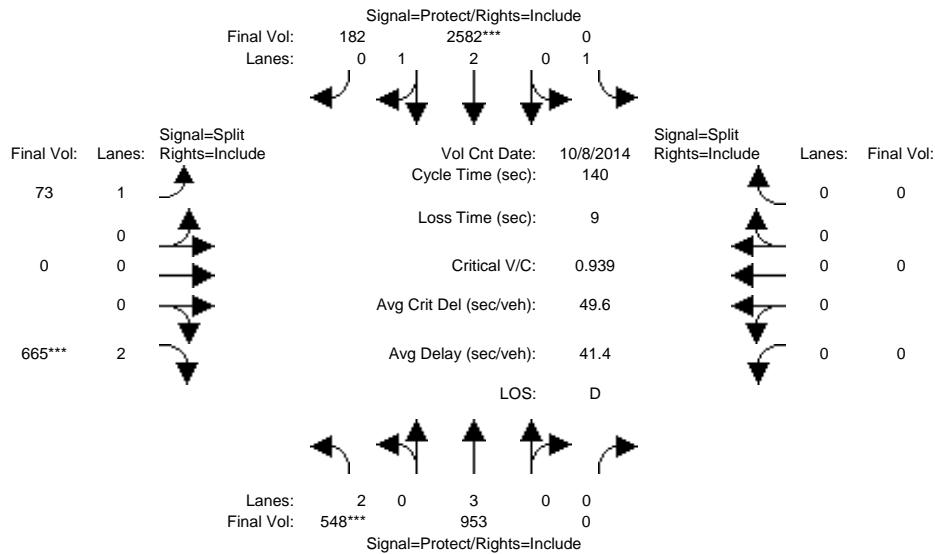

Approach:	North Bound			South Bound			East Bound			West Bound		
	L	T	R	L	T	R	L	T	R	L	T	R
Min. Green:	7	10	0	7	10	10	10	0	10	0	0	0
Y+R:	4.0	4.0	4.0	4.0	4.0	4.0	4.0	4.0	4.0	4.0	4.0	4.0
Volume Module: >> Count Date: 8 Oct 2014 <<												
Base Vol:	548	953	0	0	2582	182	73	0	665	0	0	0
Growth Adj:	1.00	1.00	1.00	1.00	1.00	1.00	1.00	1.00	1.00	1.00	1.00	1.00
Initial Bse:	548	953	0	0	2582	182	73	0	665	0	0	0
Added Vol:	0	0	0	0	0	0	0	0	0	0	0	0
PasserByVol:	0	0	0	0	0	0	0	0	0	0	0	0
Initial Fut:	548	953	0	0	2582	182	73	0	665	0	0	0
User Adj:	1.00	1.00	1.00	1.00	1.00	1.00	1.00	1.00	1.00	1.00	1.00	1.00
PHF Adj:	1.00	1.00	1.00	1.00	1.00	1.00	1.00	1.00	1.00	1.00	1.00	1.00
PHF Volume:	548	953	0	0	2582	182	73	0	665	0	0	0
Reduct Vol:	0	0	0	0	0	0	0	0	0	0	0	0
Reduced Vol:	548	953	0	0	2582	182	73	0	665	0	0	0
PCE Adj:	1.00	1.00	1.00	1.00	1.00	1.00	1.00	1.00	1.00	1.00	1.00	1.00
MLF Adj:	1.00	1.00	1.00	1.00	1.00	1.00	1.00	1.00	1.00	1.00	1.00	1.00
FinalVolume:	548	953	0	0	2582	182	73	0	665	0	0	0
Saturation Flow Module:												
Sat/Lane:	1900	1900	1900	1900	1900	1900	1900	1900	1900	1900	1900	1900
Adjustment:	0.83	1.00	0.92	0.92	0.98	0.95	0.92	1.00	0.83	0.92	1.00	0.92
Lanes:	2.00	3.00	0.00	1.00	2.80	0.20	1.00	0.00	2.00	0.00	0.00	0.00
Final Sat.:	3150	5700	0	1750	5231	369	1750	0	3150	0	0	0
Capacity Analysis Module:												
Vol/Sat:	0.17	0.17	0.00	0.00	0.49	0.49	0.04	0.00	0.21	0.00	0.00	0.00
Crit Moves:	****				****				****			
Green Time:	25.9	99.5	0.0	0.0	73.6	73.6	31.5	0.0	31.5	0.0	0.0	0.0
Volume/Cap:	0.94	0.24	0.00	0.00	0.94	0.94	0.19	0.00	0.94	0.00	0.00	0.00
Delay/Veh:	79.5	7.1	0.0	0.0	37.9	37.9	44.1	0.0	73.6	0.0	0.0	0.0
User DelAdj:	1.00	1.00	1.00	1.00	1.00	1.00	1.00	1.00	1.00	1.00	1.00	1.00
AdjDel/Veh:	79.5	7.1	0.0	0.0	37.9	37.9	44.1	0.0	73.6	0.0	0.0	0.0
LOS by Move:	E	A	A	A	D	D	D	A	E	A	A	A
HCM2k95thQ:	31	9	0	0	63	63	5	0	35	0	0	0

Note: Queue reported is the number of cars per lane.

BART Phase II Extension Project

Level Of Service Computation Report
 2000 HCM Operations (Future Volume Alternative)
 AM - 2025 No Project Conditions

Intersection #5335: CENTRAL EXPWY/DE LA CRUZ BLVD

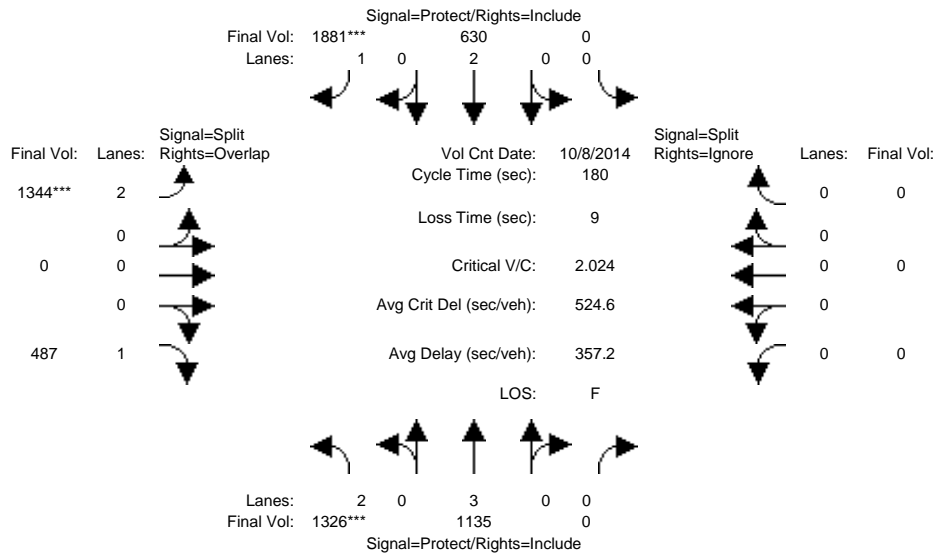

Approach:	North Bound			South Bound			East Bound			West Bound		
Movement:	L	T	R	L	T	R	L	T	R	L	T	R
Min. Green:	7	10	0	0	10	10	10	0	10	0	0	0
Y+R:	4.0	4.0	4.0	4.0	4.0	4.0	4.0	4.0	4.0	4.0	4.0	4.0
Volume Module: >> Count Date: 8 Oct 2014 <<												
Base Vol:	1326	1135	0	0	630	1881	1545	0	487	0	0	0
Growth Adj:	1.00	1.00	1.00	1.00	1.00	1.00	1.00	1.00	1.00	1.00	1.00	1.00
Initial Bse:	1326	1135	0	0	630	1881	1545	0	487	0	0	0
Added Vol:	0	0	0	0	0	0	0	0	0	0	0	0
PasserByVol:	0	0	0	0	0	0	0	0	0	0	0	0
Initial Fut:	1326	1135	0	0	630	1881	1545	0	487	0	0	0
User Adj:	1.00	1.00	1.00	1.00	1.00	1.00	0.87	1.00	1.00	1.00	1.00	0.00
PHF Adj:	1.00	1.00	1.00	1.00	1.00	1.00	1.00	1.00	1.00	1.00	1.00	0.00
PHF Volume:	1326	1135	0	0	630	1881	1344	0	487	0	0	0
Reduct Vol:	0	0	0	0	0	0	0	0	0	0	0	0
Reduced Vol:	1326	1135	0	0	630	1881	1344	0	487	0	0	0
PCE Adj:	1.00	1.00	1.00	1.00	1.00	1.00	1.00	1.00	1.00	1.00	1.00	0.00
MLF Adj:	1.00	1.00	1.00	1.00	1.00	1.00	1.00	1.00	1.00	1.00	1.00	0.00
Final Volume:	1326	1135	0	0	630	1881	1344	0	487	0	0	0
Saturation Flow Module:												
Sat/Lane:	1900	1900	1900	1900	1900	1900	1900	1900	1900	1900	1900	1900
Adjustment:	0.83	1.00	0.92	0.92	1.00	0.92	0.83	1.00	0.92	0.92	1.00	0.92
Lanes:	2.00	3.00	0.00	0.00	2.00	1.00	2.00	0.00	1.00	0.00	0.00	0.00
Final Sat.:	3150	5700	0	0	3800	1750	3150	0	1750	0	0	0
Capacity Analysis Module:												
Vol/Sat:	0.42	0.20	0.00	0.00	0.17	1.07	0.43	0.00	0.28	0.00	0.00	0.00
Crit Moves:	****				****	****	****					
Green Time:	37.4	133	0.0	0.0	95.6	95.6	38.0	0.0	75.4	0.0	0.0	0.0
Volume/Cap:	2.02	0.27	0.00	0.00	0.31	2.02	2.02	0.00	0.66	0.00	0.00	0.00
Delay/Veh:	537.3	7.7	0.0	0.0	23.8	506.7	537.0	0.0	39.1	0.0	0.0	0.0
User DelAdj:	1.00	1.00	1.00	1.00	1.00	1.00	1.00	1.00	1.00	1.00	1.00	1.00
AdjDel/Veh:	537.3	7.7	0.0	0.0	23.8	506.7	537.0	0.0	39.1	0.0	0.0	0.0
LOS by Move:	F	A	A	A	C	F	F	A	D	A	A	A
HCM2k95thQ:	138	13	0	0	17	350	140	0	34	0	0	0

Note: Queue reported is the number of cars per lane.

BART Phase II Extension Project

Level Of Service Computation Report
 2000 HCM Operations (Future Volume Alternative)
 PM - 2025 No Project Conditions

Intersection #5335: CENTRAL EXPWY/DE LA CRUZ BLVD

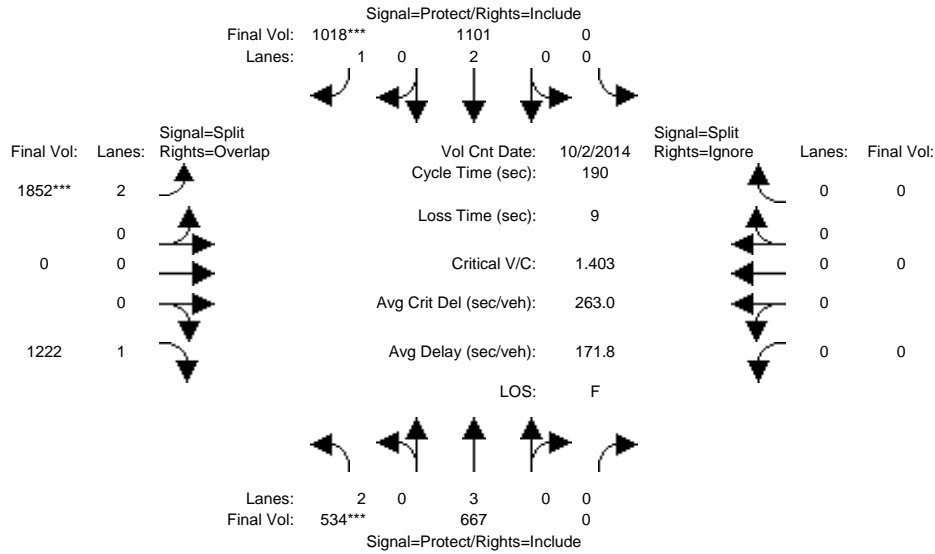

Approach:	North Bound			South Bound			East Bound			West Bound		
Movement:	L	T	R	L	T	R	L	T	R	L	T	R
Min. Green:	19	76	0	0	57	57	114	0	114	0	0	0
Y+R:	4.0	4.0	4.0	4.0	4.0	4.0	4.0	4.0	4.0	4.0	4.0	4.0
Volume Module: >> Count Date: 2 Oct 2014 <<												
Base Vol:	534	667	0	0	1101	1018	2503	0	1222	0	0	0
Growth Adj:	1.00	1.00	1.00	1.00	1.00	1.00	1.00	1.00	1.00	1.00	1.00	1.00
Initial Bse:	534	667	0	0	1101	1018	2503	0	1222	0	0	0
Added Vol:	0	0	0	0	0	0	0	0	0	0	0	0
PasserByVol:	0	0	0	0	0	0	0	0	0	0	0	0
Initial Fut:	534	667	0	0	1101	1018	2503	0	1222	0	0	0
User Adj:	1.00	1.00	1.00	1.00	1.00	1.00	0.74	1.00	1.00	1.00	1.00	0.00
PHF Adj:	1.00	1.00	1.00	1.00	1.00	1.00	1.00	1.00	1.00	1.00	1.00	0.00
PHF Volume:	534	667	0	0	1101	1018	1852	0	1222	0	0	0
Reduct Vol:	0	0	0	0	0	0	0	0	0	0	0	0
Reduced Vol:	534	667	0	0	1101	1018	1852	0	1222	0	0	0
PCE Adj:	1.00	1.00	1.00	1.00	1.00	1.00	1.00	1.00	1.00	1.00	1.00	0.00
MLF Adj:	1.00	1.00	1.00	1.00	1.00	1.00	1.00	1.00	1.00	1.00	1.00	0.00
Final Volume:	534	667	0	0	1101	1018	1852	0	1222	0	0	0
Saturation Flow Module:												
Sat/Lane:	1900	1900	1900	1900	1900	1900	1900	1900	1900	1900	1900	1900
Adjustment:	0.83	1.00	0.92	0.92	1.00	0.92	0.83	1.00	0.92	0.92	1.00	0.92
Lanes:	2.00	3.00	0.00	0.00	2.00	1.00	2.00	0.00	1.00	0.00	0.00	0.00
Final Sat.:	3150	5700	0	0	3800	1750	3150	0	1750	0	0	0
Capacity Analysis Module:												
Vol/Sat:	0.17	0.12	0.00	0.00	0.29	0.58	0.59	0.00	0.70	0.00	0.00	0.00
Crit Moves:	****				****	****	****					
Green Time:	18.1	72.6	0.0	0.0	54.4	54.4	108.8	0.0	127.0	0.0	0.0	0.0
Volume/Cap:	1.78	0.31	0.00	0.00	1.01	2.03	1.03	0.00	1.04	0.00	0.00	0.00
Delay/Veh:	452.2	43.1	0.0	0.0	101	541.9	55.2	0.0	51.3	0.0	0.0	0.0
User DelAdj:	1.00	1.00	1.00	1.00	1.00	1.00	1.00	1.00	1.00	1.00	1.00	1.00
AdjDel/Veh:	452.2	43.1	0.0	0.0	101	541.9	55.2	0.0	51.3	0.0	0.0	0.0
LOS by Move:	F	D	A	A	F	F	E	A	D	A	A	A
HCM2k95thQ:	57	17	0	0	60	199	115	0	137	0	0	0

Note: Queue reported is the number of cars per lane.

BART Phase II Extension Project

Level Of Service Computation Report
 2000 HCM Operations (Future Volume Alternative)
 AM - 2025 No Project Conditions

Intersection #5416: SAN TOMAS EXPWY/EL CAMINO REAL

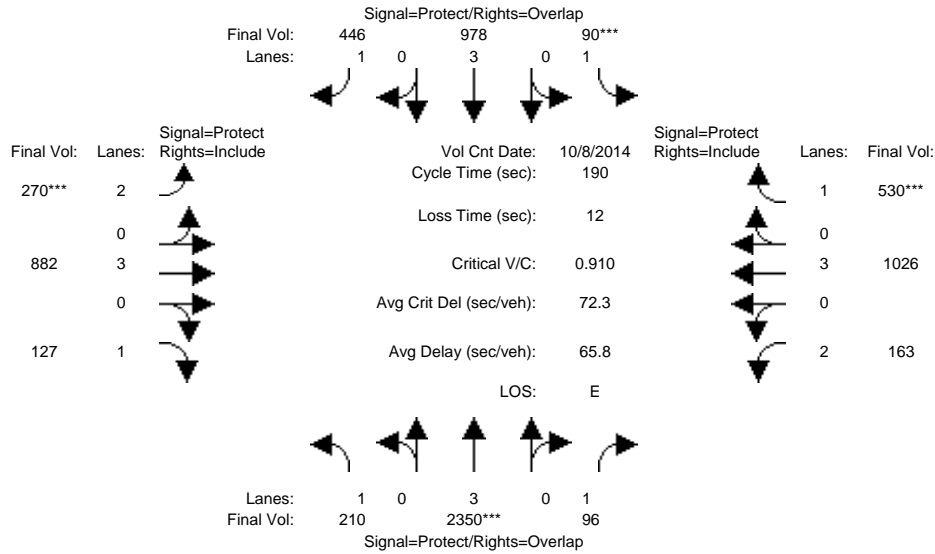

Approach:	North Bound			South Bound			East Bound			West Bound		
	L	T	R	L	T	R	L	T	R	L	T	R
Min. Green:	7	10	10	7	10	10	7	10	10	7	10	10
Y+R:	4.0	4.0	4.0	4.0	4.0	4.0	4.0	4.0	4.0	4.0	4.0	4.0

Volume Module:	>>	Count	Date:	8 Oct 2014	<<											
Base Vol:	210	2798	96	90	1164	446	270	882	127	163	1026	530				
Growth Adj:	1.00	1.00	1.00	1.00	1.00	1.00	1.00	1.00	1.00	1.00	1.00	1.00				
Initial Bse:	210	2798	96	90	1164	446	270	882	127	163	1026	530				
Added Vol:	0	0	0	0	0	0	0	0	0	0	0	0				
PasserByVol:	0	0	0	0	0	0	0	0	0	0	0	0				
Initial Fut:	210	2798	96	90	1164	446	270	882	127	163	1026	530				
User Adj:	1.00	0.84	1.00	1.00	0.84	1.00	1.00	1.00	1.00	1.00	1.00	1.00				
PHF Adj:	1.00	1.00	1.00	1.00	1.00	1.00	1.00	1.00	1.00	1.00	1.00	1.00				
PHF Volume:	210	2350	96	90	978	446	270	882	127	163	1026	530				
Reduct Vol:	0	0	0	0	0	0	0	0	0	0	0	0				
Reduced Vol:	210	2350	96	90	978	446	270	882	127	163	1026	530				
PCE Adj:	1.00	1.00	1.00	1.00	1.00	1.00	1.00	1.00	1.00	1.00	1.00	1.00				
MLF Adj:	1.00	1.00	1.00	1.00	1.00	1.00	1.00	1.00	1.00	1.00	1.00	1.00				
FinalVolume:	210	2350	96	90	978	446	270	882	127	163	1026	530				

Saturation Flow Module:												
Sat/Lane:	1900	1900	1900	1900	1900	1900	1900	1900	1900	1900	1900	1900
Adjustment:	0.92	1.00	0.92	0.92	1.00	0.92	0.83	1.00	0.92	0.83	1.00	0.92
Lanes:	1.00	3.00	1.00	1.00	3.00	1.00	2.00	3.00	1.00	2.00	3.00	1.00
Final Sat.:	1750	5700	1750	1750	5700	1750	3150	5700	1750	3150	5700	1750

Capacity Analysis Module:												
Vol/Sat:	0.12	0.41	0.05	0.05	0.17	0.25	0.09	0.15	0.07	0.05	0.18	0.30
Crit Moves:	****	****	****	****	****	****	****	****	****	****	****	****
Green Time:	39.9	86.1	106.4	10.7	57.0	74.9	17.9	60.8	60.8	20.3	63.2	63.2
Volume/Cap:	0.57	0.91	0.10	0.91	0.57	0.65	0.91	0.48	0.23	0.48	0.54	0.91
Delay/Veh:	70.4	62.7	25.8	154.8	72.7	69.2	115.3	52.2	47.6	81.0	51.9	79.0
User DelAdj:	1.00	1.00	1.00	1.00	1.00	1.00	1.00	1.00	1.00	1.00	1.00	1.00
AdjDel/Veh:	70.4	62.7	25.8	154.8	72.7	69.2	115.3	52.2	47.6	81.0	51.9	79.0
LOS by Move:	E	E	C	F	E	E	F	D	D	F	D	E
HCM2k95thQ:	22	71	7	12	30	42	22	24	11	10	27	54

Note: Queue reported is the number of cars per lane.

BART Phase II Extension Project

Level Of Service Computation Report
 2000 HCM Operations (Future Volume Alternative)
 PM - 2025 No Project Conditions

Intersection #5416: SAN TOMAS EXPWY/EL CAMINO REAL

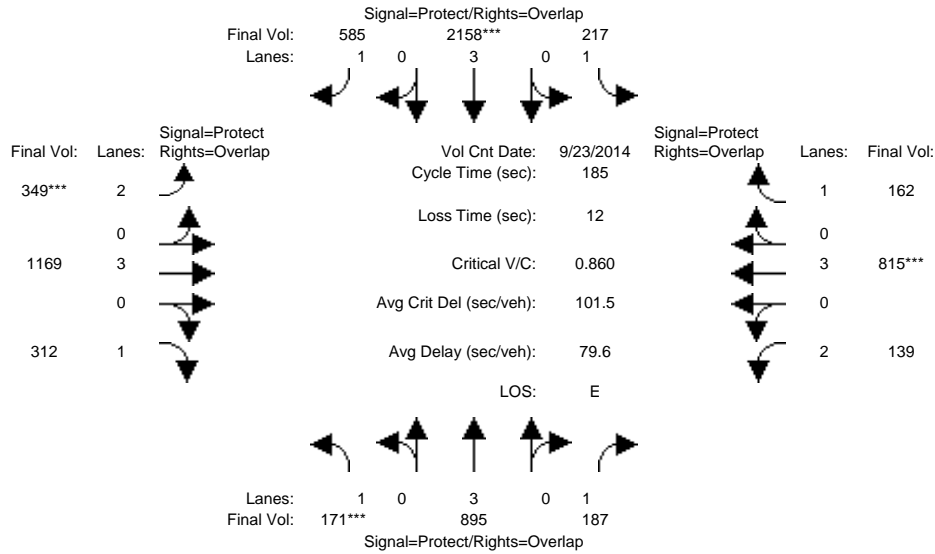

Approach:	North Bound			South Bound			East Bound			West Bound		
Movement:	L	T	R	L	T	R	L	T	R	L	T	R
Min. Green:	12	72	72	33	93	93	39	50	50	29	41	41
Y+R:	4.0	4.0	4.0	4.0	4.0	4.0	4.0	4.0	4.0	4.0	4.0	4.0
Volume Module: >> Count Date: 23 Sep 2014 <<												
Base Vol:	171	1178	187	217	2803	585	349	1169	312	139	815	162
Growth Adj:	1.00	1.00	1.00	1.00	1.00	1.00	1.00	1.00	1.00	1.00	1.00	1.00
Initial Bse:	171	1178	187	217	2803	585	349	1169	312	139	815	162
Added Vol:	0	0	0	0	0	0	0	0	0	0	0	0
PasserByVol:	0	0	0	0	0	0	0	0	0	0	0	0
Initial Fut:	171	1178	187	217	2803	585	349	1169	312	139	815	162
User Adj:	1.00	0.76	1.00	1.00	0.77	1.00	1.00	1.00	1.00	1.00	1.00	1.00
PHF Adj:	1.00	1.00	1.00	1.00	1.00	1.00	1.00	1.00	1.00	1.00	1.00	1.00
PHF Volume:	171	895	187	217	2158	585	349	1169	312	139	815	162
Reduct Vol:	0	0	0	0	0	0	0	0	0	0	0	0
Reduced Vol:	171	895	187	217	2158	585	349	1169	312	139	815	162
PCE Adj:	1.00	1.00	1.00	1.00	1.00	1.00	1.00	1.00	1.00	1.00	1.00	1.00
MLF Adj:	1.00	1.00	1.00	1.00	1.00	1.00	1.00	1.00	1.00	1.00	1.00	1.00
Final Volume:	171	895	187	217	2158	585	349	1169	312	139	815	162
Saturation Flow Module:												
Sat/Lane:	1900	1900	1900	1900	1900	1900	1900	1900	1900	1900	1900	1900
Adjustment:	0.92	1.00	0.92	0.92	0.83	0.92	0.83	1.00	0.92	0.83	1.00	0.92
Lanes:	1.00	3.00	1.00	1.00	3.00	1.00	2.00	3.00	1.00	2.00	3.00	1.00
Final Sat.:	1750	5700	1750	1750	4731	1750	3150	5700	1750	3150	5700	1750
Capacity Analysis Module:												
Vol/Sat:	0.10	0.16	0.11	0.12	0.46	0.33	0.11	0.21	0.18	0.04	0.14	0.09
Crit Moves:	****				****		****				****	
Green Time:	11.3	67.6	95.2	31.0	87.3	124.0	36.6	47.5	58.8	27.6	38.5	69.5
Volume/Cap:	1.60	0.43	0.21	0.74	0.97	0.50	0.56	0.80	0.56	0.30	0.69	0.25
Delay/Veh:	403.6	52.3	32.8	98.0	92.7	38.3	72.4	71.6	57.1	75.0	73.8	42.5
User DelAdj:	1.00	1.00	1.00	1.00	1.00	1.00	1.00	1.00	1.00	1.00	1.00	1.00
AdjDel/Veh:	403.6	52.3	32.8	98.0	92.7	38.3	72.4	71.6	57.1	75.0	73.8	42.5
LOS by Move:	F	D	C	F	F	D	E	E	E	E	E	D
HCM2k95thQ:	33	26	15	25	72	51	21	38	29	8	26	13

Note: Queue reported is the number of cars per lane.

BART Phase II Extension Project

Level Of Service Computation Report
 2000 HCM Operations (Future Volume Alternative)
 AM - 2025 No Project Conditions

Intersection #5444: Lafayette/Lewis

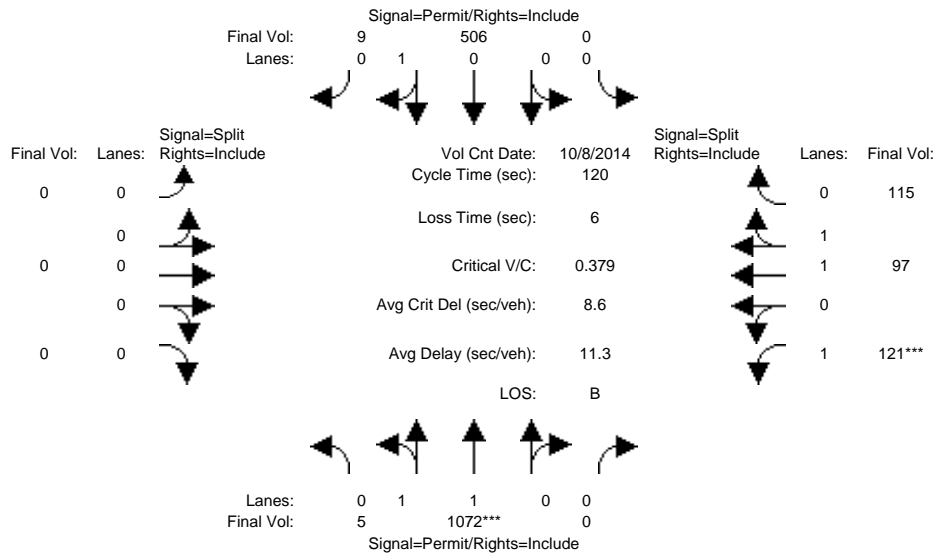

Approach:	North Bound			South Bound			East Bound			West Bound		
	L	T	R	L	T	R	L	T	R	L	T	R
Min. Green:	10	10	0	0	10	10	0	0	0	10	10	10
Y+R:	4.0	4.0	4.0	4.0	4.0	4.0	4.0	4.0	4.0	4.0	4.0	4.0
Volume Module: >> Count Date: 8 Oct 2014 <<												
Base Vol:	5	1072	0	0	506	9	0	0	0	121	97	115
Growth Adj:	1.00	1.00	1.00	1.00	1.00	1.00	1.00	1.00	1.00	1.00	1.00	1.00
Initial Bse:	5	1072	0	0	506	9	0	0	0	121	97	115
Added Vol:	0	0	0	0	0	0	0	0	0	0	0	0
PasserByVol:	0	0	0	0	0	0	0	0	0	0	0	0
Initial Fut:	5	1072	0	0	506	9	0	0	0	121	97	115
User Adj:	1.00	1.00	1.00	1.00	1.00	1.00	1.00	1.00	1.00	1.00	1.00	1.00
PHF Adj:	1.00	1.00	1.00	1.00	1.00	1.00	1.00	1.00	1.00	1.00	1.00	1.00
PHF Volume:	5	1072	0	0	506	9	0	0	0	121	97	115
Reduct Vol:	0	0	0	0	0	0	0	0	0	0	0	0
Reduced Vol:	5	1072	0	0	506	9	0	0	0	121	97	115
PCE Adj:	1.00	1.00	1.00	1.00	1.00	1.00	1.00	1.00	1.00	1.00	1.00	1.00
MLF Adj:	1.00	1.00	1.00	1.00	1.00	1.00	1.00	1.00	1.00	1.00	1.00	1.00
FinalVolume:	5	1072	0	0	506	9	0	0	0	121	97	115
Saturation Flow Module:												
Sat/Lane:	1900	1900	1900	1900	1900	1900	1900	1900	1900	1900	1900	1900
Adjustment:	0.95	0.97	0.92	0.92	0.95	0.95	0.92	1.00	0.92	0.92	1.00	0.92
Lanes:	0.01	1.99	0.00	0.00	0.98	0.02	0.00	0.00	0.00	1.00	1.00	1.00
Final Sat.:	17	3683	0	0	1769	31	0	0	0	1750	1900	1750
Capacity Analysis Module:												
Vol/Sat:	0.29	0.29	0.00	0.00	0.29	0.29	0.00	0.00	0.00	0.07	0.05	0.07
Crit Moves:	****											
Green Time:	92.1	92.1	0.0	0.0	92.1	92.1	0.0	0.0	0.0	21.9	21.9	21.9
Volume/Cap:	0.38	0.38	0.00	0.00	0.37	0.37	0.00	0.00	0.00	0.38	0.28	0.36
Delay/Veh:	4.7	4.7	0.0	0.0	4.7	4.7	0.0	0.0	0.0	43.8	42.5	43.3
User DelAdj:	1.00	1.00	1.00	1.00	1.00	1.00	1.00	1.00	1.00	1.00	1.00	1.00
AdjDel/Veh:	4.7	4.7	0.0	0.0	4.7	4.7	0.0	0.0	0.0	43.8	42.5	43.3
LOS by Move:	A	A	A	A	A	A	A	A	A	D	D	D
HCM2k95thQ:	12	12	0	0	12	12	0	0	0	9	6	8

Note: Queue reported is the number of cars per lane.

BART Phase II Extension Project

Level Of Service Computation Report
 2000 HCM Operations (Future Volume Alternative)
 PM - 2025 No Project Conditions

Intersection #5444: Lafayette/Lewis

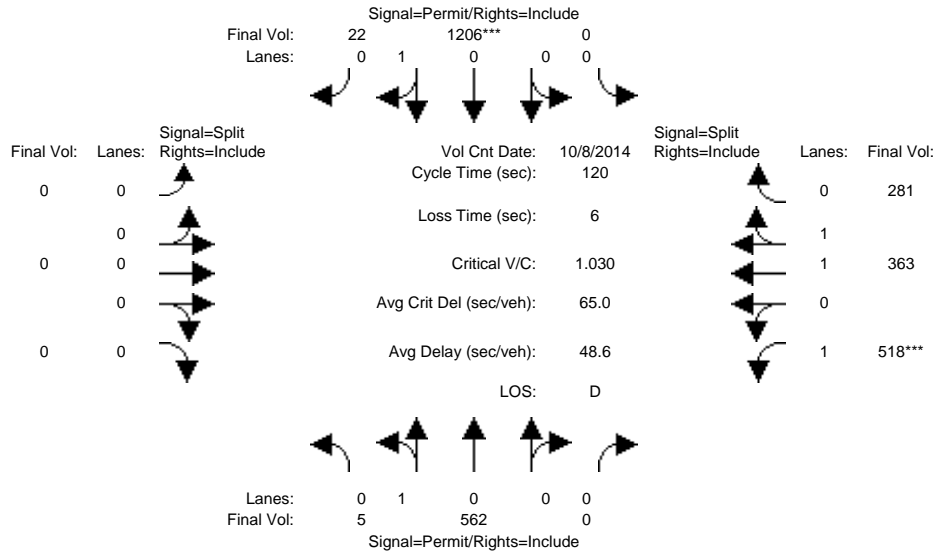

Approach:	North Bound			South Bound			East Bound			West Bound		
	L	T	R	L	T	R	L	T	R	L	T	R
Min. Green:	10	10	0	0	10	10	0	0	0	10	10	10
Y+R:	4.0	4.0	4.0	4.0	4.0	4.0	4.0	4.0	4.0	4.0	4.0	4.0
Volume Module: >> Count Date: 8 Oct 2014 <<												
Base Vol:	5	562	0	0	1206	22	0	0	0	518	363	281
Growth Adj:	1.00	1.00	1.00	1.00	1.00	1.00	1.00	1.00	1.00	1.00	1.00	1.00
Initial Bse:	5	562	0	0	1206	22	0	0	0	518	363	281
Added Vol:	0	0	0	0	0	0	0	0	0	0	0	0
PasserByVol:	0	0	0	0	0	0	0	0	0	0	0	0
Initial Fut:	5	562	0	0	1206	22	0	0	0	518	363	281
User Adj:	1.00	1.00	1.00	1.00	1.00	1.00	1.00	1.00	1.00	1.00	1.00	1.00
PHF Adj:	1.00	1.00	1.00	1.00	1.00	1.00	1.00	1.00	1.00	1.00	1.00	1.00
PHF Volume:	5	562	0	0	1206	22	0	0	0	518	363	281
Reduct Vol:	0	0	0	0	0	0	0	0	0	0	0	0
Reduced Vol:	5	562	0	0	1206	22	0	0	0	518	363	281
PCE Adj:	1.00	1.00	1.00	1.00	1.00	1.00	1.00	1.00	1.00	1.00	1.00	1.00
MLF Adj:	1.00	1.00	1.00	1.00	1.00	1.00	1.00	1.00	1.00	1.00	1.00	1.00
FinalVolume:	5	562	0	0	1206	22	0	0	0	518	363	281
Saturation Flow Module:												
Sat/Lane:	1900	1900	1900	1900	1900	1900	1900	1900	1900	1900	1900	1900
Adjustment:	0.95	0.95	0.92	0.92	0.95	0.95	0.92	1.00	0.92	0.92	0.99	0.95
Lanes:	0.01	0.99	0.00	0.00	0.98	0.02	0.00	0.00	0.00	1.00	1.10	0.90
Final Sat.:	16	1784	0	0	1768	32	0	0	0	1750	2084	1614
Capacity Analysis Module:												
Vol/Sat:	0.32	0.32	0.00	0.00	0.68	0.68	0.00	0.00	0.00	0.30	0.17	0.17
Crit Moves:				****						****		
Green Time:	79.5	79.5	0.0	0.0	79.5	79.5	0.0	0.0	0.0	34.5	34.5	34.5
Volume/Cap:	0.48	0.48	0.00	0.00	1.03	1.03	0.00	0.00	0.00	1.03	0.61	0.61
Delay/Veh:	10.3	10.3	0.0	0.0	54.2	54.2	0.0	0.0	0.0	90.7	37.9	37.9
User DelAdj:	1.00	1.00	1.00	1.00	1.00	1.00	1.00	1.00	1.00	1.00	1.00	1.00
AdjDel/Veh:	10.3	10.3	0.0	0.0	54.2	54.2	0.0	0.0	0.0	90.7	37.9	37.9
LOS by Move:	B	B	A	A	D	D	A	A	A	F	D	D
HCM2k95thQ:	19	19	0	0	85	85	0	0	0	46	20	20

Note: Queue reported is the number of cars per lane.

BART Phase II Extension Project

Level Of Service Computation Report
 2000 HCM Operations (Future Volume Alternative)
 AM - 2025 Project Conditions

Intersection #6: DE LA CRUZ/MARTIN

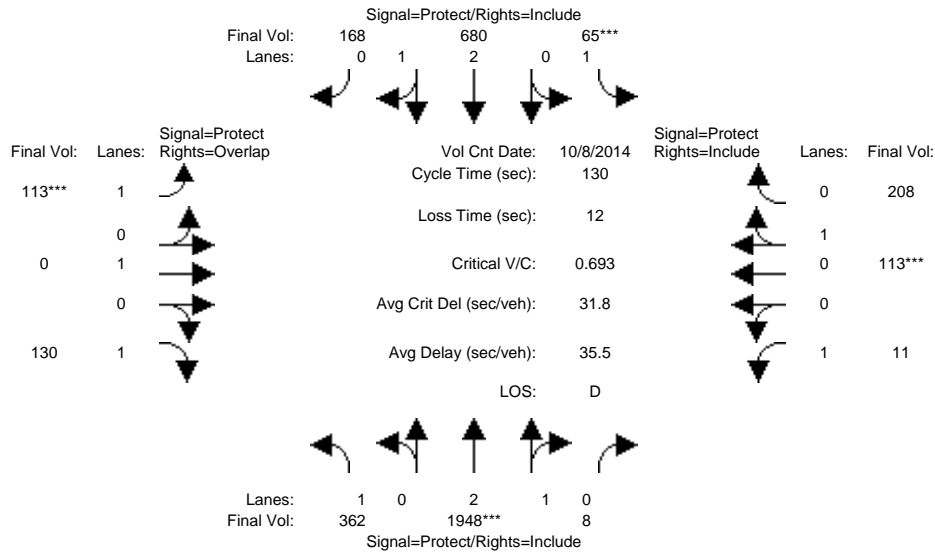

Approach:	North Bound			South Bound			East Bound			West Bound		
	L	T	R	L	T	R	L	T	R	L	T	R
Min. Green:	7	10	10	7	10	10	7	10	10	7	10	10
Y+R:	4.0	4.0	4.0	4.0	4.0	4.0	4.0	4.0	4.0	4.0	4.0	4.0

Volume Module:	>>	Count	Date:	8 Oct 2014	<<							
Base Vol:	362	1948	8	65	680	168	113	0	130	11	113	208
Growth Adj:	1.00	1.00	1.00	1.00	1.00	1.00	1.00	1.00	1.00	1.00	1.00	1.00
Initial Bse:	362	1948	8	65	680	168	113	0	130	11	113	208
Added Vol:	0	0	0	0	0	0	0	0	0	0	0	0
PasserByVol:	0	0	0	0	0	0	0	0	0	0	0	0
Initial Fut:	362	1948	8	65	680	168	113	0	130	11	113	208
User Adj:	1.00	1.00	1.00	1.00	1.00	1.00	1.00	1.00	1.00	1.00	1.00	1.00
PHF Adj:	1.00	1.00	1.00	1.00	1.00	1.00	1.00	1.00	1.00	1.00	1.00	1.00
PHF Volume:	362	1948	8	65	680	168	113	0	130	11	113	208
Reduct Vol:	0	0	0	0	0	0	0	0	0	0	0	0
Reduced Vol:	362	1948	8	65	680	168	113	0	130	11	113	208
PCE Adj:	1.00	1.00	1.00	1.00	1.00	1.00	1.00	1.00	1.00	1.00	1.00	1.00
MLF Adj:	1.00	1.00	1.00	1.00	1.00	1.00	1.00	1.00	1.00	1.00	1.00	1.00
Final Volume:	362	1948	8	65	680	168	113	0	130	11	113	208

Saturation Flow Module:												
Sat/Lane:	1900	1900	1900	1900	1900	1900	1900	1900	1900	1900	1900	1900
Adjustment:	0.92	0.98	0.95	0.92	0.99	0.95	0.92	1.00	0.92	0.92	0.95	0.95
Lanes:	1.00	2.99	0.01	1.00	2.38	0.62	1.00	1.00	1.00	1.00	0.35	0.65
Final Sat.:	1750	5577	23	1750	4489	1109	1750	1900	1750	1750	634	1166

Capacity Analysis Module:												
Vol/Sat:	0.21	0.35	0.35	0.04	0.15	0.15	0.06	0.00	0.07	0.01	0.18	0.18
Crit Moves:	****			****			****			****		
Green Time:	41.8	65.5	65.5	7.0	30.6	30.6	12.1	0.0	53.9	45.5	33.4	33.4
Volume/Cap:	0.64	0.69	0.69	0.69	0.64	0.64	0.69	0.00	0.18	0.02	0.69	0.69
Delay/Veh:	40.2	25.4	25.4	79.9	45.8	45.8	69.3	0.0	24.2	27.6	48.2	48.2
User DelAdj:	1.00	1.00	1.00	1.00	1.00	1.00	1.00	1.00	1.00	1.00	1.00	1.00
AdjDel/Veh:	40.2	25.4	25.4	79.9	45.8	45.8	69.3	0.0	24.2	27.6	48.2	48.2
LOS by Move:	D	C	C	E	D	D	E	A	C	C	D	D
HCM2k95thQ:	24	34	34	6	19	19	10	0	7	1	23	23

Note: Queue reported is the number of cars per lane.

BART Phase II Extension Project

Level Of Service Computation Report
2000 HCM Operations (Future Volume Alternative)
PM - 2025 Project Conditions

Intersection #6: DE LA CRUZ/MARTIN

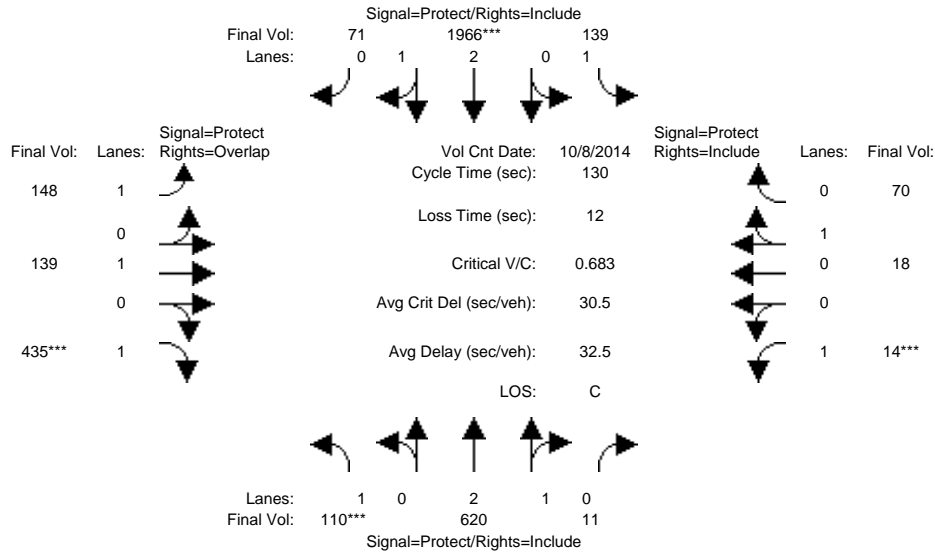

Approach:	North Bound			South Bound			East Bound			West Bound		
	L	T	R	L	T	R	L	T	R	L	T	R
Min. Green:	7	10	10	7	10	10	7	10	10	7	10	10
Y+R:	4.0	4.0	4.0	4.0	4.0	4.0	4.0	4.0	4.0	4.0	4.0	4.0
Volume Module: >> Count Date: 8 Oct 2014 <<												
Base Vol:	110	620	11	139	1966	71	148	139	435	14	18	70
Growth Adj:	1.00	1.00	1.00	1.00	1.00	1.00	1.00	1.00	1.00	1.00	1.00	1.00
Initial Bse:	110	620	11	139	1966	71	148	139	435	14	18	70
Added Vol:	0	0	0	0	0	0	0	0	0	0	0	0
PasserByVol:	0	0	0	0	0	0	0	0	0	0	0	0
Initial Fut:	110	620	11	139	1966	71	148	139	435	14	18	70
User Adj:	1.00	1.00	1.00	1.00	1.00	1.00	1.00	1.00	1.00	1.00	1.00	1.00
PHF Adj:	1.00	1.00	1.00	1.00	1.00	1.00	1.00	1.00	1.00	1.00	1.00	1.00
PHF Volume:	110	620	11	139	1966	71	148	139	435	14	18	70
Reduct Vol:	0	0	0	0	0	0	0	0	0	0	0	0
Reduced Vol:	110	620	11	139	1966	71	148	139	435	14	18	70
PCE Adj:	1.00	1.00	1.00	1.00	1.00	1.00	1.00	1.00	1.00	1.00	1.00	1.00
MLF Adj:	1.00	1.00	1.00	1.00	1.00	1.00	1.00	1.00	1.00	1.00	1.00	1.00
FinalVolume:	110	620	11	139	1966	71	148	139	435	14	18	70
Saturation Flow Module:												
Sat/Lane:	1900	1900	1900	1900	1900	1900	1900	1900	1900	1900	1900	1900
Adjustment:	0.92	0.98	0.95	0.92	0.98	0.95	0.92	1.00	0.92	0.92	0.95	0.95
Lanes:	1.00	2.95	0.05	1.00	2.89	0.11	1.00	1.00	1.00	1.00	0.20	0.80
Final Sat.:	1750	5502	98	1750	5405	195	1750	1900	1750	1750	368	1432
Capacity Analysis Module:												
Vol/Sat:	0.06	0.11	0.11	0.08	0.36	0.36	0.08	0.07	0.25	0.01	0.05	0.05
Crit Moves:	****			****			****		****	****		
Green Time:	11.4	45.4	45.4	32.0	65.9	65.9	21.3	33.7	45.1	7.0	19.4	19.4
Volume/Cap:	0.72	0.32	0.32	0.32	0.72	0.72	0.52	0.28	0.72	0.15	0.33	0.33
Delay/Veh:	72.7	31.1	31.1	40.6	25.7	25.7	51.3	38.8	41.0	59.4	50.2	50.2
User DelAdj:	1.00	1.00	1.00	1.00	1.00	1.00	1.00	1.00	1.00	1.00	1.00	1.00
AdjDel/Veh:	72.7	31.1	31.1	40.6	25.7	25.7	51.3	38.8	41.0	59.4	50.2	50.2
LOS by Move:	E	C	C	D	C	C	D	D	D	E	D	D
HCM2k95thQ:	10	12	12	9	36	36	11	8	29	1	7	7

Note: Queue reported is the number of cars per lane.

BART Phase II Extension Project

Level Of Service Computation Report
 2000 HCM Operations (Future Volume Alternative)
 AM - 2025 Project Conditions

Intersection #7: LAFAYETTE/REED

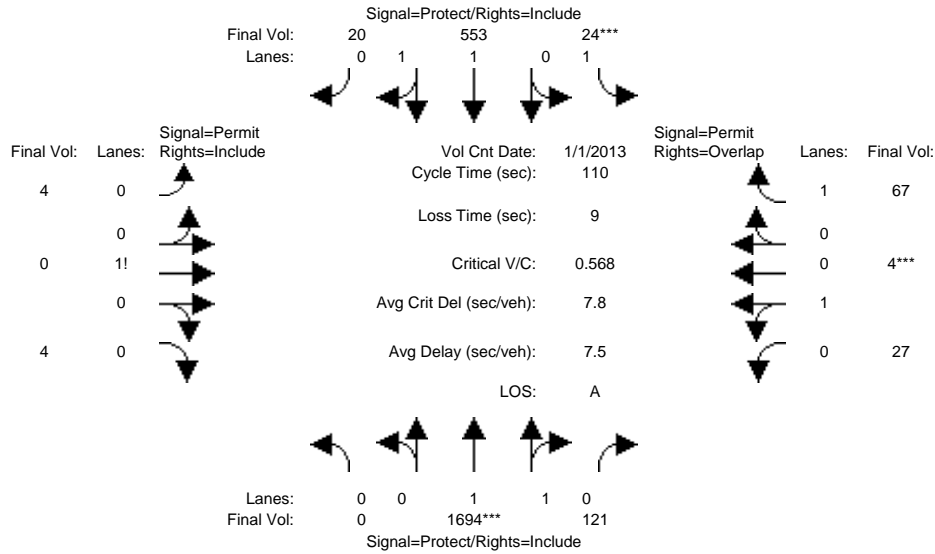

Approach:	North Bound			South Bound			East Bound			West Bound		
	L	T	R	L	T	R	L	T	R	L	T	R
Min. Green:	7	10	10	7	10	10	10	10	10	10	10	10
Y+R:	4.0	4.0	4.0	4.0	4.0	4.0	4.0	4.0	4.0	4.0	4.0	4.0
Volume Module: >> Count Date: 1 Jan 2013 <<												
Base Vol:	0	1694	121	24	553	20	4	0	4	27	4	67
Growth Adj:	1.00	1.00	1.00	1.00	1.00	1.00	1.00	1.00	1.00	1.00	1.00	1.00
Initial Bse:	0	1694	121	24	553	20	4	0	4	27	4	67
Added Vol:	0	0	0	0	0	0	0	0	0	0	0	0
PasserByVol:	0	0	0	0	0	0	0	0	0	0	0	0
Initial Fut:	0	1694	121	24	553	20	4	0	4	27	4	67
User Adj:	1.00	1.00	1.00	1.00	1.00	1.00	1.00	1.00	1.00	1.00	1.00	1.00
PHF Adj:	1.00	1.00	1.00	1.00	1.00	1.00	1.00	1.00	1.00	1.00	1.00	1.00
PHF Volume:	0	1694	121	24	553	20	4	0	4	27	4	67
Reduct Vol:	0	0	0	0	0	0	0	0	0	0	0	0
Reduced Vol:	0	1694	121	24	553	20	4	0	4	27	4	67
PCE Adj:	1.00	1.00	1.00	1.00	1.00	1.00	1.00	1.00	1.00	1.00	1.00	1.00
MLF Adj:	1.00	1.00	1.00	1.00	1.00	1.00	1.00	1.00	1.00	1.00	1.00	1.00
FinalVolume:	0	1694	121	24	553	20	4	0	4	27	4	67
Saturation Flow Module:												
Sat/Lane:	1900	1900	1900	1900	1900	1900	1900	1900	1900	1900	1900	1900
Adjustment:	0.92	0.98	0.95	0.92	0.97	0.95	0.92	0.92	0.92	0.95	0.95	0.92
Lanes:	0.00	1.86	0.14	1.00	1.93	0.07	0.50	0.00	0.50	0.87	0.13	1.00
Final Sat.:	0	3453	247	1750	3571	129	875	0	875	1568	232	1750
Capacity Analysis Module:												
Vol/Sat:	0.00	0.49	0.49	0.01	0.15	0.15	0.00	0.00	0.00	0.02	0.02	0.04
Crit Moves:	****			****			****			****		
Green Time:	0.0	84.0	84.0	7.0	91.0	91.0	10.0	0.0	10.0	10.0	10.0	17.0
Volume/Cap:	0.00	0.64	0.64	0.22	0.19	0.19	0.05	0.00	0.05	0.19	0.19	0.25
Delay/Veh:	0.0	6.5	6.5	49.9	2.0	2.0	45.8	0.0	45.8	46.8	46.8	41.4
User DelAdj:	1.00	1.00	1.00	1.00	1.00	1.00	1.00	1.00	1.00	1.00	1.00	1.00
AdjDel/Veh:	0.0	6.5	6.5	49.9	2.0	2.0	45.8	0.0	45.8	46.8	46.8	41.4
LOS by Move:	A	A	A	D	A	A	D	A	D	D	D	D
HCM2k95thQ:	0	26	26	2	4	4	1	0	1	2	2	4

Note: Queue reported is the number of cars per lane.

BART Phase II Extension Project

Level Of Service Computation Report
2000 HCM Operations (Future Volume Alternative)
PM - 2025 Project Conditions

Intersection #7: LAFAYETTE/REED

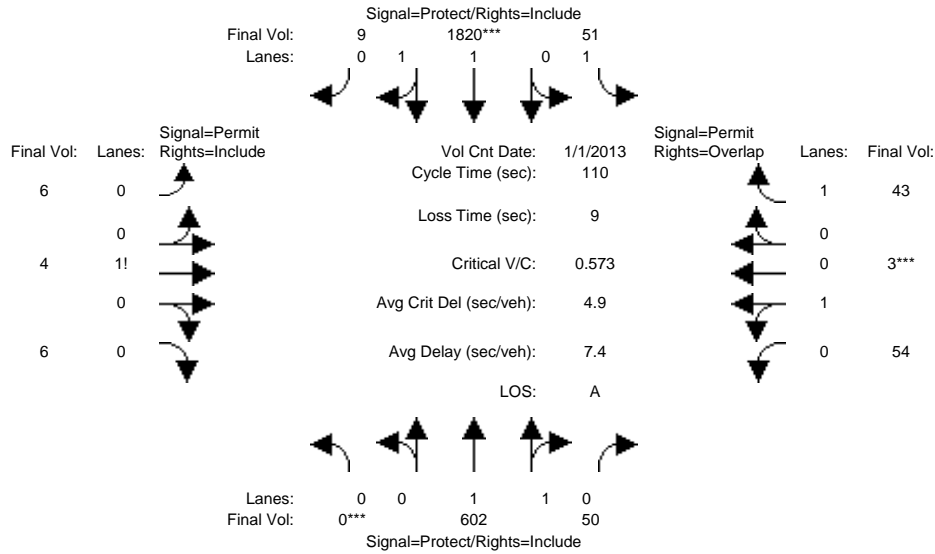

Approach:	North Bound			South Bound			East Bound			West Bound		
Movement:	L	T	R	L	T	R	L	T	R	L	T	R
Min. Green:	7	10	10	7	10	10	10	10	10	10	10	10
Y+R:	4.0	4.0	4.0	4.0	4.0	4.0	4.0	4.0	4.0	4.0	4.0	4.0
Volume Module: >> Count Date: 1 Jan 2013 <<												
Base Vol:	0	602	50	51	1820	9	6	4	6	54	3	43
Growth Adj:	1.00	1.00	1.00	1.00	1.00	1.00	1.00	1.00	1.00	1.00	1.00	1.00
Initial Bse:	0	602	50	51	1820	9	6	4	6	54	3	43
Added Vol:	0	0	0	0	0	0	0	0	0	0	0	0
PasserByVol:	0	0	0	0	0	0	0	0	0	0	0	0
Initial Fut:	0	602	50	51	1820	9	6	4	6	54	3	43
User Adj:	1.00	1.00	1.00	1.00	1.00	1.00	1.00	1.00	1.00	1.00	1.00	1.00
PHF Adj:	1.00	1.00	1.00	1.00	1.00	1.00	1.00	1.00	1.00	1.00	1.00	1.00
PHF Volume:	0	602	50	51	1820	9	6	4	6	54	3	43
Reduct Vol:	0	0	0	0	0	0	0	0	0	0	0	0
Reduced Vol:	0	602	50	51	1820	9	6	4	6	54	3	43
PCE Adj:	1.00	1.00	1.00	1.00	1.00	1.00	1.00	1.00	1.00	1.00	1.00	1.00
MLF Adj:	1.00	1.00	1.00	1.00	1.00	1.00	1.00	1.00	1.00	1.00	1.00	1.00
FinalVolume:	0	602	50	51	1820	9	6	4	6	54	3	43
Saturation Flow Module:												
Sat/Lane:	1900	1900	1900	1900	1900	1900	1900	1900	1900	1900	1900	1900
Adjustment:	0.92	0.98	0.95	0.92	0.97	0.95	0.92	0.92	0.92	0.95	0.95	0.92
Lanes:	0.00	1.84	0.16	1.00	1.99	0.01	0.37	0.25	0.38	0.95	0.05	1.00
Final Sat.:	0	3416	284	1750	3682	18	656	438	656	1705	95	1750
Capacity Analysis Module:												
Vol/Sat:	0.00	0.18	0.18	0.03	0.49	0.49	0.01	0.01	0.01	0.03	0.03	0.02
Crit Moves:	****				****						****	
Green Time:	0.0	66.9	66.9	24.1	91.0	91.0	10.0	10.0	10.0	10.0	10.0	34.1
Volume/Cap:	0.00	0.29	0.29	0.13	0.60	0.60	0.10	0.10	0.10	0.35	0.35	0.08
Delay/Veh:	0.0	10.3	10.3	34.7	3.6	3.6	46.2	46.2	46.2	48.2	48.2	26.9
User DelAdj:	1.00	1.00	1.00	1.00	1.00	1.00	1.00	1.00	1.00	1.00	1.00	1.00
AdjDel/Veh:	0.0	10.3	10.3	34.7	3.6	3.6	46.2	46.2	46.2	48.2	48.2	26.9
LOS by Move:	A	B	B	C	A	A	D	D	D	D	D	C
HCM2k95thQ:	0	10	10	3	21	21	1	1	1	4	4	2

Note: Queue reported is the number of cars per lane.

BART Phase II Extension Project

Level Of Service Computation Report
2000 HCM Operations (Future Volume Alternative)
AM - 2025 Project Conditions

Intersection #9: Coleman/Brokaw

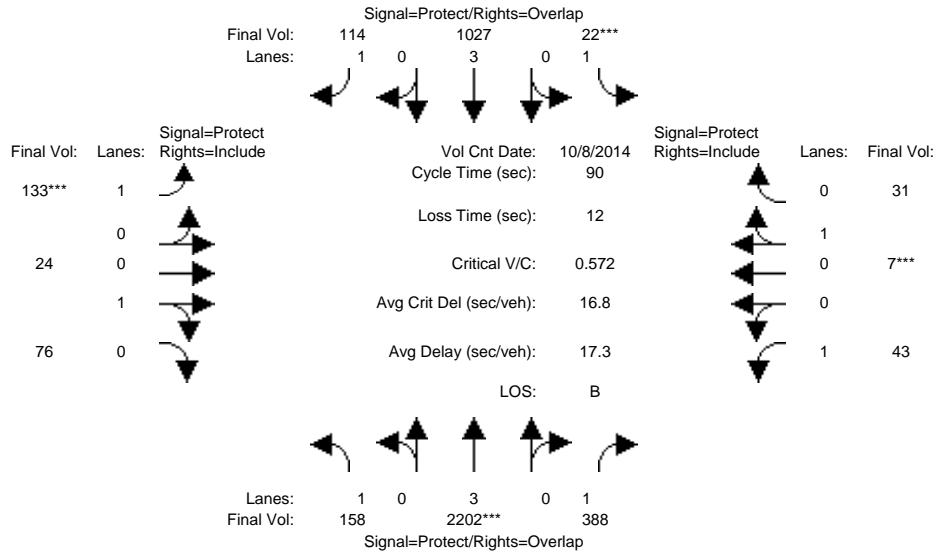

Approach:	North Bound			South Bound			East Bound			West Bound		
	L	T	R	L	T	R	L	T	R	L	T	R
Min. Green:	7	10	10	7	10	10	7	10	10	7	10	10
Y+R:	4.0	4.0	4.0	4.0	4.0	4.0	4.0	4.0	4.0	4.0	4.0	4.0
Volume Module: >> Count Date: 8 Oct 2014 <<												
Base Vol:	158	2202	388	22	1027	114	133	24	76	43	7	31
Growth Adj:	1.00	1.00	1.00	1.00	1.00	1.00	1.00	1.00	1.00	1.00	1.00	1.00
Initial Bse:	158	2202	388	22	1027	114	133	24	76	43	7	31
Added Vol:	0	0	0	0	0	0	0	0	0	0	0	0
PasserByVol:	0	0	0	0	0	0	0	0	0	0	0	0
Initial Fut:	158	2202	388	22	1027	114	133	24	76	43	7	31
User Adj:	1.00	1.00	1.00	1.00	1.00	1.00	1.00	1.00	1.00	1.00	1.00	1.00
PHF Adj:	1.00	1.00	1.00	1.00	1.00	1.00	1.00	1.00	1.00	1.00	1.00	1.00
PHF Volume:	158	2202	388	22	1027	114	133	24	76	43	7	31
Reduct Vol:	0	0	0	0	0	0	0	0	0	0	0	0
Reduced Vol:	158	2202	388	22	1027	114	133	24	76	43	7	31
PCE Adj:	1.00	1.00	1.00	1.00	1.00	1.00	1.00	1.00	1.00	1.00	1.00	1.00
MLF Adj:	1.00	1.00	1.00	1.00	1.00	1.00	1.00	1.00	1.00	1.00	1.00	1.00
FinalVolume:	158	2202	388	22	1027	114	133	24	76	43	7	31
Saturation Flow Module:												
Sat/Lane:	1900	1900	1900	1900	1900	1900	1900	1900	1900	1900	1900	1900
Adjustment:	0.92	1.00	0.92	0.92	1.00	0.92	0.92	0.95	0.95	0.92	0.95	0.95
Lanes:	1.00	3.00	1.00	1.00	3.00	1.00	1.00	0.24	0.76	1.00	0.18	0.82
Final Sat.:	1750	5700	1750	1750	5700	1750	1750	432	1368	1750	332	1468
Capacity Analysis Module:												
Vol/Sat:	0.09	0.39	0.22	0.01	0.18	0.07	0.08	0.06	0.06	0.02	0.02	0.02
Crit Moves:	****			****			****			****		
Green Time:	19.4	51.0	59.2	7.0	38.6	48.6	10.0	11.8	11.8	8.2	10.0	10.0
Volume/Cap:	0.42	0.68	0.34	0.16	0.42	0.12	0.68	0.42	0.42	0.27	0.19	0.19
Delay/Veh:	31.2	14.4	6.9	39.3	18.0	10.2	48.0	37.2	37.2	39.0	36.8	36.8
User DelAdj:	1.00	1.00	1.00	1.00	1.00	1.00	1.00	1.00	1.00	1.00	1.00	1.00
AdjDel/Veh:	31.2	14.4	6.9	39.3	18.0	10.2	48.0	37.2	37.2	39.0	36.8	36.8
LOS by Move:	C	B	A	D	B	B	D	D	D	D	D	D
HCM2k95thQ:	7	24	9	1	12	3	10	6	6	2	2	2

Note: Queue reported is the number of cars per lane.

BART Phase II Extension Project

Level Of Service Computation Report
2000 HCM Operations (Future Volume Alternative)
PM - 2025 Project Conditions

Intersection #9: Coleman/Brokaw

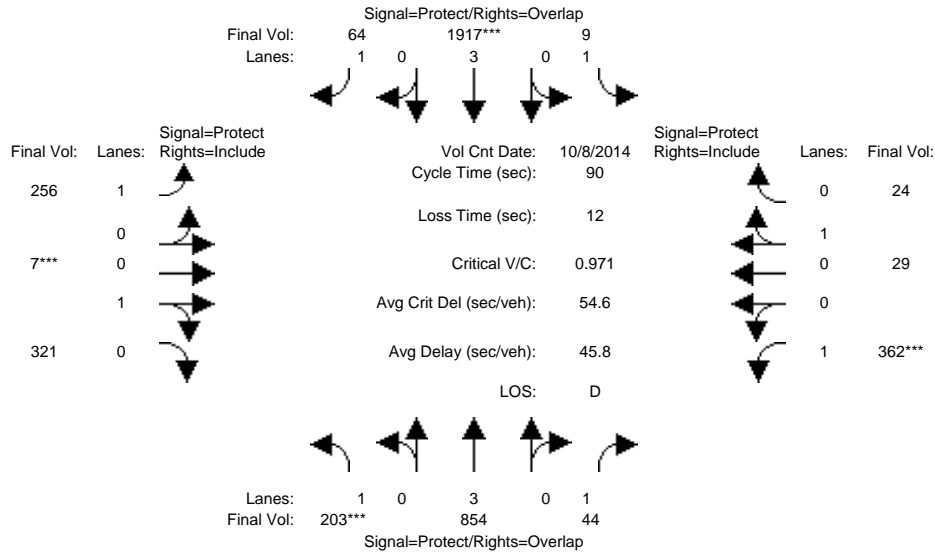

Approach:	North Bound			South Bound			East Bound			West Bound		
	L	T	R	L	T	R	L	T	R	L	T	R
Min. Green:	7	10	10	7	10	10	7	10	10	7	10	10
Y+R:	4.0	4.0	4.0	4.0	4.0	4.0	4.0	4.0	4.0	4.0	4.0	4.0
Volume Module: >> Count Date: 8 Oct 2014 <<												
Base Vol:	203	854	44	9	1917	64	256	7	321	362	29	24
Growth Adj:	1.00	1.00	1.00	1.00	1.00	1.00	1.00	1.00	1.00	1.00	1.00	1.00
Initial Bse:	203	854	44	9	1917	64	256	7	321	362	29	24
Added Vol:	0	0	0	0	0	0	0	0	0	0	0	0
PasserByVol:	0	0	0	0	0	0	0	0	0	0	0	0
Initial Fut:	203	854	44	9	1917	64	256	7	321	362	29	24
User Adj:	1.00	1.00	1.00	1.00	1.00	1.00	1.00	1.00	1.00	1.00	1.00	1.00
PHF Adj:	1.00	1.00	1.00	1.00	1.00	1.00	1.00	1.00	1.00	1.00	1.00	1.00
PHF Volume:	203	854	44	9	1917	64	256	7	321	362	29	24
Reduct Vol:	0	0	0	0	0	0	0	0	0	0	0	0
Reduced Vol:	203	854	44	9	1917	64	256	7	321	362	29	24
PCE Adj:	1.00	1.00	1.00	1.00	1.00	1.00	1.00	1.00	1.00	1.00	1.00	1.00
MLF Adj:	1.00	1.00	1.00	1.00	1.00	1.00	1.00	1.00	1.00	1.00	1.00	1.00
FinalVolume:	203	854	44	9	1917	64	256	7	321	362	29	24
Saturation Flow Module:												
Sat/Lane:	1900	1900	1900	1900	1900	1900	1900	1900	1900	1900	1900	1900
Adjustment:	0.92	1.00	0.92	0.92	1.00	0.92	0.92	0.95	0.95	0.92	0.95	0.95
Lanes:	1.00	3.00	1.00	1.00	3.00	1.00	1.00	0.02	0.98	1.00	0.55	0.45
Final Sat.:	1750	5700	1750	1750	5700	1750	1750	38	1762	1750	985	815
Capacity Analysis Module:												
Vol/Sat:	0.12	0.15	0.03	0.01	0.34	0.04	0.15	0.18	0.18	0.21	0.03	0.03
Crit Moves:	****				****			****			****	
Green Time:	10.8	27.6	46.8	14.3	31.2	51.7	20.5	16.9	16.9	19.2	15.6	15.6
Volume/Cap:	0.97	0.49	0.05	0.03	0.97	0.06	0.64	0.97	0.97	0.97	0.17	0.17
Delay/Veh:	93.1	25.7	10.7	32.0	43.0	8.5	35.0	77.3	77.3	73.9	32.0	32.0
User DelAdj:	1.00	1.00	1.00	1.00	1.00	1.00	1.00	1.00	1.00	1.00	1.00	1.00
AdjDel/Veh:	93.1	25.7	10.7	32.0	43.0	8.5	35.0	77.3	77.3	73.9	32.0	32.0
LOS by Move:	F	C	B	C	D	A	C	E	E	E	C	C
HCM2k95thQ:	15	12	1	0	36	2	15	26	26	24	3	3

Note: Queue reported is the number of cars per lane.

BART Phase II Extension Project

Level Of Service Computation Report
2000 HCM Operations (Future Volume Alternative)
AM - 2025 Project Conditions

Intersection #106: Benton/EI Camino Real

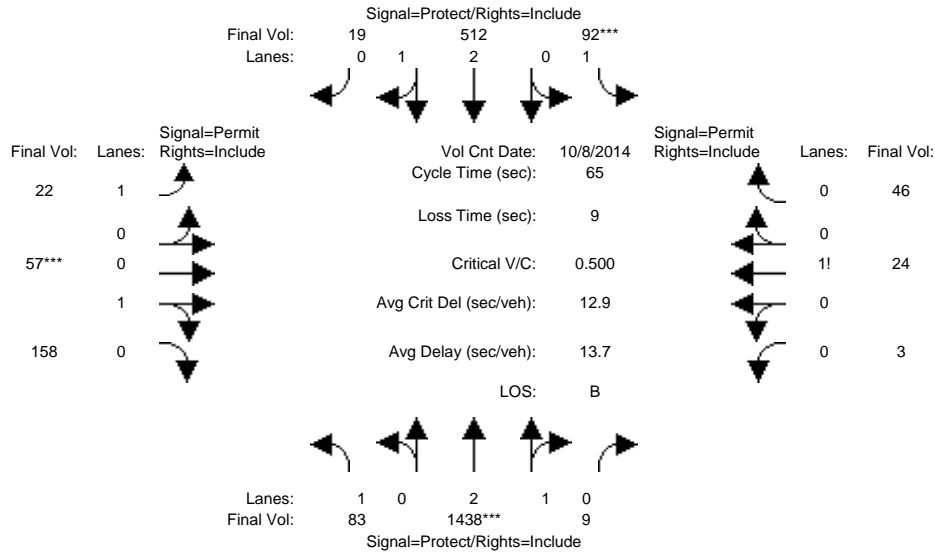

Approach:	North Bound			South Bound			East Bound			West Bound		
	L	T	R	L	T	R	L	T	R	L	T	R
Min. Green:	7	10	10	7	10	10	10	10	10	10	10	10
Y+R:	4.0	4.0	4.0	4.0	4.0	4.0	4.0	4.0	4.0	4.0	4.0	4.0
Volume Module: >> Count Date: 8 Oct 2014 <<												
Base Vol:	83	1438	9	92	512	19	22	57	158	3	24	46
Growth Adj:	1.00	1.00	1.00	1.00	1.00	1.00	1.00	1.00	1.00	1.00	1.00	1.00
Initial Bse:	83	1438	9	92	512	19	22	57	158	3	24	46
Added Vol:	0	0	0	0	0	0	0	0	0	0	0	0
PasserByVol:	0	0	0	0	0	0	0	0	0	0	0	0
Initial Fut:	83	1438	9	92	512	19	22	57	158	3	24	46
User Adj:	1.00	1.00	1.00	1.00	1.00	1.00	1.00	1.00	1.00	1.00	1.00	1.00
PHF Adj:	1.00	1.00	1.00	1.00	1.00	1.00	1.00	1.00	1.00	1.00	1.00	1.00
PHF Volume:	83	1438	9	92	512	19	22	57	158	3	24	46
Reduct Vol:	0	0	0	0	0	0	0	0	0	0	0	0
Reduced Vol:	83	1438	9	92	512	19	22	57	158	3	24	46
PCE Adj:	1.00	1.00	1.00	1.00	1.00	1.00	1.00	1.00	1.00	1.00	1.00	1.00
MLF Adj:	1.00	1.00	1.00	1.00	1.00	1.00	1.00	1.00	1.00	1.00	1.00	1.00
Final Volume:	83	1438	9	92	512	19	22	57	158	3	24	46
Saturation Flow Module:												
Sat/Lane:	1900	1900	1900	1900	1900	1900	1900	1900	1900	1900	1900	1900
Adjustment:	0.92	0.98	0.95	0.92	0.98	0.95	0.92	0.95	0.95	0.92	0.92	0.92
Lanes:	1.00	2.98	0.02	1.00	2.89	0.11	1.00	0.27	0.73	0.04	0.33	0.63
Final Sat.:	1750	5565	35	1750	5399	200	1750	477	1323	72	575	1103
Capacity Analysis Module:												
Vol/Sat:	0.05	0.26	0.26	0.05	0.09	0.09	0.01	0.12	0.12	0.04	0.04	0.04
Crit Moves:	****			****			****					
Green Time:	16.7	33.5	33.5	7.0	23.8	23.8	15.5	15.5	15.5	15.5	15.5	15.5
Volume/Cap:	0.18	0.50	0.50	0.49	0.26	0.26	0.05	0.50	0.50	0.18	0.18	0.18
Delay/Veh:	19.1	10.4	10.4	29.3	14.5	14.5	19.1	22.3	22.3	19.9	19.9	19.9
User DelAdj:	1.00	1.00	1.00	1.00	1.00	1.00	1.00	1.00	1.00	1.00	1.00	1.00
AdjDel/Veh:	19.1	10.4	10.4	29.3	14.5	14.5	19.1	22.3	22.3	19.9	19.9	19.9
LOS by Move:	B	B	B	C	B	B	B	C	C	B	B	B
HCM2k95thQ:	3	12	12	4	5	5	1	8	8	3	3	3

Note: Queue reported is the number of cars per lane.

BART Phase II Extension Project

Level Of Service Computation Report
2000 HCM Operations (Future Volume Alternative)
PM - 2025 Project Conditions

Intersection #106: Benton/EI Camino Real

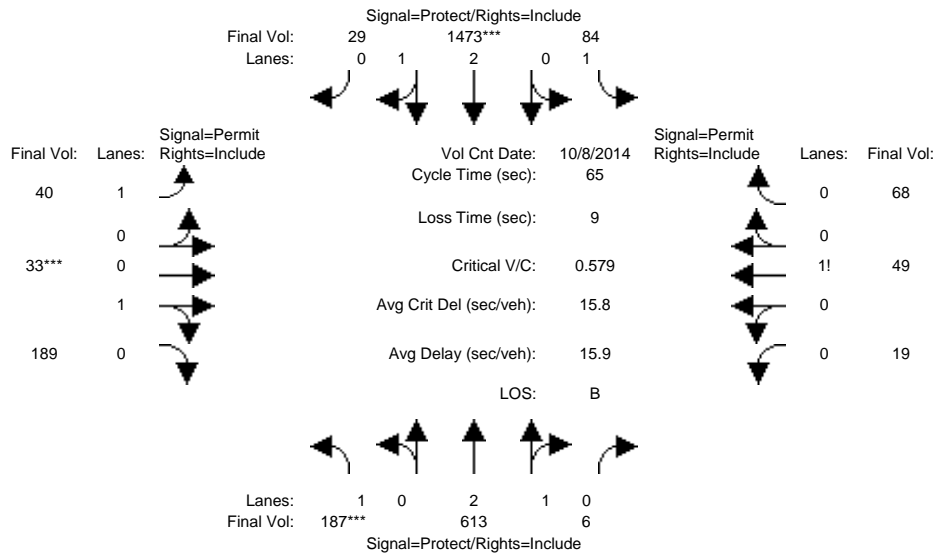

Approach:	North Bound			South Bound			East Bound			West Bound		
	L	T	R	L	T	R	L	T	R	L	T	R
Min. Green:	7	10	10	7	10	10	10	10	10	10	10	10
Y+R:	4.0	4.0	4.0	4.0	4.0	4.0	4.0	4.0	4.0	4.0	4.0	4.0

Volume Module: >> Count Date: 8 Oct 2014 <<

Base Vol:	187	613	6	84	1473	29	40	33	189	19	49	68
Growth Adj:	1.00	1.00	1.00	1.00	1.00	1.00	1.00	1.00	1.00	1.00	1.00	1.00
Initial Bse:	187	613	6	84	1473	29	40	33	189	19	49	68
Added Vol:	0	0	0	0	0	0	0	0	0	0	0	0
PasserByVol:	0	0	0	0	0	0	0	0	0	0	0	0
Initial Fut:	187	613	6	84	1473	29	40	33	189	19	49	68
User Adj:	1.00	1.00	1.00	1.00	1.00	1.00	1.00	1.00	1.00	1.00	1.00	1.00
PHF Adj:	1.00	1.00	1.00	1.00	1.00	1.00	1.00	1.00	1.00	1.00	1.00	1.00
PHF Volume:	187	613	6	84	1473	29	40	33	189	19	49	68
Reduct Vol:	0	0	0	0	0	0	0	0	0	0	0	0
Reduced Vol:	187	613	6	84	1473	29	40	33	189	19	49	68
PCE Adj:	1.00	1.00	1.00	1.00	1.00	1.00	1.00	1.00	1.00	1.00	1.00	1.00
MLF Adj:	1.00	1.00	1.00	1.00	1.00	1.00	1.00	1.00	1.00	1.00	1.00	1.00
FinalVolume:	187	613	6	84	1473	29	40	33	189	19	49	68

Saturation Flow Module:

Sat/Lane:	1900	1900	1900	1900	1900	1900	1900	1900	1900	1900	1900	1900
Adjustment:	0.92	0.98	0.95	0.92	0.98	0.95	0.92	0.95	0.95	0.92	0.92	0.92
Lanes:	1.00	2.97	0.03	1.00	2.94	0.06	1.00	0.15	0.85	0.14	0.36	0.50
Final Sat.:	1750	5546	54	1750	5492	108	1750	268	1532	244	631	875

Capacity Analysis Module:

Vol/Sat:	0.11	0.11	0.11	0.05	0.27	0.27	0.02	0.12	0.12	0.08	0.08	0.08
Crit Moves:	****			****			****					
Green Time:	12.0	24.8	24.8	17.4	30.1	30.1	13.9	13.9	13.9	13.9	13.9	13.9
Volume/Cap:	0.58	0.29	0.29	0.18	0.58	0.58	0.11	0.58	0.58	0.36	0.36	0.36
Delay/Veh:	26.8	14.1	14.1	18.5	13.1	13.1	20.7	25.1	25.1	22.4	22.4	22.4
User DelAdj:	1.00	1.00	1.00	1.00	1.00	1.00	1.00	1.00	1.00	1.00	1.00	1.00
AdjDel/Veh:	26.8	14.1	14.1	18.5	13.1	13.1	20.7	25.1	25.1	22.4	22.4	22.4
LOS by Move:	C	B	B	B	B	B	C	C	C	C	C	C
HCM2k95thQ:	7	6	6	3	14	14	1	8	8	6	6	6

Note: Queue reported is the number of cars per lane.

BART Phase II Extension Project

Level Of Service Computation Report
2000 HCM Operations (Future Volume Alternative)
AM - 2025 Project Conditions

Intersection #107: Benton/Lafayette

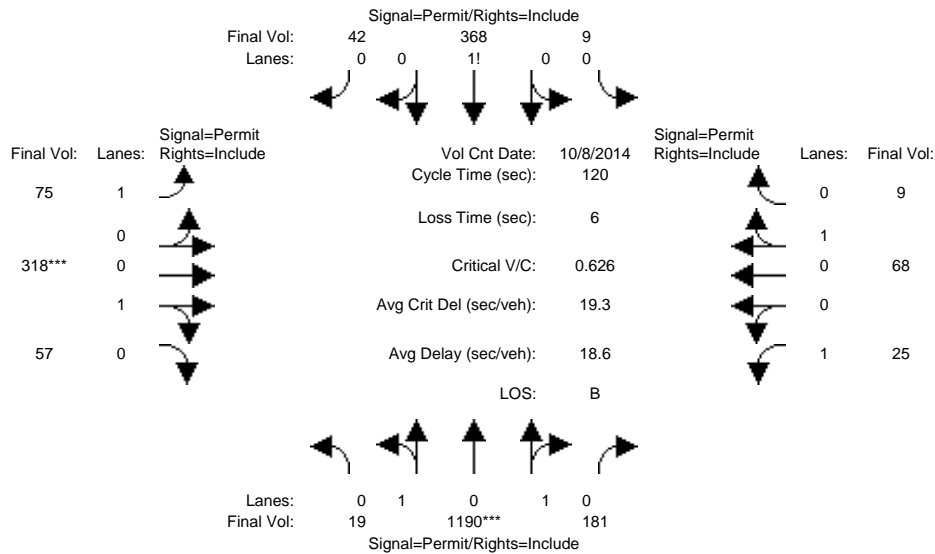

Approach:	North Bound			South Bound			East Bound			West Bound		
	L	T	R	L	T	R	L	T	R	L	T	R
Min. Green:	10	10	10	10	10	10	10	10	10	10	10	10
Y+R:	4.0	4.0	4.0	4.0	4.0	4.0	4.0	4.0	4.0	4.0	4.0	4.0
Volume Module: >> Count Date: 8 Oct 2014 <<												
Base Vol:	19	1190	181	9	368	42	75	318	57	25	68	9
Growth Adj:	1.00	1.00	1.00	1.00	1.00	1.00	1.00	1.00	1.00	1.00	1.00	1.00
Initial Bse:	19	1190	181	9	368	42	75	318	57	25	68	9
Added Vol:	0	0	0	0	0	0	0	0	0	0	0	0
PasserByVol:	0	0	0	0	0	0	0	0	0	0	0	0
Initial Fut:	19	1190	181	9	368	42	75	318	57	25	68	9
User Adj:	1.00	1.00	1.00	1.00	1.00	1.00	1.00	1.00	1.00	1.00	1.00	1.00
PHF Adj:	1.00	1.00	1.00	1.00	1.00	1.00	1.00	1.00	1.00	1.00	1.00	1.00
PHF Volume:	19	1190	181	9	368	42	75	318	57	25	68	9
Reduct Vol:	0	0	0	0	0	0	0	0	0	0	0	0
Reduced Vol:	19	1190	181	9	368	42	75	318	57	25	68	9
PCE Adj:	1.00	1.00	1.00	1.00	1.00	1.00	1.00	1.00	1.00	1.00	1.00	1.00
MLF Adj:	1.00	1.00	1.00	1.00	1.00	1.00	1.00	1.00	1.00	1.00	1.00	1.00
Final Volume:	19	1190	181	9	368	42	75	318	57	25	68	9
Saturation Flow Module:												
Sat/Lane:	1900	1900	1900	1900	1900	1900	1900	1900	1900	1900	1900	1900
Adjustment:	0.95	0.95	0.95	0.92	0.92	0.92	0.92	0.95	0.95	0.92	0.95	0.95
Lanes:	0.03	1.71	0.26	0.02	0.88	0.10	1.00	0.85	0.15	1.00	0.88	0.12
Final Sat.:	49	3082	469	38	1537	175	1750	1526	274	1750	1590	210
Capacity Analysis Module:												
Vol/Sat:	0.39	0.39	0.39	0.24	0.24	0.24	0.04	0.21	0.21	0.01	0.04	0.04
Crit Moves:	****									****		
Green Time:	74.0	74.0	74.0	74.0	74.0	74.0	40.0	40.0	40.0	40.0	40.0	40.0
Volume/Cap:	0.63	0.63	0.63	0.39	0.39	0.39	0.13	0.63	0.63	0.04	0.13	0.13
Delay/Veh:	14.9	14.9	14.9	11.8	11.8	11.8	28.0	35.8	35.8	27.1	28.0	28.0
User DelAdj:	1.00	1.00	1.00	1.00	1.00	1.00	1.00	1.00	1.00	1.00	1.00	1.00
AdjDel/Veh:	14.9	14.9	14.9	11.8	11.8	11.8	28.0	35.8	35.8	27.1	28.0	28.0
LOS by Move:	B	B	B	B	B	B	C	D	D	C	C	C
HCM2k95thQ:	28	28	28	15	15	15	4	22	22	1	4	4

Note: Queue reported is the number of cars per lane.

BART Phase II Extension Project

Level Of Service Computation Report
2000 HCM Operations (Future Volume Alternative)
PM - 2025 Project Conditions

Intersection #107: Benton/Lafayette

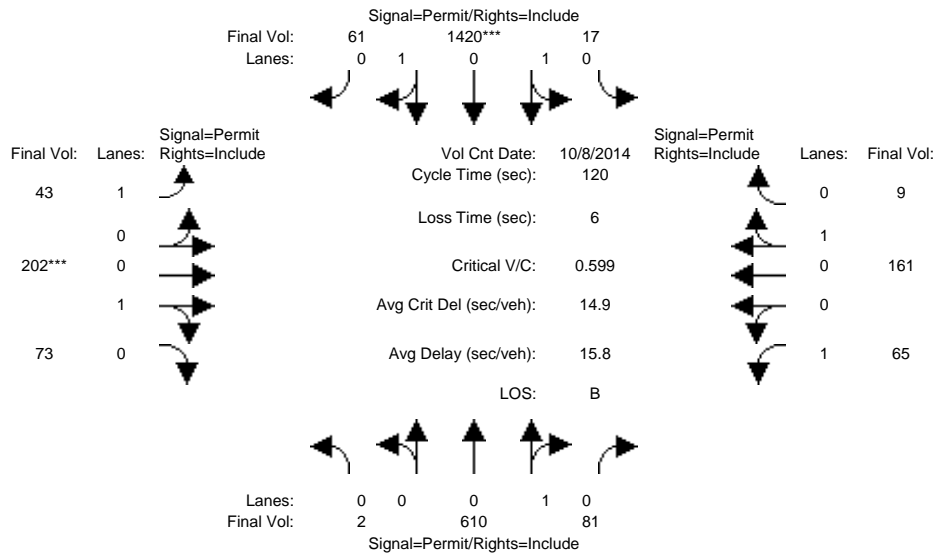

Approach:	North Bound			South Bound			East Bound			West Bound		
	L	T	R	L	T	R	L	T	R	L	T	R
Min. Green:	10	10	10	10	10	10	10	10	10	10	10	10
Y+R:	4.0	4.0	4.0	4.0	4.0	4.0	4.0	4.0	4.0	4.0	4.0	4.0

Volume Module:	>>	Count	Date:	8 Oct 2014	<<							
Base Vol:	2	610	81	17	1420	61	43	202	73	65	161	9
Growth Adj:	1.00	1.00	1.00	1.00	1.00	1.00	1.00	1.00	1.00	1.00	1.00	1.00
Initial Bse:	2	610	81	17	1420	61	43	202	73	65	161	9
Added Vol:	0	0	0	0	0	0	0	0	0	0	0	0
PasserByVol:	0	0	0	0	0	0	0	0	0	0	0	0
Initial Fut:	2	610	81	17	1420	61	43	202	73	65	161	9
User Adj:	1.00	1.00	1.00	1.00	1.00	1.00	1.00	1.00	1.00	1.00	1.00	1.00
PHF Adj:	1.00	1.00	1.00	1.00	1.00	1.00	1.00	1.00	1.00	1.00	1.00	1.00
PHF Volume:	2	610	81	17	1420	61	43	202	73	65	161	9
Reduct Vol:	0	0	0	0	0	0	0	0	0	0	0	0
Reduced Vol:	2	610	81	17	1420	61	43	202	73	65	161	9
PCE Adj:	1.00	1.00	1.00	1.00	1.00	1.00	1.00	1.00	1.00	1.00	1.00	1.00
MLF Adj:	1.00	1.00	1.00	1.00	1.00	1.00	1.00	1.00	1.00	1.00	1.00	1.00
FinalVolume:	2	610	81	17	1420	61	43	202	73	65	161	9

Saturation Flow Module:												
Sat/Lane:	1900	1900	1900	1900	1900	1900	1900	1900	1900	1900	1900	1900
Adjustment:	0.92	0.92	0.92	0.95	0.95	0.95	0.92	0.95	0.95	0.92	0.95	0.95
Lanes:	0.01	0.88	0.11	0.02	1.90	0.08	1.00	0.73	0.27	1.00	0.95	0.05
Final Sat.:	5	1540	205	41	3413	147	1750	1322	478	1750	1705	95

Capacity Analysis Module:												
Vol/Sat:	0.40	0.40	0.40	0.42	0.42	0.42	0.02	0.15	0.15	0.04	0.09	0.09
Crit Moves:	****						****					
Green Time:	83.4	83.4	83.4	83.4	83.4	83.4	30.6	30.6	30.6	30.6	30.6	30.6
Volume/Cap:	0.57	0.57	0.57	0.60	0.60	0.60	0.10	0.60	0.60	0.15	0.37	0.37
Delay/Veh:	9.9	9.9	9.9	10.0	10.0	10.0	34.2	41.5	41.5	34.7	37.3	37.3
User DelAdj:	1.00	1.00	1.00	1.00	1.00	1.00	1.00	1.00	1.00	1.00	1.00	1.00
AdjDel/Veh:	9.9	9.9	9.9	10.0	10.0	10.0	34.2	41.5	41.5	34.7	37.3	37.3
LOS by Move:	A	A	A	A	A	A	C	D	D	C	D	D
HCM2k95thQ:	24	24	24	25	25	25	3	17	17	4	11	11

Note: Queue reported is the number of cars per lane.

BART Phase II Extension Project

Level Of Service Computation Report
2000 HCM Operations (Future Volume Alternative)
AM - 2025 Project Conditions

Intersection #175: Reed/De La Cruz

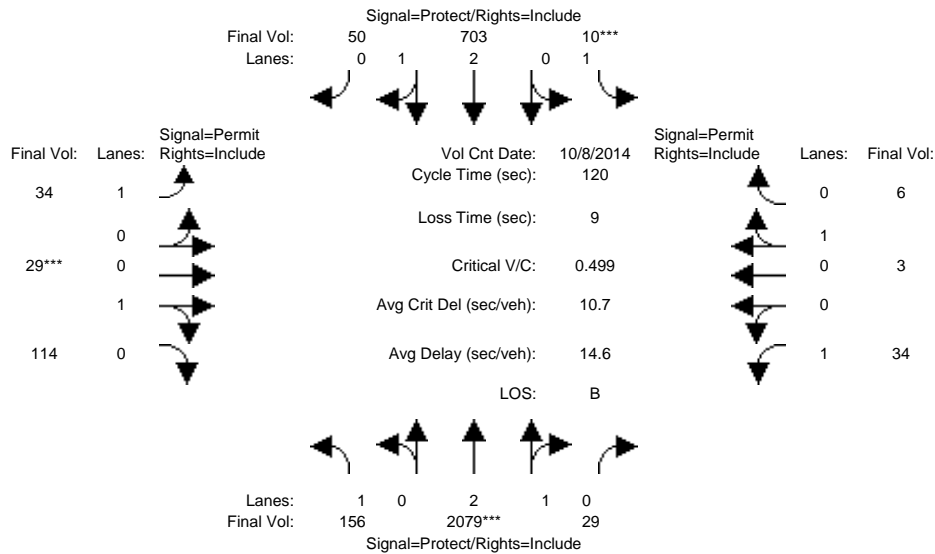

Approach:	North Bound			South Bound			East Bound			West Bound		
	L	T	R	L	T	R	L	T	R	L	T	R
Min. Green:	7	10	10	7	10	10	10	10	10	10	10	10
Y+R:	4.0	4.0	4.0	4.0	4.0	4.0	4.0	4.0	4.0	4.0	4.0	4.0

Volume Module:	>>	Count	Date:	8 Oct 2014	<<											
Base Vol:	156	2079	29	10	703	50	34	29	114	34	3	6				
Growth Adj:	1.00	1.00	1.00	1.00	1.00	1.00	1.00	1.00	1.00	1.00	1.00	1.00				
Initial Bse:	156	2079	29	10	703	50	34	29	114	34	3	6				
Added Vol:	0	0	0	0	0	0	0	0	0	0	0	0				
PasserByVol:	0	0	0	0	0	0	0	0	0	0	0	0				
Initial Fut:	156	2079	29	10	703	50	34	29	114	34	3	6				
User Adj:	1.00	1.00	1.00	1.00	1.00	1.00	1.00	1.00	1.00	1.00	1.00	1.00				
PHF Adj:	1.00	1.00	1.00	1.00	1.00	1.00	1.00	1.00	1.00	1.00	1.00	1.00				
PHF Volume:	156	2079	29	10	703	50	34	29	114	34	3	6				
Reduct Vol:	0	0	0	0	0	0	0	0	0	0	0	0				
Reduced Vol:	156	2079	29	10	703	50	34	29	114	34	3	6				
PCE Adj:	1.00	1.00	1.00	1.00	1.00	1.00	1.00	1.00	1.00	1.00	1.00	1.00				
MLF Adj:	1.00	1.00	1.00	1.00	1.00	1.00	1.00	1.00	1.00	1.00	1.00	1.00				
Final Volume:	156	2079	29	10	703	50	34	29	114	34	3	6				

Saturation Flow Module:												
Sat/Lane:	1900	1900	1900	1900	1900	1900	1900	1900	1900	1900	1900	1900
Adjustment:	0.92	0.98	0.95	0.92	0.98	0.95	0.92	0.95	0.95	0.92	0.95	0.95
Lanes:	1.00	2.96	0.04	1.00	2.79	0.21	1.00	0.20	0.80	1.00	0.33	0.67
Final Sat.:	1750	5523	77	1750	5228	372	1750	365	1435	1750	600	1200

Capacity Analysis Module:												
Vol/Sat:	0.09	0.38	0.38	0.01	0.13	0.13	0.02	0.08	0.08	0.02	0.01	0.01
Crit Moves:	****			****			****					
Green Time:	37.0	85.9	85.9	7.0	55.9	55.9	18.1	18.1	18.1	18.1	18.1	18.1
Volume/Cap:	0.29	0.53	0.53	0.10	0.29	0.29	0.13	0.53	0.53	0.13	0.03	0.03
Delay/Veh:	31.8	7.9	7.9	53.9	19.9	19.9	44.3	48.9	48.9	44.3	43.5	43.5
User DelAdj:	1.00	1.00	1.00	1.00	1.00	1.00	1.00	1.00	1.00	1.00	1.00	1.00
AdjDel/Veh:	31.8	7.9	7.9	53.9	19.9	19.9	44.3	48.9	48.9	44.3	43.5	43.5
LOS by Move:	C	A	A	D	B	B	D	D	D	D	D	D
HCM2k95thQ:	9	22	22	1	11	11	2	10	10	2	1	1

Note: Queue reported is the number of cars per lane.

BART Phase II Extension Project

Level Of Service Computation Report
2000 HCM Operations (Future Volume Alternative)
PM - 2025 Project Conditions

Intersection #175: Reed/De La Cruz

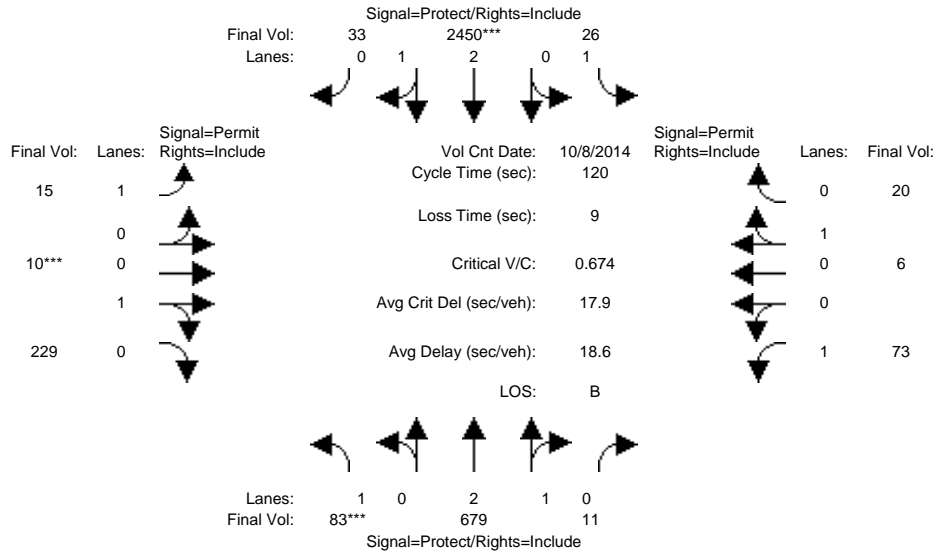

Approach:	North Bound			South Bound			East Bound			West Bound		
Movement:	L	T	R	L	T	R	L	T	R	L	T	R
Min. Green:	7	10	10	7	10	10	10	10	10	10	10	10
Y+R:	4.0	4.0	4.0	4.0	4.0	4.0	4.0	4.0	4.0	4.0	4.0	4.0
Volume Module: >> Count Date: 8 Oct 2014 <<												
Base Vol:	83	679	11	26	2450	33	15	10	229	73	6	20
Growth Adj:	1.00	1.00	1.00	1.00	1.00	1.00	1.00	1.00	1.00	1.00	1.00	1.00
Initial Bse:	83	679	11	26	2450	33	15	10	229	73	6	20
Added Vol:	0	0	0	0	0	0	0	0	0	0	0	0
PasserByVol:	0	0	0	0	0	0	0	0	0	0	0	0
Initial Fut:	83	679	11	26	2450	33	15	10	229	73	6	20
User Adj:	1.00	1.00	1.00	1.00	1.00	1.00	1.00	1.00	1.00	1.00	1.00	1.00
PHF Adj:	1.00	1.00	1.00	1.00	1.00	1.00	1.00	1.00	1.00	1.00	1.00	1.00
PHF Volume:	83	679	11	26	2450	33	15	10	229	73	6	20
Reduct Vol:	0	0	0	0	0	0	0	0	0	0	0	0
Reduced Vol:	83	679	11	26	2450	33	15	10	229	73	6	20
PCE Adj:	1.00	1.00	1.00	1.00	1.00	1.00	1.00	1.00	1.00	1.00	1.00	1.00
MLF Adj:	1.00	1.00	1.00	1.00	1.00	1.00	1.00	1.00	1.00	1.00	1.00	1.00
FinalVolume:	83	679	11	26	2450	33	15	10	229	73	6	20
Saturation Flow Module:												
Sat/Lane:	1900	1900	1900	1900	1900	1900	1900	1900	1900	1900	1900	1900
Adjustment:	0.92	0.98	0.95	0.92	0.98	0.95	0.92	0.95	0.95	0.92	0.95	0.95
Lanes:	1.00	2.95	0.05	1.00	2.96	0.04	1.00	0.04	0.96	1.00	0.23	0.77
Final Sat.:	1750	5511	89	1750	5525	74	1750	75	1725	1750	415	1385
Capacity Analysis Module:												
Vol/Sat:	0.05	0.12	0.12	0.01	0.44	0.44	0.01	0.13	0.13	0.04	0.01	0.01
Crit Moves:	****			****			****					
Green Time:	8.4	59.3	59.3	28.1	78.9	78.9	23.6	23.6	23.6	23.6	23.6	23.6
Volume/Cap:	0.67	0.25	0.25	0.06	0.67	0.67	0.04	0.67	0.67	0.21	0.07	0.07
Delay/Veh:	68.2	17.6	17.6	35.8	13.1	13.1	39.1	49.7	49.7	40.7	39.3	39.3
User DelAdj:	1.00	1.00	1.00	1.00	1.00	1.00	1.00	1.00	1.00	1.00	1.00	1.00
AdjDel/Veh:	68.2	17.6	17.6	35.8	13.1	13.1	39.1	49.7	49.7	40.7	39.3	39.3
LOS by Move:	E	B	B	D	B	B	D	D	D	D	D	D
HCM2k95thQ:	9	9	9	2	33	33	1	16	16	5	2	2

Note: Queue reported is the number of cars per lane.

BART Phase II Extension Project

Level Of Service Computation Report
2000 HCM Unsignalized (Future Volume Alternative)
AM - 2025 Project Conditions

Intersection #1008: Lafayette/Harrison

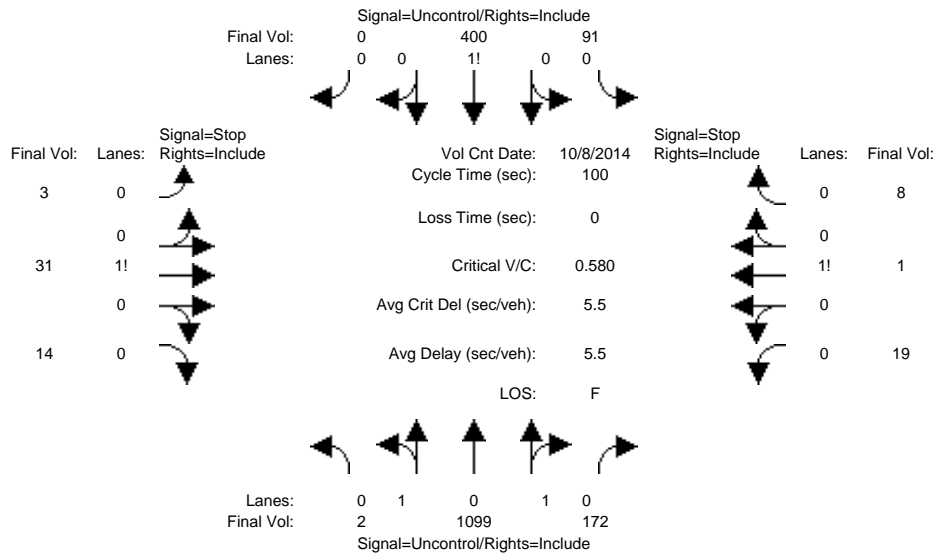

Approach:	North Bound			South Bound			East Bound			West Bound		
Movement:	L	T	R	L	T	R	L	T	R	L	T	R
Volume Module: >> Count Date: 8 Oct 2014 <<												
Base Vol:	2	1099	172	91	400	0	3	31	14	19	1	8
Growth Adj:	1.00	1.00	1.00	1.00	1.00	1.00	1.00	1.00	1.00	1.00	1.00	1.00
Initial Bse:	2	1099	172	91	400	0	3	31	14	19	1	8
Added Vol:	0	0	0	0	0	0	0	0	0	0	0	0
PasserByVol:	0	0	0	0	0	0	0	0	0	0	0	0
Initial Fut:	2	1099	172	91	400	0	3	31	14	19	1	8
User Adj:	1.00	1.00	1.00	1.00	1.00	1.00	1.00	1.00	1.00	1.00	1.00	1.00
PHF Adj:	1.00	1.00	1.00	1.00	1.00	1.00	1.00	1.00	1.00	1.00	1.00	1.00
PHF Volume:	2	1099	172	91	400	0	3	31	14	19	1	8
Reduct Vol:	0	0	0	0	0	0	0	0	0	0	0	0
FinalVolume:	2	1099	172	91	400	0	3	31	14	19	1	8
Critical Gap Module:												
Critical Gp:	4.1	xxxx	xxxxxx	4.1	xxxx	xxxxxx	7.1	6.5	6.2	7.1	6.5	6.2
FollowUpTim:	2.2	xxxx	xxxxxx	2.2	xxxx	xxxxxx	3.5	4.0	3.3	3.5	4.0	3.3
Capacity Module:												
Cnflct Vol:	400	xxxx	xxxxxx	1271	xxxx	xxxxxx	1136	1857	400	1794	1771	636
Potent Cap.:	1170	xxxx	xxxxxx	553	xxxx	xxxxxx	181	74	654	63	84	482
Move Cap.:	1170	xxxx	xxxxxx	553	xxxx	xxxxxx	152	61	654	33	69	482
Volume/Cap:	0.00	xxxx	xxxx	0.16	xxxx	xxxx	0.02	0.50	0.02	0.58	0.01	0.02
Level Of Service Module:												
2Way95thQ:	0.0	xxxx	xxxxxx	0.6	xxxx	xxxxxx	xxxx	xxxx	xxxxxx	xxxx	xxxx	xxxxxx
Control Del:	8.1	xxxx	xxxxxx	12.8	xxxx	xxxxxx	xxxxxx	xxxx	xxxxxx	xxxxxx	xxxx	xxxxxx
LOS by Move:	A	*	*	B	*	*	*	*	*	*	*	*
Movement:	LT	LTR	RT	LT	LTR	RT	LT	LTR	RT	LT	LTR	RT
Shared Cap.:	xxxx	xxxx	xxxxxx	xxxx	xxxx	xxxxxx	xxxx	88	xxxxxx	xxxx	46	xxxxxx
SharedQueue:	0.0	xxxx	xxxxxx	0.6	xxxx	xxxxxx	xxxxxx	2.4	xxxxxx	xxxxxx	2.3	xxxxxx
Shrd ConDel:	8.1	xxxx	xxxxxx	12.8	xxxx	xxxxxx	xxxxxx	86.9	xxxxxx	xxxxxx	167	xxxxxx
Shared LOS:	A	*	*	B	*	*	*	F	*	*	F	*
ApproachDel:	xxxxxxx							86.9	167.1			
ApproachLOS:	*							F	F			

Note: Queue reported is the number of cars per lane.

BART Phase II Extension Project

Level Of Service Computation Report
 2000 HCM Unsignalized (Future Volume Alternative)
 PM - 2025 Project Conditions

Intersection #1008: Lafayette/Harrison

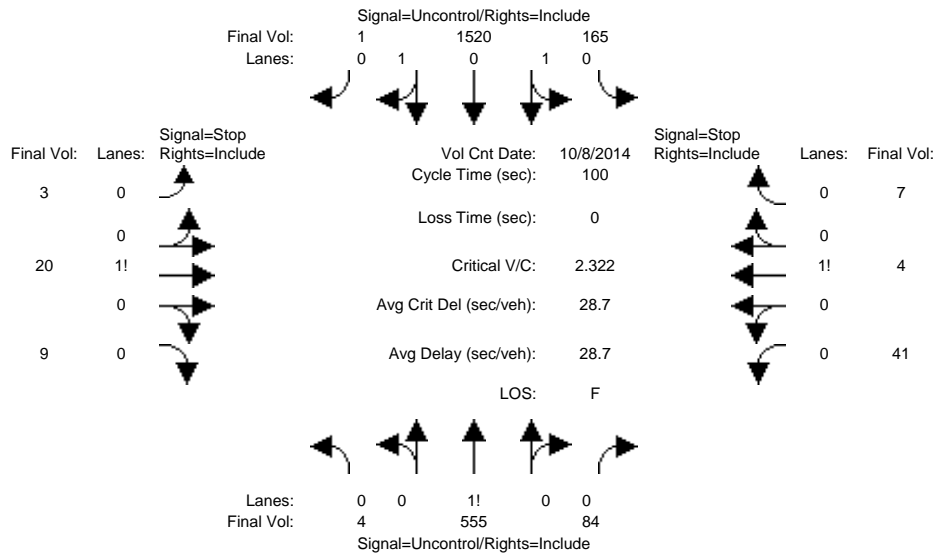

Approach:	North Bound			South Bound			East Bound			West Bound		
Movement:	L	T	R	L	T	R	L	T	R	L	T	R
Volume Module: >> Count Date: 8 Oct 2014 <<												
Base Vol:	4	555	84	165	1520	1	3	20	9	41	4	7
Growth Adj:	1.00	1.00	1.00	1.00	1.00	1.00	1.00	1.00	1.00	1.00	1.00	1.00
Initial Bse:	4	555	84	165	1520	1	3	20	9	41	4	7
Added Vol:	0	0	0	0	0	0	0	0	0	0	0	0
PasserByVol:	0	0	0	0	0	0	0	0	0	0	0	0
Initial Fut:	4	555	84	165	1520	1	3	20	9	41	4	7
User Adj:	1.00	1.00	1.00	1.00	1.00	1.00	1.00	1.00	1.00	1.00	1.00	1.00
PHF Adj:	1.00	1.00	1.00	1.00	1.00	1.00	1.00	1.00	1.00	1.00	1.00	1.00
PHF Volume:	4	555	84	165	1520	1	3	20	9	41	4	7
Reduct Vol:	0	0	0	0	0	0	0	0	0	0	0	0
FinalVolume:	4	555	84	165	1520	1	3	20	9	41	4	7
Critical Gap Module:												
Critical Gp:	4.1	xxxx	xxxxxx	4.1	xxxx	xxxxxx	7.1	6.5	6.2	7.1	6.5	6.2
FollowUpTim:	2.2	xxxx	xxxxxx	2.2	xxxx	xxxxxx	3.5	4.0	3.3	3.5	4.0	3.3
Capacity Module:												
Cnflct Vol:	1521	xxxx	xxxxxx	639	xxxx	xxxxxx	2461	2498	761	1705	2456	597
Potent Cap.:	445	xxxx	xxxxxx	955	xxxx	xxxxxx	21	29	409	73	31	507
Move Cap.:	445	xxxx	xxxxxx	955	xxxx	xxxxxx	16	24	409	18	25	507
Volume/Cap:	0.01	xxxx	xxxx	0.17	xxxx	xxxx	0.19	0.85	0.02	2.32	0.16	0.01
Level Of Service Module:												
2Way95thQ:	0.0	xxxx	xxxxxx	0.6	xxxx	xxxxxx	xxxx	xxxx	xxxxxx	xxxx	xxxx	xxxxxx
Control Del:	13.2	xxxx	xxxxxx	9.6	xxxx	xxxxxx	xxxxxx	xxxx	xxxxxx	xxxxxx	xxxx	xxxxxx
LOS by Move:	B	*	*	A	*	*	*	*	*	*	*	*
Movement:	LT	LTR	RT	LT	LTR	RT	LT	LTR	RT	LT	LTR	RT
Shared Cap.:	xxxx	xxxx	xxxxxx	xxxx	xxxx	xxxxxx	xxxx	30	xxxxxx	xxxx	21	xxxxxx
SharedQueue:	xxxxxx	xxxx	xxxxxx	0.6	xxxx	xxxxxx	xxxxxx	3.6	xxxxxx	xxxxxx	6.8	xxxxxx
Shrd ConDel:	xxxxxx	xxxx	xxxxxx	9.6	xxxx	xxxxxx	xxxxxx	380	xxxxxx	xxxxxx	1069	xxxxxx
Shared LOS:	*	*	*	A	*	*	*	F	*	*	F	*
ApproachDel:	xxxxxx			xxxxxx			379.6			1068.6		
ApproachLOS:	*			*			F			F		

Note: Queue reported is the number of cars per lane.

BART Phase II Extension Project

Level Of Service Computation Report
2000 HCM Operations (Future Volume Alternative)
AM - 2025 Project Conditions

Intersection #1012: El Camino Real/Railroad Ave

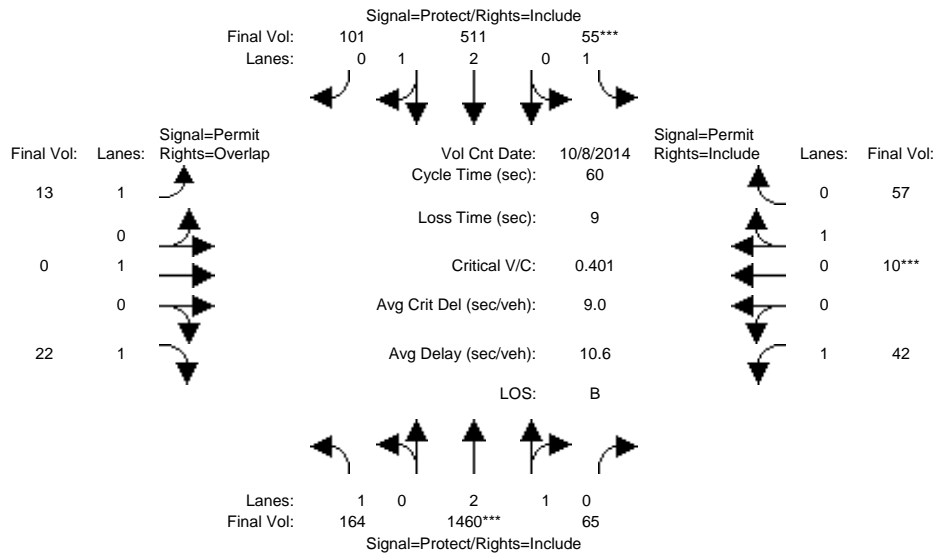

Approach:	North Bound			South Bound			East Bound			West Bound		
	L	T	R	L	T	R	L	T	R	L	T	R
Min. Green:	7	10	10	7	10	10	10	10	10	10	10	10
Y+R:	4.0	4.0	4.0	4.0	4.0	4.0	4.0	4.0	4.0	4.0	4.0	4.0
Volume Module: >> Count Date: 8 Oct 2014 <<												
Base Vol:	164	1460	65	55	511	101	13	0	22	42	10	57
Growth Adj:	1.00	1.00	1.00	1.00	1.00	1.00	1.00	1.00	1.00	1.00	1.00	1.00
Initial Bse:	164	1460	65	55	511	101	13	0	22	42	10	57
Added Vol:	0	0	0	0	0	0	0	0	0	0	0	0
PasserByVol:	0	0	0	0	0	0	0	0	0	0	0	0
Initial Fut:	164	1460	65	55	511	101	13	0	22	42	10	57
User Adj:	1.00	1.00	1.00	1.00	1.00	1.00	1.00	1.00	1.00	1.00	1.00	1.00
PHF Adj:	1.00	1.00	1.00	1.00	1.00	1.00	1.00	1.00	1.00	1.00	1.00	1.00
PHF Volume:	164	1460	65	55	511	101	13	0	22	42	10	57
Reduct Vol:	0	0	0	0	0	0	0	0	0	0	0	0
Reduced Vol:	164	1460	65	55	511	101	13	0	22	42	10	57
PCE Adj:	1.00	1.00	1.00	1.00	1.00	1.00	1.00	1.00	1.00	1.00	1.00	1.00
MLF Adj:	1.00	1.00	1.00	1.00	1.00	1.00	1.00	1.00	1.00	1.00	1.00	1.00
FinalVolume:	164	1460	65	55	511	101	13	0	22	42	10	57
Saturation Flow Module:												
Sat/Lane:	1900	1900	1900	1900	1900	1900	1900	1900	1900	1900	1900	1900
Adjustment:	0.92	0.98	0.95	0.92	0.99	0.95	0.92	1.00	0.92	0.92	0.95	0.95
Lanes:	1.00	2.87	0.13	1.00	2.49	0.51	1.00	1.00	1.00	1.00	0.15	0.85
Final Sat.:	1750	5361	239	1750	4675	924	1750	1900	1750	1750	269	1531
Capacity Analysis Module:												
Vol/Sat:	0.09	0.27	0.27	0.03	0.11	0.11	0.01	0.00	0.01	0.02	0.04	0.04
Crit Moves:	****			****						****		
Green Time:	16.9	34.0	34.0	7.0	24.1	24.1	10.0	0.0	26.9	10.0	10.0	10.0
Volume/Cap:	0.33	0.48	0.48	0.27	0.27	0.27	0.04	0.00	0.03	0.14	0.22	0.22
Delay/Veh:	17.5	7.9	7.9	24.9	12.1	12.1	21.1	0.0	9.3	21.6	22.0	22.0
User DelAdj:	1.00	1.00	1.00	1.00	1.00	1.00	1.00	1.00	1.00	1.00	1.00	1.00
AdjDel/Veh:	17.5	7.9	7.9	24.9	12.1	12.1	21.1	0.0	9.3	21.6	22.0	22.0
LOS by Move:	B	A	A	C	B	B	C	A	A	C	C	C
HCM2k95thQ:	6	12	12	2	5	5	1	0	1	2	3	3

Note: Queue reported is the number of cars per lane.

BART Phase II Extension Project

Level Of Service Computation Report
2000 HCM Operations (Future Volume Alternative)
PM - 2025 Project Conditions

Intersection #1012: El Camino Real/Railroad Ave

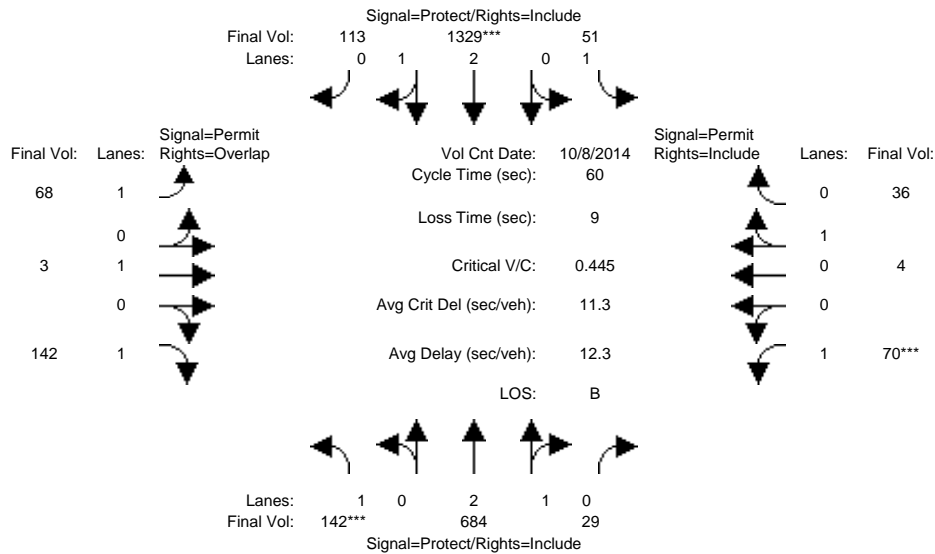

Approach:	North Bound			South Bound			East Bound			West Bound		
	L	T	R	L	T	R	L	T	R	L	T	R
Min. Green:	7	10	10	7	10	10	10	10	10	10	10	10
Y+R:	4.0	4.0	4.0	4.0	4.0	4.0	4.0	4.0	4.0	4.0	4.0	4.0

Volume Module:	>> Count Date: 8 Oct 2014 <<											
Base Vol:	142	684	29	51	1329	113	68	3	142	70	4	36
Growth Adj:	1.00	1.00	1.00	1.00	1.00	1.00	1.00	1.00	1.00	1.00	1.00	1.00
Initial Bse:	142	684	29	51	1329	113	68	3	142	70	4	36
Added Vol:	0	0	0	0	0	0	0	0	0	0	0	0
PasserByVol:	0	0	0	0	0	0	0	0	0	0	0	0
Initial Fut:	142	684	29	51	1329	113	68	3	142	70	4	36
User Adj:	1.00	1.00	1.00	1.00	1.00	1.00	1.00	1.00	1.00	1.00	1.00	1.00
PHF Adj:	1.00	1.00	1.00	1.00	1.00	1.00	1.00	1.00	1.00	1.00	1.00	1.00
PHF Volume:	142	684	29	51	1329	113	68	3	142	70	4	36
Reduct Vol:	0	0	0	0	0	0	0	0	0	0	0	0
Reduced Vol:	142	684	29	51	1329	113	68	3	142	70	4	36
PCE Adj:	1.00	1.00	1.00	1.00	1.00	1.00	1.00	1.00	1.00	1.00	1.00	1.00
MLF Adj:	1.00	1.00	1.00	1.00	1.00	1.00	1.00	1.00	1.00	1.00	1.00	1.00
FinalVolume:	142	684	29	51	1329	113	68	3	142	70	4	36

Saturation Flow Module:												
Sat/Lane:	1900	1900	1900	1900	1900	1900	1900	1900	1900	1900	1900	1900
Adjustment:	0.92	0.98	0.95	0.92	0.99	0.95	0.92	1.00	0.92	0.92	0.95	0.95
Lanes:	1.00	2.87	0.13	1.00	2.76	0.24	1.00	1.00	1.00	1.00	0.10	0.90
Final Sat.:	1750	5372	228	1750	5161	439	1750	1900	1750	1750	180	1620

Capacity Analysis Module:												
Vol/Sat:	0.08	0.13	0.13	0.03	0.26	0.26	0.04	0.00	0.08	0.04	0.02	0.02
Crit Moves:	****				****					****		
Green Time:	9.8	24.1	24.1	16.9	31.2	31.2	10.0	10.0	19.8	10.0	10.0	10.0
Volume/Cap:	0.50	0.32	0.32	0.10	0.50	0.50	0.23	0.01	0.25	0.24	0.13	0.13
Delay/Veh:	24.2	12.4	12.4	16.1	9.5	9.5	22.1	20.9	14.9	22.1	21.5	21.5
User DelAdj:	1.00	1.00	1.00	1.00	1.00	1.00	1.00	1.00	1.00	1.00	1.00	1.00
AdjDel/Veh:	24.2	12.4	12.4	16.1	9.5	9.5	22.1	20.9	14.9	22.1	21.5	21.5
LOS by Move:	C	B	B	B	A	A	C	C	B	C	C	C
HCM2k95thQ:	7	6	6	1	11	11	3	0	4	3	2	2

Note: Queue reported is the number of cars per lane.

BART Phase II Extension Project

Level Of Service Computation Report
 2000 HCM Operations (Future Volume Alternative)
 AM - 2025 Project Conditions

Intersection #1202: LAFAYETTE/EL CAMINO REAL

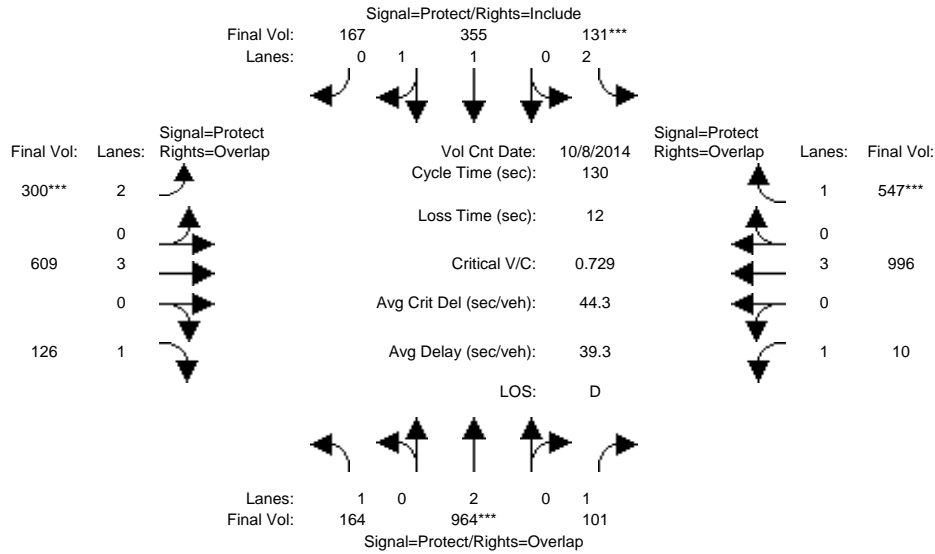

Approach:	North Bound			South Bound			East Bound			West Bound		
	L	T	R	L	T	R	L	T	R	L	T	R
Min. Green:	7	10	10	7	10	10	7	10	10	7	10	10
Y+R:	4.0	4.0	4.0	4.0	4.0	4.0	4.0	4.0	4.0	4.0	4.0	4.0

Volume Module: >> Count Date: 8 Oct 2014 <<

Base Vol:	164	964	101	131	355	167	300	609	126	10	996	547
Growth Adj:	1.00	1.00	1.00	1.00	1.00	1.00	1.00	1.00	1.00	1.00	1.00	1.00
Initial Bse:	164	964	101	131	355	167	300	609	126	10	996	547
Added Vol:	0	0	0	0	0	0	0	0	0	0	0	0
PasserByVol:	0	0	0	0	0	0	0	0	0	0	0	0
Initial Fut:	164	964	101	131	355	167	300	609	126	10	996	547
User Adj:	1.00	1.00	1.00	1.00	1.00	1.00	1.00	1.00	1.00	1.00	1.00	1.00
PHF Adj:	1.00	1.00	1.00	1.00	1.00	1.00	1.00	1.00	1.00	1.00	1.00	1.00
PHF Volume:	164	964	101	131	355	167	300	609	126	10	996	547
Reduct Vol:	0	0	0	0	0	0	0	0	0	0	0	0
Reduced Vol:	164	964	101	131	355	167	300	609	126	10	996	547
PCE Adj:	1.00	1.00	1.00	1.00	1.00	1.00	1.00	1.00	1.00	1.00	1.00	1.00
MLF Adj:	1.00	1.00	1.00	1.00	1.00	1.00	1.00	1.00	1.00	1.00	1.00	1.00
FinalVolume:	164	964	101	131	355	167	300	609	126	10	996	547

Saturation Flow Module:

Sat/Lane:	1900	1900	1900	1900	1900	1900	1900	1900	1900	1900	1900	1900
Adjustment:	0.92	1.00	0.92	0.83	0.99	0.95	0.83	1.00	0.92	0.92	1.00	0.92
Lanes:	1.00	2.00	1.00	2.00	1.34	0.66	2.00	3.00	1.00	1.00	3.00	1.00
Final Sat.:	1750	3800	1750	3150	2515	1183	3150	5700	1750	1750	5700	1750

Capacity Analysis Module:

Vol/Sat:	0.09	0.25	0.06	0.04	0.14	0.14	0.10	0.11	0.07	0.01	0.17	0.31
Crit Moves:	****	****	****	****	****	****	****	****	****	****	****	****
Green Time:	21.0	45.3	66.4	7.4	31.7	31.7	17.0	42.0	63.0	21.2	46.2	53.6
Volume/Cap:	0.58	0.73	0.11	0.73	0.58	0.58	0.73	0.33	0.15	0.04	0.49	0.76
Delay/Veh:	53.4	39.1	16.6	74.3	44.3	44.3	60.8	33.5	18.7	45.9	33.0	37.4
User DelAdj:	1.00	1.00	1.00	1.00	1.00	1.00	1.00	1.00	1.00	1.00	1.00	1.00
AdjDel/Veh:	53.4	39.1	16.6	74.3	44.3	44.3	60.8	33.5	18.7	45.9	33.0	37.4
LOS by Move:	D	D	B	E	D	D	E	C	B	D	C	D
HCM2k95thQ:	12	29	4	7	17	17	13	11	6	1	19	36

Note: Queue reported is the number of cars per lane.

BART Phase II Extension Project

Level Of Service Computation Report
2000 HCM Operations (Future Volume Alternative)
PM - 2025 Project Conditions

Intersection #1202: LAFAYETTE/EL CAMINO REAL

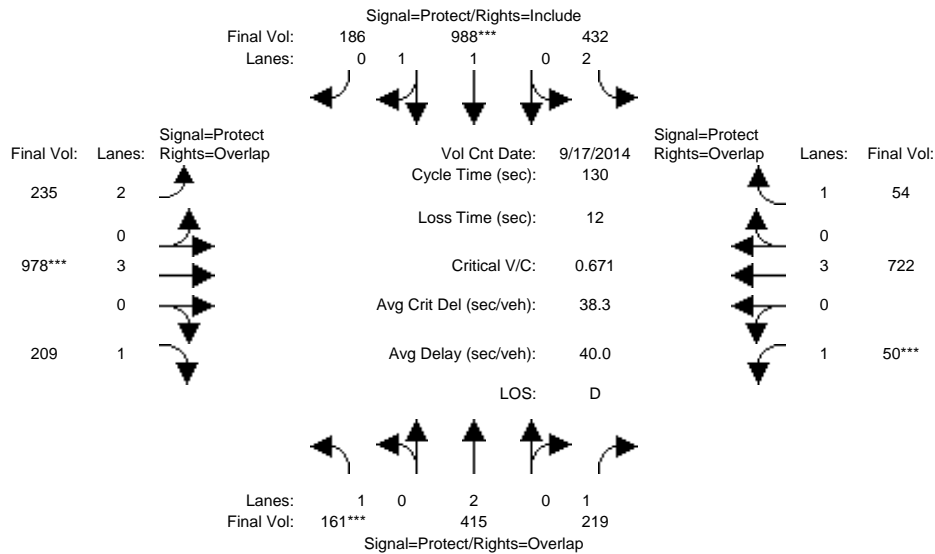

Approach:	North Bound			South Bound			East Bound			West Bound		
	L	T	R	L	T	R	L	T	R	L	T	R
Min. Green:	7	10	10	7	10	10	7	10	10	7	10	10
Y+R:	4.0	4.0	4.0	4.0	4.0	4.0	4.0	4.0	4.0	4.0	4.0	4.0

Volume Module:	>> Count Date: 17 Sep 2014 <<											
Base Vol:	161	415	219	432	988	186	235	978	209	50	722	54
Growth Adj:	1.00	1.00	1.00	1.00	1.00	1.00	1.00	1.00	1.00	1.00	1.00	1.00
Initial Bse:	161	415	219	432	988	186	235	978	209	50	722	54
Added Vol:	0	0	0	0	0	0	0	0	0	0	0	0
PasserByVol:	0	0	0	0	0	0	0	0	0	0	0	0
Initial Fut:	161	415	219	432	988	186	235	978	209	50	722	54
User Adj:	1.00	1.00	1.00	1.00	1.00	1.00	1.00	1.00	1.00	1.00	1.00	1.00
PHF Adj:	1.00	1.00	1.00	1.00	1.00	1.00	1.00	1.00	1.00	1.00	1.00	1.00
PHF Volume:	161	415	219	432	988	186	235	978	209	50	722	54
Reduct Vol:	0	0	0	0	0	0	0	0	0	0	0	0
Reduced Vol:	161	415	219	432	988	186	235	978	209	50	722	54
PCE Adj:	1.00	1.00	1.00	1.00	1.00	1.00	1.00	1.00	1.00	1.00	1.00	1.00
MLF Adj:	1.00	1.00	1.00	1.00	1.00	1.00	1.00	1.00	1.00	1.00	1.00	1.00
FinalVolume:	161	415	219	432	988	186	235	978	209	50	722	54

Saturation Flow Module:												
Sat/Lane:	1900	1900	1900	1900	1900	1900	1900	1900	1900	1900	1900	1900
Adjustment:	0.92	1.00	0.92	0.83	0.98	0.95	0.83	1.00	0.92	0.92	1.00	0.92
Lanes:	1.00	2.00	1.00	2.00	1.67	0.33	2.00	3.00	1.00	1.00	3.00	1.00
Final Sat.:	1750	3800	1750	3150	3113	586	3150	5700	1750	1750	5700	1750

Capacity Analysis Module:												
Vol/Sat:	0.09	0.11	0.13	0.14	0.32	0.32	0.07	0.17	0.12	0.03	0.13	0.03
Crit Moves:	****			****			****			****		
Green Time:	17.6	34.7	41.7	43.5	60.6	60.6	14.7	32.8	50.4	7.0	25.0	68.6
Volume/Cap:	0.68	0.41	0.39	0.41	0.68	0.68	0.66	0.68	0.31	0.53	0.66	0.06
Delay/Veh:	61.3	39.5	34.7	33.6	28.2	28.2	59.7	45.2	28.0	65.6	50.0	15.0
User DelAdj:	1.00	1.00	1.00	1.00	1.00	1.00	1.00	1.00	1.00	1.00	1.00	1.00
AdjDel/Veh:	61.3	39.5	34.7	33.6	28.2	28.2	59.7	45.2	28.0	65.6	50.0	15.0
LOS by Move:	E	D	C	C	C	C	E	D	C	E	D	B
HCM2k95thQ:	13	12	13	15	32	32	11	21	12	6	18	2

Note: Queue reported is the number of cars per lane.

BART Phase II Extension Project

Level Of Service Computation Report
2000 HCM Operations (Future Volume Alternative)
AM - 2025 Project Conditions

Intersection #1204: MONROE/EL CAMINO REAL

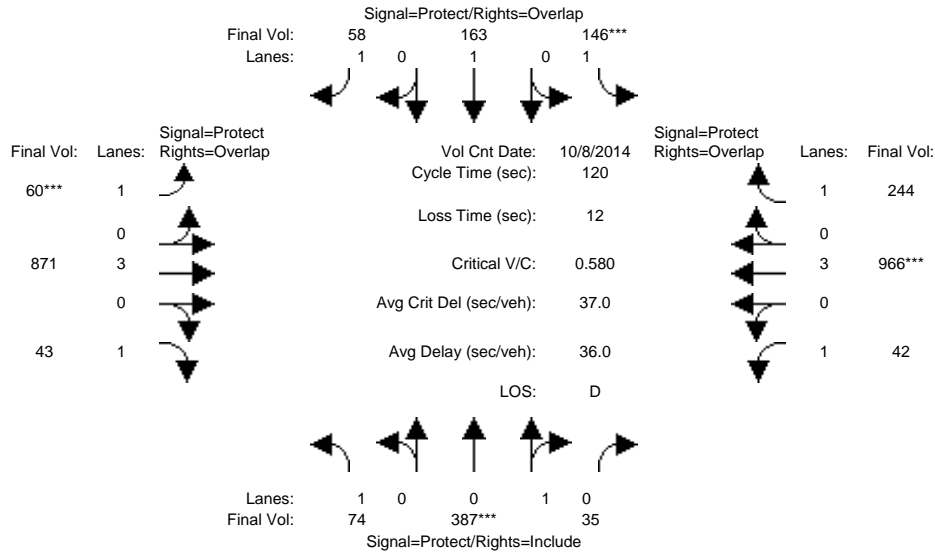

Approach:	North Bound			South Bound			East Bound			West Bound		
	L	T	R	L	T	R	L	T	R	L	T	R
Min. Green:	7	10	10	7	10	10	7	10	10	7	10	10
Y+R:	4.0	4.0	4.0	4.0	4.0	4.0	4.0	4.0	4.0	4.0	4.0	4.0
Volume Module: >> Count Date: 8 Oct 2014 <<												
Base Vol:	74	387	35	146	163	58	60	871	43	42	966	244
Growth Adj:	1.00	1.00	1.00	1.00	1.00	1.00	1.00	1.00	1.00	1.00	1.00	1.00
Initial Bse:	74	387	35	146	163	58	60	871	43	42	966	244
Added Vol:	0	0	0	0	0	0	0	0	0	0	0	0
PasserByVol:	0	0	0	0	0	0	0	0	0	0	0	0
Initial Fut:	74	387	35	146	163	58	60	871	43	42	966	244
User Adj:	1.00	1.00	1.00	1.00	1.00	1.00	1.00	1.00	1.00	1.00	1.00	1.00
PHF Adj:	1.00	1.00	1.00	1.00	1.00	1.00	1.00	1.00	1.00	1.00	1.00	1.00
PHF Volume:	74	387	35	146	163	58	60	871	43	42	966	244
Reduct Vol:	0	0	0	0	0	0	0	0	0	0	0	0
Reduced Vol:	74	387	35	146	163	58	60	871	43	42	966	244
PCE Adj:	1.00	1.00	1.00	1.00	1.00	1.00	1.00	1.00	1.00	1.00	1.00	1.00
MLF Adj:	1.00	1.00	1.00	1.00	1.00	1.00	1.00	1.00	1.00	1.00	1.00	1.00
FinalVolume:	74	387	35	146	163	58	60	871	43	42	966	244
Saturation Flow Module:												
Sat/Lane:	1900	1900	1900	1900	1900	1900	1900	1900	1900	1900	1900	1900
Adjustment:	0.92	0.95	0.95	0.92	1.00	0.92	0.92	1.00	0.92	0.92	1.00	0.92
Lanes:	1.00	0.92	0.08	1.00	1.00	1.00	1.00	3.00	1.00	1.00	3.00	1.00
Final Sat.:	1750	1651	149	1750	1900	1750	1750	5700	1750	1750	5700	1750
Capacity Analysis Module:												
Vol/Sat:	0.04	0.23	0.23	0.08	0.09	0.03	0.03	0.15	0.02	0.02	0.17	0.14
Crit Moves:	****	****	****	****	****	****	****	****	****	****	****	****
Green Time:	26.6	48.5	48.5	17.3	39.2	46.3	7.1	30.5	57.2	11.7	35.1	52.4
Volume/Cap:	0.19	0.58	0.58	0.58	0.26	0.09	0.58	0.60	0.05	0.25	0.58	0.32
Delay/Veh:	38.2	29.0	29.0	51.3	30.0	23.5	63.0	40.1	16.9	50.9	36.7	22.4
User DelAdj:	1.00	1.00	1.00	1.00	1.00	1.00	1.00	1.00	1.00	1.00	1.00	1.00
AdjDel/Veh:	38.2	29.0	29.0	51.3	30.0	23.5	63.0	40.1	16.9	50.9	36.7	22.4
LOS by Move:	D	C	C	D	C	C	E	D	B	D	D	C
HCM2k95thQ:	5	23	23	11	8	3	5	17	2	3	18	12

Note: Queue reported is the number of cars per lane.

BART Phase II Extension Project

Level Of Service Computation Report
2000 HCM Operations (Future Volume Alternative)
PM - 2025 Project Conditions

Intersection #1204: MONROE/EL CAMINO REAL

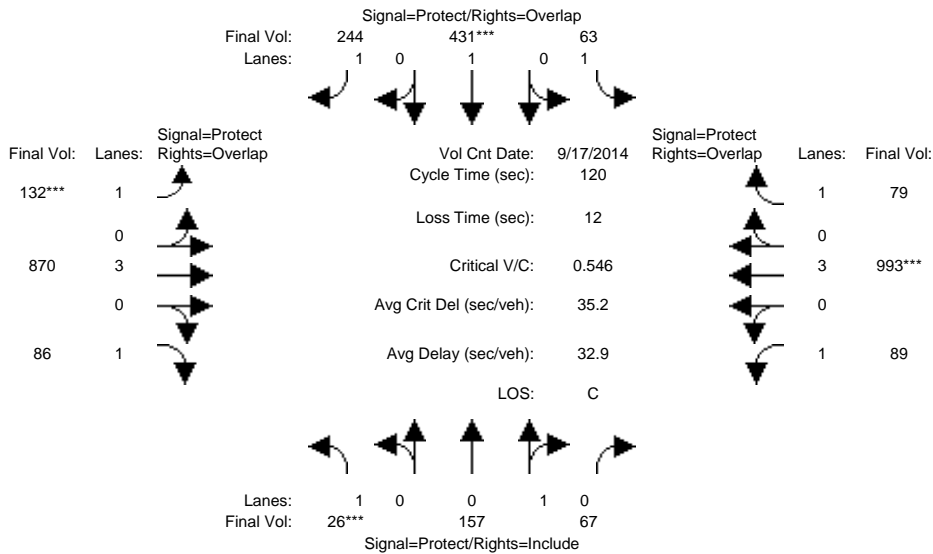

Approach:	North Bound			South Bound			East Bound			West Bound		
	L	T	R	L	T	R	L	T	R	L	T	R
Min. Green:	7	10	10	7	10	10	7	10	10	7	10	10
Y+R:	4.0	4.0	4.0	4.0	4.0	4.0	4.0	4.0	4.0	4.0	4.0	4.0
Volume Module: >> Count Date: 17 Sep 2014 <<												
Base Vol:	26	157	67	63	431	244	132	870	86	89	993	79
Growth Adj:	1.00	1.00	1.00	1.00	1.00	1.00	1.00	1.00	1.00	1.00	1.00	1.00
Initial Bse:	26	157	67	63	431	244	132	870	86	89	993	79
Added Vol:	0	0	0	0	0	0	0	0	0	0	0	0
PasserByVol:	0	0	0	0	0	0	0	0	0	0	0	0
Initial Fut:	26	157	67	63	431	244	132	870	86	89	993	79
User Adj:	1.00	1.00	1.00	1.00	1.00	1.00	1.00	1.00	1.00	1.00	1.00	1.00
PHF Adj:	1.00	1.00	1.00	1.00	1.00	1.00	1.00	1.00	1.00	1.00	1.00	1.00
PHF Volume:	26	157	67	63	431	244	132	870	86	89	993	79
Reduct Vol:	0	0	0	0	0	0	0	0	0	0	0	0
Reduced Vol:	26	157	67	63	431	244	132	870	86	89	993	79
PCE Adj:	1.00	1.00	1.00	1.00	1.00	1.00	1.00	1.00	1.00	1.00	1.00	1.00
MLF Adj:	1.00	1.00	1.00	1.00	1.00	1.00	1.00	1.00	1.00	1.00	1.00	1.00
FinalVolume:	26	157	67	63	431	244	132	870	86	89	993	79
Saturation Flow Module:												
Sat/Lane:	1900	1900	1900	1900	1900	1900	1900	1900	1900	1900	1900	1900
Adjustment:	0.92	0.95	0.95	0.92	1.00	0.92	0.92	1.00	0.92	0.92	1.00	0.92
Lanes:	1.00	0.70	0.30	1.00	1.00	1.00	1.00	3.00	1.00	1.00	3.00	1.00
Final Sat.:	1750	1262	538	1750	1900	1750	1750	5700	1750	1750	5700	1750
Capacity Analysis Module:												
Vol/Sat:	0.01	0.12	0.12	0.04	0.23	0.14	0.08	0.15	0.05	0.05	0.17	0.05
Crit Moves:	****			****			****			****		
Green Time:	7.0	37.5	37.5	17.6	48.1	64.1	16.0	38.3	45.3	14.6	36.9	54.5
Volume/Cap:	0.25	0.40	0.40	0.25	0.57	0.26	0.57	0.48	0.13	0.42	0.57	0.10
Delay/Veh:	55.3	32.9	32.9	45.8	28.9	15.3	52.0	33.0	24.6	50.1	35.3	18.8
User DelAdj:	1.00	1.00	1.00	1.00	1.00	1.00	1.00	1.00	1.00	1.00	1.00	1.00
AdjDel/Veh:	55.3	32.9	32.9	45.8	28.9	15.3	52.0	33.0	24.6	50.1	35.3	18.8
LOS by Move:	E	C	C	D	C	B	D	C	C	D	D	B
HCM2k95thQ:	3	13	13	4	22	10	10	16	4	6	18	3

Note: Queue reported is the number of cars per lane.

BART Phase II Extension Project

Level Of Service Computation Report
2000 HCM Operations (Future Volume Alternative)
AM - 2025 Project Conditions

Intersection #1205: SCOTT/EL CAMINO REAL

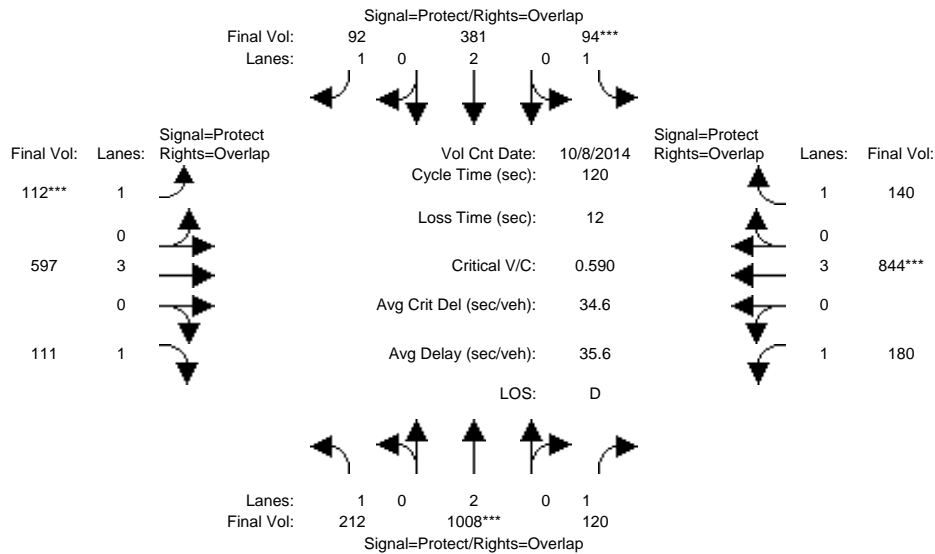

Approach:	North Bound			South Bound			East Bound			West Bound		
	L	T	R	L	T	R	L	T	R	L	T	R
Min. Green:	7	10	10	7	10	10	7	10	10	7	10	10
Y+R:	4.0	4.0	4.0	4.0	4.0	4.0	4.0	4.0	4.0	4.0	4.0	4.0
Volume Module: >> Count Date: 8 Oct 2014 <<												
Base Vol:	212	1008	120	94	381	92	112	597	111	180	844	140
Growth Adj:	1.00	1.00	1.00	1.00	1.00	1.00	1.00	1.00	1.00	1.00	1.00	1.00
Initial Bse:	212	1008	120	94	381	92	112	597	111	180	844	140
Added Vol:	0	0	0	0	0	0	0	0	0	0	0	0
PasserByVol:	0	0	0	0	0	0	0	0	0	0	0	0
Initial Fut:	212	1008	120	94	381	92	112	597	111	180	844	140
User Adj:	1.00	1.00	1.00	1.00	1.00	1.00	1.00	1.00	1.00	1.00	1.00	1.00
PHF Adj:	1.00	1.00	1.00	1.00	1.00	1.00	1.00	1.00	1.00	1.00	1.00	1.00
PHF Volume:	212	1008	120	94	381	92	112	597	111	180	844	140
Reduct Vol:	0	0	0	0	0	0	0	0	0	0	0	0
Reduced Vol:	212	1008	120	94	381	92	112	597	111	180	844	140
PCE Adj:	1.00	1.00	1.00	1.00	1.00	1.00	1.00	1.00	1.00	1.00	1.00	1.00
MLF Adj:	1.00	1.00	1.00	1.00	1.00	1.00	1.00	1.00	1.00	1.00	1.00	1.00
Final Volume:	212	1008	120	94	381	92	112	597	111	180	844	140
Saturation Flow Module:												
Sat/Lane:	1900	1900	1900	1900	1900	1900	1900	1900	1900	1900	1900	1900
Adjustment:	0.92	1.00	0.92	0.92	1.00	0.92	0.92	1.00	0.92	0.92	1.00	0.92
Lanes:	1.00	2.00	1.00	1.00	2.00	1.00	1.00	3.00	1.00	1.00	3.00	1.00
Final Sat.:	1750	3800	1750	1750	3800	1750	1750	5700	1750	1750	5700	1750
Capacity Analysis Module:												
Vol/Sat:	0.12	0.27	0.07	0.05	0.10	0.05	0.06	0.10	0.06	0.10	0.15	0.08
Crit Moves:	****			****			****			****		
Green Time:	35.5	53.9	75.3	10.9	29.4	42.4	13.0	21.8	57.3	21.4	30.1	41.0
Volume/Cap:	0.41	0.59	0.11	0.59	0.41	0.15	0.59	0.58	0.13	0.58	0.59	0.23
Delay/Veh:	34.4	25.3	9.0	58.1	38.3	26.6	55.8	45.7	17.6	47.9	40.2	28.4
User DelAdj:	1.00	1.00	1.00	1.00	1.00	1.00	1.00	1.00	1.00	1.00	1.00	1.00
AdjDel/Veh:	34.4	25.3	9.0	58.1	38.3	26.6	55.8	45.7	17.6	47.9	40.2	28.4
LOS by Move:	C	C	A	E	D	C	E	D	B	D	D	C
HCM2k95thQ:	13	24	4	7	11	5	8	13	5	13	17	8

Note: Queue reported is the number of cars per lane.

BART Phase II Extension Project

Level Of Service Computation Report
2000 HCM Operations (Future Volume Alternative)
PM - 2025 Project Conditions

Intersection #1205: SCOTT/EL CAMINO REAL

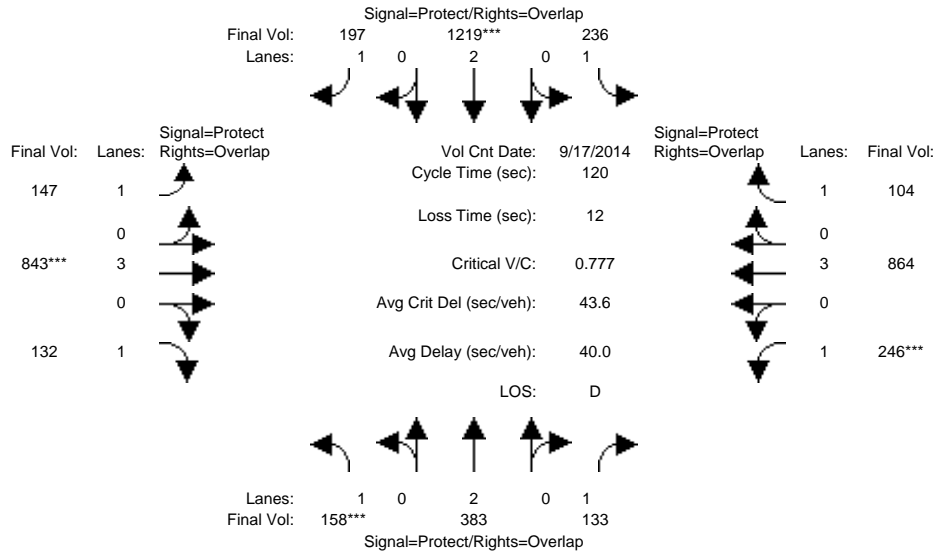

Approach:	North Bound			South Bound			East Bound			West Bound		
Movement:	L	T	R	L	T	R	L	T	R	L	T	R
Min. Green:	7	10	10	7	10	10	7	10	10	7	10	10
Y+R:	4.0	4.0	4.0	4.0	4.0	4.0	4.0	4.0	4.0	4.0	4.0	4.0
Volume Module: >> Count Date: 17 Sep 2014 <<												
Base Vol:	158	383	133	236	1219	197	147	843	132	246	864	104
Growth Adj:	1.00	1.00	1.00	1.00	1.00	1.00	1.00	1.00	1.00	1.00	1.00	1.00
Initial Bse:	158	383	133	236	1219	197	147	843	132	246	864	104
Added Vol:	0	0	0	0	0	0	0	0	0	0	0	0
PasserByVol:	0	0	0	0	0	0	0	0	0	0	0	0
Initial Fut:	158	383	133	236	1219	197	147	843	132	246	864	104
User Adj:	1.00	1.00	1.00	1.00	1.00	1.00	1.00	1.00	1.00	1.00	1.00	1.00
PHF Adj:	1.00	1.00	1.00	1.00	1.00	1.00	1.00	1.00	1.00	1.00	1.00	1.00
PHF Volume:	158	383	133	236	1219	197	147	843	132	246	864	104
Reduct Vol:	0	0	0	0	0	0	0	0	0	0	0	0
Reduced Vol:	158	383	133	236	1219	197	147	843	132	246	864	104
PCE Adj:	1.00	1.00	1.00	1.00	1.00	1.00	1.00	1.00	1.00	1.00	1.00	1.00
MLF Adj:	1.00	1.00	1.00	1.00	1.00	1.00	1.00	1.00	1.00	1.00	1.00	1.00
FinalVolume:	158	383	133	236	1219	197	147	843	132	246	864	104
Saturation Flow Module:												
Sat/Lane:	1900	1900	1900	1900	1900	1900	1900	1900	1900	1900	1900	1900
Adjustment:	0.92	1.00	0.92	0.92	1.00	0.92	0.92	1.00	0.92	0.92	1.00	0.92
Lanes:	1.00	2.00	1.00	1.00	2.00	1.00	1.00	3.00	1.00	1.00	3.00	1.00
Final Sat.:	1750	3800	1750	1750	3800	1750	1750	5700	1750	1750	5700	1750
Capacity Analysis Module:												
Vol/Sat:	0.09	0.10	0.08	0.13	0.32	0.11	0.08	0.15	0.08	0.14	0.15	0.06
Crit Moves:	****				****			****			****	
Green Time:	13.9	27.1	48.8	36.3	49.5	65.4	15.9	22.8	36.8	21.7	28.7	65.0
Volume/Cap:	0.78	0.45	0.19	0.45	0.78	0.21	0.63	0.78	0.25	0.78	0.63	0.11
Delay/Veh:	68.6	40.3	23.0	34.3	33.0	14.1	55.0	49.8	31.5	58.4	42.0	13.5
User DelAdj:	1.00	1.00	1.00	1.00	1.00	1.00	1.00	1.00	1.00	1.00	1.00	1.00
AdjDel/Veh:	68.6	40.3	23.0	34.3	33.0	14.1	55.0	49.8	31.5	58.4	42.0	13.5
LOS by Move:	E	D	C	C	C	B	E	D	C	E	D	B
HCM2k95thQ:	13	11	7	14	34	8	11	19	8	18	18	4

Note: Queue reported is the number of cars per lane.

BART Phase II Extension Project

Level Of Service Computation Report
2000 HCM Operations (Future Volume Alternative)
AM - 2025 Project Conditions

Intersection #1213: THE ALAMEDA/EL CAMINO REAL

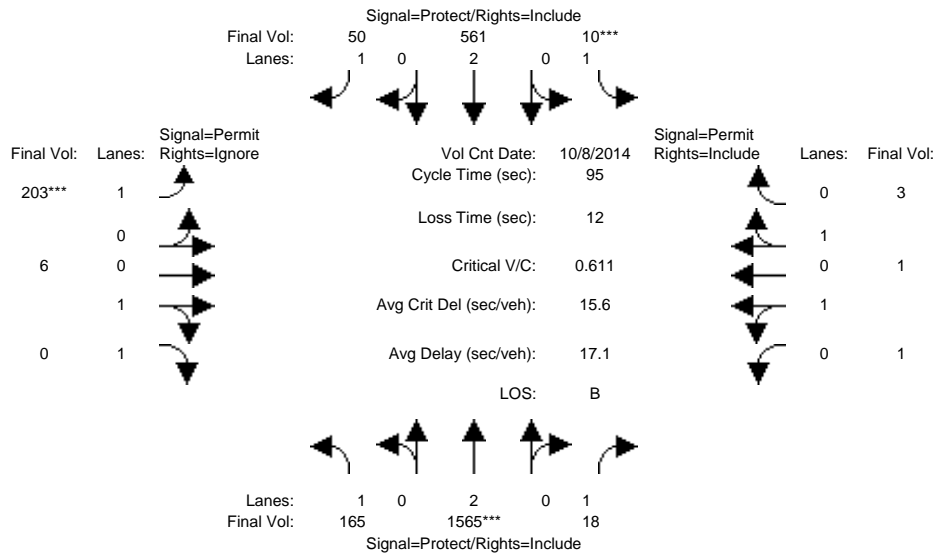

Approach:	North Bound			South Bound			East Bound			West Bound		
	L	T	R	L	T	R	L	T	R	L	T	R
Min. Green:	7	10	10	7	10	10	7	10	10	7	10	10
Y+R:	4.0	4.0	4.0	4.0	4.0	4.0	4.0	4.0	4.0	4.0	4.0	4.0
Volume Module: >> Count Date: 8 Oct 2014 <<												
Base Vol:	165	1565	18	10	561	50	203	6	195	1	1	3
Growth Adj:	1.00	1.00	1.00	1.00	1.00	1.00	1.00	1.00	1.00	1.00	1.00	1.00
Initial Bse:	165	1565	18	10	561	50	203	6	195	1	1	3
Added Vol:	0	0	0	0	0	0	0	0	0	0	0	0
PasserByVol:	0	0	0	0	0	0	0	0	0	0	0	0
Initial Fut:	165	1565	18	10	561	50	203	6	195	1	1	3
User Adj:	1.00	1.00	1.00	1.00	1.00	1.00	1.00	1.00	0.00	1.00	1.00	1.00
PHF Adj:	1.00	1.00	1.00	1.00	1.00	1.00	1.00	1.00	0.00	1.00	1.00	1.00
PHF Volume:	165	1565	18	10	561	50	203	6	0	1	1	3
Reduct Vol:	0	0	0	0	0	0	0	0	0	0	0	0
Reduced Vol:	165	1565	18	10	561	50	203	6	0	1	1	3
PCE Adj:	1.00	1.00	1.00	1.00	1.00	1.00	1.00	1.00	0.00	1.00	1.00	1.00
MLF Adj:	1.00	1.00	1.00	1.00	1.00	1.00	1.00	1.00	0.00	1.00	1.00	1.00
FinalVolume:	165	1565	18	10	561	50	203	6	0	1	1	3
Saturation Flow Module:												
Sat/Lane:	1900	1900	1900	1900	1900	1900	1900	1900	1900	1900	1900	1900
Adjustment:	0.92	1.00	0.92	0.92	1.00	0.92	0.92	0.95	0.92	0.95	0.95	0.95
Lanes:	1.00	2.00	1.00	1.00	2.00	1.00	1.00	1.00	1.00	0.50	0.50	1.00
Final Sat.:	1750	3800	1750	1750	3800	1750	1750	1800	1750	900	900	1800
Capacity Analysis Module:												
Vol/Sat:	0.09	0.41	0.01	0.01	0.15	0.03	0.12	0.00	0.00	0.00	0.00	0.00
Crit Moves:	****			****			****					
Green Time:	25.8	59.3	59.3	7.0	40.5	40.5	16.7	16.7	0.0	16.7	16.7	16.7
Volume/Cap:	0.35	0.66	0.02	0.08	0.35	0.07	0.66	0.02	0.00	0.01	0.01	0.01
Delay/Veh:	28.2	12.1	6.8	41.3	18.5	16.2	41.7	32.4	0.0	32.3	32.3	32.3
User DelAdj:	1.00	1.00	1.00	1.00	1.00	1.00	1.00	1.00	1.00	1.00	1.00	1.00
AdjDel/Veh:	28.2	12.1	6.8	41.3	18.5	16.2	41.7	32.4	0.0	32.3	32.3	32.3
LOS by Move:	C	B	A	D	B	B	D	C	A	C	C	C
HCM2k95thQ:	8	25	0	1	11	2	14	0	0	0	0	0

Note: Queue reported is the number of cars per lane.

BART Phase II Extension Project

Level Of Service Computation Report
2000 HCM Operations (Future Volume Alternative)
PM - 2025 Project Conditions

Intersection #1213: THE ALAMEDA/EL CAMINO REAL

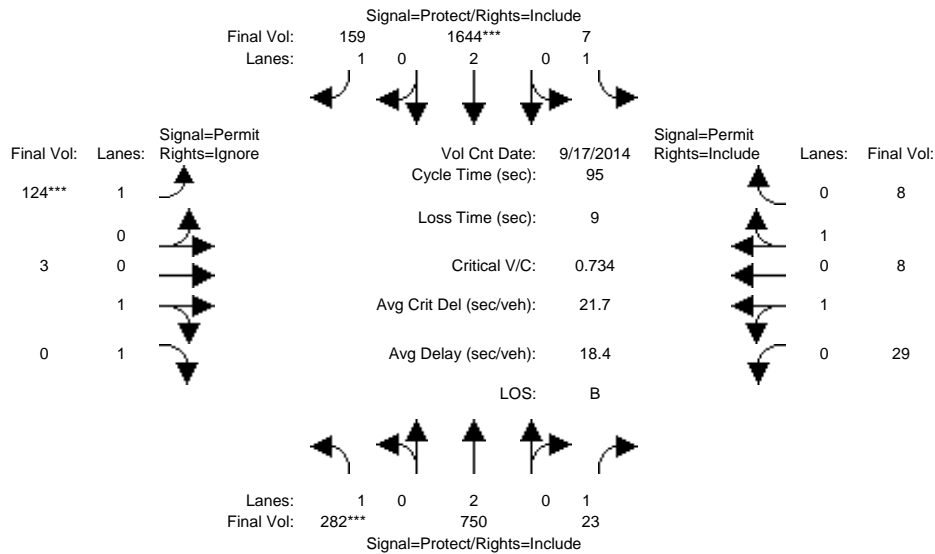

Approach:	North Bound			South Bound			East Bound			West Bound		
	L	T	R	L	T	R	L	T	R	L	T	R
Min. Green:	7	10	10	7	10	10	10	10	10	10	10	10
Y+R:	4.0	4.0	4.0	4.0	4.0	4.0	4.0	4.0	4.0	4.0	4.0	4.0

Volume Module:	>> Count Date: 17 Sep 2014 <<											
Base Vol:	282	750	23	7	1644	159	124	3	272	29	8	8
Growth Adj:	1.00	1.00	1.00	1.00	1.00	1.00	1.00	1.00	1.00	1.00	1.00	1.00
Initial Bse:	282	750	23	7	1644	159	124	3	272	29	8	8
Added Vol:	0	0	0	0	0	0	0	0	0	0	0	0
PasserByVol:	0	0	0	0	0	0	0	0	0	0	0	0
Initial Fut:	282	750	23	7	1644	159	124	3	272	29	8	8
User Adj:	1.00	1.00	1.00	1.00	1.00	1.00	1.00	1.00	0.00	1.00	1.00	1.00
PHF Adj:	1.00	1.00	1.00	1.00	1.00	1.00	1.00	1.00	0.00	1.00	1.00	1.00
PHF Volume:	282	750	23	7	1644	159	124	3	0	29	8	8
Reduct Vol:	0	0	0	0	0	0	0	0	0	0	0	0
Reduced Vol:	282	750	23	7	1644	159	124	3	0	29	8	8
PCE Adj:	1.00	1.00	1.00	1.00	1.00	1.00	1.00	1.00	0.00	1.00	1.00	1.00
MLF Adj:	1.00	1.00	1.00	1.00	1.00	1.00	1.00	1.00	0.00	1.00	1.00	1.00
FinalVolume:	282	750	23	7	1644	159	124	3	0	29	8	8

Saturation Flow Module:												
Sat/Lane:	1900	1900	1900	1900	1900	1900	1900	1900	1900	1900	1900	1900
Adjustment:	0.92	1.00	0.92	0.92	1.00	0.92	0.92	0.95	0.92	0.95	0.95	0.95
Lanes:	1.00	2.00	1.00	1.00	2.00	1.00	1.00	1.00	1.00	1.00	0.50	0.50
Final Sat.:	1750	3800	1750	1750	3800	1750	1750	1800	1750	1800	900	900

Capacity Analysis Module:												
Vol/Sat:	0.16	0.20	0.01	0.00	0.43	0.09	0.07	0.00	0.00	0.02	0.01	0.01
Crit Moves:	****				****		****					
Green Time:	20.6	55.3	55.3	20.7	55.4	55.4	10.0	10.0	0.0	10.0	10.0	10.0
Volume/Cap:	0.74	0.34	0.02	0.02	0.74	0.16	0.67	0.02	0.00	0.15	0.08	0.08
Delay/Veh:	42.4	10.4	8.4	29.2	16.0	9.2	50.3	38.1	0.0	38.9	38.4	38.4
User DelAdj:	1.00	1.00	1.00	1.00	1.00	1.00	1.00	1.00	1.00	1.00	1.00	1.00
AdjDel/Veh:	42.4	10.4	8.4	29.2	16.0	9.2	50.3	38.1	0.0	38.9	38.4	38.4
LOS by Move:	D	B	A	C	B	A	D	D	A	D	D	D
HCM2k95thQ:	15	10	1	0	32	5	10	0	0	2	1	1

Note: Queue reported is the number of cars per lane.

BART Phase II Extension Project

Level Of Service Computation Report
2000 HCM Operations (Future Volume Alternative)
AM - 2025 Project Conditions

Intersection #3411: AVIATION/COLEMAN

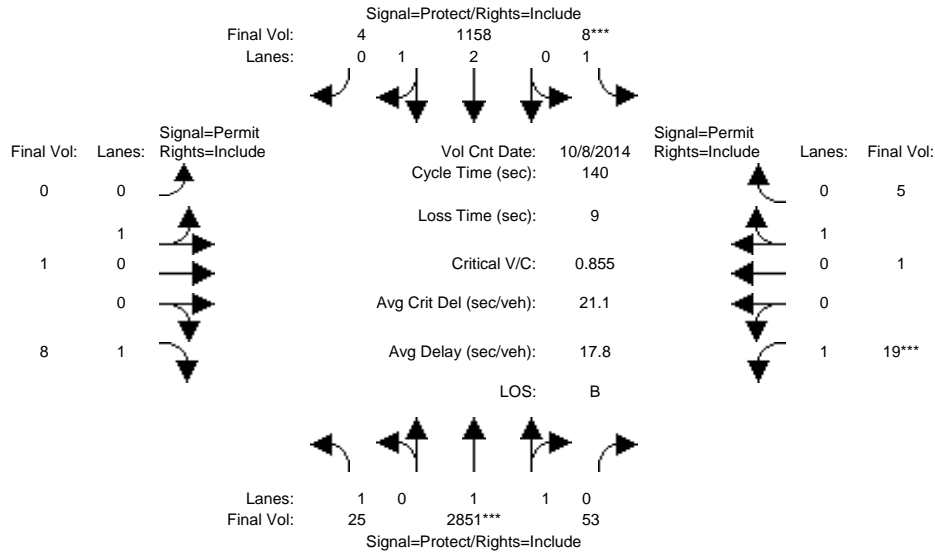

Approach:	North Bound			South Bound			East Bound			West Bound		
Movement:	L	T	R	L	T	R	L	T	R	L	T	R
Min. Green:	7	10	10	7	10	10	10	10	10	10	10	10
Y+R:	4.0	4.0	4.0	4.0	4.0	4.0	4.0	4.0	4.0	4.0	4.0	4.0
Volume Module: >> Count Date: 8 Oct 2014 <<												
Base Vol:	25	2851	53	8	1158	4	0	1	8	19	1	5
Growth Adj:	1.00	1.00	1.00	1.00	1.00	1.00	1.00	1.00	1.00	1.00	1.00	1.00
Initial Bse:	25	2851	53	8	1158	4	0	1	8	19	1	5
Added Vol:	0	0	0	0	0	0	0	0	0	0	0	0
PasserByVol:	0	0	0	0	0	0	0	0	0	0	0	0
Initial Fut:	25	2851	53	8	1158	4	0	1	8	19	1	5
User Adj:	1.00	1.00	1.00	1.00	1.00	1.00	1.00	1.00	1.00	1.00	1.00	1.00
PHF Adj:	1.00	1.00	1.00	1.00	1.00	1.00	1.00	1.00	1.00	1.00	1.00	1.00
PHF Volume:	25	2851	53	8	1158	4	0	1	8	19	1	5
Reduct Vol:	0	0	0	0	0	0	0	0	0	0	0	0
Reduced Vol:	25	2851	53	8	1158	4	0	1	8	19	1	5
PCE Adj:	1.00	1.00	1.00	1.00	1.00	1.00	1.00	1.00	1.00	1.00	1.00	1.00
MLF Adj:	1.00	1.00	1.00	1.00	1.00	1.00	1.00	1.00	1.00	1.00	1.00	1.00
FinalVolume:	25	2851	53	8	1158	4	0	1	8	19	1	5
Saturation Flow Module:												
Sat/Lane:	1900	1900	1900	1900	1900	1900	1900	1900	1900	1900	1900	1900
Adjustment:	0.92	0.97	0.95	0.92	0.98	0.95	0.95	0.95	0.92	0.92	0.95	0.95
Lanes:	1.00	1.96	0.04	1.00	2.99	0.01	0.00	1.00	1.00	1.00	0.17	0.83
Final Sat.:	1750	3632	68	1750	5581	19	0	1800	1750	1750	300	1500
Capacity Analysis Module:												
Vol/Sat:	0.01	0.78	0.78	0.00	0.21	0.21	0.00	0.00	0.00	0.01	0.00	0.00
Crit Moves:	****			****						****		
Green Time:	23.5	114	114.0	7.0	97.5	97.5	0.0	10.0	10.0	10.0	10.0	10.0
Volume/Cap:	0.09	0.96	0.96	0.09	0.30	0.30	0.00	0.01	0.06	0.15	0.05	0.05
Delay/Veh:	49.3	20.7	20.7	63.9	8.2	8.2	0.0	60.4	60.9	61.6	60.7	60.7
User DelAdj:	1.00	1.00	1.00	1.00	1.00	1.00	1.00	1.00	1.00	1.00	1.00	1.00
AdjDel/Veh:	49.3	20.7	20.7	63.9	8.2	8.2	0.0	60.4	60.9	61.6	60.7	60.7
LOS by Move:	D	C	C	E	A	A	A	E	E	E	E	E
HCM2k95thQ:	2	91	91	1	12	12	0	0	1	2	1	1

Note: Queue reported is the number of cars per lane.

BART Phase II Extension Project

Level Of Service Computation Report
2000 HCM Operations (Future Volume Alternative)
PM - 2025 Project Conditions

Intersection #3411: AVIATION/COLEMAN

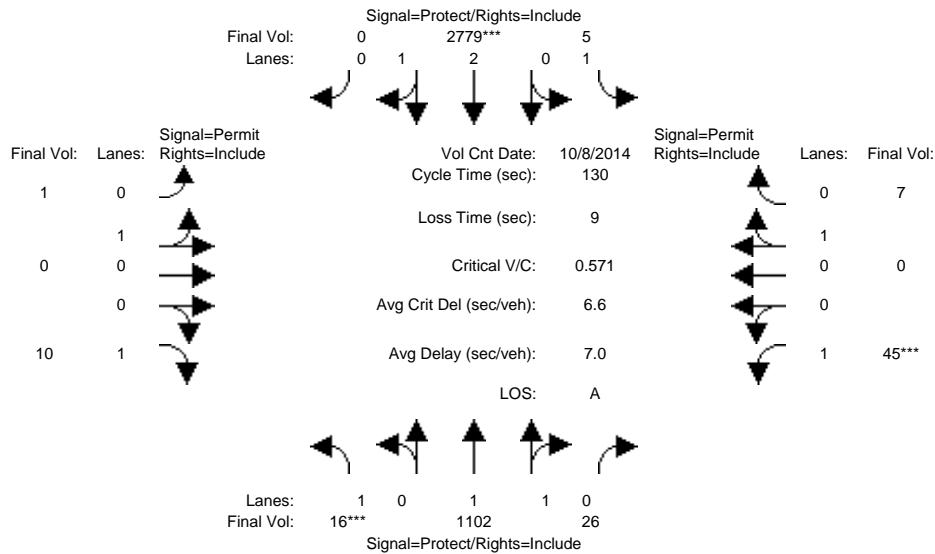

Approach:	North Bound			South Bound			East Bound			West Bound		
	L	T	R	L	T	R	L	T	R	L	T	R
Min. Green:	7	10	10	7	10	10	10	10	10	10	10	10
Y+R:	4.0	4.0	4.0	4.0	4.0	4.0	4.0	4.0	4.0	4.0	4.0	4.0

Volume Module:	>>	Count	Date:	8 Oct 2014	<<											
Base Vol:	16	1102	26	5	2779	0	1	0	10	45	0	7				
Growth Adj:	1.00	1.00	1.00	1.00	1.00	1.00	1.00	1.00	1.00	1.00	1.00	1.00				
Initial Bse:	16	1102	26	5	2779	0	1	0	10	45	0	7				
Added Vol:	0	0	0	0	0	0	0	0	0	0	0	0				
PasserByVol:	0	0	0	0	0	0	0	0	0	0	0	0				
Initial Fut:	16	1102	26	5	2779	0	1	0	10	45	0	7				
User Adj:	1.00	1.00	1.00	1.00	1.00	1.00	1.00	1.00	1.00	1.00	1.00	1.00				
PHF Adj:	1.00	1.00	1.00	1.00	1.00	1.00	1.00	1.00	1.00	1.00	1.00	1.00				
PHF Volume:	16	1102	26	5	2779	0	1	0	10	45	0	7				
Reduct Vol:	0	0	0	0	0	0	0	0	0	0	0	0				
Reduced Vol:	16	1102	26	5	2779	0	1	0	10	45	0	7				
PCE Adj:	1.00	1.00	1.00	1.00	1.00	1.00	1.00	1.00	1.00	1.00	1.00	1.00				
MLF Adj:	1.00	1.00	1.00	1.00	1.00	1.00	1.00	1.00	1.00	1.00	1.00	1.00				
FinalVolume:	16	1102	26	5	2779	0	1	0	10	45	0	7				

Saturation Flow Module:												
Sat/Lane:	1900	1900	1900	1900	1900	1900	1900	1900	1900	1900	1900	1900
Adjustment:	0.92	0.97	0.95	0.92	0.98	0.92	0.95	0.95	0.92	0.92	1.00	0.95
Lanes:	1.00	1.95	0.05	1.00	3.00	0.00	1.00	0.00	1.00	1.00	0.00	1.00
Final Sat.:	1750	3615	85	1750	5600	0	1800	0	1750	1750	0	1800

Capacity Analysis Module:												
Vol/Sat:	0.01	0.30	0.30	0.00	0.50	0.00	0.00	0.00	0.01	0.03	0.00	0.00
Crit Moves:	****				****					****		
Green Time:	7.0	94.3	94.3	16.7	104	0.0	10.0	0.0	10.0	10.0	0.0	10.0
Volume/Cap:	0.17	0.42	0.42	0.02	0.62	0.00	0.01	0.00	0.07	0.33	0.00	0.05
Delay/Veh:	59.6	7.1	7.1	49.6	5.4	0.0	55.4	0.0	55.9	58.3	0.0	55.8
User DelAdj:	1.00	1.00	1.00	1.00	1.00	1.00	1.00	1.00	1.00	1.00	1.00	1.00
AdjDel/Veh:	59.6	7.1	7.1	49.6	5.4	0.0	55.4	0.0	55.9	58.3	0.0	55.8
LOS by Move:	E	A	A	D	A	A	E	A	E	E	A	E
HCM2k95thQ:	1	17	17	0	25	0	0	0	1	4	0	1

Note: Queue reported is the number of cars per lane.

BART Phase II Extension Project

Level Of Service Computation Report
2000 HCM Operations (Future Volume Alternative)
AM - 2025 Project Conditions

Intersection #4047: COLEMAN/NEWHALL

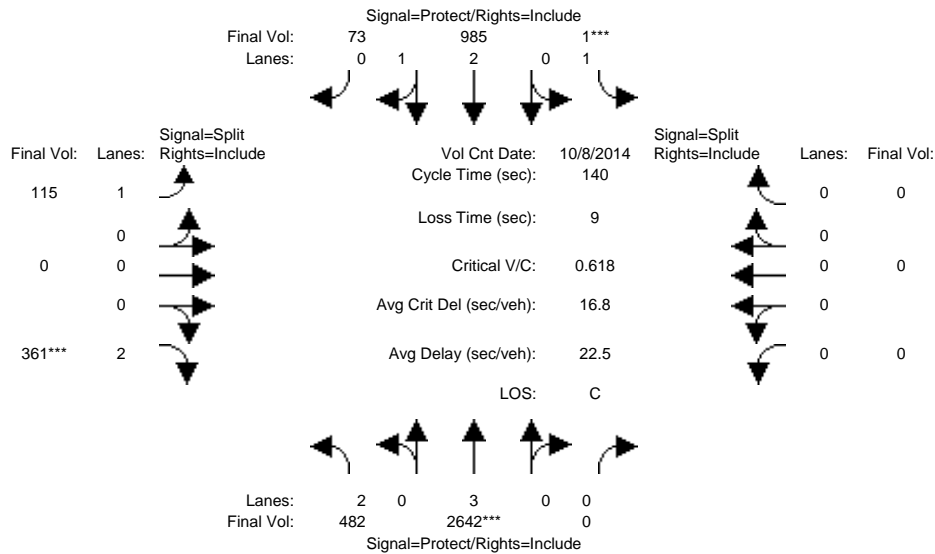

Approach:	North Bound			South Bound			East Bound			West Bound		
Movement:	L	T	R	L	T	R	L	T	R	L	T	R
Min. Green:	7	10	0	7	10	10	10	0	10	0	0	0
Y+R:	4.0	4.0	4.0	4.0	4.0	4.0	4.0	4.0	4.0	4.0	4.0	4.0
Volume Module: >> Count Date: 8 Oct 2014 <<												
Base Vol:	482	2642	0	1	985	73	115	0	361	0	0	0
Growth Adj:	1.00	1.00	1.00	1.00	1.00	1.00	1.00	1.00	1.00	1.00	1.00	1.00
Initial Bse:	482	2642	0	1	985	73	115	0	361	0	0	0
Added Vol:	0	0	0	0	0	0	0	0	0	0	0	0
PasserByVol:	0	0	0	0	0	0	0	0	0	0	0	0
Initial Fut:	482	2642	0	1	985	73	115	0	361	0	0	0
User Adj:	1.00	1.00	1.00	1.00	1.00	1.00	1.00	1.00	1.00	1.00	1.00	1.00
PHF Adj:	1.00	1.00	1.00	1.00	1.00	1.00	1.00	1.00	1.00	1.00	1.00	1.00
PHF Volume:	482	2642	0	1	985	73	115	0	361	0	0	0
Reduct Vol:	0	0	0	0	0	0	0	0	0	0	0	0
Reduced Vol:	482	2642	0	1	985	73	115	0	361	0	0	0
PCE Adj:	1.00	1.00	1.00	1.00	1.00	1.00	1.00	1.00	1.00	1.00	1.00	1.00
MLF Adj:	1.00	1.00	1.00	1.00	1.00	1.00	1.00	1.00	1.00	1.00	1.00	1.00
FinalVolume:	482	2642	0	1	985	73	115	0	361	0	0	0
Saturation Flow Module:												
Sat/Lane:	1900	1900	1900	1900	1900	1900	1900	1900	1900	1900	1900	1900
Adjustment:	0.83	1.00	0.92	0.92	0.99	0.95	0.92	1.00	0.83	0.92	1.00	0.92
Lanes:	2.00	3.00	0.00	1.00	2.79	0.21	1.00	0.00	2.00	0.00	0.00	0.00
Final Sat.:	3150	5700	0	1750	5213	386	1750	0	3150	0	0	0
Capacity Analysis Module:												
Vol/Sat:	0.15	0.46	0.00	0.00	0.19	0.19	0.07	0.00	0.11	0.00	0.00	0.00
Crit Moves:	****			****			****			****		
Green Time:	47.6	99.4	0.0	7.0	58.8	58.8	24.6	0.0	24.6	0.0	0.0	0.0
Volume/Cap:	0.45	0.65	0.00	0.01	0.45	0.45	0.37	0.00	0.65	0.00	0.00	0.00
Delay/Veh:	36.3	11.4	0.0	63.3	29.2	29.2	51.7	0.0	56.5	0.0	0.0	0.0
User DelAdj:	1.00	1.00	1.00	1.00	1.00	1.00	1.00	1.00	1.00	1.00	1.00	1.00
AdjDel/Veh:	36.3	11.4	0.0	63.3	29.2	29.2	51.7	0.0	56.5	0.0	0.0	0.0
LOS by Move:	D	B	A	E	C	C	D	A	E	A	A	A
HCM2k95thQ:	18	34	0	0	19	19	10	0	18	0	0	0

Note: Queue reported is the number of cars per lane.

BART Phase II Extension Project

Level Of Service Computation Report
2000 HCM Operations (Future Volume Alternative)
PM - 2025 Project Conditions

Intersection #4047: COLEMAN/NEWHALL

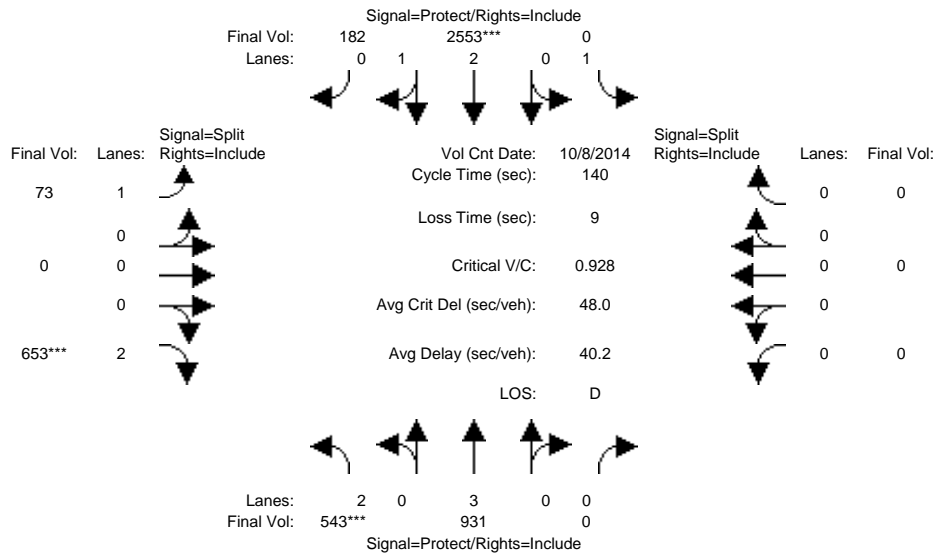

Approach:	North Bound			South Bound			East Bound			West Bound		
Movement:	L	T	R	L	T	R	L	T	R	L	T	R
Min. Green:	7	10	0	7	10	10	10	0	10	0	0	0
Y+R:	4.0	4.0	4.0	4.0	4.0	4.0	4.0	4.0	4.0	4.0	4.0	4.0
Volume Module: >> Count Date: 8 Oct 2014 <<												
Base Vol:	543	931	0	0	2553	182	73	0	653	0	0	0
Growth Adj:	1.00	1.00	1.00	1.00	1.00	1.00	1.00	1.00	1.00	1.00	1.00	1.00
Initial Bse:	543	931	0	0	2553	182	73	0	653	0	0	0
Added Vol:	0	0	0	0	0	0	0	0	0	0	0	0
PasserByVol:	0	0	0	0	0	0	0	0	0	0	0	0
Initial Fut:	543	931	0	0	2553	182	73	0	653	0	0	0
User Adj:	1.00	1.00	1.00	1.00	1.00	1.00	1.00	1.00	1.00	1.00	1.00	1.00
PHF Adj:	1.00	1.00	1.00	1.00	1.00	1.00	1.00	1.00	1.00	1.00	1.00	1.00
PHF Volume:	543	931	0	0	2553	182	73	0	653	0	0	0
Reduct Vol:	0	0	0	0	0	0	0	0	0	0	0	0
Reduced Vol:	543	931	0	0	2553	182	73	0	653	0	0	0
PCE Adj:	1.00	1.00	1.00	1.00	1.00	1.00	1.00	1.00	1.00	1.00	1.00	1.00
MLF Adj:	1.00	1.00	1.00	1.00	1.00	1.00	1.00	1.00	1.00	1.00	1.00	1.00
FinalVolume:	543	931	0	0	2553	182	73	0	653	0	0	0
Saturation Flow Module:												
Sat/Lane:	1900	1900	1900	1900	1900	1900	1900	1900	1900	1900	1900	1900
Adjustment:	0.83	1.00	0.92	0.92	0.98	0.95	0.92	1.00	0.83	0.92	1.00	0.92
Lanes:	2.00	3.00	0.00	1.00	2.79	0.21	1.00	0.00	2.00	0.00	0.00	0.00
Final Sat.:	3150	5700	0	1750	5227	373	1750	0	3150	0	0	0
Capacity Analysis Module:												
Vol/Sat:	0.17	0.16	0.00	0.00	0.49	0.49	0.04	0.00	0.21	0.00	0.00	0.00
Crit Moves:	****			****			****					
Green Time:	26.0	99.7	0.0	0.0	73.7	73.7	31.3	0.0	31.3	0.0	0.0	0.0
Volume/Cap:	0.93	0.23	0.00	0.00	0.93	0.93	0.19	0.00	0.93	0.00	0.00	0.00
Delay/Veh:	77.2	7.0	0.0	0.0	36.6	36.6	44.3	0.0	71.8	0.0	0.0	0.0
User DelAdj:	1.00	1.00	1.00	1.00	1.00	1.00	1.00	1.00	1.00	1.00	1.00	1.00
AdjDel/Veh:	77.2	7.0	0.0	0.0	36.6	36.6	44.3	0.0	71.8	0.0	0.0	0.0
LOS by Move:	E	A	A	A	D	D	D	A	E	A	A	A
HCM2k95thQ:	30	9	0	0	61	61	5	0	34	0	0	0

Note: Queue reported is the number of cars per lane.

BART Phase II Extension Project

Level Of Service Computation Report
 2000 HCM Operations (Future Volume Alternative)
 AM - 2025 Project Conditions

Intersection #5335: CENTRAL EXPWY/DE LA CRUZ BLVD

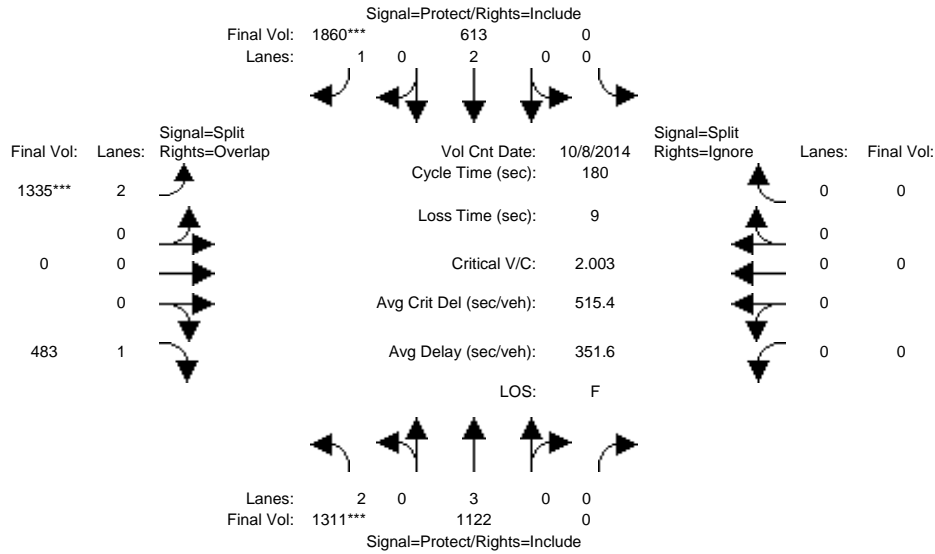

Approach:	North Bound			South Bound			East Bound			West Bound		
Movement:	L	T	R	L	T	R	L	T	R	L	T	R
Min. Green:	7	10	0	0	10	10	10	0	10	0	0	0
Y+R:	4.0	4.0	4.0	4.0	4.0	4.0	4.0	4.0	4.0	4.0	4.0	4.0
Volume Module: >> Count Date: 8 Oct 2014 <<												
Base Vol:	1311	1122	0	0	613	1860	1535	0	483	0	0	0
Growth Adj:	1.00	1.00	1.00	1.00	1.00	1.00	1.00	1.00	1.00	1.00	1.00	1.00
Initial Bse:	1311	1122	0	0	613	1860	1535	0	483	0	0	0
Added Vol:	0	0	0	0	0	0	0	0	0	0	0	0
PasserByVol:	0	0	0	0	0	0	0	0	0	0	0	0
Initial Fut:	1311	1122	0	0	613	1860	1535	0	483	0	0	0
User Adj:	1.00	1.00	1.00	1.00	1.00	1.00	0.87	1.00	1.00	1.00	1.00	0.00
PHF Adj:	1.00	1.00	1.00	1.00	1.00	1.00	1.00	1.00	1.00	1.00	1.00	0.00
PHF Volume:	1311	1122	0	0	613	1860	1335	0	483	0	0	0
Reduct Vol:	0	0	0	0	0	0	0	0	0	0	0	0
Reduced Vol:	1311	1122	0	0	613	1860	1335	0	483	0	0	0
PCE Adj:	1.00	1.00	1.00	1.00	1.00	1.00	1.00	1.00	1.00	1.00	1.00	0.00
MLF Adj:	1.00	1.00	1.00	1.00	1.00	1.00	1.00	1.00	1.00	1.00	1.00	0.00
FinalVolume:	1311	1122	0	0	613	1860	1335	0	483	0	0	0
Saturation Flow Module:												
Sat/Lane:	1900	1900	1900	1900	1900	1900	1900	1900	1900	1900	1900	1900
Adjustment:	0.83	1.00	0.92	0.92	1.00	0.92	0.83	1.00	0.92	0.92	1.00	0.92
Lanes:	2.00	3.00	0.00	0.00	2.00	1.00	2.00	0.00	1.00	0.00	0.00	0.00
Final Sat.:	3150	5700	0	0	3800	1750	3150	0	1750	0	0	0
Capacity Analysis Module:												
Vol/Sat:	0.42	0.20	0.00	0.00	0.16	1.06	0.42	0.00	0.28	0.00	0.00	0.00
Crit Moves:	****					****	****					
Green Time:	37.4	133	0.0	0.0	95.5	95.5	38.1	0.0	75.5	0.0	0.0	0.0
Volume/Cap:	2.00	0.27	0.00	0.00	0.30	2.00	2.00	0.00	0.66	0.00	0.00	0.00
Delay/Veh:	528.1	7.7	0.0	0.0	23.7	497.5	527.7	0.0	38.8	0.0	0.0	0.0
User DelAdj:	1.00	1.00	1.00	1.00	1.00	1.00	1.00	1.00	1.00	1.00	1.00	1.00
AdjDel/Veh:	528.1	7.7	0.0	0.0	23.7	497.5	527.7	0.0	38.8	0.0	0.0	0.0
LOS by Move:	F	A	A	A	C	F	F	A	D	A	A	A
HCM2k95thQ:	136	13	0	0	17	344	138	0	34	0	0	0

Note: Queue reported is the number of cars per lane.

BART Phase II Extension Project

Level Of Service Computation Report
 2000 HCM Operations (Future Volume Alternative)
 PM - 2025 Project Conditions

Intersection #5335: CENTRAL EXPWY/DE LA CRUZ BLVD

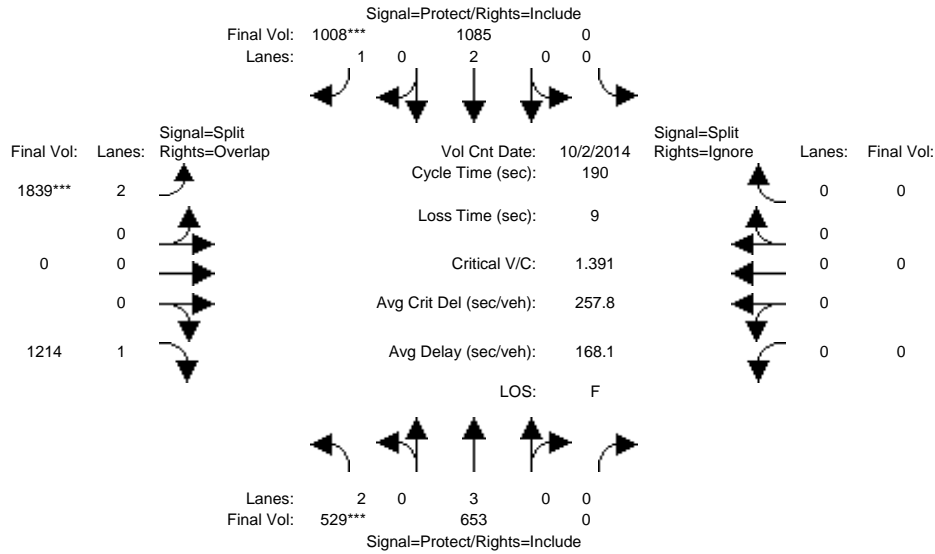

Approach:	North Bound			South Bound			East Bound			West Bound		
	L	T	R	L	T	R	L	T	R	L	T	R
Min. Green:	19	76	0	0	57	57	114	0	114	0	0	0
Y+R:	4.0	4.0	4.0	4.0	4.0	4.0	4.0	4.0	4.0	4.0	4.0	4.0
Volume Module: >> Count Date: 2 Oct 2014 <<												
Base Vol:	529	653	0	0	1085	1008	2485	0	1214	0	0	0
Growth Adj:	1.00	1.00	1.00	1.00	1.00	1.00	1.00	1.00	1.00	1.00	1.00	1.00
Initial Bse:	529	653	0	0	1085	1008	2485	0	1214	0	0	0
Added Vol:	0	0	0	0	0	0	0	0	0	0	0	0
PasserByVol:	0	0	0	0	0	0	0	0	0	0	0	0
Initial Fut:	529	653	0	0	1085	1008	2485	0	1214	0	0	0
User Adj:	1.00	1.00	1.00	1.00	1.00	1.00	0.74	1.00	1.00	1.00	1.00	0.00
PHF Adj:	1.00	1.00	1.00	1.00	1.00	1.00	1.00	1.00	1.00	1.00	1.00	0.00
PHF Volume:	529	653	0	0	1085	1008	1839	0	1214	0	0	0
Reduct Vol:	0	0	0	0	0	0	0	0	0	0	0	0
Reduced Vol:	529	653	0	0	1085	1008	1839	0	1214	0	0	0
PCE Adj:	1.00	1.00	1.00	1.00	1.00	1.00	1.00	1.00	1.00	1.00	1.00	0.00
MLF Adj:	1.00	1.00	1.00	1.00	1.00	1.00	1.00	1.00	1.00	1.00	1.00	0.00
Final Volume:	529	653	0	0	1085	1008	1839	0	1214	0	0	0
Saturation Flow Module:												
Sat/Lane:	1900	1900	1900	1900	1900	1900	1900	1900	1900	1900	1900	1900
Adjustment:	0.83	1.00	0.92	0.92	1.00	0.92	0.83	1.00	0.92	0.92	1.00	0.92
Lanes:	2.00	3.00	0.00	0.00	2.00	1.00	2.00	0.00	1.00	0.00	0.00	0.00
Final Sat.:	3150	5700	0	0	3800	1750	3150	0	1750	0	0	0
Capacity Analysis Module:												
Vol/Sat:	0.17	0.11	0.00	0.00	0.29	0.58	0.58	0.00	0.69	0.00	0.00	0.00
Crit Moves:	****				****	****	****					
Green Time:	18.1	72.6	0.0	0.0	54.4	54.4	108.8	0.0	127.0	0.0	0.0	0.0
Volume/Cap:	1.76	0.30	0.00	0.00	1.00	2.01	1.02	0.00	1.04	0.00	0.00	0.00
Delay/Veh:	444.9	43.0	0.0	0.0	97.4	533.0	53.1	0.0	49.1	0.0	0.0	0.0
User DelAdj:	1.00	1.00	1.00	1.00	1.00	1.00	1.00	1.00	1.00	1.00	1.00	1.00
AdjDel/Veh:	444.9	43.0	0.0	0.0	97.4	533.0	53.1	0.0	49.1	0.0	0.0	0.0
LOS by Move:	F	D	A	A	F	F	D	A	D	A	A	A
HCM2k95thQ:	57	16	0	0	58	196	113	0	136	0	0	0

Note: Queue reported is the number of cars per lane.

BART Phase II Extension Project

Level Of Service Computation Report
2000 HCM Operations (Future Volume Alternative)
AM - 2025 Project Conditions

Intersection #5416: SAN TOMAS EXPWY/EL CAMINO REAL

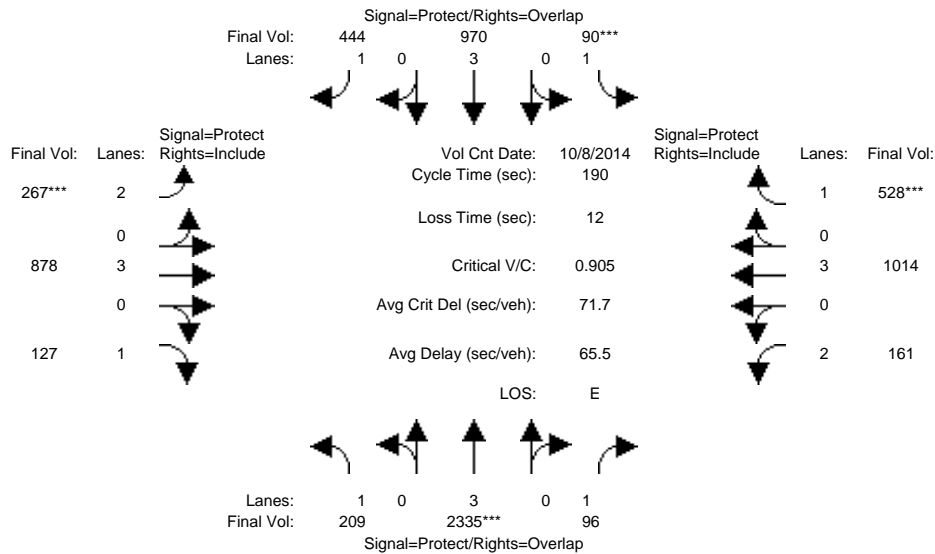

Approach:	North Bound			South Bound			East Bound			West Bound		
	L	T	R	L	T	R	L	T	R	L	T	R
Min. Green:	7	10	10	7	10	10	7	10	10	7	10	10
Y+R:	4.0	4.0	4.0	4.0	4.0	4.0	4.0	4.0	4.0	4.0	4.0	4.0
Volume Module: >> Count Date: 8 Oct 2014 <<												
Base Vol:	209	2780	96	90	1155	444	267	878	127	161	1014	528
Growth Adj:	1.00	1.00	1.00	1.00	1.00	1.00	1.00	1.00	1.00	1.00	1.00	1.00
Initial Bse:	209	2780	96	90	1155	444	267	878	127	161	1014	528
Added Vol:	0	0	0	0	0	0	0	0	0	0	0	0
PasserByVol:	0	0	0	0	0	0	0	0	0	0	0	0
Initial Fut:	209	2780	96	90	1155	444	267	878	127	161	1014	528
User Adj:	1.00	0.84	1.00	1.00	0.84	1.00	1.00	1.00	1.00	1.00	1.00	1.00
PHF Adj:	1.00	1.00	1.00	1.00	1.00	1.00	1.00	1.00	1.00	1.00	1.00	1.00
PHF Volume:	209	2335	96	90	970	444	267	878	127	161	1014	528
Reduct Vol:	0	0	0	0	0	0	0	0	0	0	0	0
Reduced Vol:	209	2335	96	90	970	444	267	878	127	161	1014	528
PCE Adj:	1.00	1.00	1.00	1.00	1.00	1.00	1.00	1.00	1.00	1.00	1.00	1.00
MLF Adj:	1.00	1.00	1.00	1.00	1.00	1.00	1.00	1.00	1.00	1.00	1.00	1.00
FinalVolume:	209	2335	96	90	970	444	267	878	127	161	1014	528
Saturation Flow Module:												
Sat/Lane:	1900	1900	1900	1900	1900	1900	1900	1900	1900	1900	1900	1900
Adjustment:	0.92	1.00	0.92	0.92	1.00	0.92	0.83	1.00	0.92	0.83	1.00	0.92
Lanes:	1.00	3.00	1.00	1.00	3.00	1.00	2.00	3.00	1.00	2.00	3.00	1.00
Final Sat.:	1750	5700	1750	1750	5700	1750	3150	5700	1750	3150	5700	1750
Capacity Analysis Module:												
Vol/Sat:	0.12	0.41	0.05	0.05	0.17	0.25	0.08	0.15	0.07	0.05	0.18	0.30
Crit Moves:	****	****	****	****	****	****	****	****	****	****	****	****
Green Time:	39.9	86.0	106.3	10.8	56.9	74.7	17.8	60.9	60.9	20.2	63.4	63.4
Volume/Cap:	0.57	0.90	0.10	0.90	0.57	0.65	0.90	0.48	0.23	0.48	0.53	0.90
Delay/Veh:	70.2	62.2	25.9	153.1	72.6	69.2	114.5	52.0	47.5	81.0	51.6	78.0
User DelAdj:	1.00	1.00	1.00	1.00	1.00	1.00	1.00	1.00	1.00	1.00	1.00	1.00
AdjDel/Veh:	70.2	62.2	25.9	153.1	72.6	69.2	114.5	52.0	47.5	81.0	51.6	78.0
LOS by Move:	E	E	C	F	E	E	F	D	D	F	D	E
HCM2k95thQ:	22	70	7	12	30	42	22	24	11	10	27	54

Note: Queue reported is the number of cars per lane.

BART Phase II Extension Project

Level Of Service Computation Report
2000 HCM Operations (Future Volume Alternative)
PM - 2025 Project Conditions

Intersection #5416: SAN TOMAS EXPWY/EL CAMINO REAL

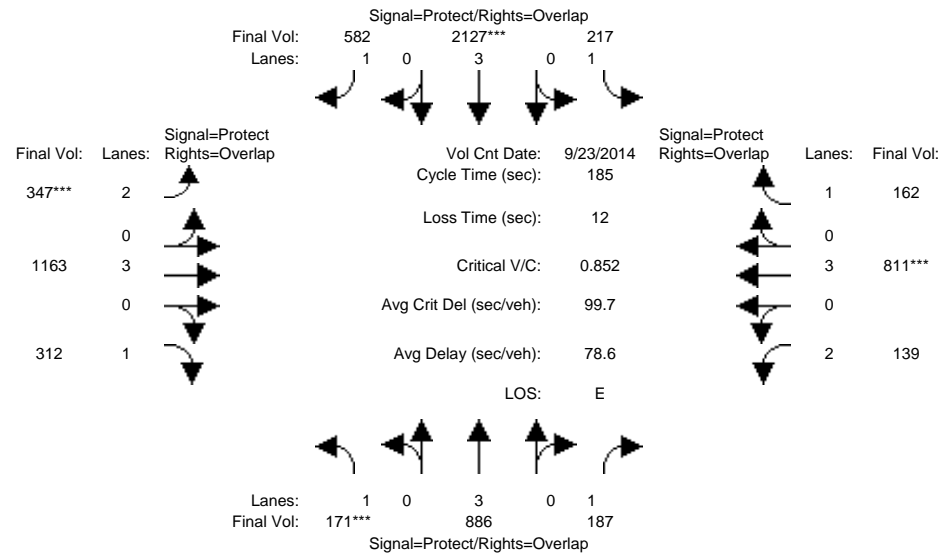

Approach:	North Bound			South Bound			East Bound			West Bound		
Movement:	L	T	R	L	T	R	L	T	R	L	T	R
Min. Green:	12	72	72	33	93	93	39	50	50	29	41	41
Y+R:	4.0	4.0	4.0	4.0	4.0	4.0	4.0	4.0	4.0	4.0	4.0	4.0
Volume Module: >> Count Date: 23 Sep 2014 <<												
Base Vol:	171	1166	187	217	2762	582	347	1163	312	139	811	162
Growth Adj:	1.00	1.00	1.00	1.00	1.00	1.00	1.00	1.00	1.00	1.00	1.00	1.00
Initial Bse:	171	1166	187	217	2762	582	347	1163	312	139	811	162
Added Vol:	0	0	0	0	0	0	0	0	0	0	0	0
PasserByVol:	0	0	0	0	0	0	0	0	0	0	0	0
Initial Fut:	171	1166	187	217	2762	582	347	1163	312	139	811	162
User Adj:	1.00	0.76	1.00	1.00	0.77	1.00	1.00	1.00	1.00	1.00	1.00	1.00
PHF Adj:	1.00	1.00	1.00	1.00	1.00	1.00	1.00	1.00	1.00	1.00	1.00	1.00
PHF Volume:	171	886	187	217	2127	582	347	1163	312	139	811	162
Reduct Vol:	0	0	0	0	0	0	0	0	0	0	0	0
Reduced Vol:	171	886	187	217	2127	582	347	1163	312	139	811	162
PCE Adj:	1.00	1.00	1.00	1.00	1.00	1.00	1.00	1.00	1.00	1.00	1.00	1.00
MLF Adj:	1.00	1.00	1.00	1.00	1.00	1.00	1.00	1.00	1.00	1.00	1.00	1.00
Final Volume:	171	886	187	217	2127	582	347	1163	312	139	811	162
Saturation Flow Module:												
Sat/Lane:	1900	1900	1900	1900	1900	1900	1900	1900	1900	1900	1900	1900
Adjustment:	0.92	1.00	0.92	0.92	0.83	0.92	0.83	1.00	0.92	0.83	1.00	0.92
Lanes:	1.00	3.00	1.00	1.00	3.00	1.00	2.00	3.00	1.00	2.00	3.00	1.00
Final Sat.:	1750	5700	1750	1750	4731	1750	3150	5700	1750	3150	5700	1750
Capacity Analysis Module:												
Vol/Sat:	0.10	0.16	0.11	0.12	0.45	0.33	0.11	0.20	0.18	0.04	0.14	0.09
Crit Moves:	****				****		****				****	
Green Time:	11.3	67.6	95.2	31.0	87.3	124.0	36.6	47.5	58.8	27.6	38.5	69.5
Volume/Cap:	1.60	0.43	0.21	0.74	0.95	0.50	0.56	0.79	0.56	0.30	0.68	0.25
Delay/Veh:	403.6	52.2	32.8	98.0	89.7	38.2	72.3	71.4	57.1	75.0	73.7	42.5
User DelAdj:	1.00	1.00	1.00	1.00	1.00	1.00	1.00	1.00	1.00	1.00	1.00	1.00
AdjDel/Veh:	403.6	52.2	32.8	98.0	89.7	38.2	72.3	71.4	57.1	75.0	73.7	42.5
LOS by Move:	F	D	C	F	F	D	E	E	E	E	E	D
HCM2k95thQ:	33	25	15	25	70	50	21	38	29	8	26	13

Note: Queue reported is the number of cars per lane.

BART Phase II Extension Project

Level Of Service Computation Report
2000 HCM Operations (Future Volume Alternative)
AM - 2025 Project Conditions

Intersection #5444: Lafayette/Lewis

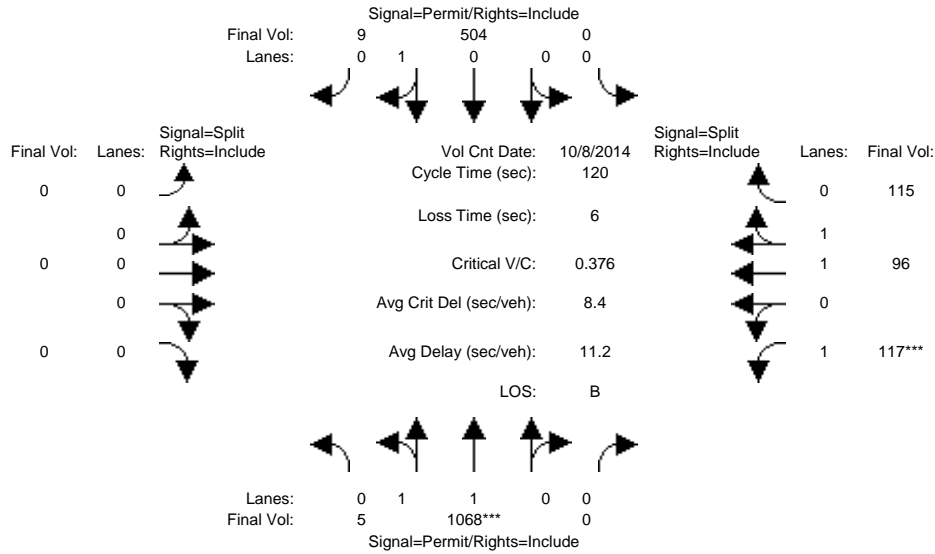

Approach:	North Bound			South Bound			East Bound			West Bound		
	L	T	R	L	T	R	L	T	R	L	T	R
Min. Green:	10	10	0	0	10	10	0	0	0	10	10	10
Y+R:	4.0	4.0	4.0	4.0	4.0	4.0	4.0	4.0	4.0	4.0	4.0	4.0
Volume Module: >> Count Date: 8 Oct 2014 <<												
Base Vol:	5	1068	0	0	504	9	0	0	0	117	96	115
Growth Adj:	1.00	1.00	1.00	1.00	1.00	1.00	1.00	1.00	1.00	1.00	1.00	1.00
Initial Bse:	5	1068	0	0	504	9	0	0	0	117	96	115
Added Vol:	0	0	0	0	0	0	0	0	0	0	0	0
PasserByVol:	0	0	0	0	0	0	0	0	0	0	0	0
Initial Fut:	5	1068	0	0	504	9	0	0	0	117	96	115
User Adj:	1.00	1.00	1.00	1.00	1.00	1.00	1.00	1.00	1.00	1.00	1.00	1.00
PHF Adj:	1.00	1.00	1.00	1.00	1.00	1.00	1.00	1.00	1.00	1.00	1.00	1.00
PHF Volume:	5	1068	0	0	504	9	0	0	0	117	96	115
Reduct Vol:	0	0	0	0	0	0	0	0	0	0	0	0
Reduced Vol:	5	1068	0	0	504	9	0	0	0	117	96	115
PCE Adj:	1.00	1.00	1.00	1.00	1.00	1.00	1.00	1.00	1.00	1.00	1.00	1.00
MLF Adj:	1.00	1.00	1.00	1.00	1.00	1.00	1.00	1.00	1.00	1.00	1.00	1.00
FinalVolume:	5	1068	0	0	504	9	0	0	0	117	96	115
Saturation Flow Module:												
Sat/Lane:	1900	1900	1900	1900	1900	1900	1900	1900	1900	1900	1900	1900
Adjustment:	0.95	0.97	0.92	0.92	0.95	0.95	0.92	1.00	0.92	0.92	1.00	0.92
Lanes:	0.01	1.99	0.00	0.00	0.98	0.02	0.00	0.00	0.00	1.00	1.00	1.00
Final Sat.:	17	3683	0	0	1768	32	0	0	0	1750	1900	1750
Capacity Analysis Module:												
Vol/Sat:	0.29	0.29	0.00	0.00	0.29	0.29	0.00	0.00	0.00	0.07	0.05	0.07
Crit Moves:	****											
Green Time:	92.6	92.6	0.0	0.0	92.6	92.6	0.0	0.0	0.0	21.4	21.4	21.4
Volume/Cap:	0.38	0.38	0.00	0.00	0.37	0.37	0.00	0.00	0.00	0.38	0.28	0.37
Delay/Veh:	4.5	4.5	0.0	0.0	4.5	4.5	0.0	0.0	0.0	44.2	42.9	43.8
User DelAdj:	1.00	1.00	1.00	1.00	1.00	1.00	1.00	1.00	1.00	1.00	1.00	1.00
AdjDel/Veh:	4.5	4.5	0.0	0.0	4.5	4.5	0.0	0.0	0.0	44.2	42.9	43.8
LOS by Move:	A	A	A	A	A	A	A	A	A	D	D	D
HCM2k95thQ:	12	12	0	0	12	12	0	0	0	9	6	8

Note: Queue reported is the number of cars per lane.

BART Phase II Extension Project

Level Of Service Computation Report
 2000 HCM Operations (Future Volume Alternative)
 PM - 2025 Project Conditions

Intersection #5444: Lafayette/Lewis

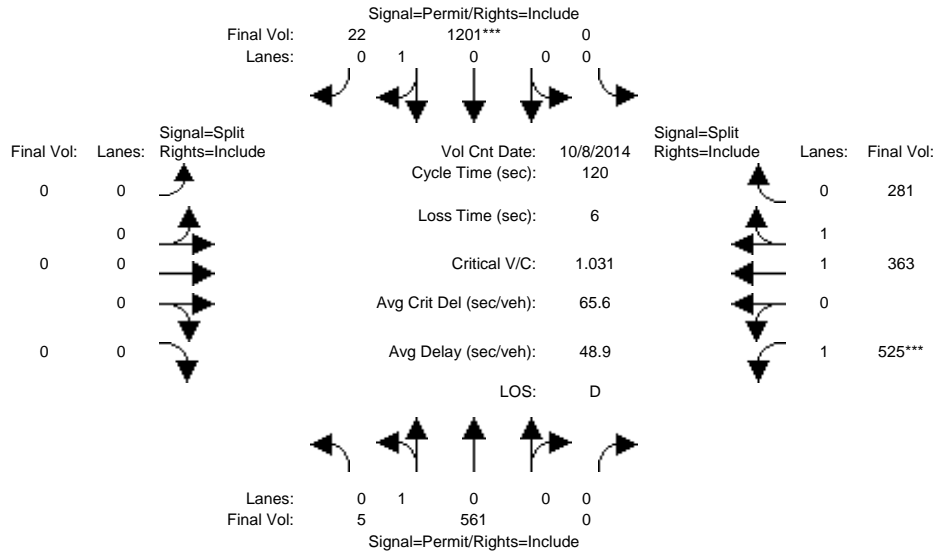

Approach:	North Bound			South Bound			East Bound			West Bound		
	L	T	R	L	T	R	L	T	R	L	T	R
Min. Green:	10	10	0	0	10	10	0	0	0	10	10	10
Y+R:	4.0	4.0	4.0	4.0	4.0	4.0	4.0	4.0	4.0	4.0	4.0	4.0
Volume Module: >> Count Date: 8 Oct 2014 <<												
Base Vol:	5	561	0	0	1201	22	0	0	0	525	363	281
Growth Adj:	1.00	1.00	1.00	1.00	1.00	1.00	1.00	1.00	1.00	1.00	1.00	1.00
Initial Bse:	5	561	0	0	1201	22	0	0	0	525	363	281
Added Vol:	0	0	0	0	0	0	0	0	0	0	0	0
PasserByVol:	0	0	0	0	0	0	0	0	0	0	0	0
Initial Fut:	5	561	0	0	1201	22	0	0	0	525	363	281
User Adj:	1.00	1.00	1.00	1.00	1.00	1.00	1.00	1.00	1.00	1.00	1.00	1.00
PHF Adj:	1.00	1.00	1.00	1.00	1.00	1.00	1.00	1.00	1.00	1.00	1.00	1.00
PHF Volume:	5	561	0	0	1201	22	0	0	0	525	363	281
Reduct Vol:	0	0	0	0	0	0	0	0	0	0	0	0
Reduced Vol:	5	561	0	0	1201	22	0	0	0	525	363	281
PCE Adj:	1.00	1.00	1.00	1.00	1.00	1.00	1.00	1.00	1.00	1.00	1.00	1.00
MLF Adj:	1.00	1.00	1.00	1.00	1.00	1.00	1.00	1.00	1.00	1.00	1.00	1.00
FinalVolume:	5	561	0	0	1201	22	0	0	0	525	363	281
Saturation Flow Module:												
Sat/Lane:	1900	1900	1900	1900	1900	1900	1900	1900	1900	1900	1900	1900
Adjustment:	0.95	0.95	0.92	0.92	0.95	0.95	0.92	1.00	0.92	0.92	0.99	0.95
Lanes:	0.01	0.99	0.00	0.00	0.98	0.02	0.00	0.00	0.00	1.00	1.10	0.90
Final Sat.:	16	1784	0	0	1768	32	0	0	0	1750	2084	1614
Capacity Analysis Module:												
Vol/Sat:	0.31	0.31	0.00	0.00	0.68	0.68	0.00	0.00	0.00	0.30	0.17	0.17
Crit Moves:	****											
Green Time:	79.1	79.1	0.0	0.0	79.1	79.1	0.0	0.0	0.0	34.9	34.9	34.9
Volume/Cap:	0.48	0.48	0.00	0.00	1.03	1.03	0.00	0.00	0.00	1.03	0.60	0.60
Delay/Veh:	10.5	10.5	0.0	0.0	54.9	54.9	0.0	0.0	0.0	90.6	37.5	37.5
User DelAdj:	1.00	1.00	1.00	1.00	1.00	1.00	1.00	1.00	1.00	1.00	1.00	1.00
AdjDel/Veh:	10.5	10.5	0.0	0.0	54.9	54.9	0.0	0.0	0.0	90.6	37.5	37.5
LOS by Move:	B	B	A	A	D	D	A	A	A	F	D	D
HCM2k95thQ:	19	19	0	0	85	85	0	0	0	46	20	20

Note: Queue reported is the number of cars per lane.

BART Phase II Extension Project

Level Of Service Computation Report
 2000 HCM Operations (Future Volume Alternative)
 AM - 2025 SC West Project Conditions

Intersection #6: DE LA CRUZ/MARTIN

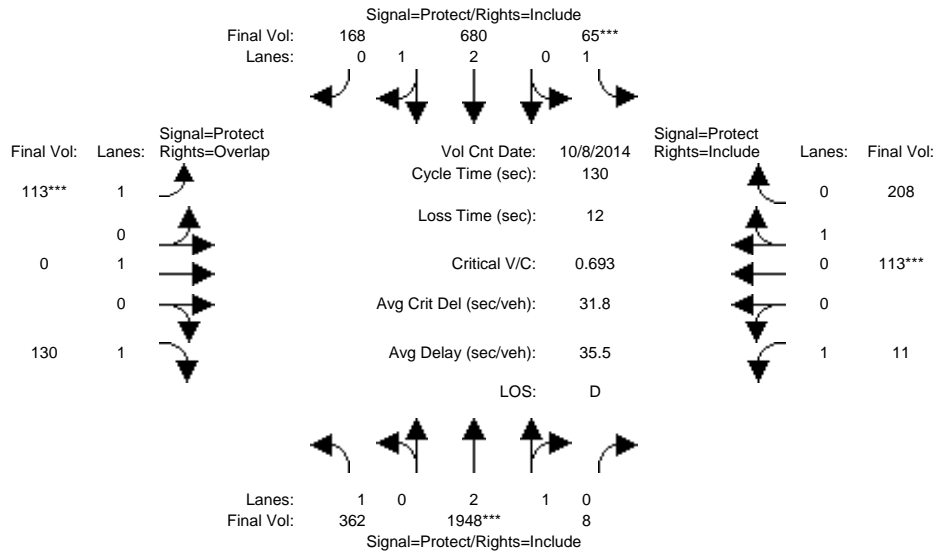

Approach:	North Bound			South Bound			East Bound			West Bound		
Movement:	L	T	R	L	T	R	L	T	R	L	T	R
Min. Green:	7	10	10	7	10	10	7	10	10	7	10	10
Y+R:	4.0	4.0	4.0	4.0	4.0	4.0	4.0	4.0	4.0	4.0	4.0	4.0

Volume Module:	>> Count			Date:	8 Oct 2014			<<				
Base Vol:	362	1948	8	65	680	168	113	0	130	11	113	208
Growth Adj:	1.00	1.00	1.00	1.00	1.00	1.00	1.00	1.00	1.00	1.00	1.00	1.00
Initial Bse:	362	1948	8	65	680	168	113	0	130	11	113	208
Added Vol:	0	0	0	0	0	0	0	0	0	0	0	0
PasserByVol:	0	0	0	0	0	0	0	0	0	0	0	0
Initial Fut:	362	1948	8	65	680	168	113	0	130	11	113	208
User Adj:	1.00	1.00	1.00	1.00	1.00	1.00	1.00	1.00	1.00	1.00	1.00	1.00
PHF Adj:	1.00	1.00	1.00	1.00	1.00	1.00	1.00	1.00	1.00	1.00	1.00	1.00
PHF Volume:	362	1948	8	65	680	168	113	0	130	11	113	208
Reduct Vol:	0	0	0	0	0	0	0	0	0	0	0	0
Reduced Vol:	362	1948	8	65	680	168	113	0	130	11	113	208
PCE Adj:	1.00	1.00	1.00	1.00	1.00	1.00	1.00	1.00	1.00	1.00	1.00	1.00
MLF Adj:	1.00	1.00	1.00	1.00	1.00	1.00	1.00	1.00	1.00	1.00	1.00	1.00
Final Volume:	362	1948	8	65	680	168	113	0	130	11	113	208

Saturation Flow Module:	Sat/Lane			Adjustment			Lanes			Final Sat.:		
Sat/Lane:	1900	1900	1900	1900	1900	1900	1900	1900	1900	1900	1900	1900
Adjustment:	0.92	0.98	0.95	0.92	0.99	0.95	0.92	1.00	0.92	0.92	0.95	0.95
Lanes:	1.00	2.99	0.01	1.00	2.38	0.62	1.00	1.00	1.00	1.00	0.35	0.65
Final Sat.:	1750	5577	23	1750	4489	1109	1750	1900	1750	1750	634	1166

Capacity Analysis Module:	Vol/Sat:			Crit Moves:			Green Time:			Volume/Cap:			Delay/Veh:			User DelAdj:			AdjDel/Veh:			LOS by Move:			HCM2k95thQ:		
Vol/Sat:	0.21	0.35	0.35	0.04	0.15	0.15	0.06	0.00	0.07	0.01	0.18	0.18															
Crit Moves:	****			****			****			****																	
Green Time:	41.8	65.5	65.5	7.0	30.6	30.6	12.1	0.0	53.9	45.5	33.4	33.4															
Volume/Cap:	0.64	0.69	0.69	0.69	0.64	0.64	0.69	0.00	0.18	0.02	0.69	0.69															
Delay/Veh:	40.2	25.4	25.4	79.9	45.8	45.8	69.3	0.0	24.2	27.6	48.2	48.2															
User DelAdj:	1.00	1.00	1.00	1.00	1.00	1.00	1.00	1.00	1.00	1.00	1.00	1.00															
AdjDel/Veh:	40.2	25.4	25.4	79.9	45.8	45.8	69.3	0.0	24.2	27.6	48.2	48.2															
LOS by Move:	D	C	C	E	D	D	E	A	C	C	D	D															
HCM2k95thQ:	24	34	34	6	19	19	10	0	7	1	23	23															

Note: Queue reported is the number of cars per lane.

BART Phase II Extension Project

Level Of Service Computation Report
 2000 HCM Operations (Future Volume Alternative)
 PM - 2025 SC West Project Conditions

Intersection #6: DE LA CRUZ/MARTIN

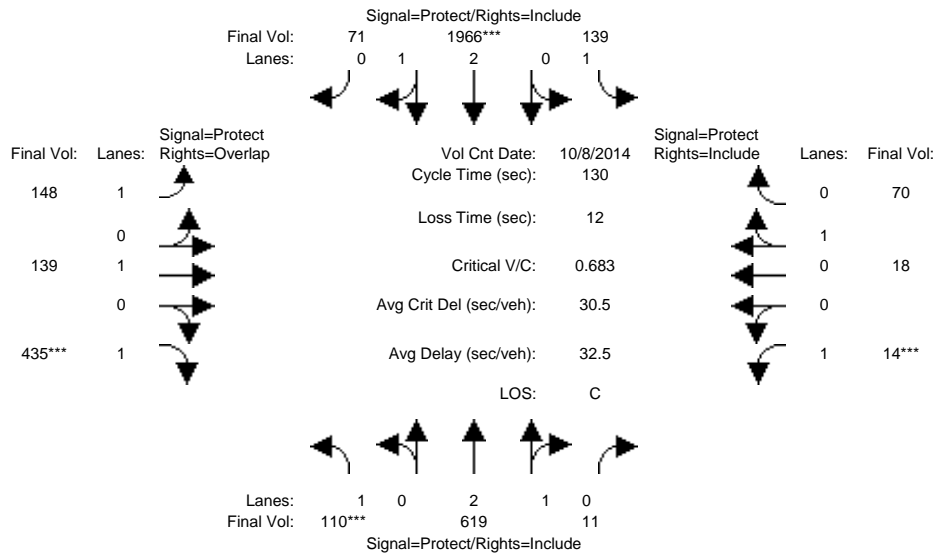

Approach:	North Bound			South Bound			East Bound			West Bound		
	L	T	R	L	T	R	L	T	R	L	T	R
Min. Green:	7	10	10	7	10	10	7	10	10	7	10	10
Y+R:	4.0	4.0	4.0	4.0	4.0	4.0	4.0	4.0	4.0	4.0	4.0	4.0

Volume Module: >> Count Date: 8 Oct 2014 <<

Base Vol:	110	619	11	139	1966	71	148	139	435	14	18	70
Growth Adj:	1.00	1.00	1.00	1.00	1.00	1.00	1.00	1.00	1.00	1.00	1.00	1.00
Initial Bse:	110	619	11	139	1966	71	148	139	435	14	18	70
Added Vol:	0	0	0	0	0	0	0	0	0	0	0	0
PasserByVol:	0	0	0	0	0	0	0	0	0	0	0	0
Initial Fut:	110	619	11	139	1966	71	148	139	435	14	18	70
User Adj:	1.00	1.00	1.00	1.00	1.00	1.00	1.00	1.00	1.00	1.00	1.00	1.00
PHF Adj:	1.00	1.00	1.00	1.00	1.00	1.00	1.00	1.00	1.00	1.00	1.00	1.00
PHF Volume:	110	619	11	139	1966	71	148	139	435	14	18	70
Reduct Vol:	0	0	0	0	0	0	0	0	0	0	0	0
Reduced Vol:	110	619	11	139	1966	71	148	139	435	14	18	70
PCE Adj:	1.00	1.00	1.00	1.00	1.00	1.00	1.00	1.00	1.00	1.00	1.00	1.00
MLF Adj:	1.00	1.00	1.00	1.00	1.00	1.00	1.00	1.00	1.00	1.00	1.00	1.00
FinalVolume:	110	619	11	139	1966	71	148	139	435	14	18	70

Saturation Flow Module:

Sat/Lane:	1900	1900	1900	1900	1900	1900	1900	1900	1900	1900	1900	1900
Adjustment:	0.92	0.98	0.95	0.92	0.98	0.95	0.92	1.00	0.92	0.92	0.95	0.95
Lanes:	1.00	2.95	0.05	1.00	2.89	0.11	1.00	1.00	1.00	1.00	0.20	0.80
Final Sat.:	1750	5502	98	1750	5405	195	1750	1900	1750	1750	368	1432

Capacity Analysis Module:

Vol/Sat:	0.06	0.11	0.11	0.08	0.36	0.36	0.08	0.07	0.25	0.01	0.05	0.05
Crit Moves:	****			****			****		****	****		
Green Time:	11.4	45.3	45.3	32.0	65.9	65.9	21.3	33.7	45.1	7.0	19.4	19.4
Volume/Cap:	0.72	0.32	0.32	0.32	0.72	0.72	0.52	0.28	0.72	0.15	0.33	0.33
Delay/Veh:	72.7	31.2	31.2	40.6	25.7	25.7	51.3	38.8	41.0	59.4	50.2	50.2
User DelAdj:	1.00	1.00	1.00	1.00	1.00	1.00	1.00	1.00	1.00	1.00	1.00	1.00
AdjDel/Veh:	72.7	31.2	31.2	40.6	25.7	25.7	51.3	38.8	41.0	59.4	50.2	50.2
LOS by Move:	E	C	C	D	C	C	D	D	D	E	D	D
HCM2k95thQ:	10	12	12	9	36	36	11	8	29	1	7	7

Note: Queue reported is the number of cars per lane.

BART Phase II Extension Project

Level Of Service Computation Report
 2000 HCM Operations (Future Volume Alternative)
 AM - 2025 SC West Project Conditions

Intersection #7: LAFAYETTE/REED

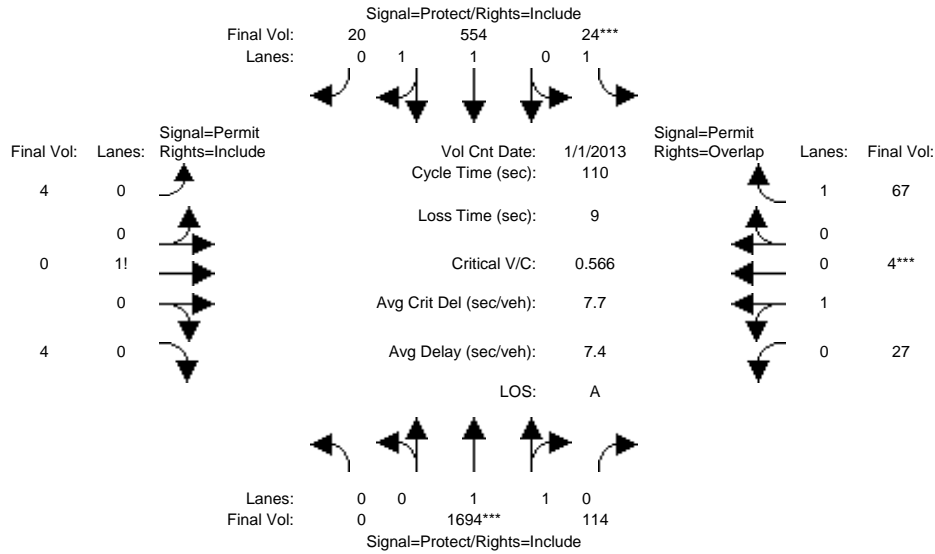

Approach:	North Bound			South Bound			East Bound			West Bound		
	L	T	R	L	T	R	L	T	R	L	T	R
Min. Green:	7	10	10	7	10	10	10	10	10	10	10	10
Y+R:	4.0	4.0	4.0	4.0	4.0	4.0	4.0	4.0	4.0	4.0	4.0	4.0

Volume Module: >> Count Date: 1 Jan 2013 <<

Base Vol:	0	1694	114	24	554	20	4	0	4	27	4	67
Growth Adj:	1.00	1.00	1.00	1.00	1.00	1.00	1.00	1.00	1.00	1.00	1.00	1.00
Initial Bse:	0	1694	114	24	554	20	4	0	4	27	4	67
Added Vol:	0	0	0	0	0	0	0	0	0	0	0	0
PasserByVol:	0	0	0	0	0	0	0	0	0	0	0	0
Initial Fut:	0	1694	114	24	554	20	4	0	4	27	4	67
User Adj:	1.00	1.00	1.00	1.00	1.00	1.00	1.00	1.00	1.00	1.00	1.00	1.00
PHF Adj:	1.00	1.00	1.00	1.00	1.00	1.00	1.00	1.00	1.00	1.00	1.00	1.00
PHF Volume:	0	1694	114	24	554	20	4	0	4	27	4	67
Reduct Vol:	0	0	0	0	0	0	0	0	0	0	0	0
Reduced Vol:	0	1694	114	24	554	20	4	0	4	27	4	67
PCE Adj:	1.00	1.00	1.00	1.00	1.00	1.00	1.00	1.00	1.00	1.00	1.00	1.00
MLF Adj:	1.00	1.00	1.00	1.00	1.00	1.00	1.00	1.00	1.00	1.00	1.00	1.00
FinalVolume:	0	1694	114	24	554	20	4	0	4	27	4	67

Saturation Flow Module:

Sat/Lane:	1900	1900	1900	1900	1900	1900	1900	1900	1900	1900	1900	1900
Adjustment:	0.92	0.98	0.95	0.92	0.97	0.95	0.92	0.92	0.92	0.95	0.95	0.92
Lanes:	0.00	1.87	0.13	1.00	1.93	0.07	0.50	0.00	0.50	0.87	0.13	1.00
Final Sat.:	0	3467	233	1750	3571	129	875	0	875	1568	232	1750

Capacity Analysis Module:

Vol/Sat:	0.00	0.49	0.49	0.01	0.16	0.16	0.00	0.00	0.00	0.02	0.02	0.04
Crit Moves:	****			****			****			****		
Green Time:	0.0	84.0	84.0	7.0	91.0	91.0	10.0	0.0	10.0	10.0	10.0	17.0
Volume/Cap:	0.00	0.64	0.64	0.22	0.19	0.19	0.05	0.00	0.05	0.19	0.19	0.25
Delay/Veh:	0.0	6.5	6.5	49.9	2.0	2.0	45.8	0.0	45.8	46.8	46.8	41.4
User DelAdj:	1.00	1.00	1.00	1.00	1.00	1.00	1.00	1.00	1.00	1.00	1.00	1.00
AdjDel/Veh:	0.0	6.5	6.5	49.9	2.0	2.0	45.8	0.0	45.8	46.8	46.8	41.4
LOS by Move:	A	A	A	D	A	A	D	A	D	D	D	D
HCM2k95thQ:	0	26	26	2	4	4	1	0	1	2	2	4

Note: Queue reported is the number of cars per lane.

BART Phase II Extension Project

Level Of Service Computation Report
 2000 HCM Operations (Future Volume Alternative)
 PM - 2025 SC West Project Conditions

Intersection #7: LAFAYETTE/REED

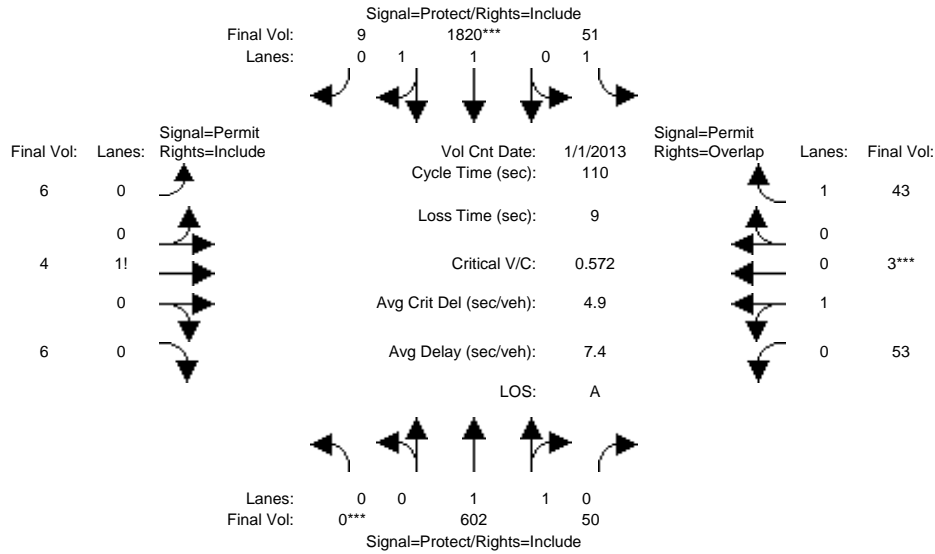

Approach:	North Bound			South Bound			East Bound			West Bound		
	L	T	R	L	T	R	L	T	R	L	T	R
Min. Green:	7	10	10	7	10	10	10	10	10	10	10	10
Y+R:	4.0	4.0	4.0	4.0	4.0	4.0	4.0	4.0	4.0	4.0	4.0	4.0
Volume Module: >> Count Date: 1 Jan 2013 <<												
Base Vol:	0	602	50	51	1820	9	6	4	6	53	3	43
Growth Adj:	1.00	1.00	1.00	1.00	1.00	1.00	1.00	1.00	1.00	1.00	1.00	1.00
Initial Bse:	0	602	50	51	1820	9	6	4	6	53	3	43
Added Vol:	0	0	0	0	0	0	0	0	0	0	0	0
PasserByVol:	0	0	0	0	0	0	0	0	0	0	0	0
Initial Fut:	0	602	50	51	1820	9	6	4	6	53	3	43
User Adj:	1.00	1.00	1.00	1.00	1.00	1.00	1.00	1.00	1.00	1.00	1.00	1.00
PHF Adj:	1.00	1.00	1.00	1.00	1.00	1.00	1.00	1.00	1.00	1.00	1.00	1.00
PHF Volume:	0	602	50	51	1820	9	6	4	6	53	3	43
Reduct Vol:	0	0	0	0	0	0	0	0	0	0	0	0
Reduced Vol:	0	602	50	51	1820	9	6	4	6	53	3	43
PCE Adj:	1.00	1.00	1.00	1.00	1.00	1.00	1.00	1.00	1.00	1.00	1.00	1.00
MLF Adj:	1.00	1.00	1.00	1.00	1.00	1.00	1.00	1.00	1.00	1.00	1.00	1.00
FinalVolume:	0	602	50	51	1820	9	6	4	6	53	3	43
Saturation Flow Module:												
Sat/Lane:	1900	1900	1900	1900	1900	1900	1900	1900	1900	1900	1900	1900
Adjustment:	0.92	0.98	0.95	0.92	0.97	0.95	0.92	0.92	0.92	0.95	0.95	0.92
Lanes:	0.00	1.84	0.16	1.00	1.99	0.01	0.37	0.25	0.38	0.95	0.05	1.00
Final Sat.:	0	3416	284	1750	3682	18	656	438	656	1704	96	1750
Capacity Analysis Module:												
Vol/Sat:	0.00	0.18	0.18	0.03	0.49	0.49	0.01	0.01	0.01	0.03	0.03	0.02
Crit Moves:	****			****						****		
Green Time:	0.0	66.9	66.9	24.1	91.0	91.0	10.0	10.0	10.0	10.0	10.0	34.1
Volume/Cap:	0.00	0.29	0.29	0.13	0.60	0.60	0.10	0.10	0.10	0.34	0.34	0.08
Delay/Veh:	0.0	10.3	10.3	34.7	3.6	3.6	46.2	46.2	46.2	48.2	48.2	26.9
User DelAdj:	1.00	1.00	1.00	1.00	1.00	1.00	1.00	1.00	1.00	1.00	1.00	1.00
AdjDel/Veh:	0.0	10.3	10.3	34.7	3.6	3.6	46.2	46.2	46.2	48.2	48.2	26.9
LOS by Move:	A	B	B	C	A	A	D	D	D	D	D	C
HCM2k95thQ:	0	10	10	3	21	21	1	1	1	4	4	2

Note: Queue reported is the number of cars per lane.

BART Phase II Extension Project

Level Of Service Computation Report
2000 HCM Operations (Future Volume Alternative)
AM - 2025 SC West Project Conditions

Intersection #9: Coleman/Brokaw

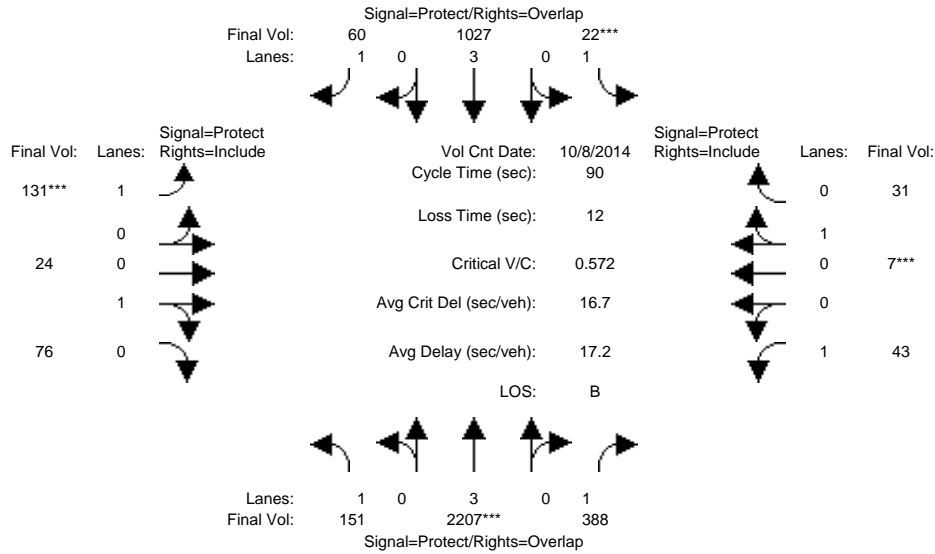

Approach:	North Bound			South Bound			East Bound			West Bound		
	L	T	R	L	T	R	L	T	R	L	T	R
Min. Green:	7	10	10	7	10	10	7	10	10	7	10	10
Y+R:	4.0	4.0	4.0	4.0	4.0	4.0	4.0	4.0	4.0	4.0	4.0	4.0
Volume Module: >> Count Date: 8 Oct 2014 <<												
Base Vol:	151	2207	388	22	1027	60	131	24	76	43	7	31
Growth Adj:	1.00	1.00	1.00	1.00	1.00	1.00	1.00	1.00	1.00	1.00	1.00	1.00
Initial Bse:	151	2207	388	22	1027	60	131	24	76	43	7	31
Added Vol:	0	0	0	0	0	0	0	0	0	0	0	0
PasserByVol:	0	0	0	0	0	0	0	0	0	0	0	0
Initial Fut:	151	2207	388	22	1027	60	131	24	76	43	7	31
User Adj:	1.00	1.00	1.00	1.00	1.00	1.00	1.00	1.00	1.00	1.00	1.00	1.00
PHF Adj:	1.00	1.00	1.00	1.00	1.00	1.00	1.00	1.00	1.00	1.00	1.00	1.00
PHF Volume:	151	2207	388	22	1027	60	131	24	76	43	7	31
Reduct Vol:	0	0	0	0	0	0	0	0	0	0	0	0
Reduced Vol:	151	2207	388	22	1027	60	131	24	76	43	7	31
PCE Adj:	1.00	1.00	1.00	1.00	1.00	1.00	1.00	1.00	1.00	1.00	1.00	1.00
MLF Adj:	1.00	1.00	1.00	1.00	1.00	1.00	1.00	1.00	1.00	1.00	1.00	1.00
FinalVolume:	151	2207	388	22	1027	60	131	24	76	43	7	31
Saturation Flow Module:												
Sat/Lane:	1900	1900	1900	1900	1900	1900	1900	1900	1900	1900	1900	1900
Adjustment:	0.92	1.00	0.92	0.92	1.00	0.92	0.92	0.95	0.95	0.92	0.95	0.95
Lanes:	1.00	3.00	1.00	1.00	3.00	1.00	1.00	0.24	0.76	1.00	0.18	0.82
Final Sat.:	1750	5700	1750	1750	5700	1750	1750	432	1368	1750	332	1468
Capacity Analysis Module:												
Vol/Sat:	0.09	0.39	0.22	0.01	0.18	0.03	0.07	0.06	0.06	0.02	0.02	0.02
Crit Moves:	****			****			****			****		
Green Time:	18.8	51.1	59.3	7.0	39.3	49.2	9.9	11.7	11.7	8.2	10.0	10.0
Volume/Cap:	0.41	0.68	0.34	0.16	0.41	0.06	0.68	0.43	0.43	0.27	0.19	0.19
Delay/Veh:	31.6	14.3	6.9	39.3	17.5	9.6	48.1	37.3	37.3	39.0	36.8	36.8
User DelAdj:	1.00	1.00	1.00	1.00	1.00	1.00	1.00	1.00	1.00	1.00	1.00	1.00
AdjDel/Veh:	31.6	14.3	6.9	39.3	17.5	9.6	48.1	37.3	37.3	39.0	36.8	36.8
LOS by Move:	C	B	A	D	B	A	D	D	D	D	D	D
HCM2k95thQ:	7	24	9	1	12	2	10	6	6	2	2	2

Note: Queue reported is the number of cars per lane.

BART Phase II Extension Project

Level Of Service Computation Report
2000 HCM Operations (Future Volume Alternative)
PM - 2025 SC West Project Conditions

Intersection #9: Coleman/Brokaw

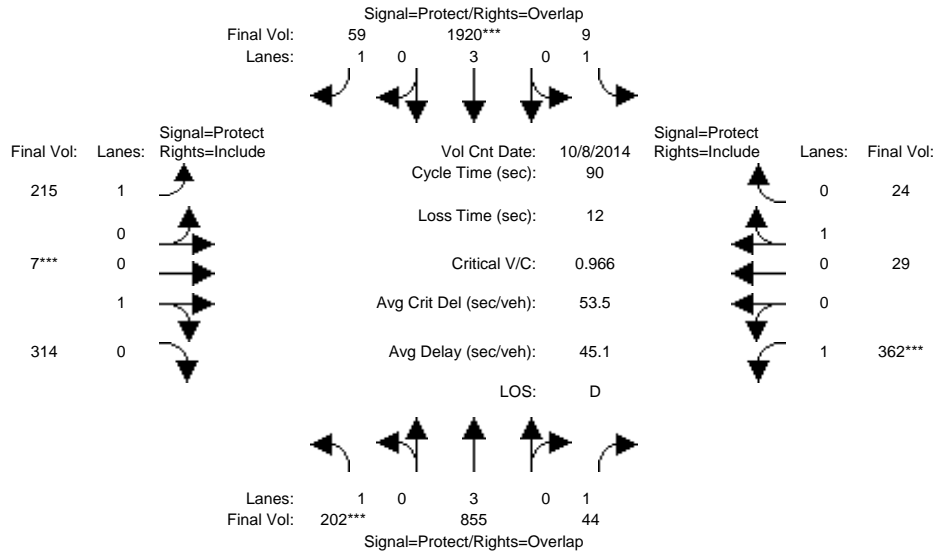

Approach:	North Bound			South Bound			East Bound			West Bound		
	L	T	R	L	T	R	L	T	R	L	T	R
Min. Green:	7	10	10	7	10	10	7	10	10	7	10	10
Y+R:	4.0	4.0	4.0	4.0	4.0	4.0	4.0	4.0	4.0	4.0	4.0	4.0

Volume Module:	>>	Count	Date:	8 Oct 2014	<<						
Base Vol:	202	855	44	9 1920	59	215	7	314	362	29	24
Growth Adj:	1.00	1.00	1.00	1.00	1.00	1.00	1.00	1.00	1.00	1.00	1.00
Initial Bse:	202	855	44	9 1920	59	215	7	314	362	29	24
Added Vol:	0	0	0	0	0	0	0	0	0	0	0
PasserByVol:	0	0	0	0	0	0	0	0	0	0	0
Initial Fut:	202	855	44	9 1920	59	215	7	314	362	29	24
User Adj:	1.00	1.00	1.00	1.00	1.00	1.00	1.00	1.00	1.00	1.00	1.00
PHF Adj:	1.00	1.00	1.00	1.00	1.00	1.00	1.00	1.00	1.00	1.00	1.00
PHF Volume:	202	855	44	9 1920	59	215	7	314	362	29	24
Reduct Vol:	0	0	0	0	0	0	0	0	0	0	0
Reduced Vol:	202	855	44	9 1920	59	215	7	314	362	29	24
PCE Adj:	1.00	1.00	1.00	1.00	1.00	1.00	1.00	1.00	1.00	1.00	1.00
MLF Adj:	1.00	1.00	1.00	1.00	1.00	1.00	1.00	1.00	1.00	1.00	1.00
FinalVolume:	202	855	44	9 1920	59	215	7	314	362	29	24

Saturation Flow Module:												
Sat/Lane:	1900	1900	1900	1900	1900	1900	1900	1900	1900	1900	1900	1900
Adjustment:	0.92	1.00	0.92	0.92	1.00	0.92	0.92	0.95	0.95	0.92	0.95	0.95
Lanes:	1.00	3.00	1.00	1.00	3.00	1.00	1.00	0.02	0.98	1.00	0.55	0.45
Final Sat.:	1750	5700	1750	1750	5700	1750	1750	39	1761	1750	985	815

Capacity Analysis Module:												
Vol/Sat:	0.12	0.15	0.03	0.01	0.34	0.03	0.12	0.18	0.18	0.21	0.03	0.03
Crit Moves:	****				****			****			****	
Green Time:	10.8	27.7	47.0	14.4	31.4	50.2	18.8	16.6	16.6	19.3	17.0	17.0
Volume/Cap:	0.97	0.49	0.05	0.03	0.97	0.06	0.59	0.97	0.97	0.97	0.16	0.16
Delay/Veh:	91.9	25.5	10.6	32.0	42.0	9.1	34.5	76.7	76.7	72.6	30.7	30.7
User DelAdj:	1.00	1.00	1.00	1.00	1.00	1.00	1.00	1.00	1.00	1.00	1.00	1.00
AdjDel/Veh:	91.9	25.5	10.6	32.0	42.0	9.1	34.5	76.7	76.7	72.6	30.7	30.7
LOS by Move:	F	C	B	C	D	A	C	E	E	E	C	C
HCM2k95thQ:	15	12	1	0	35	2	13	25	25	24	3	3

Note: Queue reported is the number of cars per lane.

BART Phase II Extension Project

Level Of Service Computation Report
 2000 HCM Operations (Future Volume Alternative)
 AM - 2025 SC West Project Conditions

Intersection #106: Benton/EI Camino Real

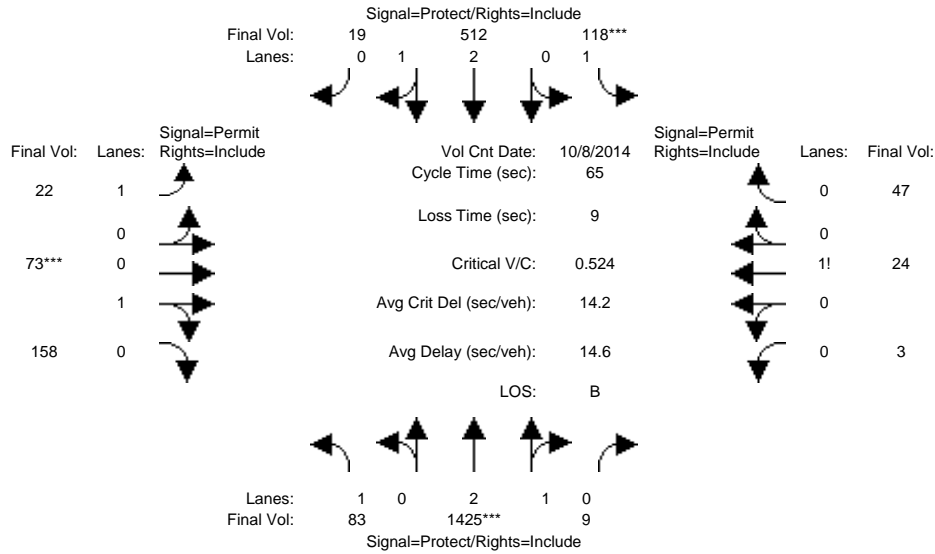

Approach:	North Bound			South Bound			East Bound			West Bound		
	L	T	R	L	T	R	L	T	R	L	T	R
Min. Green:	7	10	10	7	10	10	10	10	10	10	10	10
Y+R:	4.0	4.0	4.0	4.0	4.0	4.0	4.0	4.0	4.0	4.0	4.0	4.0
Volume Module: >> Count Date: 8 Oct 2014 <<												
Base Vol:	83	1425	9	118	512	19	22	73	158	3	24	47
Growth Adj:	1.00	1.00	1.00	1.00	1.00	1.00	1.00	1.00	1.00	1.00	1.00	1.00
Initial Bse:	83	1425	9	118	512	19	22	73	158	3	24	47
Added Vol:	0	0	0	0	0	0	0	0	0	0	0	0
PasserByVol:	0	0	0	0	0	0	0	0	0	0	0	0
Initial Fut:	83	1425	9	118	512	19	22	73	158	3	24	47
User Adj:	1.00	1.00	1.00	1.00	1.00	1.00	1.00	1.00	1.00	1.00	1.00	1.00
PHF Adj:	1.00	1.00	1.00	1.00	1.00	1.00	1.00	1.00	1.00	1.00	1.00	1.00
PHF Volume:	83	1425	9	118	512	19	22	73	158	3	24	47
Reduct Vol:	0	0	0	0	0	0	0	0	0	0	0	0
Reduced Vol:	83	1425	9	118	512	19	22	73	158	3	24	47
PCE Adj:	1.00	1.00	1.00	1.00	1.00	1.00	1.00	1.00	1.00	1.00	1.00	1.00
MLF Adj:	1.00	1.00	1.00	1.00	1.00	1.00	1.00	1.00	1.00	1.00	1.00	1.00
FinalVolume:	83	1425	9	118	512	19	22	73	158	3	24	47
Saturation Flow Module:												
Sat/Lane:	1900	1900	1900	1900	1900	1900	1900	1900	1900	1900	1900	1900
Adjustment:	0.92	0.98	0.95	0.92	0.98	0.95	0.92	0.95	0.95	0.92	0.92	0.92
Lanes:	1.00	2.98	0.02	1.00	2.89	0.11	1.00	0.32	0.68	0.04	0.32	0.64
Final Sat.:	1750	5565	35	1750	5399	200	1750	569	1231	71	568	1111
Capacity Analysis Module:												
Vol/Sat:	0.05	0.26	0.26	0.07	0.09	0.09	0.01	0.13	0.13	0.04	0.04	0.04
Crit Moves:	****			****			****			****		
Green Time:	16.5	31.7	31.7	8.4	23.6	23.6	15.9	15.9	15.9	15.9	15.9	15.9
Volume/Cap:	0.19	0.52	0.52	0.52	0.26	0.26	0.05	0.52	0.52	0.17	0.17	0.17
Delay/Veh:	19.2	11.6	11.6	28.7	14.6	14.6	18.8	22.4	22.4	19.6	19.6	19.6
User DelAdj:	1.00	1.00	1.00	1.00	1.00	1.00	1.00	1.00	1.00	1.00	1.00	1.00
AdjDel/Veh:	19.2	11.6	11.6	28.7	14.6	14.6	18.8	22.4	22.4	19.6	19.6	19.6
LOS by Move:	B	B	B	C	B	B	B	C	C	B	B	B
HCM2k95thQ:	3	13	13	5	5	5	1	8	8	3	3	3

Note: Queue reported is the number of cars per lane.

BART Phase II Extension Project

Level Of Service Computation Report
 2000 HCM Operations (Future Volume Alternative)
 PM - 2025 SC West Project Conditions

Intersection #106: Benton/EI Camino Real

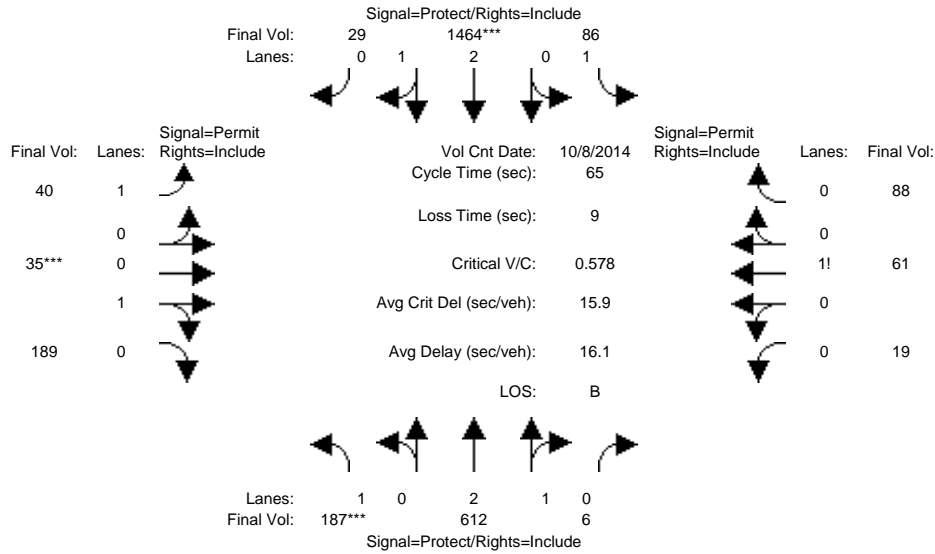

Approach:	North Bound			South Bound			East Bound			West Bound		
	L	T	R	L	T	R	L	T	R	L	T	R
Min. Green:	7	10	10	7	10	10	10	10	10	10	10	10
Y+R:	4.0	4.0	4.0	4.0	4.0	4.0	4.0	4.0	4.0	4.0	4.0	4.0
Volume Module: >> Count Date: 8 Oct 2014 <<												
Base Vol:	187	612	6	86	1464	29	40	35	189	19	61	88
Growth Adj:	1.00	1.00	1.00	1.00	1.00	1.00	1.00	1.00	1.00	1.00	1.00	1.00
Initial Bse:	187	612	6	86	1464	29	40	35	189	19	61	88
Added Vol:	0	0	0	0	0	0	0	0	0	0	0	0
PasserByVol:	0	0	0	0	0	0	0	0	0	0	0	0
Initial Fut:	187	612	6	86	1464	29	40	35	189	19	61	88
User Adj:	1.00	1.00	1.00	1.00	1.00	1.00	1.00	1.00	1.00	1.00	1.00	1.00
PHF Adj:	1.00	1.00	1.00	1.00	1.00	1.00	1.00	1.00	1.00	1.00	1.00	1.00
PHF Volume:	187	612	6	86	1464	29	40	35	189	19	61	88
Reduct Vol:	0	0	0	0	0	0	0	0	0	0	0	0
Reduced Vol:	187	612	6	86	1464	29	40	35	189	19	61	88
PCE Adj:	1.00	1.00	1.00	1.00	1.00	1.00	1.00	1.00	1.00	1.00	1.00	1.00
MLF Adj:	1.00	1.00	1.00	1.00	1.00	1.00	1.00	1.00	1.00	1.00	1.00	1.00
FinalVolume:	187	612	6	86	1464	29	40	35	189	19	61	88
Saturation Flow Module:												
Sat/Lane:	1900	1900	1900	1900	1900	1900	1900	1900	1900	1900	1900	1900
Adjustment:	0.92	0.98	0.95	0.92	0.98	0.95	0.92	0.95	0.95	0.92	0.92	0.92
Lanes:	1.00	2.97	0.03	1.00	2.94	0.06	1.00	0.16	0.84	0.11	0.36	0.53
Final Sat.:	1750	5546	54	1750	5491	109	1750	281	1519	198	635	917
Capacity Analysis Module:												
Vol/Sat:	0.11	0.11	0.11	0.05	0.27	0.27	0.02	0.12	0.12	0.10	0.10	0.10
Crit Moves:	****			****			****					
Green Time:	12.0	24.7	24.7	17.3	30.0	30.0	14.0	14.0	14.0	14.0	14.0	14.0
Volume/Cap:	0.58	0.29	0.29	0.18	0.58	0.58	0.11	0.58	0.58	0.45	0.45	0.45
Delay/Veh:	26.8	14.1	14.1	18.6	13.2	13.2	20.6	25.0	25.0	23.0	23.0	23.0
User DelAdj:	1.00	1.00	1.00	1.00	1.00	1.00	1.00	1.00	1.00	1.00	1.00	1.00
AdjDel/Veh:	26.8	14.1	14.1	18.6	13.2	13.2	20.6	25.0	25.0	23.0	23.0	23.0
LOS by Move:	C	B	B	B	B	B	C	C	C	C	C	C
HCM2k95thQ:	7	6	6	3	14	14	1	8	8	7	7	7

Note: Queue reported is the number of cars per lane.

BART Phase II Extension Project

Level Of Service Computation Report
 2000 HCM Operations (Future Volume Alternative)
 AM - 2025 SC West Project Conditions

Intersection #107: Benton/Lafayette

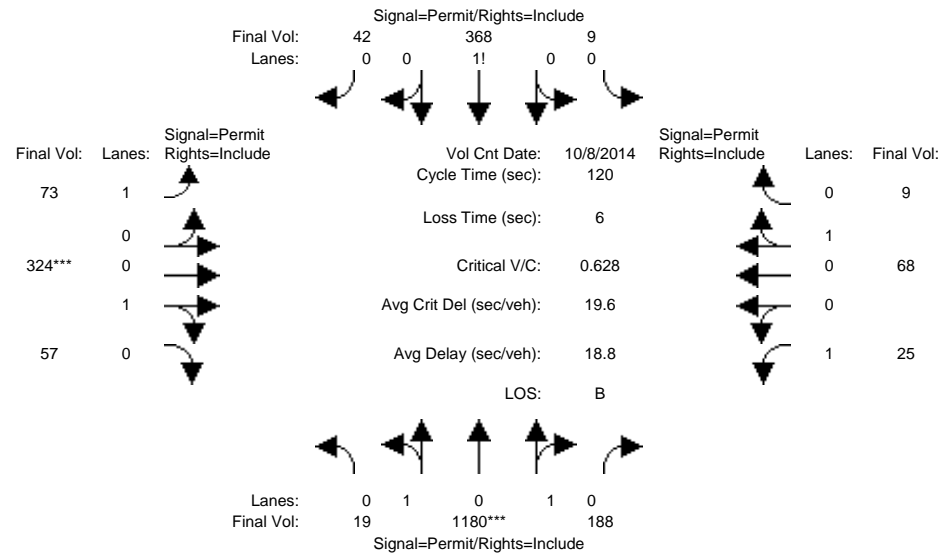

Approach:	North Bound			South Bound			East Bound			West Bound		
	L	T	R	L	T	R	L	T	R	L	T	R
Min. Green:	10	10	10	10	10	10	10	10	10	10	10	10
Y+R:	4.0	4.0	4.0	4.0	4.0	4.0	4.0	4.0	4.0	4.0	4.0	4.0
Volume Module: >> Count Date: 8 Oct 2014 <<												
Base Vol:	19	1180	188	9	368	42	73	324	57	25	68	9
Growth Adj:	1.00	1.00	1.00	1.00	1.00	1.00	1.00	1.00	1.00	1.00	1.00	1.00
Initial Bse:	19	1180	188	9	368	42	73	324	57	25	68	9
Added Vol:	0	0	0	0	0	0	0	0	0	0	0	0
PasserByVol:	0	0	0	0	0	0	0	0	0	0	0	0
Initial Fut:	19	1180	188	9	368	42	73	324	57	25	68	9
User Adj:	1.00	1.00	1.00	1.00	1.00	1.00	1.00	1.00	1.00	1.00	1.00	1.00
PHF Adj:	1.00	1.00	1.00	1.00	1.00	1.00	1.00	1.00	1.00	1.00	1.00	1.00
PHF Volume:	19	1180	188	9	368	42	73	324	57	25	68	9
Reduct Vol:	0	0	0	0	0	0	0	0	0	0	0	0
Reduced Vol:	19	1180	188	9	368	42	73	324	57	25	68	9
PCE Adj:	1.00	1.00	1.00	1.00	1.00	1.00	1.00	1.00	1.00	1.00	1.00	1.00
MLF Adj:	1.00	1.00	1.00	1.00	1.00	1.00	1.00	1.00	1.00	1.00	1.00	1.00
FinalVolume:	19	1180	188	9	368	42	73	324	57	25	68	9
Saturation Flow Module:												
Sat/Lane:	1900	1900	1900	1900	1900	1900	1900	1900	1900	1900	1900	1900
Adjustment:	0.95	0.95	0.95	0.92	0.92	0.92	0.92	0.95	0.95	0.92	0.95	0.95
Lanes:	0.03	1.70	0.27	0.02	0.88	0.10	1.00	0.85	0.15	1.00	0.88	0.12
Final Sat.:	49	3063	488	38	1537	175	1750	1531	269	1750	1590	210
Capacity Analysis Module:												
Vol/Sat:	0.39	0.39	0.39	0.24	0.24	0.24	0.04	0.21	0.21	0.01	0.04	0.04
Crit Moves:	****						****					
Green Time:	73.6	73.6	73.6	73.6	73.6	73.6	40.4	40.4	40.4	40.4	40.4	40.4
Volume/Cap:	0.63	0.63	0.63	0.39	0.39	0.39	0.12	0.63	0.63	0.04	0.13	0.13
Delay/Veh:	15.2	15.2	15.2	12.0	12.0	12.0	27.6	35.6	35.6	26.8	27.7	27.7
User DelAdj:	1.00	1.00	1.00	1.00	1.00	1.00	1.00	1.00	1.00	1.00	1.00	1.00
AdjDel/Veh:	15.2	15.2	15.2	12.0	12.0	12.0	27.6	35.6	35.6	26.8	27.7	27.7
LOS by Move:	B	B	B	B	B	B	C	D	D	C	C	C
HCM2k95thQ:	28	28	28	16	16	16	4	22	22	1	4	4

Note: Queue reported is the number of cars per lane.

BART Phase II Extension Project

Level Of Service Computation Report
 2000 HCM Operations (Future Volume Alternative)
 PM - 2025 SC West Project Conditions

Intersection #107: Benton/Lafayette

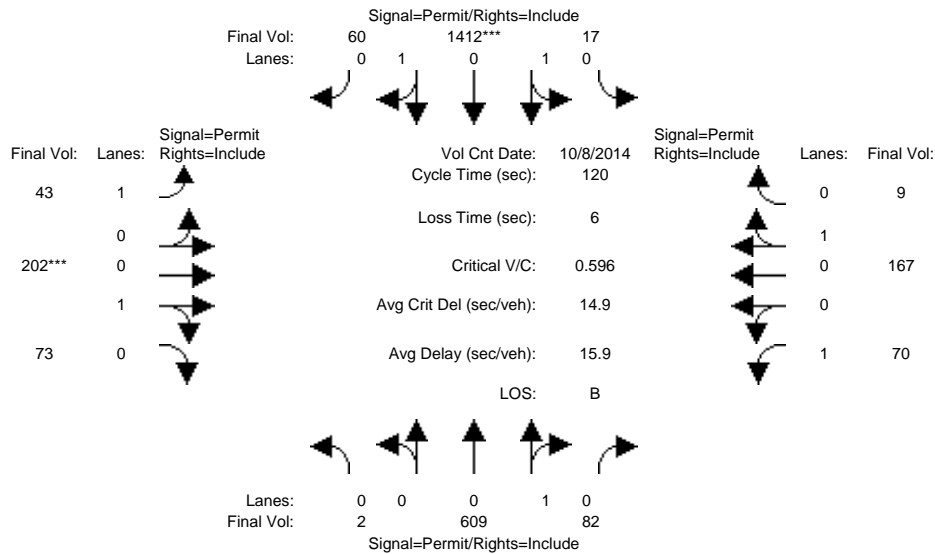

Approach:	North Bound			South Bound			East Bound			West Bound		
	L	T	R	L	T	R	L	T	R	L	T	R
Min. Green:	10	10	10	10	10	10	10	10	10	10	10	10
Y+R:	4.0	4.0	4.0	4.0	4.0	4.0	4.0	4.0	4.0	4.0	4.0	4.0
Volume Module: >> Count Date: 8 Oct 2014 <<												
Base Vol:	2	609	82	17	1412	60	43	202	73	70	167	9
Growth Adj:	1.00	1.00	1.00	1.00	1.00	1.00	1.00	1.00	1.00	1.00	1.00	1.00
Initial Bse:	2	609	82	17	1412	60	43	202	73	70	167	9
Added Vol:	0	0	0	0	0	0	0	0	0	0	0	0
PasserByVol:	0	0	0	0	0	0	0	0	0	0	0	0
Initial Fut:	2	609	82	17	1412	60	43	202	73	70	167	9
User Adj:	1.00	1.00	1.00	1.00	1.00	1.00	1.00	1.00	1.00	1.00	1.00	1.00
PHF Adj:	1.00	1.00	1.00	1.00	1.00	1.00	1.00	1.00	1.00	1.00	1.00	1.00
PHF Volume:	2	609	82	17	1412	60	43	202	73	70	167	9
Reduct Vol:	0	0	0	0	0	0	0	0	0	0	0	0
Reduced Vol:	2	609	82	17	1412	60	43	202	73	70	167	9
PCE Adj:	1.00	1.00	1.00	1.00	1.00	1.00	1.00	1.00	1.00	1.00	1.00	1.00
MLF Adj:	1.00	1.00	1.00	1.00	1.00	1.00	1.00	1.00	1.00	1.00	1.00	1.00
FinalVolume:	2	609	82	17	1412	60	43	202	73	70	167	9
Saturation Flow Module:												
Sat/Lane:	1900	1900	1900	1900	1900	1900	1900	1900	1900	1900	1900	1900
Adjustment:	0.92	0.92	0.92	0.95	0.95	0.95	0.92	0.95	0.95	0.92	0.95	0.95
Lanes:	0.01	0.88	0.11	0.02	1.90	0.08	1.00	0.73	0.27	1.00	0.95	0.05
Final Sat.:	5	1538	207	41	3414	145	1750	1322	478	1750	1708	92
Capacity Analysis Module:												
Vol/Sat:	0.40	0.40	0.40	0.41	0.41	0.41	0.02	0.15	0.15	0.04	0.10	0.10
Crit Moves:	****						****					
Green Time:	83.2	83.2	83.2	83.2	83.2	83.2	30.8	30.8	30.8	30.8	30.8	30.8
Volume/Cap:	0.57	0.57	0.57	0.60	0.60	0.60	0.10	0.60	0.60	0.16	0.38	0.38
Delay/Veh:	10.0	10.0	10.0	10.0	10.0	10.0	34.1	41.3	41.3	34.7	37.3	37.3
User DelAdj:	1.00	1.00	1.00	1.00	1.00	1.00	1.00	1.00	1.00	1.00	1.00	1.00
AdjDel/Veh:	10.0	10.0	10.0	10.0	10.0	10.0	34.1	41.3	41.3	34.7	37.3	37.3
LOS by Move:	A	A	A	A	A	A	C	D	D	C	D	D
HCM2k95thQ:	24	24	24	25	25	25	3	17	17	4	11	11

Note: Queue reported is the number of cars per lane.

BART Phase II Extension Project

Level Of Service Computation Report
 2000 HCM Operations (Future Volume Alternative)
 AM - 2025 SC West Project Conditions

Intersection #175: Reed/De La Cruz

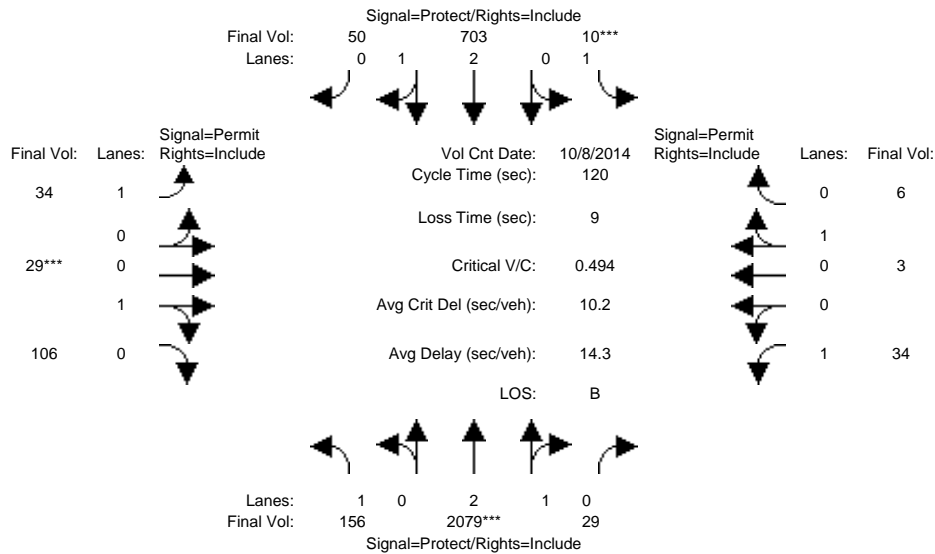

Approach:	North Bound			South Bound			East Bound			West Bound		
Movement:	L	T	R	L	T	R	L	T	R	L	T	R
Min. Green:	7	10	10	7	10	10	10	10	10	10	10	10
Y+R:	4.0	4.0	4.0	4.0	4.0	4.0	4.0	4.0	4.0	4.0	4.0	4.0
Volume Module: >> Count Date: 8 Oct 2014 <<												
Base Vol:	156	2079	29	10	703	50	34	29	106	34	3	6
Growth Adj:	1.00	1.00	1.00	1.00	1.00	1.00	1.00	1.00	1.00	1.00	1.00	1.00
Initial Bse:	156	2079	29	10	703	50	34	29	106	34	3	6
Added Vol:	0	0	0	0	0	0	0	0	0	0	0	0
PasserByVol:	0	0	0	0	0	0	0	0	0	0	0	0
Initial Fut:	156	2079	29	10	703	50	34	29	106	34	3	6
User Adj:	1.00	1.00	1.00	1.00	1.00	1.00	1.00	1.00	1.00	1.00	1.00	1.00
PHF Adj:	1.00	1.00	1.00	1.00	1.00	1.00	1.00	1.00	1.00	1.00	1.00	1.00
PHF Volume:	156	2079	29	10	703	50	34	29	106	34	3	6
Reduct Vol:	0	0	0	0	0	0	0	0	0	0	0	0
Reduced Vol:	156	2079	29	10	703	50	34	29	106	34	3	6
PCE Adj:	1.00	1.00	1.00	1.00	1.00	1.00	1.00	1.00	1.00	1.00	1.00	1.00
MLF Adj:	1.00	1.00	1.00	1.00	1.00	1.00	1.00	1.00	1.00	1.00	1.00	1.00
FinalVolume:	156	2079	29	10	703	50	34	29	106	34	3	6
Saturation Flow Module:												
Sat/Lane:	1900	1900	1900	1900	1900	1900	1900	1900	1900	1900	1900	1900
Adjustment:	0.92	0.98	0.95	0.92	0.98	0.95	0.92	0.95	0.95	0.92	0.95	0.95
Lanes:	1.00	2.96	0.04	1.00	2.79	0.21	1.00	0.21	0.79	1.00	0.33	0.67
Final Sat.:	1750	5523	77	1750	5228	372	1750	387	1413	1750	600	1200
Capacity Analysis Module:												
Vol/Sat:	0.09	0.38	0.38	0.01	0.13	0.13	0.02	0.08	0.08	0.02	0.01	0.01
Crit Moves:	****			****			****			****		
Green Time:	37.4	86.7	86.7	7.0	56.4	56.4	17.3	17.3	17.3	17.3	17.3	17.3
Volume/Cap:	0.29	0.52	0.52	0.10	0.29	0.29	0.13	0.52	0.52	0.13	0.03	0.03
Delay/Veh:	31.5	7.5	7.5	53.9	19.6	19.6	45.1	49.4	49.4	45.1	44.2	44.2
User DelAdj:	1.00	1.00	1.00	1.00	1.00	1.00	1.00	1.00	1.00	1.00	1.00	1.00
AdjDel/Veh:	31.5	7.5	7.5	53.9	19.6	19.6	45.1	49.4	49.4	45.1	44.2	44.2
LOS by Move:	C	A	A	D	B	B	D	D	D	D	D	D
HCM2k95thQ:	9	21	21	1	11	11	2	9	9	3	1	1

Note: Queue reported is the number of cars per lane.

BART Phase II Extension Project

Level Of Service Computation Report
 2000 HCM Operations (Future Volume Alternative)
 PM - 2025 SC West Project Conditions

Intersection #175: Reed/De La Cruz

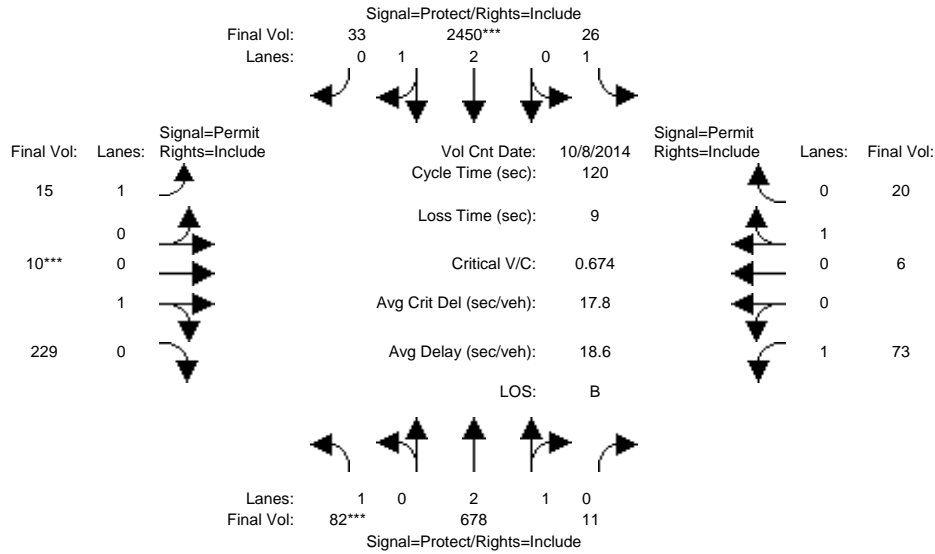

Approach:	North Bound			South Bound			East Bound			West Bound		
Movement:	L	T	R	L	T	R	L	T	R	L	T	R
Min. Green:	7	10	10	7	10	10	10	10	10	10	10	10
Y+R:	4.0	4.0	4.0	4.0	4.0	4.0	4.0	4.0	4.0	4.0	4.0	4.0
Volume Module: >> Count Date: 8 Oct 2014 <<												
Base Vol:	82	678	11	26	2450	33	15	10	229	73	6	20
Growth Adj:	1.00	1.00	1.00	1.00	1.00	1.00	1.00	1.00	1.00	1.00	1.00	1.00
Initial Bse:	82	678	11	26	2450	33	15	10	229	73	6	20
Added Vol:	0	0	0	0	0	0	0	0	0	0	0	0
PasserByVol:	0	0	0	0	0	0	0	0	0	0	0	0
Initial Fut:	82	678	11	26	2450	33	15	10	229	73	6	20
User Adj:	1.00	1.00	1.00	1.00	1.00	1.00	1.00	1.00	1.00	1.00	1.00	1.00
PHF Adj:	1.00	1.00	1.00	1.00	1.00	1.00	1.00	1.00	1.00	1.00	1.00	1.00
PHF Volume:	82	678	11	26	2450	33	15	10	229	73	6	20
Reduct Vol:	0	0	0	0	0	0	0	0	0	0	0	0
Reduced Vol:	82	678	11	26	2450	33	15	10	229	73	6	20
PCE Adj:	1.00	1.00	1.00	1.00	1.00	1.00	1.00	1.00	1.00	1.00	1.00	1.00
MLF Adj:	1.00	1.00	1.00	1.00	1.00	1.00	1.00	1.00	1.00	1.00	1.00	1.00
FinalVolume:	82	678	11	26	2450	33	15	10	229	73	6	20
Saturation Flow Module:												
Sat/Lane:	1900	1900	1900	1900	1900	1900	1900	1900	1900	1900	1900	1900
Adjustment:	0.92	0.98	0.95	0.92	0.98	0.95	0.92	0.95	0.95	0.92	0.95	0.95
Lanes:	1.00	2.95	0.05	1.00	2.96	0.04	1.00	0.04	0.96	1.00	0.23	0.77
Final Sat.:	1750	5510	89	1750	5525	74	1750	75	1725	1750	415	1385
Capacity Analysis Module:												
Vol/Sat:	0.05	0.12	0.12	0.01	0.44	0.44	0.01	0.13	0.13	0.04	0.01	0.01
Crit Moves:	****			****			****					
Green Time:	8.3	59.3	59.3	28.1	79.0	79.0	23.7	23.7	23.7	23.7	23.7	23.7
Volume/Cap:	0.67	0.25	0.25	0.06	0.67	0.67	0.04	0.67	0.67	0.21	0.07	0.07
Delay/Veh:	68.4	17.6	17.6	35.8	13.1	13.1	39.1	49.6	49.6	40.7	39.3	39.3
User DelAdj:	1.00	1.00	1.00	1.00	1.00	1.00	1.00	1.00	1.00	1.00	1.00	1.00
AdjDel/Veh:	68.4	17.6	17.6	35.8	13.1	13.1	39.1	49.6	49.6	40.7	39.3	39.3
LOS by Move:	E	B	B	D	B	B	D	D	D	D	D	D
HCM2k95thQ:	9	9	9	2	33	33	1	16	16	5	2	2

Note: Queue reported is the number of cars per lane.

BART Phase II Extension Project

Level of Service Computation Report
 2000 HCM Unsignalized (Future Volume Alternative)
 AM - 2025 SC West Project Conditions

Intersection #1008: Lafayette/Harrison

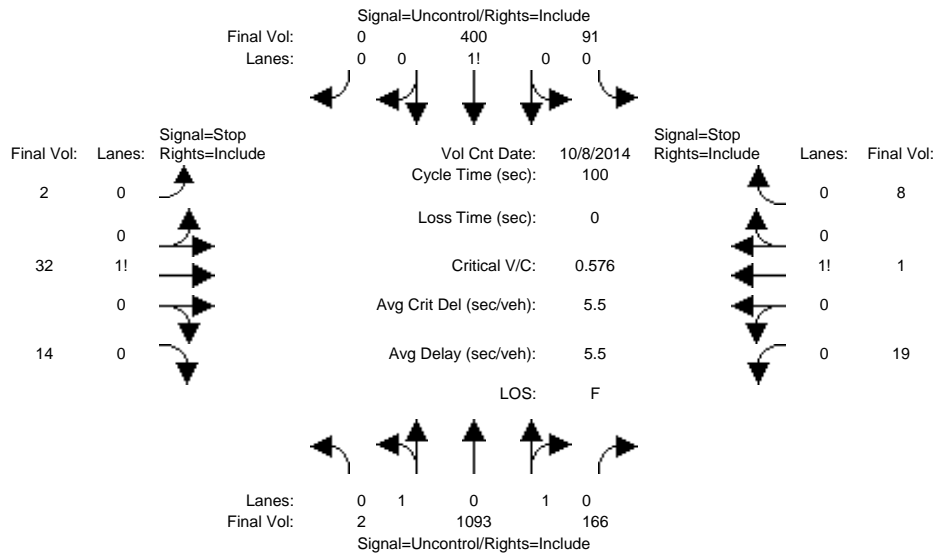

Approach:	North Bound			South Bound			East Bound			West Bound		
Movement:	L	T	R	L	T	R	L	T	R	L	T	R
Volume Module: >> Count Date: 8 Oct 2014 <<												
Base Vol:	2	1093	166	91	400	0	2	32	14	19	1	8
Growth Adj:	1.00	1.00	1.00	1.00	1.00	1.00	1.00	1.00	1.00	1.00	1.00	1.00
Initial Bse:	2	1093	166	91	400	0	2	32	14	19	1	8
Added Vol:	0	0	0	0	0	0	0	0	0	0	0	0
PasserByVol:	0	0	0	0	0	0	0	0	0	0	0	0
Initial Fut:	2	1093	166	91	400	0	2	32	14	19	1	8
User Adj:	1.00	1.00	1.00	1.00	1.00	1.00	1.00	1.00	1.00	1.00	1.00	1.00
PHF Adj:	1.00	1.00	1.00	1.00	1.00	1.00	1.00	1.00	1.00	1.00	1.00	1.00
PHF Volume:	2	1093	166	91	400	0	2	32	14	19	1	8
Reduct Vol:	0	0	0	0	0	0	0	0	0	0	0	0
FinalVolume:	2	1093	166	91	400	0	2	32	14	19	1	8
Critical Gap Module:												
Critical Gp:	4.1	xxxx	xxxxxx	4.1	xxxx	xxxxxx	7.1	6.5	6.2	7.1	6.5	6.2
FollowUpTim:	2.2	xxxx	xxxxxx	2.2	xxxx	xxxxxx	3.5	4.0	3.3	3.5	4.0	3.3
Capacity Module:												
Cnflct Vol:	400	xxxx	xxxxxx	1259	xxxx	xxxxxx	1133	1845	400	1785	1762	630
Potent Cap.:	1170	xxxx	xxxxxx	559	xxxx	xxxxxx	182	76	654	64	85	486
Move Cap.:	1170	xxxx	xxxxxx	559	xxxx	xxxxxx	153	63	654	33	70	486
Volume/Cap:	0.00	xxxx	xxxx	0.16	xxxx	xxxx	0.01	0.51	0.02	0.58	0.01	0.02
Level of Service Module:												
2Way95thQ:	0.0	xxxx	xxxxxx	0.6	xxxx	xxxxxx	xxxx	xxxx	xxxxxx	xxxx	xxxx	xxxxxx
Control Del:	8.1	xxxx	xxxxxx	12.7	xxxx	xxxxxx	xxxxxx	xxxx	xxxxxx	xxxxxx	xxxx	xxxxxx
LOS by Move:	A	*	*	B	*	*	*	*	*	*	*	*
Movement:	LT - LTR - RT			LT - LTR - RT			LT - LTR - RT			LT - LTR - RT		
Shared Cap.:	xxxx	xxxx	xxxxxx	xxxx	xxxx	xxxxxx	xxxx	88	xxxxxx	xxxx	46	xxxxxx
SharedQueue:	0.0	xxxx	xxxxxx	0.6	xxxx	xxxxxx	xxxxxx	2.4	xxxxxx	xxxxxx	2.3	xxxxxx
Shrd ConDel:	8.1	xxxx	xxxxxx	12.7	xxxx	xxxxxx	xxxxxx	86.8	xxxxxx	xxxxxx	165	xxxxxx
Shared LOS:	A	*	*	B	*	*	*	F	*	*	F	*
ApproachDel:	xxxxxx			xxxxxx				86.8			165.2	
ApproachLOS:	*			*				F			F	

Note: Queue reported is the number of cars per lane.

BART Phase II Extension Project

Level Of Service Computation Report
 2000 HCM Unsignalized (Future Volume Alternative)
 PM - 2025 SC West Project Conditions

Intersection #1008: Lafayette/Harrison

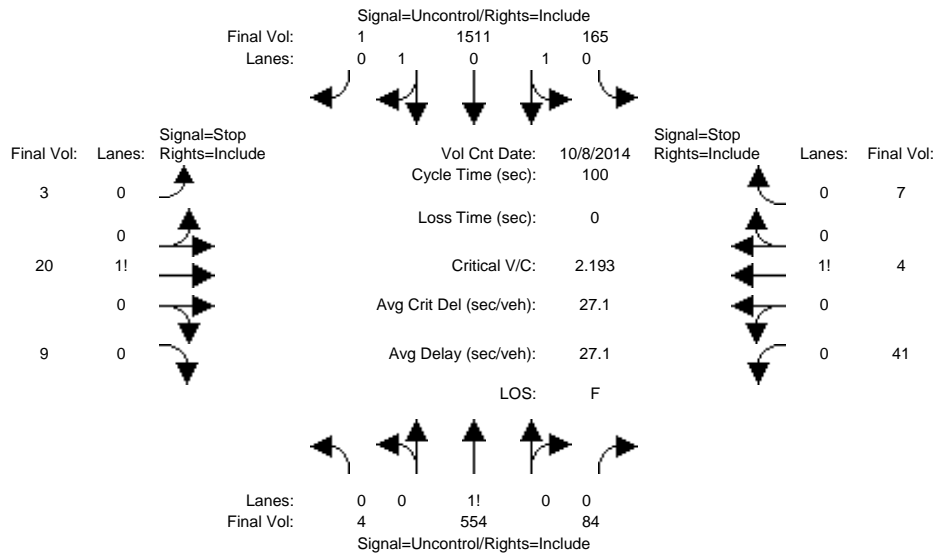

Approach:	North Bound			South Bound			East Bound			West Bound		
Movement:	L	T	R	L	T	R	L	T	R	L	T	R
Volume Module: >> Count Date: 8 Oct 2014 <<												
Base Vol:	4	554	84	165	1511	1	3	20	9	41	4	7
Growth Adj:	1.00	1.00	1.00	1.00	1.00	1.00	1.00	1.00	1.00	1.00	1.00	1.00
Initial Bse:	4	554	84	165	1511	1	3	20	9	41	4	7
Added Vol:	0	0	0	0	0	0	0	0	0	0	0	0
PasserByVol:	0	0	0	0	0	0	0	0	0	0	0	0
Initial Fut:	4	554	84	165	1511	1	3	20	9	41	4	7
User Adj:	1.00	1.00	1.00	1.00	1.00	1.00	1.00	1.00	1.00	1.00	1.00	1.00
PHF Adj:	1.00	1.00	1.00	1.00	1.00	1.00	1.00	1.00	1.00	1.00	1.00	1.00
PHF Volume:	4	554	84	165	1511	1	3	20	9	41	4	7
Reduct Vol:	0	0	0	0	0	0	0	0	0	0	0	0
FinalVolume:	4	554	84	165	1511	1	3	20	9	41	4	7
Critical Gap Module:												
Critical Gp:	4.1	xxxx	xxxxxx	4.1	xxxx	xxxxxx	7.1	6.5	6.2	7.1	6.5	6.2
FollowUpTim:	2.2	xxxx	xxxxxx	2.2	xxxx	xxxxxx	3.5	4.0	3.3	3.5	4.0	3.3
Capacity Module:												
Cnflct Vol:	1512	xxxx	xxxxxx	638	xxxx	xxxxxx	2451	2488	756	1700	2446	596
Potent Cap.:	448	xxxx	xxxxxx	956	xxxx	xxxxxx	21	30	411	74	32	507
Move Cap.:	448	xxxx	xxxxxx	956	xxxx	xxxxxx	16	24	411	19	25	507
Volume/Cap:	0.01	xxxx	xxxx	0.17	xxxx	xxxx	0.19	0.84	0.02	2.19	0.16	0.01
Level Of Service Module:												
2Way95thQ:	0.0	xxxx	xxxxxx	0.6	xxxx	xxxxxx	xxxx	xxxx	xxxxxx	xxxx	xxxx	xxxxxx
Control Del:	13.1	xxxx	xxxxxx	9.6	xxxx	xxxxxx	xxxxxx	xxxx	xxxxxx	xxxxxx	xxxx	xxxxxx
LOS by Move:	B	*	*	A	*	*	*	*	*	*	*	*
Movement:	LT	LTR	RT	LT	LTR	RT	LT	LTR	RT	LT	LTR	RT
Shared Cap.:	xxxx	xxxx	xxxxxx	xxxx	xxxx	xxxxxx	xxxx	31	xxxxxx	xxxx	22	xxxxxx
SharedQueue:	xxxxxx	xxxx	xxxxxx	0.6	xxxx	xxxxxx	xxxxxx	3.6	xxxxxx	xxxxxx	6.7	xxxxxx
Shrd ConDel:	xxxxxx	xxxx	xxxxxx	9.6	xxxx	xxxxxx	xxxxxx	370	xxxxxx	xxxxxx	994	xxxxxx
Shared LOS:	*	*	*	A	*	*	*	F	*	*	F	*
ApproachDel:	xxxxxxx			xxxxxxx			370.1			993.7		
ApproachLOS:	*			*			F			F		

Note: Queue reported is the number of cars per lane.

BART Phase II Extension Project

Level Of Service Computation Report
 2000 HCM Operations (Future Volume Alternative)
 AM - 2025 SC West Project Conditions

Intersection #1012: El Camino Real/Railroad Ave

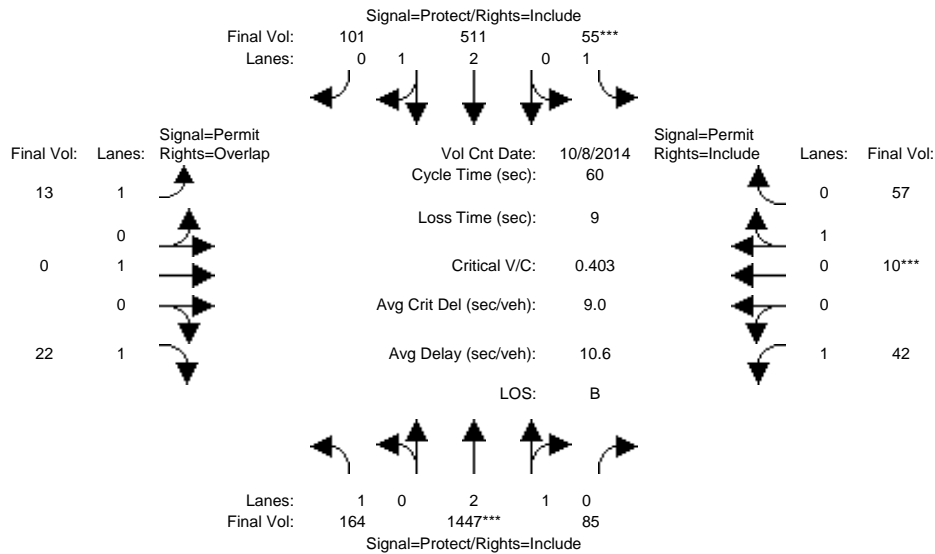

Approach:	North Bound			South Bound			East Bound			West Bound		
Movement:	L	T	R	L	T	R	L	T	R	L	T	R
Min. Green:	7	10	10	7	10	10	10	10	10	10	10	10
Y+R:	4.0	4.0	4.0	4.0	4.0	4.0	4.0	4.0	4.0	4.0	4.0	4.0
Volume Module: >> Count Date: 8 Oct 2014 <<												
Base Vol:	164	1447	85	55	511	101	13	0	22	42	10	57
Growth Adj:	1.00	1.00	1.00	1.00	1.00	1.00	1.00	1.00	1.00	1.00	1.00	1.00
Initial Bse:	164	1447	85	55	511	101	13	0	22	42	10	57
Added Vol:	0	0	0	0	0	0	0	0	0	0	0	0
PasserByVol:	0	0	0	0	0	0	0	0	0	0	0	0
Initial Fut:	164	1447	85	55	511	101	13	0	22	42	10	57
User Adj:	1.00	1.00	1.00	1.00	1.00	1.00	1.00	1.00	1.00	1.00	1.00	1.00
PHF Adj:	1.00	1.00	1.00	1.00	1.00	1.00	1.00	1.00	1.00	1.00	1.00	1.00
PHF Volume:	164	1447	85	55	511	101	13	0	22	42	10	57
Reduct Vol:	0	0	0	0	0	0	0	0	0	0	0	0
Reduced Vol:	164	1447	85	55	511	101	13	0	22	42	10	57
PCE Adj:	1.00	1.00	1.00	1.00	1.00	1.00	1.00	1.00	1.00	1.00	1.00	1.00
MLF Adj:	1.00	1.00	1.00	1.00	1.00	1.00	1.00	1.00	1.00	1.00	1.00	1.00
FinalVolume:	164	1447	85	55	511	101	13	0	22	42	10	57
Saturation Flow Module:												
Sat/Lane:	1900	1900	1900	1900	1900	1900	1900	1900	1900	1900	1900	1900
Adjustment:	0.92	0.98	0.95	0.92	0.99	0.95	0.92	1.00	0.92	0.92	0.95	0.95
Lanes:	1.00	2.83	0.17	1.00	2.49	0.51	1.00	1.00	1.00	1.00	0.15	0.85
Final Sat.:	1750	5289	311	1750	4675	924	1750	1900	1750	1750	269	1531
Capacity Analysis Module:												
Vol/Sat:	0.09	0.27	0.27	0.03	0.11	0.11	0.01	0.00	0.01	0.02	0.04	0.04
Crit Moves:	****			****						****		
Green Time:	16.9	34.0	34.0	7.0	24.1	24.1	10.0	0.0	26.9	10.0	10.0	10.0
Volume/Cap:	0.33	0.48	0.48	0.27	0.27	0.27	0.04	0.00	0.03	0.14	0.22	0.22
Delay/Veh:	17.5	7.9	7.9	24.9	12.1	12.1	21.1	0.0	9.3	21.6	22.0	22.0
User DelAdj:	1.00	1.00	1.00	1.00	1.00	1.00	1.00	1.00	1.00	1.00	1.00	1.00
AdjDel/Veh:	17.5	7.9	7.9	24.9	12.1	12.1	21.1	0.0	9.3	21.6	22.0	22.0
LOS by Move:	B	A	A	C	B	B	C	A	A	C	C	C
HCM2k95thQ:	6	12	12	2	5	5	1	0	1	2	3	3

Note: Queue reported is the number of cars per lane.

BART Phase II Extension Project

Level Of Service Computation Report
 2000 HCM Operations (Future Volume Alternative)
 PM - 2025 SC West Project Conditions

Intersection #1012: El Camino Real/Railroad Ave

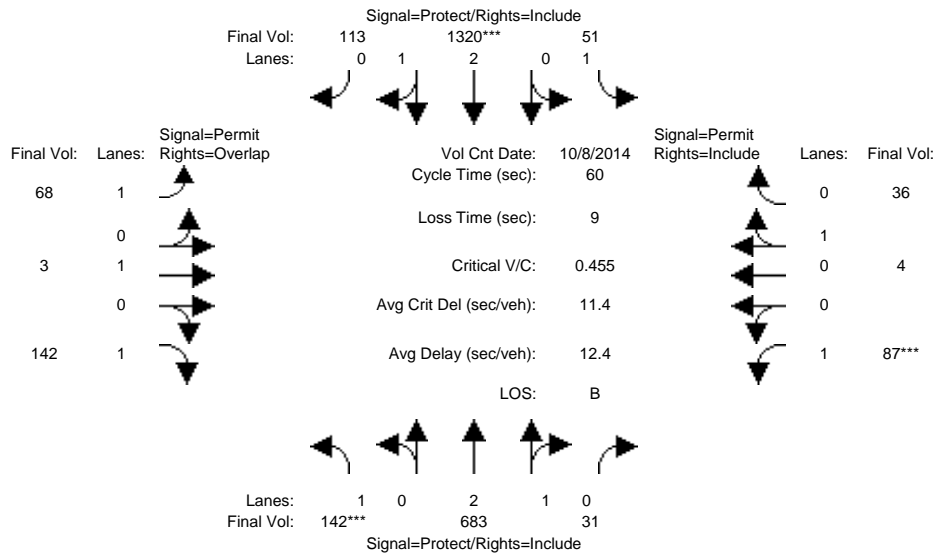

Approach:	North Bound			South Bound			East Bound			West Bound		
	L	T	R	L	T	R	L	T	R	L	T	R
Min. Green:	7	10	10	7	10	10	10	10	10	10	10	10
Y+R:	4.0	4.0	4.0	4.0	4.0	4.0	4.0	4.0	4.0	4.0	4.0	4.0
Volume Module: >> Count Date: 8 Oct 2014 <<												
Base Vol:	142	683	31	51	1320	113	68	3	142	87	4	36
Growth Adj:	1.00	1.00	1.00	1.00	1.00	1.00	1.00	1.00	1.00	1.00	1.00	1.00
Initial Bse:	142	683	31	51	1320	113	68	3	142	87	4	36
Added Vol:	0	0	0	0	0	0	0	0	0	0	0	0
PasserByVol:	0	0	0	0	0	0	0	0	0	0	0	0
Initial Fut:	142	683	31	51	1320	113	68	3	142	87	4	36
User Adj:	1.00	1.00	1.00	1.00	1.00	1.00	1.00	1.00	1.00	1.00	1.00	1.00
PHF Adj:	1.00	1.00	1.00	1.00	1.00	1.00	1.00	1.00	1.00	1.00	1.00	1.00
PHF Volume:	142	683	31	51	1320	113	68	3	142	87	4	36
Reduct Vol:	0	0	0	0	0	0	0	0	0	0	0	0
Reduced Vol:	142	683	31	51	1320	113	68	3	142	87	4	36
PCE Adj:	1.00	1.00	1.00	1.00	1.00	1.00	1.00	1.00	1.00	1.00	1.00	1.00
MLF Adj:	1.00	1.00	1.00	1.00	1.00	1.00	1.00	1.00	1.00	1.00	1.00	1.00
Final Volume:	142	683	31	51	1320	113	68	3	142	87	4	36
Saturation Flow Module:												
Sat/Lane:	1900	1900	1900	1900	1900	1900	1900	1900	1900	1900	1900	1900
Adjustment:	0.92	0.98	0.95	0.92	0.99	0.95	0.92	1.00	0.92	0.92	0.95	0.95
Lanes:	1.00	2.86	0.14	1.00	2.75	0.25	1.00	1.00	1.00	1.00	0.10	0.90
Final Sat.:	1750	5357	243	1750	5158	442	1750	1900	1750	1750	180	1620
Capacity Analysis Module:												
Vol/Sat:	0.08	0.13	0.13	0.03	0.26	0.26	0.04	0.00	0.08	0.05	0.02	0.02
Crit Moves:	****				****					****		
Green Time:	9.9	24.1	24.1	16.9	31.1	31.1	10.0	10.0	19.9	10.0	10.0	10.0
Volume/Cap:	0.49	0.32	0.32	0.10	0.49	0.49	0.23	0.01	0.25	0.30	0.13	0.13
Delay/Veh:	24.1	12.4	12.4	16.1	9.5	9.5	22.1	20.9	14.8	22.5	21.5	21.5
User DelAdj:	1.00	1.00	1.00	1.00	1.00	1.00	1.00	1.00	1.00	1.00	1.00	1.00
AdjDel/Veh:	24.1	12.4	12.4	16.1	9.5	9.5	22.1	20.9	14.8	22.5	21.5	21.5
LOS by Move:	C	B	B	B	A	A	C	C	B	C	C	C
HCM2k95thQ:	7	6	6	1	11	11	3	0	4	4	2	2

Note: Queue reported is the number of cars per lane.

BART Phase II Extension Project

Level Of Service Computation Report
 2000 HCM Operations (Future Volume Alternative)
 AM - 2025 SC West Project Conditions

Intersection #1202: LAFAYETTE/EL CAMINO REAL

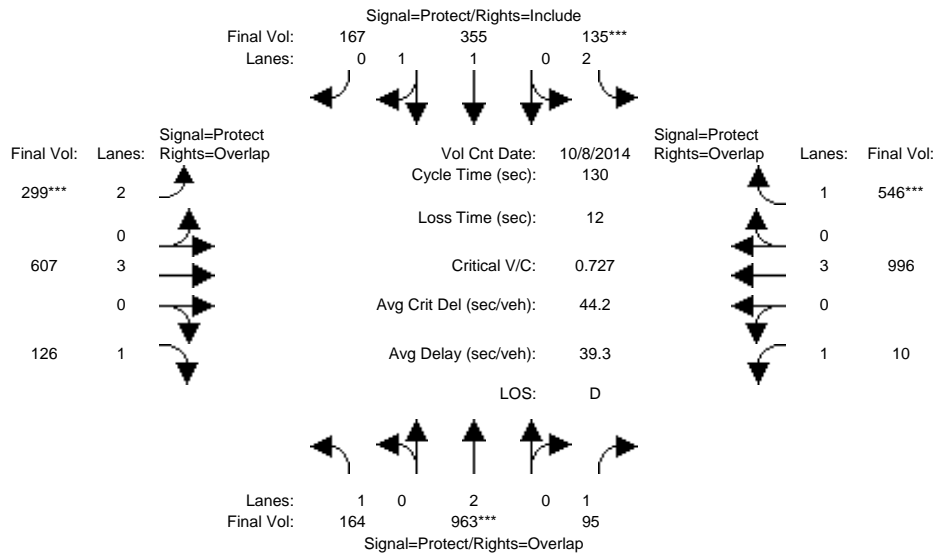

Approach:	North Bound			South Bound			East Bound			West Bound		
	L	T	R	L	T	R	L	T	R	L	T	R
Min. Green:	7	10	10	7	10	10	7	10	10	7	10	10
Y+R:	4.0	4.0	4.0	4.0	4.0	4.0	4.0	4.0	4.0	4.0	4.0	4.0
Volume Module: >> Count Date: 8 Oct 2014 <<												
Base Vol:	164	963	95	135	355	167	299	607	126	10	996	546
Growth Adj:	1.00	1.00	1.00	1.00	1.00	1.00	1.00	1.00	1.00	1.00	1.00	1.00
Initial Bse:	164	963	95	135	355	167	299	607	126	10	996	546
Added Vol:	0	0	0	0	0	0	0	0	0	0	0	0
PasserByVol:	0	0	0	0	0	0	0	0	0	0	0	0
Initial Fut:	164	963	95	135	355	167	299	607	126	10	996	546
User Adj:	1.00	1.00	1.00	1.00	1.00	1.00	1.00	1.00	1.00	1.00	1.00	1.00
PHF Adj:	1.00	1.00	1.00	1.00	1.00	1.00	1.00	1.00	1.00	1.00	1.00	1.00
PHF Volume:	164	963	95	135	355	167	299	607	126	10	996	546
Reduct Vol:	0	0	0	0	0	0	0	0	0	0	0	0
Reduced Vol:	164	963	95	135	355	167	299	607	126	10	996	546
PCE Adj:	1.00	1.00	1.00	1.00	1.00	1.00	1.00	1.00	1.00	1.00	1.00	1.00
MLF Adj:	1.00	1.00	1.00	1.00	1.00	1.00	1.00	1.00	1.00	1.00	1.00	1.00
FinalVolume:	164	963	95	135	355	167	299	607	126	10	996	546
Saturation Flow Module:												
Sat/Lane:	1900	1900	1900	1900	1900	1900	1900	1900	1900	1900	1900	1900
Adjustment:	0.92	1.00	0.92	0.83	0.99	0.95	0.83	1.00	0.92	0.92	1.00	0.92
Lanes:	1.00	2.00	1.00	2.00	1.34	0.66	2.00	3.00	1.00	1.00	3.00	1.00
Final Sat.:	1750	3800	1750	3150	2515	1183	3150	5700	1750	1750	5700	1750
Capacity Analysis Module:												
Vol/Sat:	0.09	0.25	0.05	0.04	0.14	0.14	0.09	0.11	0.07	0.01	0.17	0.31
Crit Moves:	****			****			****			****		
Green Time:	21.1	45.3	66.5	7.7	31.8	31.8	17.0	41.9	63.0	21.2	46.1	53.8
Volume/Cap:	0.58	0.73	0.11	0.73	0.58	0.58	0.73	0.33	0.15	0.04	0.49	0.75
Delay/Veh:	53.2	39.0	16.5	73.6	44.1	44.1	60.7	33.5	18.7	45.9	33.0	37.0
User DelAdj:	1.00	1.00	1.00	1.00	1.00	1.00	1.00	1.00	1.00	1.00	1.00	1.00
AdjDel/Veh:	53.2	39.0	16.5	73.6	44.1	44.1	60.7	33.5	18.7	45.9	33.0	37.0
LOS by Move:	D	D	B	E	D	D	E	C	B	D	C	D
HCM2k95thQ:	12	29	4	7	17	17	13	11	6	1	19	35

Note: Queue reported is the number of cars per lane.

BART Phase II Extension Project

Level Of Service Computation Report
2000 HCM Operations (Future Volume Alternative)
PM - 2025 SC West Project Conditions

Intersection #1202: LAFAYETTE/EL CAMINO REAL

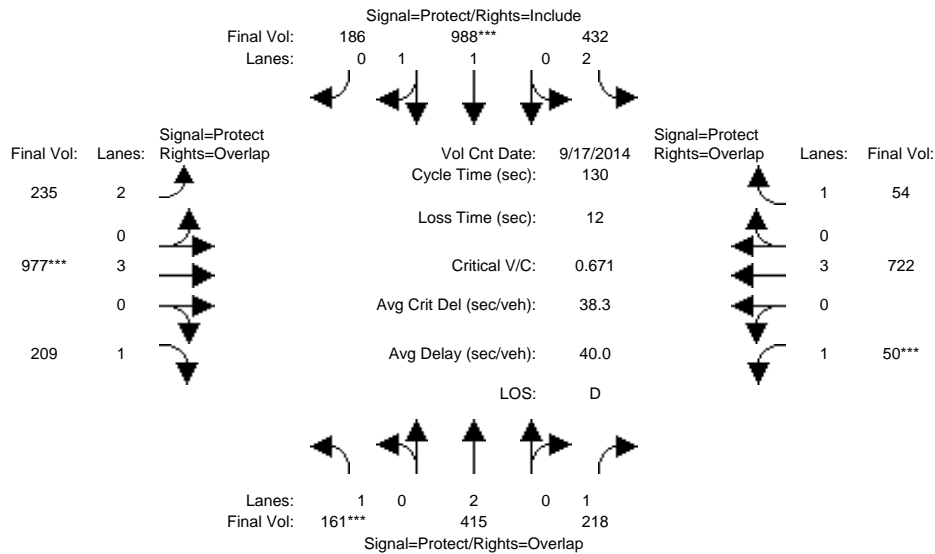

Approach:	North Bound			South Bound			East Bound			West Bound		
Movement:	L	T	R	L	T	R	L	T	R	L	T	R
Min. Green:	7	10	10	7	10	10	7	10	10	7	10	10
Y+R:	4.0	4.0	4.0	4.0	4.0	4.0	4.0	4.0	4.0	4.0	4.0	4.0
Volume Module: >> Count Date: 17 Sep 2014 <<												
Base Vol:	161	415	218	432	988	186	235	977	209	50	722	54
Growth Adj:	1.00	1.00	1.00	1.00	1.00	1.00	1.00	1.00	1.00	1.00	1.00	1.00
Initial Bse:	161	415	218	432	988	186	235	977	209	50	722	54
Added Vol:	0	0	0	0	0	0	0	0	0	0	0	0
PasserByVol:	0	0	0	0	0	0	0	0	0	0	0	0
Initial Fut:	161	415	218	432	988	186	235	977	209	50	722	54
User Adj:	1.00	1.00	1.00	1.00	1.00	1.00	1.00	1.00	1.00	1.00	1.00	1.00
PHF Adj:	1.00	1.00	1.00	1.00	1.00	1.00	1.00	1.00	1.00	1.00	1.00	1.00
PHF Volume:	161	415	218	432	988	186	235	977	209	50	722	54
Reduct Vol:	0	0	0	0	0	0	0	0	0	0	0	0
Reduced Vol:	161	415	218	432	988	186	235	977	209	50	722	54
PCE Adj:	1.00	1.00	1.00	1.00	1.00	1.00	1.00	1.00	1.00	1.00	1.00	1.00
MLF Adj:	1.00	1.00	1.00	1.00	1.00	1.00	1.00	1.00	1.00	1.00	1.00	1.00
FinalVolume:	161	415	218	432	988	186	235	977	209	50	722	54
Saturation Flow Module:												
Sat/Lane:	1900	1900	1900	1900	1900	1900	1900	1900	1900	1900	1900	1900
Adjustment:	0.92	1.00	0.92	0.83	0.98	0.95	0.83	1.00	0.92	0.92	1.00	0.92
Lanes:	1.00	2.00	1.00	2.00	1.67	0.33	2.00	3.00	1.00	1.00	3.00	1.00
Final Sat.:	1750	3800	1750	3150	3113	586	3150	5700	1750	1750	5700	1750
Capacity Analysis Module:												
Vol/Sat:	0.09	0.11	0.12	0.14	0.32	0.32	0.07	0.17	0.12	0.03	0.13	0.03
Crit Moves:	****			****			****			****		
Green Time:	17.6	34.7	41.7	43.6	60.7	60.7	14.7	32.8	50.3	7.0	25.0	68.6
Volume/Cap:	0.68	0.41	0.39	0.41	0.68	0.68	0.66	0.68	0.31	0.53	0.66	0.06
Delay/Veh:	61.3	39.5	34.7	33.6	28.2	28.2	59.7	45.2	28.0	65.6	50.0	15.0
User DelAdj:	1.00	1.00	1.00	1.00	1.00	1.00	1.00	1.00	1.00	1.00	1.00	1.00
AdjDel/Veh:	61.3	39.5	34.7	33.6	28.2	28.2	59.7	45.2	28.0	65.6	50.0	15.0
LOS by Move:	E	D	C	C	C	C	E	D	C	E	D	B
HCM2k95thQ:	13	12	13	15	32	32	11	21	12	6	18	2

Note: Queue reported is the number of cars per lane.

BART Phase II Extension Project

Level Of Service Computation Report
 2000 HCM Operations (Future Volume Alternative)
 AM - 2025 SC West Project Conditions

Intersection #1204: MONROE/EL CAMINO REAL

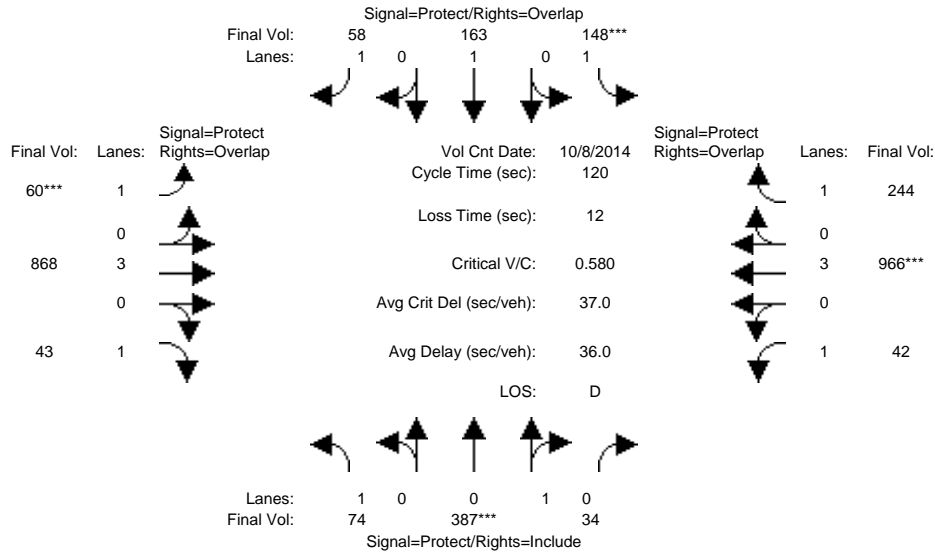

Approach:	North Bound			South Bound			East Bound			West Bound		
	L	T	R	L	T	R	L	T	R	L	T	R
Min. Green:	7	10	10	7	10	10	7	10	10	7	10	10
Y+R:	4.0	4.0	4.0	4.0	4.0	4.0	4.0	4.0	4.0	4.0	4.0	4.0

Volume Module: >> Count Date: 8 Oct 2014 <<

Base Vol:	74	387	34	148	163	58	60	868	43	42	966	244
Growth Adj:	1.00	1.00	1.00	1.00	1.00	1.00	1.00	1.00	1.00	1.00	1.00	1.00
Initial Bse:	74	387	34	148	163	58	60	868	43	42	966	244
Added Vol:	0	0	0	0	0	0	0	0	0	0	0	0
PasserByVol:	0	0	0	0	0	0	0	0	0	0	0	0
Initial Fut:	74	387	34	148	163	58	60	868	43	42	966	244
User Adj:	1.00	1.00	1.00	1.00	1.00	1.00	1.00	1.00	1.00	1.00	1.00	1.00
PHF Adj:	1.00	1.00	1.00	1.00	1.00	1.00	1.00	1.00	1.00	1.00	1.00	1.00
PHF Volume:	74	387	34	148	163	58	60	868	43	42	966	244
Reduct Vol:	0	0	0	0	0	0	0	0	0	0	0	0
Reduced Vol:	74	387	34	148	163	58	60	868	43	42	966	244
PCE Adj:	1.00	1.00	1.00	1.00	1.00	1.00	1.00	1.00	1.00	1.00	1.00	1.00
MLF Adj:	1.00	1.00	1.00	1.00	1.00	1.00	1.00	1.00	1.00	1.00	1.00	1.00
FinalVolume:	74	387	34	148	163	58	60	868	43	42	966	244

Saturation Flow Module:

Sat/Lane:	1900	1900	1900	1900	1900	1900	1900	1900	1900	1900	1900	1900
Adjustment:	0.92	0.95	0.95	0.92	1.00	0.92	0.92	1.00	0.92	0.92	1.00	0.92
Lanes:	1.00	0.92	0.08	1.00	1.00	1.00	1.00	3.00	1.00	1.00	3.00	1.00
Final Sat.:	1750	1655	145	1750	1900	1750	1750	5700	1750	1750	5700	1750

Capacity Analysis Module:

Vol/Sat:	0.04	0.23	0.23	0.08	0.09	0.03	0.03	0.15	0.02	0.02	0.17	0.14
Crit Moves:	****	****	****	****	****	****	****	****	****	****	****	****
Green Time:	26.7	48.4	48.4	17.5	39.2	46.3	7.1	30.5	57.1	11.7	35.0	52.5
Volume/Cap:	0.19	0.58	0.58	0.58	0.26	0.09	0.58	0.60	0.05	0.25	0.58	0.32
Delay/Veh:	38.1	29.1	29.1	51.2	30.0	23.5	63.0	40.1	16.9	50.9	36.7	22.3
User DelAdj:	1.00	1.00	1.00	1.00	1.00	1.00	1.00	1.00	1.00	1.00	1.00	1.00
AdjDel/Veh:	38.1	29.1	29.1	51.2	30.0	23.5	63.0	40.1	16.9	50.9	36.7	22.3
LOS by Move:	D	C	C	D	C	C	E	D	B	D	D	C
HCM2k95thQ:	5	23	23	11	8	3	5	17	2	3	18	12

Note: Queue reported is the number of cars per lane.

BART Phase II Extension Project

Level Of Service Computation Report
 2000 HCM Operations (Future Volume Alternative)
 PM - 2025 SC West Project Conditions

Intersection #1204: MONROE/EL CAMINO REAL

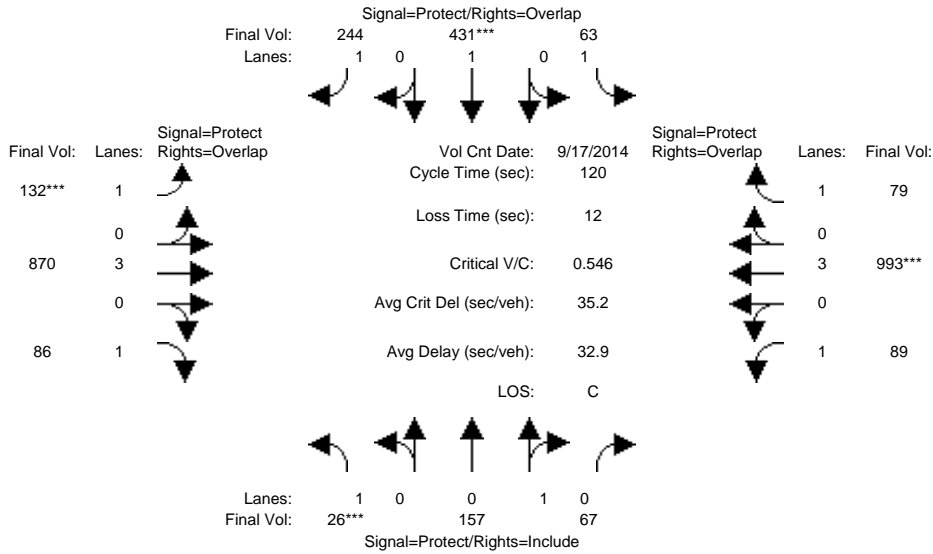

Approach:	North Bound			South Bound			East Bound			West Bound		
	L	T	R	L	T	R	L	T	R	L	T	R
Min. Green:	7	10	10	7	10	10	7	10	10	7	10	10
Y+R:	4.0	4.0	4.0	4.0	4.0	4.0	4.0	4.0	4.0	4.0	4.0	4.0
Volume Module: >> Count Date: 17 Sep 2014 <<												
Base Vol:	26	157	67	63	431	244	132	870	86	89	993	79
Growth Adj:	1.00	1.00	1.00	1.00	1.00	1.00	1.00	1.00	1.00	1.00	1.00	1.00
Initial Bse:	26	157	67	63	431	244	132	870	86	89	993	79
Added Vol:	0	0	0	0	0	0	0	0	0	0	0	0
PasserByVol:	0	0	0	0	0	0	0	0	0	0	0	0
Initial Fut:	26	157	67	63	431	244	132	870	86	89	993	79
User Adj:	1.00	1.00	1.00	1.00	1.00	1.00	1.00	1.00	1.00	1.00	1.00	1.00
PHF Adj:	1.00	1.00	1.00	1.00	1.00	1.00	1.00	1.00	1.00	1.00	1.00	1.00
PHF Volume:	26	157	67	63	431	244	132	870	86	89	993	79
Reduct Vol:	0	0	0	0	0	0	0	0	0	0	0	0
Reduced Vol:	26	157	67	63	431	244	132	870	86	89	993	79
PCE Adj:	1.00	1.00	1.00	1.00	1.00	1.00	1.00	1.00	1.00	1.00	1.00	1.00
MLF Adj:	1.00	1.00	1.00	1.00	1.00	1.00	1.00	1.00	1.00	1.00	1.00	1.00
FinalVolume:	26	157	67	63	431	244	132	870	86	89	993	79
Saturation Flow Module:												
Sat/Lane:	1900	1900	1900	1900	1900	1900	1900	1900	1900	1900	1900	1900
Adjustment:	0.92	0.95	0.95	0.92	1.00	0.92	0.92	1.00	0.92	0.92	1.00	0.92
Lanes:	1.00	0.70	0.30	1.00	1.00	1.00	1.00	3.00	1.00	1.00	3.00	1.00
Final Sat.:	1750	1262	538	1750	1900	1750	1750	5700	1750	1750	5700	1750
Capacity Analysis Module:												
Vol/Sat:	0.01	0.12	0.12	0.04	0.23	0.14	0.08	0.15	0.05	0.05	0.17	0.05
Crit Moves:	****			****			****			****		
Green Time:	7.0	37.5	37.5	17.6	48.1	64.1	16.0	38.3	45.3	14.6	36.9	54.5
Volume/Cap:	0.25	0.40	0.40	0.25	0.57	0.26	0.57	0.48	0.13	0.42	0.57	0.10
Delay/Veh:	55.3	32.9	32.9	45.8	28.9	15.3	52.0	33.0	24.6	50.1	35.3	18.8
User DelAdj:	1.00	1.00	1.00	1.00	1.00	1.00	1.00	1.00	1.00	1.00	1.00	1.00
AdjDel/Veh:	55.3	32.9	32.9	45.8	28.9	15.3	52.0	33.0	24.6	50.1	35.3	18.8
LOS by Move:	E	C	C	D	C	B	D	C	C	D	D	B
HCM2k95thQ:	3	13	13	4	22	10	10	16	4	6	18	3

Note: Queue reported is the number of cars per lane.

BART Phase II Extension Project

Level Of Service Computation Report
 2000 HCM Operations (Future Volume Alternative)
 AM - 2025 SC West Project Conditions

Intersection #1205: SCOTT/EL CAMINO REAL

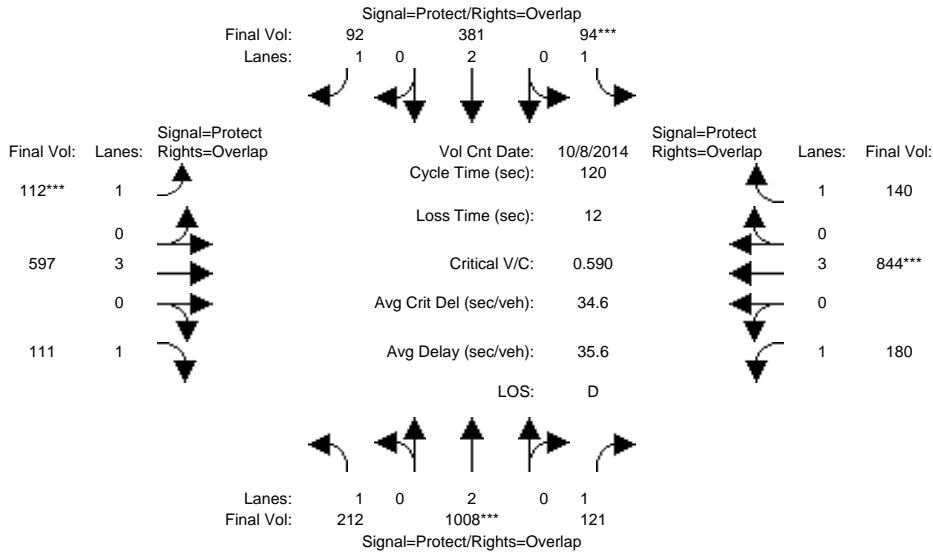

Approach:	North Bound			South Bound			East Bound			West Bound		
Movement:	L	T	R	L	T	R	L	T	R	L	T	R
Min. Green:	7	10	10	7	10	10	7	10	10	7	10	10
Y+R:	4.0	4.0	4.0	4.0	4.0	4.0	4.0	4.0	4.0	4.0	4.0	4.0
Volume Module: >> Count Date: 8 Oct 2014 <<												
Base Vol:	212	1008	121	94	381	92	112	597	111	180	844	140
Growth Adj:	1.00	1.00	1.00	1.00	1.00	1.00	1.00	1.00	1.00	1.00	1.00	1.00
Initial Bse:	212	1008	121	94	381	92	112	597	111	180	844	140
Added Vol:	0	0	0	0	0	0	0	0	0	0	0	0
PasserByVol:	0	0	0	0	0	0	0	0	0	0	0	0
Initial Fut:	212	1008	121	94	381	92	112	597	111	180	844	140
User Adj:	1.00	1.00	1.00	1.00	1.00	1.00	1.00	1.00	1.00	1.00	1.00	1.00
PHF Adj:	1.00	1.00	1.00	1.00	1.00	1.00	1.00	1.00	1.00	1.00	1.00	1.00
PHF Volume:	212	1008	121	94	381	92	112	597	111	180	844	140
Reduct Vol:	0	0	0	0	0	0	0	0	0	0	0	0
Reduced Vol:	212	1008	121	94	381	92	112	597	111	180	844	140
PCE Adj:	1.00	1.00	1.00	1.00	1.00	1.00	1.00	1.00	1.00	1.00	1.00	1.00
MLF Adj:	1.00	1.00	1.00	1.00	1.00	1.00	1.00	1.00	1.00	1.00	1.00	1.00
Final Volume:	212	1008	121	94	381	92	112	597	111	180	844	140
Saturation Flow Module:												
Sat/Lane:	1900	1900	1900	1900	1900	1900	1900	1900	1900	1900	1900	1900
Adjustment:	0.92	1.00	0.92	0.92	1.00	0.92	0.92	1.00	0.92	0.92	1.00	0.92
Lanes:	1.00	2.00	1.00	1.00	2.00	1.00	1.00	3.00	1.00	1.00	3.00	1.00
Final Sat.:	1750	3800	1750	1750	3800	1750	1750	5700	1750	1750	5700	1750
Capacity Analysis Module:												
Vol/Sat:	0.12	0.27	0.07	0.05	0.10	0.05	0.06	0.10	0.06	0.10	0.15	0.08
Crit Moves:	****			****			****			****		
Green Time:	35.5	53.9	75.3	10.9	29.4	42.4	13.0	21.8	57.3	21.4	30.1	41.0
Volume/Cap:	0.41	0.59	0.11	0.59	0.41	0.15	0.59	0.58	0.13	0.58	0.59	0.23
Delay/Veh:	34.4	25.3	9.0	58.1	38.3	26.6	55.8	45.7	17.6	47.9	40.2	28.4
User DelAdj:	1.00	1.00	1.00	1.00	1.00	1.00	1.00	1.00	1.00	1.00	1.00	1.00
AdjDel/Veh:	34.4	25.3	9.0	58.1	38.3	26.6	55.8	45.7	17.6	47.9	40.2	28.4
LOS by Move:	C	C	A	E	D	C	E	D	B	D	D	C
HCM2k95thQ:	13	24	4	7	11	5	8	13	5	13	17	8

Note: Queue reported is the number of cars per lane.

BART Phase II Extension Project

Level Of Service Computation Report
 2000 HCM Operations (Future Volume Alternative)
 PM - 2025 SC West Project Conditions

Intersection #1205: SCOTT/EL CAMINO REAL

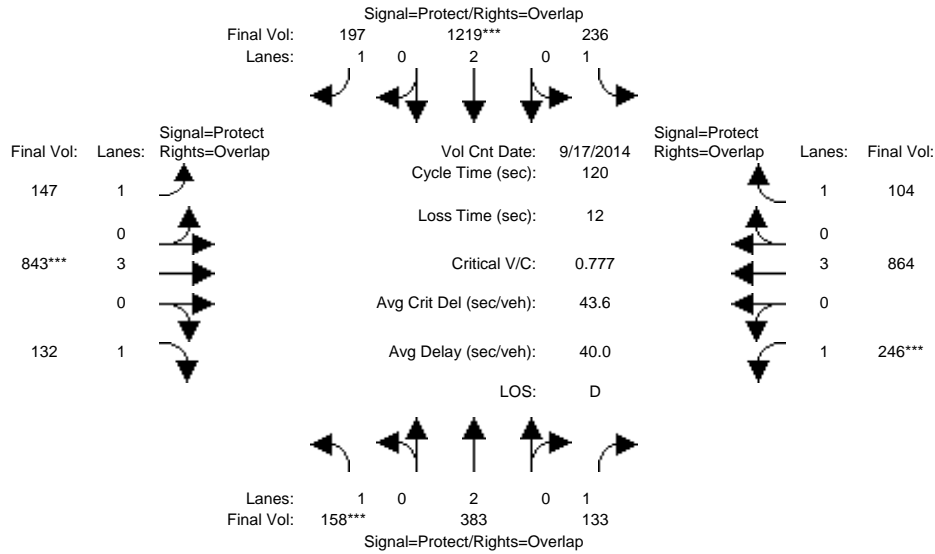

Approach:	North Bound			South Bound			East Bound			West Bound		
	L	T	R	L	T	R	L	T	R	L	T	R
Min. Green:	7	10	10	7	10	10	7	10	10	7	10	10
Y+R:	4.0	4.0	4.0	4.0	4.0	4.0	4.0	4.0	4.0	4.0	4.0	4.0

Volume Module:	>> Count Date: 17 Sep 2014 <<											
Base Vol:	158	383	133	236	1219	197	147	843	132	246	864	104
Growth Adj:	1.00	1.00	1.00	1.00	1.00	1.00	1.00	1.00	1.00	1.00	1.00	1.00
Initial Bse:	158	383	133	236	1219	197	147	843	132	246	864	104
Added Vol:	0	0	0	0	0	0	0	0	0	0	0	0
PasserByVol:	0	0	0	0	0	0	0	0	0	0	0	0
Initial Fut:	158	383	133	236	1219	197	147	843	132	246	864	104
User Adj:	1.00	1.00	1.00	1.00	1.00	1.00	1.00	1.00	1.00	1.00	1.00	1.00
PHF Adj:	1.00	1.00	1.00	1.00	1.00	1.00	1.00	1.00	1.00	1.00	1.00	1.00
PHF Volume:	158	383	133	236	1219	197	147	843	132	246	864	104
Reduct Vol:	0	0	0	0	0	0	0	0	0	0	0	0
Reduced Vol:	158	383	133	236	1219	197	147	843	132	246	864	104
PCE Adj:	1.00	1.00	1.00	1.00	1.00	1.00	1.00	1.00	1.00	1.00	1.00	1.00
MLF Adj:	1.00	1.00	1.00	1.00	1.00	1.00	1.00	1.00	1.00	1.00	1.00	1.00
Final Volume:	158	383	133	236	1219	197	147	843	132	246	864	104

Saturation Flow Module:												
Sat/Lane:	1900	1900	1900	1900	1900	1900	1900	1900	1900	1900	1900	1900
Adjustment:	0.92	1.00	0.92	0.92	1.00	0.92	0.92	1.00	0.92	0.92	1.00	0.92
Lanes:	1.00	2.00	1.00	1.00	2.00	1.00	1.00	3.00	1.00	1.00	3.00	1.00
Final Sat.:	1750	3800	1750	1750	3800	1750	1750	5700	1750	1750	5700	1750

Capacity Analysis Module:												
Vol/Sat:	0.09	0.10	0.08	0.13	0.32	0.11	0.08	0.15	0.08	0.14	0.15	0.06
Crit Moves:	****				****			****			****	
Green Time:	13.9	27.1	48.8	36.3	49.5	65.4	15.9	22.8	36.8	21.7	28.7	65.0
Volume/Cap:	0.78	0.45	0.19	0.45	0.78	0.21	0.63	0.78	0.25	0.78	0.63	0.11
Delay/Veh:	68.6	40.3	23.0	34.3	33.0	14.1	55.0	49.8	31.5	58.4	42.0	13.5
User DelAdj:	1.00	1.00	1.00	1.00	1.00	1.00	1.00	1.00	1.00	1.00	1.00	1.00
AdjDel/Veh:	68.6	40.3	23.0	34.3	33.0	14.1	55.0	49.8	31.5	58.4	42.0	13.5
LOS by Move:	E	D	C	C	C	B	E	D	C	E	D	B
HCM2k95thQ:	13	11	7	14	34	8	11	19	8	18	18	4

Note: Queue reported is the number of cars per lane.

BART Phase II Extension Project

Level Of Service Computation Report
 2000 HCM Operations (Future Volume Alternative)
 AM - 2025 SC West Project Conditions

Intersection #1213: THE ALAMEDA/EL CAMINO REAL

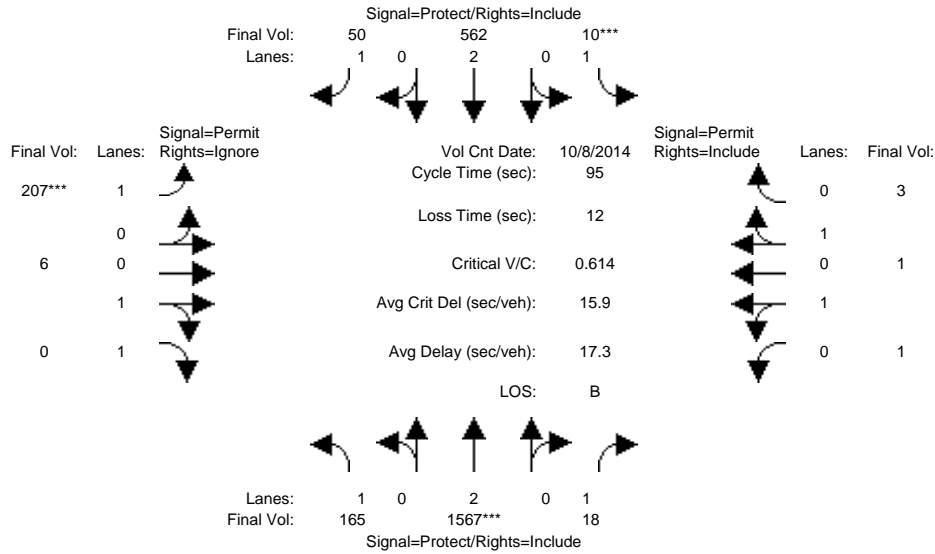

Approach:	North Bound			South Bound			East Bound			West Bound		
	L	T	R	L	T	R	L	T	R	L	T	R
Min. Green:	7	10	10	7	10	10	7	10	10	7	10	10
Y+R:	4.0	4.0	4.0	4.0	4.0	4.0	4.0	4.0	4.0	4.0	4.0	4.0

Volume Module:	>> Count Date: 8 Oct 2014 <<											
Base Vol:	165	1567	18	10	562	50	207	6	195	1	1	3
Growth Adj:	1.00	1.00	1.00	1.00	1.00	1.00	1.00	1.00	1.00	1.00	1.00	1.00
Initial Bse:	165	1567	18	10	562	50	207	6	195	1	1	3
Added Vol:	0	0	0	0	0	0	0	0	0	0	0	0
PasserByVol:	0	0	0	0	0	0	0	0	0	0	0	0
Initial Fut:	165	1567	18	10	562	50	207	6	195	1	1	3
User Adj:	1.00	1.00	1.00	1.00	1.00	1.00	1.00	1.00	0.00	1.00	1.00	1.00
PHF Adj:	1.00	1.00	1.00	1.00	1.00	1.00	1.00	1.00	0.00	1.00	1.00	1.00
PHF Volume:	165	1567	18	10	562	50	207	6	0	1	1	3
Reduct Vol:	0	0	0	0	0	0	0	0	0	0	0	0
Reduced Vol:	165	1567	18	10	562	50	207	6	0	1	1	3
PCE Adj:	1.00	1.00	1.00	1.00	1.00	1.00	1.00	1.00	0.00	1.00	1.00	1.00
MLF Adj:	1.00	1.00	1.00	1.00	1.00	1.00	1.00	1.00	0.00	1.00	1.00	1.00
FinalVolume:	165	1567	18	10	562	50	207	6	0	1	1	3

Saturation Flow Module:												
Sat/Lane:	1900	1900	1900	1900	1900	1900	1900	1900	1900	1900	1900	1900
Adjustment:	0.92	1.00	0.92	0.92	1.00	0.92	0.92	0.95	0.92	0.95	0.95	0.95
Lanes:	1.00	2.00	1.00	1.00	2.00	1.00	1.00	1.00	1.00	0.50	0.50	1.00
Final Sat.:	1750	3800	1750	1750	3800	1750	1750	1800	1750	900	900	1800

Capacity Analysis Module:												
Vol/Sat:	0.09	0.41	0.01	0.01	0.15	0.03	0.12	0.00	0.00	0.00	0.00	0.00
Crit Moves:	****			****			****					
Green Time:	25.7	59.1	59.1	7.0	40.3	40.3	16.9	16.9	0.0	16.9	16.9	16.9
Volume/Cap:	0.35	0.66	0.02	0.08	0.35	0.07	0.66	0.02	0.00	0.01	0.01	0.01
Delay/Veh:	28.3	12.3	6.9	41.3	18.6	16.2	41.7	32.2	0.0	32.1	32.1	32.1
User DelAdj:	1.00	1.00	1.00	1.00	1.00	1.00	1.00	1.00	1.00	1.00	1.00	1.00
AdjDel/Veh:	28.3	12.3	6.9	41.3	18.6	16.2	41.7	32.2	0.0	32.1	32.1	32.1
LOS by Move:	C	B	A	D	B	B	D	C	A	C	C	C
HCM2k95thQ:	8	25	0	1	11	2	14	0	0	0	0	0

Note: Queue reported is the number of cars per lane.

BART Phase II Extension Project

Level Of Service Computation Report
 2000 HCM Operations (Future Volume Alternative)
 PM - 2025 SC West Project Conditions

Intersection #1213: THE ALAMEDA/EL CAMINO REAL

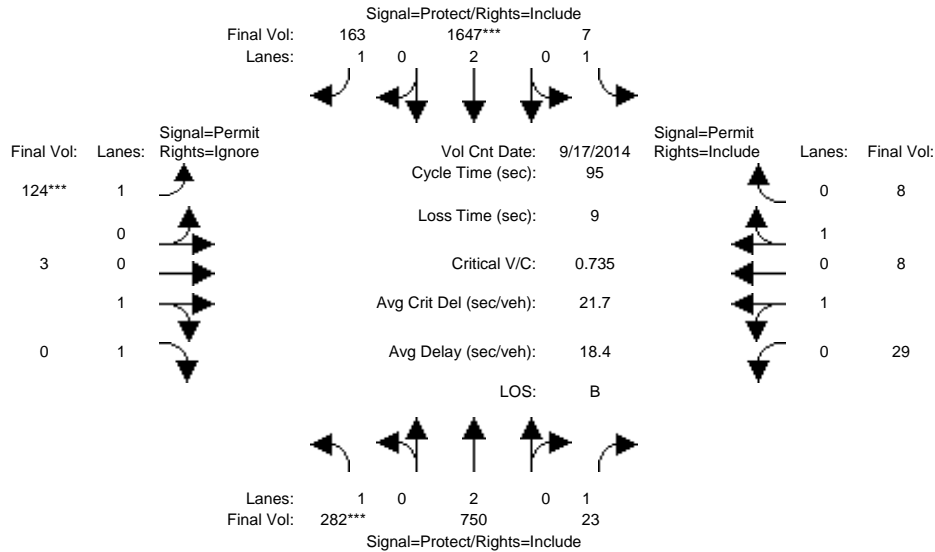

Approach:	North Bound			South Bound			East Bound			West Bound		
	L	T	R	L	T	R	L	T	R	L	T	R
Min. Green:	7	10	10	7	10	10	10	10	10	10	10	10
Y+R:	4.0	4.0	4.0	4.0	4.0	4.0	4.0	4.0	4.0	4.0	4.0	4.0

Volume Module:	>> Count Date: 17 Sep 2014 <<											
Base Vol:	282	750	23	7	1647	163	124	3	272	29	8	8
Growth Adj:	1.00	1.00	1.00	1.00	1.00	1.00	1.00	1.00	1.00	1.00	1.00	1.00
Initial Bse:	282	750	23	7	1647	163	124	3	272	29	8	8
Added Vol:	0	0	0	0	0	0	0	0	0	0	0	0
PasserByVol:	0	0	0	0	0	0	0	0	0	0	0	0
Initial Fut:	282	750	23	7	1647	163	124	3	272	29	8	8
User Adj:	1.00	1.00	1.00	1.00	1.00	1.00	1.00	1.00	0.00	1.00	1.00	1.00
PHF Adj:	1.00	1.00	1.00	1.00	1.00	1.00	1.00	1.00	0.00	1.00	1.00	1.00
PHF Volume:	282	750	23	7	1647	163	124	3	0	29	8	8
Reduct Vol:	0	0	0	0	0	0	0	0	0	0	0	0
Reduced Vol:	282	750	23	7	1647	163	124	3	0	29	8	8
PCE Adj:	1.00	1.00	1.00	1.00	1.00	1.00	1.00	1.00	0.00	1.00	1.00	1.00
MLF Adj:	1.00	1.00	1.00	1.00	1.00	1.00	1.00	1.00	0.00	1.00	1.00	1.00
FinalVolume:	282	750	23	7	1647	163	124	3	0	29	8	8

Saturation Flow Module:												
Sat/Lane:	1900	1900	1900	1900	1900	1900	1900	1900	1900	1900	1900	1900
Adjustment:	0.92	1.00	0.92	0.92	1.00	0.92	0.92	0.95	0.92	0.95	0.95	0.95
Lanes:	1.00	2.00	1.00	1.00	2.00	1.00	1.00	1.00	1.00	1.00	0.50	0.50
Final Sat.:	1750	3800	1750	1750	3800	1750	1750	1800	1750	1800	900	900

Capacity Analysis Module:												
Vol/Sat:	0.16	0.20	0.01	0.00	0.43	0.09	0.07	0.00	0.00	0.02	0.01	0.01
Crit Moves:	****				****		****					
Green Time:	20.6	55.3	55.3	20.7	55.4	55.4	10.0	10.0	0.0	10.0	10.0	10.0
Volume/Cap:	0.74	0.34	0.02	0.02	0.74	0.16	0.67	0.02	0.00	0.15	0.08	0.08
Delay/Veh:	42.5	10.4	8.4	29.2	16.0	9.2	50.3	38.1	0.0	38.9	38.4	38.4
User DelAdj:	1.00	1.00	1.00	1.00	1.00	1.00	1.00	1.00	1.00	1.00	1.00	1.00
AdjDel/Veh:	42.5	10.4	8.4	29.2	16.0	9.2	50.3	38.1	0.0	38.9	38.4	38.4
LOS by Move:	D	B	A	C	B	A	D	D	A	D	D	D
HCM2k95thQ:	15	10	1	0	32	5	10	0	0	2	1	1

Note: Queue reported is the number of cars per lane.

BART Phase II Extension Project

Level Of Service Computation Report
 2000 HCM Operations (Future Volume Alternative)
 AM - 2025 SC West Project Conditions

Intersection #3411: AVIATION/COLEMAN

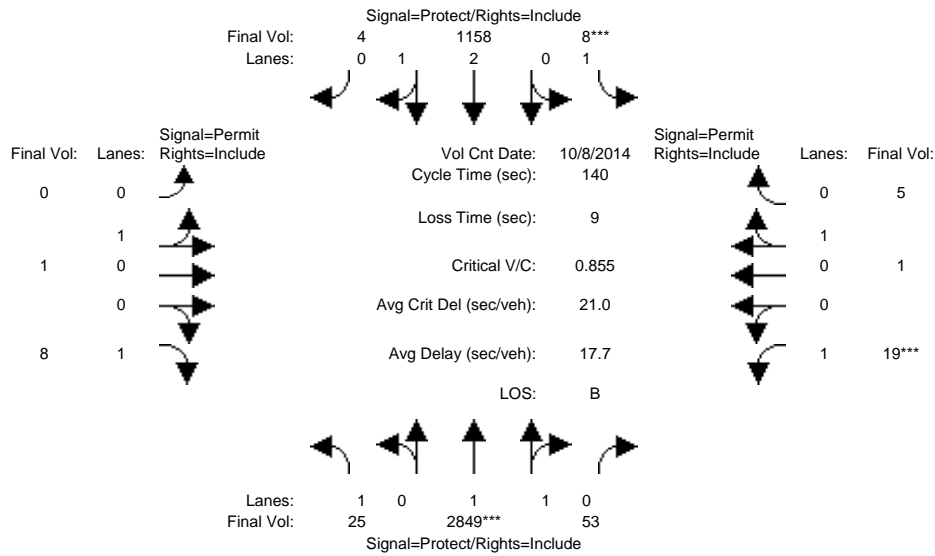

Approach:	North Bound			South Bound			East Bound			West Bound		
	L	T	R	L	T	R	L	T	R	L	T	R
Min. Green:	7	10	10	7	10	10	10	10	10	10	10	10
Y+R:	4.0	4.0	4.0	4.0	4.0	4.0	4.0	4.0	4.0	4.0	4.0	4.0
Volume Module: >> Count Date: 8 Oct 2014 <<												
Base Vol:	25	2849	53	8	1158	4	0	1	8	19	1	5
Growth Adj:	1.00	1.00	1.00	1.00	1.00	1.00	1.00	1.00	1.00	1.00	1.00	1.00
Initial Bse:	25	2849	53	8	1158	4	0	1	8	19	1	5
Added Vol:	0	0	0	0	0	0	0	0	0	0	0	0
PasserByVol:	0	0	0	0	0	0	0	0	0	0	0	0
Initial Fut:	25	2849	53	8	1158	4	0	1	8	19	1	5
User Adj:	1.00	1.00	1.00	1.00	1.00	1.00	1.00	1.00	1.00	1.00	1.00	1.00
PHF Adj:	1.00	1.00	1.00	1.00	1.00	1.00	1.00	1.00	1.00	1.00	1.00	1.00
PHF Volume:	25	2849	53	8	1158	4	0	1	8	19	1	5
Reduct Vol:	0	0	0	0	0	0	0	0	0	0	0	0
Reduced Vol:	25	2849	53	8	1158	4	0	1	8	19	1	5
PCE Adj:	1.00	1.00	1.00	1.00	1.00	1.00	1.00	1.00	1.00	1.00	1.00	1.00
MLF Adj:	1.00	1.00	1.00	1.00	1.00	1.00	1.00	1.00	1.00	1.00	1.00	1.00
FinalVolume:	25	2849	53	8	1158	4	0	1	8	19	1	5
Saturation Flow Module:												
Sat/Lane:	1900	1900	1900	1900	1900	1900	1900	1900	1900	1900	1900	1900
Adjustment:	0.92	0.97	0.95	0.92	0.98	0.95	0.95	0.95	0.92	0.92	0.95	0.95
Lanes:	1.00	1.96	0.04	1.00	2.99	0.01	0.00	1.00	1.00	1.00	0.17	0.83
Final Sat.:	1750	3632	68	1750	5581	19	0	1800	1750	1750	300	1500
Capacity Analysis Module:												
Vol/Sat:	0.01	0.78	0.78	0.00	0.21	0.21	0.00	0.00	0.00	0.01	0.00	0.00
Crit Moves:	****			****						****		
Green Time:	23.5	114	114.0	7.0	97.5	97.5	0.0	10.0	10.0	10.0	10.0	10.0
Volume/Cap:	0.09	0.96	0.96	0.09	0.30	0.30	0.00	0.01	0.06	0.15	0.05	0.05
Delay/Veh:	49.3	20.6	20.6	63.9	8.2	8.2	0.0	60.4	60.9	61.6	60.7	60.7
User DelAdj:	1.00	1.00	1.00	1.00	1.00	1.00	1.00	1.00	1.00	1.00	1.00	1.00
AdjDel/Veh:	49.3	20.6	20.6	63.9	8.2	8.2	0.0	60.4	60.9	61.6	60.7	60.7
LOS by Move:	D	C	C	E	A	A	A	E	E	E	E	E
HCM2k95thQ:	2	90	90	1	12	12	0	0	1	2	1	1

Note: Queue reported is the number of cars per lane.

BART Phase II Extension Project

Level Of Service Computation Report
 2000 HCM Operations (Future Volume Alternative)
 PM - 2025 SC West Project Conditions

Intersection #3411: AVIATION/COLEMAN

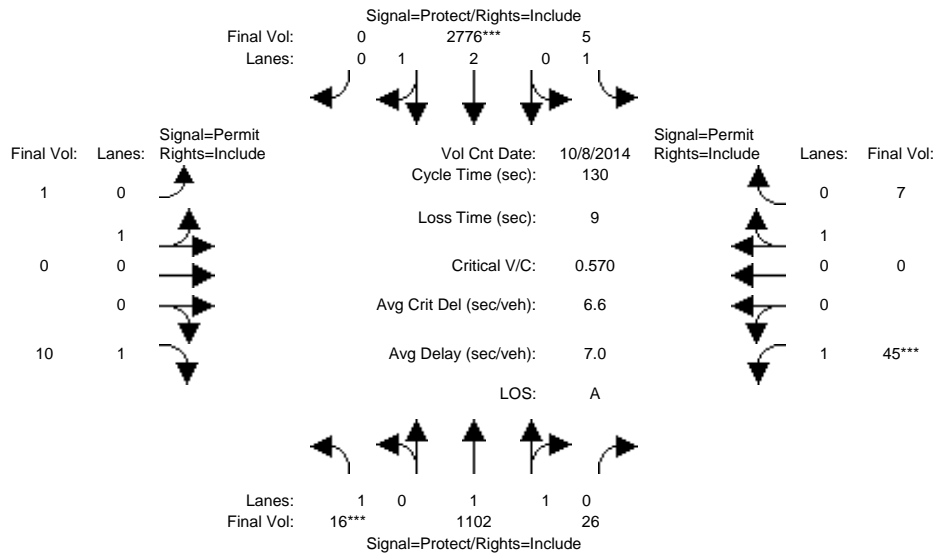

Approach:	North Bound			South Bound			East Bound			West Bound		
	L	T	R	L	T	R	L	T	R	L	T	R
Min. Green:	7	10	10	7	10	10	10	10	10	10	10	10
Y+R:	4.0	4.0	4.0	4.0	4.0	4.0	4.0	4.0	4.0	4.0	4.0	4.0

Volume Module:	>>	Count	Date:	8 Oct 2014	<<											
Base Vol:	16	1102	26	5	2776	0	1	0	10	45	0	7				
Growth Adj:	1.00	1.00	1.00	1.00	1.00	1.00	1.00	1.00	1.00	1.00	1.00	1.00				
Initial Bse:	16	1102	26	5	2776	0	1	0	10	45	0	7				
Added Vol:	0	0	0	0	0	0	0	0	0	0	0	0				
PasserByVol:	0	0	0	0	0	0	0	0	0	0	0	0				
Initial Fut:	16	1102	26	5	2776	0	1	0	10	45	0	7				
User Adj:	1.00	1.00	1.00	1.00	1.00	1.00	1.00	1.00	1.00	1.00	1.00	1.00				
PHF Adj:	1.00	1.00	1.00	1.00	1.00	1.00	1.00	1.00	1.00	1.00	1.00	1.00				
PHF Volume:	16	1102	26	5	2776	0	1	0	10	45	0	7				
Reduct Vol:	0	0	0	0	0	0	0	0	0	0	0	0				
Reduced Vol:	16	1102	26	5	2776	0	1	0	10	45	0	7				
PCE Adj:	1.00	1.00	1.00	1.00	1.00	1.00	1.00	1.00	1.00	1.00	1.00	1.00				
MLF Adj:	1.00	1.00	1.00	1.00	1.00	1.00	1.00	1.00	1.00	1.00	1.00	1.00				
FinalVolume:	16	1102	26	5	2776	0	1	0	10	45	0	7				

Saturation Flow Module:												
Sat/Lane:	1900	1900	1900	1900	1900	1900	1900	1900	1900	1900	1900	1900
Adjustment:	0.92	0.97	0.95	0.92	0.98	0.92	0.95	0.95	0.92	0.92	1.00	0.95
Lanes:	1.00	1.95	0.05	1.00	3.00	0.00	1.00	0.00	1.00	1.00	0.00	1.00
Final Sat.:	1750	3615	85	1750	5600	0	1800	0	1750	1750	0	1800

Capacity Analysis Module:												
Vol/Sat:	0.01	0.30	0.30	0.00	0.50	0.00	0.00	0.00	0.01	0.03	0.00	0.00
Crit Moves:	****				****					****		
Green Time:	7.0	94.3	94.3	16.7	104	0.0	10.0	0.0	10.0	10.0	0.0	10.0
Volume/Cap:	0.17	0.42	0.42	0.02	0.62	0.00	0.01	0.00	0.07	0.33	0.00	0.05
Delay/Veh:	59.6	7.1	7.1	49.6	5.4	0.0	55.4	0.0	55.9	58.3	0.0	55.8
User DelAdj:	1.00	1.00	1.00	1.00	1.00	1.00	1.00	1.00	1.00	1.00	1.00	1.00
AdjDel/Veh:	59.6	7.1	7.1	49.6	5.4	0.0	55.4	0.0	55.9	58.3	0.0	55.8
LOS by Move:	E	A	A	D	A	A	E	A	E	E	A	E
HCM2k95thQ:	1	17	17	0	25	0	0	0	1	4	0	1

Note: Queue reported is the number of cars per lane.

BART Phase II Extension Project

Level Of Service Computation Report
 2000 HCM Operations (Future Volume Alternative)
 AM - 2025 SC West Project Conditions

Intersection #4047: COLEMAN/NEWHALL

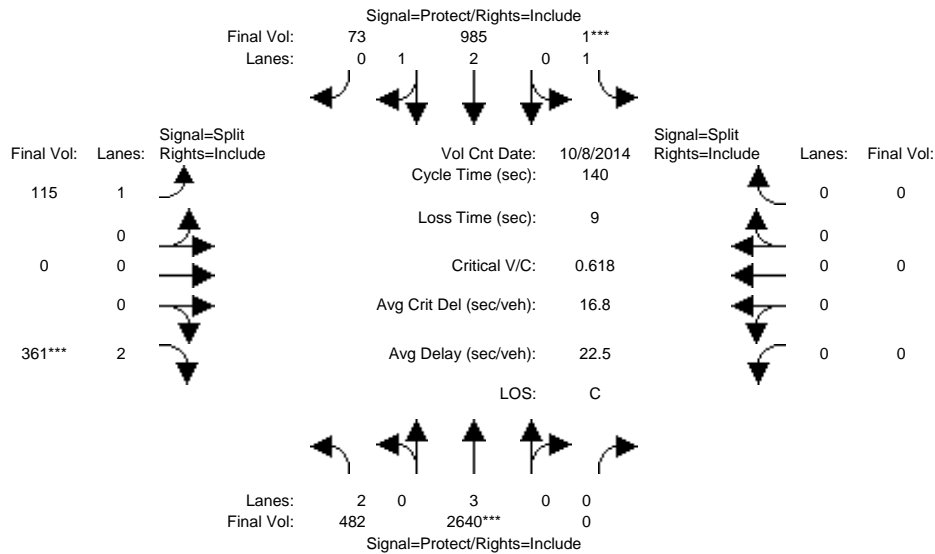

Approach:	North Bound			South Bound			East Bound			West Bound		
	L	T	R	L	T	R	L	T	R	L	T	R
Min. Green:	7	10	0	7	10	10	10	0	10	0	0	0
Y+R:	4.0	4.0	4.0	4.0	4.0	4.0	4.0	4.0	4.0	4.0	4.0	4.0
Volume Module: >> Count Date: 8 Oct 2014 <<												
Base Vol:	482	2640	0	1	985	73	115	0	361	0	0	0
Growth Adj:	1.00	1.00	1.00	1.00	1.00	1.00	1.00	1.00	1.00	1.00	1.00	1.00
Initial Bse:	482	2640	0	1	985	73	115	0	361	0	0	0
Added Vol:	0	0	0	0	0	0	0	0	0	0	0	0
PasserByVol:	0	0	0	0	0	0	0	0	0	0	0	0
Initial Fut:	482	2640	0	1	985	73	115	0	361	0	0	0
User Adj:	1.00	1.00	1.00	1.00	1.00	1.00	1.00	1.00	1.00	1.00	1.00	1.00
PHF Adj:	1.00	1.00	1.00	1.00	1.00	1.00	1.00	1.00	1.00	1.00	1.00	1.00
PHF Volume:	482	2640	0	1	985	73	115	0	361	0	0	0
Reduct Vol:	0	0	0	0	0	0	0	0	0	0	0	0
Reduced Vol:	482	2640	0	1	985	73	115	0	361	0	0	0
PCE Adj:	1.00	1.00	1.00	1.00	1.00	1.00	1.00	1.00	1.00	1.00	1.00	1.00
MLF Adj:	1.00	1.00	1.00	1.00	1.00	1.00	1.00	1.00	1.00	1.00	1.00	1.00
Final Volume:	482	2640	0	1	985	73	115	0	361	0	0	0
Saturation Flow Module:												
Sat/Lane:	1900	1900	1900	1900	1900	1900	1900	1900	1900	1900	1900	1900
Adjustment:	0.83	1.00	0.92	0.92	0.99	0.95	0.92	1.00	0.83	0.92	1.00	0.92
Lanes:	2.00	3.00	0.00	1.00	2.79	0.21	1.00	0.00	2.00	0.00	0.00	0.00
Final Sat.:	3150	5700	0	1750	5213	386	1750	0	3150	0	0	0
Capacity Analysis Module:												
Vol/Sat:	0.15	0.46	0.00	0.00	0.19	0.19	0.07	0.00	0.11	0.00	0.00	0.00
Crit Moves:	****			****			****			****		
Green Time:	47.6	99.4	0.0	7.0	58.8	58.8	24.6	0.0	24.6	0.0	0.0	0.0
Volume/Cap:	0.45	0.65	0.00	0.01	0.45	0.45	0.37	0.00	0.65	0.00	0.00	0.00
Delay/Veh:	36.3	11.3	0.0	63.3	29.2	29.2	51.7	0.0	56.5	0.0	0.0	0.0
User DelAdj:	1.00	1.00	1.00	1.00	1.00	1.00	1.00	1.00	1.00	1.00	1.00	1.00
AdjDel/Veh:	36.3	11.3	0.0	63.3	29.2	29.2	51.7	0.0	56.5	0.0	0.0	0.0
LOS by Move:	D	B	A	E	C	C	D	A	E	A	A	A
HCM2k95thQ:	18	34	0	0	19	19	10	0	18	0	0	0

Note: Queue reported is the number of cars per lane.

BART Phase II Extension Project

Level Of Service Computation Report
 2000 HCM Operations (Future Volume Alternative)
 PM - 2025 SC West Project Conditions

Intersection #4047: COLEMAN/NEWHALL

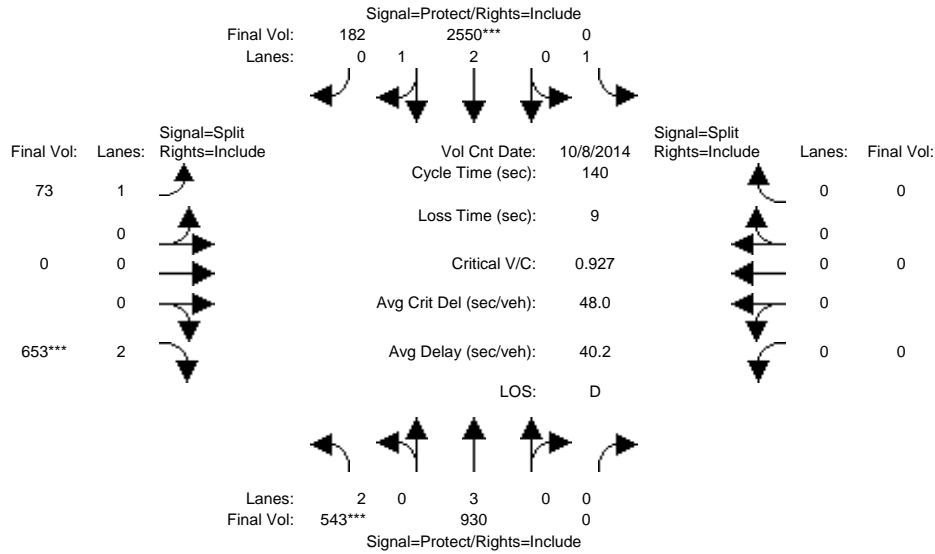

Approach:	North Bound			South Bound			East Bound			West Bound		
Movement:	L	T	R	L	T	R	L	T	R	L	T	R
Min. Green:	7	10	0	7	10	10	10	0	10	0	0	0
Y+R:	4.0	4.0	4.0	4.0	4.0	4.0	4.0	4.0	4.0	4.0	4.0	4.0
Volume Module: >> Count Date: 8 Oct 2014 <<												
Base Vol:	543	930	0	0	2550	182	73	0	653	0	0	0
Growth Adj:	1.00	1.00	1.00	1.00	1.00	1.00	1.00	1.00	1.00	1.00	1.00	1.00
Initial Bse:	543	930	0	0	2550	182	73	0	653	0	0	0
Added Vol:	0	0	0	0	0	0	0	0	0	0	0	0
PasserByVol:	0	0	0	0	0	0	0	0	0	0	0	0
Initial Fut:	543	930	0	0	2550	182	73	0	653	0	0	0
User Adj:	1.00	1.00	1.00	1.00	1.00	1.00	1.00	1.00	1.00	1.00	1.00	1.00
PHF Adj:	1.00	1.00	1.00	1.00	1.00	1.00	1.00	1.00	1.00	1.00	1.00	1.00
PHF Volume:	543	930	0	0	2550	182	73	0	653	0	0	0
Reduct Vol:	0	0	0	0	0	0	0	0	0	0	0	0
Reduced Vol:	543	930	0	0	2550	182	73	0	653	0	0	0
PCE Adj:	1.00	1.00	1.00	1.00	1.00	1.00	1.00	1.00	1.00	1.00	1.00	1.00
MLF Adj:	1.00	1.00	1.00	1.00	1.00	1.00	1.00	1.00	1.00	1.00	1.00	1.00
FinalVolume:	543	930	0	0	2550	182	73	0	653	0	0	0
Saturation Flow Module:												
Sat/Lane:	1900	1900	1900	1900	1900	1900	1900	1900	1900	1900	1900	1900
Adjustment:	0.83	1.00	0.92	0.92	0.98	0.95	0.92	1.00	0.83	0.92	1.00	0.92
Lanes:	2.00	3.00	0.00	1.00	2.79	0.21	1.00	0.00	2.00	0.00	0.00	0.00
Final Sat.:	3150	5700	0	1750	5226	373	1750	0	3150	0	0	0
Capacity Analysis Module:												
Vol/Sat:	0.17	0.16	0.00	0.00	0.49	0.49	0.04	0.00	0.21	0.00	0.00	0.00
Crit Moves:	****			****			****					
Green Time:	26.0	99.7	0.0	0.0	73.7	73.7	31.3	0.0	31.3	0.0	0.0	0.0
Volume/Cap:	0.93	0.23	0.00	0.00	0.93	0.93	0.19	0.00	0.93	0.00	0.00	0.00
Delay/Veh:	77.1	7.0	0.0	0.0	36.5	36.5	44.3	0.0	71.6	0.0	0.0	0.0
User DelAdj:	1.00	1.00	1.00	1.00	1.00	1.00	1.00	1.00	1.00	1.00	1.00	1.00
AdjDel/Veh:	77.1	7.0	0.0	0.0	36.5	36.5	44.3	0.0	71.6	0.0	0.0	0.0
LOS by Move:	E	A	A	A	D	D	D	A	E	A	A	A
HCM2k95thQ:	30	9	0	0	61	61	5	0	34	0	0	0

Note: Queue reported is the number of cars per lane.

BART Phase II Extension Project

Level Of Service Computation Report
 2000 HCM Operations (Future Volume Alternative)
 AM - 2025 SC West Project Conditions

Intersection #5335: CENTRAL EXPWY/DE LA CRUZ BLVD

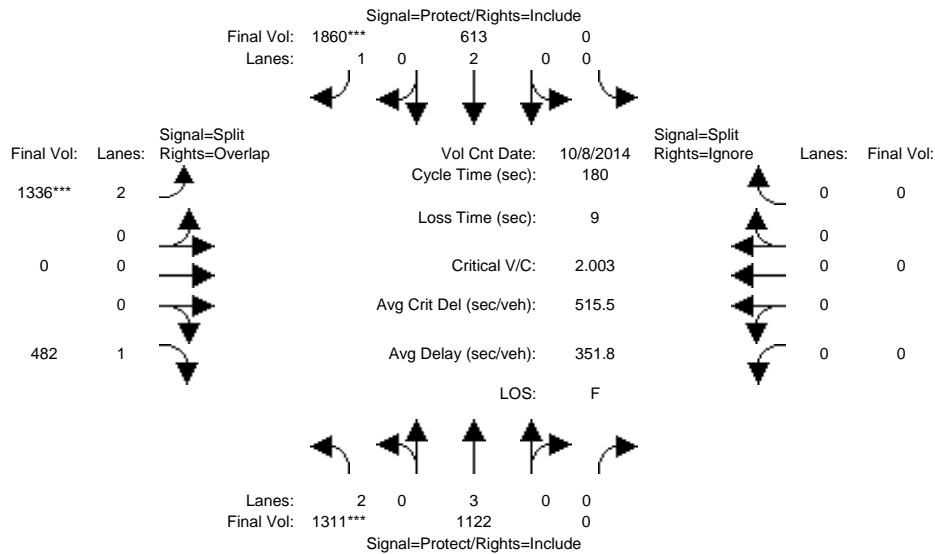

Approach:	North Bound			South Bound			East Bound			West Bound		
Movement:	L	T	R	L	T	R	L	T	R	L	T	R
Min. Green:	7	10	0	0	10	10	10	0	10	0	0	0
Y+R:	4.0	4.0	4.0	4.0	4.0	4.0	4.0	4.0	4.0	4.0	4.0	4.0
Volume Module: >> Count Date: 8 Oct 2014 <<												
Base Vol:	1311	1122	0	0	613	1860	1536	0	482	0	0	0
Growth Adj:	1.00	1.00	1.00	1.00	1.00	1.00	1.00	1.00	1.00	1.00	1.00	1.00
Initial Bse:	1311	1122	0	0	613	1860	1536	0	482	0	0	0
Added Vol:	0	0	0	0	0	0	0	0	0	0	0	0
PasserByVol:	0	0	0	0	0	0	0	0	0	0	0	0
Initial Fut:	1311	1122	0	0	613	1860	1536	0	482	0	0	0
User Adj:	1.00	1.00	1.00	1.00	1.00	1.00	0.87	1.00	1.00	1.00	1.00	0.00
PHF Adj:	1.00	1.00	1.00	1.00	1.00	1.00	1.00	1.00	1.00	1.00	1.00	0.00
PHF Volume:	1311	1122	0	0	613	1860	1336	0	482	0	0	0
Reduct Vol:	0	0	0	0	0	0	0	0	0	0	0	0
Reduced Vol:	1311	1122	0	0	613	1860	1336	0	482	0	0	0
PCE Adj:	1.00	1.00	1.00	1.00	1.00	1.00	1.00	1.00	1.00	1.00	1.00	0.00
MLF Adj:	1.00	1.00	1.00	1.00	1.00	1.00	1.00	1.00	1.00	1.00	1.00	0.00
FinalVolume:	1311	1122	0	0	613	1860	1336	0	482	0	0	0
Saturation Flow Module:												
Sat/Lane:	1900	1900	1900	1900	1900	1900	1900	1900	1900	1900	1900	1900
Adjustment:	0.83	1.00	0.92	0.92	1.00	0.92	0.83	1.00	0.92	0.92	1.00	0.92
Lanes:	2.00	3.00	0.00	0.00	2.00	1.00	2.00	0.00	1.00	0.00	0.00	0.00
Final Sat.:	3150	5700	0	0	3800	1750	3150	0	1750	0	0	0
Capacity Analysis Module:												
Vol/Sat:	0.42	0.20	0.00	0.00	0.16	1.06	0.42	0.00	0.28	0.00	0.00	0.00
Crit Moves:	****					****	****					
Green Time:	37.4	133	0.0	0.0	95.5	95.5	38.1	0.0	75.5	0.0	0.0	0.0
Volume/Cap:	2.00	0.27	0.00	0.00	0.30	2.00	2.00	0.00	0.66	0.00	0.00	0.00
Delay/Veh:	528.3	7.7	0.0	0.0	23.7	497.6	527.8	0.0	38.7	0.0	0.0	0.0
User DelAdj:	1.00	1.00	1.00	1.00	1.00	1.00	1.00	1.00	1.00	1.00	1.00	1.00
AdjDel/Veh:	528.3	7.7	0.0	0.0	23.7	497.6	527.8	0.0	38.7	0.0	0.0	0.0
LOS by Move:	F	A	A	A	C	F	F	A	D	A	A	A
HCM2k95thQ:	136	13	0	0	17	344	138	0	34	0	0	0

Note: Queue reported is the number of cars per lane.

BART Phase II Extension Project

Level Of Service Computation Report
 2000 HCM Operations (Future Volume Alternative)
 PM - 2025 SC West Project Conditions

Intersection #5335: CENTRAL EXPWY/DE LA CRUZ BLVD

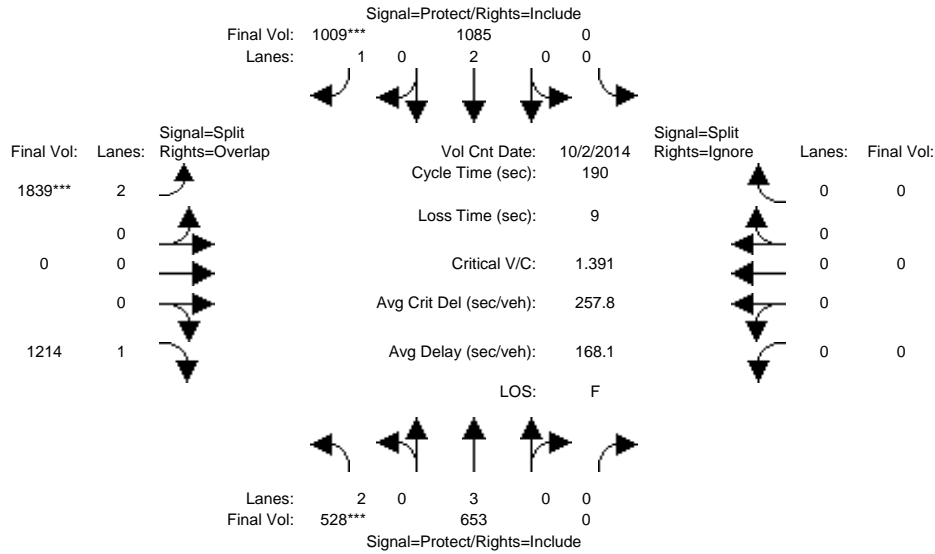

Approach:	North Bound			South Bound			East Bound			West Bound		
	L	T	R	L	T	R	L	T	R	L	T	R
Min. Green:	19	76	0	0	57	57	114	0	114	0	0	0
Y+R:	4.0	4.0	4.0	4.0	4.0	4.0	4.0	4.0	4.0	4.0	4.0	4.0
Volume Module: >> Count Date: 2 Oct 2014 <<												
Base Vol:	528	653	0	0	1085	1009	2485	0	1214	0	0	0
Growth Adj:	1.00	1.00	1.00	1.00	1.00	1.00	1.00	1.00	1.00	1.00	1.00	1.00
Initial Bse:	528	653	0	0	1085	1009	2485	0	1214	0	0	0
Added Vol:	0	0	0	0	0	0	0	0	0	0	0	0
PasserByVol:	0	0	0	0	0	0	0	0	0	0	0	0
Initial Fut:	528	653	0	0	1085	1009	2485	0	1214	0	0	0
User Adj:	1.00	1.00	1.00	1.00	1.00	1.00	0.74	1.00	1.00	1.00	1.00	0.00
PHF Adj:	1.00	1.00	1.00	1.00	1.00	1.00	1.00	1.00	1.00	1.00	1.00	0.00
PHF Volume:	528	653	0	0	1085	1009	1839	0	1214	0	0	0
Reduct Vol:	0	0	0	0	0	0	0	0	0	0	0	0
Reduced Vol:	528	653	0	0	1085	1009	1839	0	1214	0	0	0
PCE Adj:	1.00	1.00	1.00	1.00	1.00	1.00	1.00	1.00	1.00	1.00	1.00	0.00
MLF Adj:	1.00	1.00	1.00	1.00	1.00	1.00	1.00	1.00	1.00	1.00	1.00	0.00
Final Volume:	528	653	0	0	1085	1009	1839	0	1214	0	0	0
Saturation Flow Module:												
Sat/Lane:	1900	1900	1900	1900	1900	1900	1900	1900	1900	1900	1900	1900
Adjustment:	0.83	1.00	0.92	0.92	1.00	0.92	0.83	1.00	0.92	0.92	1.00	0.92
Lanes:	2.00	3.00	0.00	0.00	2.00	1.00	2.00	0.00	1.00	0.00	0.00	0.00
Final Sat.:	3150	5700	0	0	3800	1750	3150	0	1750	0	0	0
Capacity Analysis Module:												
Vol/Sat:	0.17	0.11	0.00	0.00	0.29	0.58	0.58	0.00	0.69	0.00	0.00	0.00
Crit Moves:	****				****	****	****					
Green Time:	18.1	72.6	0.0	0.0	54.4	54.4	108.8	0.0	127.0	0.0	0.0	0.0
Volume/Cap:	1.76	0.30	0.00	0.00	1.00	2.01	1.02	0.00	1.04	0.00	0.00	0.00
Delay/Veh:	443.4	43.0	0.0	0.0	97.4	533.9	53.1	0.0	49.1	0.0	0.0	0.0
User DelAdj:	1.00	1.00	1.00	1.00	1.00	1.00	1.00	1.00	1.00	1.00	1.00	1.00
AdjDel/Veh:	443.4	43.0	0.0	0.0	97.4	533.9	53.1	0.0	49.1	0.0	0.0	0.0
LOS by Move:	F	D	A	A	F	F	D	A	D	A	A	A
HCM2k95thQ:	56	16	0	0	58	196	113	0	136	0	0	0

Note: Queue reported is the number of cars per lane.

BART Phase II Extension Project

Level Of Service Computation Report
2000 HCM Operations (Future Volume Alternative)
AM - 2025 SC West Project Conditions

Intersection #5416: SAN TOMAS EXPWY/EL CAMINO REAL

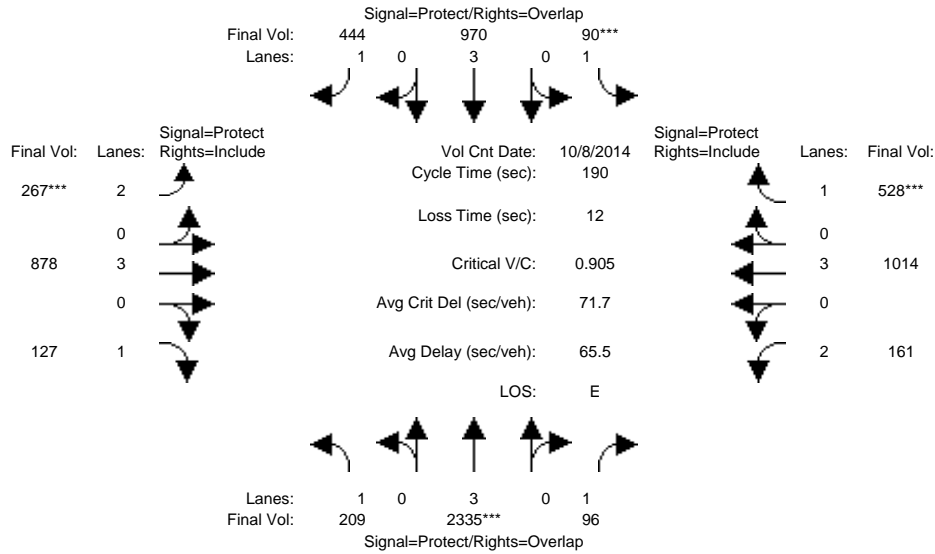

Approach:	North Bound			South Bound			East Bound			West Bound		
	L	T	R	L	T	R	L	T	R	L	T	R
Min. Green:	7	10	10	7	10	10	7	10	10	7	10	10
Y+R:	4.0	4.0	4.0	4.0	4.0	4.0	4.0	4.0	4.0	4.0	4.0	4.0
Volume Module: >> Count Date: 8 Oct 2014 <<												
Base Vol:	209	2780	96	90	1155	444	267	878	127	161	1014	528
Growth Adj:	1.00	1.00	1.00	1.00	1.00	1.00	1.00	1.00	1.00	1.00	1.00	1.00
Initial Bse:	209	2780	96	90	1155	444	267	878	127	161	1014	528
Added Vol:	0	0	0	0	0	0	0	0	0	0	0	0
PasserByVol:	0	0	0	0	0	0	0	0	0	0	0	0
Initial Fut:	209	2780	96	90	1155	444	267	878	127	161	1014	528
User Adj:	1.00	0.84	1.00	1.00	0.84	1.00	1.00	1.00	1.00	1.00	1.00	1.00
PHF Adj:	1.00	1.00	1.00	1.00	1.00	1.00	1.00	1.00	1.00	1.00	1.00	1.00
PHF Volume:	209	2335	96	90	970	444	267	878	127	161	1014	528
Reduct Vol:	0	0	0	0	0	0	0	0	0	0	0	0
Reduced Vol:	209	2335	96	90	970	444	267	878	127	161	1014	528
PCE Adj:	1.00	1.00	1.00	1.00	1.00	1.00	1.00	1.00	1.00	1.00	1.00	1.00
MLF Adj:	1.00	1.00	1.00	1.00	1.00	1.00	1.00	1.00	1.00	1.00	1.00	1.00
FinalVolume:	209	2335	96	90	970	444	267	878	127	161	1014	528
Saturation Flow Module:												
Sat/Lane:	1900	1900	1900	1900	1900	1900	1900	1900	1900	1900	1900	1900
Adjustment:	0.92	1.00	0.92	0.92	1.00	0.92	0.83	1.00	0.92	0.83	1.00	0.92
Lanes:	1.00	3.00	1.00	1.00	3.00	1.00	2.00	3.00	1.00	2.00	3.00	1.00
Final Sat.:	1750	5700	1750	1750	5700	1750	3150	5700	1750	3150	5700	1750
Capacity Analysis Module:												
Vol/Sat:	0.12	0.41	0.05	0.05	0.17	0.25	0.08	0.15	0.07	0.05	0.18	0.30
Crit Moves:	****			****			****			****		
Green Time:	39.9	86.0	106.3	10.8	56.9	74.7	17.8	60.9	60.9	20.2	63.4	63.4
Volume/Cap:	0.57	0.90	0.10	0.90	0.57	0.65	0.90	0.48	0.23	0.48	0.53	0.90
Delay/Veh:	70.2	62.2	25.9	153.1	72.6	69.2	114.5	52.0	47.5	81.0	51.6	78.0
User DelAdj:	1.00	1.00	1.00	1.00	1.00	1.00	1.00	1.00	1.00	1.00	1.00	1.00
AdjDel/Veh:	70.2	62.2	25.9	153.1	72.6	69.2	114.5	52.0	47.5	81.0	51.6	78.0
LOS by Move:	E	E	C	F	E	E	F	D	D	F	D	E
HCM2k95thQ:	22	70	7	12	30	42	22	24	11	10	27	54

Note: Queue reported is the number of cars per lane.

BART Phase II Extension Project

Level Of Service Computation Report
 2000 HCM Operations (Future Volume Alternative)
 PM - 2025 SC West Project Conditions

Intersection #5416: SAN TOMAS EXPWY/EL CAMINO REAL

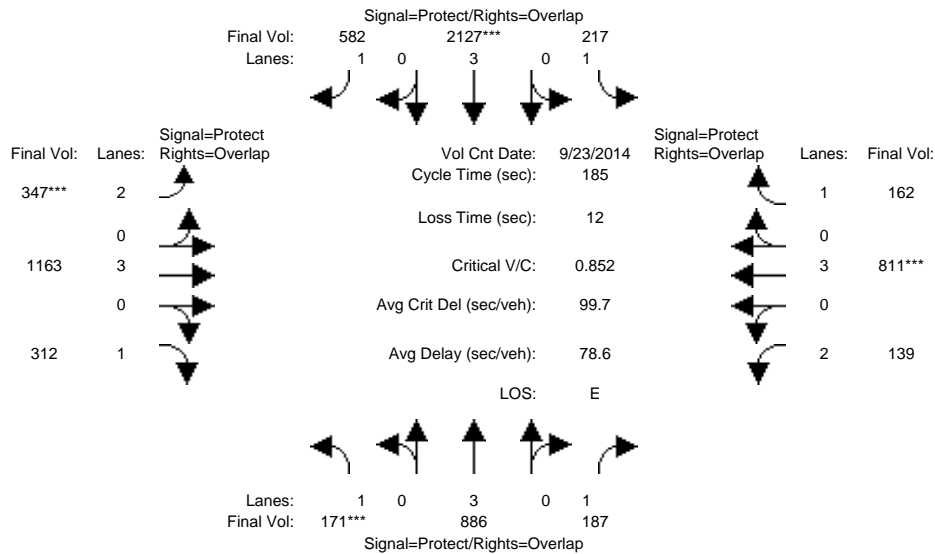

Approach:	North Bound			South Bound			East Bound			West Bound		
Movement:	L	T	R	L	T	R	L	T	R	L	T	R
Min. Green:	12	72	72	33	93	93	39	50	50	29	41	41
Y+R:	4.0	4.0	4.0	4.0	4.0	4.0	4.0	4.0	4.0	4.0	4.0	4.0
Volume Module: >> Count Date: 23 Sep 2014 <<												
Base Vol:	171	1166	187	217	2762	582	347	1163	312	139	811	162
Growth Adj:	1.00	1.00	1.00	1.00	1.00	1.00	1.00	1.00	1.00	1.00	1.00	1.00
Initial Bse:	171	1166	187	217	2762	582	347	1163	312	139	811	162
Added Vol:	0	0	0	0	0	0	0	0	0	0	0	0
PasserByVol:	0	0	0	0	0	0	0	0	0	0	0	0
Initial Fut:	171	1166	187	217	2762	582	347	1163	312	139	811	162
User Adj:	1.00	0.76	1.00	1.00	0.77	1.00	1.00	1.00	1.00	1.00	1.00	1.00
PHF Adj:	1.00	1.00	1.00	1.00	1.00	1.00	1.00	1.00	1.00	1.00	1.00	1.00
PHF Volume:	171	886	187	217	2127	582	347	1163	312	139	811	162
Reduct Vol:	0	0	0	0	0	0	0	0	0	0	0	0
Reduced Vol:	171	886	187	217	2127	582	347	1163	312	139	811	162
PCE Adj:	1.00	1.00	1.00	1.00	1.00	1.00	1.00	1.00	1.00	1.00	1.00	1.00
MLF Adj:	1.00	1.00	1.00	1.00	1.00	1.00	1.00	1.00	1.00	1.00	1.00	1.00
FinalVolume:	171	886	187	217	2127	582	347	1163	312	139	811	162
Saturation Flow Module:												
Sat/Lane:	1900	1900	1900	1900	1900	1900	1900	1900	1900	1900	1900	1900
Adjustment:	0.92	1.00	0.92	0.92	0.83	0.92	0.83	1.00	0.92	0.83	1.00	0.92
Lanes:	1.00	3.00	1.00	1.00	3.00	1.00	2.00	3.00	1.00	2.00	3.00	1.00
Final Sat.:	1750	5700	1750	1750	4731	1750	3150	5700	1750	3150	5700	1750
Capacity Analysis Module:												
Vol/Sat:	0.10	0.16	0.11	0.12	0.45	0.33	0.11	0.20	0.18	0.04	0.14	0.09
Crit Moves:	****				****		****				****	
Green Time:	11.3	67.6	95.2	31.0	87.3	124.0	36.6	47.5	58.8	27.6	38.5	69.5
Volume/Cap:	1.60	0.43	0.21	0.74	0.95	0.50	0.56	0.79	0.56	0.30	0.68	0.25
Delay/Veh:	403.6	52.2	32.8	98.0	89.7	38.2	72.3	71.4	57.1	75.0	73.7	42.5
User DelAdj:	1.00	1.00	1.00	1.00	1.00	1.00	1.00	1.00	1.00	1.00	1.00	1.00
AdjDel/Veh:	403.6	52.2	32.8	98.0	89.7	38.2	72.3	71.4	57.1	75.0	73.7	42.5
LOS by Move:	F	D	C	F	F	D	E	E	E	E	E	D
HCM2k95thQ:	33	25	15	25	70	50	21	38	29	8	26	13

Note: Queue reported is the number of cars per lane.

BART Phase II Extension Project

Level Of Service Computation Report
 2000 HCM Operations (Future Volume Alternative)
 AM - 2025 SC West Project Conditions

Intersection #5444: Lafayette/Lewis

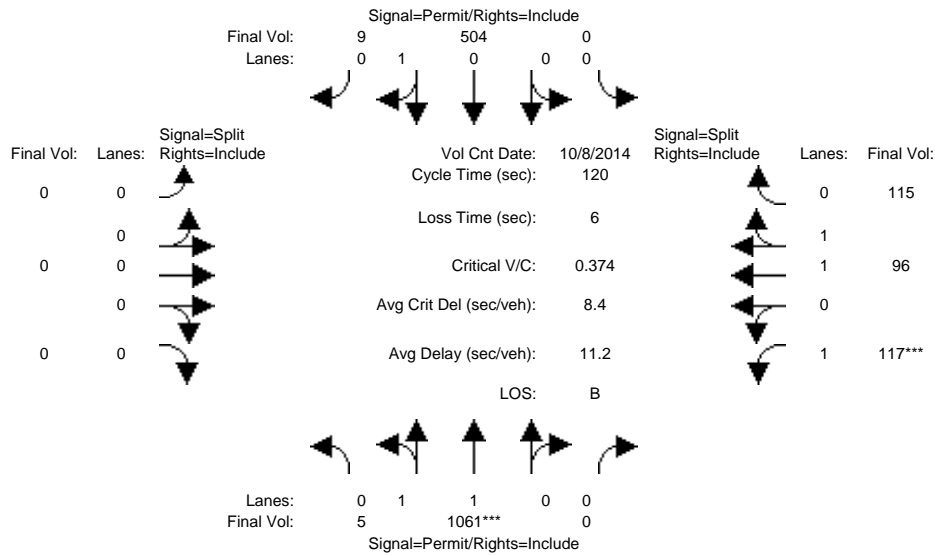

Approach:	North Bound			South Bound			East Bound			West Bound		
	L	T	R	L	T	R	L	T	R	L	T	R
Min. Green:	10	10	0	0	10	10	0	0	0	10	10	10
Y+R:	4.0	4.0	4.0	4.0	4.0	4.0	4.0	4.0	4.0	4.0	4.0	4.0
Volume Module: >> Count Date: 8 Oct 2014 <<												
Base Vol:	5	1061	0	0	504	9	0	0	0	117	96	115
Growth Adj:	1.00	1.00	1.00	1.00	1.00	1.00	1.00	1.00	1.00	1.00	1.00	1.00
Initial Bse:	5	1061	0	0	504	9	0	0	0	117	96	115
Added Vol:	0	0	0	0	0	0	0	0	0	0	0	0
PasserByVol:	0	0	0	0	0	0	0	0	0	0	0	0
Initial Fut:	5	1061	0	0	504	9	0	0	0	117	96	115
User Adj:	1.00	1.00	1.00	1.00	1.00	1.00	1.00	1.00	1.00	1.00	1.00	1.00
PHF Adj:	1.00	1.00	1.00	1.00	1.00	1.00	1.00	1.00	1.00	1.00	1.00	1.00
PHF Volume:	5	1061	0	0	504	9	0	0	0	117	96	115
Reduct Vol:	0	0	0	0	0	0	0	0	0	0	0	0
Reduced Vol:	5	1061	0	0	504	9	0	0	0	117	96	115
PCE Adj:	1.00	1.00	1.00	1.00	1.00	1.00	1.00	1.00	1.00	1.00	1.00	1.00
MLF Adj:	1.00	1.00	1.00	1.00	1.00	1.00	1.00	1.00	1.00	1.00	1.00	1.00
FinalVolume:	5	1061	0	0	504	9	0	0	0	117	96	115
Saturation Flow Module:												
Sat/Lane:	1900	1900	1900	1900	1900	1900	1900	1900	1900	1900	1900	1900
Adjustment:	0.95	0.97	0.92	0.92	0.95	0.95	0.92	1.00	0.92	0.92	1.00	0.92
Lanes:	0.01	1.99	0.00	0.00	0.98	0.02	0.00	0.00	0.00	1.00	1.00	1.00
Final Sat.:	17	3683	0	0	1768	32	0	0	0	1750	1900	1750
Capacity Analysis Module:												
Vol/Sat:	0.29	0.29	0.00	0.00	0.29	0.29	0.00	0.00	0.00	0.07	0.05	0.07
Crit Moves:	****						****					
Green Time:	92.5	92.5	0.0	0.0	92.5	92.5	0.0	0.0	0.0	21.5	21.5	21.5
Volume/Cap:	0.37	0.37	0.00	0.00	0.37	0.37	0.00	0.00	0.00	0.37	0.28	0.37
Delay/Veh:	4.5	4.5	0.0	0.0	4.6	4.6	0.0	0.0	0.0	44.1	42.8	43.7
User DelAdj:	1.00	1.00	1.00	1.00	1.00	1.00	1.00	1.00	1.00	1.00	1.00	1.00
AdjDel/Veh:	4.5	4.5	0.0	0.0	4.6	4.6	0.0	0.0	0.0	44.1	42.8	43.7
LOS by Move:	A	A	A	A	A	A	A	A	A	D	D	D
HCM2k95thQ:	12	12	0	0	12	12	0	0	0	8	6	8

Note: Queue reported is the number of cars per lane.

BART Phase II Extension Project

Level Of Service Computation Report
 2000 HCM Operations (Future Volume Alternative)
 PM - 2025 SC West Project Conditions

Intersection #5444: Lafayette/Lewis

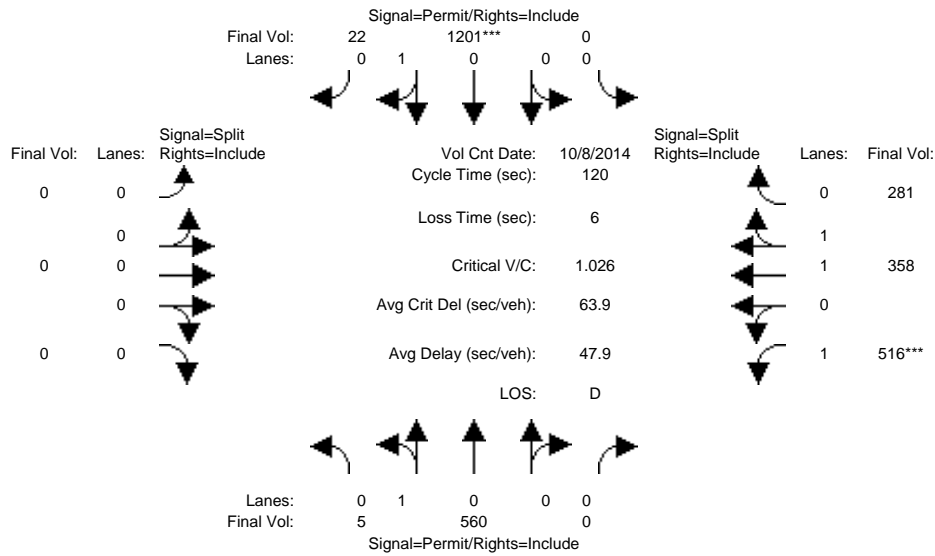

Approach:	North Bound			South Bound			East Bound			West Bound		
Movement:	L	T	R	L	T	R	L	T	R	L	T	R
Min. Green:	10	10	0	0	10	10	0	0	0	10	10	10
Y+R:	4.0	4.0	4.0	4.0	4.0	4.0	4.0	4.0	4.0	4.0	4.0	4.0
Volume Module: >> Count Date: 8 Oct 2014 <<												
Base Vol:	5	560	0	0	1201	22	0	0	0	516	358	281
Growth Adj:	1.00	1.00	1.00	1.00	1.00	1.00	1.00	1.00	1.00	1.00	1.00	1.00
Initial Bse:	5	560	0	0	1201	22	0	0	0	516	358	281
Added Vol:	0	0	0	0	0	0	0	0	0	0	0	0
PasserByVol:	0	0	0	0	0	0	0	0	0	0	0	0
Initial Fut:	5	560	0	0	1201	22	0	0	0	516	358	281
User Adj:	1.00	1.00	1.00	1.00	1.00	1.00	1.00	1.00	1.00	1.00	1.00	1.00
PHF Adj:	1.00	1.00	1.00	1.00	1.00	1.00	1.00	1.00	1.00	1.00	1.00	1.00
PHF Volume:	5	560	0	0	1201	22	0	0	0	516	358	281
Reduct Vol:	0	0	0	0	0	0	0	0	0	0	0	0
Reduced Vol:	5	560	0	0	1201	22	0	0	0	516	358	281
PCE Adj:	1.00	1.00	1.00	1.00	1.00	1.00	1.00	1.00	1.00	1.00	1.00	1.00
MLF Adj:	1.00	1.00	1.00	1.00	1.00	1.00	1.00	1.00	1.00	1.00	1.00	1.00
FinalVolume:	5	560	0	0	1201	22	0	0	0	516	358	281
Saturation Flow Module:												
Sat/Lane:	1900	1900	1900	1900	1900	1900	1900	1900	1900	1900	1900	1900
Adjustment:	0.95	0.95	0.92	0.92	0.95	0.95	0.92	1.00	0.92	0.92	0.99	0.95
Lanes:	0.01	0.99	0.00	0.00	0.98	0.02	0.00	0.00	0.00	1.00	1.10	0.90
Final Sat.:	16	1784	0	0	1768	32	0	0	0	1750	2072	1626
Capacity Analysis Module:												
Vol/Sat:	0.31	0.31	0.00	0.00	0.68	0.68	0.00	0.00	0.00	0.29	0.17	0.17
Crit Moves:	****						****					
Green Time:	79.5	79.5	0.0	0.0	79.5	79.5	0.0	0.0	0.0	34.5	34.5	34.5
Volume/Cap:	0.47	0.47	0.00	0.00	1.03	1.03	0.00	0.00	0.00	1.03	0.60	0.60
Delay/Veh:	10.3	10.3	0.0	0.0	53.0	53.0	0.0	0.0	0.0	89.5	37.8	37.8
User DelAdj:	1.00	1.00	1.00	1.00	1.00	1.00	1.00	1.00	1.00	1.00	1.00	1.00
AdjDel/Veh:	10.3	10.3	0.0	0.0	53.0	53.0	0.0	0.0	0.0	89.5	37.8	37.8
LOS by Move:	B	B	A	A	D	D	A	A	A	F	D	D
HCM2k95thQ:	19	19	0	0	85	85	0	0	0	45	20	20

Note: Queue reported is the number of cars per lane.

BART Phase II Extension Project

Level Of Service Computation Report
 2000 HCM Operations (Future Volume Alternative)
 AM - 2035 No Project Conditions

Intersection #6: DE LA CRUZ/MARTIN

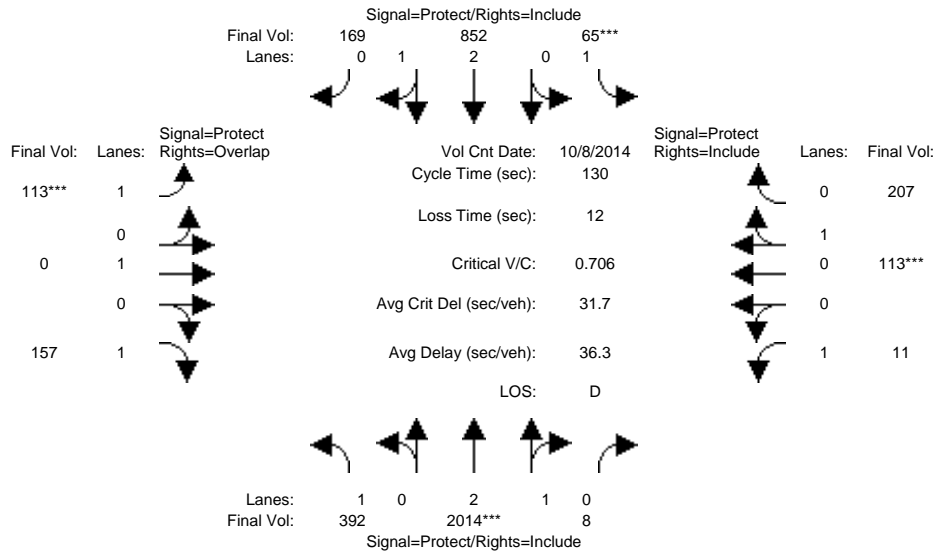

Approach:	North Bound			South Bound			East Bound			West Bound		
Movement:	L	T	R	L	T	R	L	T	R	L	T	R
Min. Green:	7	10	10	7	10	10	7	10	10	7	10	10
Y+R:	4.0	4.0	4.0	4.0	4.0	4.0	4.0	4.0	4.0	4.0	4.0	4.0

Volume Module:	>>	Count	Date:	8 Oct 2014	<<											
Base Vol:	392	2014	8	65	852	169	113	0	157	11	113	207				
Growth Adj:	1.00	1.00	1.00	1.00	1.00	1.00	1.00	1.00	1.00	1.00	1.00	1.00				
Initial Bse:	392	2014	8	65	852	169	113	0	157	11	113	207				
Added Vol:	0	0	0	0	0	0	0	0	0	0	0	0				
PasserByVol:	0	0	0	0	0	0	0	0	0	0	0	0				
Initial Fut:	392	2014	8	65	852	169	113	0	157	11	113	207				
User Adj:	1.00	1.00	1.00	1.00	1.00	1.00	1.00	1.00	1.00	1.00	1.00	1.00				
PHF Adj:	1.00	1.00	1.00	1.00	1.00	1.00	1.00	1.00	1.00	1.00	1.00	1.00				
PHF Volume:	392	2014	8	65	852	169	113	0	157	11	113	207				
Reduct Vol:	0	0	0	0	0	0	0	0	0	0	0	0				
Reduced Vol:	392	2014	8	65	852	169	113	0	157	11	113	207				
PCE Adj:	1.00	1.00	1.00	1.00	1.00	1.00	1.00	1.00	1.00	1.00	1.00	1.00				
MLF Adj:	1.00	1.00	1.00	1.00	1.00	1.00	1.00	1.00	1.00	1.00	1.00	1.00				
Final Volume:	392	2014	8	65	852	169	113	0	157	11	113	207				

Saturation Flow Module:												
Sat/Lane:	1900	1900	1900	1900	1900	1900	1900	1900	1900	1900	1900	1900
Adjustment:	0.92	0.98	0.95	0.92	0.99	0.95	0.92	1.00	0.92	0.92	0.95	0.95
Lanes:	1.00	2.99	0.01	1.00	2.49	0.51	1.00	1.00	1.00	1.00	0.35	0.65
Final Sat.:	1750	5578	22	1750	4672	927	1750	1900	1750	1750	636	1164

Capacity Analysis Module:												
Vol/Sat:	0.22	0.36	0.36	0.04	0.18	0.18	0.06	0.00	0.09	0.01	0.18	0.18
Crit Moves:	****			****			****			****		
Green Time:	40.5	66.4	66.4	7.0	32.9	32.9	11.9	0.0	52.3	44.6	32.7	32.7
Volume/Cap:	0.72	0.71	0.71	0.69	0.72	0.72	0.71	0.00	0.22	0.02	0.71	0.71
Delay/Veh:	44.4	25.2	25.2	79.9	46.1	46.1	70.9	0.0	25.6	28.3	49.4	49.4
User DelAdj:	1.00	1.00	1.00	1.00	1.00	1.00	1.00	1.00	1.00	1.00	1.00	1.00
AdjDel/Veh:	44.4	25.2	25.2	79.9	46.1	46.1	70.9	0.0	25.6	28.3	49.4	49.4
LOS by Move:	D	C	C	E	D	D	E	A	C	C	D	D
HCM2k95thQ:	27	35	35	6	23	23	10	0	8	1	24	24

Note: Queue reported is the number of cars per lane.

BART Phase II Extension Project

Level Of Service Computation Report
 2000 HCM Operations (Future Volume Alternative)
 PM - 2035 No Project Conditions

Intersection #6: DE LA CRUZ/MARTIN

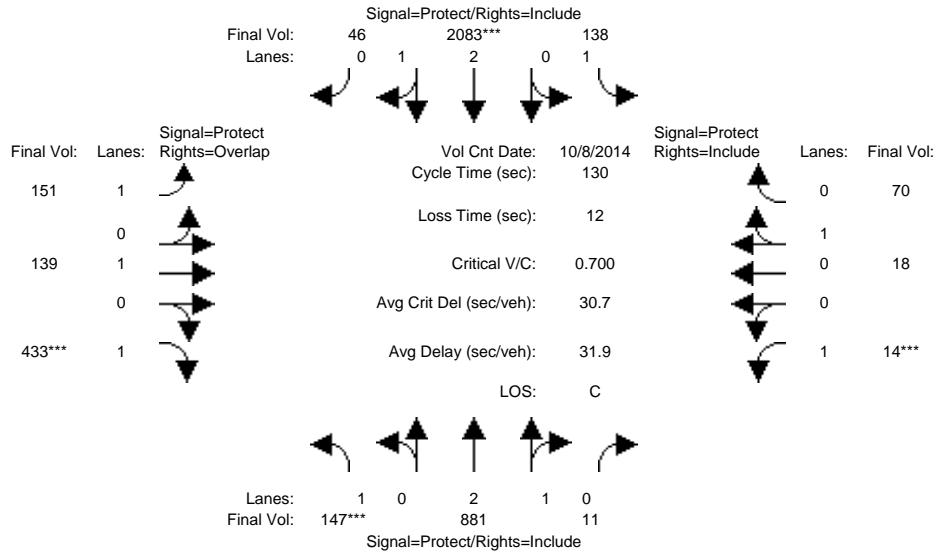

Approach:	North Bound			South Bound			East Bound			West Bound		
	L	T	R	L	T	R	L	T	R	L	T	R
Min. Green:	7	10	10	7	10	10	7	10	10	7	10	10
Y+R:	4.0	4.0	4.0	4.0	4.0	4.0	4.0	4.0	4.0	4.0	4.0	4.0

Volume Module:	>> Count Date: 8 Oct 2014 <<											
Base Vol:	147	881	11	138	2083	46	151	139	433	14	18	70
Growth Adj:	1.00	1.00	1.00	1.00	1.00	1.00	1.00	1.00	1.00	1.00	1.00	1.00
Initial Bse:	147	881	11	138	2083	46	151	139	433	14	18	70
Added Vol:	0	0	0	0	0	0	0	0	0	0	0	0
PasserByVol:	0	0	0	0	0	0	0	0	0	0	0	0
Initial Fut:	147	881	11	138	2083	46	151	139	433	14	18	70
User Adj:	1.00	1.00	1.00	1.00	1.00	1.00	1.00	1.00	1.00	1.00	1.00	1.00
PHF Adj:	1.00	1.00	1.00	1.00	1.00	1.00	1.00	1.00	1.00	1.00	1.00	1.00
PHF Volume:	147	881	11	138	2083	46	151	139	433	14	18	70
Reduct Vol:	0	0	0	0	0	0	0	0	0	0	0	0
Reduced Vol:	147	881	11	138	2083	46	151	139	433	14	18	70
PCE Adj:	1.00	1.00	1.00	1.00	1.00	1.00	1.00	1.00	1.00	1.00	1.00	1.00
MLF Adj:	1.00	1.00	1.00	1.00	1.00	1.00	1.00	1.00	1.00	1.00	1.00	1.00
Final Volume:	147	881	11	138	2083	46	151	139	433	14	18	70

Saturation Flow Module:												
Sat/Lane:	1900	1900	1900	1900	1900	1900	1900	1900	1900	1900	1900	1900
Adjustment:	0.92	0.98	0.95	0.92	0.98	0.95	0.92	1.00	0.92	0.92	0.95	0.95
Lanes:	1.00	2.96	0.04	1.00	2.93	0.07	1.00	1.00	1.00	1.00	0.20	0.80
Final Sat.:	1750	5531	69	1750	5479	121	1750	1900	1750	1750	368	1432

Capacity Analysis Module:												
Vol/Sat:	0.08	0.16	0.16	0.08	0.38	0.38	0.09	0.07	0.25	0.01	0.05	0.05
Crit Moves:	****			****			****		****	****		
Green Time:	14.9	54.9	54.9	27.2	67.2	67.2	19.0	28.9	43.8	7.0	16.9	16.9
Volume/Cap:	0.74	0.38	0.38	0.38	0.74	0.74	0.59	0.33	0.74	0.15	0.38	0.38
Delay/Veh:	68.9	25.9	25.9	44.8	25.4	25.4	55.5	42.9	42.8	59.4	52.7	52.7
User DelAdj:	1.00	1.00	1.00	1.00	1.00	1.00	1.00	1.00	1.00	1.00	1.00	1.00
AdjDel/Veh:	68.9	25.9	25.9	44.8	25.4	25.4	55.5	42.9	42.8	59.4	52.7	52.7
LOS by Move:	E	C	C	D	C	C	E	D	D	E	D	D
HCM2k95thQ:	12	15	15	10	38	38	12	9	29	1	7	7

Note: Queue reported is the number of cars per lane.

BART Phase II Extension Project

Level Of Service Computation Report
 2000 HCM Operations (Future Volume Alternative)
 AM - 2035 No Project Conditions

Intersection #7: LAFAYETTE/REED

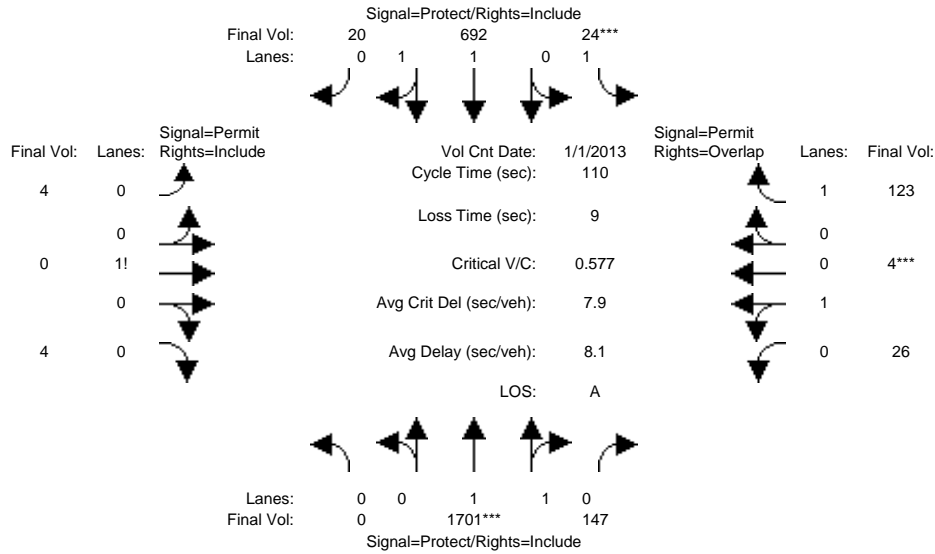

Approach:	North Bound			South Bound			East Bound			West Bound		
	L	T	R	L	T	R	L	T	R	L	T	R
Min. Green:	7	10	10	7	10	10	10	10	10	10	10	10
Y+R:	4.0	4.0	4.0	4.0	4.0	4.0	4.0	4.0	4.0	4.0	4.0	4.0
Volume Module: >> Count Date: 1 Jan 2013 <<												
Base Vol:	0	1701	147	24	692	20	4	0	4	26	4	123
Growth Adj:	1.00	1.00	1.00	1.00	1.00	1.00	1.00	1.00	1.00	1.00	1.00	1.00
Initial Bse:	0	1701	147	24	692	20	4	0	4	26	4	123
Added Vol:	0	0	0	0	0	0	0	0	0	0	0	0
PasserByVol:	0	0	0	0	0	0	0	0	0	0	0	0
Initial Fut:	0	1701	147	24	692	20	4	0	4	26	4	123
User Adj:	1.00	1.00	1.00	1.00	1.00	1.00	1.00	1.00	1.00	1.00	1.00	1.00
PHF Adj:	1.00	1.00	1.00	1.00	1.00	1.00	1.00	1.00	1.00	1.00	1.00	1.00
PHF Volume:	0	1701	147	24	692	20	4	0	4	26	4	123
Reduct Vol:	0	0	0	0	0	0	0	0	0	0	0	0
Reduced Vol:	0	1701	147	24	692	20	4	0	4	26	4	123
PCE Adj:	1.00	1.00	1.00	1.00	1.00	1.00	1.00	1.00	1.00	1.00	1.00	1.00
MLF Adj:	1.00	1.00	1.00	1.00	1.00	1.00	1.00	1.00	1.00	1.00	1.00	1.00
FinalVolume:	0	1701	147	24	692	20	4	0	4	26	4	123
Saturation Flow Module:												
Sat/Lane:	1900	1900	1900	1900	1900	1900	1900	1900	1900	1900	1900	1900
Adjustment:	0.92	0.98	0.95	0.92	0.97	0.95	0.92	0.92	0.92	0.95	0.95	0.92
Lanes:	0.00	1.84	0.16	1.00	1.94	0.06	0.50	0.00	0.50	0.87	0.13	1.00
Final Sat.:	0	3405	294	1750	3596	104	875	0	875	1560	240	1750
Capacity Analysis Module:												
Vol/Sat:	0.00	0.50	0.50	0.01	0.19	0.19	0.00	0.00	0.00	0.02	0.02	0.07
Crit Moves:	****			****						****		
Green Time:	0.0	84.0	84.0	7.0	91.0	91.0	10.0	0.0	10.0	10.0	10.0	17.0
Volume/Cap:	0.00	0.65	0.65	0.22	0.23	0.23	0.05	0.00	0.05	0.18	0.18	0.45
Delay/Veh:	0.0	6.7	6.7	49.9	2.1	2.1	45.8	0.0	45.8	46.8	46.8	43.5
User DelAdj:	1.00	1.00	1.00	1.00	1.00	1.00	1.00	1.00	1.00	1.00	1.00	1.00
AdjDel/Veh:	0.0	6.7	6.7	49.9	2.1	2.1	45.8	0.0	45.8	46.8	46.8	43.5
LOS by Move:	A	A	A	D	A	A	D	A	D	D	D	D
HCM2k95thQ:	0	27	27	2	5	5	1	0	1	2	2	8

Note: Queue reported is the number of cars per lane.

BART Phase II Extension Project

Level Of Service Computation Report
2000 HCM Operations (Future Volume Alternative)
PM - 2035 No Project Conditions

Intersection #7: LAFAYETTE/REED

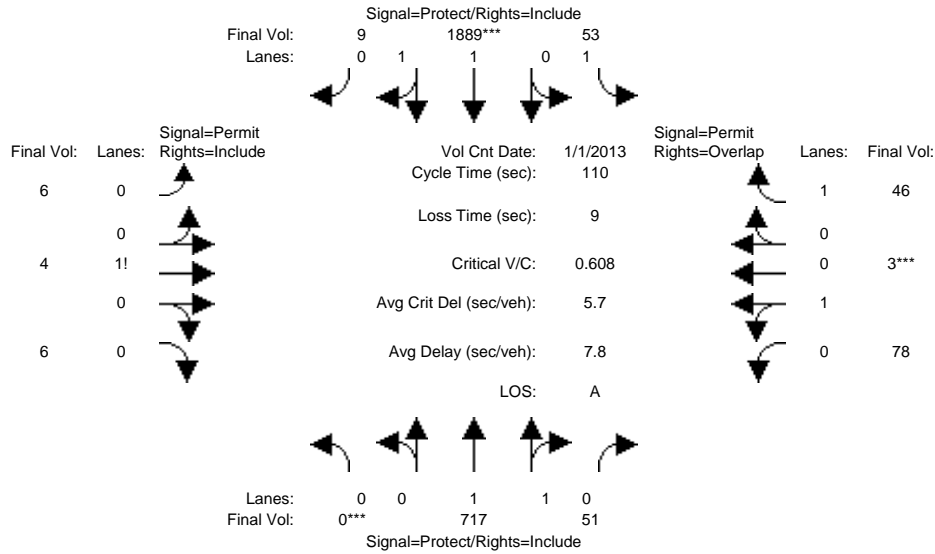

Approach:	North Bound			South Bound			East Bound			West Bound		
Movement:	L	T	R	L	T	R	L	T	R	L	T	R
Min. Green:	7	10	10	7	10	10	10	10	10	10	10	10
Y+R:	4.0	4.0	4.0	4.0	4.0	4.0	4.0	4.0	4.0	4.0	4.0	4.0
Volume Module: >> Count Date: 1 Jan 2013 <<												
Base Vol:	0	717	51	53	1889	9	6	4	6	78	3	46
Growth Adj:	1.00	1.00	1.00	1.00	1.00	1.00	1.00	1.00	1.00	1.00	1.00	1.00
Initial Bse:	0	717	51	53	1889	9	6	4	6	78	3	46
Added Vol:	0	0	0	0	0	0	0	0	0	0	0	0
PasserByVol:	0	0	0	0	0	0	0	0	0	0	0	0
Initial Fut:	0	717	51	53	1889	9	6	4	6	78	3	46
User Adj:	1.00	1.00	1.00	1.00	1.00	1.00	1.00	1.00	1.00	1.00	1.00	1.00
PHF Adj:	1.00	1.00	1.00	1.00	1.00	1.00	1.00	1.00	1.00	1.00	1.00	1.00
PHF Volume:	0	717	51	53	1889	9	6	4	6	78	3	46
Reduct Vol:	0	0	0	0	0	0	0	0	0	0	0	0
Reduced Vol:	0	717	51	53	1889	9	6	4	6	78	3	46
PCE Adj:	1.00	1.00	1.00	1.00	1.00	1.00	1.00	1.00	1.00	1.00	1.00	1.00
MLF Adj:	1.00	1.00	1.00	1.00	1.00	1.00	1.00	1.00	1.00	1.00	1.00	1.00
FinalVolume:	0	717	51	53	1889	9	6	4	6	78	3	46
Saturation Flow Module:												
Sat/Lane:	1900	1900	1900	1900	1900	1900	1900	1900	1900	1900	1900	1900
Adjustment:	0.92	0.98	0.95	0.92	0.97	0.95	0.92	0.92	0.92	0.95	0.95	0.92
Lanes:	0.00	1.86	0.14	1.00	1.99	0.01	0.37	0.25	0.38	0.96	0.04	1.00
Final Sat.:	0	3454	246	1750	3682	18	656	438	656	1733	67	1750
Capacity Analysis Module:												
Vol/Sat:	0.00	0.21	0.21	0.03	0.51	0.51	0.01	0.01	0.01	0.05	0.05	0.03
Crit Moves:	****				****						****	
Green Time:	0.0	69.6	69.6	21.4	91.0	91.0	10.0	10.0	10.0	10.0	10.0	31.4
Volume/Cap:	0.00	0.33	0.33	0.16	0.62	0.62	0.10	0.10	0.10	0.50	0.50	0.09
Delay/Veh:	0.0	9.4	9.4	37.1	3.8	3.8	46.2	46.2	46.2	49.9	49.9	29.0
User DelAdj:	1.00	1.00	1.00	1.00	1.00	1.00	1.00	1.00	1.00	1.00	1.00	1.00
AdjDel/Veh:	0.0	9.4	9.4	37.1	3.8	3.8	46.2	46.2	46.2	49.9	49.9	29.0
LOS by Move:	A	A	A	D	A	A	D	D	D	D	D	C
HCM2k95thQ:	0	12	12	3	22	22	1	1	1	6	6	2

Note: Queue reported is the number of cars per lane.

BART Phase II Extension Project

Level Of Service Computation Report
 2000 HCM Operations (Future Volume Alternative)
 AM - 2035 No Project Conditions

Intersection #9: Coleman/Brokaw

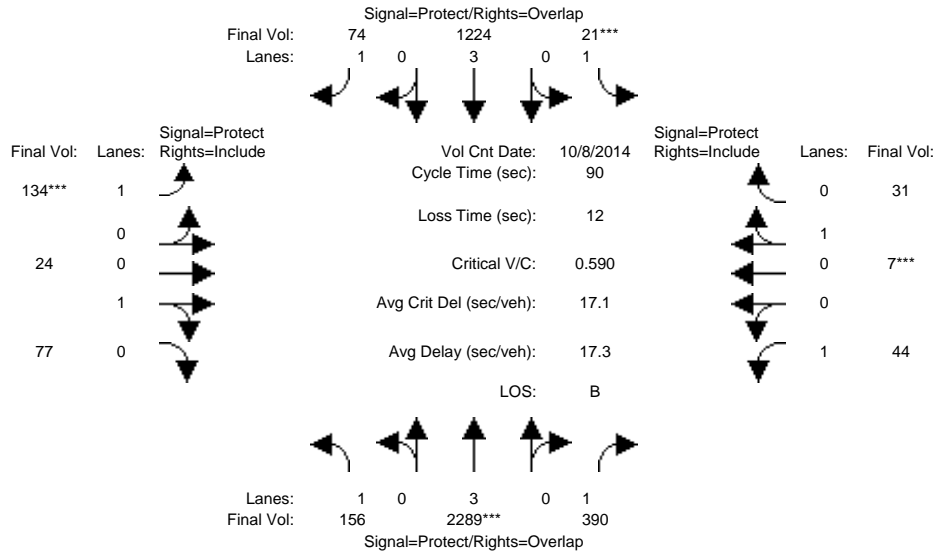

Approach:	North Bound			South Bound			East Bound			West Bound		
	L	T	R	L	T	R	L	T	R	L	T	R
Min. Green:	7	10	10	7	10	10	7	10	10	7	10	10
Y+R:	4.0	4.0	4.0	4.0	4.0	4.0	4.0	4.0	4.0	4.0	4.0	4.0
Volume Module: >> Count Date: 8 Oct 2014 <<												
Base Vol:	156	2289	390	21	1224	74	134	24	77	44	7	31
Growth Adj:	1.00	1.00	1.00	1.00	1.00	1.00	1.00	1.00	1.00	1.00	1.00	1.00
Initial Bse:	156	2289	390	21	1224	74	134	24	77	44	7	31
Added Vol:	0	0	0	0	0	0	0	0	0	0	0	0
PasserByVol:	0	0	0	0	0	0	0	0	0	0	0	0
Initial Fut:	156	2289	390	21	1224	74	134	24	77	44	7	31
User Adj:	1.00	1.00	1.00	1.00	1.00	1.00	1.00	1.00	1.00	1.00	1.00	1.00
PHF Adj:	1.00	1.00	1.00	1.00	1.00	1.00	1.00	1.00	1.00	1.00	1.00	1.00
PHF Volume:	156	2289	390	21	1224	74	134	24	77	44	7	31
Reduct Vol:	0	0	0	0	0	0	0	0	0	0	0	0
Reduced Vol:	156	2289	390	21	1224	74	134	24	77	44	7	31
PCE Adj:	1.00	1.00	1.00	1.00	1.00	1.00	1.00	1.00	1.00	1.00	1.00	1.00
MLF Adj:	1.00	1.00	1.00	1.00	1.00	1.00	1.00	1.00	1.00	1.00	1.00	1.00
FinalVolume:	156	2289	390	21	1224	74	134	24	77	44	7	31
Saturation Flow Module:												
Sat/Lane:	1900	1900	1900	1900	1900	1900	1900	1900	1900	1900	1900	1900
Adjustment:	0.92	1.00	0.92	0.92	1.00	0.92	0.92	0.95	0.95	0.92	0.95	0.95
Lanes:	1.00	3.00	1.00	1.00	3.00	1.00	1.00	0.24	0.76	1.00	0.18	0.82
Final Sat.:	1750	5700	1750	1750	5700	1750	1750	428	1372	1750	332	1468
Capacity Analysis Module:												
Vol/Sat:	0.09	0.40	0.22	0.01	0.21	0.04	0.08	0.06	0.06	0.03	0.02	0.02
Crit Moves:	****			****			****			****		
Green Time:	17.1	51.2	59.4	7.0	41.1	50.9	9.8	11.6	11.6	8.1	10.0	10.0
Volume/Cap:	0.47	0.71	0.34	0.15	0.47	0.07	0.71	0.43	0.43	0.28	0.19	0.19
Delay/Veh:	33.5	14.7	6.9	39.3	17.0	8.9	50.2	37.5	37.5	39.1	36.8	36.8
User DelAdj:	1.00	1.00	1.00	1.00	1.00	1.00	1.00	1.00	1.00	1.00	1.00	1.00
AdjDel/Veh:	33.5	14.7	6.9	39.3	17.0	8.9	50.2	37.5	37.5	39.1	36.8	36.8
LOS by Move:	C	B	A	D	B	A	D	D	D	D	D	D
HCM2k95thQ:	8	25	9	1	14	2	11	6	6	2	2	2

Note: Queue reported is the number of cars per lane.

BART Phase II Extension Project

Level Of Service Computation Report
 2000 HCM Operations (Future Volume Alternative)
 PM - 2035 No Project Conditions

Intersection #9: Coleman/Brokaw

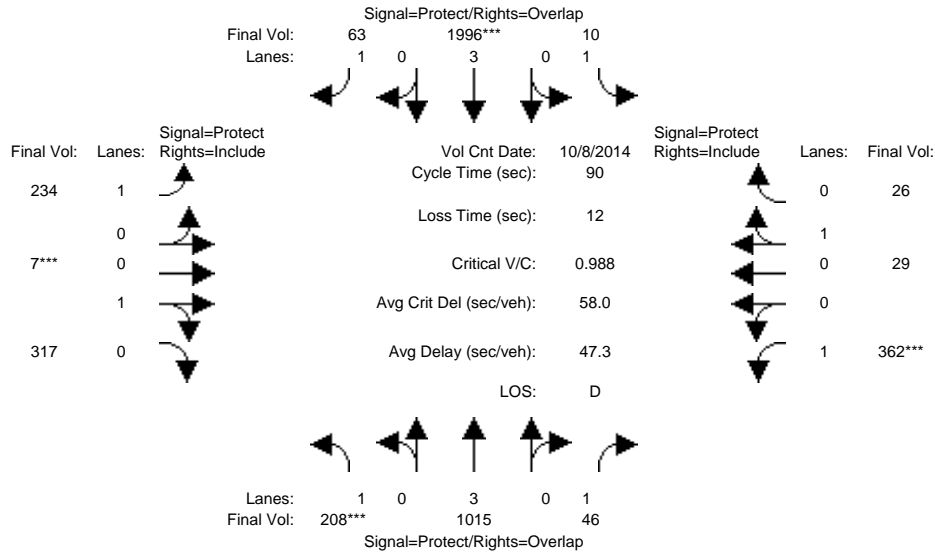

Approach:	North Bound			South Bound			East Bound			West Bound		
	L	T	R	L	T	R	L	T	R	L	T	R
Min. Green:	7	10	10	7	10	10	7	10	10	7	10	10
Y+R:	4.0	4.0	4.0	4.0	4.0	4.0	4.0	4.0	4.0	4.0	4.0	4.0
Volume Module: >> Count Date: 8 Oct 2014 <<												
Base Vol:	208	1015	46	10	1996	63	234	7	317	362	29	26
Growth Adj:	1.00	1.00	1.00	1.00	1.00	1.00	1.00	1.00	1.00	1.00	1.00	1.00
Initial Bse:	208	1015	46	10	1996	63	234	7	317	362	29	26
Added Vol:	0	0	0	0	0	0	0	0	0	0	0	0
PasserByVol:	0	0	0	0	0	0	0	0	0	0	0	0
Initial Fut:	208	1015	46	10	1996	63	234	7	317	362	29	26
User Adj:	1.00	1.00	1.00	1.00	1.00	1.00	1.00	1.00	1.00	1.00	1.00	1.00
PHF Adj:	1.00	1.00	1.00	1.00	1.00	1.00	1.00	1.00	1.00	1.00	1.00	1.00
PHF Volume:	208	1015	46	10	1996	63	234	7	317	362	29	26
Reduct Vol:	0	0	0	0	0	0	0	0	0	0	0	0
Reduced Vol:	208	1015	46	10	1996	63	234	7	317	362	29	26
PCE Adj:	1.00	1.00	1.00	1.00	1.00	1.00	1.00	1.00	1.00	1.00	1.00	1.00
MLF Adj:	1.00	1.00	1.00	1.00	1.00	1.00	1.00	1.00	1.00	1.00	1.00	1.00
FinalVolume:	208	1015	46	10	1996	63	234	7	317	362	29	26
Saturation Flow Module:												
Sat/Lane:	1900	1900	1900	1900	1900	1900	1900	1900	1900	1900	1900	1900
Adjustment:	0.92	1.00	0.92	0.92	1.00	0.92	0.92	0.95	0.95	0.92	0.95	0.95
Lanes:	1.00	3.00	1.00	1.00	3.00	1.00	1.00	0.02	0.98	1.00	0.53	0.47
Final Sat.:	1750	5700	1750	1750	5700	1750	1750	39	1761	1750	949	851
Capacity Analysis Module:												
Vol/Sat:	0.12	0.18	0.03	0.01	0.35	0.04	0.13	0.18	0.18	0.21	0.03	0.03
Crit Moves:	****				****			****			****	
Green Time:	10.8	29.8	48.6	13.0	31.9	51.2	19.3	16.4	16.4	18.9	16.0	16.0
Volume/Cap:	0.99	0.54	0.05	0.04	0.99	0.06	0.62	0.99	0.99	0.99	0.17	0.17
Delay/Veh:	97.8	24.9	9.8	33.2	45.9	8.7	35.4	82.9	82.9	79.0	31.6	31.6
User DelAdj:	1.00	1.00	1.00	1.00	1.00	1.00	1.00	1.00	1.00	1.00	1.00	1.00
AdjDel/Veh:	97.8	24.9	9.8	33.2	45.9	8.7	35.4	82.9	82.9	79.0	31.6	31.6
LOS by Move:	F	C	A	C	D	A	D	F	F	E	C	C
HCM2k95thQ:	15	14	1	1	38	2	14	26	26	25	3	3

Note: Queue reported is the number of cars per lane.

BART Phase II Extension Project

Level Of Service Computation Report
2000 HCM Operations (Future Volume Alternative)
AM - 2035 No Project Conditions

Intersection #106: Benton/EI Camino Real

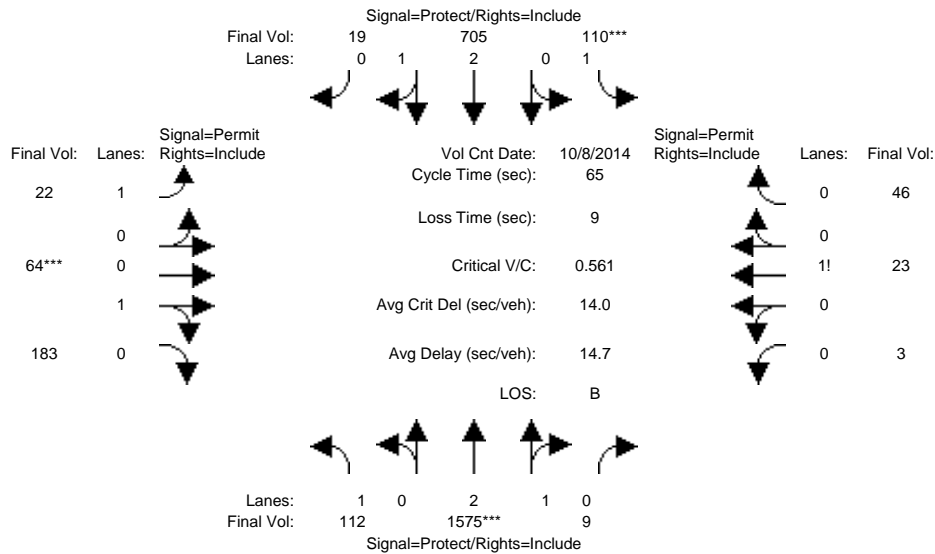

Approach:	North Bound			South Bound			East Bound			West Bound		
	L	T	R	L	T	R	L	T	R	L	T	R
Min. Green:	7	10	10	7	10	10	10	10	10	10	10	10
Y+R:	4.0	4.0	4.0	4.0	4.0	4.0	4.0	4.0	4.0	4.0	4.0	4.0
Volume Module: >> Count Date: 8 Oct 2014 <<												
Base Vol:	112	1575	9	110	705	19	22	64	183	3	23	46
Growth Adj:	1.00	1.00	1.00	1.00	1.00	1.00	1.00	1.00	1.00	1.00	1.00	1.00
Initial Bse:	112	1575	9	110	705	19	22	64	183	3	23	46
Added Vol:	0	0	0	0	0	0	0	0	0	0	0	0
PasserByVol:	0	0	0	0	0	0	0	0	0	0	0	0
Initial Fut:	112	1575	9	110	705	19	22	64	183	3	23	46
User Adj:	1.00	1.00	1.00	1.00	1.00	1.00	1.00	1.00	1.00	1.00	1.00	1.00
PHF Adj:	1.00	1.00	1.00	1.00	1.00	1.00	1.00	1.00	1.00	1.00	1.00	1.00
PHF Volume:	112	1575	9	110	705	19	22	64	183	3	23	46
Reduct Vol:	0	0	0	0	0	0	0	0	0	0	0	0
Reduced Vol:	112	1575	9	110	705	19	22	64	183	3	23	46
PCE Adj:	1.00	1.00	1.00	1.00	1.00	1.00	1.00	1.00	1.00	1.00	1.00	1.00
MLF Adj:	1.00	1.00	1.00	1.00	1.00	1.00	1.00	1.00	1.00	1.00	1.00	1.00
Final Volume:	112	1575	9	110	705	19	22	64	183	3	23	46
Saturation Flow Module:												
Sat/Lane:	1900	1900	1900	1900	1900	1900	1900	1900	1900	1900	1900	1900
Adjustment:	0.92	0.98	0.95	0.92	0.98	0.95	0.92	0.95	0.95	0.92	0.92	0.92
Lanes:	1.00	2.98	0.02	1.00	2.92	0.08	1.00	0.26	0.74	0.04	0.32	0.64
Final Sat.:	1750	5568	32	1750	5453	147	1750	466	1334	73	559	1118
Capacity Analysis Module:												
Vol/Sat:	0.06	0.28	0.28	0.06	0.13	0.13	0.01	0.14	0.14	0.04	0.04	0.04
Crit Moves:	****			****			****					
Green Time:	16.5	32.8	32.8	7.3	23.6	23.6	15.9	15.9	15.9	15.9	15.9	15.9
Volume/Cap:	0.25	0.56	0.56	0.56	0.36	0.36	0.05	0.56	0.56	0.17	0.17	0.17
Delay/Veh:	19.6	11.4	11.4	31.0	15.3	15.3	18.8	23.1	23.1	19.5	19.5	19.5
User DelAdj:	1.00	1.00	1.00	1.00	1.00	1.00	1.00	1.00	1.00	1.00	1.00	1.00
AdjDel/Veh:	19.6	11.4	11.4	31.0	15.3	15.3	18.8	23.1	23.1	19.5	19.5	19.5
LOS by Move:	B	B	B	C	B	B	B	C	C	B	B	B
HCM2k95thQ:	4	14	14	5	7	7	1	9	9	3	3	3

Note: Queue reported is the number of cars per lane.

BART Phase II Extension Project

Level Of Service Computation Report
2000 HCM Operations (Future Volume Alternative)
PM - 2035 No Project Conditions

Intersection #106: Benton/EI Camino Real

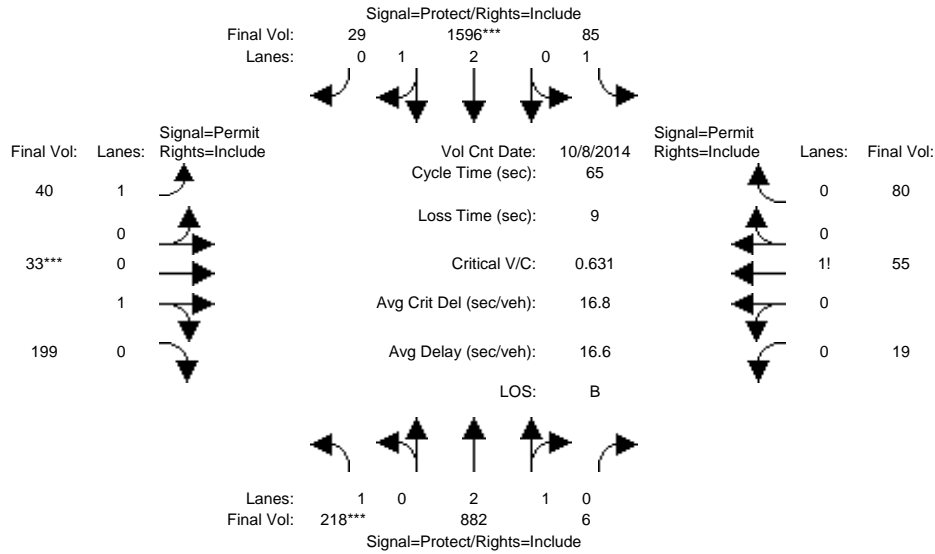

Approach:	North Bound			South Bound			East Bound			West Bound		
	L	T	R	L	T	R	L	T	R	L	T	R
Min. Green:	7	10	10	7	10	10	10	10	10	10	10	10
Y+R:	4.0	4.0	4.0	4.0	4.0	4.0	4.0	4.0	4.0	4.0	4.0	4.0
Volume Module: >> Count Date: 8 Oct 2014 <<												
Base Vol:	218	882	6	85	1596	29	40	33	199	19	55	80
Growth Adj:	1.00	1.00	1.00	1.00	1.00	1.00	1.00	1.00	1.00	1.00	1.00	1.00
Initial Bse:	218	882	6	85	1596	29	40	33	199	19	55	80
Added Vol:	0	0	0	0	0	0	0	0	0	0	0	0
PasserByVol:	0	0	0	0	0	0	0	0	0	0	0	0
Initial Fut:	218	882	6	85	1596	29	40	33	199	19	55	80
User Adj:	1.00	1.00	1.00	1.00	1.00	1.00	1.00	1.00	1.00	1.00	1.00	1.00
PHF Adj:	1.00	1.00	1.00	1.00	1.00	1.00	1.00	1.00	1.00	1.00	1.00	1.00
PHF Volume:	218	882	6	85	1596	29	40	33	199	19	55	80
Reduct Vol:	0	0	0	0	0	0	0	0	0	0	0	0
Reduced Vol:	218	882	6	85	1596	29	40	33	199	19	55	80
PCE Adj:	1.00	1.00	1.00	1.00	1.00	1.00	1.00	1.00	1.00	1.00	1.00	1.00
MLF Adj:	1.00	1.00	1.00	1.00	1.00	1.00	1.00	1.00	1.00	1.00	1.00	1.00
FinalVolume:	218	882	6	85	1596	29	40	33	199	19	55	80
Saturation Flow Module:												
Sat/Lane:	1900	1900	1900	1900	1900	1900	1900	1900	1900	1900	1900	1900
Adjustment:	0.92	0.98	0.95	0.92	0.98	0.95	0.92	0.95	0.95	0.92	0.92	0.92
Lanes:	1.00	2.98	0.02	1.00	2.94	0.06	1.00	0.14	0.86	0.12	0.36	0.52
Final Sat.:	1750	5562	38	1750	5500	100	1750	256	1544	216	625	909
Capacity Analysis Module:												
Vol/Sat:	0.12	0.16	0.16	0.05	0.29	0.29	0.02	0.13	0.13	0.09	0.09	0.09
Crit Moves:	****			****			****					
Green Time:	12.8	25.4	25.4	17.3	29.9	29.9	13.3	13.3	13.3	13.3	13.3	13.3
Volume/Cap:	0.63	0.41	0.41	0.18	0.63	0.63	0.11	0.63	0.63	0.43	0.43	0.43
Delay/Veh:	27.7	14.4	14.4	18.6	13.9	13.9	21.2	27.1	27.1	23.4	23.4	23.4
User DelAdj:	1.00	1.00	1.00	1.00	1.00	1.00	1.00	1.00	1.00	1.00	1.00	1.00
AdjDel/Veh:	27.7	14.4	14.4	18.6	13.9	13.9	21.2	27.1	27.1	23.4	23.4	23.4
LOS by Move:	C	B	B	B	B	B	C	C	C	C	C	C
HCM2k95thQ:	9	8	8	3	16	16	1	9	9	7	7	7

Note: Queue reported is the number of cars per lane.

BART Phase II Extension Project

Level Of Service Computation Report
 2000 HCM Operations (Future Volume Alternative)
 AM - 2035 No Project Conditions

Intersection #107: Benton/Lafayette

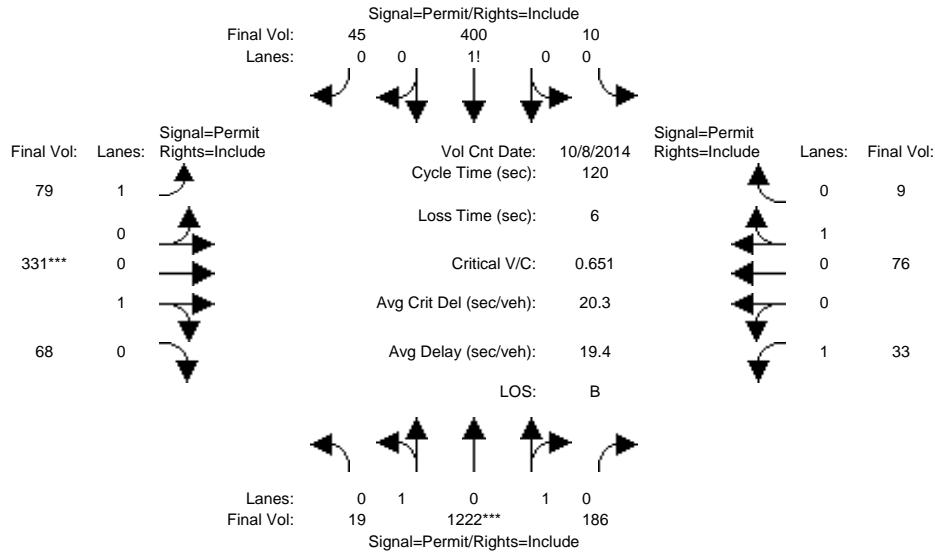

Approach:	North Bound			South Bound			East Bound			West Bound		
	L	T	R	L	T	R	L	T	R	L	T	R
Min. Green:	10	10	10	10	10	10	10	10	10	10	10	10
Y+R:	4.0	4.0	4.0	4.0	4.0	4.0	4.0	4.0	4.0	4.0	4.0	4.0
Volume Module: >> Count Date: 8 Oct 2014 <<												
Base Vol:	19	1222	186	10	400	45	79	331	68	33	76	9
Growth Adj:	1.00	1.00	1.00	1.00	1.00	1.00	1.00	1.00	1.00	1.00	1.00	1.00
Initial Bse:	19	1222	186	10	400	45	79	331	68	33	76	9
Added Vol:	0	0	0	0	0	0	0	0	0	0	0	0
PasserByVol:	0	0	0	0	0	0	0	0	0	0	0	0
Initial Fut:	19	1222	186	10	400	45	79	331	68	33	76	9
User Adj:	1.00	1.00	1.00	1.00	1.00	1.00	1.00	1.00	1.00	1.00	1.00	1.00
PHF Adj:	1.00	1.00	1.00	1.00	1.00	1.00	1.00	1.00	1.00	1.00	1.00	1.00
PHF Volume:	19	1222	186	10	400	45	79	331	68	33	76	9
Reduct Vol:	0	0	0	0	0	0	0	0	0	0	0	0
Reduced Vol:	19	1222	186	10	400	45	79	331	68	33	76	9
PCE Adj:	1.00	1.00	1.00	1.00	1.00	1.00	1.00	1.00	1.00	1.00	1.00	1.00
MLF Adj:	1.00	1.00	1.00	1.00	1.00	1.00	1.00	1.00	1.00	1.00	1.00	1.00
FinalVolume:	19	1222	186	10	400	45	79	331	68	33	76	9
Saturation Flow Module:												
Sat/Lane:	1900	1900	1900	1900	1900	1900	1900	1900	1900	1900	1900	1900
Adjustment:	0.95	0.95	0.95	0.92	0.92	0.92	0.92	0.95	0.95	0.92	0.95	0.95
Lanes:	0.03	1.71	0.26	0.02	0.88	0.10	1.00	0.83	0.17	1.00	0.89	0.11
Final Sat.:	48	3083	469	38	1538	173	1750	1493	307	1750	1609	191
Capacity Analysis Module:												
Vol/Sat:	0.40	0.40	0.40	0.26	0.26	0.26	0.05	0.22	0.22	0.02	0.05	0.05
Crit Moves:	****			****			****			****		
Green Time:	73.1	73.1	73.1	73.1	73.1	73.1	40.9	40.9	40.9	40.9	40.9	40.9
Volume/Cap:	0.65	0.65	0.65	0.43	0.43	0.43	0.13	0.65	0.65	0.06	0.14	0.14
Delay/Veh:	15.9	15.9	15.9	12.7	12.7	12.7	27.4	36.0	36.0	26.6	27.5	27.5
User DelAdj:	1.00	1.00	1.00	1.00	1.00	1.00	1.00	1.00	1.00	1.00	1.00	1.00
AdjDel/Veh:	15.9	15.9	15.9	12.7	12.7	12.7	27.4	36.0	36.0	26.6	27.5	27.5
LOS by Move:	B	B	B	B	B	B	C	D	D	C	C	C
HCM2k95thQ:	29	29	29	17	17	17	4	23	23	2	5	5

Note: Queue reported is the number of cars per lane.

BART Phase II Extension Project

Level Of Service Computation Report
2000 HCM Operations (Future Volume Alternative)
PM - 2035 No Project Conditions

Intersection #107: Benton/Lafayette

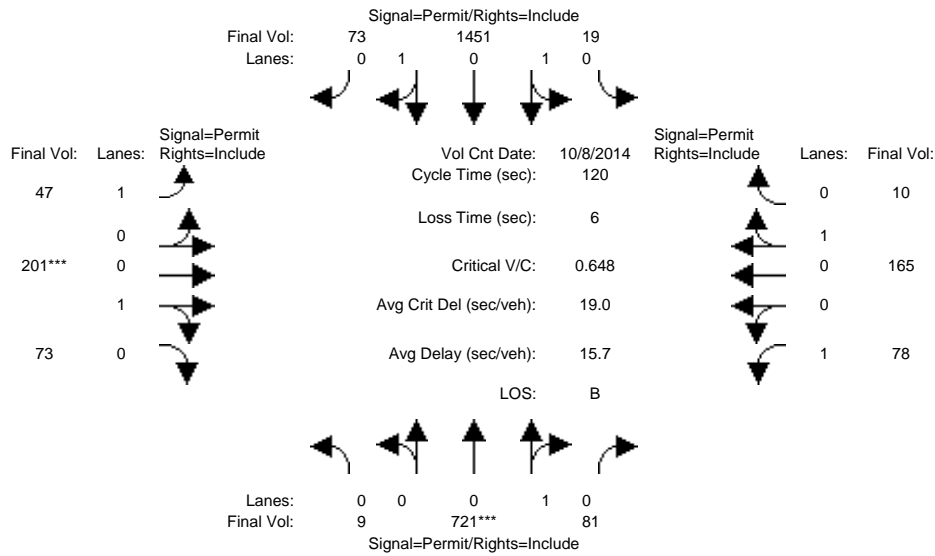

Approach:	North Bound			South Bound			East Bound			West Bound		
	L	T	R	L	T	R	L	T	R	L	T	R
Min. Green:	10	10	10	10	10	10	10	10	10	10	10	10
Y+R:	4.0	4.0	4.0	4.0	4.0	4.0	4.0	4.0	4.0	4.0	4.0	4.0
Volume Module: >> Count Date: 8 Oct 2014 <<												
Base Vol:	9	721	81	19	1451	73	47	201	73	78	165	10
Growth Adj:	1.00	1.00	1.00	1.00	1.00	1.00	1.00	1.00	1.00	1.00	1.00	1.00
Initial Bse:	9	721	81	19	1451	73	47	201	73	78	165	10
Added Vol:	0	0	0	0	0	0	0	0	0	0	0	0
PasserByVol:	0	0	0	0	0	0	0	0	0	0	0	0
Initial Fut:	9	721	81	19	1451	73	47	201	73	78	165	10
User Adj:	1.00	1.00	1.00	1.00	1.00	1.00	1.00	1.00	1.00	1.00	1.00	1.00
PHF Adj:	1.00	1.00	1.00	1.00	1.00	1.00	1.00	1.00	1.00	1.00	1.00	1.00
PHF Volume:	9	721	81	19	1451	73	47	201	73	78	165	10
Reduct Vol:	0	0	0	0	0	0	0	0	0	0	0	0
Reduced Vol:	9	721	81	19	1451	73	47	201	73	78	165	10
PCE Adj:	1.00	1.00	1.00	1.00	1.00	1.00	1.00	1.00	1.00	1.00	1.00	1.00
MLF Adj:	1.00	1.00	1.00	1.00	1.00	1.00	1.00	1.00	1.00	1.00	1.00	1.00
FinalVolume:	9	721	81	19	1451	73	47	201	73	78	165	10
Saturation Flow Module:												
Sat/Lane:	1900	1900	1900	1900	1900	1900	1900	1900	1900	1900	1900	1900
Adjustment:	0.92	0.92	0.92	0.95	0.95	0.95	0.92	0.95	0.95	0.92	0.95	0.95
Lanes:	0.01	0.89	0.10	0.02	1.89	0.09	1.00	0.73	0.27	1.00	0.94	0.06
Final Sat.:	19	1556	175	44	3385	170	1750	1320	480	1750	1697	103
Capacity Analysis Module:												
Vol/Sat:	0.46	0.46	0.46	0.43	0.43	0.43	0.03	0.15	0.15	0.04	0.10	0.10
Crit Moves:	****			****			****					
Green Time:	85.8	85.8	85.8	85.8	85.8	85.8	28.2	28.2	28.2	28.2	28.2	28.2
Volume/Cap:	0.65	0.65	0.65	0.60	0.60	0.60	0.11	0.65	0.65	0.19	0.41	0.41
Delay/Veh:	10.3	10.3	10.3	8.9	8.9	8.9	36.2	44.9	44.9	37.0	39.6	39.6
User DelAdj:	1.00	1.00	1.00	1.00	1.00	1.00	1.00	1.00	1.00	1.00	1.00	1.00
AdjDel/Veh:	10.3	10.3	10.3	8.9	8.9	8.9	36.2	44.9	44.9	37.0	39.6	39.6
LOS by Move:	B	B	B	A	A	A	D	D	D	D	D	D
HCM2k95thQ:	28	28	28	24	24	24	3	18	18	5	11	11

Note: Queue reported is the number of cars per lane.

BART Phase II Extension Project

Level Of Service Computation Report
 2000 HCM Operations (Future Volume Alternative)
 AM - 2035 No Project Conditions

Intersection #175: Reed/De La Cruz

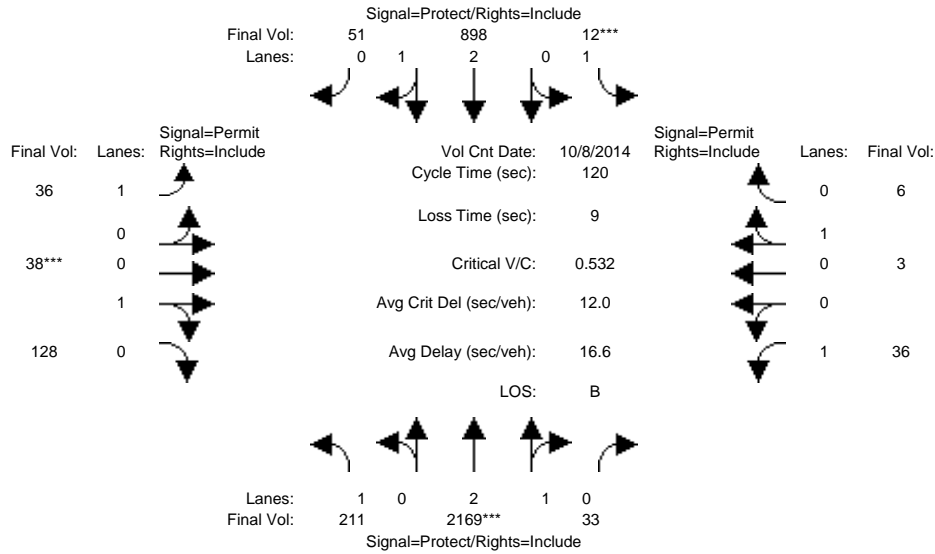

Approach:	North Bound			South Bound			East Bound			West Bound		
	L	T	R	L	T	R	L	T	R	L	T	R
Min. Green:	7	10	10	7	10	10	10	10	10	10	10	10
Y+R:	4.0	4.0	4.0	4.0	4.0	4.0	4.0	4.0	4.0	4.0	4.0	4.0
Volume Module: >> Count Date: 8 Oct 2014 <<												
Base Vol:	211	2169	33	12	898	51	36	38	128	36	3	6
Growth Adj:	1.00	1.00	1.00	1.00	1.00	1.00	1.00	1.00	1.00	1.00	1.00	1.00
Initial Bse:	211	2169	33	12	898	51	36	38	128	36	3	6
Added Vol:	0	0	0	0	0	0	0	0	0	0	0	0
PasserByVol:	0	0	0	0	0	0	0	0	0	0	0	0
Initial Fut:	211	2169	33	12	898	51	36	38	128	36	3	6
User Adj:	1.00	1.00	1.00	1.00	1.00	1.00	1.00	1.00	1.00	1.00	1.00	1.00
PHF Adj:	1.00	1.00	1.00	1.00	1.00	1.00	1.00	1.00	1.00	1.00	1.00	1.00
PHF Volume:	211	2169	33	12	898	51	36	38	128	36	3	6
Reduct Vol:	0	0	0	0	0	0	0	0	0	0	0	0
Reduced Vol:	211	2169	33	12	898	51	36	38	128	36	3	6
PCE Adj:	1.00	1.00	1.00	1.00	1.00	1.00	1.00	1.00	1.00	1.00	1.00	1.00
MLF Adj:	1.00	1.00	1.00	1.00	1.00	1.00	1.00	1.00	1.00	1.00	1.00	1.00
FinalVolume:	211	2169	33	12	898	51	36	38	128	36	3	6
Saturation Flow Module:												
Sat/Lane:	1900	1900	1900	1900	1900	1900	1900	1900	1900	1900	1900	1900
Adjustment:	0.92	0.98	0.95	0.92	0.98	0.95	0.92	0.95	0.95	0.92	0.95	0.95
Lanes:	1.00	2.95	0.05	1.00	2.83	0.17	1.00	0.23	0.77	1.00	0.33	0.67
Final Sat.:	1750	5516	84	1750	5299	301	1750	412	1388	1750	600	1200
Capacity Analysis Module:												
Vol/Sat:	0.12	0.39	0.39	0.01	0.17	0.17	0.02	0.09	0.09	0.02	0.01	0.01
Crit Moves:	****			****			****			****		
Green Time:	37.9	84.2	84.2	7.0	53.3	53.3	19.8	19.8	19.8	19.8	19.8	19.8
Volume/Cap:	0.38	0.56	0.56	0.12	0.38	0.38	0.12	0.56	0.56	0.12	0.03	0.03
Delay/Veh:	32.4	9.0	9.0	54.1	22.4	22.4	42.9	48.5	48.5	42.9	42.1	42.1
User DelAdj:	1.00	1.00	1.00	1.00	1.00	1.00	1.00	1.00	1.00	1.00	1.00	1.00
AdjDel/Veh:	32.4	9.0	9.0	54.1	22.4	22.4	42.9	48.5	48.5	42.9	42.1	42.1
LOS by Move:	C	A	A	D	C	C	D	D	D	D	D	D
HCM2k95thQ:	13	24	24	1	14	14	2	11	11	3	1	1

Note: Queue reported is the number of cars per lane.

BART Phase II Extension Project

Level Of Service Computation Report
 2000 HCM Operations (Future Volume Alternative)
 PM - 2035 No Project Conditions

Intersection #175: Reed/De La Cruz

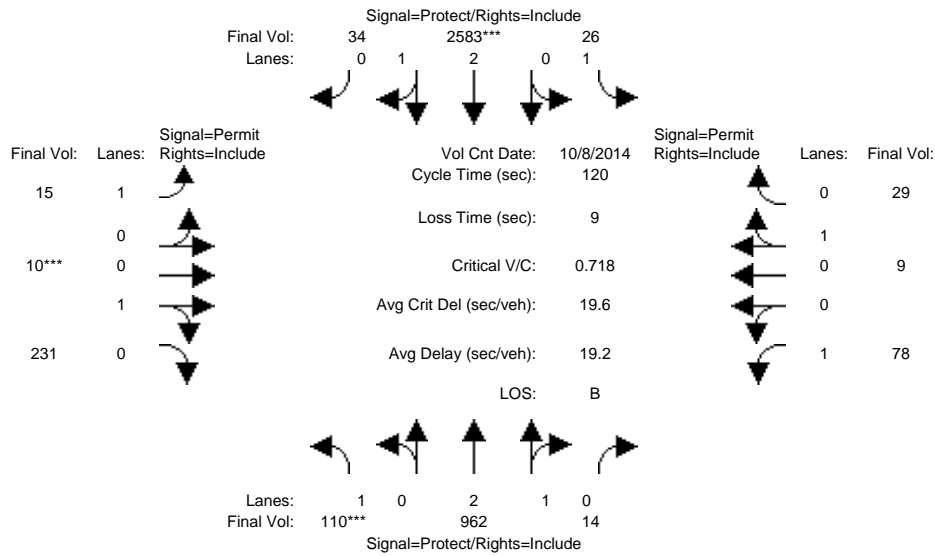

Approach:	North Bound			South Bound			East Bound			West Bound		
Movement:	L	T	R	L	T	R	L	T	R	L	T	R
Min. Green:	7	10	10	7	10	10	10	10	10	10	10	10
Y+R:	4.0	4.0	4.0	4.0	4.0	4.0	4.0	4.0	4.0	4.0	4.0	4.0
Volume Module: >> Count Date: 8 Oct 2014 <<												
Base Vol:	110	962	14	26	2583	34	15	10	231	78	9	29
Growth Adj:	1.00	1.00	1.00	1.00	1.00	1.00	1.00	1.00	1.00	1.00	1.00	1.00
Initial Bse:	110	962	14	26	2583	34	15	10	231	78	9	29
Added Vol:	0	0	0	0	0	0	0	0	0	0	0	0
PasserByVol:	0	0	0	0	0	0	0	0	0	0	0	0
Initial Fut:	110	962	14	26	2583	34	15	10	231	78	9	29
User Adj:	1.00	1.00	1.00	1.00	1.00	1.00	1.00	1.00	1.00	1.00	1.00	1.00
PHF Adj:	1.00	1.00	1.00	1.00	1.00	1.00	1.00	1.00	1.00	1.00	1.00	1.00
PHF Volume:	110	962	14	26	2583	34	15	10	231	78	9	29
Reduct Vol:	0	0	0	0	0	0	0	0	0	0	0	0
Reduced Vol:	110	962	14	26	2583	34	15	10	231	78	9	29
PCE Adj:	1.00	1.00	1.00	1.00	1.00	1.00	1.00	1.00	1.00	1.00	1.00	1.00
MLF Adj:	1.00	1.00	1.00	1.00	1.00	1.00	1.00	1.00	1.00	1.00	1.00	1.00
FinalVolume:	110	962	14	26	2583	34	15	10	231	78	9	29
Saturation Flow Module:												
Sat/Lane:	1900	1900	1900	1900	1900	1900	1900	1900	1900	1900	1900	1900
Adjustment:	0.92	0.98	0.95	0.92	0.98	0.95	0.92	0.95	0.95	0.92	0.95	0.95
Lanes:	1.00	2.96	0.04	1.00	2.96	0.04	1.00	0.04	0.96	1.00	0.24	0.76
Final Sat.:	1750	5520	80	1750	5527	73	1750	75	1725	1750	426	1374
Capacity Analysis Module:												
Vol/Sat:	0.06	0.17	0.17	0.01	0.47	0.47	0.01	0.13	0.13	0.04	0.02	0.02
Crit Moves:	****			****			****					
Green Time:	10.5	66.4	66.4	22.2	78.1	78.1	22.4	22.4	22.4	22.4	22.4	22.4
Volume/Cap:	0.72	0.31	0.31	0.08	0.72	0.72	0.05	0.72	0.72	0.24	0.11	0.11
Delay/Veh:	68.4	14.6	14.6	40.5	14.4	14.4	40.1	53.1	53.1	41.9	40.7	40.7
User DelAdj:	1.00	1.00	1.00	1.00	1.00	1.00	1.00	1.00	1.00	1.00	1.00	1.00
AdjDel/Veh:	68.4	14.6	14.6	40.5	14.4	14.4	40.1	53.1	53.1	41.9	40.7	40.7
LOS by Move:	E	B	B	D	B	B	D	D	D	D	D	D
HCM2k95thQ:	11	12	12	2	36	36	1	17	17	5	3	3

Note: Queue reported is the number of cars per lane.

BART Phase II Extension Project

Level Of Service Computation Report
2000 HCM Unsignalized (Future Volume Alternative)
AM - 2035 No Project Conditions

Intersection #1008: Lafayette/Harrison

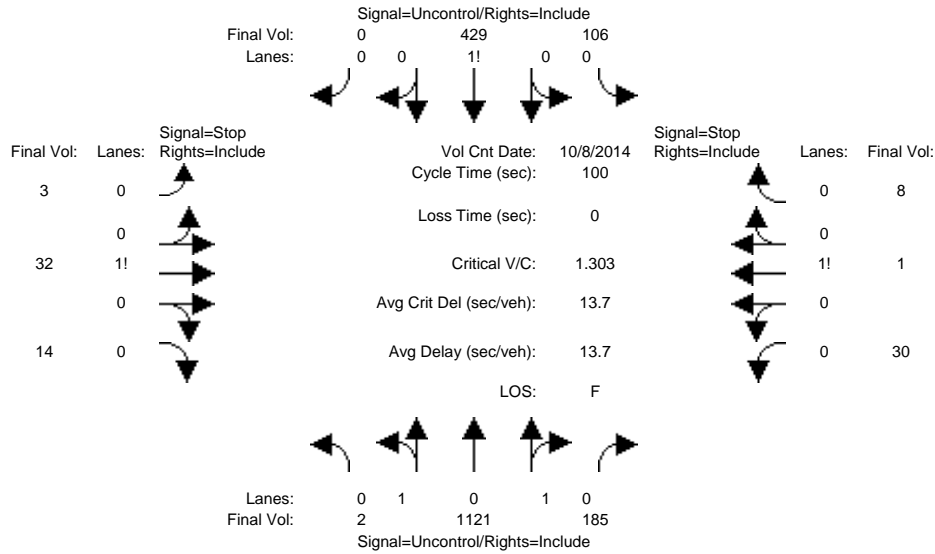

Approach:	North Bound			South Bound			East Bound			West Bound			
Movement:	L	T	R	L	T	R	L	T	R	L	T	R	
Volume Module: >> Count Date: 8 Oct 2014 <<													
Base Vol:	2	1121	185	106	429	0	3	32	14	30	1	8	
Growth Adj:	1.00	1.00	1.00	1.00	1.00	1.00	1.00	1.00	1.00	1.00	1.00	1.00	
Initial Bse:	2	1121	185	106	429	0	3	32	14	30	1	8	
Added Vol:	0	0	0	0	0	0	0	0	0	0	0	0	
PasserByVol:	0	0	0	0	0	0	0	0	0	0	0	0	
Initial Fut:	2	1121	185	106	429	0	3	32	14	30	1	8	
User Adj:	1.00	1.00	1.00	1.00	1.00	1.00	1.00	1.00	1.00	1.00	1.00	1.00	
PHF Adj:	1.00	1.00	1.00	1.00	1.00	1.00	1.00	1.00	1.00	1.00	1.00	1.00	
PHF Volume:	2	1121	185	106	429	0	3	32	14	30	1	8	
Reduct Vol:	0	0	0	0	0	0	0	0	0	0	0	0	
FinalVolume:	2	1121	185	106	429	0	3	32	14	30	1	8	
Critical Gap Module:													
Critical Gp:	4.1	xxxx	xxxxxx	4.1	xxxx	xxxxxx	7.1	6.5	6.2	7.1	6.5	6.2	
FollowUpTim:	2.2	xxxx	xxxxxx	2.2	xxxx	xxxxxx	3.5	4.0	3.3	3.5	4.0	3.3	
Capacity Module:													
Cnflct Vol:	429	xxxx	xxxxxx	1306	xxxx	xxxxxx	1206	1951	429	1882	1859	653	
Potent Cap.:	1141	xxxx	xxxxxx	537	xxxx	xxxxxx	162	65	630	55	74	471	
Move Cap.:	1141	xxxx	xxxxxx	537	xxxx	xxxxxx	132	51	630	23	59	471	
Volume/Cap:	0.00	xxxx	xxxx	0.20	xxxx	xxxx	0.02	0.62	0.02	1.30	0.02	0.02	
Level Of Service Module:													
2Way95thQ:	0.0	xxxx	xxxxxx	0.7	xxxx	xxxxxx	xxxx	xxxx	xxxxxx	xxxx	xxxx	xxxxxx	
Control Del:	8.2	xxxx	xxxxxx	13.4	xxxx	xxxxxx	xxxxxx	xxxx	xxxxxx	xxxxxx	xxxx	xxxxxx	
LOS by Move:	A	*	*	B	*	*	*	*	*	*	*	*	
Movement:	LT	LTR	RT	LT	LTR	RT	LT	LTR	RT	LT	LTR	RT	
Shared Cap.:	xxxx	xxxx	xxxxxx	xxxx	xxxx	xxxxxx	xxxx	73	xxxxxx	xxxx	29	xxxxxx	
SharedQueue:	0.0	xxxx	xxxxxx	0.7	xxxx	xxxxxx	xxxxxx	3.0	xxxxxx	xxxxxx	4.5	xxxxxx	
Shrd ConDel:	8.2	xxxx	xxxxxx	13.4	xxxx	xxxxxx	xxxxxx	122	xxxxxx	xxxxxx	487	xxxxxx	
Shared LOS:	A	*	*	B	*	*	*	F	*	*	F	*	
ApproachDel:	xxxxxx						xxxxxx	122.3			487.0		
ApproachLOS:	*						*	F			F		

Note: Queue reported is the number of cars per lane.

BART Phase II Extension Project

Level Of Service Computation Report
2000 HCM Unsignalized (Future Volume Alternative)
PM - 2035 No Project Conditions

Intersection #1008: Lafayette/Harrison

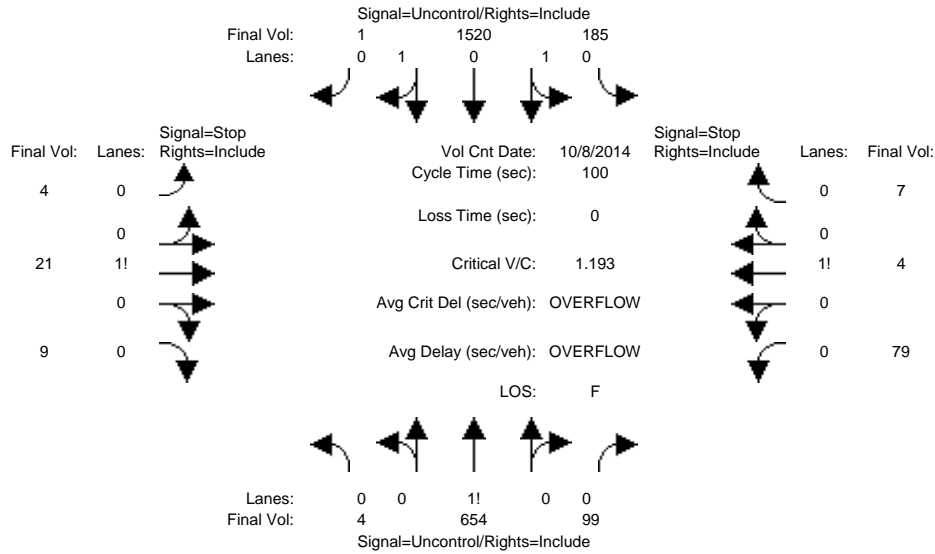

Approach:	North Bound			South Bound			East Bound			West Bound		
Movement:	L	T	R	L	T	R	L	T	R	L	T	R
Volume Module: >> Count Date: 8 Oct 2014 <<												
Base Vol:	4	654	99	185	1520	1	4	21	9	79	4	7
Growth Adj:	1.00	1.00	1.00	1.00	1.00	1.00	1.00	1.00	1.00	1.00	1.00	1.00
Initial Bse:	4	654	99	185	1520	1	4	21	9	79	4	7
Added Vol:	0	0	0	0	0	0	0	0	0	0	0	0
PasserByVol:	0	0	0	0	0	0	0	0	0	0	0	0
Initial Fut:	4	654	99	185	1520	1	4	21	9	79	4	7
User Adj:	1.00	1.00	1.00	1.00	1.00	1.00	1.00	1.00	1.00	1.00	1.00	1.00
PHF Adj:	1.00	1.00	1.00	1.00	1.00	1.00	1.00	1.00	1.00	1.00	1.00	1.00
PHF Volume:	4	654	99	185	1520	1	4	21	9	79	4	7
Reduct Vol:	0	0	0	0	0	0	0	0	0	0	0	0
FinalVolume:	4	654	99	185	1520	1	4	21	9	79	4	7
Critical Gap Module:												
Critical Gp:	4.1	xxxx	xxxxxx	4.1	xxxx	xxxxxx	7.1	6.5	6.2	7.1	6.5	6.2
FollowUpTim:	2.2	xxxx	xxxxxx	2.2	xxxx	xxxxxx	3.5	4.0	3.3	3.5	4.0	3.3
Capacity Module:												
Cnflct Vol:	1521	xxxx	xxxxxx	753	xxxx	xxxxxx	2608	2652	761	1852	2603	704
Potent Cap.:	445	xxxx	xxxxxx	866	xxxx	xxxxxx	17	23	409	58	25	441
Move Cap.:	445	xxxx	xxxxxx	866	xxxx	xxxxxx	11	18	409	0	19	441
Volume/Cap:	0.01	xxxx	xxxx	0.21	xxxx	xxxx	0.36	1.19	0.02	xxxx	0.21	0.02
Level Of Service Module:												
2Way95thQ:	0.0	xxxx	xxxxxx	0.8	xxxx	xxxxxx	xxxx	xxxx	xxxxxx	xxxx	xxxx	xxxxxx
Control Del:	13.2	xxxx	xxxxxx	10.3	xxxx	xxxxxx	xxxxxx	xxxx	xxxxxx	xxxxxx	xxxx	xxxxxx
LOS by Move:	B	*	*	B	*	*	*	*	*	*	*	*
Movement:	LT	LTR	RT	LT	LTR	RT	LT	LTR	RT	LT	LTR	RT
Shared Cap.:	xxxx	xxxx	xxxxxx	xxxx	xxxx	xxxxxx	xxxx	22	xxxxxx	xxxx	0	xxxxxx
SharedQueue:	xxxxxx	xxxx	xxxxxx	0.8	xxxx	xxxxxx	xxxxxx	4.4	xxxxxx	xxxxxx	xxxx	xxxxxx
Shrd ConDel:	xxxxxx	xxxx	xxxxxx	10.3	xxxx	xxxxxx	xxxxxx	668	xxxxxx	xxxxxx	xxxx	xxxxxx
Shared LOS:	*	*	*	B	*	*	*	F	*	*	*	*
ApproachDel:	xxxxxxx			xxxxxxx			667.7			xxxxxxx		
ApproachLOS:	*			*			F			F		

Note: Queue reported is the number of cars per lane.

BART Phase II Extension Project

Level Of Service Computation Report
 2000 HCM Operations (Future Volume Alternative)
 AM - 2035 No Project Conditions

Intersection #1012: El Camino Real/Railroad Ave

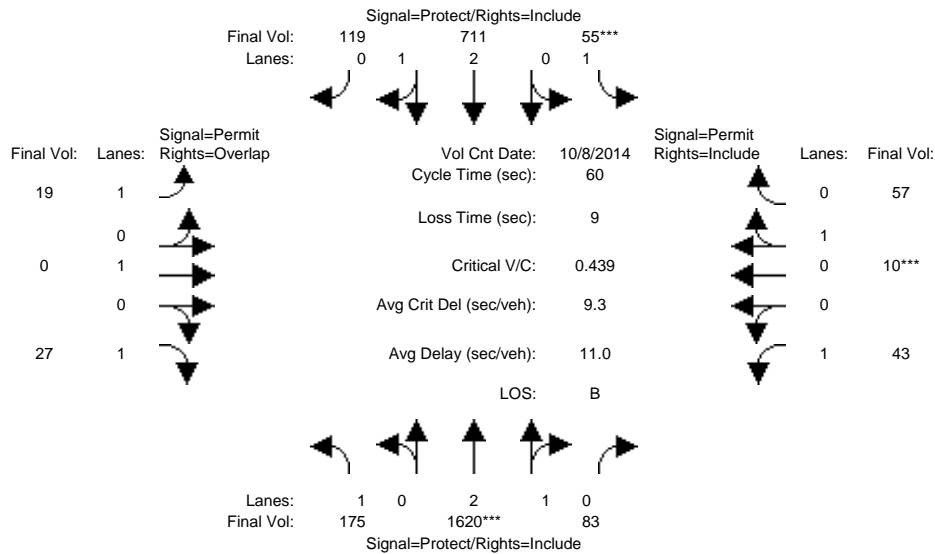

Approach:	North Bound			South Bound			East Bound			West Bound		
	L	T	R	L	T	R	L	T	R	L	T	R
Min. Green:	7	10	10	7	10	10	10	10	10	10	10	10
Y+R:	4.0	4.0	4.0	4.0	4.0	4.0	4.0	4.0	4.0	4.0	4.0	4.0
Volume Module: >> Count Date: 8 Oct 2014 <<												
Base Vol:	175	1620	83	55	711	119	19	0	27	43	10	57
Growth Adj:	1.00	1.00	1.00	1.00	1.00	1.00	1.00	1.00	1.00	1.00	1.00	1.00
Initial Bse:	175	1620	83	55	711	119	19	0	27	43	10	57
Added Vol:	0	0	0	0	0	0	0	0	0	0	0	0
PasserByVol:	0	0	0	0	0	0	0	0	0	0	0	0
Initial Fut:	175	1620	83	55	711	119	19	0	27	43	10	57
User Adj:	1.00	1.00	1.00	1.00	1.00	1.00	1.00	1.00	1.00	1.00	1.00	1.00
PHF Adj:	1.00	1.00	1.00	1.00	1.00	1.00	1.00	1.00	1.00	1.00	1.00	1.00
PHF Volume:	175	1620	83	55	711	119	19	0	27	43	10	57
Reduct Vol:	0	0	0	0	0	0	0	0	0	0	0	0
Reduced Vol:	175	1620	83	55	711	119	19	0	27	43	10	57
PCE Adj:	1.00	1.00	1.00	1.00	1.00	1.00	1.00	1.00	1.00	1.00	1.00	1.00
MLF Adj:	1.00	1.00	1.00	1.00	1.00	1.00	1.00	1.00	1.00	1.00	1.00	1.00
FinalVolume:	175	1620	83	55	711	119	19	0	27	43	10	57
Saturation Flow Module:												
Sat/Lane:	1900	1900	1900	1900	1900	1900	1900	1900	1900	1900	1900	1900
Adjustment:	0.92	0.98	0.95	0.92	0.99	0.95	0.92	1.00	0.92	0.92	0.95	0.95
Lanes:	1.00	2.85	0.15	1.00	2.55	0.45	1.00	1.00	1.00	1.00	0.15	0.85
Final Sat.:	1750	5327	273	1750	4796	803	1750	1900	1750	1750	269	1531
Capacity Analysis Module:												
Vol/Sat:	0.10	0.30	0.30	0.03	0.15	0.15	0.01	0.00	0.02	0.02	0.04	0.04
Crit Moves:	****			****						****		
Green Time:	16.9	34.0	34.0	7.0	24.1	24.1	10.0	0.0	26.9	10.0	10.0	10.0
Volume/Cap:	0.36	0.54	0.54	0.27	0.37	0.37	0.07	0.00	0.03	0.15	0.22	0.22
Delay/Veh:	17.7	8.3	8.3	24.9	12.7	12.7	21.2	0.0	9.3	21.6	22.0	22.0
User DelAdj:	1.00	1.00	1.00	1.00	1.00	1.00	1.00	1.00	1.00	1.00	1.00	1.00
AdjDel/Veh:	17.7	8.3	8.3	24.9	12.7	12.7	21.2	0.0	9.3	21.6	22.0	22.0
LOS by Move:	B	A	A	C	B	B	C	A	A	C	C	C
HCM2k95thQ:	6	14	14	2	7	7	1	0	1	2	3	3

Note: Queue reported is the number of cars per lane.

BART Phase II Extension Project

Level Of Service Computation Report
2000 HCM Operations (Future Volume Alternative)
PM - 2035 No Project Conditions

Intersection #1012: El Camino Real/Railroad Ave

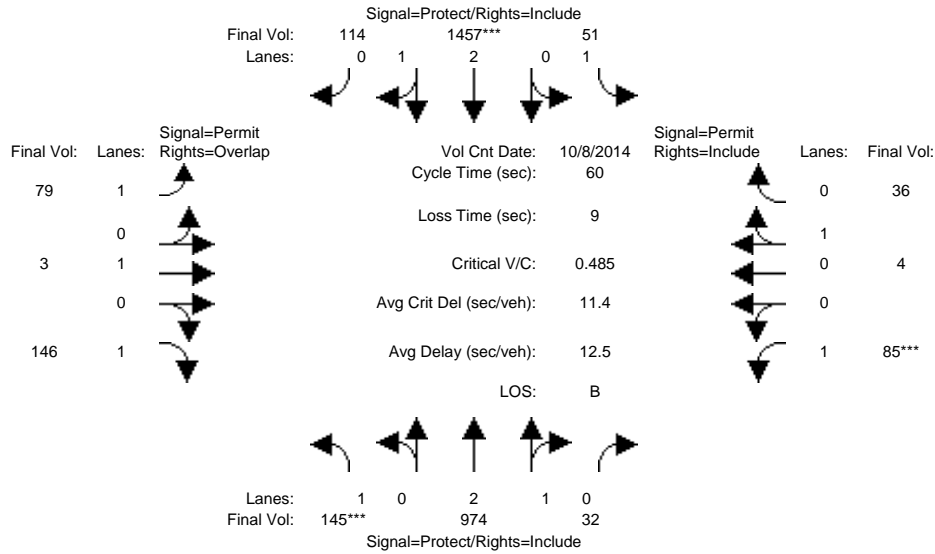

Approach:	North Bound			South Bound			East Bound			West Bound		
Movement:	L	T	R	L	T	R	L	T	R	L	T	R
Min. Green:	7	10	10	7	10	10	10	10	10	10	10	10
Y+R:	4.0	4.0	4.0	4.0	4.0	4.0	4.0	4.0	4.0	4.0	4.0	4.0
Volume Module: >> Count Date: 8 Oct 2014 <<												
Base Vol:	145	974	32	51	1457	114	79	3	146	85	4	36
Growth Adj:	1.00	1.00	1.00	1.00	1.00	1.00	1.00	1.00	1.00	1.00	1.00	1.00
Initial Bse:	145	974	32	51	1457	114	79	3	146	85	4	36
Added Vol:	0	0	0	0	0	0	0	0	0	0	0	0
PasserByVol:	0	0	0	0	0	0	0	0	0	0	0	0
Initial Fut:	145	974	32	51	1457	114	79	3	146	85	4	36
User Adj:	1.00	1.00	1.00	1.00	1.00	1.00	1.00	1.00	1.00	1.00	1.00	1.00
PHF Adj:	1.00	1.00	1.00	1.00	1.00	1.00	1.00	1.00	1.00	1.00	1.00	1.00
PHF Volume:	145	974	32	51	1457	114	79	3	146	85	4	36
Reduct Vol:	0	0	0	0	0	0	0	0	0	0	0	0
Reduced Vol:	145	974	32	51	1457	114	79	3	146	85	4	36
PCE Adj:	1.00	1.00	1.00	1.00	1.00	1.00	1.00	1.00	1.00	1.00	1.00	1.00
MLF Adj:	1.00	1.00	1.00	1.00	1.00	1.00	1.00	1.00	1.00	1.00	1.00	1.00
FinalVolume:	145	974	32	51	1457	114	79	3	146	85	4	36
Saturation Flow Module:												
Sat/Lane:	1900	1900	1900	1900	1900	1900	1900	1900	1900	1900	1900	1900
Adjustment:	0.92	0.98	0.95	0.92	0.99	0.95	0.92	1.00	0.92	0.92	0.95	0.95
Lanes:	1.00	2.90	0.10	1.00	2.77	0.23	1.00	1.00	1.00	1.00	0.10	0.90
Final Sat.:	1750	5422	178	1750	5193	406	1750	1900	1750	1750	180	1620
Capacity Analysis Module:												
Vol/Sat:	0.08	0.18	0.18	0.03	0.28	0.28	0.05	0.00	0.08	0.05	0.02	0.02
Crit Moves:	****				****					****		
Green Time:	9.3	24.9	24.9	16.1	31.7	31.7	10.0	10.0	19.3	10.0	10.0	10.0
Volume/Cap:	0.53	0.43	0.43	0.11	0.53	0.53	0.27	0.01	0.26	0.29	0.13	0.13
Delay/Veh:	25.3	12.7	12.7	16.6	9.5	9.5	22.3	20.9	15.3	22.5	21.5	21.5
User DelAdj:	1.00	1.00	1.00	1.00	1.00	1.00	1.00	1.00	1.00	1.00	1.00	1.00
AdjDel/Veh:	25.3	12.7	12.7	16.6	9.5	9.5	22.3	20.9	15.3	22.5	21.5	21.5
LOS by Move:	C	B	B	B	A	A	C	C	B	C	C	C
HCM2k95thQ:	7	9	9	2	12	12	3	0	5	4	2	2

Note: Queue reported is the number of cars per lane.

BART Phase II Extension Project

Level Of Service Computation Report
2000 HCM Operations (Future Volume Alternative)
AM - 2035 No Project Conditions

Intersection #1202: LAFAYETTE/EL CAMINO REAL

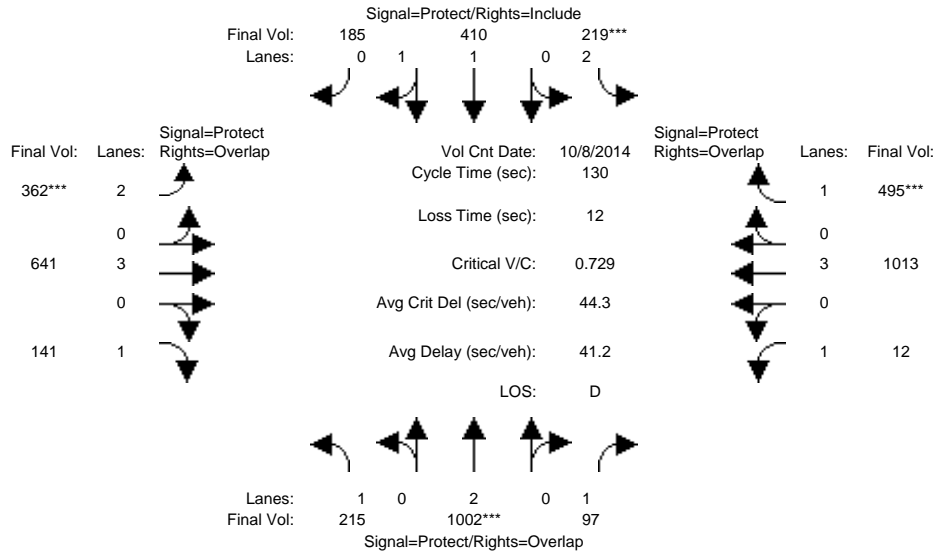

Approach:	North Bound			South Bound			East Bound			West Bound		
Movement:	L	T	R	L	T	R	L	T	R	L	T	R
Min. Green:	7	10	10	7	10	10	7	10	10	7	10	10
Y+R:	4.0	4.0	4.0	4.0	4.0	4.0	4.0	4.0	4.0	4.0	4.0	4.0
Volume Module: >> Count Date: 8 Oct 2014 <<												
Base Vol:	215	1002	97	219	410	185	362	641	141	12	1013	495
Growth Adj:	1.00	1.00	1.00	1.00	1.00	1.00	1.00	1.00	1.00	1.00	1.00	1.00
Initial Bse:	215	1002	97	219	410	185	362	641	141	12	1013	495
Added Vol:	0	0	0	0	0	0	0	0	0	0	0	0
PasserByVol:	0	0	0	0	0	0	0	0	0	0	0	0
Initial Fut:	215	1002	97	219	410	185	362	641	141	12	1013	495
User Adj:	1.00	1.00	1.00	1.00	1.00	1.00	1.00	1.00	1.00	1.00	1.00	1.00
PHF Adj:	1.00	1.00	1.00	1.00	1.00	1.00	1.00	1.00	1.00	1.00	1.00	1.00
PHF Volume:	215	1002	97	219	410	185	362	641	141	12	1013	495
Reduct Vol:	0	0	0	0	0	0	0	0	0	0	0	0
Reduced Vol:	215	1002	97	219	410	185	362	641	141	12	1013	495
PCE Adj:	1.00	1.00	1.00	1.00	1.00	1.00	1.00	1.00	1.00	1.00	1.00	1.00
MLF Adj:	1.00	1.00	1.00	1.00	1.00	1.00	1.00	1.00	1.00	1.00	1.00	1.00
FinalVolume:	215	1002	97	219	410	185	362	641	141	12	1013	495
Saturation Flow Module:												
Sat/Lane:	1900	1900	1900	1900	1900	1900	1900	1900	1900	1900	1900	1900
Adjustment:	0.92	1.00	0.92	0.83	0.99	0.95	0.83	1.00	0.92	0.92	1.00	0.92
Lanes:	1.00	2.00	1.00	2.00	1.36	0.64	2.00	3.00	1.00	1.00	3.00	1.00
Final Sat.:	1750	3800	1750	3150	2549	1150	3150	5700	1750	1750	5700	1750
Capacity Analysis Module:												
Vol/Sat:	0.12	0.26	0.06	0.07	0.16	0.16	0.11	0.11	0.08	0.01	0.18	0.28
Crit Moves:	****			****			****			****		
Green Time:	25.7	47.0	66.0	12.4	33.7	33.7	20.5	39.6	65.3	19.0	38.1	50.5
Volume/Cap:	0.62	0.73	0.11	0.73	0.62	0.62	0.73	0.37	0.16	0.05	0.61	0.73
Delay/Veh:	51.1	38.0	16.7	65.9	43.8	43.8	57.5	35.5	17.6	47.8	40.2	37.9
User DelAdj:	1.00	1.00	1.00	1.00	1.00	1.00	1.00	1.00	1.00	1.00	1.00	1.00
AdjDel/Veh:	51.1	38.0	16.7	65.9	43.8	43.8	57.5	35.5	17.6	47.8	40.2	37.9
LOS by Move:	D	D	B	E	D	D	E	D	B	D	D	D
HCM2k95thQ:	16	30	4	10	19	19	16	12	6	1	22	32

Note: Queue reported is the number of cars per lane.

BART Phase II Extension Project

Level Of Service Computation Report
 2000 HCM Operations (Future Volume Alternative)
 PM - 2035 No Project Conditions

Intersection #1202: LAFAYETTE/EL CAMINO REAL

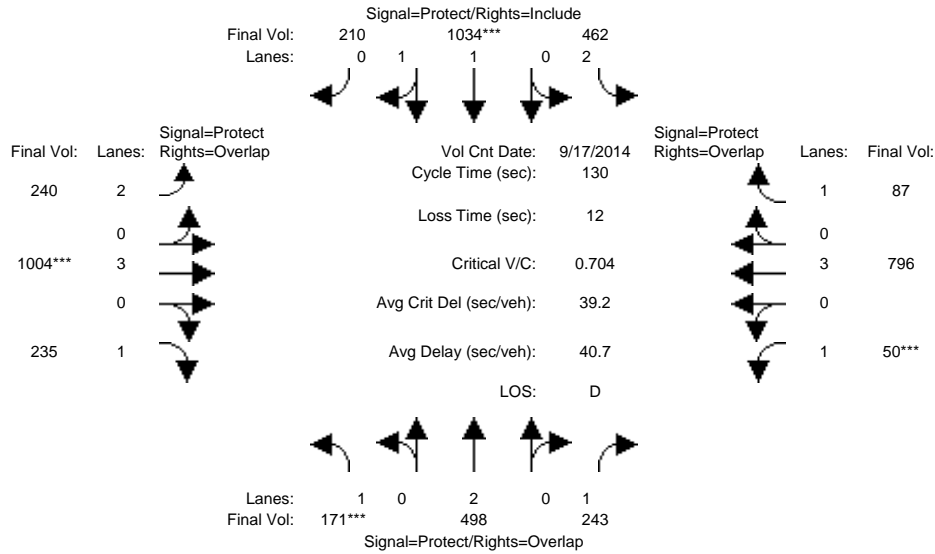

Approach:	North Bound			South Bound			East Bound			West Bound		
	L	T	R	L	T	R	L	T	R	L	T	R
Min. Green:	7	10	10	7	10	10	7	10	10	7	10	10
Y+R:	4.0	4.0	4.0	4.0	4.0	4.0	4.0	4.0	4.0	4.0	4.0	4.0

Volume Module:	>> Count Date: 17 Sep 2014 <<											
Base Vol:	171	498	243	462	1034	210	240	1004	235	50	796	87
Growth Adj:	1.00	1.00	1.00	1.00	1.00	1.00	1.00	1.00	1.00	1.00	1.00	1.00
Initial Bse:	171	498	243	462	1034	210	240	1004	235	50	796	87
Added Vol:	0	0	0	0	0	0	0	0	0	0	0	0
PasserByVol:	0	0	0	0	0	0	0	0	0	0	0	0
Initial Fut:	171	498	243	462	1034	210	240	1004	235	50	796	87
User Adj:	1.00	1.00	1.00	1.00	1.00	1.00	1.00	1.00	1.00	1.00	1.00	1.00
PHF Adj:	1.00	1.00	1.00	1.00	1.00	1.00	1.00	1.00	1.00	1.00	1.00	1.00
PHF Volume:	171	498	243	462	1034	210	240	1004	235	50	796	87
Reduct Vol:	0	0	0	0	0	0	0	0	0	0	0	0
Reduced Vol:	171	498	243	462	1034	210	240	1004	235	50	796	87
PCE Adj:	1.00	1.00	1.00	1.00	1.00	1.00	1.00	1.00	1.00	1.00	1.00	1.00
MLF Adj:	1.00	1.00	1.00	1.00	1.00	1.00	1.00	1.00	1.00	1.00	1.00	1.00
FinalVolume:	171	498	243	462	1034	210	240	1004	235	50	796	87

Saturation Flow Module:												
Sat/Lane:	1900	1900	1900	1900	1900	1900	1900	1900	1900	1900	1900	1900
Adjustment:	0.92	1.00	0.92	0.83	0.98	0.95	0.83	1.00	0.92	0.92	1.00	0.92
Lanes:	1.00	2.00	1.00	2.00	1.65	0.35	2.00	3.00	1.00	1.00	3.00	1.00
Final Sat.:	1750	3800	1750	3150	3075	625	3150	5700	1750	1750	5700	1750

Capacity Analysis Module:												
Vol/Sat:	0.10	0.13	0.14	0.15	0.34	0.34	0.08	0.18	0.13	0.03	0.14	0.05
Crit Moves:	****			****			****			****		
Green Time:	17.8	37.3	44.3	41.7	61.2	61.2	13.8	32.0	49.8	7.0	25.3	67.0
Volume/Cap:	0.71	0.46	0.41	0.46	0.71	0.71	0.72	0.71	0.35	0.53	0.72	0.10
Delay/Veh:	63.5	38.4	33.3	35.5	28.9	28.9	63.6	46.6	28.9	65.6	51.3	16.1
User DelAdj:	1.00	1.00	1.00	1.00	1.00	1.00	1.00	1.00	1.00	1.00	1.00	1.00
AdjDel/Veh:	63.5	38.4	33.3	35.5	28.9	28.9	63.6	46.6	28.9	65.6	51.3	16.1
LOS by Move:	E	D	C	D	C	C	E	D	C	E	D	B
HCM2k95thQ:	14	15	15	16	34	34	11	22	13	6	20	4

Note: Queue reported is the number of cars per lane.

BART Phase II Extension Project

Level Of Service Computation Report
 2000 HCM Operations (Future Volume Alternative)
 AM - 2035 No Project Conditions

Intersection #1204: MONROE/EL CAMINO REAL

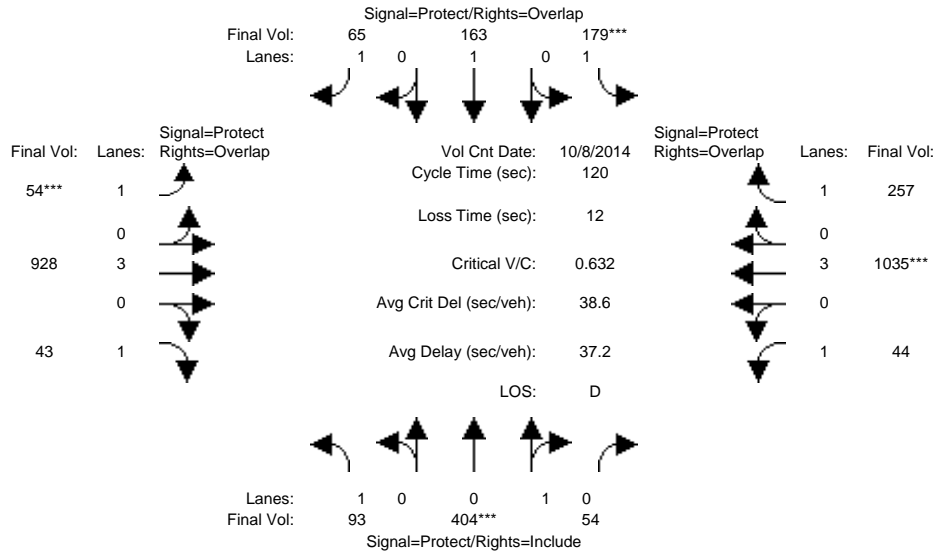

Approach:	North Bound			South Bound			East Bound			West Bound		
Movement:	L	T	R	L	T	R	L	T	R	L	T	R
Min. Green:	7	10	10	7	10	10	7	10	10	7	10	10
Y+R:	4.0	4.0	4.0	4.0	4.0	4.0	4.0	4.0	4.0	4.0	4.0	4.0
Volume Module: >> Count Date: 8 Oct 2014 <<												
Base Vol:	93	404	54	179	163	65	54	928	43	44	1035	257
Growth Adj:	1.00	1.00	1.00	1.00	1.00	1.00	1.00	1.00	1.00	1.00	1.00	1.00
Initial Bse:	93	404	54	179	163	65	54	928	43	44	1035	257
Added Vol:	0	0	0	0	0	0	0	0	0	0	0	0
PasserByVol:	0	0	0	0	0	0	0	0	0	0	0	0
Initial Fut:	93	404	54	179	163	65	54	928	43	44	1035	257
User Adj:	1.00	1.00	1.00	1.00	1.00	1.00	1.00	1.00	1.00	1.00	1.00	1.00
PHF Adj:	1.00	1.00	1.00	1.00	1.00	1.00	1.00	1.00	1.00	1.00	1.00	1.00
PHF Volume:	93	404	54	179	163	65	54	928	43	44	1035	257
Reduct Vol:	0	0	0	0	0	0	0	0	0	0	0	0
Reduced Vol:	93	404	54	179	163	65	54	928	43	44	1035	257
PCE Adj:	1.00	1.00	1.00	1.00	1.00	1.00	1.00	1.00	1.00	1.00	1.00	1.00
MLF Adj:	1.00	1.00	1.00	1.00	1.00	1.00	1.00	1.00	1.00	1.00	1.00	1.00
Final Volume:	93	404	54	179	163	65	54	928	43	44	1035	257
Saturation Flow Module:												
Sat/Lane:	1900	1900	1900	1900	1900	1900	1900	1900	1900	1900	1900	1900
Adjustment:	0.92	0.95	0.95	0.92	1.00	0.92	0.92	1.00	0.92	0.92	1.00	0.92
Lanes:	1.00	0.88	0.12	1.00	1.00	1.00	1.00	3.00	1.00	1.00	3.00	1.00
Final Sat.:	1750	1588	212	1750	1900	1750	1750	5700	1750	1750	5700	1750
Capacity Analysis Module:												
Vol/Sat:	0.05	0.25	0.25	0.10	0.09	0.04	0.03	0.16	0.02	0.03	0.18	0.15
Crit Moves:	****	****	****	****	****	****	****	****	****	****	****	****
Green Time:	27.1	47.7	47.7	19.2	39.8	46.8	7.0	30.2	57.3	10.8	34.1	53.3
Volume/Cap:	0.24	0.64	0.64	0.64	0.26	0.10	0.53	0.65	0.05	0.28	0.64	0.33
Delay/Veh:	38.3	31.1	31.1	52.1	29.5	23.2	60.0	41.1	16.8	51.9	38.5	22.0
User DelAdj:	1.00	1.00	1.00	1.00	1.00	1.00	1.00	1.00	1.00	1.00	1.00	1.00
AdjDel/Veh:	38.3	31.1	31.1	52.1	29.5	23.2	60.0	41.1	16.8	51.9	38.5	22.0
LOS by Move:	D	C	C	D	C	C	E	D	B	D	D	C
HCM2k95thQ:	6	26	26	13	8	3	4	19	2	3	20	12

Note: Queue reported is the number of cars per lane.

BART Phase II Extension Project

Level Of Service Computation Report
 2000 HCM Operations (Future Volume Alternative)
 PM - 2035 No Project Conditions

Intersection #1204: MONROE/EL CAMINO REAL

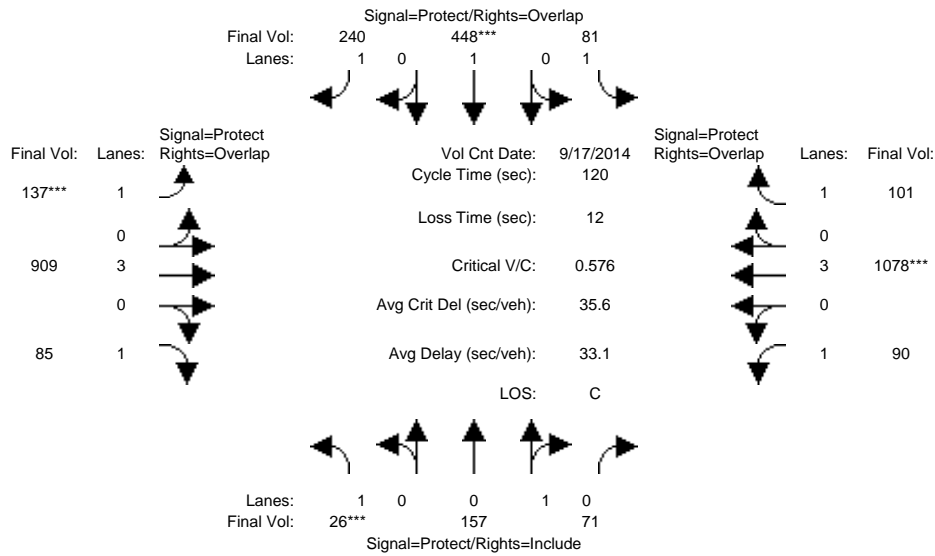

Approach:	North Bound			South Bound			East Bound			West Bound		
	L	T	R	L	T	R	L	T	R	L	T	R
Min. Green:	7	10	10	7	10	10	7	10	10	7	10	10
Y+R:	4.0	4.0	4.0	4.0	4.0	4.0	4.0	4.0	4.0	4.0	4.0	4.0
Volume Module: >> Count Date: 17 Sep 2014 <<												
Base Vol:	26	157	71	81	448	240	137	909	85	90	1078	101
Growth Adj:	1.00	1.00	1.00	1.00	1.00	1.00	1.00	1.00	1.00	1.00	1.00	1.00
Initial Bse:	26	157	71	81	448	240	137	909	85	90	1078	101
Added Vol:	0	0	0	0	0	0	0	0	0	0	0	0
PasserByVol:	0	0	0	0	0	0	0	0	0	0	0	0
Initial Fut:	26	157	71	81	448	240	137	909	85	90	1078	101
User Adj:	1.00	1.00	1.00	1.00	1.00	1.00	1.00	1.00	1.00	1.00	1.00	1.00
PHF Adj:	1.00	1.00	1.00	1.00	1.00	1.00	1.00	1.00	1.00	1.00	1.00	1.00
PHF Volume:	26	157	71	81	448	240	137	909	85	90	1078	101
Reduct Vol:	0	0	0	0	0	0	0	0	0	0	0	0
Reduced Vol:	26	157	71	81	448	240	137	909	85	90	1078	101
PCE Adj:	1.00	1.00	1.00	1.00	1.00	1.00	1.00	1.00	1.00	1.00	1.00	1.00
MLF Adj:	1.00	1.00	1.00	1.00	1.00	1.00	1.00	1.00	1.00	1.00	1.00	1.00
FinalVolume:	26	157	71	81	448	240	137	909	85	90	1078	101
Saturation Flow Module:												
Sat/Lane:	1900	1900	1900	1900	1900	1900	1900	1900	1900	1900	1900	1900
Adjustment:	0.92	0.95	0.95	0.92	1.00	0.92	0.92	1.00	0.92	0.92	1.00	0.92
Lanes:	1.00	0.69	0.31	1.00	1.00	1.00	1.00	3.00	1.00	1.00	3.00	1.00
Final Sat.:	1750	1239	561	1750	1900	1750	1750	5700	1750	1750	5700	1750
Capacity Analysis Module:												
Vol/Sat:	0.01	0.13	0.13	0.05	0.24	0.14	0.08	0.16	0.05	0.05	0.19	0.06
Crit Moves:	****			****			****			****		
Green Time:	7.0	37.2	37.2	17.1	47.3	63.0	15.7	39.3	46.3	14.4	38.0	55.1
Volume/Cap:	0.25	0.41	0.41	0.32	0.60	0.26	0.60	0.49	0.13	0.43	0.60	0.13
Delay/Veh:	55.3	33.2	33.2	47.0	30.1	15.8	53.5	32.5	23.9	50.4	35.1	18.7
User DelAdj:	1.00	1.00	1.00	1.00	1.00	1.00	1.00	1.00	1.00	1.00	1.00	1.00
AdjDel/Veh:	55.3	33.2	33.2	47.0	30.1	15.8	53.5	32.5	23.9	50.4	35.1	18.7
LOS by Move:	E	C	C	D	C	B	D	C	C	D	D	B
HCM2k95thQ:	3	13	13	6	23	10	10	16	4	6	20	4

Note: Queue reported is the number of cars per lane.

BART Phase II Extension Project

Level Of Service Computation Report
 2000 HCM Operations (Future Volume Alternative)
 AM - 2035 No Project Conditions

Intersection #1205: SCOTT/EL CAMINO REAL

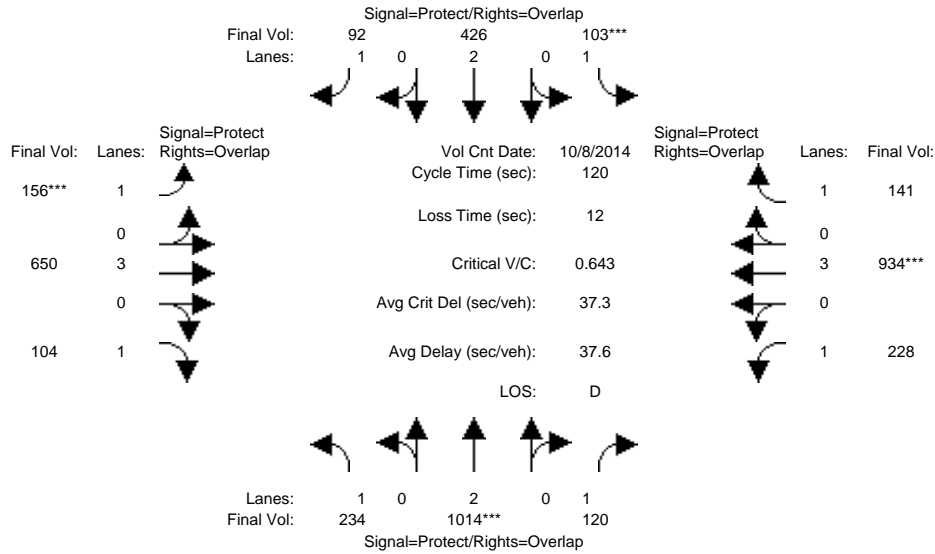

Approach:	North Bound			South Bound			East Bound			West Bound		
	L	T	R	L	T	R	L	T	R	L	T	R
Min. Green:	7	10	10	7	10	10	7	10	10	7	10	10
Y+R:	4.0	4.0	4.0	4.0	4.0	4.0	4.0	4.0	4.0	4.0	4.0	4.0

Volume Module: >> Count Date: 8 Oct 2014 <<

Base Vol:	234	1014	120	103	426	92	156	650	104	228	934	141
Growth Adj:	1.00	1.00	1.00	1.00	1.00	1.00	1.00	1.00	1.00	1.00	1.00	1.00
Initial Bse:	234	1014	120	103	426	92	156	650	104	228	934	141
Added Vol:	0	0	0	0	0	0	0	0	0	0	0	0
PasserByVol:	0	0	0	0	0	0	0	0	0	0	0	0
Initial Fut:	234	1014	120	103	426	92	156	650	104	228	934	141
User Adj:	1.00	1.00	1.00	1.00	1.00	1.00	1.00	1.00	1.00	1.00	1.00	1.00
PHF Adj:	1.00	1.00	1.00	1.00	1.00	1.00	1.00	1.00	1.00	1.00	1.00	1.00
PHF Volume:	234	1014	120	103	426	92	156	650	104	228	934	141
Reduct Vol:	0	0	0	0	0	0	0	0	0	0	0	0
Reduced Vol:	234	1014	120	103	426	92	156	650	104	228	934	141
PCE Adj:	1.00	1.00	1.00	1.00	1.00	1.00	1.00	1.00	1.00	1.00	1.00	1.00
MLF Adj:	1.00	1.00	1.00	1.00	1.00	1.00	1.00	1.00	1.00	1.00	1.00	1.00
FinalVolume:	234	1014	120	103	426	92	156	650	104	228	934	141

Saturation Flow Module:

Sat/Lane:	1900	1900	1900	1900	1900	1900	1900	1900	1900	1900	1900	1900
Adjustment:	0.92	1.00	0.92	0.92	1.00	0.92	0.92	1.00	0.92	0.92	1.00	0.92
Lanes:	1.00	2.00	1.00	1.00	2.00	1.00	1.00	3.00	1.00	1.00	3.00	1.00
Final Sat.:	1750	3800	1750	1750	3800	1750	1750	5700	1750	1750	5700	1750

Capacity Analysis Module:

Vol/Sat:	0.13	0.27	0.07	0.06	0.11	0.05	0.09	0.11	0.06	0.13	0.16	0.08
Crit Moves:	****	****	****	****	****	****	****	****	****	****	****	****
Green Time:	33.1	49.8	75.0	11.0	27.7	44.4	16.6	22.0	55.1	25.2	30.6	41.6
Volume/Cap:	0.49	0.64	0.11	0.64	0.49	0.14	0.64	0.62	0.13	0.62	0.64	0.23
Delay/Veh:	37.1	28.9	9.1	61.2	40.4	25.3	54.7	46.3	18.7	46.3	40.8	28.1
User DelAdj:	1.00	1.00	1.00	1.00	1.00	1.00	1.00	1.00	1.00	1.00	1.00	1.00
AdjDel/Veh:	37.1	28.9	9.1	61.2	40.4	25.3	54.7	46.3	18.7	46.3	40.8	28.1
LOS by Move:	D	C	A	E	D	C	D	D	B	D	D	C
HCM2k95thQ:	14	26	4	8	13	5	12	14	5	15	19	8

Note: Queue reported is the number of cars per lane.

BART Phase II Extension Project

Level Of Service Computation Report
 2000 HCM Operations (Future Volume Alternative)
 PM - 2035 No Project Conditions

Intersection #1205: SCOTT/EL CAMINO REAL

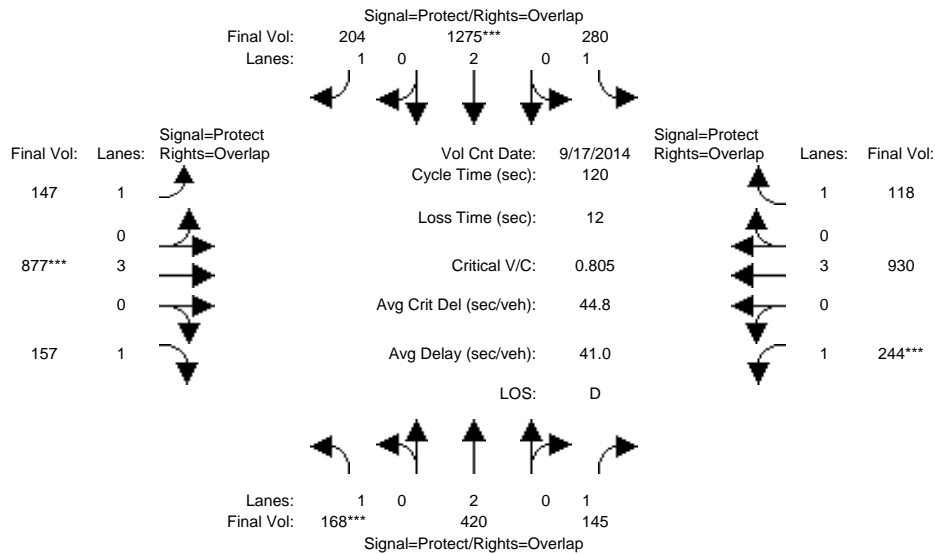

Approach:	North Bound			South Bound			East Bound			West Bound		
	L	T	R	L	T	R	L	T	R	L	T	R
Min. Green:	7	10	10	7	10	10	7	10	10	7	10	10
Y+R:	4.0	4.0	4.0	4.0	4.0	4.0	4.0	4.0	4.0	4.0	4.0	4.0

Volume Module: >> Count Date: 17 Sep 2014 <<

Base Vol:	168	420	145	280	1275	204	147	877	157	244	930	118
Growth Adj:	1.00	1.00	1.00	1.00	1.00	1.00	1.00	1.00	1.00	1.00	1.00	1.00
Initial Bse:	168	420	145	280	1275	204	147	877	157	244	930	118
Added Vol:	0	0	0	0	0	0	0	0	0	0	0	0
PasserByVol:	0	0	0	0	0	0	0	0	0	0	0	0
Initial Fut:	168	420	145	280	1275	204	147	877	157	244	930	118
User Adj:	1.00	1.00	1.00	1.00	1.00	1.00	1.00	1.00	1.00	1.00	1.00	1.00
PHF Adj:	1.00	1.00	1.00	1.00	1.00	1.00	1.00	1.00	1.00	1.00	1.00	1.00
PHF Volume:	168	420	145	280	1275	204	147	877	157	244	930	118
Reduct Vol:	0	0	0	0	0	0	0	0	0	0	0	0
Reduced Vol:	168	420	145	280	1275	204	147	877	157	244	930	118
PCE Adj:	1.00	1.00	1.00	1.00	1.00	1.00	1.00	1.00	1.00	1.00	1.00	1.00
MLF Adj:	1.00	1.00	1.00	1.00	1.00	1.00	1.00	1.00	1.00	1.00	1.00	1.00
FinalVolume:	168	420	145	280	1275	204	147	877	157	244	930	118

Saturation Flow Module:

Sat/Lane:	1900	1900	1900	1900	1900	1900	1900	1900	1900	1900	1900	1900
Adjustment:	0.92	1.00	0.92	0.92	1.00	0.92	0.92	1.00	0.92	0.92	1.00	0.92
Lanes:	1.00	2.00	1.00	1.00	2.00	1.00	1.00	3.00	1.00	1.00	3.00	1.00
Final Sat.:	1750	3800	1750	1750	3800	1750	1750	5700	1750	1750	5700	1750

Capacity Analysis Module:

Vol/Sat:	0.10	0.11	0.08	0.16	0.34	0.12	0.08	0.15	0.09	0.14	0.16	0.07
Crit Moves:	****				****			****			****	
Green Time:	14.3	26.3	47.0	38.0	50.0	64.8	14.9	22.9	37.2	20.8	28.8	66.9
Volume/Cap:	0.81	0.50	0.21	0.50	0.81	0.22	0.68	0.81	0.29	0.81	0.68	0.12
Delay/Veh:	71.5	41.7	24.3	34.1	33.9	14.5	58.7	50.9	31.7	62.2	42.8	12.7
User DelAdj:	1.00	1.00	1.00	1.00	1.00	1.00	1.00	1.00	1.00	1.00	1.00	1.00
AdjDel/Veh:	71.5	41.7	24.3	34.1	33.9	14.5	58.7	50.9	31.7	62.2	42.8	12.7
LOS by Move:	E	D	C	C	C	B	E	D	C	E	D	B
HCM2k95thQ:	13	13	7	17	36	8	11	20	9	18	19	4

Note: Queue reported is the number of cars per lane.

BART Phase II Extension Project

Level Of Service Computation Report
 2000 HCM Operations (Future Volume Alternative)
 AM - 2035 No Project Conditions

Intersection #1213: THE ALAMEDA/EL CAMINO REAL

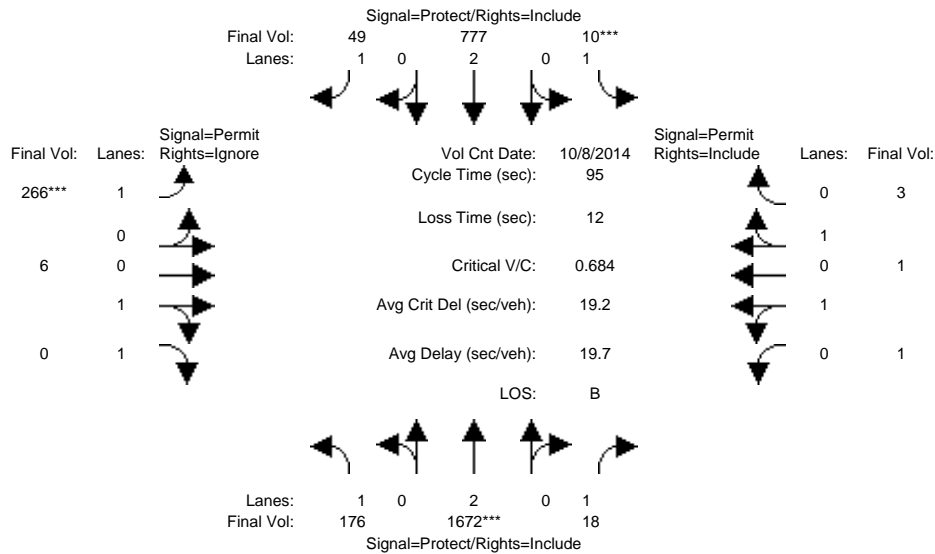

Approach:	North Bound			South Bound			East Bound			West Bound		
	L	T	R	L	T	R	L	T	R	L	T	R
Min. Green:	7	10	10	7	10	10	7	10	10	7	10	10
Y+R:	4.0	4.0	4.0	4.0	4.0	4.0	4.0	4.0	4.0	4.0	4.0	4.0

Volume Module:	>>	Count	Date:	8 Oct 2014	<<											
Base Vol:	176	1672	18	10	777	49	266	6	243	1	1	3				
Growth Adj:	1.00	1.00	1.00	1.00	1.00	1.00	1.00	1.00	1.00	1.00	1.00	1.00				
Initial Bse:	176	1672	18	10	777	49	266	6	243	1	1	3				
Added Vol:	0	0	0	0	0	0	0	0	0	0	0	0				
PasserByVol:	0	0	0	0	0	0	0	0	0	0	0	0				
Initial Fut:	176	1672	18	10	777	49	266	6	243	1	1	3				
User Adj:	1.00	1.00	1.00	1.00	1.00	1.00	1.00	1.00	0.00	1.00	1.00	1.00				
PHF Adj:	1.00	1.00	1.00	1.00	1.00	1.00	1.00	1.00	0.00	1.00	1.00	1.00				
PHF Volume:	176	1672	18	10	777	49	266	6	0	1	1	3				
Reduct Vol:	0	0	0	0	0	0	0	0	0	0	0	0				
Reduced Vol:	176	1672	18	10	777	49	266	6	0	1	1	3				
PCE Adj:	1.00	1.00	1.00	1.00	1.00	1.00	1.00	1.00	0.00	1.00	1.00	1.00				
MLF Adj:	1.00	1.00	1.00	1.00	1.00	1.00	1.00	1.00	0.00	1.00	1.00	1.00				
FinalVolume:	176	1672	18	10	777	49	266	6	0	1	1	3				

Saturation Flow Module:												
Sat/Lane:	1900	1900	1900	1900	1900	1900	1900	1900	1900	1900	1900	1900
Adjustment:	0.92	1.00	0.92	0.92	1.00	0.92	0.92	0.95	0.92	0.95	0.95	0.95
Lanes:	1.00	2.00	1.00	1.00	2.00	1.00	1.00	1.00	1.00	0.50	0.50	1.00
Final Sat.:	1750	3800	1750	1750	3800	1750	1750	1800	1750	900	900	1800

Capacity Analysis Module:												
Vol/Sat:	0.10	0.44	0.01	0.01	0.20	0.03	0.15	0.00	0.00	0.00	0.00	0.00
Crit Moves:	****			****			****					
Green Time:	20.9	56.5	56.5	7.0	42.6	42.6	19.5	19.5	0.0	19.5	19.5	19.5
Volume/Cap:	0.46	0.74	0.02	0.08	0.46	0.06	0.74	0.02	0.00	0.01	0.01	0.01
Delay/Veh:	33.0	15.3	7.9	41.3	18.4	14.9	43.3	30.1	0.0	30.0	30.0	30.0
User DelAdj:	1.00	1.00	1.00	1.00	1.00	1.00	1.00	1.00	1.00	1.00	1.00	1.00
AdjDel/Veh:	33.0	15.3	7.9	41.3	18.4	14.9	43.3	30.1	0.0	30.0	30.0	30.0
LOS by Move:	C	B	A	D	B	B	D	C	A	C	C	C
HCM2k95thQ:	9	30	0	1	15	2	18	0	0	0	0	0

Note: Queue reported is the number of cars per lane.

BART Phase II Extension Project

Level Of Service Computation Report
 2000 HCM Operations (Future Volume Alternative)
 PM - 2035 No Project Conditions

Intersection #1213: THE ALAMEDA/EL CAMINO REAL

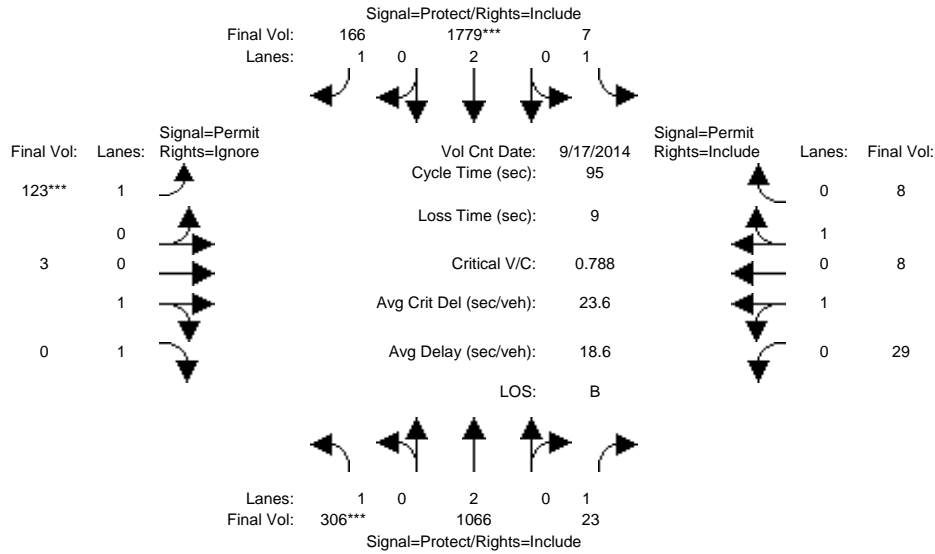

Approach:	North Bound			South Bound			East Bound			West Bound		
Movement:	L	T	R	L	T	R	L	T	R	L	T	R
Min. Green:	7	10	10	7	10	10	10	10	10	10	10	10
Y+R:	4.0	4.0	4.0	4.0	4.0	4.0	4.0	4.0	4.0	4.0	4.0	4.0
Volume Module: >> Count Date: 17 Sep 2014 <<												
Base Vol:	306	1066	23	7	1779	166	123	3	281	29	8	8
Growth Adj:	1.00	1.00	1.00	1.00	1.00	1.00	1.00	1.00	1.00	1.00	1.00	1.00
Initial Bse:	306	1066	23	7	1779	166	123	3	281	29	8	8
Added Vol:	0	0	0	0	0	0	0	0	0	0	0	0
PasserByVol:	0	0	0	0	0	0	0	0	0	0	0	0
Initial Fut:	306	1066	23	7	1779	166	123	3	281	29	8	8
User Adj:	1.00	1.00	1.00	1.00	1.00	1.00	1.00	1.00	0.00	1.00	1.00	1.00
PHF Adj:	1.00	1.00	1.00	1.00	1.00	1.00	1.00	1.00	0.00	1.00	1.00	1.00
PHF Volume:	306	1066	23	7	1779	166	123	3	0	29	8	8
Reduct Vol:	0	0	0	0	0	0	0	0	0	0	0	0
Reduced Vol:	306	1066	23	7	1779	166	123	3	0	29	8	8
PCE Adj:	1.00	1.00	1.00	1.00	1.00	1.00	1.00	1.00	0.00	1.00	1.00	1.00
MLF Adj:	1.00	1.00	1.00	1.00	1.00	1.00	1.00	1.00	0.00	1.00	1.00	1.00
Final Volume:	306	1066	23	7	1779	166	123	3	0	29	8	8
Saturation Flow Module:												
Sat/Lane:	1900	1900	1900	1900	1900	1900	1900	1900	1900	1900	1900	1900
Adjustment:	0.92	1.00	0.92	0.92	1.00	0.92	0.92	0.95	0.92	0.95	0.95	0.95
Lanes:	1.00	2.00	1.00	1.00	2.00	1.00	1.00	1.00	1.00	1.00	0.50	0.50
Final Sat.:	1750	3800	1750	1750	3800	1750	1750	1800	1750	1800	900	900
Capacity Analysis Module:												
Vol/Sat:	0.17	0.28	0.01	0.00	0.47	0.09	0.07	0.00	0.00	0.02	0.01	0.01
Crit Moves:	****				****		****					
Green Time:	20.7	60.2	60.2	15.8	55.3	55.3	10.0	10.0	0.0	10.0	10.0	10.0
Volume/Cap:	0.80	0.44	0.02	0.02	0.80	0.16	0.67	0.02	0.00	0.15	0.08	0.08
Delay/Veh:	47.0	9.0	6.5	33.2	17.8	9.2	49.9	38.1	0.0	38.9	38.4	38.4
User DelAdj:	1.00	1.00	1.00	1.00	1.00	1.00	1.00	1.00	1.00	1.00	1.00	1.00
AdjDel/Veh:	47.0	9.0	6.5	33.2	17.8	9.2	49.9	38.1	0.0	38.9	38.4	38.4
LOS by Move:	D	A	A	C	B	A	D	D	A	D	D	D
HCM2k95thQ:	17	14	1	0	37	5	10	0	0	2	1	1

Note: Queue reported is the number of cars per lane.

BART Phase II Extension Project

Level Of Service Computation Report
 2000 HCM Operations (Future Volume Alternative)
 AM - 2035 No Project Conditions

Intersection #3411: AVIATION/COLEMAN

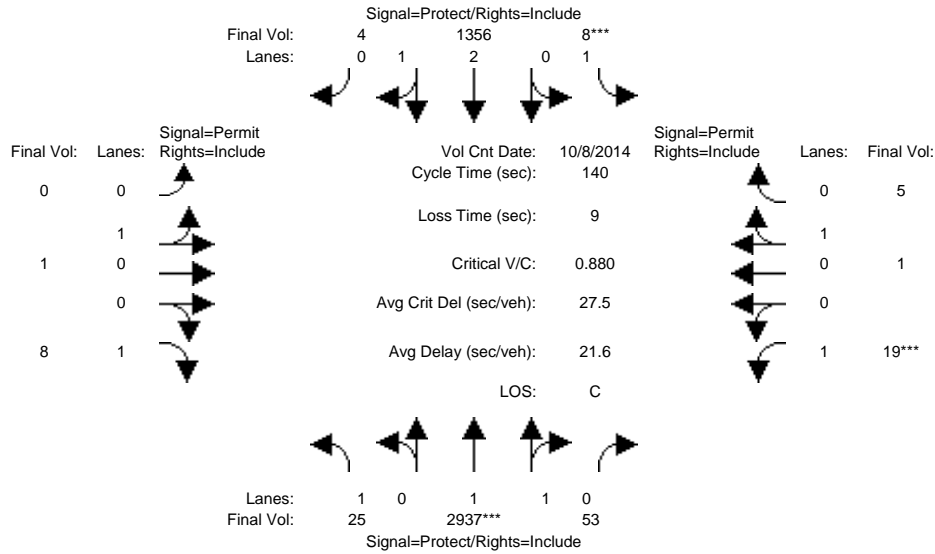

Approach:	North Bound			South Bound			East Bound			West Bound		
	L	T	R	L	T	R	L	T	R	L	T	R
Min. Green:	7	10	10	7	10	10	10	10	10	10	10	10
Y+R:	4.0	4.0	4.0	4.0	4.0	4.0	4.0	4.0	4.0	4.0	4.0	4.0

Volume Module:	>>	Count	Date:	8 Oct 2014	<<											
Base Vol:	25	2937	53	8	1356	4	0	1	8	19	1	5				
Growth Adj:	1.00	1.00	1.00	1.00	1.00	1.00	1.00	1.00	1.00	1.00	1.00	1.00				
Initial Bse:	25	2937	53	8	1356	4	0	1	8	19	1	5				
Added Vol:	0	0	0	0	0	0	0	0	0	0	0	0				
PasserByVol:	0	0	0	0	0	0	0	0	0	0	0	0				
Initial Fut:	25	2937	53	8	1356	4	0	1	8	19	1	5				
User Adj:	1.00	1.00	1.00	1.00	1.00	1.00	1.00	1.00	1.00	1.00	1.00	1.00				
PHF Adj:	1.00	1.00	1.00	1.00	1.00	1.00	1.00	1.00	1.00	1.00	1.00	1.00				
PHF Volume:	25	2937	53	8	1356	4	0	1	8	19	1	5				
Reduct Vol:	0	0	0	0	0	0	0	0	0	0	0	0				
Reduced Vol:	25	2937	53	8	1356	4	0	1	8	19	1	5				
PCE Adj:	1.00	1.00	1.00	1.00	1.00	1.00	1.00	1.00	1.00	1.00	1.00	1.00				
MLF Adj:	1.00	1.00	1.00	1.00	1.00	1.00	1.00	1.00	1.00	1.00	1.00	1.00				
FinalVolume:	25	2937	53	8	1356	4	0	1	8	19	1	5				

Saturation Flow Module:												
Sat/Lane:	1900	1900	1900	1900	1900	1900	1900	1900	1900	1900	1900	1900
Adjustment:	0.92	0.97	0.95	0.92	0.98	0.95	0.95	0.95	0.92	0.92	0.95	0.95
Lanes:	1.00	1.96	0.04	1.00	2.99	0.01	0.00	1.00	1.00	1.00	0.17	0.83
Final Sat.:	1750	3634	66	1750	5584	16	0	1800	1750	1750	300	1500

Capacity Analysis Module:												
Vol/Sat:	0.01	0.81	0.81	0.00	0.24	0.24	0.00	0.00	0.00	0.01	0.00	0.00
Crit Moves:	****			****						****		
Green Time:	20.7	114	114.0	7.0	100	100.3	0.0	10.0	10.0	10.0	10.0	10.0
Volume/Cap:	0.10	0.99	0.99	0.09	0.34	0.34	0.00	0.01	0.06	0.15	0.05	0.05
Delay/Veh:	51.8	27.2	27.2	63.9	7.5	7.5	0.0	60.4	60.9	61.6	60.7	60.7
User DelAdj:	1.00	1.00	1.00	1.00	1.00	1.00	1.00	1.00	1.00	1.00	1.00	1.00
AdjDel/Veh:	51.8	27.2	27.2	63.9	7.5	7.5	0.0	60.4	60.9	61.6	60.7	60.7
LOS by Move:	D	C	C	E	A	A	A	E	E	E	E	E
HCM2k95thQ:	2	104	104	1	14	14	0	0	1	2	1	1

Note: Queue reported is the number of cars per lane.

BART Phase II Extension Project

Level Of Service Computation Report
 2000 HCM Operations (Future Volume Alternative)
 PM - 2035 No Project Conditions

Intersection #3411: AVIATION/COLEMAN

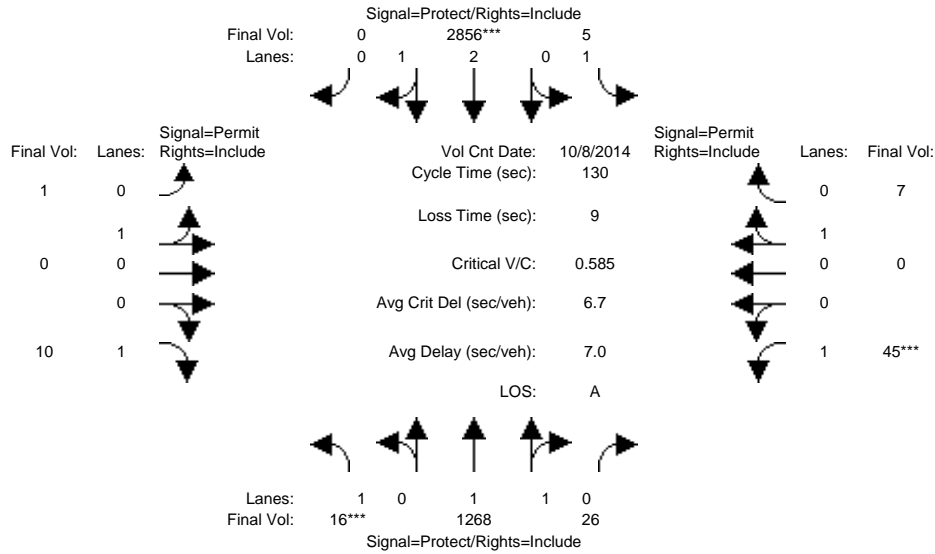

Approach:	North Bound			South Bound			East Bound			West Bound		
	L	T	R	L	T	R	L	T	R	L	T	R
Min. Green:	7	10	10	7	10	10	10	10	10	10	10	10
Y+R:	4.0	4.0	4.0	4.0	4.0	4.0	4.0	4.0	4.0	4.0	4.0	4.0
Volume Module: >> Count Date: 8 Oct 2014 <<												
Base Vol:	16	1268	26	5	2856	0	1	0	10	45	0	7
Growth Adj:	1.00	1.00	1.00	1.00	1.00	1.00	1.00	1.00	1.00	1.00	1.00	1.00
Initial Bse:	16	1268	26	5	2856	0	1	0	10	45	0	7
Added Vol:	0	0	0	0	0	0	0	0	0	0	0	0
PasserByVol:	0	0	0	0	0	0	0	0	0	0	0	0
Initial Fut:	16	1268	26	5	2856	0	1	0	10	45	0	7
User Adj:	1.00	1.00	1.00	1.00	1.00	1.00	1.00	1.00	1.00	1.00	1.00	1.00
PHF Adj:	1.00	1.00	1.00	1.00	1.00	1.00	1.00	1.00	1.00	1.00	1.00	1.00
PHF Volume:	16	1268	26	5	2856	0	1	0	10	45	0	7
Reduct Vol:	0	0	0	0	0	0	0	0	0	0	0	0
Reduced Vol:	16	1268	26	5	2856	0	1	0	10	45	0	7
PCE Adj:	1.00	1.00	1.00	1.00	1.00	1.00	1.00	1.00	1.00	1.00	1.00	1.00
MLF Adj:	1.00	1.00	1.00	1.00	1.00	1.00	1.00	1.00	1.00	1.00	1.00	1.00
FinalVolume:	16	1268	26	5	2856	0	1	0	10	45	0	7
Saturation Flow Module:												
Sat/Lane:	1900	1900	1900	1900	1900	1900	1900	1900	1900	1900	1900	1900
Adjustment:	0.92	0.97	0.95	0.92	0.98	0.92	0.95	0.95	0.92	0.92	1.00	0.95
Lanes:	1.00	1.96	0.04	1.00	3.00	0.00	1.00	0.00	1.00	1.00	0.00	1.00
Final Sat.:	1750	3626	74	1750	5600	0	1800	0	1750	1750	0	1800
Capacity Analysis Module:												
Vol/Sat:	0.01	0.35	0.35	0.00	0.51	0.00	0.00	0.00	0.01	0.03	0.00	0.00
Crit Moves:	****				****					****		
Green Time:	7.0	96.2	96.2	14.8	104	0.0	10.0	0.0	10.0	10.0	0.0	10.0
Volume/Cap:	0.17	0.47	0.47	0.03	0.64	0.00	0.01	0.00	0.07	0.33	0.00	0.05
Delay/Veh:	59.6	6.9	6.9	51.2	5.6	0.0	55.4	0.0	55.9	58.3	0.0	55.8
User DelAdj:	1.00	1.00	1.00	1.00	1.00	1.00	1.00	1.00	1.00	1.00	1.00	1.00
AdjDel/Veh:	59.6	6.9	6.9	51.2	5.6	0.0	55.4	0.0	55.9	58.3	0.0	55.8
LOS by Move:	E	A	A	D	A	A	E	A	E	E	A	E
HCM2k95thQ:	1	19	19	0	26	0	0	0	1	4	0	1

Note: Queue reported is the number of cars per lane.

BART Phase II Extension Project

Level Of Service Computation Report
 2000 HCM Operations (Future Volume Alternative)
 AM - 2035 No Project Conditions

Intersection #4047: COLEMAN/NEWHALL

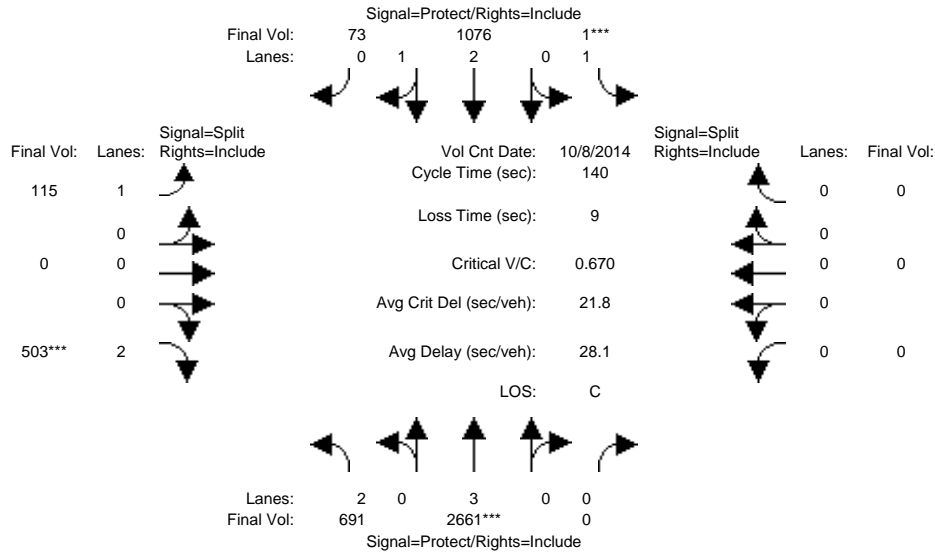

Approach:	North Bound			South Bound			East Bound			West Bound		
Movement:	L	T	R	L	T	R	L	T	R	L	T	R
Min. Green:	7	10	0	7	10	10	10	0	10	0	0	0
Y+R:	4.0	4.0	4.0	4.0	4.0	4.0	4.0	4.0	4.0	4.0	4.0	4.0
Volume Module: >> Count Date: 8 Oct 2014 <<												
Base Vol:	691	2661	0	1	1076	73	115	0	503	0	0	0
Growth Adj:	1.00	1.00	1.00	1.00	1.00	1.00	1.00	1.00	1.00	1.00	1.00	1.00
Initial Bse:	691	2661	0	1	1076	73	115	0	503	0	0	0
Added Vol:	0	0	0	0	0	0	0	0	0	0	0	0
PasserByVol:	0	0	0	0	0	0	0	0	0	0	0	0
Initial Fut:	691	2661	0	1	1076	73	115	0	503	0	0	0
User Adj:	1.00	1.00	1.00	1.00	1.00	1.00	1.00	1.00	1.00	1.00	1.00	1.00
PHF Adj:	1.00	1.00	1.00	1.00	1.00	1.00	1.00	1.00	1.00	1.00	1.00	1.00
PHF Volume:	691	2661	0	1	1076	73	115	0	503	0	0	0
Reduct Vol:	0	0	0	0	0	0	0	0	0	0	0	0
Reduced Vol:	691	2661	0	1	1076	73	115	0	503	0	0	0
PCE Adj:	1.00	1.00	1.00	1.00	1.00	1.00	1.00	1.00	1.00	1.00	1.00	1.00
MLF Adj:	1.00	1.00	1.00	1.00	1.00	1.00	1.00	1.00	1.00	1.00	1.00	1.00
Final Volume:	691	2661	0	1	1076	73	115	0	503	0	0	0
Saturation Flow Module:												
Sat/Lane:	1900	1900	1900	1900	1900	1900	1900	1900	1900	1900	1900	1900
Adjustment:	0.83	1.00	0.92	0.92	0.98	0.95	0.92	1.00	0.83	0.92	1.00	0.92
Lanes:	2.00	3.00	0.00	1.00	2.80	0.20	1.00	0.00	2.00	0.00	0.00	0.00
Final Sat.:	3150	5700	0	1750	5244	356	1750	0	3150	0	0	0
Capacity Analysis Module:												
Vol/Sat:	0.22	0.47	0.00	0.00	0.21	0.21	0.07	0.00	0.16	0.00	0.00	0.00
Crit Moves:	****			****			****			****		
Green Time:	51.4	92.4	0.0	7.0	48.0	48.0	31.6	0.0	31.6	0.0	0.0	0.0
Volume/Cap:	0.60	0.71	0.00	0.01	0.60	0.60	0.29	0.00	0.71	0.00	0.00	0.00
Delay/Veh:	36.8	15.8	0.0	63.3	38.5	38.5	45.3	0.0	53.2	0.0	0.0	0.0
User DelAdj:	1.00	1.00	1.00	1.00	1.00	1.00	1.00	1.00	1.00	1.00	1.00	1.00
AdjDel/Veh:	36.8	15.8	0.0	63.3	38.5	38.5	45.3	0.0	53.2	0.0	0.0	0.0
LOS by Move:	D	B	A	E	D	D	D	A	D	A	A	A
HCM2k95thQ:	26	40	0	0	24	24	9	0	23	0	0	0

Note: Queue reported is the number of cars per lane.

BART Phase II Extension Project

Level Of Service Computation Report
 2000 HCM Operations (Future Volume Alternative)
 PM - 2035 No Project Conditions

Intersection #4047: COLEMAN/NEWHALL

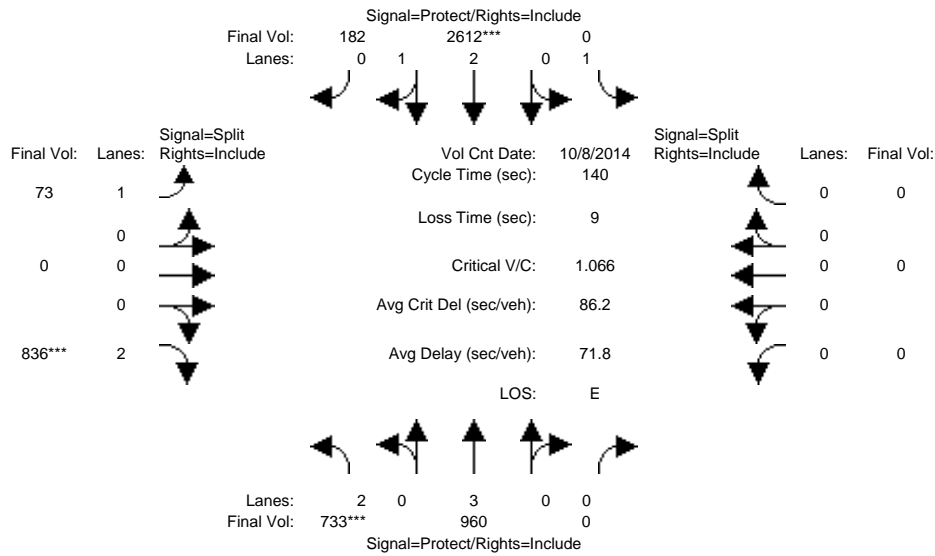

Approach:	North Bound			South Bound			East Bound			West Bound		
	L	T	R	L	T	R	L	T	R	L	T	R
Min. Green:	7	10	0	7	10	10	10	0	10	0	0	0
Y+R:	4.0	4.0	4.0	4.0	4.0	4.0	4.0	4.0	4.0	4.0	4.0	4.0
Volume Module: >> Count Date: 8 Oct 2014 <<												
Base Vol:	733	960	0	0	2612	182	73	0	836	0	0	0
Growth Adj:	1.00	1.00	1.00	1.00	1.00	1.00	1.00	1.00	1.00	1.00	1.00	1.00
Initial Bse:	733	960	0	0	2612	182	73	0	836	0	0	0
Added Vol:	0	0	0	0	0	0	0	0	0	0	0	0
PasserByVol:	0	0	0	0	0	0	0	0	0	0	0	0
Initial Fut:	733	960	0	0	2612	182	73	0	836	0	0	0
User Adj:	1.00	1.00	1.00	1.00	1.00	1.00	1.00	1.00	1.00	1.00	1.00	1.00
PHF Adj:	1.00	1.00	1.00	1.00	1.00	1.00	1.00	1.00	1.00	1.00	1.00	1.00
PHF Volume:	733	960	0	0	2612	182	73	0	836	0	0	0
Reduct Vol:	0	0	0	0	0	0	0	0	0	0	0	0
Reduced Vol:	733	960	0	0	2612	182	73	0	836	0	0	0
PCE Adj:	1.00	1.00	1.00	1.00	1.00	1.00	1.00	1.00	1.00	1.00	1.00	1.00
MLF Adj:	1.00	1.00	1.00	1.00	1.00	1.00	1.00	1.00	1.00	1.00	1.00	1.00
Final Volume:	733	960	0	0	2612	182	73	0	836	0	0	0
Saturation Flow Module:												
Sat/Lane:	1900	1900	1900	1900	1900	1900	1900	1900	1900	1900	1900	1900
Adjustment:	0.83	1.00	0.92	0.92	0.98	0.95	0.92	1.00	0.83	0.92	1.00	0.92
Lanes:	2.00	3.00	0.00	1.00	2.80	0.20	1.00	0.00	2.00	0.00	0.00	0.00
Final Sat.:	3150	5700	0	1750	5235	365	1750	0	3150	0	0	0
Capacity Analysis Module:												
Vol/Sat:	0.23	0.17	0.00	0.00	0.50	0.50	0.04	0.00	0.27	0.00	0.00	0.00
Crit Moves:	****				****				****			
Green Time:	30.6	96.1	0.0	0.0	65.6	65.6	34.9	0.0	34.9	0.0	0.0	0.0
Volume/Cap:	1.07	0.25	0.00	0.00	1.07	1.07	0.17	0.00	1.07	0.00	0.00	0.00
Delay/Veh:	107.8	8.3	0.0	0.0	75.4	75.4	41.4	0.0	103.6	0.0	0.0	0.0
User DelAdj:	1.00	1.00	1.00	1.00	1.00	1.00	1.00	1.00	1.00	1.00	1.00	1.00
AdjDel/Veh:	107.8	8.3	0.0	0.0	75.4	75.4	41.4	0.0	103.6	0.0	0.0	0.0
LOS by Move:	F	A	A	A	E	E	D	A	F	A	A	A
HCM2k95thQ:	43	10	0	0	77	77	5	0	48	0	0	0

Note: Queue reported is the number of cars per lane.

BART Phase II Extension Project

Level Of Service Computation Report
 2000 HCM Operations (Future Volume Alternative)
 AM - 2035 No Project Conditions

Intersection #5335: CENTRAL EXPWY/DE LA CRUZ BLVD

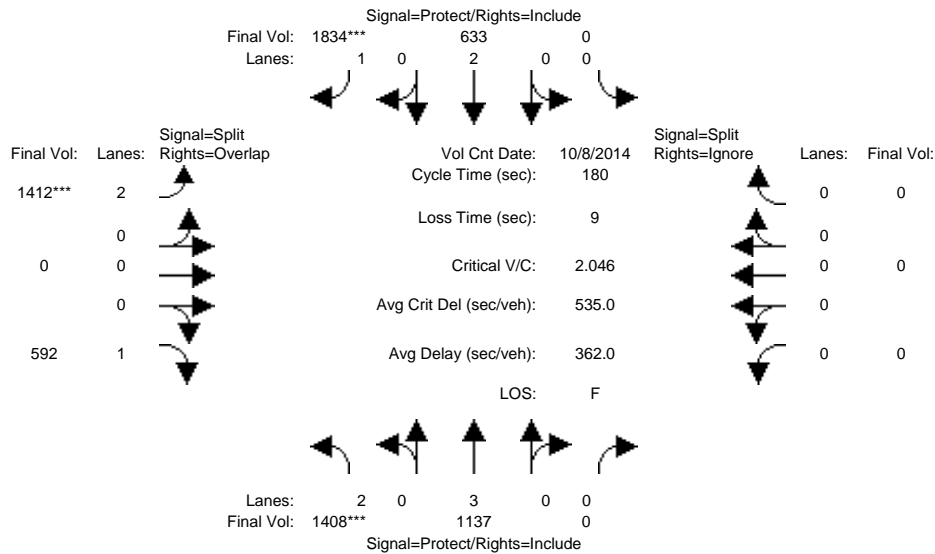

Approach:	North Bound			South Bound			East Bound			West Bound		
	L	T	R	L	T	R	L	T	R	L	T	R
Min. Green:	7	10	0	0	10	10	10	0	10	0	0	0
Y+R:	4.0	4.0	4.0	4.0	4.0	4.0	4.0	4.0	4.0	4.0	4.0	4.0

Volume Module:	>>	Count	Date:	8 Oct 2014	<<							
Base Vol:	1408	1137	0	0	633	1834	1623	0	592	0	0	0
Growth Adj:	1.00	1.00	1.00	1.00	1.00	1.00	1.00	1.00	1.00	1.00	1.00	1.00
Initial Bse:	1408	1137	0	0	633	1834	1623	0	592	0	0	0
Added Vol:	0	0	0	0	0	0	0	0	0	0	0	0
PasserByVol:	0	0	0	0	0	0	0	0	0	0	0	0
Initial Fut:	1408	1137	0	0	633	1834	1623	0	592	0	0	0
User Adj:	1.00	1.00	1.00	1.00	1.00	1.00	0.87	1.00	1.00	1.00	1.00	0.00
PHF Adj:	1.00	1.00	1.00	1.00	1.00	1.00	1.00	1.00	1.00	1.00	1.00	0.00
PHF Volume:	1408	1137	0	0	633	1834	1412	0	592	0	0	0
Reduct Vol:	0	0	0	0	0	0	0	0	0	0	0	0
Reduced Vol:	1408	1137	0	0	633	1834	1412	0	592	0	0	0
PCE Adj:	1.00	1.00	1.00	1.00	1.00	1.00	1.00	1.00	1.00	1.00	1.00	0.00
MLF Adj:	1.00	1.00	1.00	1.00	1.00	1.00	1.00	1.00	1.00	1.00	1.00	0.00
FinalVolume:	1408	1137	0	0	633	1834	1412	0	592	0	0	0

Saturation Flow Module:												
Sat/Lane:	1900	1900	1900	1900	1900	1900	1900	1900	1900	1900	1900	1900
Adjustment:	0.83	1.00	0.92	0.92	1.00	0.92	0.83	1.00	0.92	0.92	1.00	0.92
Lanes:	2.00	3.00	0.00	0.00	2.00	1.00	2.00	0.00	1.00	0.00	0.00	0.00
Final Sat.:	3150	5700	0	0	3800	1750	3150	0	1750	0	0	0

Capacity Analysis Module:												
Vol/Sat:	0.45	0.20	0.00	0.00	0.17	1.05	0.45	0.00	0.34	0.00	0.00	0.00
Crit Moves:	****					****	****					
Green Time:	39.3	132	0.0	0.0	92.2	92.2	39.4	0.0	78.8	0.0	0.0	0.0
Volume/Cap:	2.05	0.27	0.00	0.00	0.33	2.05	2.05	0.00	0.77	0.00	0.00	0.00
Delay/Veh:	545.9	8.2	0.0	0.0	25.8	518.3	545.8	0.0	41.5	0.0	0.0	0.0
User DelAdj:	1.00	1.00	1.00	1.00	1.00	1.00	1.00	1.00	1.00	1.00	1.00	1.00
AdjDel/Veh:	545.9	8.2	0.0	0.0	25.8	518.3	545.8	0.0	41.5	0.0	0.0	0.0
LOS by Move:	F	A	A	A	C	F	F	A	D	A	A	A
HCM2k95thQ:	147	13	0	0	18	343	147	0	44	0	0	0

Note: Queue reported is the number of cars per lane.

BART Phase II Extension Project

Level Of Service Computation Report
 2000 HCM Operations (Future Volume Alternative)
 PM - 2035 No Project Conditions

Intersection #5335: CENTRAL EXPWY/DE LA CRUZ BLVD

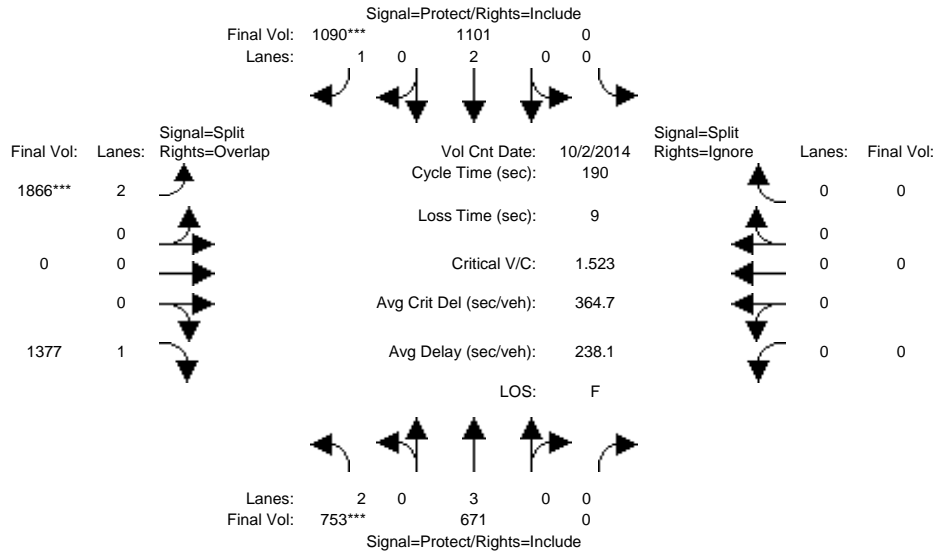

Approach:	North Bound			South Bound			East Bound			West Bound		
Movement:	L	T	R	L	T	R	L	T	R	L	T	R
Min. Green:	19	76	0	0	57	57	114	0	114	0	0	0
Y+R:	4.0	4.0	4.0	4.0	4.0	4.0	4.0	4.0	4.0	4.0	4.0	4.0
Volume Module: >> Count Date: 2 Oct 2014 <<												
Base Vol:	753	671	0	0	1101	1090	2521	0	1377	0	0	0
Growth Adj:	1.00	1.00	1.00	1.00	1.00	1.00	1.00	1.00	1.00	1.00	1.00	1.00
Initial Bse:	753	671	0	0	1101	1090	2521	0	1377	0	0	0
Added Vol:	0	0	0	0	0	0	0	0	0	0	0	0
PasserByVol:	0	0	0	0	0	0	0	0	0	0	0	0
Initial Fut:	753	671	0	0	1101	1090	2521	0	1377	0	0	0
User Adj:	1.00	1.00	1.00	1.00	1.00	1.00	0.74	1.00	1.00	1.00	1.00	0.00
PHF Adj:	1.00	1.00	1.00	1.00	1.00	1.00	1.00	1.00	1.00	1.00	1.00	0.00
PHF Volume:	753	671	0	0	1101	1090	1866	0	1377	0	0	0
Reduct Vol:	0	0	0	0	0	0	0	0	0	0	0	0
Reduced Vol:	753	671	0	0	1101	1090	1866	0	1377	0	0	0
PCE Adj:	1.00	1.00	1.00	1.00	1.00	1.00	1.00	1.00	1.00	1.00	1.00	0.00
MLF Adj:	1.00	1.00	1.00	1.00	1.00	1.00	1.00	1.00	1.00	1.00	1.00	0.00
Final Volume:	753	671	0	0	1101	1090	1866	0	1377	0	0	0
Saturation Flow Module:												
Sat/Lane:	1900	1900	1900	1900	1900	1900	1900	1900	1900	1900	1900	1900
Adjustment:	0.83	1.00	0.92	0.92	1.00	0.92	0.83	1.00	0.92	0.92	1.00	0.92
Lanes:	2.00	3.00	0.00	0.00	2.00	1.00	2.00	0.00	1.00	0.00	0.00	0.00
Final Sat.:	3150	5700	0	0	3800	1750	3150	0	1750	0	0	0
Capacity Analysis Module:												
Vol/Sat:	0.24	0.12	0.00	0.00	0.29	0.62	0.59	0.00	0.79	0.00	0.00	0.00
Crit Moves:	****				****	****	****					
Green Time:	18.1	72.6	0.0	0.0	54.4	54.4	108.8	0.0	127.0	0.0	0.0	0.0
Volume/Cap:	2.50	0.31	0.00	0.00	1.01	2.17	1.03	0.00	1.18	0.00	0.00	0.00
Delay/Veh:	776.5	43.2	0.0	0.0	101	606.1	57.5	0.0	101.4	0.0	0.0	0.0
User DelAdj:	1.00	1.00	1.00	1.00	1.00	1.00	1.00	1.00	1.00	1.00	1.00	1.00
AdjDel/Veh:	776.5	43.2	0.0	0.0	101	606.1	57.5	0.0	101.4	0.0	0.0	0.0
LOS by Move:	F	D	A	A	F	F	E	A	F	A	A	A
HCM2k95thQ:	91	17	0	0	60	220	116	0	176	0	0	0

Note: Queue reported is the number of cars per lane.

BART Phase II Extension Project

Level Of Service Computation Report
 2000 HCM Operations (Future Volume Alternative)
 AM - 2035 No Project Conditions

Intersection #5416: SAN TOMAS EXPWY/EL CAMINO REAL

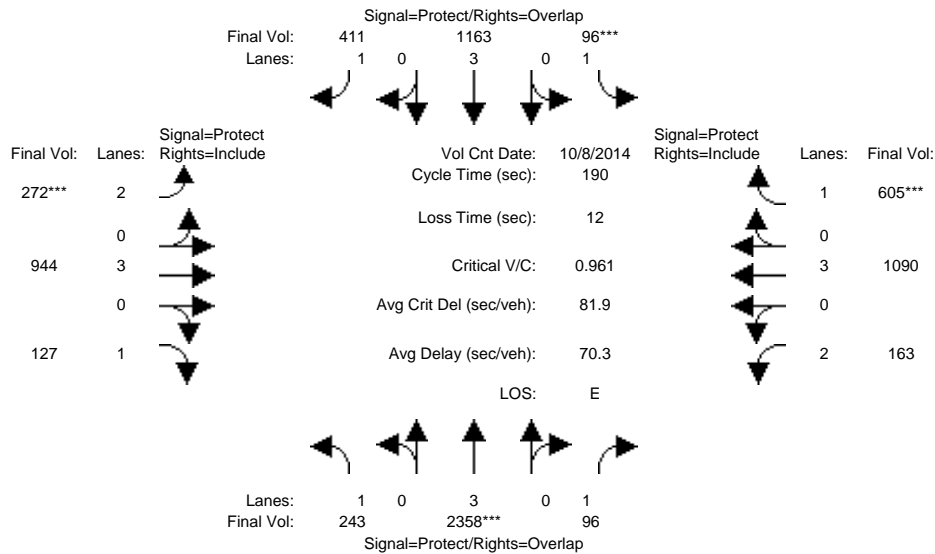

Approach:	North Bound			South Bound			East Bound			West Bound		
	L	T	R	L	T	R	L	T	R	L	T	R
Min. Green:	7	10	10	7	10	10	7	10	10	7	10	10
Y+R:	4.0	4.0	4.0	4.0	4.0	4.0	4.0	4.0	4.0	4.0	4.0	4.0
Volume Module: >> Count Date: 8 Oct 2014 <<												
Base Vol:	243	2807	96	96	1384	411	272	944	127	163	1090	605
Growth Adj:	1.00	1.00	1.00	1.00	1.00	1.00	1.00	1.00	1.00	1.00	1.00	1.00
Initial Bse:	243	2807	96	96	1384	411	272	944	127	163	1090	605
Added Vol:	0	0	0	0	0	0	0	0	0	0	0	0
PasserByVol:	0	0	0	0	0	0	0	0	0	0	0	0
Initial Fut:	243	2807	96	96	1384	411	272	944	127	163	1090	605
User Adj:	1.00	0.84	1.00	1.00	0.84	1.00	1.00	1.00	1.00	1.00	1.00	1.00
PHF Adj:	1.00	1.00	1.00	1.00	1.00	1.00	1.00	1.00	1.00	1.00	1.00	1.00
PHF Volume:	243	2358	96	96	1163	411	272	944	127	163	1090	605
Reduct Vol:	0	0	0	0	0	0	0	0	0	0	0	0
Reduced Vol:	243	2358	96	96	1163	411	272	944	127	163	1090	605
PCE Adj:	1.00	1.00	1.00	1.00	1.00	1.00	1.00	1.00	1.00	1.00	1.00	1.00
MLF Adj:	1.00	1.00	1.00	1.00	1.00	1.00	1.00	1.00	1.00	1.00	1.00	1.00
Final Volume:	243	2358	96	96	1163	411	272	944	127	163	1090	605
Saturation Flow Module:												
Sat/Lane:	1900	1900	1900	1900	1900	1900	1900	1900	1900	1900	1900	1900
Adjustment:	0.92	1.00	0.92	0.92	1.00	0.92	0.83	1.00	0.92	0.83	1.00	0.92
Lanes:	1.00	3.00	1.00	1.00	3.00	1.00	2.00	3.00	1.00	2.00	3.00	1.00
Final Sat.:	1750	5700	1750	1750	5700	1750	3150	5700	1750	3150	5700	1750
Capacity Analysis Module:												
Vol/Sat:	0.14	0.41	0.05	0.05	0.20	0.23	0.09	0.17	0.07	0.05	0.19	0.35
Crit Moves:	****	****	****	****	****	****	****	****	****	****	****	****
Green Time:	37.5	81.8	102.1	10.8	55.1	72.2	17.1	65.1	65.1	20.3	68.3	68.3
Volume/Cap:	0.70	0.96	0.10	0.96	0.70	0.62	0.96	0.48	0.21	0.48	0.53	0.96
Delay/Veh:	77.9	71.8	27.8	170.2	77.9	69.0	129.0	49.4	44.5	81.0	48.4	86.0
User DelAdj:	1.00	1.00	1.00	1.00	1.00	1.00	1.00	1.00	1.00	1.00	1.00	1.00
AdjDel/Veh:	77.9	71.8	27.8	170.2	77.9	69.0	129.0	49.4	44.5	81.0	48.4	86.0
LOS by Move:	E	E	C	F	E	E	F	D	D	F	D	F
HCM2k95thQ:	26	75	8	14	36	39	23	25	11	10	28	64

Note: Queue reported is the number of cars per lane.

BART Phase II Extension Project

Level Of Service Computation Report
 2000 HCM Operations (Future Volume Alternative)
 PM - 2035 No Project Conditions

Intersection #5416: SAN TOMAS EXPWY/EL CAMINO REAL

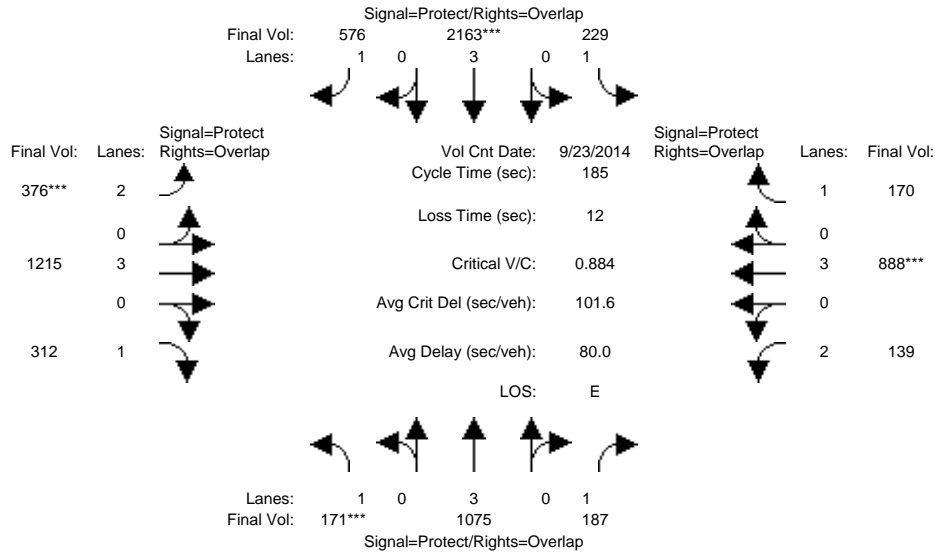

Approach:	North Bound			South Bound			East Bound			West Bound		
	L	T	R	L	T	R	L	T	R	L	T	R
Min. Green:	12	72	72	33	93	93	39	50	50	29	41	41
Y+R:	4.0	4.0	4.0	4.0	4.0	4.0	4.0	4.0	4.0	4.0	4.0	4.0

Volume Module: >> Count Date: 23 Sep 2014 <<

Base Vol:	171	1414	187	229	2809	576	376	1215	312	139	888	170
Growth Adj:	1.00	1.00	1.00	1.00	1.00	1.00	1.00	1.00	1.00	1.00	1.00	1.00
Initial Bse:	171	1414	187	229	2809	576	376	1215	312	139	888	170
Added Vol:	0	0	0	0	0	0	0	0	0	0	0	0
PasserByVol:	0	0	0	0	0	0	0	0	0	0	0	0
Initial Fut:	171	1414	187	229	2809	576	376	1215	312	139	888	170
User Adj:	1.00	0.76	1.00	1.00	0.77	1.00	1.00	1.00	1.00	1.00	1.00	1.00
PHF Adj:	1.00	1.00	1.00	1.00	1.00	1.00	1.00	1.00	1.00	1.00	1.00	1.00
PHF Volume:	171	1075	187	229	2163	576	376	1215	312	139	888	170
Reduct Vol:	0	0	0	0	0	0	0	0	0	0	0	0
Reduced Vol:	171	1075	187	229	2163	576	376	1215	312	139	888	170
PCE Adj:	1.00	1.00	1.00	1.00	1.00	1.00	1.00	1.00	1.00	1.00	1.00	1.00
MLF Adj:	1.00	1.00	1.00	1.00	1.00	1.00	1.00	1.00	1.00	1.00	1.00	1.00
Final Volume:	171	1075	187	229	2163	576	376	1215	312	139	888	170

Saturation Flow Module:

Sat/Lane:	1900	1900	1900	1900	1900	1900	1900	1900	1900	1900	1900	1900
Adjustment:	0.92	1.00	0.92	0.92	0.83	0.92	0.83	1.00	0.92	0.83	1.00	0.92
Lanes:	1.00	3.00	1.00	1.00	3.00	1.00	2.00	3.00	1.00	2.00	3.00	1.00
Final Sat.:	1750	5700	1750	1750	4731	1750	3150	5700	1750	3150	5700	1750

Capacity Analysis Module:

Vol/Sat:	0.10	0.19	0.11	0.13	0.46	0.33	0.12	0.21	0.18	0.04	0.16	0.10
Crit Moves:	****				****		****				****	
Green Time:	11.3	67.6	95.2	31.0	87.3	124.0	36.6	47.5	58.8	27.6	38.5	69.5
Volume/Cap:	1.60	0.52	0.21	0.78	0.97	0.49	0.60	0.83	0.56	0.30	0.75	0.26
Delay/Veh:	403.6	54.4	32.8	101.8	93.2	38.0	73.6	73.2	57.1	75.0	75.8	42.7
User DelAdj:	1.00	1.00	1.00	1.00	1.00	1.00	1.00	1.00	1.00	1.00	1.00	1.00
AdjDel/Veh:	403.6	54.4	32.8	101.8	93.2	38.0	73.6	73.2	57.1	75.0	75.8	42.7
LOS by Move:	F	D	C	F	F	D	E	E	E	E	E	D
HCM2k95thQ:	33	31	15	27	73	50	23	41	29	8	29	14

Note: Queue reported is the number of cars per lane.

BART Phase II Extension Project

Level Of Service Computation Report
 2000 HCM Operations (Future Volume Alternative)
 AM - 2035 No Project Conditions

Intersection #5444: Lafayette/Lewis

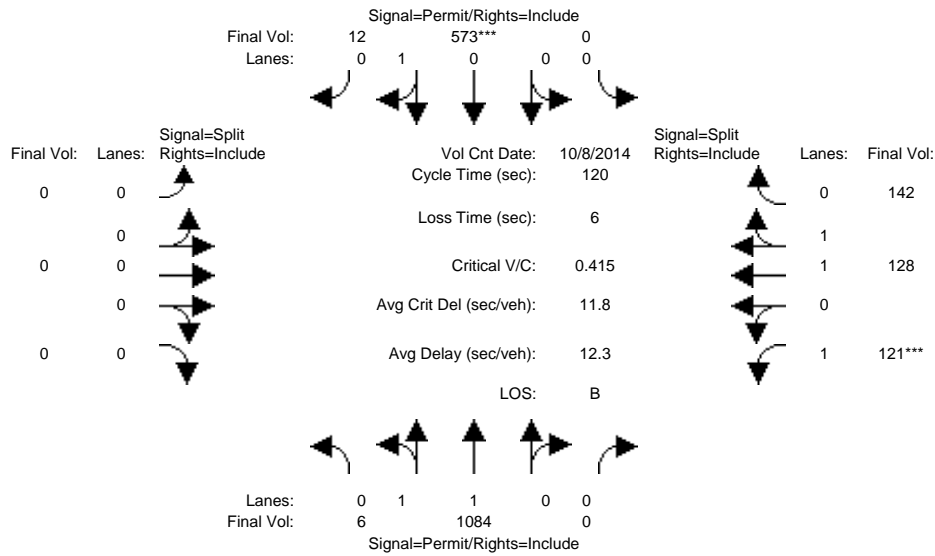

Approach:	North Bound			South Bound			East Bound			West Bound		
Movement:	L	T	R	L	T	R	L	T	R	L	T	R
Min. Green:	10	10	0	0	10	10	0	0	0	10	10	10
Y+R:	4.0	4.0	4.0	4.0	4.0	4.0	4.0	4.0	4.0	4.0	4.0	4.0
Volume Module: >> Count Date: 8 Oct 2014 <<												
Base Vol:	6	1084	0	0	573	12	0	0	0	121	128	142
Growth Adj:	1.00	1.00	1.00	1.00	1.00	1.00	1.00	1.00	1.00	1.00	1.00	1.00
Initial Bse:	6	1084	0	0	573	12	0	0	0	121	128	142
Added Vol:	0	0	0	0	0	0	0	0	0	0	0	0
PasserByVol:	0	0	0	0	0	0	0	0	0	0	0	0
Initial Fut:	6	1084	0	0	573	12	0	0	0	121	128	142
User Adj:	1.00	1.00	1.00	1.00	1.00	1.00	1.00	1.00	1.00	1.00	1.00	1.00
PHF Adj:	1.00	1.00	1.00	1.00	1.00	1.00	1.00	1.00	1.00	1.00	1.00	1.00
PHF Volume:	6	1084	0	0	573	12	0	0	0	121	128	142
Reduct Vol:	0	0	0	0	0	0	0	0	0	0	0	0
Reduced Vol:	6	1084	0	0	573	12	0	0	0	121	128	142
PCE Adj:	1.00	1.00	1.00	1.00	1.00	1.00	1.00	1.00	1.00	1.00	1.00	1.00
MLF Adj:	1.00	1.00	1.00	1.00	1.00	1.00	1.00	1.00	1.00	1.00	1.00	1.00
FinalVolume:	6	1084	0	0	573	12	0	0	0	121	128	142
Saturation Flow Module:												
Sat/Lane:	1900	1900	1900	1900	1900	1900	1900	1900	1900	1900	1900	1900
Adjustment:	0.95	0.97	0.92	0.92	0.95	0.95	0.92	1.00	0.92	0.92	1.00	0.92
Lanes:	0.01	1.99	0.00	0.00	0.98	0.02	0.00	0.00	0.00	1.00	1.00	1.00
Final Sat.:	20	3680	0	0	1763	37	0	0	0	1750	1900	1750
Capacity Analysis Module:												
Vol/Sat:	0.29	0.29	0.00	0.00	0.33	0.33	0.00	0.00	0.00	0.07	0.07	0.08
Crit Moves:	*****											
Green Time:	91.2	91.2	0.0	0.0	91.2	91.2	0.0	0.0	0.0	22.8	22.8	22.8
Volume/Cap:	0.39	0.39	0.00	0.00	0.43	0.43	0.00	0.00	0.00	0.36	0.35	0.43
Delay/Veh:	5.0	5.0	0.0	0.0	5.3	5.3	0.0	0.0	0.0	43.0	42.5	43.3
User DelAdj:	1.00	1.00	1.00	1.00	1.00	1.00	1.00	1.00	1.00	1.00	1.00	1.00
AdjDel/Veh:	5.0	5.0	0.0	0.0	5.3	5.3	0.0	0.0	0.0	43.0	42.5	43.3
LOS by Move:	A	A	A	A	A	A	A	A	A	D	D	D
HCM2k95thQ:	13	13	0	0	15	15	0	0	0	9	8	10

Note: Queue reported is the number of cars per lane.

BART Phase II Extension Project

Level Of Service Computation Report
 2000 HCM Operations (Future Volume Alternative)
 PM - 2035 No Project Conditions

Intersection #5444: Lafayette/Lewis

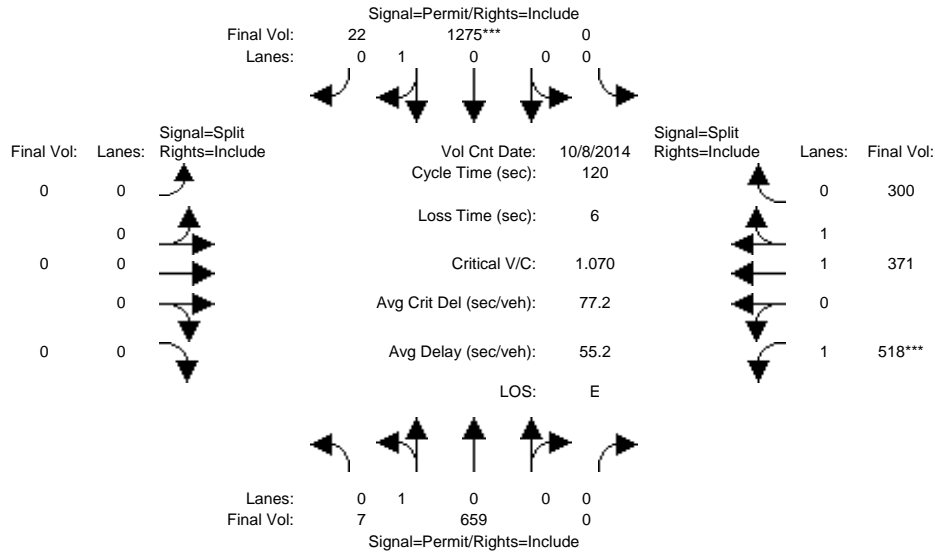

Approach:	North Bound			South Bound			East Bound			West Bound		
	L	T	R	L	T	R	L	T	R	L	T	R
Min. Green:	10	10	0	0	10	10	0	0	0	10	10	10
Y+R:	4.0	4.0	4.0	4.0	4.0	4.0	4.0	4.0	4.0	4.0	4.0	4.0
Volume Module: >> Count Date: 8 Oct 2014 <<												
Base Vol:	7	659	0	0	1275	22	0	0	0	518	371	300
Growth Adj:	1.00	1.00	1.00	1.00	1.00	1.00	1.00	1.00	1.00	1.00	1.00	1.00
Initial Bse:	7	659	0	0	1275	22	0	0	0	518	371	300
Added Vol:	0	0	0	0	0	0	0	0	0	0	0	0
PasserByVol:	0	0	0	0	0	0	0	0	0	0	0	0
Initial Fut:	7	659	0	0	1275	22	0	0	0	518	371	300
User Adj:	1.00	1.00	1.00	1.00	1.00	1.00	1.00	1.00	1.00	1.00	1.00	1.00
PHF Adj:	1.00	1.00	1.00	1.00	1.00	1.00	1.00	1.00	1.00	1.00	1.00	1.00
PHF Volume:	7	659	0	0	1275	22	0	0	0	518	371	300
Reduct Vol:	0	0	0	0	0	0	0	0	0	0	0	0
Reduced Vol:	7	659	0	0	1275	22	0	0	0	518	371	300
PCE Adj:	1.00	1.00	1.00	1.00	1.00	1.00	1.00	1.00	1.00	1.00	1.00	1.00
MLF Adj:	1.00	1.00	1.00	1.00	1.00	1.00	1.00	1.00	1.00	1.00	1.00	1.00
FinalVolume:	7	659	0	0	1275	22	0	0	0	518	371	300
Saturation Flow Module:												
Sat/Lane:	1900	1900	1900	1900	1900	1900	1900	1900	1900	1900	1900	1900
Adjustment:	0.95	0.95	0.92	0.92	0.95	0.95	0.92	1.00	0.92	0.92	0.99	0.95
Lanes:	0.01	0.99	0.00	0.00	0.98	0.02	0.00	0.00	0.00	1.00	1.08	0.92
Final Sat.:	19	1781	0	0	1769	31	0	0	0	1750	2045	1653
Capacity Analysis Module:												
Vol/Sat:	0.37	0.37	0.00	0.00	0.72	0.72	0.00	0.00	0.00	0.30	0.18	0.18
Crit Moves:	****						****					
Green Time:	80.8	80.8	0.0	0.0	80.8	80.8	0.0	0.0	0.0	33.2	33.2	33.2
Volume/Cap:	0.55	0.55	0.00	0.00	1.07	1.07	0.00	0.00	0.00	1.07	0.66	0.66
Delay/Veh:	10.7	10.7	0.0	0.0	66.4	66.4	0.0	0.0	0.0	104.3	39.9	39.9
User DelAdj:	1.00	1.00	1.00	1.00	1.00	1.00	1.00	1.00	1.00	1.00	1.00	1.00
AdjDel/Veh:	10.7	10.7	0.0	0.0	66.4	66.4	0.0	0.0	0.0	104.3	39.9	39.9
LOS by Move:	B	B	A	A	E	E	A	A	A	F	D	D
HCM2k95thQ:	23	23	0	0	95	95	0	0	0	48	22	22

Note: Queue reported is the number of cars per lane.

BART Phase II Extension Project

Level Of Service Computation Report
 2000 HCM Operations (Future Volume Alternative)
 AM - 2035 Project Conditions

Intersection #6: DE LA CRUZ/MARTIN

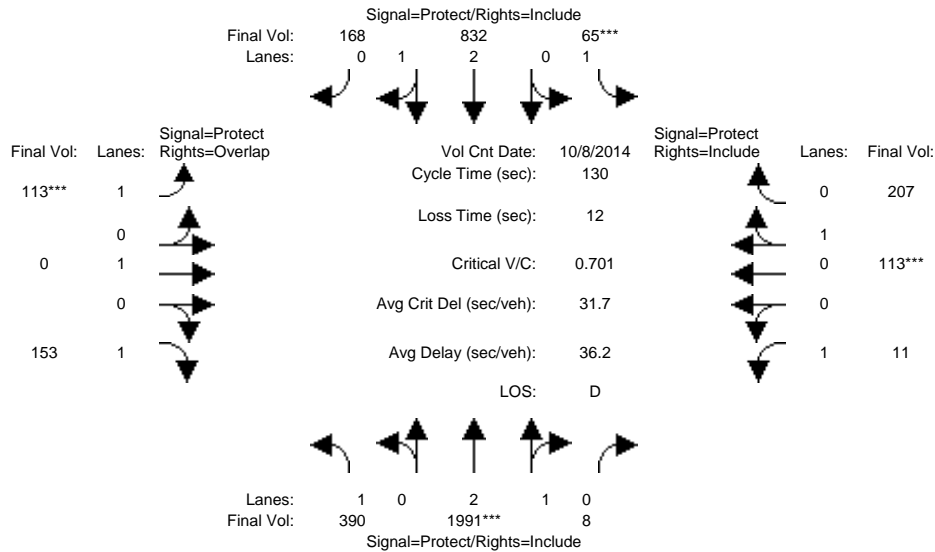

Approach:	North Bound			South Bound			East Bound			West Bound		
Movement:	L	T	R	L	T	R	L	T	R	L	T	R
Min. Green:	7	10	10	7	10	10	7	10	10	7	10	10
Y+R:	4.0	4.0	4.0	4.0	4.0	4.0	4.0	4.0	4.0	4.0	4.0	4.0

Volume Module:	>>	Count	Date:	8 Oct 2014	<<							
Base Vol:	390	1991	8	65	832	168	113	0	153	11	113	207
Growth Adj:	1.00	1.00	1.00	1.00	1.00	1.00	1.00	1.00	1.00	1.00	1.00	1.00
Initial Bse:	390	1991	8	65	832	168	113	0	153	11	113	207
Added Vol:	0	0	0	0	0	0	0	0	0	0	0	0
PasserByVol:	0	0	0	0	0	0	0	0	0	0	0	0
Initial Fut:	390	1991	8	65	832	168	113	0	153	11	113	207
User Adj:	1.00	1.00	1.00	1.00	1.00	1.00	1.00	1.00	1.00	1.00	1.00	1.00
PHF Adj:	1.00	1.00	1.00	1.00	1.00	1.00	1.00	1.00	1.00	1.00	1.00	1.00
PHF Volume:	390	1991	8	65	832	168	113	0	153	11	113	207
Reduct Vol:	0	0	0	0	0	0	0	0	0	0	0	0
Reduced Vol:	390	1991	8	65	832	168	113	0	153	11	113	207
PCE Adj:	1.00	1.00	1.00	1.00	1.00	1.00	1.00	1.00	1.00	1.00	1.00	1.00
MLF Adj:	1.00	1.00	1.00	1.00	1.00	1.00	1.00	1.00	1.00	1.00	1.00	1.00
Final Volume:	390	1991	8	65	832	168	113	0	153	11	113	207

Saturation Flow Module:												
Sat/Lane:	1900	1900	1900	1900	1900	1900	1900	1900	1900	1900	1900	1900
Adjustment:	0.92	0.98	0.95	0.92	0.99	0.95	0.92	1.00	0.92	0.92	0.95	0.95
Lanes:	1.00	2.99	0.01	1.00	2.48	0.52	1.00	1.00	1.00	1.00	0.35	0.65
Final Sat.:	1750	5578	22	1750	4658	941	1750	1900	1750	1750	636	1164

Capacity Analysis Module:												
Vol/Sat:	0.22	0.36	0.36	0.04	0.18	0.18	0.06	0.00	0.09	0.01	0.18	0.18
Crit Moves:	****			****			****			****		
Green Time:	40.6	66.1	66.1	7.0	32.5	32.5	12.0	0.0	52.5	44.9	32.9	32.9
Volume/Cap:	0.71	0.70	0.70	0.69	0.71	0.71	0.70	0.00	0.22	0.02	0.70	0.70
Delay/Veh:	44.0	25.2	25.2	79.9	46.3	46.3	70.3	0.0	25.4	28.1	48.9	48.9
User DelAdj:	1.00	1.00	1.00	1.00	1.00	1.00	1.00	1.00	1.00	1.00	1.00	1.00
AdjDel/Veh:	44.0	25.2	25.2	79.9	46.3	46.3	70.3	0.0	25.4	28.1	48.9	48.9
LOS by Move:	D	C	C	E	D	D	E	A	C	C	D	D
HCM2k95thQ:	26	35	35	6	22	22	10	0	8	1	24	24

Note: Queue reported is the number of cars per lane.

BART Phase II Extension Project

Level Of Service Computation Report
2000 HCM Operations (Future Volume Alternative)
PM - 2035 Project Conditions

Intersection #6: DE LA CRUZ/MARTIN

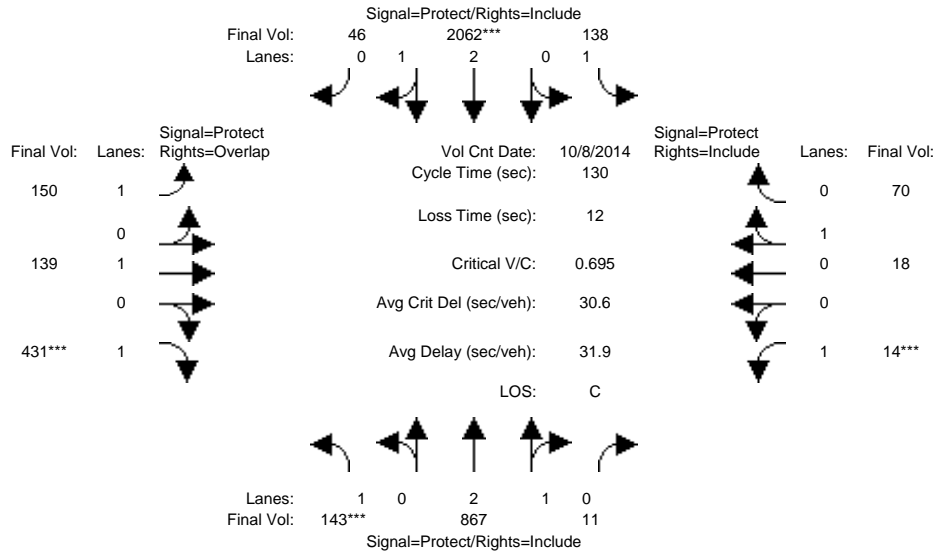

Approach:	North Bound			South Bound			East Bound			West Bound		
	L	T	R	L	T	R	L	T	R	L	T	R
Min. Green:	7	10	10	7	10	10	7	10	10	7	10	10
Y+R:	4.0	4.0	4.0	4.0	4.0	4.0	4.0	4.0	4.0	4.0	4.0	4.0

Volume Module:	>> Count Date: 8 Oct 2014 <<											
Base Vol:	143	867	11	138	2062	46	150	139	431	14	18	70
Growth Adj:	1.00	1.00	1.00	1.00	1.00	1.00	1.00	1.00	1.00	1.00	1.00	1.00
Initial Bse:	143	867	11	138	2062	46	150	139	431	14	18	70
Added Vol:	0	0	0	0	0	0	0	0	0	0	0	0
PasserByVol:	0	0	0	0	0	0	0	0	0	0	0	0
Initial Fut:	143	867	11	138	2062	46	150	139	431	14	18	70
User Adj:	1.00	1.00	1.00	1.00	1.00	1.00	1.00	1.00	1.00	1.00	1.00	1.00
PHF Adj:	1.00	1.00	1.00	1.00	1.00	1.00	1.00	1.00	1.00	1.00	1.00	1.00
PHF Volume:	143	867	11	138	2062	46	150	139	431	14	18	70
Reduct Vol:	0	0	0	0	0	0	0	0	0	0	0	0
Reduced Vol:	143	867	11	138	2062	46	150	139	431	14	18	70
PCE Adj:	1.00	1.00	1.00	1.00	1.00	1.00	1.00	1.00	1.00	1.00	1.00	1.00
MLF Adj:	1.00	1.00	1.00	1.00	1.00	1.00	1.00	1.00	1.00	1.00	1.00	1.00
Final Volume:	143	867	11	138	2062	46	150	139	431	14	18	70

Saturation Flow Module:												
Sat/Lane:	1900	1900	1900	1900	1900	1900	1900	1900	1900	1900	1900	1900
Adjustment:	0.92	0.98	0.95	0.92	0.98	0.95	0.92	1.00	0.92	0.92	0.95	0.95
Lanes:	1.00	2.96	0.04	1.00	2.93	0.07	1.00	1.00	1.00	1.00	0.20	0.80
Final Sat.:	1750	5530	70	1750	5478	122	1750	1900	1750	1750	368	1432

Capacity Analysis Module:												
Vol/Sat:	0.08	0.16	0.16	0.08	0.38	0.38	0.09	0.07	0.25	0.01	0.05	0.05
Crit Moves:	****			****			****		****	****		
Green Time:	14.6	54.3	54.3	27.3	67.1	67.1	19.1	29.3	43.9	7.0	17.2	17.2
Volume/Cap:	0.73	0.38	0.38	0.38	0.73	0.73	0.58	0.32	0.73	0.15	0.37	0.37
Delay/Veh:	68.8	26.2	26.2	44.7	25.4	25.4	55.0	42.5	42.4	59.4	52.4	52.4
User DelAdj:	1.00	1.00	1.00	1.00	1.00	1.00	1.00	1.00	1.00	1.00	1.00	1.00
AdjDel/Veh:	68.8	26.2	26.2	44.7	25.4	25.4	55.0	42.5	42.4	59.4	52.4	52.4
LOS by Move:	E	C	C	D	C	C	E	D	D	E	D	D
HCM2k95thQ:	12	15	15	10	37	37	12	9	29	1	7	7

Note: Queue reported is the number of cars per lane.

BART Phase II Extension Project

Level Of Service Computation Report
2000 HCM Operations (Future Volume Alternative)
AM - 2035 Project Conditions

Intersection #7: LAFAYETTE/REED

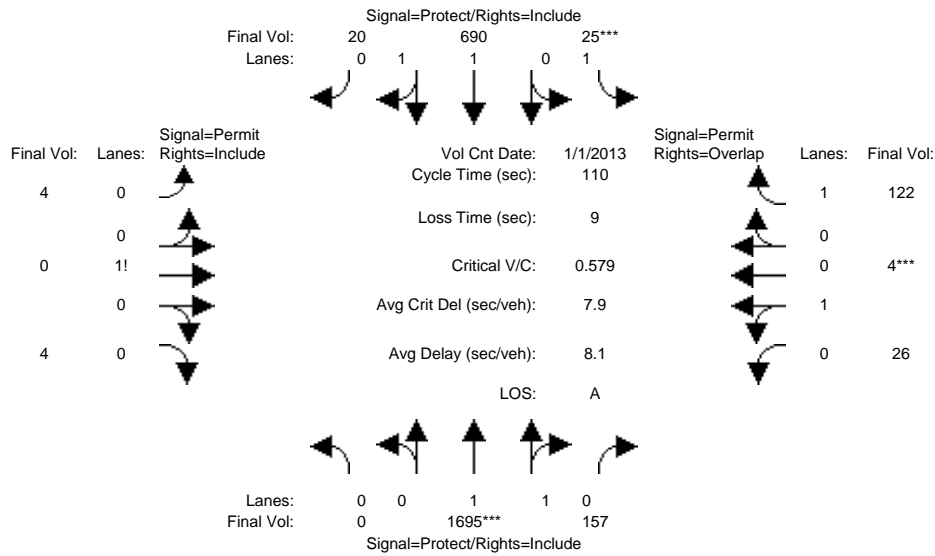

Approach:	North Bound			South Bound			East Bound			West Bound		
Movement:	L	T	R	L	T	R	L	T	R	L	T	R
Min. Green:	7	10	10	7	10	10	10	10	10	10	10	10
Y+R:	4.0	4.0	4.0	4.0	4.0	4.0	4.0	4.0	4.0	4.0	4.0	4.0
Volume Module: >> Count Date: 1 Jan 2013 <<												
Base Vol:	0	1695	157	25	690	20	4	0	4	26	4	122
Growth Adj:	1.00	1.00	1.00	1.00	1.00	1.00	1.00	1.00	1.00	1.00	1.00	1.00
Initial Bse:	0	1695	157	25	690	20	4	0	4	26	4	122
Added Vol:	0	0	0	0	0	0	0	0	0	0	0	0
PasserByVol:	0	0	0	0	0	0	0	0	0	0	0	0
Initial Fut:	0	1695	157	25	690	20	4	0	4	26	4	122
User Adj:	1.00	1.00	1.00	1.00	1.00	1.00	1.00	1.00	1.00	1.00	1.00	1.00
PHF Adj:	1.00	1.00	1.00	1.00	1.00	1.00	1.00	1.00	1.00	1.00	1.00	1.00
PHF Volume:	0	1695	157	25	690	20	4	0	4	26	4	122
Reduct Vol:	0	0	0	0	0	0	0	0	0	0	0	0
Reduced Vol:	0	1695	157	25	690	20	4	0	4	26	4	122
PCE Adj:	1.00	1.00	1.00	1.00	1.00	1.00	1.00	1.00	1.00	1.00	1.00	1.00
MLF Adj:	1.00	1.00	1.00	1.00	1.00	1.00	1.00	1.00	1.00	1.00	1.00	1.00
FinalVolume:	0	1695	157	25	690	20	4	0	4	26	4	122
Saturation Flow Module:												
Sat/Lane:	1900	1900	1900	1900	1900	1900	1900	1900	1900	1900	1900	1900
Adjustment:	0.92	0.98	0.95	0.92	0.97	0.95	0.92	0.92	0.92	0.95	0.95	0.92
Lanes:	0.00	1.83	0.17	1.00	1.94	0.06	0.50	0.00	0.50	0.87	0.13	1.00
Final Sat.:	0	3386	314	1750	3596	104	875	0	875	1560	240	1750
Capacity Analysis Module:												
Vol/Sat:	0.00	0.50	0.50	0.01	0.19	0.19	0.00	0.00	0.00	0.02	0.02	0.07
Crit Moves:	****			****						****		
Green Time:	0.0	84.0	84.0	7.0	91.0	91.0	10.0	0.0	10.0	10.0	10.0	17.0
Volume/Cap:	0.00	0.66	0.66	0.22	0.23	0.23	0.05	0.00	0.05	0.18	0.18	0.45
Delay/Veh:	0.0	6.7	6.7	49.9	2.1	2.1	45.8	0.0	45.8	46.8	46.8	43.5
User DelAdj:	1.00	1.00	1.00	1.00	1.00	1.00	1.00	1.00	1.00	1.00	1.00	1.00
AdjDel/Veh:	0.0	6.7	6.7	49.9	2.1	2.1	45.8	0.0	45.8	46.8	46.8	43.5
LOS by Move:	A	A	A	D	A	A	D	A	D	D	D	D
HCM2k95thQ:	0	27	27	2	5	5	1	0	1	2	2	8

Note: Queue reported is the number of cars per lane.

BART Phase II Extension Project

Level Of Service Computation Report
2000 HCM Operations (Future Volume Alternative)
PM - 2035 Project Conditions

Intersection #7: LAFAYETTE/REED

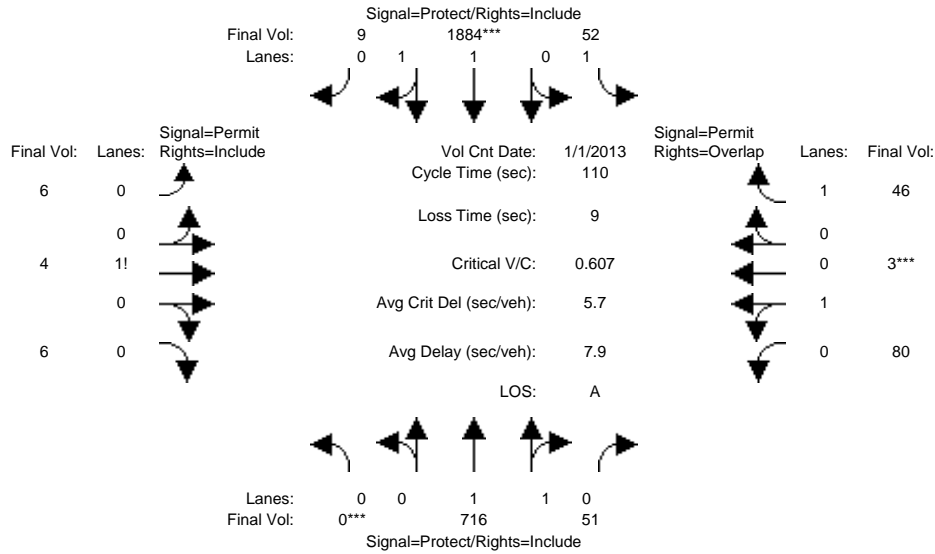

Approach:	North Bound			South Bound			East Bound			West Bound		
Movement:	L	T	R	L	T	R	L	T	R	L	T	R
Min. Green:	7	10	10	7	10	10	10	10	10	10	10	10
Y+R:	4.0	4.0	4.0	4.0	4.0	4.0	4.0	4.0	4.0	4.0	4.0	4.0
Volume Module: >> Count Date: 1 Jan 2013 <<												
Base Vol:	0	716	51	52	1884	9	6	4	6	80	3	46
Growth Adj:	1.00	1.00	1.00	1.00	1.00	1.00	1.00	1.00	1.00	1.00	1.00	1.00
Initial Bse:	0	716	51	52	1884	9	6	4	6	80	3	46
Added Vol:	0	0	0	0	0	0	0	0	0	0	0	0
PasserByVol:	0	0	0	0	0	0	0	0	0	0	0	0
Initial Fut:	0	716	51	52	1884	9	6	4	6	80	3	46
User Adj:	1.00	1.00	1.00	1.00	1.00	1.00	1.00	1.00	1.00	1.00	1.00	1.00
PHF Adj:	1.00	1.00	1.00	1.00	1.00	1.00	1.00	1.00	1.00	1.00	1.00	1.00
PHF Volume:	0	716	51	52	1884	9	6	4	6	80	3	46
Reduct Vol:	0	0	0	0	0	0	0	0	0	0	0	0
Reduced Vol:	0	716	51	52	1884	9	6	4	6	80	3	46
PCE Adj:	1.00	1.00	1.00	1.00	1.00	1.00	1.00	1.00	1.00	1.00	1.00	1.00
MLF Adj:	1.00	1.00	1.00	1.00	1.00	1.00	1.00	1.00	1.00	1.00	1.00	1.00
FinalVolume:	0	716	51	52	1884	9	6	4	6	80	3	46
Saturation Flow Module:												
Sat/Lane:	1900	1900	1900	1900	1900	1900	1900	1900	1900	1900	1900	1900
Adjustment:	0.92	0.98	0.95	0.92	0.97	0.95	0.92	0.92	0.92	0.95	0.95	0.92
Lanes:	0.00	1.86	0.14	1.00	1.99	0.01	0.37	0.25	0.38	0.96	0.04	1.00
Final Sat.:	0	3454	246	1750	3682	18	656	438	656	1735	65	1750
Capacity Analysis Module:												
Vol/Sat:	0.00	0.21	0.21	0.03	0.51	0.51	0.01	0.01	0.01	0.05	0.05	0.03
Crit Moves:	****				****						****	
Green Time:	0.0	69.6	69.6	21.4	91.0	91.0	10.0	10.0	10.0	10.0	10.0	31.4
Volume/Cap:	0.00	0.33	0.33	0.15	0.62	0.62	0.10	0.10	0.10	0.51	0.51	0.09
Delay/Veh:	0.0	9.4	9.4	37.0	3.7	3.7	46.2	46.2	46.2	50.2	50.2	28.9
User DelAdj:	1.00	1.00	1.00	1.00	1.00	1.00	1.00	1.00	1.00	1.00	1.00	1.00
AdjDel/Veh:	0.0	9.4	9.4	37.0	3.7	3.7	46.2	46.2	46.2	50.2	50.2	28.9
LOS by Move:	A	A	A	D	A	A	D	D	D	D	D	C
HCM2k95thQ:	0	12	12	3	22	22	1	1	1	6	6	2

Note: Queue reported is the number of cars per lane.

BART Phase II Extension Project

Level Of Service Computation Report
2000 HCM Operations (Future Volume Alternative)
AM - 2035 Project Conditions

Intersection #9: Coleman/Brokaw

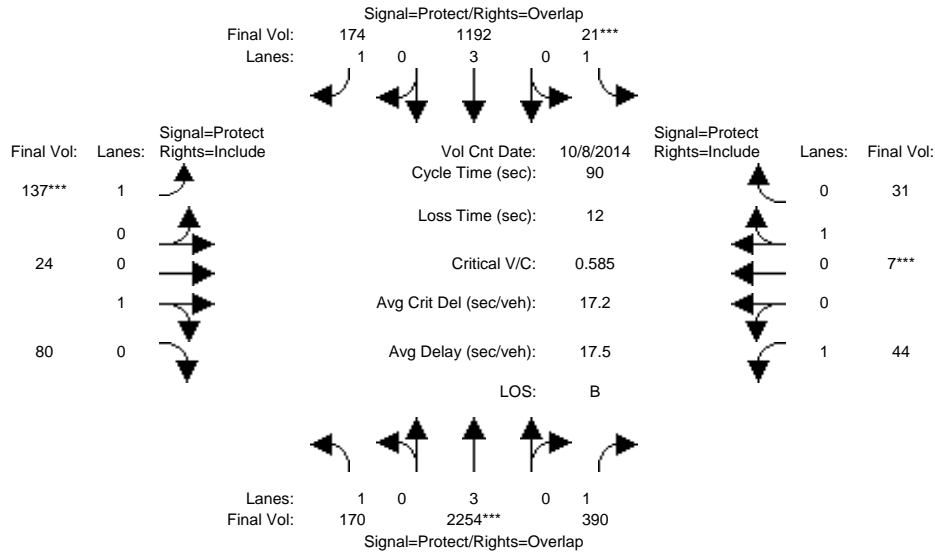

Approach:	North Bound			South Bound			East Bound			West Bound		
	L	T	R	L	T	R	L	T	R	L	T	R
Min. Green:	7	10	10	7	10	10	7	10	10	7	10	10
Y+R:	4.0	4.0	4.0	4.0	4.0	4.0	4.0	4.0	4.0	4.0	4.0	4.0

Volume Module: >> Count Date: 8 Oct 2014 <<

Base Vol:	170	2254	390	21	1192	174	137	24	80	44	7	31
Growth Adj:	1.00	1.00	1.00	1.00	1.00	1.00	1.00	1.00	1.00	1.00	1.00	1.00
Initial Bse:	170	2254	390	21	1192	174	137	24	80	44	7	31
Added Vol:	0	0	0	0	0	0	0	0	0	0	0	0
PasserByVol:	0	0	0	0	0	0	0	0	0	0	0	0
Initial Fut:	170	2254	390	21	1192	174	137	24	80	44	7	31
User Adj:	1.00	1.00	1.00	1.00	1.00	1.00	1.00	1.00	1.00	1.00	1.00	1.00
PHF Adj:	1.00	1.00	1.00	1.00	1.00	1.00	1.00	1.00	1.00	1.00	1.00	1.00
PHF Volume:	170	2254	390	21	1192	174	137	24	80	44	7	31
Reduct Vol:	0	0	0	0	0	0	0	0	0	0	0	0
Reduced Vol:	170	2254	390	21	1192	174	137	24	80	44	7	31
PCE Adj:	1.00	1.00	1.00	1.00	1.00	1.00	1.00	1.00	1.00	1.00	1.00	1.00
MLF Adj:	1.00	1.00	1.00	1.00	1.00	1.00	1.00	1.00	1.00	1.00	1.00	1.00
FinalVolume:	170	2254	390	21	1192	174	137	24	80	44	7	31

Saturation Flow Module:

Sat/Lane:	1900	1900	1900	1900	1900	1900	1900	1900	1900	1900	1900	1900
Adjustment:	0.92	1.00	0.92	0.92	1.00	0.92	0.92	0.95	0.95	0.92	0.95	0.95
Lanes:	1.00	3.00	1.00	1.00	3.00	1.00	1.00	0.23	0.77	1.00	0.18	0.82
Final Sat.:	1750	5700	1750	1750	5700	1750	1750	415	1385	1750	332	1468

Capacity Analysis Module:

Vol/Sat:	0.10	0.40	0.22	0.01	0.21	0.10	0.08	0.06	0.06	0.03	0.02	0.02
Crit Moves:	****	****	****	****	****	****	****	****	****	****	****	****
Green Time:	18.4	50.9	59.2	7.0	39.5	49.6	10.1	11.8	11.8	8.3	10.0	10.0
Volume/Cap:	0.48	0.70	0.34	0.15	0.48	0.18	0.70	0.44	0.44	0.27	0.19	0.19
Delay/Veh:	32.6	14.7	7.0	39.3	18.0	10.1	49.1	37.4	37.4	39.0	36.8	36.8
User DelAdj:	1.00	1.00	1.00	1.00	1.00	1.00	1.00	1.00	1.00	1.00	1.00	1.00
AdjDel/Veh:	32.6	14.7	7.0	39.3	18.0	10.1	49.1	37.4	37.4	39.0	36.8	36.8
LOS by Move:	C	B	A	D	B	B	D	D	D	D	D	D
HCM2k95thQ:	8	24	9	1	14	5	11	7	7	2	2	2

Note: Queue reported is the number of cars per lane.

BART Phase II Extension Project

Level Of Service Computation Report
2000 HCM Operations (Future Volume Alternative)
PM - 2035 Project Conditions

Intersection #9: Coleman/Brokaw

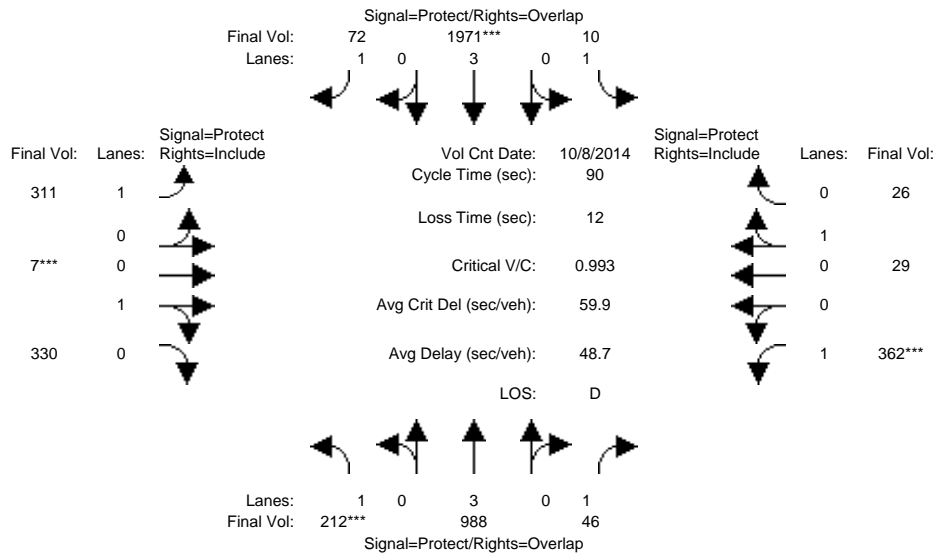

Approach:	North Bound			South Bound			East Bound			West Bound		
	L	T	R	L	T	R	L	T	R	L	T	R
Min. Green:	7	10	10	7	10	10	7	10	10	7	10	10
Y+R:	4.0	4.0	4.0	4.0	4.0	4.0	4.0	4.0	4.0	4.0	4.0	4.0
Volume Module: >> Count Date: 8 Oct 2014 <<												
Base Vol:	212	988	46	10	1971	72	311	7	330	362	29	26
Growth Adj:	1.00	1.00	1.00	1.00	1.00	1.00	1.00	1.00	1.00	1.00	1.00	1.00
Initial Bse:	212	988	46	10	1971	72	311	7	330	362	29	26
Added Vol:	0	0	0	0	0	0	0	0	0	0	0	0
PasserByVol:	0	0	0	0	0	0	0	0	0	0	0	0
Initial Fut:	212	988	46	10	1971	72	311	7	330	362	29	26
User Adj:	1.00	1.00	1.00	1.00	1.00	1.00	1.00	1.00	1.00	1.00	1.00	1.00
PHF Adj:	1.00	1.00	1.00	1.00	1.00	1.00	1.00	1.00	1.00	1.00	1.00	1.00
PHF Volume:	212	988	46	10	1971	72	311	7	330	362	29	26
Reduct Vol:	0	0	0	0	0	0	0	0	0	0	0	0
Reduced Vol:	212	988	46	10	1971	72	311	7	330	362	29	26
PCE Adj:	1.00	1.00	1.00	1.00	1.00	1.00	1.00	1.00	1.00	1.00	1.00	1.00
MLF Adj:	1.00	1.00	1.00	1.00	1.00	1.00	1.00	1.00	1.00	1.00	1.00	1.00
FinalVolume:	212	988	46	10	1971	72	311	7	330	362	29	26
Saturation Flow Module:												
Sat/Lane:	1900	1900	1900	1900	1900	1900	1900	1900	1900	1900	1900	1900
Adjustment:	0.92	1.00	0.92	0.92	1.00	0.92	0.92	0.95	0.95	0.92	0.95	0.95
Lanes:	1.00	3.00	1.00	1.00	3.00	1.00	1.00	0.02	0.98	1.00	0.53	0.47
Final Sat.:	1750	5700	1750	1750	5700	1750	1750	37	1763	1750	949	851
Capacity Analysis Module:												
Vol/Sat:	0.12	0.17	0.03	0.01	0.35	0.04	0.18	0.19	0.19	0.21	0.03	0.03
Crit Moves:	****				****			****			****	
Green Time:	11.0	29.2	47.9	13.1	31.3	53.3	22.0	17.0	17.0	18.7	13.7	13.7
Volume/Cap:	0.99	0.53	0.05	0.04	0.99	0.07	0.73	0.99	0.99	0.99	0.20	0.20
Delay/Veh:	99.1	25.2	10.1	33.1	47.9	7.8	37.5	83.5	83.5	80.9	33.7	33.7
User DelAdj:	1.00	1.00	1.00	1.00	1.00	1.00	1.00	1.00	1.00	1.00	1.00	1.00
AdjDel/Veh:	99.1	25.2	10.1	33.1	47.9	7.8	37.5	83.5	83.5	80.9	33.7	33.7
LOS by Move:	F	C	B	C	D	A	D	F	F	F	C	C
HCM2k95thQ:	16	14	1	1	38	2	19	27	27	25	3	3

Note: Queue reported is the number of cars per lane.

BART Phase II Extension Project

Level Of Service Computation Report
 2000 HCM Operations (Future Volume Alternative)
 AM - 2035 Project Conditions

Intersection #106: Benton/EI Camino Real

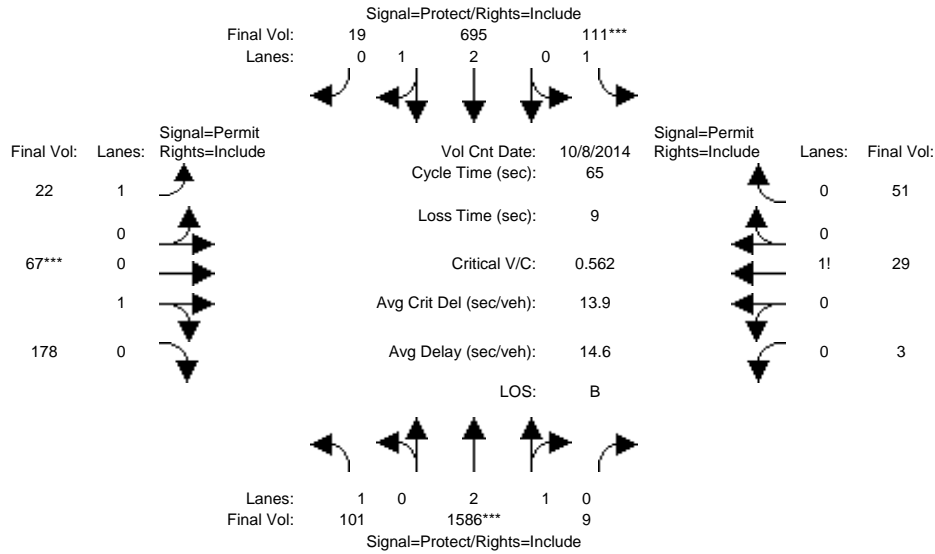

Approach:	North Bound			South Bound			East Bound			West Bound		
	L	T	R	L	T	R	L	T	R	L	T	R
Min. Green:	7	10	10	7	10	10	10	10	10	10	10	10
Y+R:	4.0	4.0	4.0	4.0	4.0	4.0	4.0	4.0	4.0	4.0	4.0	4.0

Volume Module:	>>	Count	Date:	8 Oct 2014	<<							
Base Vol:	101	1586	9	111	695	19	22	67	178	3	29	51
Growth Adj:	1.00	1.00	1.00	1.00	1.00	1.00	1.00	1.00	1.00	1.00	1.00	1.00
Initial Bse:	101	1586	9	111	695	19	22	67	178	3	29	51
Added Vol:	0	0	0	0	0	0	0	0	0	0	0	0
PasserByVol:	0	0	0	0	0	0	0	0	0	0	0	0
Initial Fut:	101	1586	9	111	695	19	22	67	178	3	29	51
User Adj:	1.00	1.00	1.00	1.00	1.00	1.00	1.00	1.00	1.00	1.00	1.00	1.00
PHF Adj:	1.00	1.00	1.00	1.00	1.00	1.00	1.00	1.00	1.00	1.00	1.00	1.00
PHF Volume:	101	1586	9	111	695	19	22	67	178	3	29	51
Reduct Vol:	0	0	0	0	0	0	0	0	0	0	0	0
Reduced Vol:	101	1586	9	111	695	19	22	67	178	3	29	51
PCE Adj:	1.00	1.00	1.00	1.00	1.00	1.00	1.00	1.00	1.00	1.00	1.00	1.00
MLF Adj:	1.00	1.00	1.00	1.00	1.00	1.00	1.00	1.00	1.00	1.00	1.00	1.00
Final Volume:	101	1586	9	111	695	19	22	67	178	3	29	51

Saturation Flow Module:	Sat/Lane:	1900	1900	1900	1900	1900	1900	1900	1900	1900	1900	1900
Adjustment:	0.92	0.98	0.95	0.92	0.98	0.95	0.92	0.95	0.95	0.92	0.92	0.92
Lanes:	1.00	2.98	0.02	1.00	2.92	0.08	1.00	0.27	0.73	0.04	0.35	0.61
Final Sat.:	1750	5568	32	1750	5451	149	1750	492	1308	63	611	1075

Capacity Analysis Module:	Vol/Sat:	0.06	0.28	0.28	0.06	0.13	0.13	0.01	0.14	0.14	0.05	0.05	0.05
Crit Moves:	****	****	****	****	****	****	****	****	****	****	****	****	****
Green Time:	16.6	32.9	32.9	7.3	23.7	23.7	15.7	15.7	15.7	15.7	15.7	15.7	15.7
Volume/Cap:	0.23	0.56	0.56	0.56	0.35	0.35	0.05	0.56	0.56	0.20	0.20	0.20	0.20
Delay/Veh:	19.4	11.3	11.3	31.0	15.2	15.2	19.0	23.3	23.3	19.8	19.8	19.8	19.8
User DelAdj:	1.00	1.00	1.00	1.00	1.00	1.00	1.00	1.00	1.00	1.00	1.00	1.00	1.00
AdjDel/Veh:	19.4	11.3	11.3	31.0	15.2	15.2	19.0	23.3	23.3	19.8	19.8	19.8	19.8
LOS by Move:	B	B	B	C	B	B	B	C	C	B	B	B	B
HCM2k95thQ:	3	14	14	5	7	7	1	9	9	3	3	3	3

Note: Queue reported is the number of cars per lane.

BART Phase II Extension Project

Level Of Service Computation Report
2000 HCM Operations (Future Volume Alternative)
PM - 2035 Project Conditions

Intersection #106: Benton/EI Camino Real

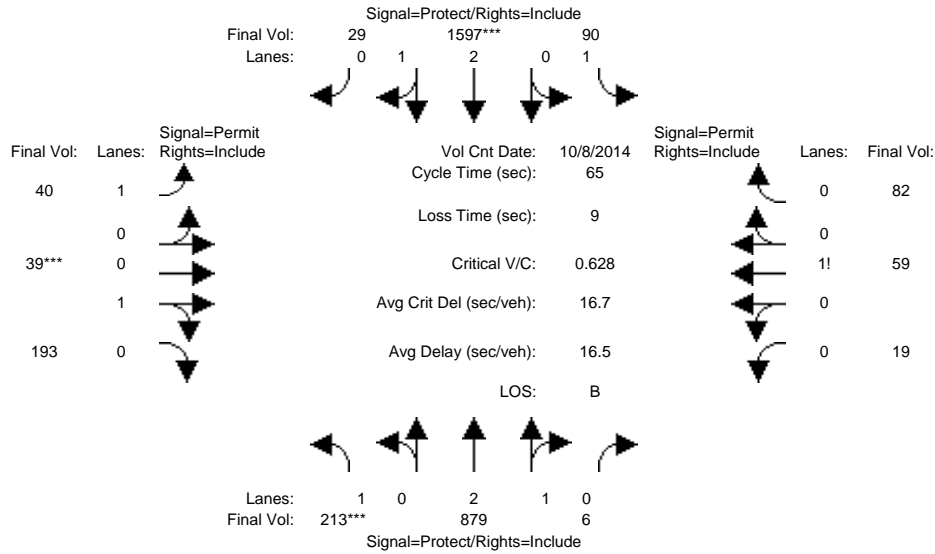

Approach:	North Bound			South Bound			East Bound			West Bound		
	L	T	R	L	T	R	L	T	R	L	T	R
Min. Green:	7	10	10	7	10	10	10	10	10	10	10	10
Y+R:	4.0	4.0	4.0	4.0	4.0	4.0	4.0	4.0	4.0	4.0	4.0	4.0

Volume Module: >> Count Date: 8 Oct 2014 <<

Base Vol:	213	879	6	90	1597	29	40	39	193	19	59	82
Growth Adj:	1.00	1.00	1.00	1.00	1.00	1.00	1.00	1.00	1.00	1.00	1.00	1.00
Initial Bse:	213	879	6	90	1597	29	40	39	193	19	59	82
Added Vol:	0	0	0	0	0	0	0	0	0	0	0	0
PasserByVol:	0	0	0	0	0	0	0	0	0	0	0	0
Initial Fut:	213	879	6	90	1597	29	40	39	193	19	59	82
User Adj:	1.00	1.00	1.00	1.00	1.00	1.00	1.00	1.00	1.00	1.00	1.00	1.00
PHF Adj:	1.00	1.00	1.00	1.00	1.00	1.00	1.00	1.00	1.00	1.00	1.00	1.00
PHF Volume:	213	879	6	90	1597	29	40	39	193	19	59	82
Reduct Vol:	0	0	0	0	0	0	0	0	0	0	0	0
Reduced Vol:	213	879	6	90	1597	29	40	39	193	19	59	82
PCE Adj:	1.00	1.00	1.00	1.00	1.00	1.00	1.00	1.00	1.00	1.00	1.00	1.00
MLF Adj:	1.00	1.00	1.00	1.00	1.00	1.00	1.00	1.00	1.00	1.00	1.00	1.00
FinalVolume:	213	879	6	90	1597	29	40	39	193	19	59	82

Saturation Flow Module:

Sat/Lane:	1900	1900	1900	1900	1900	1900	1900	1900	1900	1900	1900	1900
Adjustment:	0.92	0.98	0.95	0.92	0.98	0.95	0.92	0.95	0.95	0.92	0.92	0.92
Lanes:	1.00	2.98	0.02	1.00	2.94	0.06	1.00	0.17	0.83	0.12	0.37	0.51
Final Sat.:	1750	5562	38	1750	5500	100	1750	303	1497	208	645	897

Capacity Analysis Module:

Vol/Sat:	0.12	0.16	0.16	0.05	0.29	0.29	0.02	0.13	0.13	0.09	0.09	0.09
Crit Moves:	****			****			****					
Green Time:	12.6	25.4	25.4	17.3	30.1	30.1	13.3	13.3	13.3	13.3	13.3	13.3
Volume/Cap:	0.63	0.40	0.40	0.19	0.63	0.63	0.11	0.63	0.63	0.45	0.45	0.45
Delay/Veh:	27.8	14.5	14.5	18.7	13.7	13.7	21.1	27.0	27.0	23.5	23.5	23.5
User DelAdj:	1.00	1.00	1.00	1.00	1.00	1.00	1.00	1.00	1.00	1.00	1.00	1.00
AdjDel/Veh:	27.8	14.5	14.5	18.7	13.7	13.7	21.1	27.0	27.0	23.5	23.5	23.5
LOS by Move:	C	B	B	B	B	B	C	C	C	C	C	C
HCM2k95thQ:	8	8	8	3	16	16	1	9	9	7	7	7

Note: Queue reported is the number of cars per lane.

BART Phase II Extension Project

Level Of Service Computation Report
2000 HCM Operations (Future Volume Alternative)
AM - 2035 Project Conditions

Intersection #107: Benton/Lafayette

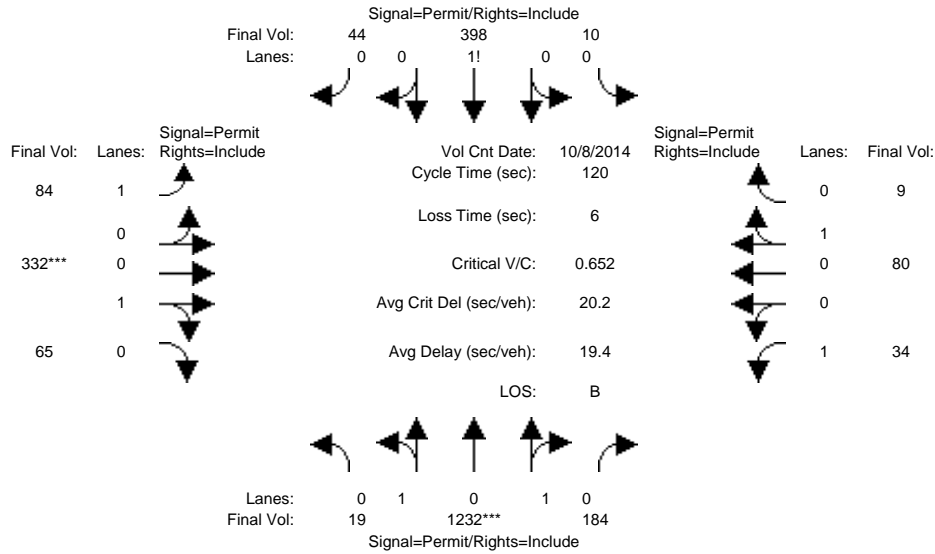

Approach:	North Bound			South Bound			East Bound			West Bound		
	L	T	R	L	T	R	L	T	R	L	T	R
Min. Green:	10	10	10	10	10	10	10	10	10	10	10	10
Y+R:	4.0	4.0	4.0	4.0	4.0	4.0	4.0	4.0	4.0	4.0	4.0	4.0
Volume Module: >> Count Date: 8 Oct 2014 <<												
Base Vol:	19	1232	184	10	398	44	84	332	65	34	80	9
Growth Adj:	1.00	1.00	1.00	1.00	1.00	1.00	1.00	1.00	1.00	1.00	1.00	1.00
Initial Bse:	19	1232	184	10	398	44	84	332	65	34	80	9
Added Vol:	0	0	0	0	0	0	0	0	0	0	0	0
PasserByVol:	0	0	0	0	0	0	0	0	0	0	0	0
Initial Fut:	19	1232	184	10	398	44	84	332	65	34	80	9
User Adj:	1.00	1.00	1.00	1.00	1.00	1.00	1.00	1.00	1.00	1.00	1.00	1.00
PHF Adj:	1.00	1.00	1.00	1.00	1.00	1.00	1.00	1.00	1.00	1.00	1.00	1.00
PHF Volume:	19	1232	184	10	398	44	84	332	65	34	80	9
Reduct Vol:	0	0	0	0	0	0	0	0	0	0	0	0
Reduced Vol:	19	1232	184	10	398	44	84	332	65	34	80	9
PCE Adj:	1.00	1.00	1.00	1.00	1.00	1.00	1.00	1.00	1.00	1.00	1.00	1.00
MLF Adj:	1.00	1.00	1.00	1.00	1.00	1.00	1.00	1.00	1.00	1.00	1.00	1.00
FinalVolume:	19	1232	184	10	398	44	84	332	65	34	80	9
Saturation Flow Module:												
Sat/Lane:	1900	1900	1900	1900	1900	1900	1900	1900	1900	1900	1900	1900
Adjustment:	0.95	0.95	0.95	0.92	0.92	0.92	0.92	0.95	0.95	0.92	0.95	0.95
Lanes:	0.03	1.72	0.25	0.02	0.88	0.10	1.00	0.84	0.16	1.00	0.90	0.10
Final Sat.:	48	3091	462	39	1541	170	1750	1505	295	1750	1618	182
Capacity Analysis Module:												
Vol/Sat:	0.40	0.40	0.40	0.26	0.26	0.26	0.05	0.22	0.22	0.02	0.05	0.05
Crit Moves:	****			****			****			****		
Green Time:	73.4	73.4	73.4	73.4	73.4	73.4	40.6	40.6	40.6	40.6	40.6	40.6
Volume/Cap:	0.65	0.65	0.65	0.42	0.42	0.42	0.14	0.65	0.65	0.06	0.15	0.15
Delay/Veh:	15.8	15.8	15.8	12.5	12.5	12.5	27.7	36.2	36.2	26.8	27.7	27.7
User DelAdj:	1.00	1.00	1.00	1.00	1.00	1.00	1.00	1.00	1.00	1.00	1.00	1.00
AdjDel/Veh:	15.8	15.8	15.8	12.5	12.5	12.5	27.7	36.2	36.2	26.8	27.7	27.7
LOS by Move:	B	B	B	B	B	B	C	D	D	C	C	C
HCM2k95thQ:	29	29	29	17	17	17	5	23	23	2	5	5

Note: Queue reported is the number of cars per lane.

BART Phase II Extension Project

Level Of Service Computation Report
2000 HCM Operations (Future Volume Alternative)
PM - 2035 Project Conditions

Intersection #107: Benton/Lafayette

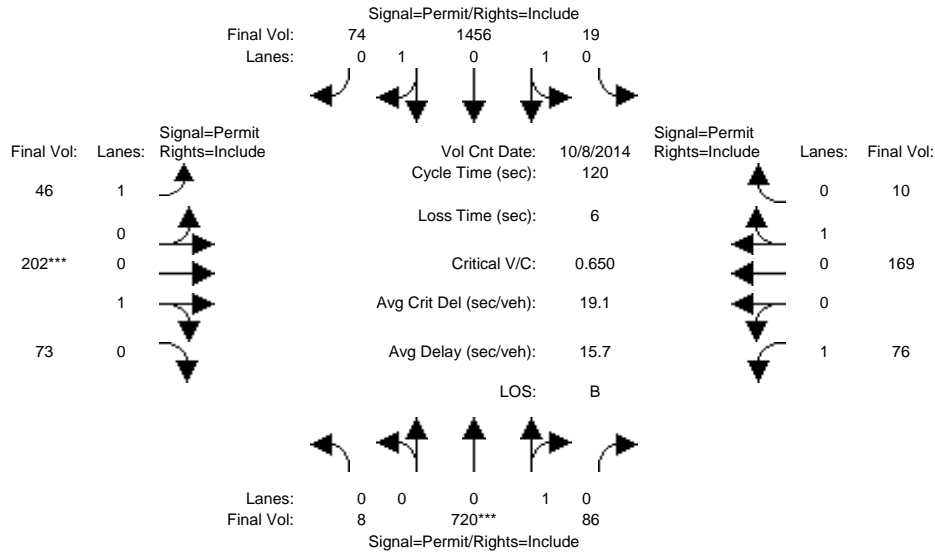

Approach:	North Bound			South Bound			East Bound			West Bound		
	L	T	R	L	T	R	L	T	R	L	T	R
Min. Green:	10	10	10	10	10	10	10	10	10	10	10	10
Y+R:	4.0	4.0	4.0	4.0	4.0	4.0	4.0	4.0	4.0	4.0	4.0	4.0
Volume Module: >> Count Date: 8 Oct 2014 <<												
Base Vol:	8	720	86	19	1456	74	46	202	73	76	169	10
Growth Adj:	1.00	1.00	1.00	1.00	1.00	1.00	1.00	1.00	1.00	1.00	1.00	1.00
Initial Bse:	8	720	86	19	1456	74	46	202	73	76	169	10
Added Vol:	0	0	0	0	0	0	0	0	0	0	0	0
PasserByVol:	0	0	0	0	0	0	0	0	0	0	0	0
Initial Fut:	8	720	86	19	1456	74	46	202	73	76	169	10
User Adj:	1.00	1.00	1.00	1.00	1.00	1.00	1.00	1.00	1.00	1.00	1.00	1.00
PHF Adj:	1.00	1.00	1.00	1.00	1.00	1.00	1.00	1.00	1.00	1.00	1.00	1.00
PHF Volume:	8	720	86	19	1456	74	46	202	73	76	169	10
Reduct Vol:	0	0	0	0	0	0	0	0	0	0	0	0
Reduced Vol:	8	720	86	19	1456	74	46	202	73	76	169	10
PCE Adj:	1.00	1.00	1.00	1.00	1.00	1.00	1.00	1.00	1.00	1.00	1.00	1.00
MLF Adj:	1.00	1.00	1.00	1.00	1.00	1.00	1.00	1.00	1.00	1.00	1.00	1.00
FinalVolume:	8	720	86	19	1456	74	46	202	73	76	169	10
Saturation Flow Module:												
Sat/Lane:	1900	1900	1900	1900	1900	1900	1900	1900	1900	1900	1900	1900
Adjustment:	0.92	0.92	0.92	0.95	0.95	0.95	0.92	0.95	0.95	0.92	0.95	0.95
Lanes:	0.01	0.88	0.11	0.02	1.88	0.10	1.00	0.73	0.27	1.00	0.94	0.06
Final Sat.:	17	1548	185	44	3384	172	1750	1322	478	1750	1699	101
Capacity Analysis Module:												
Vol/Sat:	0.47	0.47	0.47	0.43	0.43	0.43	0.03	0.15	0.15	0.04	0.10	0.10
Crit Moves:	****						****					
Green Time:	85.8	85.8	85.8	85.8	85.8	85.8	28.2	28.2	28.2	28.2	28.2	28.2
Volume/Cap:	0.65	0.65	0.65	0.60	0.60	0.60	0.11	0.65	0.65	0.18	0.42	0.42
Delay/Veh:	10.3	10.3	10.3	9.0	9.0	9.0	36.2	45.0	45.0	36.9	39.7	39.7
User DelAdj:	1.00	1.00	1.00	1.00	1.00	1.00	1.00	1.00	1.00	1.00	1.00	1.00
AdjDel/Veh:	10.3	10.3	10.3	9.0	9.0	9.0	36.2	45.0	45.0	36.9	39.7	39.7
LOS by Move:	B	B	B	A	A	A	D	D	D	D	D	D
HCM2k95thQ:	29	29	29	24	24	24	3	18	18	5	12	12

Note: Queue reported is the number of cars per lane.

BART Phase II Extension Project

Level Of Service Computation Report
2000 HCM Operations (Future Volume Alternative)
AM - 2035 Project Conditions

Intersection #175: Reed/De La Cruz

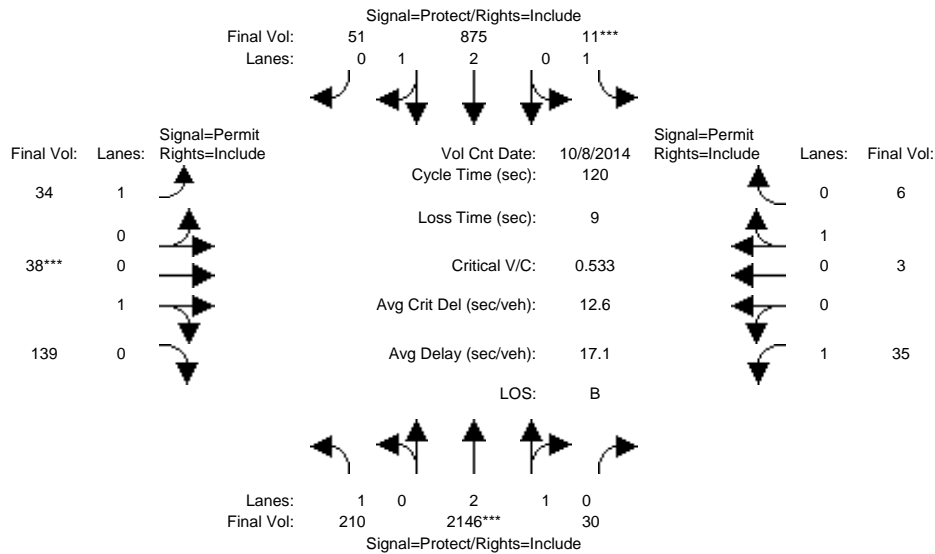

Approach:	North Bound			South Bound			East Bound			West Bound		
	L	T	R	L	T	R	L	T	R	L	T	R
Min. Green:	7	10	10	7	10	10	10	10	10	10	10	10
Y+R:	4.0	4.0	4.0	4.0	4.0	4.0	4.0	4.0	4.0	4.0	4.0	4.0
Volume Module: >> Count Date: 8 Oct 2014 <<												
Base Vol:	210	2146	30	11	875	51	34	38	139	35	3	6
Growth Adj:	1.00	1.00	1.00	1.00	1.00	1.00	1.00	1.00	1.00	1.00	1.00	1.00
Initial Bse:	210	2146	30	11	875	51	34	38	139	35	3	6
Added Vol:	0	0	0	0	0	0	0	0	0	0	0	0
PasserByVol:	0	0	0	0	0	0	0	0	0	0	0	0
Initial Fut:	210	2146	30	11	875	51	34	38	139	35	3	6
User Adj:	1.00	1.00	1.00	1.00	1.00	1.00	1.00	1.00	1.00	1.00	1.00	1.00
PHF Adj:	1.00	1.00	1.00	1.00	1.00	1.00	1.00	1.00	1.00	1.00	1.00	1.00
PHF Volume:	210	2146	30	11	875	51	34	38	139	35	3	6
Reduct Vol:	0	0	0	0	0	0	0	0	0	0	0	0
Reduced Vol:	210	2146	30	11	875	51	34	38	139	35	3	6
PCE Adj:	1.00	1.00	1.00	1.00	1.00	1.00	1.00	1.00	1.00	1.00	1.00	1.00
MLF Adj:	1.00	1.00	1.00	1.00	1.00	1.00	1.00	1.00	1.00	1.00	1.00	1.00
Final Volume:	210	2146	30	11	875	51	34	38	139	35	3	6
Saturation Flow Module:												
Sat/Lane:	1900	1900	1900	1900	1900	1900	1900	1900	1900	1900	1900	1900
Adjustment:	0.92	0.98	0.95	0.92	0.98	0.95	0.92	0.95	0.95	0.92	0.95	0.95
Lanes:	1.00	2.96	0.04	1.00	2.83	0.17	1.00	0.21	0.79	1.00	0.33	0.67
Final Sat.:	1750	5523	77	1750	5291	308	1750	386	1414	1750	600	1200
Capacity Analysis Module:												
Vol/Sat:	0.12	0.39	0.39	0.01	0.17	0.17	0.02	0.10	0.10	0.02	0.01	0.01
Crit Moves:	****			****			****					
Green Time:	37.8	83.0	83.0	7.0	52.2	52.2	21.0	21.0	21.0	21.0	21.0	21.0
Volume/Cap:	0.38	0.56	0.56	0.11	0.38	0.38	0.11	0.56	0.56	0.11	0.03	0.03
Delay/Veh:	32.4	9.5	9.5	54.0	23.1	23.1	41.8	47.6	47.6	41.8	41.1	41.1
User DelAdj:	1.00	1.00	1.00	1.00	1.00	1.00	1.00	1.00	1.00	1.00	1.00	1.00
AdjDel/Veh:	32.4	9.5	9.5	54.0	23.1	23.1	41.8	47.6	47.6	41.8	41.1	41.1
LOS by Move:	C	A	A	D	C	C	D	D	D	D	D	D
HCM2k95thQ:	13	24	24	1	14	14	2	12	12	2	1	1

Note: Queue reported is the number of cars per lane.

BART Phase II Extension Project

Level Of Service Computation Report
2000 HCM Operations (Future Volume Alternative)
PM - 2035 Project Conditions

Intersection #175: Reed/De La Cruz

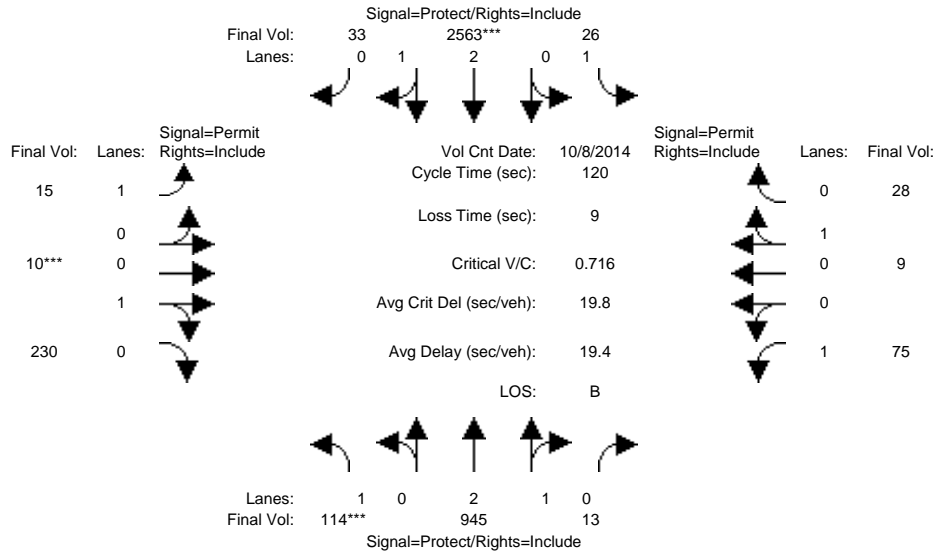

Approach:	North Bound			South Bound			East Bound			West Bound		
Movement:	L	T	R	L	T	R	L	T	R	L	T	R
Min. Green:	7	10	10	7	10	10	10	10	10	10	10	10
Y+R:	4.0	4.0	4.0	4.0	4.0	4.0	4.0	4.0	4.0	4.0	4.0	4.0
Volume Module: >> Count Date: 8 Oct 2014 <<												
Base Vol:	114	945	13	26	2563	33	15	10	230	75	9	28
Growth Adj:	1.00	1.00	1.00	1.00	1.00	1.00	1.00	1.00	1.00	1.00	1.00	1.00
Initial Bse:	114	945	13	26	2563	33	15	10	230	75	9	28
Added Vol:	0	0	0	0	0	0	0	0	0	0	0	0
PasserByVol:	0	0	0	0	0	0	0	0	0	0	0	0
Initial Fut:	114	945	13	26	2563	33	15	10	230	75	9	28
User Adj:	1.00	1.00	1.00	1.00	1.00	1.00	1.00	1.00	1.00	1.00	1.00	1.00
PHF Adj:	1.00	1.00	1.00	1.00	1.00	1.00	1.00	1.00	1.00	1.00	1.00	1.00
PHF Volume:	114	945	13	26	2563	33	15	10	230	75	9	28
Reduct Vol:	0	0	0	0	0	0	0	0	0	0	0	0
Reduced Vol:	114	945	13	26	2563	33	15	10	230	75	9	28
PCE Adj:	1.00	1.00	1.00	1.00	1.00	1.00	1.00	1.00	1.00	1.00	1.00	1.00
MLF Adj:	1.00	1.00	1.00	1.00	1.00	1.00	1.00	1.00	1.00	1.00	1.00	1.00
FinalVolume:	114	945	13	26	2563	33	15	10	230	75	9	28
Saturation Flow Module:												
Sat/Lane:	1900	1900	1900	1900	1900	1900	1900	1900	1900	1900	1900	1900
Adjustment:	0.92	0.98	0.95	0.92	0.98	0.95	0.92	0.95	0.95	0.92	0.95	0.95
Lanes:	1.00	2.96	0.04	1.00	2.96	0.04	1.00	0.04	0.96	1.00	0.24	0.76
Final Sat.:	1750	5524	76	1750	5529	71	1750	75	1725	1750	438	1362
Capacity Analysis Module:												
Vol/Sat:	0.07	0.17	0.17	0.01	0.46	0.46	0.01	0.13	0.13	0.04	0.02	0.02
Crit Moves:	****			****			****					
Green Time:	10.9	66.1	66.1	22.5	77.7	77.7	22.4	22.4	22.4	22.4	22.4	22.4
Volume/Cap:	0.72	0.31	0.31	0.08	0.72	0.72	0.05	0.72	0.72	0.23	0.11	0.11
Delay/Veh:	67.4	14.7	14.7	40.3	14.6	14.6	40.1	53.0	53.0	41.9	40.7	40.7
User DelAdj:	1.00	1.00	1.00	1.00	1.00	1.00	1.00	1.00	1.00	1.00	1.00	1.00
AdjDel/Veh:	67.4	14.7	14.7	40.3	14.6	14.6	40.1	53.0	53.0	41.9	40.7	40.7
LOS by Move:	E	B	B	D	B	B	D	D	D	D	D	D
HCM2k95thQ:	11	12	12	2	36	36	1	17	17	5	2	2

Note: Queue reported is the number of cars per lane.

BART Phase II Extension Project

Level Of Service Computation Report
 2000 HCM Unsignalized (Future Volume Alternative)
 AM - 2035 Project Conditions

Intersection #1008: Lafayette/Harrison

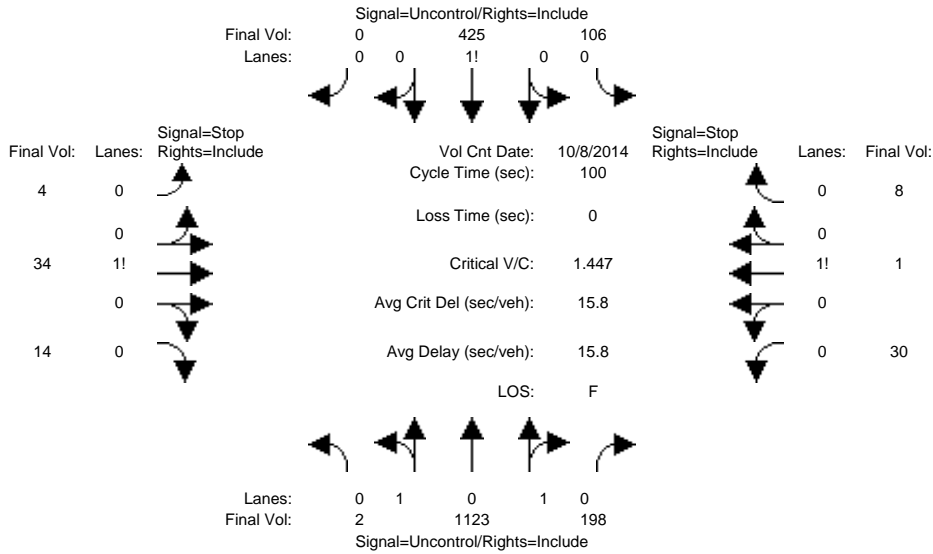

Approach:	North Bound			South Bound			East Bound			West Bound			
Movement:	L	T	R	L	T	R	L	T	R	L	T	R	
Volume Module: >> Count Date: 8 Oct 2014 <<													
Base Vol:	2	1123	198	106	425	0	4	34	14	30	1	8	
Growth Adj:	1.00	1.00	1.00	1.00	1.00	1.00	1.00	1.00	1.00	1.00	1.00	1.00	
Initial Bse:	2	1123	198	106	425	0	4	34	14	30	1	8	
Added Vol:	0	0	0	0	0	0	0	0	0	0	0	0	
PasserByVol:	0	0	0	0	0	0	0	0	0	0	0	0	
Initial Fut:	2	1123	198	106	425	0	4	34	14	30	1	8	
User Adj:	1.00	1.00	1.00	1.00	1.00	1.00	1.00	1.00	1.00	1.00	1.00	1.00	
PHF Adj:	1.00	1.00	1.00	1.00	1.00	1.00	1.00	1.00	1.00	1.00	1.00	1.00	
PHF Volume:	2	1123	198	106	425	0	4	34	14	30	1	8	
Reduct Vol:	0	0	0	0	0	0	0	0	0	0	0	0	
FinalVolume:	2	1123	198	106	425	0	4	34	14	30	1	8	
Critical Gap Module:													
Critical Gp:	4.1	xxxx	xxxxxx	4.1	xxxx	xxxxxx	7.1	6.5	6.2	7.1	6.5	6.2	
FollowUpTim:	2.2	xxxx	xxxxxx	2.2	xxxx	xxxxxx	3.5	4.0	3.3	3.5	4.0	3.3	
Capacity Module:													
Cnflct Vol:	425	xxxx	xxxxxx	1321	xxxx	xxxxxx	1203	1962	425	1887	1863	661	
Potent Cap.:	1145	xxxx	xxxxxx	530	xxxx	xxxxxx	163	64	634	54	74	466	
Move Cap.:	1145	xxxx	xxxxxx	530	xxxx	xxxxxx	132	50	634	21	58	466	
Volume/Cap:	0.00	xxxx	xxxx	0.20	xxxx	xxxx	0.03	0.68	0.02	1.45	0.02	0.02	
Level Of Service Module:													
2Way95thQ:	0.0	xxxx	xxxxxx	0.7	xxxx	xxxxxx	xxxx	xxxx	xxxxxx	xxxx	xxxx	xxxxxx	
Control Del:	8.1	xxxx	xxxxxx	13.5	xxxx	xxxxxx	xxxxxx	xxxx	xxxxxx	xxxxxx	xxxx	xxxxxx	
LOS by Move:	A	*	*	B	*	*	*	*	*	*	*	*	
Movement:	LT - LTR - RT	LT - LTR - RT			LT - LTR - RT			LT - LTR - RT			LT - LTR - RT		
Shared Cap.:	xxxx	xxxx	xxxxxx	xxxx	xxxx	xxxxxx	xxxx	71	xxxxxx	xxxx	26	xxxxxx	
SharedQueue:	0.0	xxxx	xxxxxx	0.7	xxxx	xxxxxx	xxxxxx	3.4	xxxxxx	xxxxxx	4.7	xxxxxx	
Shrd ConDel:	8.1	xxxx	xxxxxx	13.5	xxxx	xxxxxx	xxxxxx	137	xxxxxx	xxxxxx	571	xxxxxx	
Shared LOS:	A	*	*	B	*	*	*	F	*	*	F	*	
ApproachDel:	xxxxxxx	xxxxxxx			136.6			571.0					
ApproachLOS:	*	*			F			F					

Note: Queue reported is the number of cars per lane.

BART Phase II Extension Project

Level Of Service Computation Report
2000 HCM Unsignalized (Future Volume Alternative)
PM - 2035 Project Conditions

Intersection #1008: Lafayette/Harrison

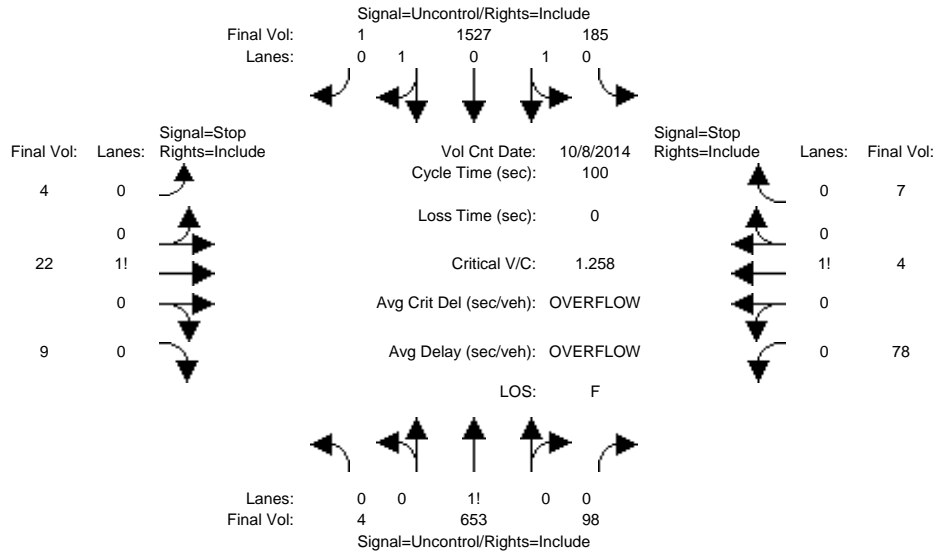

Approach:	North Bound			South Bound			East Bound			West Bound			
Movement:	L	T	R	L	T	R	L	T	R	L	T	R	
Volume Module: >> Count Date: 8 Oct 2014 <<													
Base Vol:	4	653	98	185	1527	1	4	22	9	78	4	7	
Growth Adj:	1.00	1.00	1.00	1.00	1.00	1.00	1.00	1.00	1.00	1.00	1.00	1.00	
Initial Bse:	4	653	98	185	1527	1	4	22	9	78	4	7	
Added Vol:	0	0	0	0	0	0	0	0	0	0	0	0	
PasserByVol:	0	0	0	0	0	0	0	0	0	0	0	0	
Initial Fut:	4	653	98	185	1527	1	4	22	9	78	4	7	
User Adj:	1.00	1.00	1.00	1.00	1.00	1.00	1.00	1.00	1.00	1.00	1.00	1.00	
PHF Adj:	1.00	1.00	1.00	1.00	1.00	1.00	1.00	1.00	1.00	1.00	1.00	1.00	
PHF Volume:	4	653	98	185	1527	1	4	22	9	78	4	7	
Reduct Vol:	0	0	0	0	0	0	0	0	0	0	0	0	
FinalVolume:	4	653	98	185	1527	1	4	22	9	78	4	7	
Critical Gap Module:													
Critical Gp:	4.1	xxxx	xxxxxx	4.1	xxxx	xxxxxx	7.1	6.5	6.2	7.1	6.5	6.2	
FollowUpTim:	2.2	xxxx	xxxxxx	2.2	xxxx	xxxxxx	3.5	4.0	3.3	3.5	4.0	3.3	
Capacity Module:													
Cnflct Vol:	1528	xxxx	xxxxxx	751	xxxx	xxxxxx	2613	2657	764	1855	2608	702	
Potent Cap.:	442	xxxx	xxxxxx	868	xxxx	xxxxxx	16	23	407	57	25	442	
Move Cap.:	442	xxxx	xxxxxx	868	xxxx	xxxxxx	11	17	407	0	19	442	
Volume/Cap:	0.01	xxxx	xxxx	0.21	xxxx	xxxx	0.36	1.26	0.02	xxxx	0.21	0.02	
Level Of Service Module:													
2Way95thQ:	0.0	xxxx	xxxxxx	0.8	xxxx	xxxxxx	xxxx	xxxx	xxxxxx	xxxx	xxxx	xxxxxx	
Control Del:	13.2	xxxx	xxxxxx	10.3	xxxx	xxxxxx	xxxxxx	xxxx	xxxxxx	xxxxxx	xxxx	xxxxxx	
LOS by Move:	B	*	*	B	*	*	*	*	*	*	*	*	
Movement:	LT - LTR - RT				LT - LTR - RT				LT - LTR - RT				LT - LTR - RT
Shared Cap.:	xxxx	xxxx	xxxxxx	xxxx	xxxx	xxxxxx	xxxx	21	xxxxxx	xxxx	0	xxxxxx	
SharedQueue:	xxxxxx	xxxx	xxxxxx	0.8	xxxx	xxxxxx	xxxxxx	4.6	xxxxxx	xxxxxx	xxxx	xxxxxx	
Shrd ConDel:	xxxxxx	xxxx	xxxxxx	10.3	xxxx	xxxxxx	xxxxxx	701	xxxxxx	xxxxxx	xxxx	xxxxxx	
Shared LOS:	*	*	*	B	*	*	*	F	*	*	*	*	
ApproachDel:	xxxxxxx				xxxxxxx				700.6				xxxxxxx
ApproachLOS:	*				*				F				F

Note: Queue reported is the number of cars per lane.

BART Phase II Extension Project

Level Of Service Computation Report
2000 HCM Operations (Future Volume Alternative)
AM - 2035 Project Conditions

Intersection #1012: El Camino Real/Railroad Ave

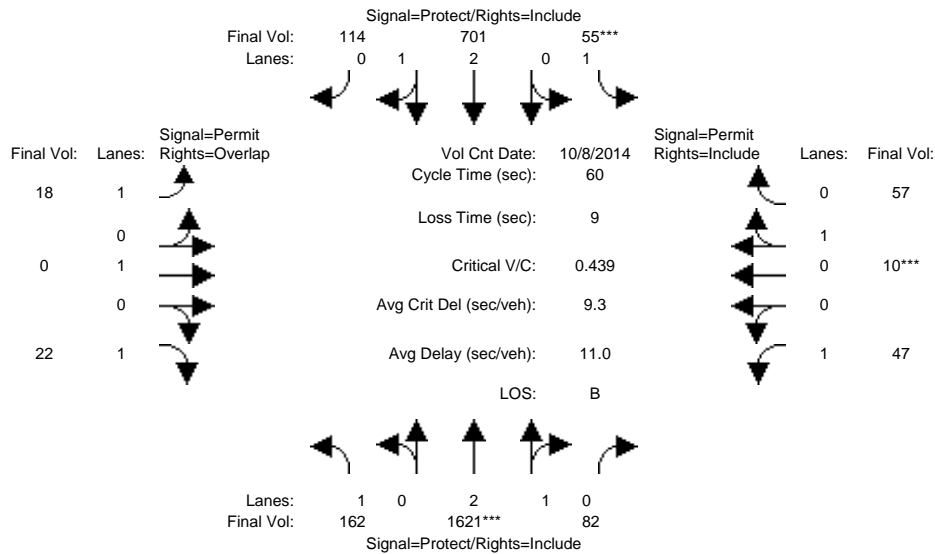

Approach:	North Bound			South Bound			East Bound			West Bound		
	L	T	R	L	T	R	L	T	R	L	T	R
Min. Green:	7	10	10	7	10	10	10	10	10	10	10	10
Y+R:	4.0	4.0	4.0	4.0	4.0	4.0	4.0	4.0	4.0	4.0	4.0	4.0
Volume Module: >> Count Date: 8 Oct 2014 <<												
Base Vol:	162	1621	82	55	701	114	18	0	22	47	10	57
Growth Adj:	1.00	1.00	1.00	1.00	1.00	1.00	1.00	1.00	1.00	1.00	1.00	1.00
Initial Bse:	162	1621	82	55	701	114	18	0	22	47	10	57
Added Vol:	0	0	0	0	0	0	0	0	0	0	0	0
PasserByVol:	0	0	0	0	0	0	0	0	0	0	0	0
Initial Fut:	162	1621	82	55	701	114	18	0	22	47	10	57
User Adj:	1.00	1.00	1.00	1.00	1.00	1.00	1.00	1.00	1.00	1.00	1.00	1.00
PHF Adj:	1.00	1.00	1.00	1.00	1.00	1.00	1.00	1.00	1.00	1.00	1.00	1.00
PHF Volume:	162	1621	82	55	701	114	18	0	22	47	10	57
Reduct Vol:	0	0	0	0	0	0	0	0	0	0	0	0
Reduced Vol:	162	1621	82	55	701	114	18	0	22	47	10	57
PCE Adj:	1.00	1.00	1.00	1.00	1.00	1.00	1.00	1.00	1.00	1.00	1.00	1.00
MLF Adj:	1.00	1.00	1.00	1.00	1.00	1.00	1.00	1.00	1.00	1.00	1.00	1.00
FinalVolume:	162	1621	82	55	701	114	18	0	22	47	10	57
Saturation Flow Module:												
Sat/Lane:	1900	1900	1900	1900	1900	1900	1900	1900	1900	1900	1900	1900
Adjustment:	0.92	0.98	0.95	0.92	0.99	0.95	0.92	1.00	0.92	0.92	0.95	0.95
Lanes:	1.00	2.85	0.15	1.00	2.56	0.44	1.00	1.00	1.00	1.00	0.15	0.85
Final Sat.:	1750	5330	270	1750	4816	783	1750	1900	1750	1750	269	1531
Capacity Analysis Module:												
Vol/Sat:	0.09	0.30	0.30	0.03	0.15	0.15	0.01	0.00	0.01	0.03	0.04	0.04
Crit Moves:	****			****						****		
Green Time:	16.9	34.0	34.0	7.0	24.1	24.1	10.0	0.0	26.9	10.0	10.0	10.0
Volume/Cap:	0.33	0.54	0.54	0.27	0.36	0.36	0.06	0.00	0.03	0.16	0.22	0.22
Delay/Veh:	17.5	8.3	8.3	24.9	12.7	12.7	21.1	0.0	9.3	21.7	22.0	22.0
User DelAdj:	1.00	1.00	1.00	1.00	1.00	1.00	1.00	1.00	1.00	1.00	1.00	1.00
AdjDel/Veh:	17.5	8.3	8.3	24.9	12.7	12.7	21.1	0.0	9.3	21.7	22.0	22.0
LOS by Move:	B	A	A	C	B	B	C	A	A	C	C	C
HCM2k95thQ:	6	14	14	2	7	7	1	0	1	2	3	3

Note: Queue reported is the number of cars per lane.

BART Phase II Extension Project

Level Of Service Computation Report
2000 HCM Operations (Future Volume Alternative)
PM - 2035 Project Conditions

Intersection #1012: El Camino Real/Railroad Ave

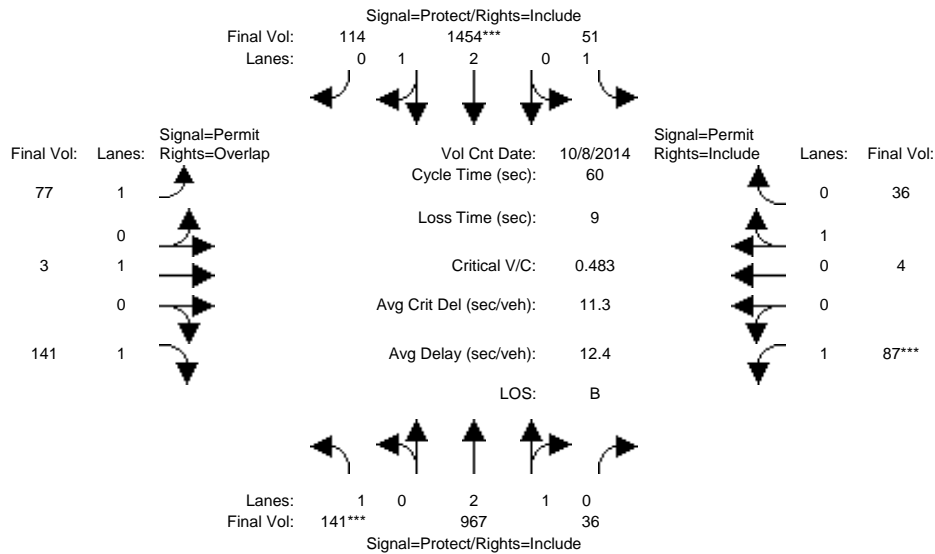

Approach:	North Bound			South Bound			East Bound			West Bound		
Movement:	L	T	R	L	T	R	L	T	R	L	T	R
Min. Green:	7	10	10	7	10	10	10	10	10	10	10	10
Y+R:	4.0	4.0	4.0	4.0	4.0	4.0	4.0	4.0	4.0	4.0	4.0	4.0
Volume Module: >> Count Date: 8 Oct 2014 <<												
Base Vol:	141	967	36	51	1454	114	77	3	141	87	4	36
Growth Adj:	1.00	1.00	1.00	1.00	1.00	1.00	1.00	1.00	1.00	1.00	1.00	1.00
Initial Bse:	141	967	36	51	1454	114	77	3	141	87	4	36
Added Vol:	0	0	0	0	0	0	0	0	0	0	0	0
PasserByVol:	0	0	0	0	0	0	0	0	0	0	0	0
Initial Fut:	141	967	36	51	1454	114	77	3	141	87	4	36
User Adj:	1.00	1.00	1.00	1.00	1.00	1.00	1.00	1.00	1.00	1.00	1.00	1.00
PHF Adj:	1.00	1.00	1.00	1.00	1.00	1.00	1.00	1.00	1.00	1.00	1.00	1.00
PHF Volume:	141	967	36	51	1454	114	77	3	141	87	4	36
Reduct Vol:	0	0	0	0	0	0	0	0	0	0	0	0
Reduced Vol:	141	967	36	51	1454	114	77	3	141	87	4	36
PCE Adj:	1.00	1.00	1.00	1.00	1.00	1.00	1.00	1.00	1.00	1.00	1.00	1.00
MLF Adj:	1.00	1.00	1.00	1.00	1.00	1.00	1.00	1.00	1.00	1.00	1.00	1.00
Final Volume:	141	967	36	51	1454	114	77	3	141	87	4	36
Saturation Flow Module:												
Sat/Lane:	1900	1900	1900	1900	1900	1900	1900	1900	1900	1900	1900	1900
Adjustment:	0.92	0.98	0.95	0.92	0.99	0.95	0.92	1.00	0.92	0.92	0.95	0.95
Lanes:	1.00	2.89	0.11	1.00	2.77	0.23	1.00	1.00	1.00	1.00	0.10	0.90
Final Sat.:	1750	5399	201	1750	5192	407	1750	1900	1750	1750	180	1620
Capacity Analysis Module:												
Vol/Sat:	0.08	0.18	0.18	0.03	0.28	0.28	0.04	0.00	0.08	0.05	0.02	0.02
Crit Moves:	****				****					****		
Green Time:	9.2	24.8	24.8	16.2	31.8	31.8	10.0	10.0	19.2	10.0	10.0	10.0
Volume/Cap:	0.53	0.43	0.43	0.11	0.53	0.53	0.26	0.01	0.25	0.30	0.13	0.13
Delay/Veh:	25.4	12.7	12.7	16.6	9.4	9.4	22.3	20.9	15.4	22.5	21.5	21.5
User DelAdj:	1.00	1.00	1.00	1.00	1.00	1.00	1.00	1.00	1.00	1.00	1.00	1.00
AdjDel/Veh:	25.4	12.7	12.7	16.6	9.4	9.4	22.3	20.9	15.4	22.5	21.5	21.5
LOS by Move:	C	B	B	B	A	A	C	C	B	C	C	C
HCM2k95thQ:	7	9	9	2	12	12	3	0	5	4	2	2

Note: Queue reported is the number of cars per lane.

BART Phase II Extension Project

Level Of Service Computation Report
2000 HCM Operations (Future Volume Alternative)
AM - 2035 Project Conditions

Intersection #1202: LAFAYETTE/EL CAMINO REAL

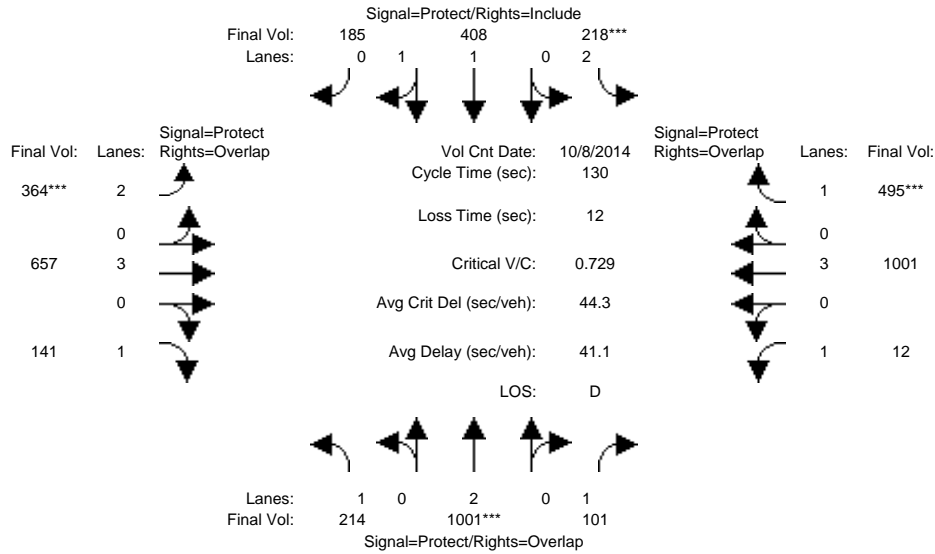

Approach:	North Bound			South Bound			East Bound			West Bound		
	L	T	R	L	T	R	L	T	R	L	T	R
Min. Green:	7	10	10	7	10	10	7	10	10	7	10	10
Y+R:	4.0	4.0	4.0	4.0	4.0	4.0	4.0	4.0	4.0	4.0	4.0	4.0

Volume Module:	>> Count Date: 8 Oct 2014 <<											
Base Vol:	214	1001	101	218	408	185	364	657	141	12	1001	495
Growth Adj:	1.00	1.00	1.00	1.00	1.00	1.00	1.00	1.00	1.00	1.00	1.00	1.00
Initial Bse:	214	1001	101	218	408	185	364	657	141	12	1001	495
Added Vol:	0	0	0	0	0	0	0	0	0	0	0	0
PasserByVol:	0	0	0	0	0	0	0	0	0	0	0	0
Initial Fut:	214	1001	101	218	408	185	364	657	141	12	1001	495
User Adj:	1.00	1.00	1.00	1.00	1.00	1.00	1.00	1.00	1.00	1.00	1.00	1.00
PHF Adj:	1.00	1.00	1.00	1.00	1.00	1.00	1.00	1.00	1.00	1.00	1.00	1.00
PHF Volume:	214	1001	101	218	408	185	364	657	141	12	1001	495
Reduct Vol:	0	0	0	0	0	0	0	0	0	0	0	0
Reduced Vol:	214	1001	101	218	408	185	364	657	141	12	1001	495
PCE Adj:	1.00	1.00	1.00	1.00	1.00	1.00	1.00	1.00	1.00	1.00	1.00	1.00
MLF Adj:	1.00	1.00	1.00	1.00	1.00	1.00	1.00	1.00	1.00	1.00	1.00	1.00
FinalVolume:	214	1001	101	218	408	185	364	657	141	12	1001	495

Saturation Flow Module:												
Sat/Lane:	1900	1900	1900	1900	1900	1900	1900	1900	1900	1900	1900	1900
Adjustment:	0.92	1.00	0.92	0.83	0.99	0.95	0.83	1.00	0.92	0.92	1.00	0.92
Lanes:	1.00	2.00	1.00	2.00	1.36	0.64	2.00	3.00	1.00	1.00	3.00	1.00
Final Sat.:	1750	3800	1750	3150	2545	1154	3150	5700	1750	1750	5700	1750

Capacity Analysis Module:												
Vol/Sat:	0.12	0.26	0.06	0.07	0.16	0.16	0.12	0.12	0.08	0.01	0.18	0.28
Crit Moves:	****	****	****	****	****	****	****	****	****	****	****	****
Green Time:	25.7	47.0	65.7	12.3	33.6	33.6	20.6	40.0	65.7	18.7	38.1	50.4
Volume/Cap:	0.62	0.73	0.11	0.73	0.62	0.62	0.73	0.37	0.16	0.05	0.60	0.73
Delay/Veh:	51.1	38.0	17.0	66.0	43.8	43.8	57.4	35.3	17.4	48.1	40.0	38.0
User DelAdj:	1.00	1.00	1.00	1.00	1.00	1.00	1.00	1.00	1.00	1.00	1.00	1.00
AdjDel/Veh:	51.1	38.0	17.0	66.0	43.8	43.8	57.4	35.3	17.4	48.1	40.0	38.0
LOS by Move:	D	D	B	E	D	D	E	D	B	D	D	D
HCM2k95thQ:	16	30	4	10	19	19	16	12	6	1	21	32

Note: Queue reported is the number of cars per lane.

BART Phase II Extension Project

Level Of Service Computation Report
 2000 HCM Operations (Future Volume Alternative)
 PM - 2035 Project Conditions

Intersection #1202: LAFAYETTE/EL CAMINO REAL

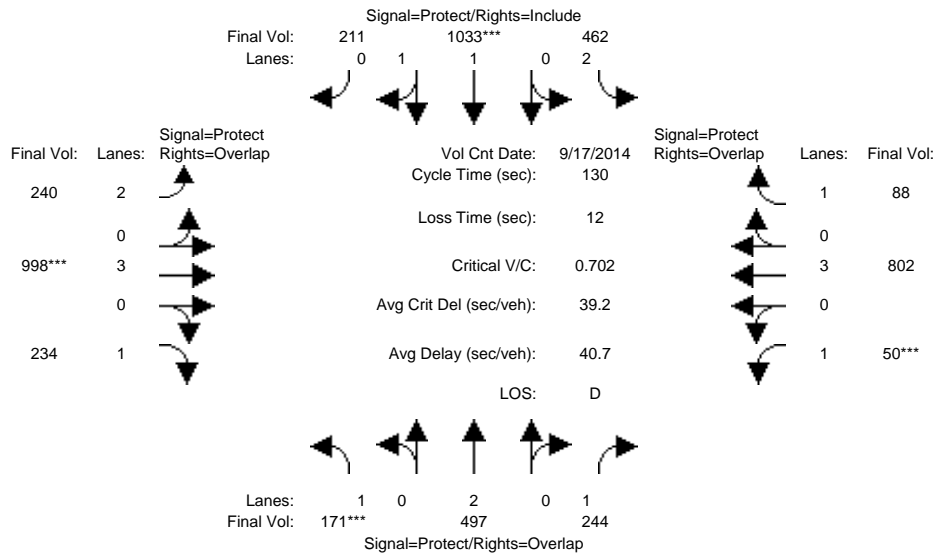

Approach:	North Bound			South Bound			East Bound			West Bound		
	L	T	R	L	T	R	L	T	R	L	T	R
Min. Green:	7	10	10	7	10	10	7	10	10	7	10	10
Y+R:	4.0	4.0	4.0	4.0	4.0	4.0	4.0	4.0	4.0	4.0	4.0	4.0

Volume Module:	>>	Count	Date:	17 Sep 2014	<<							
Base Vol:	171	497	244	462	1033	211	240	998	234	50	802	88
Growth Adj:	1.00	1.00	1.00	1.00	1.00	1.00	1.00	1.00	1.00	1.00	1.00	1.00
Initial Bse:	171	497	244	462	1033	211	240	998	234	50	802	88
Added Vol:	0	0	0	0	0	0	0	0	0	0	0	0
PasserByVol:	0	0	0	0	0	0	0	0	0	0	0	0
Initial Fut:	171	497	244	462	1033	211	240	998	234	50	802	88
User Adj:	1.00	1.00	1.00	1.00	1.00	1.00	1.00	1.00	1.00	1.00	1.00	1.00
PHF Adj:	1.00	1.00	1.00	1.00	1.00	1.00	1.00	1.00	1.00	1.00	1.00	1.00
PHF Volume:	171	497	244	462	1033	211	240	998	234	50	802	88
Reduct Vol:	0	0	0	0	0	0	0	0	0	0	0	0
Reduced Vol:	171	497	244	462	1033	211	240	998	234	50	802	88
PCE Adj:	1.00	1.00	1.00	1.00	1.00	1.00	1.00	1.00	1.00	1.00	1.00	1.00
MLF Adj:	1.00	1.00	1.00	1.00	1.00	1.00	1.00	1.00	1.00	1.00	1.00	1.00
FinalVolume:	171	497	244	462	1033	211	240	998	234	50	802	88

Saturation Flow Module:												
Sat/Lane:	1900	1900	1900	1900	1900	1900	1900	1900	1900	1900	1900	1900
Adjustment:	0.92	1.00	0.92	0.83	0.98	0.95	0.83	1.00	0.92	0.92	1.00	0.92
Lanes:	1.00	2.00	1.00	2.00	1.65	0.35	2.00	3.00	1.00	1.00	3.00	1.00
Final Sat.:	1750	3800	1750	3150	3072	627	3150	5700	1750	1750	5700	1750

Capacity Analysis Module:												
Vol/Sat:	0.10	0.13	0.14	0.15	0.34	0.34	0.08	0.18	0.13	0.03	0.14	0.05
Crit Moves:	****			****			****			****		
Green Time:	17.8	37.3	44.3	41.8	61.3	61.3	13.7	31.9	49.7	7.0	25.2	67.0
Volume/Cap:	0.71	0.46	0.41	0.46	0.71	0.71	0.72	0.71	0.35	0.53	0.72	0.10
Delay/Veh:	63.4	38.3	33.3	35.4	28.8	28.8	64.1	46.6	28.9	65.6	51.5	16.1
User DelAdj:	1.00	1.00	1.00	1.00	1.00	1.00	1.00	1.00	1.00	1.00	1.00	1.00
AdjDel/Veh:	63.4	38.3	33.3	35.4	28.8	28.8	64.1	46.6	28.9	65.6	51.5	16.1
LOS by Move:	E	D	C	D	C	C	E	D	C	E	D	B
HCM2k95thQ:	14	15	15	16	34	34	11	22	13	6	21	4

Note: Queue reported is the number of cars per lane.

BART Phase II Extension Project

Level Of Service Computation Report
2000 HCM Operations (Future Volume Alternative)
AM - 2035 Project Conditions

Intersection #1204: MONROE/EL CAMINO REAL

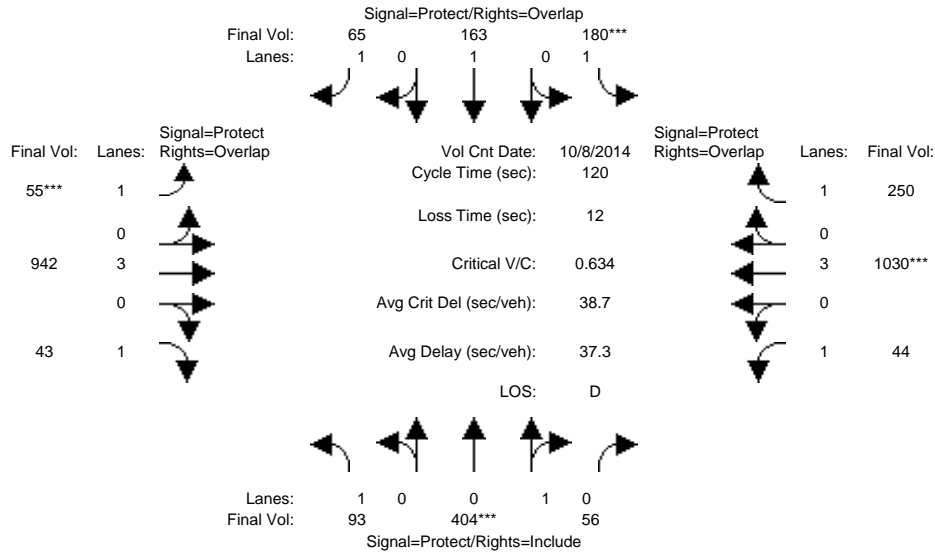

Approach:	North Bound			South Bound			East Bound			West Bound		
Movement:	L	T	R	L	T	R	L	T	R	L	T	R
Min. Green:	7	10	10	7	10	10	7	10	10	7	10	10
Y+R:	4.0	4.0	4.0	4.0	4.0	4.0	4.0	4.0	4.0	4.0	4.0	4.0
Volume Module: >> Count Date: 8 Oct 2014 <<												
Base Vol:	93	404	56	180	163	65	55	942	43	44	1030	250
Growth Adj:	1.00	1.00	1.00	1.00	1.00	1.00	1.00	1.00	1.00	1.00	1.00	1.00
Initial Bse:	93	404	56	180	163	65	55	942	43	44	1030	250
Added Vol:	0	0	0	0	0	0	0	0	0	0	0	0
PasserByVol:	0	0	0	0	0	0	0	0	0	0	0	0
Initial Fut:	93	404	56	180	163	65	55	942	43	44	1030	250
User Adj:	1.00	1.00	1.00	1.00	1.00	1.00	1.00	1.00	1.00	1.00	1.00	1.00
PHF Adj:	1.00	1.00	1.00	1.00	1.00	1.00	1.00	1.00	1.00	1.00	1.00	1.00
PHF Volume:	93	404	56	180	163	65	55	942	43	44	1030	250
Reduct Vol:	0	0	0	0	0	0	0	0	0	0	0	0
Reduced Vol:	93	404	56	180	163	65	55	942	43	44	1030	250
PCE Adj:	1.00	1.00	1.00	1.00	1.00	1.00	1.00	1.00	1.00	1.00	1.00	1.00
MLF Adj:	1.00	1.00	1.00	1.00	1.00	1.00	1.00	1.00	1.00	1.00	1.00	1.00
FinalVolume:	93	404	56	180	163	65	55	942	43	44	1030	250
Saturation Flow Module:												
Sat/Lane:	1900	1900	1900	1900	1900	1900	1900	1900	1900	1900	1900	1900
Adjustment:	0.92	0.95	0.95	0.92	1.00	0.92	0.92	1.00	0.92	0.92	1.00	0.92
Lanes:	1.00	0.88	0.12	1.00	1.00	1.00	1.00	3.00	1.00	1.00	3.00	1.00
Final Sat.:	1750	1581	219	1750	1900	1750	1750	5700	1750	1750	5700	1750
Capacity Analysis Module:												
Vol/Sat:	0.05	0.26	0.26	0.10	0.09	0.04	0.03	0.17	0.02	0.03	0.18	0.14
Crit Moves:	****	****	****	****	****	****	****	****	****	****	****	****
Green Time:	27.2	47.9	47.9	19.3	40.0	47.0	7.0	30.2	57.4	10.7	33.9	53.1
Volume/Cap:	0.23	0.64	0.64	0.64	0.26	0.09	0.54	0.66	0.05	0.28	0.64	0.32
Delay/Veh:	38.2	31.1	31.1	52.1	29.4	23.1	60.6	41.4	16.8	52.1	38.6	22.0
User DelAdj:	1.00	1.00	1.00	1.00	1.00	1.00	1.00	1.00	1.00	1.00	1.00	1.00
AdjDel/Veh:	38.2	31.1	31.1	52.1	29.4	23.1	60.6	41.4	16.8	52.1	38.6	22.0
LOS by Move:	D	C	C	D	C	C	E	D	B	D	D	C
HCM2k95thQ:	6	26	26	13	8	3	4	19	2	3	20	12

Note: Queue reported is the number of cars per lane.

BART Phase II Extension Project

Level Of Service Computation Report
2000 HCM Operations (Future Volume Alternative)
PM - 2035 Project Conditions

Intersection #1204: MONROE/EL CAMINO REAL

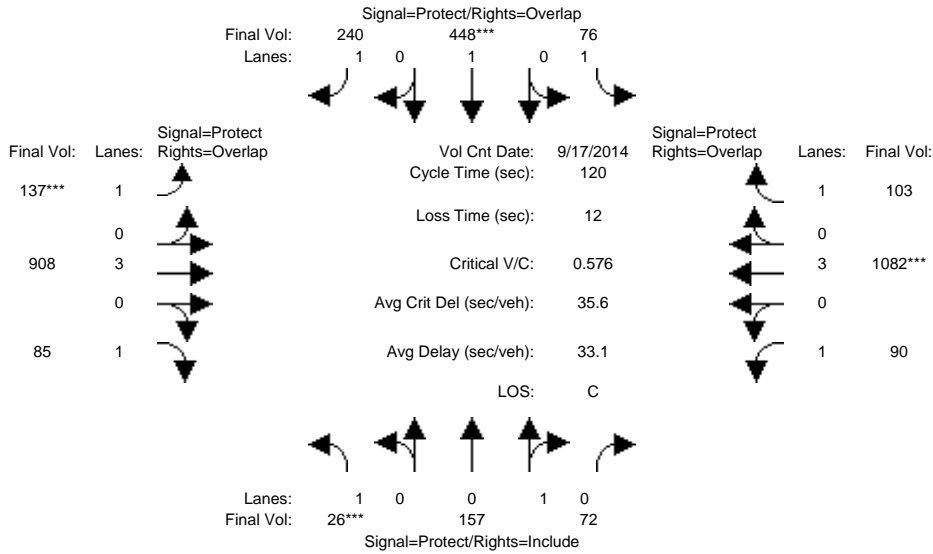

Approach:	North Bound			South Bound			East Bound			West Bound		
	L	T	R	L	T	R	L	T	R	L	T	R
Min. Green:	7	10	10	7	10	10	7	10	10	7	10	10
Y+R:	4.0	4.0	4.0	4.0	4.0	4.0	4.0	4.0	4.0	4.0	4.0	4.0
Volume Module: >> Count Date: 17 Sep 2014 <<												
Base Vol:	26	157	72	76	448	240	137	908	85	90	1082	103
Growth Adj:	1.00	1.00	1.00	1.00	1.00	1.00	1.00	1.00	1.00	1.00	1.00	1.00
Initial Bse:	26	157	72	76	448	240	137	908	85	90	1082	103
Added Vol:	0	0	0	0	0	0	0	0	0	0	0	0
PasserByVol:	0	0	0	0	0	0	0	0	0	0	0	0
Initial Fut:	26	157	72	76	448	240	137	908	85	90	1082	103
User Adj:	1.00	1.00	1.00	1.00	1.00	1.00	1.00	1.00	1.00	1.00	1.00	1.00
PHF Adj:	1.00	1.00	1.00	1.00	1.00	1.00	1.00	1.00	1.00	1.00	1.00	1.00
PHF Volume:	26	157	72	76	448	240	137	908	85	90	1082	103
Reduct Vol:	0	0	0	0	0	0	0	0	0	0	0	0
Reduced Vol:	26	157	72	76	448	240	137	908	85	90	1082	103
PCE Adj:	1.00	1.00	1.00	1.00	1.00	1.00	1.00	1.00	1.00	1.00	1.00	1.00
MLF Adj:	1.00	1.00	1.00	1.00	1.00	1.00	1.00	1.00	1.00	1.00	1.00	1.00
FinalVolume:	26	157	72	76	448	240	137	908	85	90	1082	103
Saturation Flow Module:												
Sat/Lane:	1900	1900	1900	1900	1900	1900	1900	1900	1900	1900	1900	1900
Adjustment:	0.92	0.95	0.95	0.92	1.00	0.92	0.92	1.00	0.92	0.92	1.00	0.92
Lanes:	1.00	0.69	0.31	1.00	1.00	1.00	1.00	3.00	1.00	1.00	3.00	1.00
Final Sat.:	1750	1234	566	1750	1900	1750	1750	5700	1750	1750	5700	1750
Capacity Analysis Module:												
Vol/Sat:	0.01	0.13	0.13	0.04	0.24	0.14	0.08	0.16	0.05	0.05	0.19	0.06
Crit Moves:	****			****			****			****		
Green Time:	7.0	37.2	37.2	17.1	47.3	63.0	15.7	39.3	46.3	14.4	38.0	55.1
Volume/Cap:	0.25	0.41	0.41	0.31	0.60	0.26	0.60	0.49	0.13	0.43	0.60	0.13
Delay/Veh:	55.3	33.2	33.2	46.9	30.2	15.9	53.5	32.4	23.8	50.4	35.1	18.7
User DelAdj:	1.00	1.00	1.00	1.00	1.00	1.00	1.00	1.00	1.00	1.00	1.00	1.00
AdjDel/Veh:	55.3	33.2	33.2	46.9	30.2	15.9	53.5	32.4	23.8	50.4	35.1	18.7
LOS by Move:	E	C	C	D	C	B	D	C	C	D	D	B
HCM2k95thQ:	3	13	13	5	23	10	10	16	4	6	20	4

Note: Queue reported is the number of cars per lane.

BART Phase II Extension Project

Level Of Service Computation Report
2000 HCM Operations (Future Volume Alternative)
AM - 2035 Project Conditions

Intersection #1205: SCOTT/EL CAMINO REAL

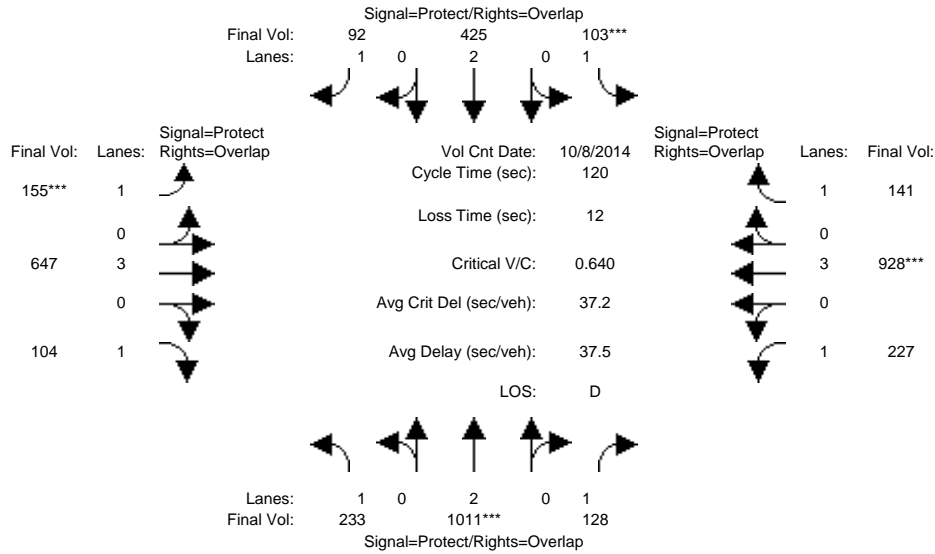

Approach:	North Bound			South Bound			East Bound			West Bound		
	L	T	R	L	T	R	L	T	R	L	T	R
Min. Green:	7	10	10	7	10	10	7	10	10	7	10	10
Y+R:	4.0	4.0	4.0	4.0	4.0	4.0	4.0	4.0	4.0	4.0	4.0	4.0
Volume Module: >> Count Date: 8 Oct 2014 <<												
Base Vol:	233	1011	128	103	425	92	155	647	104	227	928	141
Growth Adj:	1.00	1.00	1.00	1.00	1.00	1.00	1.00	1.00	1.00	1.00	1.00	1.00
Initial Bse:	233	1011	128	103	425	92	155	647	104	227	928	141
Added Vol:	0	0	0	0	0	0	0	0	0	0	0	0
PasserByVol:	0	0	0	0	0	0	0	0	0	0	0	0
Initial Fut:	233	1011	128	103	425	92	155	647	104	227	928	141
User Adj:	1.00	1.00	1.00	1.00	1.00	1.00	1.00	1.00	1.00	1.00	1.00	1.00
PHF Adj:	1.00	1.00	1.00	1.00	1.00	1.00	1.00	1.00	1.00	1.00	1.00	1.00
PHF Volume:	233	1011	128	103	425	92	155	647	104	227	928	141
Reduct Vol:	0	0	0	0	0	0	0	0	0	0	0	0
Reduced Vol:	233	1011	128	103	425	92	155	647	104	227	928	141
PCE Adj:	1.00	1.00	1.00	1.00	1.00	1.00	1.00	1.00	1.00	1.00	1.00	1.00
MLF Adj:	1.00	1.00	1.00	1.00	1.00	1.00	1.00	1.00	1.00	1.00	1.00	1.00
Final Volume:	233	1011	128	103	425	92	155	647	104	227	928	141
Saturation Flow Module:												
Sat/Lane:	1900	1900	1900	1900	1900	1900	1900	1900	1900	1900	1900	1900
Adjustment:	0.92	1.00	0.92	0.92	1.00	0.92	0.92	1.00	0.92	0.92	1.00	0.92
Lanes:	1.00	2.00	1.00	1.00	2.00	1.00	1.00	3.00	1.00	1.00	3.00	1.00
Final Sat.:	1750	3800	1750	1750	3800	1750	1750	5700	1750	1750	5700	1750
Capacity Analysis Module:												
Vol/Sat:	0.13	0.27	0.07	0.06	0.11	0.05	0.09	0.11	0.06	0.13	0.16	0.08
Crit Moves:	****			****			****			****		
Green Time:	33.1	49.9	75.0	11.0	27.8	44.4	16.6	22.0	55.1	25.1	30.5	41.5
Volume/Cap:	0.48	0.64	0.12	0.64	0.48	0.14	0.64	0.62	0.13	0.62	0.64	0.23
Delay/Veh:	37.1	28.8	9.2	61.0	40.3	25.2	54.6	46.3	18.7	46.3	40.8	28.1
User DelAdj:	1.00	1.00	1.00	1.00	1.00	1.00	1.00	1.00	1.00	1.00	1.00	1.00
AdjDel/Veh:	37.1	28.8	9.2	61.0	40.3	25.2	54.6	46.3	18.7	46.3	40.8	28.1
LOS by Move:	D	C	A	E	D	C	D	D	B	D	D	C
HCM2k95thQ:	14	26	4	8	13	5	11	14	5	15	19	8

Note: Queue reported is the number of cars per lane.

BART Phase II Extension Project

Level Of Service Computation Report
2000 HCM Operations (Future Volume Alternative)
PM - 2035 Project Conditions

Intersection #1205: SCOTT/EL CAMINO REAL

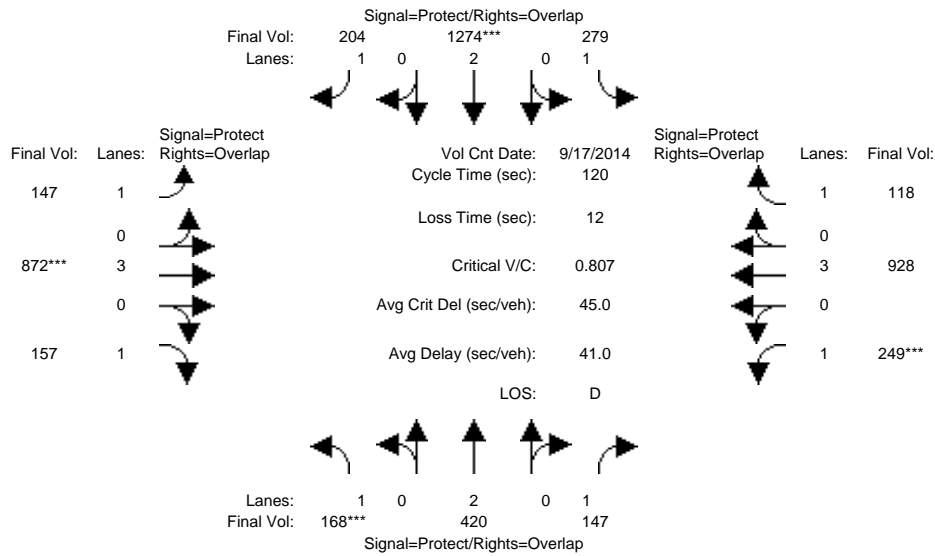

Approach:	North Bound			South Bound			East Bound			West Bound		
	L	T	R	L	T	R	L	T	R	L	T	R
Min. Green:	7	10	10	7	10	10	7	10	10	7	10	10
Y+R:	4.0	4.0	4.0	4.0	4.0	4.0	4.0	4.0	4.0	4.0	4.0	4.0

Volume Module:	>>	Count	Date:	17 Sep 2014	<<							
Base Vol:	168	420	147	279	1274	204	147	872	157	249	928	118
Growth Adj:	1.00	1.00	1.00	1.00	1.00	1.00	1.00	1.00	1.00	1.00	1.00	1.00
Initial Bse:	168	420	147	279	1274	204	147	872	157	249	928	118
Added Vol:	0	0	0	0	0	0	0	0	0	0	0	0
PasserByVol:	0	0	0	0	0	0	0	0	0	0	0	0
Initial Fut:	168	420	147	279	1274	204	147	872	157	249	928	118
User Adj:	1.00	1.00	1.00	1.00	1.00	1.00	1.00	1.00	1.00	1.00	1.00	1.00
PHF Adj:	1.00	1.00	1.00	1.00	1.00	1.00	1.00	1.00	1.00	1.00	1.00	1.00
PHF Volume:	168	420	147	279	1274	204	147	872	157	249	928	118
Reduct Vol:	0	0	0	0	0	0	0	0	0	0	0	0
Reduced Vol:	168	420	147	279	1274	204	147	872	157	249	928	118
PCE Adj:	1.00	1.00	1.00	1.00	1.00	1.00	1.00	1.00	1.00	1.00	1.00	1.00
MLF Adj:	1.00	1.00	1.00	1.00	1.00	1.00	1.00	1.00	1.00	1.00	1.00	1.00
FinalVolume:	168	420	147	279	1274	204	147	872	157	249	928	118

Saturation Flow Module:												
Sat/Lane:	1900	1900	1900	1900	1900	1900	1900	1900	1900	1900	1900	1900
Adjustment:	0.92	1.00	0.92	0.92	1.00	0.92	0.92	1.00	0.92	0.92	1.00	0.92
Lanes:	1.00	2.00	1.00	1.00	2.00	1.00	1.00	3.00	1.00	1.00	3.00	1.00
Final Sat.:	1750	3800	1750	1750	3800	1750	1750	5700	1750	1750	5700	1750

Capacity Analysis Module:												
Vol/Sat:	0.10	0.11	0.08	0.16	0.34	0.12	0.08	0.15	0.09	0.14	0.16	0.07
Crit Moves:	****				****			****			****	
Green Time:	14.3	26.2	47.4	37.9	49.8	64.8	14.9	22.7	37.0	21.2	29.0	66.8
Volume/Cap:	0.81	0.51	0.21	0.51	0.81	0.22	0.67	0.81	0.29	0.81	0.67	0.12
Delay/Veh:	71.8	41.7	24.1	34.2	34.0	14.5	58.3	51.1	31.8	62.0	42.6	12.7
User DelAdj:	1.00	1.00	1.00	1.00	1.00	1.00	1.00	1.00	1.00	1.00	1.00	1.00
AdjDel/Veh:	71.8	41.7	24.1	34.2	34.0	14.5	58.3	51.1	31.8	62.0	42.6	12.7
LOS by Move:	E	D	C	C	C	B	E	D	C	E	D	B
HCM2k95thQ:	13	13	7	16	36	8	11	20	9	19	19	4

Note: Queue reported is the number of cars per lane.

BART Phase II Extension Project

Level Of Service Computation Report
2000 HCM Operations (Future Volume Alternative)
AM - 2035 Project Conditions

Intersection #1213: THE ALAMEDA/EL CAMINO REAL

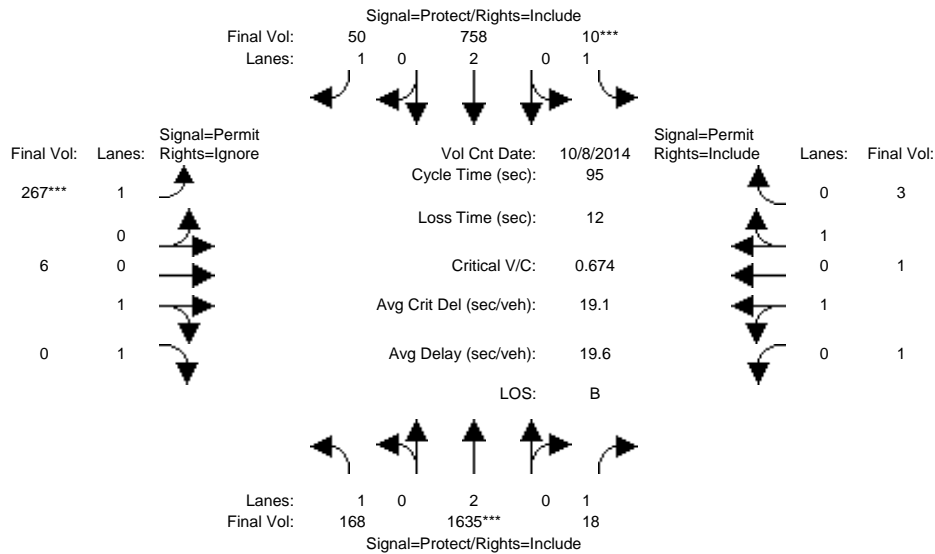

Approach:	North Bound			South Bound			East Bound			West Bound		
	L	T	R	L	T	R	L	T	R	L	T	R
Min. Green:	7	10	10	7	10	10	7	10	10	7	10	10
Y+R:	4.0	4.0	4.0	4.0	4.0	4.0	4.0	4.0	4.0	4.0	4.0	4.0

Volume Module:	>>	Count	Date:	8 Oct 2014	<<							
Base Vol:	168	1635	18	10	758	50	267	6	225	1	1	3
Growth Adj:	1.00	1.00	1.00	1.00	1.00	1.00	1.00	1.00	1.00	1.00	1.00	1.00
Initial Bse:	168	1635	18	10	758	50	267	6	225	1	1	3
Added Vol:	0	0	0	0	0	0	0	0	0	0	0	0
PasserByVol:	0	0	0	0	0	0	0	0	0	0	0	0
Initial Fut:	168	1635	18	10	758	50	267	6	225	1	1	3
User Adj:	1.00	1.00	1.00	1.00	1.00	1.00	1.00	1.00	0.00	1.00	1.00	1.00
PHF Adj:	1.00	1.00	1.00	1.00	1.00	1.00	1.00	1.00	0.00	1.00	1.00	1.00
PHF Volume:	168	1635	18	10	758	50	267	6	0	1	1	3
Reduct Vol:	0	0	0	0	0	0	0	0	0	0	0	0
Reduced Vol:	168	1635	18	10	758	50	267	6	0	1	1	3
PCE Adj:	1.00	1.00	1.00	1.00	1.00	1.00	1.00	1.00	0.00	1.00	1.00	1.00
MLF Adj:	1.00	1.00	1.00	1.00	1.00	1.00	1.00	1.00	0.00	1.00	1.00	1.00
FinalVolume:	168	1635	18	10	758	50	267	6	0	1	1	3

Saturation Flow Module:	North Bound			South Bound			East Bound			West Bound		
Sat/Lane:	1900	1900	1900	1900	1900	1900	1900	1900	1900	1900	1900	1900
Adjustment:	0.92	1.00	0.92	0.92	1.00	0.92	0.92	0.95	0.92	0.95	0.95	0.95
Lanes:	1.00	2.00	1.00	1.00	2.00	1.00	1.00	1.00	1.00	0.50	0.50	1.00
Final Sat.:	1750	3800	1750	1750	3800	1750	1750	1800	1750	900	900	1800

Capacity Analysis Module:	North Bound			South Bound			East Bound			West Bound		
Vol/Sat:	0.10	0.43	0.01	0.01	0.20	0.03	0.15	0.00	0.00	0.00	0.00	0.00
Crit Moves:	****			****			****					
Green Time:	20.5	56.1	56.1	7.0	42.6	42.6	19.9	19.9	0.0	19.9	19.9	19.9
Volume/Cap:	0.44	0.73	0.02	0.08	0.44	0.06	0.73	0.02	0.00	0.01	0.01	0.01
Delay/Veh:	33.1	15.2	8.1	41.3	18.2	14.9	42.3	29.8	0.0	29.7	29.7	29.7
User DelAdj:	1.00	1.00	1.00	1.00	1.00	1.00	1.00	1.00	1.00	1.00	1.00	1.00
AdjDel/Veh:	33.1	15.2	8.1	41.3	18.2	14.9	42.3	29.8	0.0	29.7	29.7	29.7
LOS by Move:	C	B	A	D	B	B	D	C	A	C	C	C
HCM2k95thQ:	9	29	0	1	15	2	17	0	0	0	0	0

Note: Queue reported is the number of cars per lane.

BART Phase II Extension Project

Level Of Service Computation Report
 2000 HCM Operations (Future Volume Alternative)
 PM - 2035 Project Conditions

Intersection #1213: THE ALAMEDA/EL CAMINO REAL

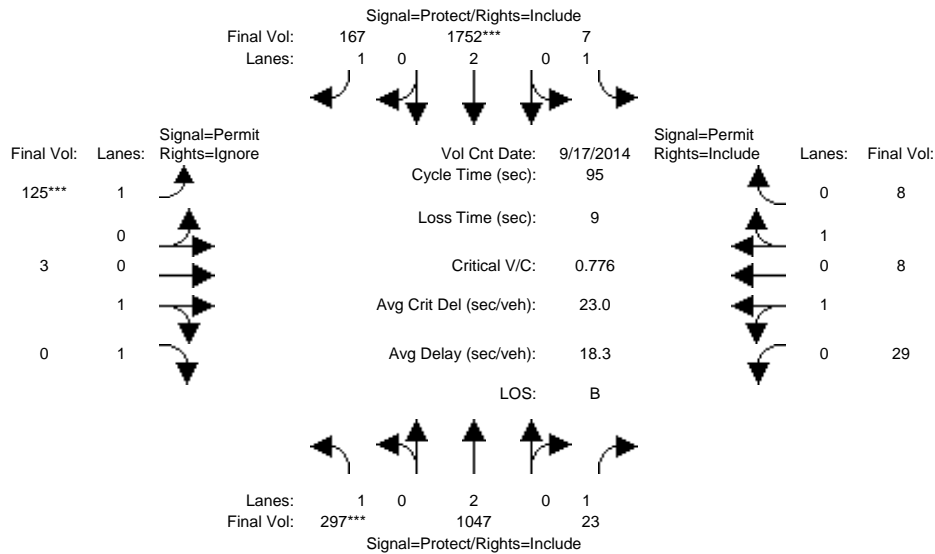

Approach:	North Bound			South Bound			East Bound			West Bound		
	L	T	R	L	T	R	L	T	R	L	T	R
Min. Green:	7	10	10	7	10	10	10	10	10	10	10	10
Y+R:	4.0	4.0	4.0	4.0	4.0	4.0	4.0	4.0	4.0	4.0	4.0	4.0

Volume Module:	>> Count Date: 17 Sep 2014 <<											
Base Vol:	297	1047	23	7	1752	167	125	3	272	29	8	8
Growth Adj:	1.00	1.00	1.00	1.00	1.00	1.00	1.00	1.00	1.00	1.00	1.00	1.00
Initial Bse:	297	1047	23	7	1752	167	125	3	272	29	8	8
Added Vol:	0	0	0	0	0	0	0	0	0	0	0	0
PasserByVol:	0	0	0	0	0	0	0	0	0	0	0	0
Initial Fut:	297	1047	23	7	1752	167	125	3	272	29	8	8
User Adj:	1.00	1.00	1.00	1.00	1.00	1.00	1.00	1.00	0.00	1.00	1.00	1.00
PHF Adj:	1.00	1.00	1.00	1.00	1.00	1.00	1.00	1.00	0.00	1.00	1.00	1.00
PHF Volume:	297	1047	23	7	1752	167	125	3	0	29	8	8
Reduct Vol:	0	0	0	0	0	0	0	0	0	0	0	0
Reduced Vol:	297	1047	23	7	1752	167	125	3	0	29	8	8
PCE Adj:	1.00	1.00	1.00	1.00	1.00	1.00	1.00	1.00	0.00	1.00	1.00	1.00
MLF Adj:	1.00	1.00	1.00	1.00	1.00	1.00	1.00	1.00	0.00	1.00	1.00	1.00
FinalVolume:	297	1047	23	7	1752	167	125	3	0	29	8	8

Saturation Flow Module:												
Sat/Lane:	1900	1900	1900	1900	1900	1900	1900	1900	1900	1900	1900	1900
Adjustment:	0.92	1.00	0.92	0.92	1.00	0.92	0.92	0.95	0.92	0.95	0.95	0.95
Lanes:	1.00	2.00	1.00	1.00	2.00	1.00	1.00	1.00	1.00	1.00	0.50	0.50
Final Sat.:	1750	3800	1750	1750	3800	1750	1750	1800	1750	1800	900	900

Capacity Analysis Module:												
Vol/Sat:	0.17	0.28	0.01	0.00	0.46	0.10	0.07	0.00	0.00	0.02	0.01	0.01
Crit Moves:	****				****		****					
Green Time:	20.4	60.0	60.0	16.0	55.6	55.6	10.0	10.0	0.0	10.0	10.0	10.0
Volume/Cap:	0.79	0.44	0.02	0.02	0.79	0.16	0.68	0.02	0.00	0.15	0.08	0.08
Delay/Veh:	45.9	9.0	6.6	33.0	17.2	9.1	50.7	38.1	0.0	38.9	38.4	38.4
User DelAdj:	1.00	1.00	1.00	1.00	1.00	1.00	1.00	1.00	1.00	1.00	1.00	1.00
AdjDel/Veh:	45.9	9.0	6.6	33.0	17.2	9.1	50.7	38.1	0.0	38.9	38.4	38.4
LOS by Move:	D	A	A	C	B	A	D	D	A	D	D	D
HCM2k95thQ:	16	14	1	0	36	5	10	0	0	2	1	1

Note: Queue reported is the number of cars per lane.

BART Phase II Extension Project

Level Of Service Computation Report
2000 HCM Operations (Future Volume Alternative)
AM - 2035 Project Conditions

Intersection #3411: AVIATION/COLEMAN

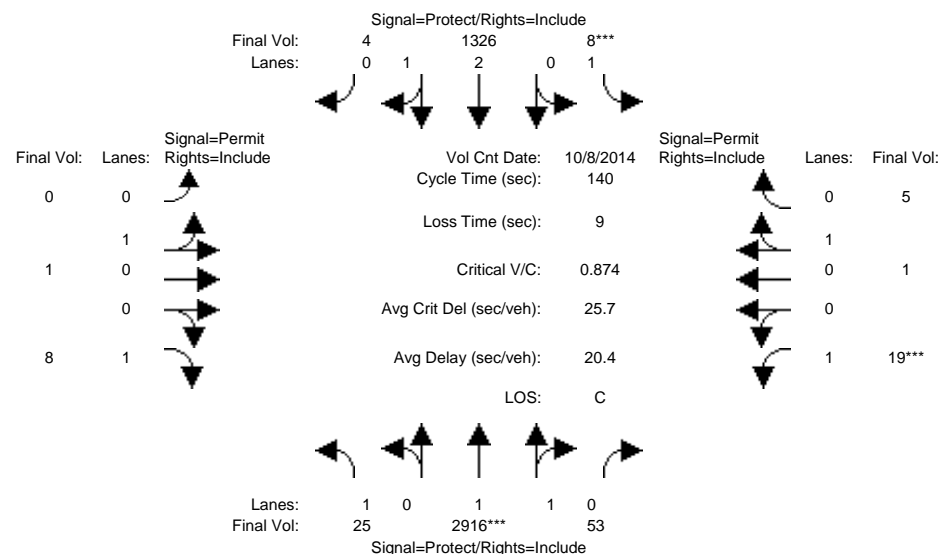

Approach:	North Bound			South Bound			East Bound			West Bound		
Movement:	L	T	R	L	T	R	L	T	R	L	T	R
Min. Green:	7	10	10	7	10	10	10	10	10	10	10	10
Y+R:	4.0	4.0	4.0	4.0	4.0	4.0	4.0	4.0	4.0	4.0	4.0	4.0
Volume Module: >> Count Date: 8 Oct 2014 <<												
Base Vol:	25	2916	53	8	1326	4	0	1	8	19	1	5
Growth Adj:	1.00	1.00	1.00	1.00	1.00	1.00	1.00	1.00	1.00	1.00	1.00	1.00
Initial Bse:	25	2916	53	8	1326	4	0	1	8	19	1	5
Added Vol:	0	0	0	0	0	0	0	0	0	0	0	0
PasserByVol:	0	0	0	0	0	0	0	0	0	0	0	0
Initial Fut:	25	2916	53	8	1326	4	0	1	8	19	1	5
User Adj:	1.00	1.00	1.00	1.00	1.00	1.00	1.00	1.00	1.00	1.00	1.00	1.00
PHF Adj:	1.00	1.00	1.00	1.00	1.00	1.00	1.00	1.00	1.00	1.00	1.00	1.00
PHF Volume:	25	2916	53	8	1326	4	0	1	8	19	1	5
Reduct Vol:	0	0	0	0	0	0	0	0	0	0	0	0
Reduced Vol:	25	2916	53	8	1326	4	0	1	8	19	1	5
PCE Adj:	1.00	1.00	1.00	1.00	1.00	1.00	1.00	1.00	1.00	1.00	1.00	1.00
MLF Adj:	1.00	1.00	1.00	1.00	1.00	1.00	1.00	1.00	1.00	1.00	1.00	1.00
FinalVolume:	25	2916	53	8	1326	4	0	1	8	19	1	5
Saturation Flow Module:												
Sat/Lane:	1900	1900	1900	1900	1900	1900	1900	1900	1900	1900	1900	1900
Adjustment:	0.92	0.97	0.95	0.92	0.98	0.95	0.95	0.95	0.92	0.92	0.95	0.95
Lanes:	1.00	1.96	0.04	1.00	2.99	0.01	0.00	1.00	1.00	1.00	0.17	0.83
Final Sat.:	1750	3634	66	1750	5583	17	0	1800	1750	1750	300	1500
Capacity Analysis Module:												
Vol/Sat:	0.01	0.80	0.80	0.00	0.24	0.24	0.00	0.00	0.00	0.01	0.00	0.00
Crit Moves:	****			****			****			****		
Green Time:	21.0	114	114.0	7.0	xxxx	100.0	0.0	10.0	10.0	10.0	10.0	10.0
Volume/Cap:	0.10	0.99	0.99	0.09	0.33	0.33	0.00	0.01	0.06	0.15	0.05	0.05
Delay/Veh:	51.4	25.4	25.4	63.9	7.6	7.6	0.0	60.4	60.9	61.6	60.7	60.7
User DelAdj:	1.00	1.00	1.00	1.00	1.00	1.00	1.00	1.00	1.00	1.00	1.00	1.00
AdjDel/Veh:	51.4	25.4	25.4	63.9	7.6	7.6	0.0	60.4	60.9	61.6	60.7	60.7
LOS by Move:	D	C	C	E	A	A	A	E	E	E	E	E
HCM2k95thQ:	2	101	101	1	13	13	0	0	1	2	1	1

Note: Queue reported is the number of cars per lane.

BART Phase II Extension Project

Level Of Service Computation Report
2000 HCM Operations (Future Volume Alternative)
PM - 2035 Project Conditions

Intersection #3411: AVIATION/COLEMAN

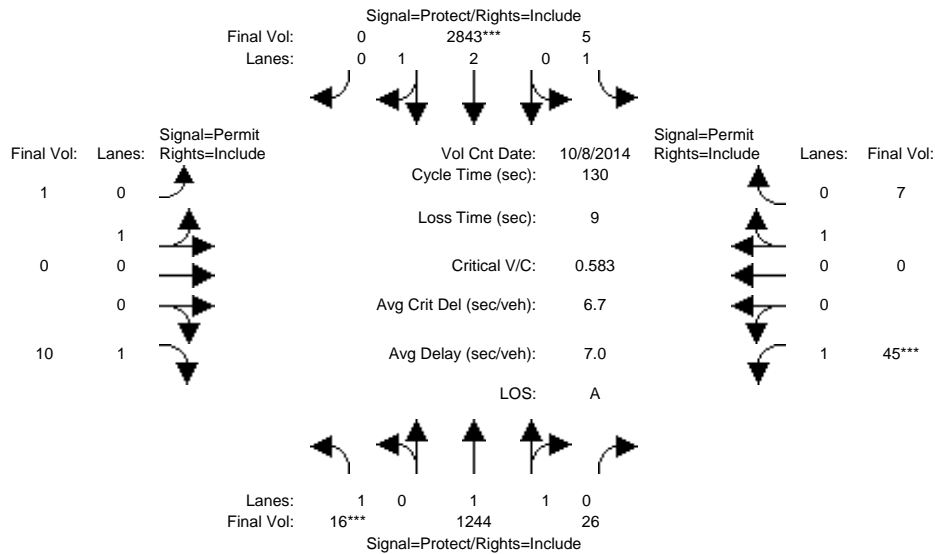

Approach:	North Bound			South Bound			East Bound			West Bound		
	L	T	R	L	T	R	L	T	R	L	T	R
Min. Green:	7	10	10	7	10	10	10	10	10	10	10	10
Y+R:	4.0	4.0	4.0	4.0	4.0	4.0	4.0	4.0	4.0	4.0	4.0	4.0

Volume Module:	>>	Count	Date:	8 Oct 2014	<<							
Base Vol:	16	1244	26	5	2843	0	1	0	10	45	0	7
Growth Adj:	1.00	1.00	1.00	1.00	1.00	1.00	1.00	1.00	1.00	1.00	1.00	1.00
Initial Bse:	16	1244	26	5	2843	0	1	0	10	45	0	7
Added Vol:	0	0	0	0	0	0	0	0	0	0	0	0
PasserByVol:	0	0	0	0	0	0	0	0	0	0	0	0
Initial Fut:	16	1244	26	5	2843	0	1	0	10	45	0	7
User Adj:	1.00	1.00	1.00	1.00	1.00	1.00	1.00	1.00	1.00	1.00	1.00	1.00
PHF Adj:	1.00	1.00	1.00	1.00	1.00	1.00	1.00	1.00	1.00	1.00	1.00	1.00
PHF Volume:	16	1244	26	5	2843	0	1	0	10	45	0	7
Reduct Vol:	0	0	0	0	0	0	0	0	0	0	0	0
Reduced Vol:	16	1244	26	5	2843	0	1	0	10	45	0	7
PCE Adj:	1.00	1.00	1.00	1.00	1.00	1.00	1.00	1.00	1.00	1.00	1.00	1.00
MLF Adj:	1.00	1.00	1.00	1.00	1.00	1.00	1.00	1.00	1.00	1.00	1.00	1.00
FinalVolume:	16	1244	26	5	2843	0	1	0	10	45	0	7

Saturation Flow Module:												
Sat/Lane:	1900	1900	1900	1900	1900	1900	1900	1900	1900	1900	1900	1900
Adjustment:	0.92	0.97	0.95	0.92	0.98	0.92	0.95	0.95	0.92	0.92	1.00	0.95
Lanes:	1.00	1.96	0.04	1.00	3.00	0.00	1.00	0.00	1.00	1.00	0.00	1.00
Final Sat.:	1750	3624	76	1750	5600	0	1800	0	1750	1750	0	1800

Capacity Analysis Module:												
Vol/Sat:	0.01	0.34	0.34	0.00	0.51	0.00	0.00	0.00	0.01	0.03	0.00	0.00
Crit Moves:	****				****					****		
Green Time:	7.0	95.9	95.9	15.1	104	0.0	10.0	0.0	10.0	10.0	0.0	10.0
Volume/Cap:	0.17	0.47	0.47	0.02	0.63	0.00	0.01	0.00	0.07	0.33	0.00	0.05
Delay/Veh:	59.6	6.9	6.9	51.0	5.6	0.0	55.4	0.0	55.9	58.3	0.0	55.8
User DelAdj:	1.00	1.00	1.00	1.00	1.00	1.00	1.00	1.00	1.00	1.00	1.00	1.00
AdjDel/Veh:	59.6	6.9	6.9	51.0	5.6	0.0	55.4	0.0	55.9	58.3	0.0	55.8
LOS by Move:	E	A	A	D	A	A	E	A	E	E	A	E
HCM2k95thQ:	1	19	19	0	25	0	0	0	1	4	0	1

Note: Queue reported is the number of cars per lane.

BART Phase II Extension Project

Level Of Service Computation Report
2000 HCM Operations (Future Volume Alternative)
AM - 2035 Project Conditions

Intersection #4047: COLEMAN/NEWHALL

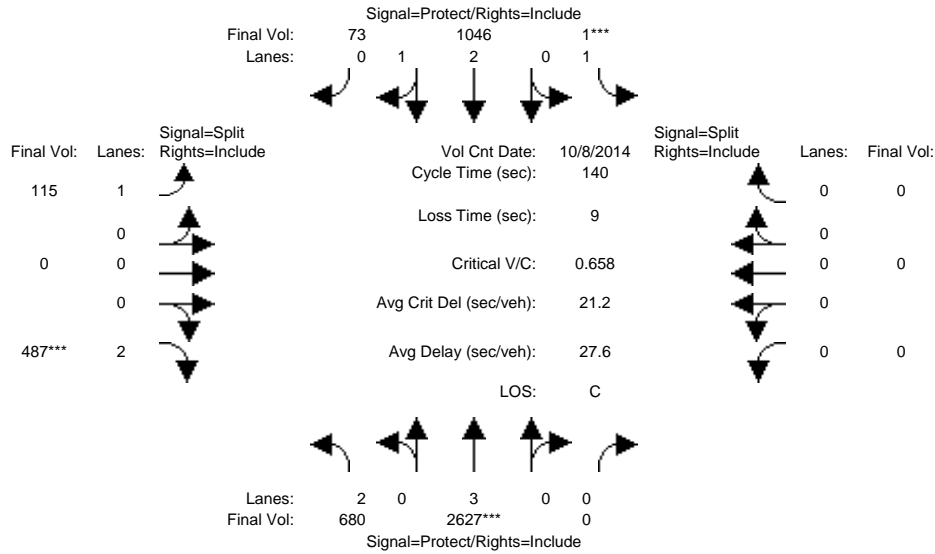

Approach:	North Bound			South Bound			East Bound			West Bound		
	L	T	R	L	T	R	L	T	R	L	T	R
Min. Green:	7	10	0	7	10	10	10	0	10	0	0	0
Y+R:	4.0	4.0	4.0	4.0	4.0	4.0	4.0	4.0	4.0	4.0	4.0	4.0
Volume Module: >> Count Date: 8 Oct 2014 <<												
Base Vol:	680	2627	0	1	1046	73	115	0	487	0	0	0
Growth Adj:	1.00	1.00	1.00	1.00	1.00	1.00	1.00	1.00	1.00	1.00	1.00	1.00
Initial Bse:	680	2627	0	1	1046	73	115	0	487	0	0	0
Added Vol:	0	0	0	0	0	0	0	0	0	0	0	0
PasserByVol:	0	0	0	0	0	0	0	0	0	0	0	0
Initial Fut:	680	2627	0	1	1046	73	115	0	487	0	0	0
User Adj:	1.00	1.00	1.00	1.00	1.00	1.00	1.00	1.00	1.00	1.00	1.00	1.00
PHF Adj:	1.00	1.00	1.00	1.00	1.00	1.00	1.00	1.00	1.00	1.00	1.00	1.00
PHF Volume:	680	2627	0	1	1046	73	115	0	487	0	0	0
Reduct Vol:	0	0	0	0	0	0	0	0	0	0	0	0
Reduced Vol:	680	2627	0	1	1046	73	115	0	487	0	0	0
PCE Adj:	1.00	1.00	1.00	1.00	1.00	1.00	1.00	1.00	1.00	1.00	1.00	1.00
MLF Adj:	1.00	1.00	1.00	1.00	1.00	1.00	1.00	1.00	1.00	1.00	1.00	1.00
Final Volume:	680	2627	0	1	1046	73	115	0	487	0	0	0
Saturation Flow Module:												
Sat/Lane:	1900	1900	1900	1900	1900	1900	1900	1900	1900	1900	1900	1900
Adjustment:	0.83	1.00	0.92	0.92	0.98	0.95	0.92	1.00	0.83	0.92	1.00	0.92
Lanes:	2.00	3.00	0.00	1.00	2.80	0.20	1.00	0.00	2.00	0.00	0.00	0.00
Final Sat.:	3150	5700	0	1750	5234	365	1750	0	3150	0	0	0
Capacity Analysis Module:												
Vol/Sat:	0.22	0.46	0.00	0.00	0.20	0.20	0.07	0.00	0.15	0.00	0.00	0.00
Crit Moves:	****			****			****			****		
Green Time:	51.9	92.9	0.0	7.0	48.0	48.0	31.1	0.0	31.1	0.0	0.0	0.0
Volume/Cap:	0.58	0.69	0.00	0.01	0.58	0.58	0.30	0.00	0.69	0.00	0.00	0.00
Delay/Veh:	36.1	15.3	0.0	63.3	38.2	38.2	45.7	0.0	53.1	0.0	0.0	0.0
User DelAdj:	1.00	1.00	1.00	1.00	1.00	1.00	1.00	1.00	1.00	1.00	1.00	1.00
AdjDel/Veh:	36.1	15.3	0.0	63.3	38.2	38.2	45.7	0.0	53.1	0.0	0.0	0.0
LOS by Move:	D	B	A	E	D	D	D	A	D	A	A	A
HCM2k95thQ:	25	39	0	0	23	23	9	0	23	0	0	0

Note: Queue reported is the number of cars per lane.

BART Phase II Extension Project

Level Of Service Computation Report
2000 HCM Operations (Future Volume Alternative)
PM - 2035 Project Conditions

Intersection #4047: COLEMAN/NEWHALL

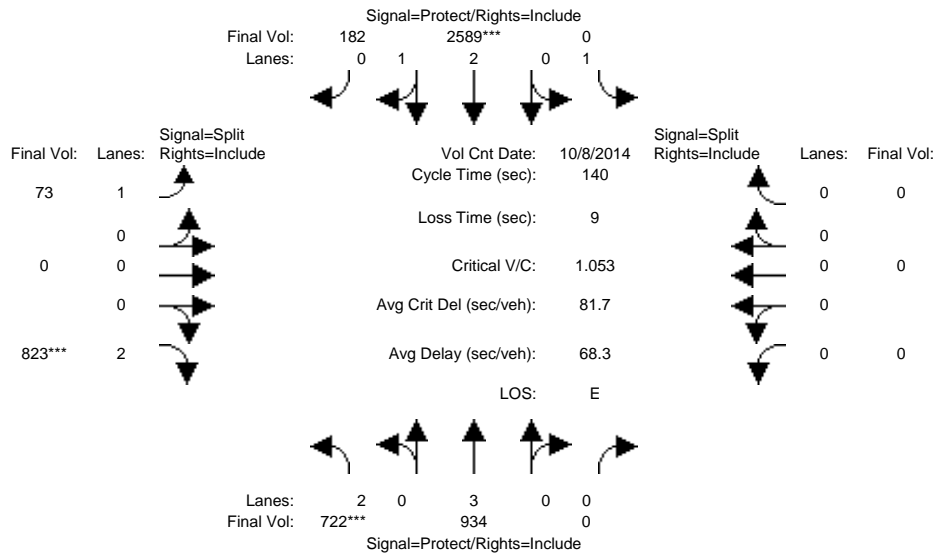

Approach:	North Bound			South Bound			East Bound			West Bound		
	L	T	R	L	T	R	L	T	R	L	T	R
Min. Green:	7	10	0	7	10	10	10	0	10	0	0	0
Y+R:	4.0	4.0	4.0	4.0	4.0	4.0	4.0	4.0	4.0	4.0	4.0	4.0
Volume Module: >> Count Date: 8 Oct 2014 <<												
Base Vol:	722	934	0	0	2589	182	73	0	823	0	0	0
Growth Adj:	1.00	1.00	1.00	1.00	1.00	1.00	1.00	1.00	1.00	1.00	1.00	1.00
Initial Bse:	722	934	0	0	2589	182	73	0	823	0	0	0
Added Vol:	0	0	0	0	0	0	0	0	0	0	0	0
PasserByVol:	0	0	0	0	0	0	0	0	0	0	0	0
Initial Fut:	722	934	0	0	2589	182	73	0	823	0	0	0
User Adj:	1.00	1.00	1.00	1.00	1.00	1.00	1.00	1.00	1.00	1.00	1.00	1.00
PHF Adj:	1.00	1.00	1.00	1.00	1.00	1.00	1.00	1.00	1.00	1.00	1.00	1.00
PHF Volume:	722	934	0	0	2589	182	73	0	823	0	0	0
Reduct Vol:	0	0	0	0	0	0	0	0	0	0	0	0
Reduced Vol:	722	934	0	0	2589	182	73	0	823	0	0	0
PCE Adj:	1.00	1.00	1.00	1.00	1.00	1.00	1.00	1.00	1.00	1.00	1.00	1.00
MLF Adj:	1.00	1.00	1.00	1.00	1.00	1.00	1.00	1.00	1.00	1.00	1.00	1.00
FinalVolume:	722	934	0	0	2589	182	73	0	823	0	0	0
Saturation Flow Module:												
Sat/Lane:	1900	1900	1900	1900	1900	1900	1900	1900	1900	1900	1900	1900
Adjustment:	0.83	1.00	0.92	0.92	0.98	0.95	0.92	1.00	0.83	0.92	1.00	0.92
Lanes:	2.00	3.00	0.00	1.00	2.80	0.20	1.00	0.00	2.00	0.00	0.00	0.00
Final Sat.:	3150	5700	0	1750	5232	368	1750	0	3150	0	0	0
Capacity Analysis Module:												
Vol/Sat:	0.23	0.16	0.00	0.00	0.49	0.49	0.04	0.00	0.26	0.00	0.00	0.00
Crit Moves:	****				****				****			
Green Time:	30.5	96.3	0.0	0.0	65.8	65.8	34.7	0.0	34.7	0.0	0.0	0.0
Volume/Cap:	1.05	0.24	0.00	0.00	1.05	1.05	0.17	0.00	1.05	0.00	0.00	0.00
Delay/Veh:	103.9	8.2	0.0	0.0	70.6	70.6	41.5	0.0	99.7	0.0	0.0	0.0
User DelAdj:	1.00	1.00	1.00	1.00	1.00	1.00	1.00	1.00	1.00	1.00	1.00	1.00
AdjDel/Veh:	103.9	8.2	0.0	0.0	70.6	70.6	41.5	0.0	99.7	0.0	0.0	0.0
LOS by Move:	F	A	A	A	E	E	D	A	F	A	A	A
HCM2k95thQ:	42	9	0	0	75	75	5	0	47	0	0	0

Note: Queue reported is the number of cars per lane.

BART Phase II Extension Project

Level Of Service Computation Report
 2000 HCM Operations (Future Volume Alternative)
 AM - 2035 Project Conditions

Intersection #5335: CENTRAL EXPWY/DE LA CRUZ BLVD

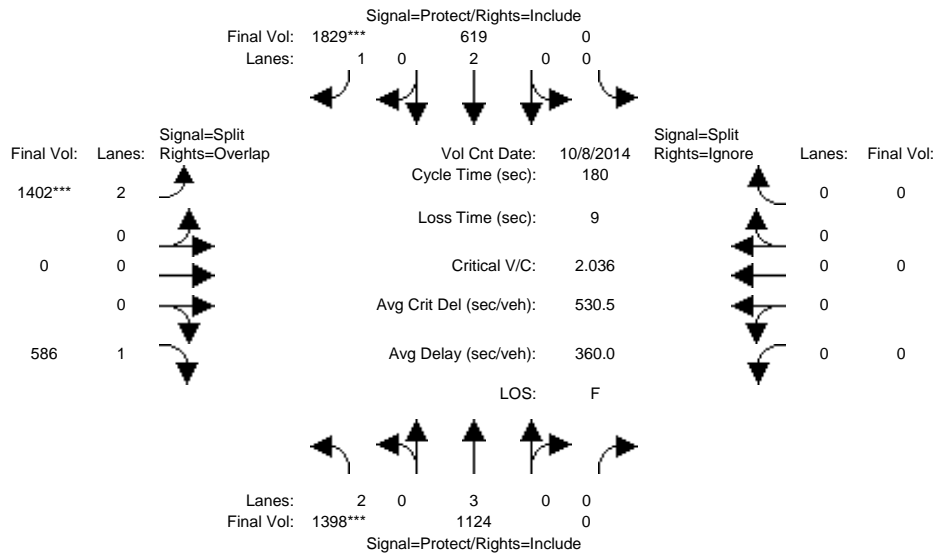

Approach:	North Bound			South Bound			East Bound			West Bound		
	L	T	R	L	T	R	L	T	R	L	T	R
Min. Green:	7	10	0	0	10	10	10	0	10	0	0	0
Y+R:	4.0	4.0	4.0	4.0	4.0	4.0	4.0	4.0	4.0	4.0	4.0	4.0

Volume Module: >> Count Date: 8 Oct 2014 <<

Base Vol:	1398	1124	0	0	619	1829	1611	0	586	0	0	0
Growth Adj:	1.00	1.00	1.00	1.00	1.00	1.00	1.00	1.00	1.00	1.00	1.00	1.00
Initial Bse:	1398	1124	0	0	619	1829	1611	0	586	0	0	0
Added Vol:	0	0	0	0	0	0	0	0	0	0	0	0
PasserByVol:	0	0	0	0	0	0	0	0	0	0	0	0
Initial Fut:	1398	1124	0	0	619	1829	1611	0	586	0	0	0
User Adj:	1.00	1.00	1.00	1.00	1.00	1.00	0.87	1.00	1.00	1.00	1.00	0.00
PHF Adj:	1.00	1.00	1.00	1.00	1.00	1.00	1.00	1.00	1.00	1.00	1.00	0.00
PHF Volume:	1398	1124	0	0	619	1829	1402	0	586	0	0	0
Reduct Vol:	0	0	0	0	0	0	0	0	0	0	0	0
Reduced Vol:	1398	1124	0	0	619	1829	1402	0	586	0	0	0
PCE Adj:	1.00	1.00	1.00	1.00	1.00	1.00	1.00	1.00	1.00	1.00	1.00	0.00
MLF Adj:	1.00	1.00	1.00	1.00	1.00	1.00	1.00	1.00	1.00	1.00	1.00	0.00
FinalVolume:	1398	1124	0	0	619	1829	1402	0	586	0	0	0

Saturation Flow Module:

Sat/Lane:	1900	1900	1900	1900	1900	1900	1900	1900	1900	1900	1900	1900
Adjustment:	0.83	1.00	0.92	0.92	1.00	0.92	0.83	1.00	0.92	0.92	1.00	0.92
Lanes:	2.00	3.00	0.00	0.00	2.00	1.00	2.00	0.00	1.00	0.00	0.00	0.00
Final Sat.:	3150	5700	0	0	3800	1750	3150	0	1750	0	0	0

Capacity Analysis Module:

Vol/Sat:	0.44	0.20	0.00	0.00	0.16	1.05	0.44	0.00	0.33	0.00	0.00	0.00
Crit Moves:	****					****	****					
Green Time:	39.2	132	0.0	0.0	92.4	92.4	39.3	0.0	78.6	0.0	0.0	0.0
Volume/Cap:	2.04	0.27	0.00	0.00	0.32	2.04	2.04	0.00	0.77	0.00	0.00	0.00
Delay/Veh:	541.5	8.1	0.0	0.0	25.5	513.8	541.5	0.0	41.3	0.0	0.0	0.0
User DelAdj:	1.00	1.00	1.00	1.00	1.00	1.00	1.00	1.00	1.00	1.00	1.00	1.00
AdjDel/Veh:	541.5	8.1	0.0	0.0	25.5	513.8	541.5	0.0	41.3	0.0	0.0	0.0
LOS by Move:	F	A	A	A	C	F	F	A	D	A	A	A
HCM2k95thQ:	146	13	0	0	18	341	146	0	44	0	0	0

Note: Queue reported is the number of cars per lane.

BART Phase II Extension Project

Level Of Service Computation Report
 2000 HCM Operations (Future Volume Alternative)
 PM - 2035 Project Conditions

Intersection #5335: CENTRAL EXPWY/DE LA CRUZ BLVD

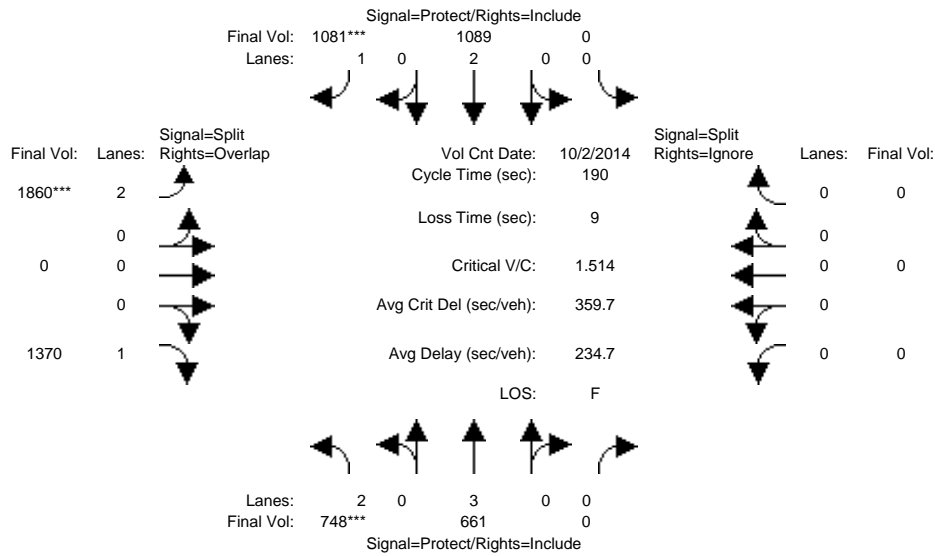

Approach:	North Bound			South Bound			East Bound			West Bound		
	L	T	R	L	T	R	L	T	R	L	T	R
Min. Green:	19	76	0	0	57	57	114	0	114	0	0	0
Y+R:	4.0	4.0	4.0	4.0	4.0	4.0	4.0	4.0	4.0	4.0	4.0	4.0

Volume Module:	>>	Count	Date:	2 Oct 2014	<<							
Base Vol:	748	661	0	0	1089	1081	2513	0	1370	0	0	0
Growth Adj:	1.00	1.00	1.00	1.00	1.00	1.00	1.00	1.00	1.00	1.00	1.00	1.00
Initial Bse:	748	661	0	0	1089	1081	2513	0	1370	0	0	0
Added Vol:	0	0	0	0	0	0	0	0	0	0	0	0
PasserByVol:	0	0	0	0	0	0	0	0	0	0	0	0
Initial Fut:	748	661	0	0	1089	1081	2513	0	1370	0	0	0
User Adj:	1.00	1.00	1.00	1.00	1.00	1.00	0.74	1.00	1.00	1.00	1.00	0.00
PHF Adj:	1.00	1.00	1.00	1.00	1.00	1.00	1.00	1.00	1.00	1.00	1.00	0.00
PHF Volume:	748	661	0	0	1089	1081	1860	0	1370	0	0	0
Reduct Vol:	0	0	0	0	0	0	0	0	0	0	0	0
Reduced Vol:	748	661	0	0	1089	1081	1860	0	1370	0	0	0
PCE Adj:	1.00	1.00	1.00	1.00	1.00	1.00	1.00	1.00	1.00	1.00	1.00	0.00
MLF Adj:	1.00	1.00	1.00	1.00	1.00	1.00	1.00	1.00	1.00	1.00	1.00	0.00
Final Volume:	748	661	0	0	1089	1081	1860	0	1370	0	0	0

Saturation Flow Module:												
Sat/Lane:	1900	1900	1900	1900	1900	1900	1900	1900	1900	1900	1900	1900
Adjustment:	0.83	1.00	0.92	0.92	1.00	0.92	0.83	1.00	0.92	0.92	1.00	0.92
Lanes:	2.00	3.00	0.00	0.00	2.00	1.00	2.00	0.00	1.00	0.00	0.00	0.00
Final Sat.:	3150	5700	0	0	3800	1750	3150	0	1750	0	0	0

Capacity Analysis Module:												
Vol/Sat:	0.24	0.12	0.00	0.00	0.29	0.62	0.59	0.00	0.78	0.00	0.00	0.00
Crit Moves:	****				****	****	****					
Green Time:	18.1	72.6	0.0	0.0	54.4	54.4	108.8	0.0	127.0	0.0	0.0	0.0
Volume/Cap:	2.49	0.30	0.00	0.00	1.00	2.16	1.03	0.00	1.17	0.00	0.00	0.00
Delay/Veh:	769.1	43.1	0.0	0.0	98.4	598.1	56.5	0.0	98.9	0.0	0.0	0.0
User DelAdj:	1.00	1.00	1.00	1.00	1.00	1.00	1.00	1.00	1.00	1.00	1.00	1.00
AdjDel/Veh:	769.1	43.1	0.0	0.0	98.4	598.1	56.5	0.0	98.9	0.0	0.0	0.0
LOS by Move:	F	D	A	A	F	F	E	A	F	A	A	A
HCM2k95thQ:	90	17	0	0	59	217	115	0	174	0	0	0

Note: Queue reported is the number of cars per lane.

BART Phase II Extension Project

Level Of Service Computation Report
 2000 HCM Operations (Future Volume Alternative)
 AM - 2035 Project Conditions

Intersection #5416: SAN TOMAS EXPWY/EL CAMINO REAL

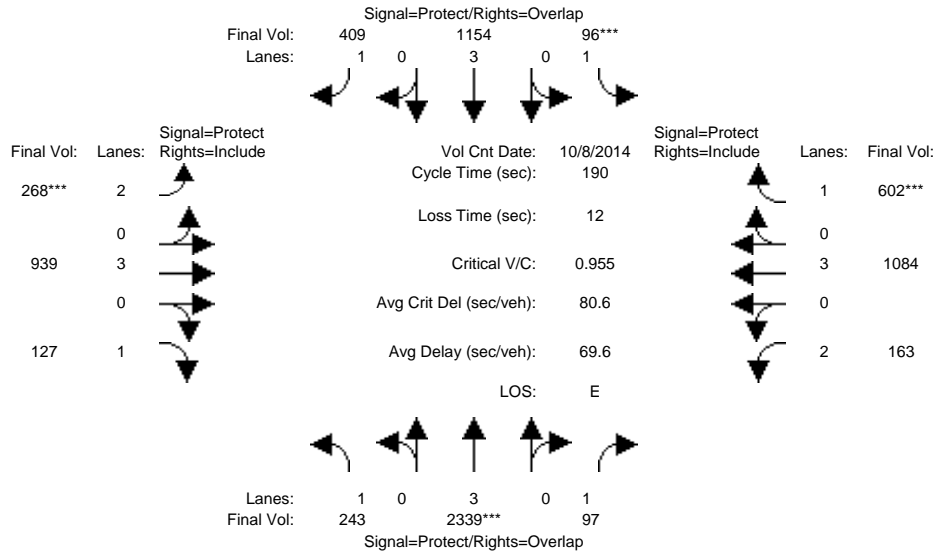

Approach:	North Bound			South Bound			East Bound			West Bound		
	L	T	R	L	T	R	L	T	R	L	T	R
Min. Green:	7	10	10	7	10	10	7	10	10	7	10	10
Y+R:	4.0	4.0	4.0	4.0	4.0	4.0	4.0	4.0	4.0	4.0	4.0	4.0
Volume Module: >> Count Date: 8 Oct 2014 <<												
Base Vol:	243	2785	97	96	1374	409	268	939	127	163	1084	602
Growth Adj:	1.00	1.00	1.00	1.00	1.00	1.00	1.00	1.00	1.00	1.00	1.00	1.00
Initial Bse:	243	2785	97	96	1374	409	268	939	127	163	1084	602
Added Vol:	0	0	0	0	0	0	0	0	0	0	0	0
PasserByVol:	0	0	0	0	0	0	0	0	0	0	0	0
Initial Fut:	243	2785	97	96	1374	409	268	939	127	163	1084	602
User Adj:	1.00	0.84	1.00	1.00	0.84	1.00	1.00	1.00	1.00	1.00	1.00	1.00
PHF Adj:	1.00	1.00	1.00	1.00	1.00	1.00	1.00	1.00	1.00	1.00	1.00	1.00
PHF Volume:	243	2339	97	96	1154	409	268	939	127	163	1084	602
Reduct Vol:	0	0	0	0	0	0	0	0	0	0	0	0
Reduced Vol:	243	2339	97	96	1154	409	268	939	127	163	1084	602
PCE Adj:	1.00	1.00	1.00	1.00	1.00	1.00	1.00	1.00	1.00	1.00	1.00	1.00
MLF Adj:	1.00	1.00	1.00	1.00	1.00	1.00	1.00	1.00	1.00	1.00	1.00	1.00
FinalVolume:	243	2339	97	96	1154	409	268	939	127	163	1084	602
Saturation Flow Module:												
Sat/Lane:	1900	1900	1900	1900	1900	1900	1900	1900	1900	1900	1900	1900
Adjustment:	0.92	1.00	0.92	0.92	1.00	0.92	0.83	1.00	0.92	0.83	1.00	0.92
Lanes:	1.00	3.00	1.00	1.00	3.00	1.00	2.00	3.00	1.00	2.00	3.00	1.00
Final Sat.:	1750	5700	1750	1750	5700	1750	3150	5700	1750	3150	5700	1750
Capacity Analysis Module:												
Vol/Sat:	0.14	0.41	0.06	0.05	0.20	0.23	0.09	0.16	0.07	0.05	0.19	0.34
Crit Moves:	****			****			****			****		
Green Time:	37.7	81.7	102.1	10.9	54.9	71.9	16.9	65.0	65.0	20.4	68.5	68.5
Volume/Cap:	0.70	0.95	0.10	0.95	0.70	0.62	0.95	0.48	0.21	0.48	0.53	0.95
Delay/Veh:	77.6	70.7	27.8	167.8	77.9	69.1	127.5	49.4	44.5	80.9	48.3	84.3
User DelAdj:	1.00	1.00	1.00	1.00	1.00	1.00	1.00	1.00	1.00	1.00	1.00	1.00
AdjDel/Veh:	77.6	70.7	27.8	167.8	77.9	69.1	127.5	49.4	44.5	80.9	48.3	84.3
LOS by Move:	E	E	C	F	E	E	F	D	D	F	D	F
HCM2k95thQ:	26	74	8	14	36	39	23	25	11	10	28	63

Note: Queue reported is the number of cars per lane.

BART Phase II Extension Project

Level Of Service Computation Report
 2000 HCM Operations (Future Volume Alternative)
 PM - 2035 Project Conditions

Intersection #5416: SAN TOMAS EXPWY/EL CAMINO REAL

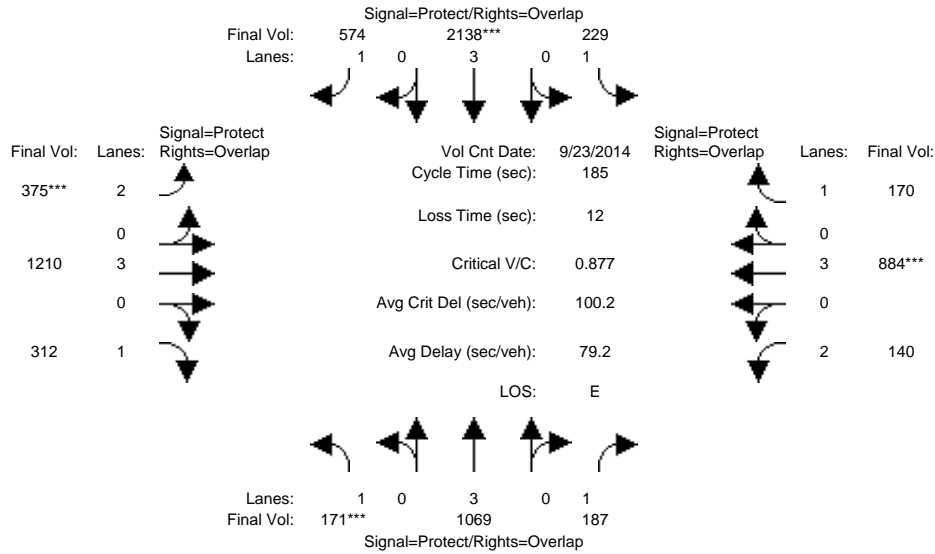

Approach:	North Bound			South Bound			East Bound			West Bound		
Movement:	L	T	R	L	T	R	L	T	R	L	T	R
Min. Green:	12	72	72	33	93	93	39	50	50	29	41	41
Y+R:	4.0	4.0	4.0	4.0	4.0	4.0	4.0	4.0	4.0	4.0	4.0	4.0
Volume Module: >> Count Date: 23 Sep 2014 <<												
Base Vol:	171	1406	187	229	2777	574	375	1210	312	140	884	170
Growth Adj:	1.00	1.00	1.00	1.00	1.00	1.00	1.00	1.00	1.00	1.00	1.00	1.00
Initial Bse:	171	1406	187	229	2777	574	375	1210	312	140	884	170
Added Vol:	0	0	0	0	0	0	0	0	0	0	0	0
PasserByVol:	0	0	0	0	0	0	0	0	0	0	0	0
Initial Fut:	171	1406	187	229	2777	574	375	1210	312	140	884	170
User Adj:	1.00	0.76	1.00	1.00	0.77	1.00	1.00	1.00	1.00	1.00	1.00	1.00
PHF Adj:	1.00	1.00	1.00	1.00	1.00	1.00	1.00	1.00	1.00	1.00	1.00	1.00
PHF Volume:	171	1069	187	229	2138	574	375	1210	312	140	884	170
Reduct Vol:	0	0	0	0	0	0	0	0	0	0	0	0
Reduced Vol:	171	1069	187	229	2138	574	375	1210	312	140	884	170
PCE Adj:	1.00	1.00	1.00	1.00	1.00	1.00	1.00	1.00	1.00	1.00	1.00	1.00
MLF Adj:	1.00	1.00	1.00	1.00	1.00	1.00	1.00	1.00	1.00	1.00	1.00	1.00
FinalVolume:	171	1069	187	229	2138	574	375	1210	312	140	884	170
Saturation Flow Module:												
Sat/Lane:	1900	1900	1900	1900	1900	1900	1900	1900	1900	1900	1900	1900
Adjustment:	0.92	1.00	0.92	0.92	0.83	0.92	0.83	1.00	0.92	0.83	1.00	0.92
Lanes:	1.00	3.00	1.00	1.00	3.00	1.00	2.00	3.00	1.00	2.00	3.00	1.00
Final Sat.:	1750	5700	1750	1750	4731	1750	3150	5700	1750	3150	5700	1750
Capacity Analysis Module:												
Vol/Sat:	0.10	0.19	0.11	0.13	0.45	0.33	0.12	0.21	0.18	0.04	0.16	0.10
Crit Moves:	****				****		****				****	
Green Time:	11.3	67.6	95.2	31.0	87.3	124.0	36.6	47.5	58.8	27.6	38.5	69.5
Volume/Cap:	1.60	0.51	0.21	0.78	0.96	0.49	0.60	0.83	0.56	0.30	0.75	0.26
Delay/Veh:	403.6	54.3	32.8	101.8	90.8	37.9	73.6	73.0	57.1	75.0	75.7	42.7
User DelAdj:	1.00	1.00	1.00	1.00	1.00	1.00	1.00	1.00	1.00	1.00	1.00	1.00
AdjDel/Veh:	403.6	54.3	32.8	101.8	90.8	37.9	73.6	73.0	57.1	75.0	75.7	42.7
LOS by Move:	F	D	C	F	F	D	E	E	E	E	E	D
HCM2k95thQ:	33	31	15	27	71	50	23	40	29	9	29	14

Note: Queue reported is the number of cars per lane.

BART Phase II Extension Project

Level Of Service Computation Report
2000 HCM Operations (Future Volume Alternative)
AM - 2035 Project Conditions

Intersection #5444: Lafayette/Lewis

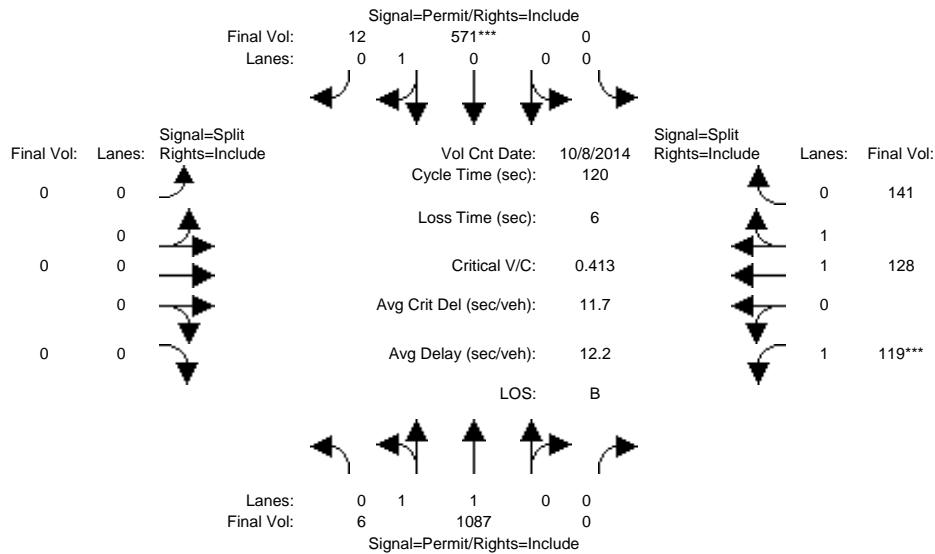

Approach:	North Bound			South Bound			East Bound			West Bound		
Movement:	L	T	R	L	T	R	L	T	R	L	T	R
Min. Green:	10	10	0	0	10	10	0	0	0	10	10	10
Y+R:	4.0	4.0	4.0	4.0	4.0	4.0	4.0	4.0	4.0	4.0	4.0	4.0
Volume Module: >> Count Date: 8 Oct 2014 <<												
Base Vol:	6	1087	0	0	571	12	0	0	0	119	128	141
Growth Adj:	1.00	1.00	1.00	1.00	1.00	1.00	1.00	1.00	1.00	1.00	1.00	1.00
Initial Bse:	6	1087	0	0	571	12	0	0	0	119	128	141
Added Vol:	0	0	0	0	0	0	0	0	0	0	0	0
PasserByVol:	0	0	0	0	0	0	0	0	0	0	0	0
Initial Fut:	6	1087	0	0	571	12	0	0	0	119	128	141
User Adj:	1.00	1.00	1.00	1.00	1.00	1.00	1.00	1.00	1.00	1.00	1.00	1.00
PHF Adj:	1.00	1.00	1.00	1.00	1.00	1.00	1.00	1.00	1.00	1.00	1.00	1.00
PHF Volume:	6	1087	0	0	571	12	0	0	0	119	128	141
Reduct Vol:	0	0	0	0	0	0	0	0	0	0	0	0
Reduced Vol:	6	1087	0	0	571	12	0	0	0	119	128	141
PCE Adj:	1.00	1.00	1.00	1.00	1.00	1.00	1.00	1.00	1.00	1.00	1.00	1.00
MLF Adj:	1.00	1.00	1.00	1.00	1.00	1.00	1.00	1.00	1.00	1.00	1.00	1.00
FinalVolume:	6	1087	0	0	571	12	0	0	0	119	128	141
Saturation Flow Module:												
Sat/Lane:	1900	1900	1900	1900	1900	1900	1900	1900	1900	1900	1900	1900
Adjustment:	0.95	0.97	0.92	0.92	0.95	0.95	0.92	1.00	0.92	0.92	1.00	0.92
Lanes:	0.01	1.99	0.00	0.00	0.98	0.02	0.00	0.00	0.00	1.00	1.00	1.00
Final Sat.:	20	3680	0	0	1763	37	0	0	0	1750	1900	1750
Capacity Analysis Module:												
Vol/Sat:	0.30	0.30	0.00	0.00	0.32	0.32	0.00	0.00	0.00	0.07	0.07	0.08
Crit Moves:	****						****					
Green Time:	91.3	91.3	0.0	0.0	91.3	91.3	0.0	0.0	0.0	22.7	22.7	22.7
Volume/Cap:	0.39	0.39	0.00	0.00	0.43	0.43	0.00	0.00	0.00	0.36	0.36	0.43
Delay/Veh:	5.0	5.0	0.0	0.0	5.3	5.3	0.0	0.0	0.0	43.0	42.6	43.4
User DelAdj:	1.00	1.00	1.00	1.00	1.00	1.00	1.00	1.00	1.00	1.00	1.00	1.00
AdjDel/Veh:	5.0	5.0	0.0	0.0	5.3	5.3	0.0	0.0	0.0	43.0	42.6	43.4
LOS by Move:	A	A	A	A	A	A	A	A	A	D	D	D
HCM2k95thQ:	13	13	0	0	15	15	0	0	0	8	8	10

Note: Queue reported is the number of cars per lane.

BART Phase II Extension Project

Level Of Service Computation Report
2000 HCM Operations (Future Volume Alternative)
PM - 2035 Project Conditions

Intersection #5444: Lafayette/Lewis

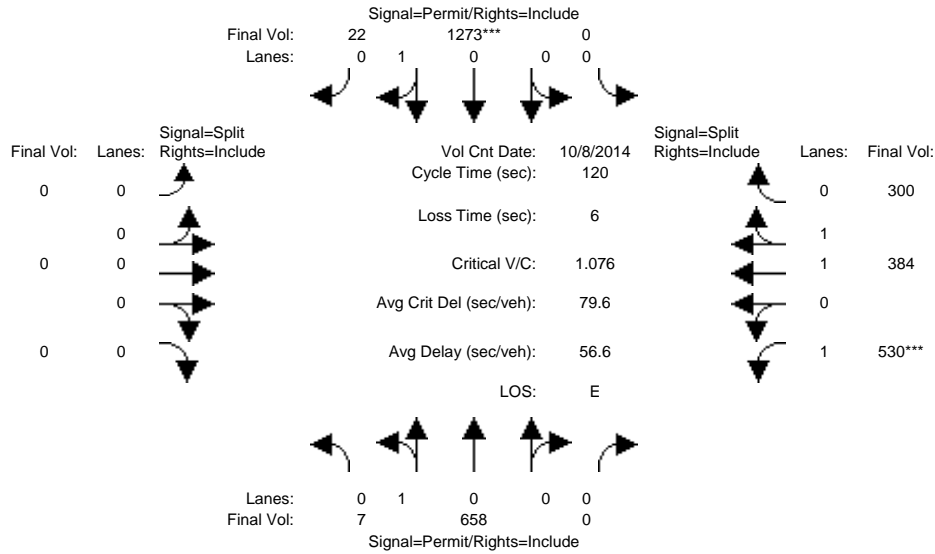

Approach:	North Bound			South Bound			East Bound			West Bound		
Movement:	L	T	R	L	T	R	L	T	R	L	T	R
Min. Green:	10	10	0	0	10	10	0	0	0	10	10	10
Y+R:	4.0	4.0	4.0	4.0	4.0	4.0	4.0	4.0	4.0	4.0	4.0	4.0
Volume Module: >> Count Date: 8 Oct 2014 <<												
Base Vol:	7	658	0	0	1273	22	0	0	0	530	384	300
Growth Adj:	1.00	1.00	1.00	1.00	1.00	1.00	1.00	1.00	1.00	1.00	1.00	1.00
Initial Bse:	7	658	0	0	1273	22	0	0	0	530	384	300
Added Vol:	0	0	0	0	0	0	0	0	0	0	0	0
PasserByVol:	0	0	0	0	0	0	0	0	0	0	0	0
Initial Fut:	7	658	0	0	1273	22	0	0	0	530	384	300
User Adj:	1.00	1.00	1.00	1.00	1.00	1.00	1.00	1.00	1.00	1.00	1.00	1.00
PHF Adj:	1.00	1.00	1.00	1.00	1.00	1.00	1.00	1.00	1.00	1.00	1.00	1.00
PHF Volume:	7	658	0	0	1273	22	0	0	0	530	384	300
Reduct Vol:	0	0	0	0	0	0	0	0	0	0	0	0
Reduced Vol:	7	658	0	0	1273	22	0	0	0	530	384	300
PCE Adj:	1.00	1.00	1.00	1.00	1.00	1.00	1.00	1.00	1.00	1.00	1.00	1.00
MLF Adj:	1.00	1.00	1.00	1.00	1.00	1.00	1.00	1.00	1.00	1.00	1.00	1.00
FinalVolume:	7	658	0	0	1273	22	0	0	0	530	384	300
Saturation Flow Module:												
Sat/Lane:	1900	1900	1900	1900	1900	1900	1900	1900	1900	1900	1900	1900
Adjustment:	0.95	0.95	0.92	0.92	0.95	0.95	0.92	1.00	0.92	0.92	0.99	0.95
Lanes:	0.01	0.99	0.00	0.00	0.98	0.02	0.00	0.00	0.00	1.00	1.10	0.90
Final Sat.:	19	1781	0	0	1769	31	0	0	0	1750	2076	1622
Capacity Analysis Module:												
Vol/Sat:	0.37	0.37	0.00	0.00	0.72	0.72	0.00	0.00	0.00	0.30	0.18	0.18
Crit Moves:	****						****					
Green Time:	80.2	80.2	0.0	0.0	80.2	80.2	0.0	0.0	0.0	33.8	33.8	33.8
Volume/Cap:	0.55	0.55	0.00	0.00	1.08	1.08	0.00	0.00	0.00	1.08	0.66	0.66
Delay/Veh:	11.0	11.0	0.0	0.0	68.9	68.9	0.0	0.0	0.0	105.7	39.6	39.6
User DelAdj:	1.00	1.00	1.00	1.00	1.00	1.00	1.00	1.00	1.00	1.00	1.00	1.00
AdjDel/Veh:	11.0	11.0	0.0	0.0	68.9	68.9	0.0	0.0	0.0	105.7	39.6	39.6
LOS by Move:	B	B	A	A	E	E	A	A	A	F	D	D
HCM2k95thQ:	23	23	0	0	96	96	0	0	0	49	22	22

Note: Queue reported is the number of cars per lane.

BART Phase II Extension Project

Level Of Service Computation Report
 2000 HCM Operations (Future Volume Alternative)
 AM - 2035 SC West Project Conditions

Intersection #6: DE LA CRUZ/MARTIN

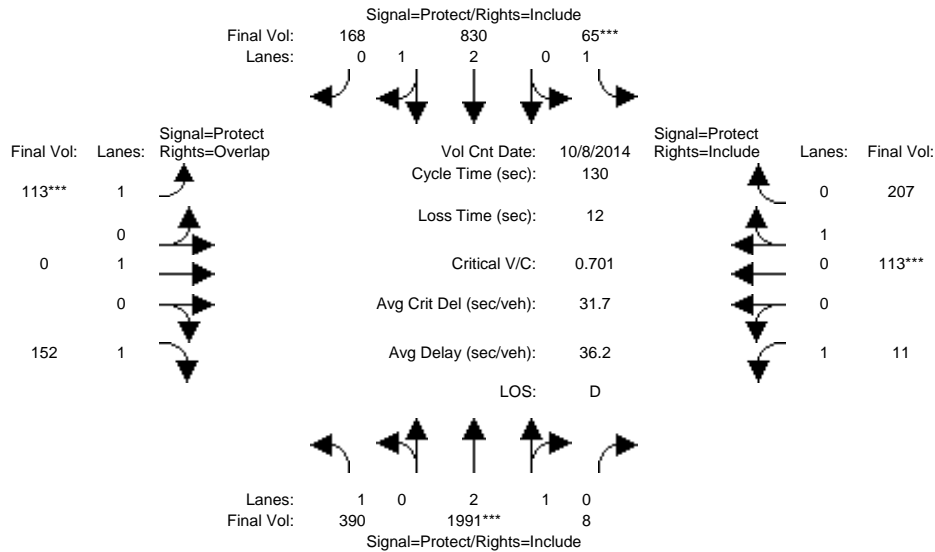

Approach:	North Bound			South Bound			East Bound			West Bound		
	L	T	R	L	T	R	L	T	R	L	T	R
Movement:												
Min. Green:	7	10	10	7	10	10	7	10	10	7	10	10
Y+R:	4.0	4.0	4.0	4.0	4.0	4.0	4.0	4.0	4.0	4.0	4.0	4.0

Volume Module:	>>	Count	Date:	8 Oct 2014	<<											
Base Vol:	390	1991	8	65	830	168	113	0	152	11	113	207				
Growth Adj:	1.00	1.00	1.00	1.00	1.00	1.00	1.00	1.00	1.00	1.00	1.00	1.00				
Initial Bse:	390	1991	8	65	830	168	113	0	152	11	113	207				
Added Vol:	0	0	0	0	0	0	0	0	0	0	0	0				
PasserByVol:	0	0	0	0	0	0	0	0	0	0	0	0				
Initial Fut:	390	1991	8	65	830	168	113	0	152	11	113	207				
User Adj:	1.00	1.00	1.00	1.00	1.00	1.00	1.00	1.00	1.00	1.00	1.00	1.00				
PHF Adj:	1.00	1.00	1.00	1.00	1.00	1.00	1.00	1.00	1.00	1.00	1.00	1.00				
PHF Volume:	390	1991	8	65	830	168	113	0	152	11	113	207				
Reduct Vol:	0	0	0	0	0	0	0	0	0	0	0	0				
Reduced Vol:	390	1991	8	65	830	168	113	0	152	11	113	207				
PCE Adj:	1.00	1.00	1.00	1.00	1.00	1.00	1.00	1.00	1.00	1.00	1.00	1.00				
MLF Adj:	1.00	1.00	1.00	1.00	1.00	1.00	1.00	1.00	1.00	1.00	1.00	1.00				
Final Volume:	390	1991	8	65	830	168	113	0	152	11	113	207				

Saturation Flow Module:												
Sat/Lane:	1900	1900	1900	1900	1900	1900	1900	1900	1900	1900	1900	1900
Adjustment:	0.92	0.98	0.95	0.92	0.99	0.95	0.92	1.00	0.92	0.92	0.95	0.95
Lanes:	1.00	2.99	0.01	1.00	2.48	0.52	1.00	1.00	1.00	1.00	0.35	0.65
Final Sat.:	1750	5578	22	1750	4656	942	1750	1900	1750	1750	636	1164

Capacity Analysis Module:												
Vol/Sat:	0.22	0.36	0.36	0.04	0.18	0.18	0.06	0.00	0.09	0.01	0.18	0.18
Crit Moves:	****			****			****			****		
Green Time:	40.6	66.1	66.1	7.0	32.5	32.5	12.0	0.0	52.6	44.9	32.9	32.9
Volume/Cap:	0.71	0.70	0.70	0.69	0.71	0.71	0.70	0.00	0.21	0.02	0.70	0.70
Delay/Veh:	44.0	25.2	25.2	79.9	46.3	46.3	70.3	0.0	25.4	28.1	48.9	48.9
User DelAdj:	1.00	1.00	1.00	1.00	1.00	1.00	1.00	1.00	1.00	1.00	1.00	1.00
AdjDel/Veh:	44.0	25.2	25.2	79.9	46.3	46.3	70.3	0.0	25.4	28.1	48.9	48.9
LOS by Move:	D	C	C	E	D	D	E	A	C	C	D	D
HCM2k95thQ:	26	35	35	6	22	22	10	0	8	1	24	24

Note: Queue reported is the number of cars per lane.

BART Phase II Extension Project

Level Of Service Computation Report
 2000 HCM Operations (Future Volume Alternative)
 PM - 2035 SC West Project Conditions

Intersection #6: DE LA CRUZ/MARTIN

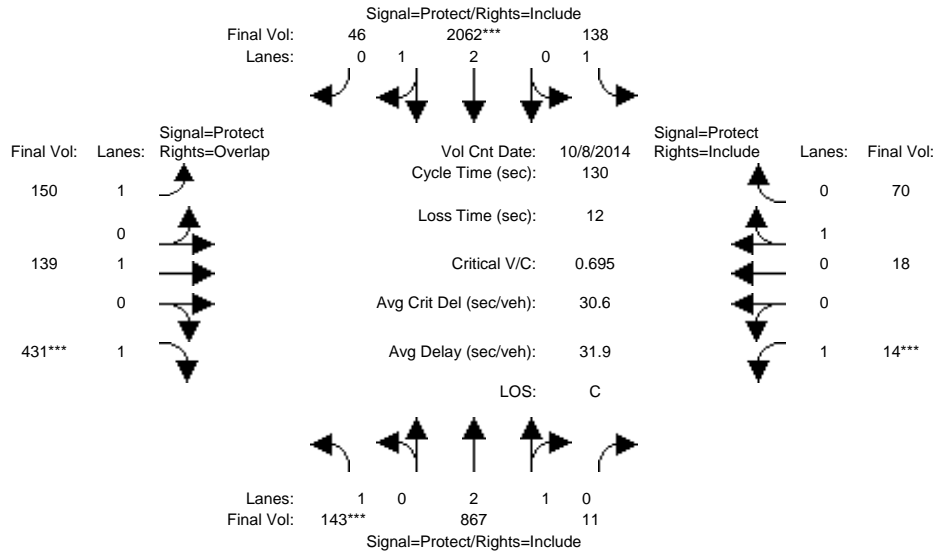

Approach:	North Bound			South Bound			East Bound			West Bound		
	L	T	R	L	T	R	L	T	R	L	T	R
Min. Green:	7	10	10	7	10	10	7	10	10	7	10	10
Y+R:	4.0	4.0	4.0	4.0	4.0	4.0	4.0	4.0	4.0	4.0	4.0	4.0
Volume Module: >> Count Date: 8 Oct 2014 <<												
Base Vol:	143	867	11	138	2062	46	150	139	431	14	18	70
Growth Adj:	1.00	1.00	1.00	1.00	1.00	1.00	1.00	1.00	1.00	1.00	1.00	1.00
Initial Bse:	143	867	11	138	2062	46	150	139	431	14	18	70
Added Vol:	0	0	0	0	0	0	0	0	0	0	0	0
PasserByVol:	0	0	0	0	0	0	0	0	0	0	0	0
Initial Fut:	143	867	11	138	2062	46	150	139	431	14	18	70
User Adj:	1.00	1.00	1.00	1.00	1.00	1.00	1.00	1.00	1.00	1.00	1.00	1.00
PHF Adj:	1.00	1.00	1.00	1.00	1.00	1.00	1.00	1.00	1.00	1.00	1.00	1.00
PHF Volume:	143	867	11	138	2062	46	150	139	431	14	18	70
Reduct Vol:	0	0	0	0	0	0	0	0	0	0	0	0
Reduced Vol:	143	867	11	138	2062	46	150	139	431	14	18	70
PCE Adj:	1.00	1.00	1.00	1.00	1.00	1.00	1.00	1.00	1.00	1.00	1.00	1.00
MLF Adj:	1.00	1.00	1.00	1.00	1.00	1.00	1.00	1.00	1.00	1.00	1.00	1.00
Final Volume:	143	867	11	138	2062	46	150	139	431	14	18	70
Saturation Flow Module:												
Sat/Lane:	1900	1900	1900	1900	1900	1900	1900	1900	1900	1900	1900	1900
Adjustment:	0.92	0.98	0.95	0.92	0.98	0.95	0.92	1.00	0.92	0.92	0.95	0.95
Lanes:	1.00	2.96	0.04	1.00	2.93	0.07	1.00	1.00	1.00	1.00	0.20	0.80
Final Sat.:	1750	5530	70	1750	5478	122	1750	1900	1750	1750	368	1432
Capacity Analysis Module:												
Vol/Sat:	0.08	0.16	0.16	0.08	0.38	0.38	0.09	0.07	0.25	0.01	0.05	0.05
Crit Moves:	****			****			****		****	****		
Green Time:	14.6	54.3	54.3	27.3	67.1	67.1	19.1	29.3	43.9	7.0	17.2	17.2
Volume/Cap:	0.73	0.38	0.38	0.38	0.73	0.73	0.58	0.32	0.73	0.15	0.37	0.37
Delay/Veh:	68.8	26.2	26.2	44.7	25.4	25.4	55.0	42.5	42.4	59.4	52.4	52.4
User DelAdj:	1.00	1.00	1.00	1.00	1.00	1.00	1.00	1.00	1.00	1.00	1.00	1.00
AdjDel/Veh:	68.8	26.2	26.2	44.7	25.4	25.4	55.0	42.5	42.4	59.4	52.4	52.4
LOS by Move:	E	C	C	D	C	C	E	D	D	E	D	D
HCM2k95thQ:	12	15	15	10	37	37	12	9	29	1	7	7

Note: Queue reported is the number of cars per lane.

BART Phase II Extension Project

Level Of Service Computation Report
 2000 HCM Operations (Future Volume Alternative)
 AM - 2035 SC West Project Conditions

Intersection #7: LAFAYETTE/REED

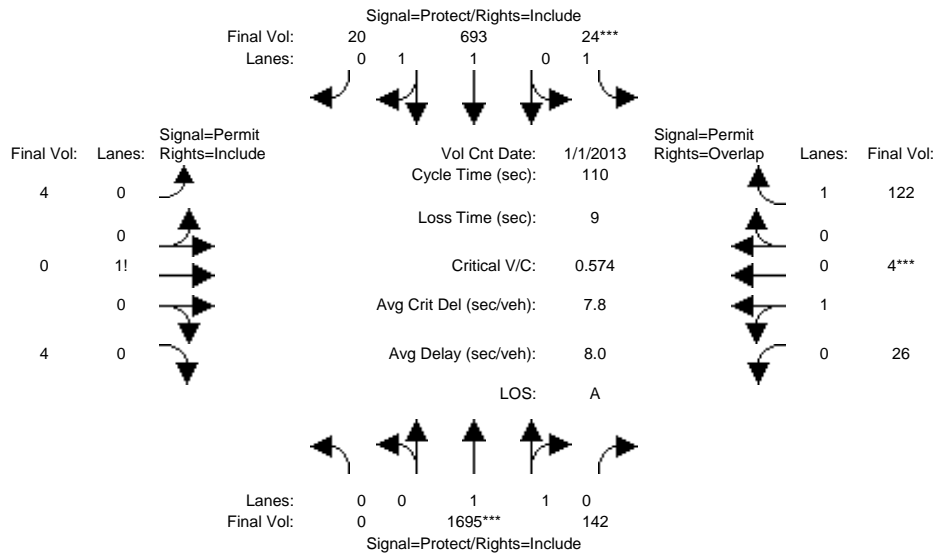

Approach:	North Bound			South Bound			East Bound			West Bound		
	L	T	R	L	T	R	L	T	R	L	T	R
Min. Green:	7	10	10	7	10	10	10	10	10	10	10	10
Y+R:	4.0	4.0	4.0	4.0	4.0	4.0	4.0	4.0	4.0	4.0	4.0	4.0

Volume Module:	>>	Count	Date:	1 Jan 2013	<<							
Base Vol:	0	1695	142	24	693	20	4	0	4	26	4	122
Growth Adj:	1.00	1.00	1.00	1.00	1.00	1.00	1.00	1.00	1.00	1.00	1.00	1.00
Initial Bse:	0	1695	142	24	693	20	4	0	4	26	4	122
Added Vol:	0	0	0	0	0	0	0	0	0	0	0	0
PasserByVol:	0	0	0	0	0	0	0	0	0	0	0	0
Initial Fut:	0	1695	142	24	693	20	4	0	4	26	4	122
User Adj:	1.00	1.00	1.00	1.00	1.00	1.00	1.00	1.00	1.00	1.00	1.00	1.00
PHF Adj:	1.00	1.00	1.00	1.00	1.00	1.00	1.00	1.00	1.00	1.00	1.00	1.00
PHF Volume:	0	1695	142	24	693	20	4	0	4	26	4	122
Reduct Vol:	0	0	0	0	0	0	0	0	0	0	0	0
Reduced Vol:	0	1695	142	24	693	20	4	0	4	26	4	122
PCE Adj:	1.00	1.00	1.00	1.00	1.00	1.00	1.00	1.00	1.00	1.00	1.00	1.00
MLF Adj:	1.00	1.00	1.00	1.00	1.00	1.00	1.00	1.00	1.00	1.00	1.00	1.00
FinalVolume:	0	1695	142	24	693	20	4	0	4	26	4	122

Saturation Flow Module:	Sat/Lane:	1900	1900	1900	1900	1900	1900	1900	1900	1900	1900	1900
Adjustment:	0.92	0.98	0.95	0.92	0.97	0.95	0.92	0.92	0.92	0.95	0.95	0.92
Lanes:	0.00	1.84	0.16	1.00	1.94	0.06	0.50	0.00	0.50	0.87	0.13	1.00
Final Sat.:	0	3414	286	1750	3596	104	875	0	875	1560	240	1750

Capacity Analysis Module:	Vol/Sat:	0.00	0.50	0.50	0.01	0.19	0.19	0.00	0.00	0.00	0.02	0.02	0.07
Crit Moves:	****	****	****	****	****	****	****	****	****	****	****	****	****
Green Time:	0.0	84.0	84.0	7.0	91.0	91.0	10.0	0.0	10.0	10.0	10.0	10.0	17.0
Volume/Cap:	0.00	0.65	0.65	0.22	0.23	0.23	0.05	0.00	0.05	0.18	0.18	0.45	0.45
Delay/Veh:	0.0	6.6	6.6	49.9	2.1	2.1	45.8	0.0	45.8	46.8	46.8	43.5	43.5
User DelAdj:	1.00	1.00	1.00	1.00	1.00	1.00	1.00	1.00	1.00	1.00	1.00	1.00	1.00
AdjDel/Veh:	0.0	6.6	6.6	49.9	2.1	2.1	45.8	0.0	45.8	46.8	46.8	43.5	43.5
LOS by Move:	A	A	A	D	A	A	D	A	D	D	D	D	D
HCM2k95thQ:	0	27	27	2	5	5	1	0	1	2	2	8	8

Note: Queue reported is the number of cars per lane.

BART Phase II Extension Project

Level Of Service Computation Report
 2000 HCM Operations (Future Volume Alternative)
 PM - 2035 SC West Project Conditions

Intersection #7: LAFAYETTE/REED

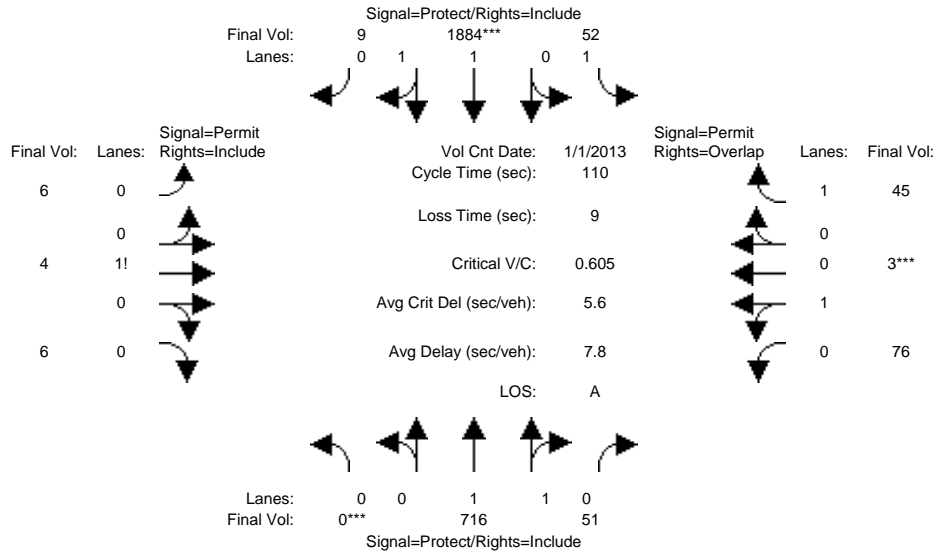

Approach:	North Bound			South Bound			East Bound			West Bound		
Movement:	L	T	R	L	T	R	L	T	R	L	T	R
Min. Green:	7	10	10	7	10	10	10	10	10	10	10	10
Y+R:	4.0	4.0	4.0	4.0	4.0	4.0	4.0	4.0	4.0	4.0	4.0	4.0
Volume Module: >> Count Date: 1 Jan 2013 <<												
Base Vol:	0	716	51	52	1884	9	6	4	6	76	3	45
Growth Adj:	1.00	1.00	1.00	1.00	1.00	1.00	1.00	1.00	1.00	1.00	1.00	1.00
Initial Bse:	0	716	51	52	1884	9	6	4	6	76	3	45
Added Vol:	0	0	0	0	0	0	0	0	0	0	0	0
PasserByVol:	0	0	0	0	0	0	0	0	0	0	0	0
Initial Fut:	0	716	51	52	1884	9	6	4	6	76	3	45
User Adj:	1.00	1.00	1.00	1.00	1.00	1.00	1.00	1.00	1.00	1.00	1.00	1.00
PHF Adj:	1.00	1.00	1.00	1.00	1.00	1.00	1.00	1.00	1.00	1.00	1.00	1.00
PHF Volume:	0	716	51	52	1884	9	6	4	6	76	3	45
Reduct Vol:	0	0	0	0	0	0	0	0	0	0	0	0
Reduced Vol:	0	716	51	52	1884	9	6	4	6	76	3	45
PCE Adj:	1.00	1.00	1.00	1.00	1.00	1.00	1.00	1.00	1.00	1.00	1.00	1.00
MLF Adj:	1.00	1.00	1.00	1.00	1.00	1.00	1.00	1.00	1.00	1.00	1.00	1.00
FinalVolume:	0	716	51	52	1884	9	6	4	6	76	3	45
Saturation Flow Module:												
Sat/Lane:	1900	1900	1900	1900	1900	1900	1900	1900	1900	1900	1900	1900
Adjustment:	0.92	0.98	0.95	0.92	0.97	0.95	0.92	0.92	0.92	0.95	0.95	0.92
Lanes:	0.00	1.86	0.14	1.00	1.99	0.01	0.37	0.25	0.38	0.96	0.04	1.00
Final Sat.:	0	3454	246	1750	3682	18	656	438	656	1732	68	1750
Capacity Analysis Module:												
Vol/Sat:	0.00	0.21	0.21	0.03	0.51	0.51	0.01	0.01	0.01	0.04	0.04	0.03
Crit Moves:	****				****						****	
Green Time:	0.0	69.6	69.6	21.4	91.0	91.0	10.0	10.0	10.0	10.0	10.0	31.4
Volume/Cap:	0.00	0.33	0.33	0.15	0.62	0.62	0.10	0.10	0.10	0.48	0.48	0.09
Delay/Veh:	0.0	9.4	9.4	37.0	3.7	3.7	46.2	46.2	46.2	49.8	49.8	28.9
User DelAdj:	1.00	1.00	1.00	1.00	1.00	1.00	1.00	1.00	1.00	1.00	1.00	1.00
AdjDel/Veh:	0.0	9.4	9.4	37.0	3.7	3.7	46.2	46.2	46.2	49.8	49.8	28.9
LOS by Move:	A	A	A	D	A	A	D	D	D	D	D	C
HCM2k95thQ:	0	12	12	3	22	22	1	1	1	5	5	2

Note: Queue reported is the number of cars per lane.

BART Phase II Extension Project

Level Of Service Computation Report
 2000 HCM Operations (Future Volume Alternative)
 AM - 2035 SC West Project Conditions

Intersection #9: Coleman/Brokaw

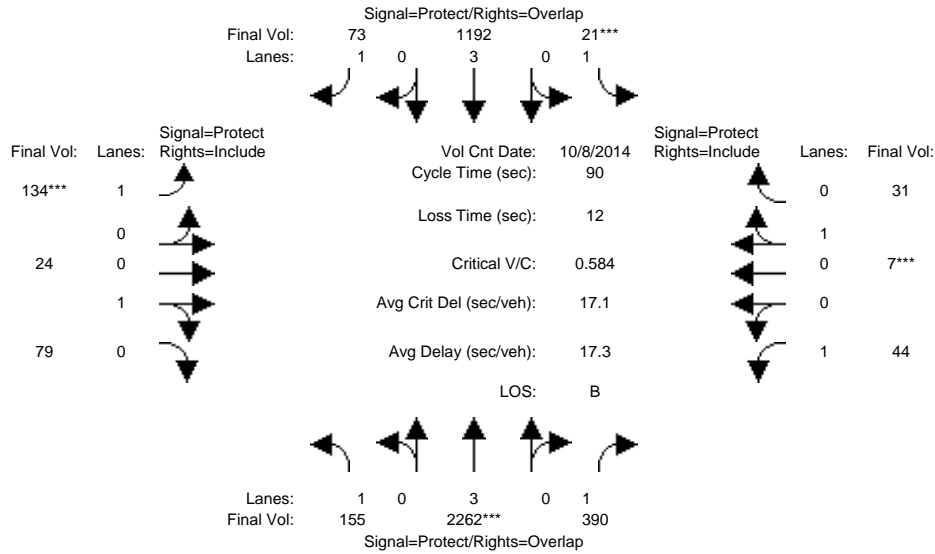

Approach:	North Bound			South Bound			East Bound			West Bound		
	L	T	R	L	T	R	L	T	R	L	T	R
Min. Green:	7	10	10	7	10	10	7	10	10	7	10	10
Y+R:	4.0	4.0	4.0	4.0	4.0	4.0	4.0	4.0	4.0	4.0	4.0	4.0
Volume Module: >> Count Date: 8 Oct 2014 <<												
Base Vol:	155	2262	390	21	1192	73	134	24	79	44	7	31
Growth Adj:	1.00	1.00	1.00	1.00	1.00	1.00	1.00	1.00	1.00	1.00	1.00	1.00
Initial Bse:	155	2262	390	21	1192	73	134	24	79	44	7	31
Added Vol:	0	0	0	0	0	0	0	0	0	0	0	0
PasserByVol:	0	0	0	0	0	0	0	0	0	0	0	0
Initial Fut:	155	2262	390	21	1192	73	134	24	79	44	7	31
User Adj:	1.00	1.00	1.00	1.00	1.00	1.00	1.00	1.00	1.00	1.00	1.00	1.00
PHF Adj:	1.00	1.00	1.00	1.00	1.00	1.00	1.00	1.00	1.00	1.00	1.00	1.00
PHF Volume:	155	2262	390	21	1192	73	134	24	79	44	7	31
Reduct Vol:	0	0	0	0	0	0	0	0	0	0	0	0
Reduced Vol:	155	2262	390	21	1192	73	134	24	79	44	7	31
PCE Adj:	1.00	1.00	1.00	1.00	1.00	1.00	1.00	1.00	1.00	1.00	1.00	1.00
MLF Adj:	1.00	1.00	1.00	1.00	1.00	1.00	1.00	1.00	1.00	1.00	1.00	1.00
FinalVolume:	155	2262	390	21	1192	73	134	24	79	44	7	31
Saturation Flow Module:												
Sat/Lane:	1900	1900	1900	1900	1900	1900	1900	1900	1900	1900	1900	1900
Adjustment:	0.92	1.00	0.92	0.92	1.00	0.92	0.92	0.95	0.95	0.92	0.95	0.95
Lanes:	1.00	3.00	1.00	1.00	3.00	1.00	1.00	0.23	0.77	1.00	0.18	0.82
Final Sat.:	1750	5700	1750	1750	5700	1750	1750	419	1381	1750	332	1468
Capacity Analysis Module:												
Vol/Sat:	0.09	0.40	0.22	0.01	0.21	0.04	0.08	0.06	0.06	0.03	0.02	0.02
Crit Moves:	****			****			****			****		
Green Time:	17.3	51.1	59.3	7.0	40.8	50.7	9.9	11.7	11.7	8.2	10.0	10.0
Volume/Cap:	0.46	0.70	0.34	0.15	0.46	0.07	0.70	0.44	0.44	0.28	0.19	0.19
Delay/Veh:	33.2	14.6	6.9	39.3	17.1	9.0	49.5	37.5	37.5	39.1	36.8	36.8
User DelAdj:	1.00	1.00	1.00	1.00	1.00	1.00	1.00	1.00	1.00	1.00	1.00	1.00
AdjDel/Veh:	33.2	14.6	6.9	39.3	17.1	9.0	49.5	37.5	37.5	39.1	36.8	36.8
LOS by Move:	C	B	A	D	B	A	D	D	D	D	D	D
HCM2k95thQ:	7	24	9	1	14	2	10	7	7	2	2	2

Note: Queue reported is the number of cars per lane.

BART Phase II Extension Project

Level Of Service Computation Report
 2000 HCM Operations (Future Volume Alternative)
 PM - 2035 SC West Project Conditions

Intersection #9: Coleman/Brokaw

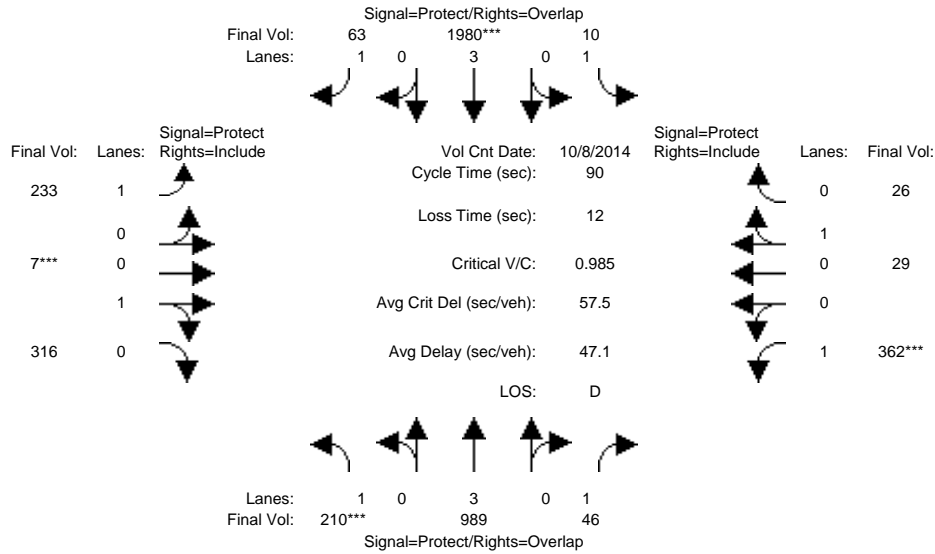

Approach:	North Bound			South Bound			East Bound			West Bound		
Movement:	L	T	R	L	T	R	L	T	R	L	T	R
Min. Green:	7	10	10	7	10	10	7	10	10	7	10	10
Y+R:	4.0	4.0	4.0	4.0	4.0	4.0	4.0	4.0	4.0	4.0	4.0	4.0
Volume Module: >> Count Date: 8 Oct 2014 <<												
Base Vol:	210	989	46	10	1980	63	233	7	316	362	29	26
Growth Adj:	1.00	1.00	1.00	1.00	1.00	1.00	1.00	1.00	1.00	1.00	1.00	1.00
Initial Bse:	210	989	46	10	1980	63	233	7	316	362	29	26
Added Vol:	0	0	0	0	0	0	0	0	0	0	0	0
PasserByVol:	0	0	0	0	0	0	0	0	0	0	0	0
Initial Fut:	210	989	46	10	1980	63	233	7	316	362	29	26
User Adj:	1.00	1.00	1.00	1.00	1.00	1.00	1.00	1.00	1.00	1.00	1.00	1.00
PHF Adj:	1.00	1.00	1.00	1.00	1.00	1.00	1.00	1.00	1.00	1.00	1.00	1.00
PHF Volume:	210	989	46	10	1980	63	233	7	316	362	29	26
Reduct Vol:	0	0	0	0	0	0	0	0	0	0	0	0
Reduced Vol:	210	989	46	10	1980	63	233	7	316	362	29	26
PCE Adj:	1.00	1.00	1.00	1.00	1.00	1.00	1.00	1.00	1.00	1.00	1.00	1.00
MLF Adj:	1.00	1.00	1.00	1.00	1.00	1.00	1.00	1.00	1.00	1.00	1.00	1.00
FinalVolume:	210	989	46	10	1980	63	233	7	316	362	29	26
Saturation Flow Module:												
Sat/Lane:	1900	1900	1900	1900	1900	1900	1900	1900	1900	1900	1900	1900
Adjustment:	0.92	1.00	0.92	0.92	1.00	0.92	0.92	0.95	0.95	0.92	0.95	0.95
Lanes:	1.00	3.00	1.00	1.00	3.00	1.00	1.00	0.02	0.98	1.00	0.53	0.47
Final Sat.:	1750	5700	1750	1750	5700	1750	1750	39	1761	1750	949	851
Capacity Analysis Module:												
Vol/Sat:	0.12	0.17	0.03	0.01	0.35	0.04	0.13	0.18	0.18	0.21	0.03	0.03
Crit Moves:	****				****			****			****	
Green Time:	11.0	29.5	48.4	13.2	31.7	51.0	19.2	16.4	16.4	18.9	16.1	16.1
Volume/Cap:	0.99	0.53	0.05	0.04	0.99	0.06	0.62	0.99	0.99	0.99	0.17	0.17
Delay/Veh:	96.6	24.9	9.9	33.0	45.5	8.8	35.3	82.2	82.2	78.2	31.6	31.6
User DelAdj:	1.00	1.00	1.00	1.00	1.00	1.00	1.00	1.00	1.00	1.00	1.00	1.00
AdjDel/Veh:	96.6	24.9	9.9	33.0	45.5	8.8	35.3	82.2	82.2	78.2	31.6	31.6
LOS by Move:	F	C	A	C	D	A	D	F	F	E	C	C
HCM2k95thQ:	15	14	1	1	38	2	14	26	26	25	3	3

Note: Queue reported is the number of cars per lane.

BART Phase II Extension Project

Level Of Service Computation Report
 2000 HCM Operations (Future Volume Alternative)
 AM - 2035 SC West Project Conditions

Intersection #106: Benton/EI Camino Real

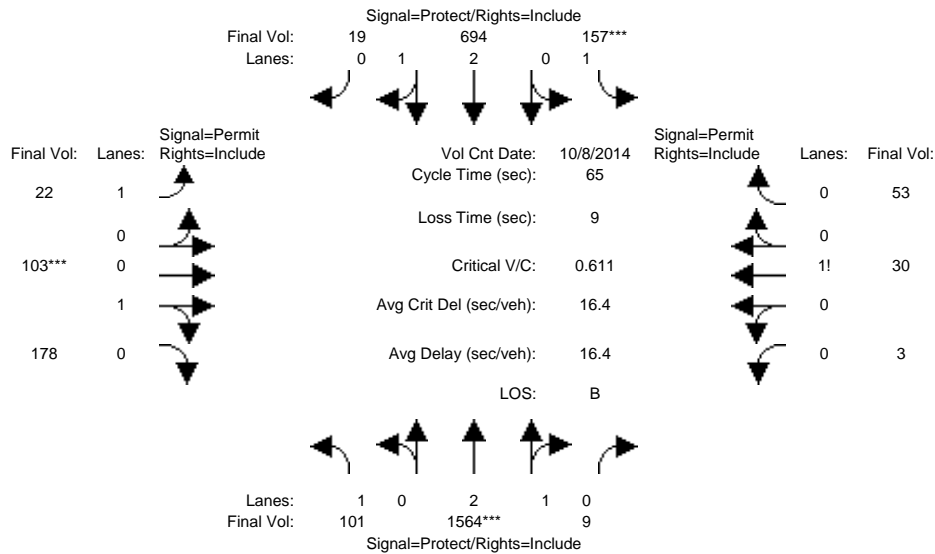

Approach:	North Bound			South Bound			East Bound			West Bound		
	L	T	R	L	T	R	L	T	R	L	T	R
Min. Green:	7	10	10	7	10	10	10	10	10	10	10	10
Y+R:	4.0	4.0	4.0	4.0	4.0	4.0	4.0	4.0	4.0	4.0	4.0	4.0
Volume Module: >> Count Date: 8 Oct 2014 <<												
Base Vol:	101	1564	9	157	694	19	22	103	178	3	30	53
Growth Adj:	1.00	1.00	1.00	1.00	1.00	1.00	1.00	1.00	1.00	1.00	1.00	1.00
Initial Bse:	101	1564	9	157	694	19	22	103	178	3	30	53
Added Vol:	0	0	0	0	0	0	0	0	0	0	0	0
PasserByVol:	0	0	0	0	0	0	0	0	0	0	0	0
Initial Fut:	101	1564	9	157	694	19	22	103	178	3	30	53
User Adj:	1.00	1.00	1.00	1.00	1.00	1.00	1.00	1.00	1.00	1.00	1.00	1.00
PHF Adj:	1.00	1.00	1.00	1.00	1.00	1.00	1.00	1.00	1.00	1.00	1.00	1.00
PHF Volume:	101	1564	9	157	694	19	22	103	178	3	30	53
Reduct Vol:	0	0	0	0	0	0	0	0	0	0	0	0
Reduced Vol:	101	1564	9	157	694	19	22	103	178	3	30	53
PCE Adj:	1.00	1.00	1.00	1.00	1.00	1.00	1.00	1.00	1.00	1.00	1.00	1.00
MLF Adj:	1.00	1.00	1.00	1.00	1.00	1.00	1.00	1.00	1.00	1.00	1.00	1.00
FinalVolume:	101	1564	9	157	694	19	22	103	178	3	30	53
Saturation Flow Module:												
Sat/Lane:	1900	1900	1900	1900	1900	1900	1900	1900	1900	1900	1900	1900
Adjustment:	0.92	0.98	0.95	0.92	0.98	0.95	0.92	0.95	0.95	0.92	0.92	0.92
Lanes:	1.00	2.98	0.02	1.00	2.92	0.08	1.00	0.37	0.63	0.03	0.35	0.62
Final Sat.:	1750	5568	32	1750	5451	149	1750	660	1140	61	610	1078
Capacity Analysis Module:												
Vol/Sat:	0.06	0.28	0.28	0.09	0.13	0.13	0.01	0.16	0.16	0.05	0.05	0.05
Crit Moves:	****			****			****					
Green Time:	16.2	29.9	29.9	9.5	23.2	23.2	16.6	16.6	16.6	16.6	16.6	16.6
Volume/Cap:	0.23	0.61	0.61	0.61	0.36	0.36	0.05	0.61	0.61	0.19	0.19	0.19
Delay/Veh:	19.7	13.6	13.6	30.3	15.5	15.5	18.3	23.8	23.8	19.2	19.2	19.2
User DelAdj:	1.00	1.00	1.00	1.00	1.00	1.00	1.00	1.00	1.00	1.00	1.00	1.00
AdjDel/Veh:	19.7	13.6	13.6	30.3	15.5	15.5	18.3	23.8	23.8	19.2	19.2	19.2
LOS by Move:	B	B	B	C	B	B	B	C	C	B	B	B
HCM2k95thQ:	3	15	15	7	7	7	1	10	10	3	3	3

Note: Queue reported is the number of cars per lane.

BART Phase II Extension Project

Level Of Service Computation Report
 2000 HCM Operations (Future Volume Alternative)
 PM - 2035 SC West Project Conditions

Intersection #106: Benton/EI Camino Real

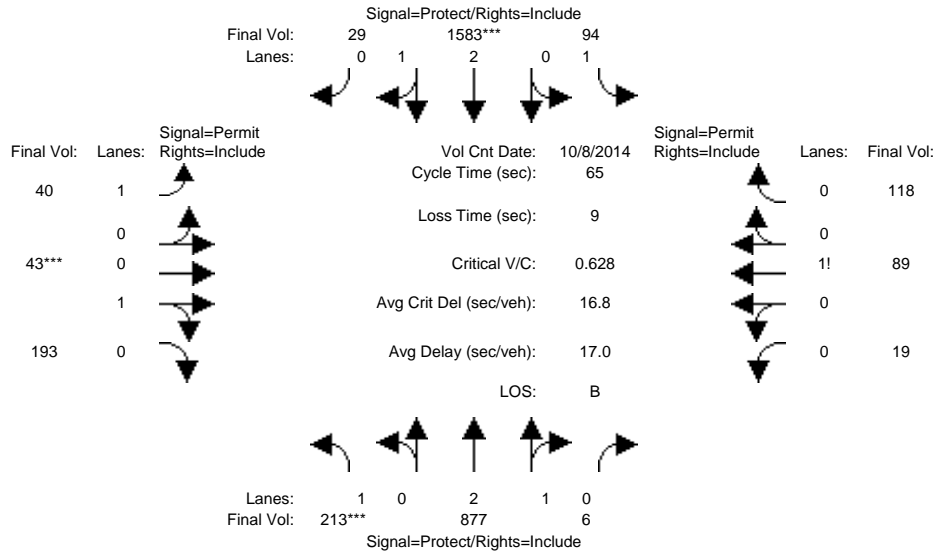

Approach:	North Bound			South Bound			East Bound			West Bound		
	L	T	R	L	T	R	L	T	R	L	T	R
Min. Green:	7	10	10	7	10	10	10	10	10	10	10	10
Y+R:	4.0	4.0	4.0	4.0	4.0	4.0	4.0	4.0	4.0	4.0	4.0	4.0
Volume Module: >> Count Date: 8 Oct 2014 <<												
Base Vol:	213	877	6	94	1583	29	40	43	193	19	89	118
Growth Adj:	1.00	1.00	1.00	1.00	1.00	1.00	1.00	1.00	1.00	1.00	1.00	1.00
Initial Bse:	213	877	6	94	1583	29	40	43	193	19	89	118
Added Vol:	0	0	0	0	0	0	0	0	0	0	0	0
PasserByVol:	0	0	0	0	0	0	0	0	0	0	0	0
Initial Fut:	213	877	6	94	1583	29	40	43	193	19	89	118
User Adj:	1.00	1.00	1.00	1.00	1.00	1.00	1.00	1.00	1.00	1.00	1.00	1.00
PHF Adj:	1.00	1.00	1.00	1.00	1.00	1.00	1.00	1.00	1.00	1.00	1.00	1.00
PHF Volume:	213	877	6	94	1583	29	40	43	193	19	89	118
Reduct Vol:	0	0	0	0	0	0	0	0	0	0	0	0
Reduced Vol:	213	877	6	94	1583	29	40	43	193	19	89	118
PCE Adj:	1.00	1.00	1.00	1.00	1.00	1.00	1.00	1.00	1.00	1.00	1.00	1.00
MLF Adj:	1.00	1.00	1.00	1.00	1.00	1.00	1.00	1.00	1.00	1.00	1.00	1.00
FinalVolume:	213	877	6	94	1583	29	40	43	193	19	89	118
Saturation Flow Module:												
Sat/Lane:	1900	1900	1900	1900	1900	1900	1900	1900	1900	1900	1900	1900
Adjustment:	0.92	0.98	0.95	0.92	0.98	0.95	0.92	0.95	0.95	0.92	0.92	0.92
Lanes:	1.00	2.98	0.02	1.00	2.94	0.06	1.00	0.18	0.82	0.08	0.39	0.53
Final Sat.:	1750	5562	38	1750	5499	101	1750	328	1472	147	689	914
Capacity Analysis Module:												
Vol/Sat:	0.12	0.16	0.16	0.05	0.29	0.29	0.02	0.13	0.13	0.13	0.13	0.13
Crit Moves:	****			****			****					
Green Time:	12.6	25.2	25.2	17.2	29.8	29.8	13.6	13.6	13.6	13.6	13.6	13.6
Volume/Cap:	0.63	0.41	0.41	0.20	0.63	0.63	0.11	0.63	0.63	0.62	0.62	0.62
Delay/Veh:	27.8	14.6	14.6	18.8	13.9	13.9	20.9	26.8	26.8	26.6	26.6	26.6
User DelAdj:	1.00	1.00	1.00	1.00	1.00	1.00	1.00	1.00	1.00	1.00	1.00	1.00
AdjDel/Veh:	27.8	14.6	14.6	18.8	13.9	13.9	20.9	26.8	26.8	26.6	26.6	26.6
LOS by Move:	C	B	B	B	B	B	C	C	C	C	C	C
HCM2k95thQ:	8	8	8	3	16	16	1	9	9	11	11	11

Note: Queue reported is the number of cars per lane.

BART Phase II Extension Project

Level Of Service Computation Report
 2000 HCM Operations (Future Volume Alternative)
 AM - 2035 SC West Project Conditions

Intersection #107: Benton/Lafayette

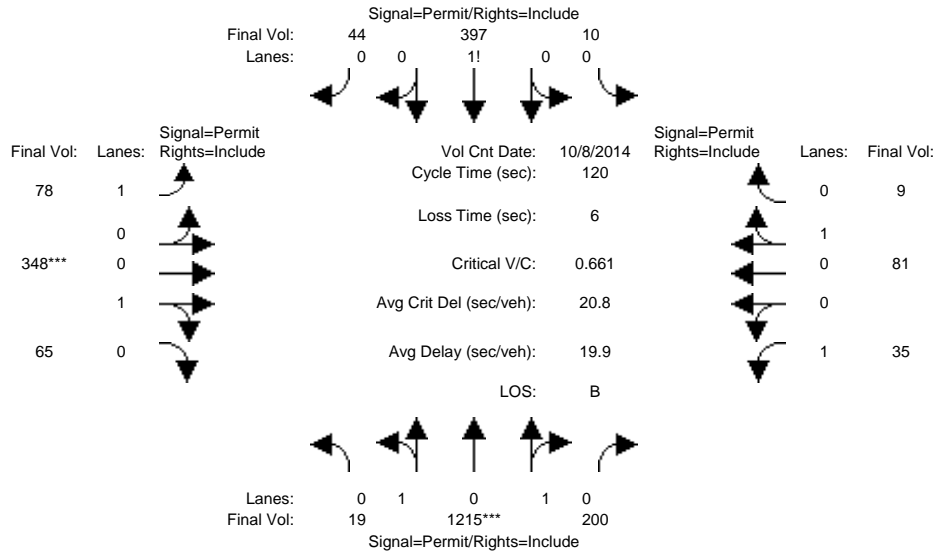

Approach:	North Bound			South Bound			East Bound			West Bound		
	L	T	R	L	T	R	L	T	R	L	T	R
Min. Green:	10	10	10	10	10	10	10	10	10	10	10	10
Y+R:	4.0	4.0	4.0	4.0	4.0	4.0	4.0	4.0	4.0	4.0	4.0	4.0
Volume Module: >> Count Date: 8 Oct 2014 <<												
Base Vol:	19	1215	200	10	397	44	78	348	65	35	81	9
Growth Adj:	1.00	1.00	1.00	1.00	1.00	1.00	1.00	1.00	1.00	1.00	1.00	1.00
Initial Bse:	19	1215	200	10	397	44	78	348	65	35	81	9
Added Vol:	0	0	0	0	0	0	0	0	0	0	0	0
PasserByVol:	0	0	0	0	0	0	0	0	0	0	0	0
Initial Fut:	19	1215	200	10	397	44	78	348	65	35	81	9
User Adj:	1.00	1.00	1.00	1.00	1.00	1.00	1.00	1.00	1.00	1.00	1.00	1.00
PHF Adj:	1.00	1.00	1.00	1.00	1.00	1.00	1.00	1.00	1.00	1.00	1.00	1.00
PHF Volume:	19	1215	200	10	397	44	78	348	65	35	81	9
Reduct Vol:	0	0	0	0	0	0	0	0	0	0	0	0
Reduced Vol:	19	1215	200	10	397	44	78	348	65	35	81	9
PCE Adj:	1.00	1.00	1.00	1.00	1.00	1.00	1.00	1.00	1.00	1.00	1.00	1.00
MLF Adj:	1.00	1.00	1.00	1.00	1.00	1.00	1.00	1.00	1.00	1.00	1.00	1.00
FinalVolume:	19	1215	200	10	397	44	78	348	65	35	81	9
Saturation Flow Module:												
Sat/Lane:	1900	1900	1900	1900	1900	1900	1900	1900	1900	1900	1900	1900
Adjustment:	0.95	0.95	0.95	0.92	0.92	0.92	0.92	0.95	0.95	0.92	0.95	0.95
Lanes:	0.03	1.69	0.28	0.02	0.88	0.10	1.00	0.84	0.16	1.00	0.90	0.10
Final Sat.:	48	3050	502	39	1540	171	1750	1517	283	1750	1620	180
Capacity Analysis Module:												
Vol/Sat:	0.40	0.40	0.40	0.26	0.26	0.26	0.04	0.23	0.23	0.02	0.05	0.05
Crit Moves:	****						****					
Green Time:	72.3	72.3	72.3	72.3	72.3	72.3	41.7	41.7	41.7	41.7	41.7	41.7
Volume/Cap:	0.66	0.66	0.66	0.43	0.43	0.43	0.13	0.66	0.66	0.06	0.14	0.14
Delay/Veh:	16.5	16.5	16.5	13.0	13.0	13.0	26.9	35.8	35.8	26.1	27.0	27.0
User DelAdj:	1.00	1.00	1.00	1.00	1.00	1.00	1.00	1.00	1.00	1.00	1.00	1.00
AdjDel/Veh:	16.5	16.5	16.5	13.0	13.0	13.0	26.9	35.8	35.8	26.1	27.0	27.0
LOS by Move:	B	B	B	B	B	B	C	D	D	C	C	C
HCM2k95thQ:	30	30	30	17	17	17	4	24	24	2	5	5

Note: Queue reported is the number of cars per lane.

BART Phase II Extension Project

Level Of Service Computation Report
 2000 HCM Operations (Future Volume Alternative)
 PM - 2035 SC West Project Conditions

Intersection #107: Benton/Lafayette

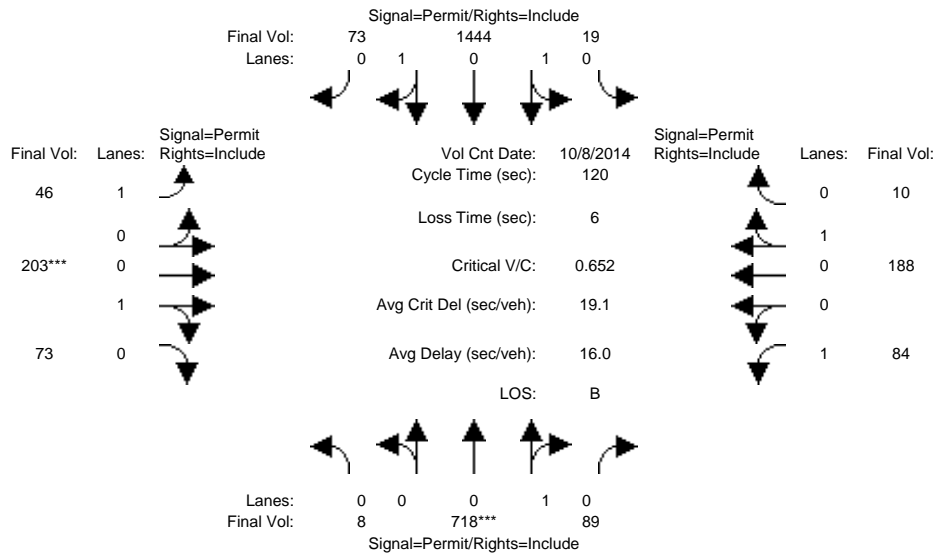

Approach:	North Bound			South Bound			East Bound			West Bound		
	L	T	R	L	T	R	L	T	R	L	T	R
Min. Green:	10	10	10	10	10	10	10	10	10	10	10	10
Y+R:	4.0	4.0	4.0	4.0	4.0	4.0	4.0	4.0	4.0	4.0	4.0	4.0
Volume Module: >> Count Date: 8 Oct 2014 <<												
Base Vol:	8	718	89	19	1444	73	46	203	73	84	188	10
Growth Adj:	1.00	1.00	1.00	1.00	1.00	1.00	1.00	1.00	1.00	1.00	1.00	1.00
Initial Bse:	8	718	89	19	1444	73	46	203	73	84	188	10
Added Vol:	0	0	0	0	0	0	0	0	0	0	0	0
PasserByVol:	0	0	0	0	0	0	0	0	0	0	0	0
Initial Fut:	8	718	89	19	1444	73	46	203	73	84	188	10
User Adj:	1.00	1.00	1.00	1.00	1.00	1.00	1.00	1.00	1.00	1.00	1.00	1.00
PHF Adj:	1.00	1.00	1.00	1.00	1.00	1.00	1.00	1.00	1.00	1.00	1.00	1.00
PHF Volume:	8	718	89	19	1444	73	46	203	73	84	188	10
Reduct Vol:	0	0	0	0	0	0	0	0	0	0	0	0
Reduced Vol:	8	718	89	19	1444	73	46	203	73	84	188	10
PCE Adj:	1.00	1.00	1.00	1.00	1.00	1.00	1.00	1.00	1.00	1.00	1.00	1.00
MLF Adj:	1.00	1.00	1.00	1.00	1.00	1.00	1.00	1.00	1.00	1.00	1.00	1.00
FinalVolume:	8	718	89	19	1444	73	46	203	73	84	188	10
Saturation Flow Module:												
Sat/Lane:	1900	1900	1900	1900	1900	1900	1900	1900	1900	1900	1900	1900
Adjustment:	0.92	0.92	0.92	0.95	0.95	0.95	0.92	0.95	0.95	0.92	0.95	0.95
Lanes:	0.01	0.88	0.11	0.02	1.88	0.10	1.00	0.74	0.26	1.00	0.95	0.05
Final Sat.:	17	1542	191	45	3384	171	1750	1324	476	1750	1709	91
Capacity Analysis Module:												
Vol/Sat:	0.47	0.47	0.47	0.43	0.43	0.43	0.03	0.15	0.15	0.05	0.11	0.11
Crit Moves:	****									****		
Green Time:	85.8	85.8	85.8	85.8	85.8	85.8	28.2	28.2	28.2	28.2	28.2	28.2
Volume/Cap:	0.65	0.65	0.65	0.60	0.60	0.60	0.11	0.65	0.65	0.20	0.47	0.47
Delay/Veh:	10.4	10.4	10.4	8.9	8.9	8.9	36.2	45.0	45.0	37.1	40.2	40.2
User DelAdj:	1.00	1.00	1.00	1.00	1.00	1.00	1.00	1.00	1.00	1.00	1.00	1.00
AdjDel/Veh:	10.4	10.4	10.4	8.9	8.9	8.9	36.2	45.0	45.0	37.1	40.2	40.2
LOS by Move:	B	B	B	A	A	A	D	D	D	D	D	D
HCM2k95thQ:	29	29	29	24	24	24	3	18	18	5	13	13

Note: Queue reported is the number of cars per lane.

BART Phase II Extension Project

Level Of Service Computation Report
2000 HCM Operations (Future Volume Alternative)
AM - 2035 SC West Project Conditions

Intersection #175: Reed/De La Cruz

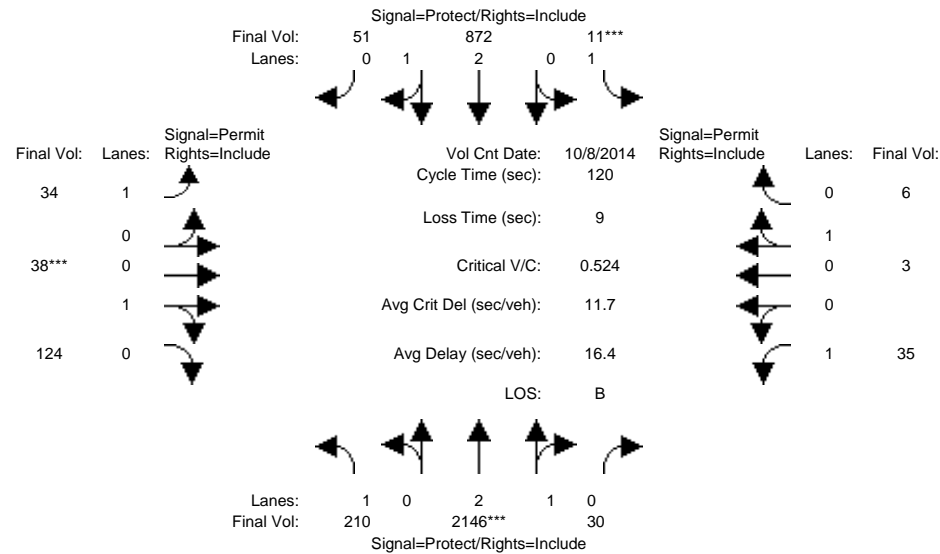

Approach:	North Bound			South Bound			East Bound			West Bound		
Movement:	L	T	R	L	T	R	L	T	R	L	T	R
Min. Green:	7	10	10	7	10	10	10	10	10	10	10	10
Y+R:	4.0	4.0	4.0	4.0	4.0	4.0	4.0	4.0	4.0	4.0	4.0	4.0
Volume Module: >> Count Date: 8 Oct 2014 <<												
Base Vol:	210	2146	30	11	872	51	34	38	124	35	3	6
Growth Adj:	1.00	1.00	1.00	1.00	1.00	1.00	1.00	1.00	1.00	1.00	1.00	1.00
Initial Bse:	210	2146	30	11	872	51	34	38	124	35	3	6
Added Vol:	0	0	0	0	0	0	0	0	0	0	0	0
PasserByVol:	0	0	0	0	0	0	0	0	0	0	0	0
Initial Fut:	210	2146	30	11	872	51	34	38	124	35	3	6
User Adj:	1.00	1.00	1.00	1.00	1.00	1.00	1.00	1.00	1.00	1.00	1.00	1.00
PHF Adj:	1.00	1.00	1.00	1.00	1.00	1.00	1.00	1.00	1.00	1.00	1.00	1.00
PHF Volume:	210	2146	30	11	872	51	34	38	124	35	3	6
Reduct Vol:	0	0	0	0	0	0	0	0	0	0	0	0
Reduced Vol:	210	2146	30	11	872	51	34	38	124	35	3	6
PCE Adj:	1.00	1.00	1.00	1.00	1.00	1.00	1.00	1.00	1.00	1.00	1.00	1.00
MLF Adj:	1.00	1.00	1.00	1.00	1.00	1.00	1.00	1.00	1.00	1.00	1.00	1.00
FinalVolume:	210	2146	30	11	872	51	34	38	124	35	3	6
Saturation Flow Module:												
Sat/Lane:	1900	1900	1900	1900	1900	1900	1900	1900	1900	1900	1900	1900
Adjustment:	0.92	0.98	0.95	0.92	0.98	0.95	0.92	0.95	0.95	0.92	0.95	0.95
Lanes:	1.00	2.96	0.04	1.00	2.83	0.17	1.00	0.23	0.77	1.00	0.33	0.67
Final Sat.:	1750	5523	77	1750	5290	309	1750	422	1378	1750	600	1200
Capacity Analysis Module:												
Vol/Sat:	0.12	0.39	0.39	0.01	0.16	0.16	0.02	0.09	0.09	0.02	0.01	0.01
Crit Moves:	****			****			****					
Green Time:	38.5	84.4	84.4	7.0	52.9	52.9	19.6	19.6	19.6	19.6	19.6	19.6
Volume/Cap:	0.37	0.55	0.55	0.11	0.37	0.37	0.12	0.55	0.55	0.12	0.03	0.03
Delay/Veh:	31.9	8.8	8.8	54.0	22.5	22.5	43.1	48.5	48.5	43.1	42.3	42.3
User DelAdj:	1.00	1.00	1.00	1.00	1.00	1.00	1.00	1.00	1.00	1.00	1.00	1.00
AdjDel/Veh:	31.9	8.8	8.8	54.0	22.5	22.5	43.1	48.5	48.5	43.1	42.3	42.3
LOS by Move:	C	A	A	D	C	C	D	D	D	D	D	D
HCM2k95thQ:	12	24	24	1	14	14	2	11	11	3	1	1

Note: Queue reported is the number of cars per lane.

BART Phase II Extension Project

Level Of Service Computation Report
2000 HCM Operations (Future Volume Alternative)
PM - 2035 SC West Project Conditions

Intersection #175: Reed/De La Cruz

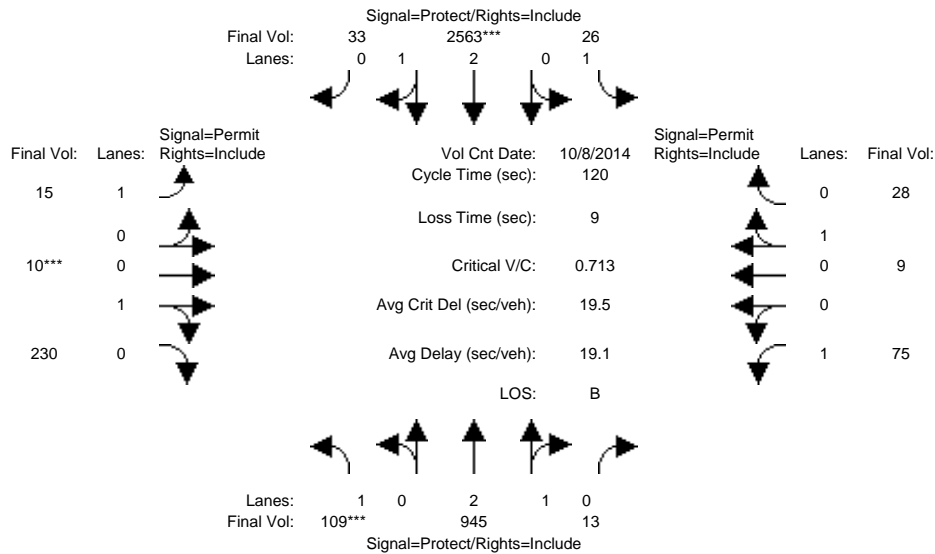

Approach:	North Bound			South Bound			East Bound			West Bound		
	L	T	R	L	T	R	L	T	R	L	T	R
Min. Green:	7	10	10	7	10	10	10	10	10	10	10	10
Y+R:	4.0	4.0	4.0	4.0	4.0	4.0	4.0	4.0	4.0	4.0	4.0	4.0
Volume Module: >> Count Date: 8 Oct 2014 <<												
Base Vol:	109	945	13	26	2563	33	15	10	230	75	9	28
Growth Adj:	1.00	1.00	1.00	1.00	1.00	1.00	1.00	1.00	1.00	1.00	1.00	1.00
Initial Bse:	109	945	13	26	2563	33	15	10	230	75	9	28
Added Vol:	0	0	0	0	0	0	0	0	0	0	0	0
PasserByVol:	0	0	0	0	0	0	0	0	0	0	0	0
Initial Fut:	109	945	13	26	2563	33	15	10	230	75	9	28
User Adj:	1.00	1.00	1.00	1.00	1.00	1.00	1.00	1.00	1.00	1.00	1.00	1.00
PHF Adj:	1.00	1.00	1.00	1.00	1.00	1.00	1.00	1.00	1.00	1.00	1.00	1.00
PHF Volume:	109	945	13	26	2563	33	15	10	230	75	9	28
Reduct Vol:	0	0	0	0	0	0	0	0	0	0	0	0
Reduced Vol:	109	945	13	26	2563	33	15	10	230	75	9	28
PCE Adj:	1.00	1.00	1.00	1.00	1.00	1.00	1.00	1.00	1.00	1.00	1.00	1.00
MLF Adj:	1.00	1.00	1.00	1.00	1.00	1.00	1.00	1.00	1.00	1.00	1.00	1.00
FinalVolume:	109	945	13	26	2563	33	15	10	230	75	9	28
Saturation Flow Module:												
Sat/Lane:	1900	1900	1900	1900	1900	1900	1900	1900	1900	1900	1900	1900
Adjustment:	0.92	0.98	0.95	0.92	0.98	0.95	0.92	0.95	0.95	0.92	0.95	0.95
Lanes:	1.00	2.96	0.04	1.00	2.96	0.04	1.00	0.04	0.96	1.00	0.24	0.76
Final Sat.:	1750	5524	76	1750	5529	71	1750	75	1725	1750	438	1362
Capacity Analysis Module:												
Vol/Sat:	0.06	0.17	0.17	0.01	0.46	0.46	0.01	0.13	0.13	0.04	0.02	0.02
Crit Moves:	****			****			****					
Green Time:	10.5	66.0	66.0	22.5	78.1	78.1	22.5	22.5	22.5	22.5	22.5	22.5
Volume/Cap:	0.71	0.31	0.31	0.08	0.71	0.71	0.05	0.71	0.71	0.23	0.11	0.11
Delay/Veh:	67.9	14.7	14.7	40.3	14.3	14.3	40.0	52.8	52.8	41.8	40.6	40.6
User DelAdj:	1.00	1.00	1.00	1.00	1.00	1.00	1.00	1.00	1.00	1.00	1.00	1.00
AdjDel/Veh:	67.9	14.7	14.7	40.3	14.3	14.3	40.0	52.8	52.8	41.8	40.6	40.6
LOS by Move:	E	B	B	D	B	B	D	D	D	D	D	D
HCM2k95thQ:	11	12	12	2	36	36	1	17	17	5	2	2

Note: Queue reported is the number of cars per lane.

BART Phase II Extension Project

Level Of Service Computation Report
 2000 HCM Unsignalized (Future Volume Alternative)
 AM - 2035 SC West Project Conditions

Intersection #1008: Lafayette/Harrison

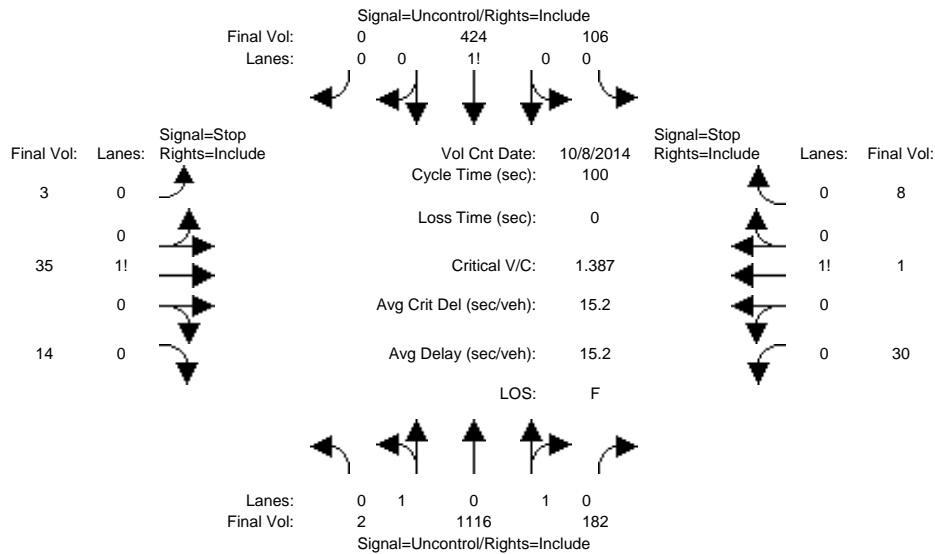

Approach:	North Bound			South Bound			East Bound			West Bound			
Movement:	L	T	R	L	T	R	L	T	R	L	T	R	
Volume Module: >> Count Date: 8 Oct 2014 <<													
Base Vol:	2	1116	182	106	424	0	3	35	14	30	1	8	
Growth Adj:	1.00	1.00	1.00	1.00	1.00	1.00	1.00	1.00	1.00	1.00	1.00	1.00	
Initial Bse:	2	1116	182	106	424	0	3	35	14	30	1	8	
Added Vol:	0	0	0	0	0	0	0	0	0	0	0	0	
PasserByVol:	0	0	0	0	0	0	0	0	0	0	0	0	
Initial Fut:	2	1116	182	106	424	0	3	35	14	30	1	8	
User Adj:	1.00	1.00	1.00	1.00	1.00	1.00	1.00	1.00	1.00	1.00	1.00	1.00	
PHF Adj:	1.00	1.00	1.00	1.00	1.00	1.00	1.00	1.00	1.00	1.00	1.00	1.00	
PHF Volume:	2	1116	182	106	424	0	3	35	14	30	1	8	
Reduct Vol:	0	0	0	0	0	0	0	0	0	0	0	0	
FinalVolume:	2	1116	182	106	424	0	3	35	14	30	1	8	
Critical Gap Module:													
Critical Gp:	4.1	xxxx	xxxxxx	4.1	xxxx	xxxxxx	7.1	6.5	6.2	7.1	6.5	6.2	
FollowUpTim:	2.2	xxxx	xxxxxx	2.2	xxxx	xxxxxx	3.5	4.0	3.3	3.5	4.0	3.3	
Capacity Module:													
Cnflct Vol:	424	xxxx	xxxxxx	1298	xxxx	xxxxxx	1199	1938	424	1872	1847	649	
Potent Cap.:	1146	xxxx	xxxxxx	540	xxxx	xxxxxx	164	66	634	56	75	473	
Move Cap.:	1146	xxxx	xxxxxx	540	xxxx	xxxxxx	133	52	634	22	60	473	
Volume/Cap:	0.00	xxxx	xxxx	0.20	xxxx	xxxx	0.02	0.67	0.02	1.39	0.02	0.02	
Level Of Service Module:													
2Way95thQ:	0.0	xxxx	xxxxxx	0.7	xxxx	xxxxxx	xxxx	xxxx	xxxxxx	xxxx	xxxx	xxxxxx	
Control Del:	8.1	xxxx	xxxxxx	13.3	xxxx	xxxxxx	xxxxxx	xxxx	xxxxxx	xxxxxx	xxxx	xxxxxx	
LOS by Move:	A	*	*	B	*	*	*	*	*	*	*	*	
Movement:	LT - LTR - RT	LT - LTR - RT			LT - LTR - RT			LT - LTR - RT			LT - LTR - RT		
Shared Cap.:	xxxx	xxxx	xxxxxx	xxxx	xxxx	xxxxxx	xxxx	73	xxxxxx	xxxx	27	xxxxxx	
SharedQueue:	0.0	xxxx	xxxxxx	0.7	xxxx	xxxxxx	xxxxxx	3.3	xxxxxx	xxxxxx	4.6	xxxxxx	
Shrd ConDel:	8.1	xxxx	xxxxxx	13.3	xxxx	xxxxxx	xxxxxx	131	xxxxxx	xxxxxx	535	xxxxxx	
Shared LOS:	A	*	*	B	*	*	*	F	*	*	F	*	
ApproachDel:	xxxxxxx	xxxxxxx			131.3			535.3					
ApproachLOS:	*	*			F			F					

Note: Queue reported is the number of cars per lane.

BART Phase II Extension Project

Level Of Service Computation Report
 2000 HCM Unsignalized (Future Volume Alternative)
 PM - 2035 SC West Project Conditions

Intersection #1008: Lafayette/Harrison

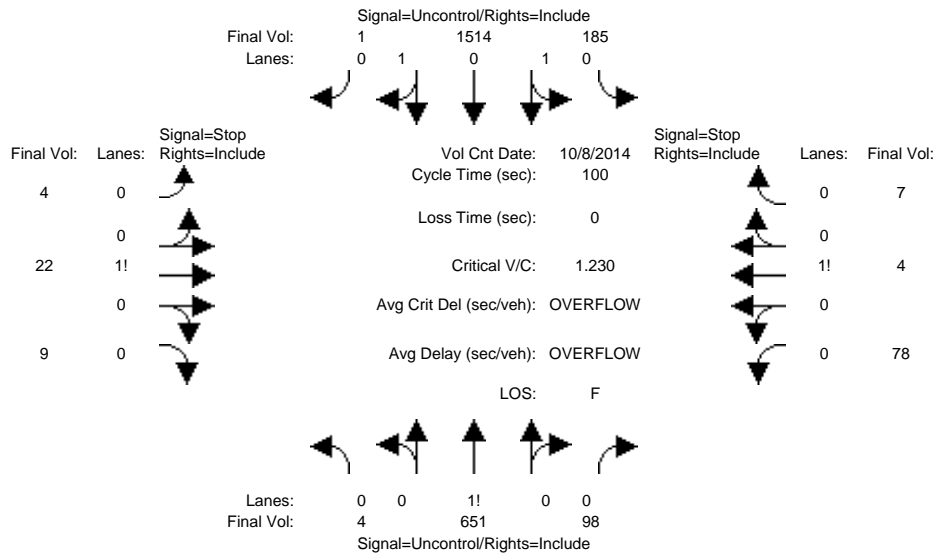

Approach:	North Bound			South Bound			East Bound			West Bound		
Movement:	L	T	R	L	T	R	L	T	R	L	T	R
Volume Module: >> Count Date: 8 Oct 2014 <<												
Base Vol:	4	651	98	185	1514	1	4	22	9	78	4	7
Growth Adj:	1.00	1.00	1.00	1.00	1.00	1.00	1.00	1.00	1.00	1.00	1.00	1.00
Initial Bse:	4	651	98	185	1514	1	4	22	9	78	4	7
Added Vol:	0	0	0	0	0	0	0	0	0	0	0	0
PasserByVol:	0	0	0	0	0	0	0	0	0	0	0	0
Initial Fut:	4	651	98	185	1514	1	4	22	9	78	4	7
User Adj:	1.00	1.00	1.00	1.00	1.00	1.00	1.00	1.00	1.00	1.00	1.00	1.00
PHF Adj:	1.00	1.00	1.00	1.00	1.00	1.00	1.00	1.00	1.00	1.00	1.00	1.00
PHF Volume:	4	651	98	185	1514	1	4	22	9	78	4	7
Reduct Vol:	0	0	0	0	0	0	0	0	0	0	0	0
FinalVolume:	4	651	98	185	1514	1	4	22	9	78	4	7
Critical Gap Module:												
Critical Gp:	4.1	xxxx	xxxxxx	4.1	xxxx	xxxxxx	7.1	6.5	6.2	7.1	6.5	6.2
FollowUpTim:	2.2	xxxx	xxxxxx	2.2	xxxx	xxxxxx	3.5	4.0	3.3	3.5	4.0	3.3
Capacity Module:												
Cnflct Vol:	1515	xxxx	xxxxxx	749	xxxx	xxxxxx	2598	2642	758	1846	2593	700
Potent Cap.:	447	xxxx	xxxxxx	869	xxxx	xxxxxx	17	24	410	58	25	443
Move Cap.:	447	xxxx	xxxxxx	869	xxxx	xxxxxx	11	18	410	0	19	443
Volume/Cap:	0.01	xxxx	xxxx	0.21	xxxx	xxxx	0.35	1.23	0.02	xxxx	0.21	0.02
Level Of Service Module:												
2Way95thQ:	0.0	xxxx	xxxxxx	0.8	xxxx	xxxxxx	xxxx	xxxx	xxxxxx	xxxx	xxxx	xxxxxx
Control Del:	13.1	xxxx	xxxxxx	10.3	xxxx	xxxxxx	xxxxxx	xxxx	xxxxxx	xxxxxx	xxxx	xxxxxx
LOS by Move:	B	*	*	B	*	*	*	*	*	*	*	*
Movement:	LT	LTR	RT	LT	LTR	RT	LT	LTR	RT	LT	LTR	RT
Shared Cap.:	xxxx	xxxx	xxxxxx	xxxx	xxxx	xxxxxx	xxxx	22	xxxxxx	xxxx	0	xxxxxx
SharedQueue:	xxxxxx	xxxx	xxxxxx	0.8	xxxx	xxxxxx	xxxxxx	4.5	xxxxxx	xxxxxx	xxxx	xxxxxx
Shrd ConDel:	xxxxxx	xxxx	xxxxxx	10.3	xxxx	xxxxxx	xxxxxx	677	xxxxxx	xxxxxx	xxxx	xxxxxx
Shared LOS:	*	*	*	B	*	*	*	F	*	*	*	*
ApproachDel:	xxxxxx			xxxxxx			676.5			xxxxxx		
ApproachLOS:	*			*			F			F		

Note: Queue reported is the number of cars per lane.

BART Phase II Extension Project

Level Of Service Computation Report
 2000 HCM Operations (Future Volume Alternative)
 AM - 2035 SC West Project Conditions

Intersection #1012: El Camino Real/Railroad Ave

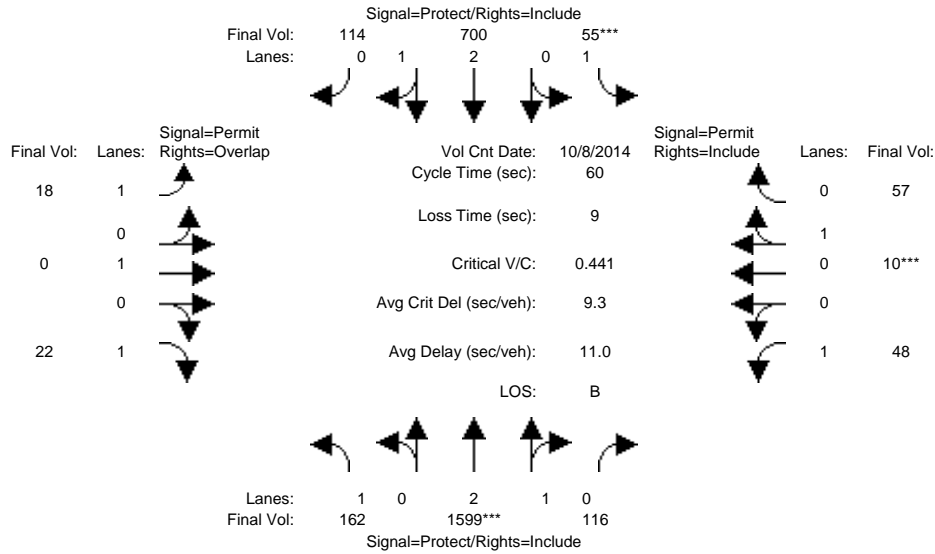

Approach:	North Bound			South Bound			East Bound			West Bound		
	L	T	R	L	T	R	L	T	R	L	T	R
Min. Green:	7	10	10	7	10	10	10	10	10	10	10	10
Y+R:	4.0	4.0	4.0	4.0	4.0	4.0	4.0	4.0	4.0	4.0	4.0	4.0
Volume Module: >> Count Date: 8 Oct 2014 <<												
Base Vol:	162	1599	116	55	700	114	18	0	22	48	10	57
Growth Adj:	1.00	1.00	1.00	1.00	1.00	1.00	1.00	1.00	1.00	1.00	1.00	1.00
Initial Bse:	162	1599	116	55	700	114	18	0	22	48	10	57
Added Vol:	0	0	0	0	0	0	0	0	0	0	0	0
PasserByVol:	0	0	0	0	0	0	0	0	0	0	0	0
Initial Fut:	162	1599	116	55	700	114	18	0	22	48	10	57
User Adj:	1.00	1.00	1.00	1.00	1.00	1.00	1.00	1.00	1.00	1.00	1.00	1.00
PHF Adj:	1.00	1.00	1.00	1.00	1.00	1.00	1.00	1.00	1.00	1.00	1.00	1.00
PHF Volume:	162	1599	116	55	700	114	18	0	22	48	10	57
Reduct Vol:	0	0	0	0	0	0	0	0	0	0	0	0
Reduced Vol:	162	1599	116	55	700	114	18	0	22	48	10	57
PCE Adj:	1.00	1.00	1.00	1.00	1.00	1.00	1.00	1.00	1.00	1.00	1.00	1.00
MLF Adj:	1.00	1.00	1.00	1.00	1.00	1.00	1.00	1.00	1.00	1.00	1.00	1.00
Final Volume:	162	1599	116	55	700	114	18	0	22	48	10	57
Saturation Flow Module:												
Sat/Lane:	1900	1900	1900	1900	1900	1900	1900	1900	1900	1900	1900	1900
Adjustment:	0.92	0.99	0.95	0.92	0.99	0.95	0.92	1.00	0.92	0.92	0.95	0.95
Lanes:	1.00	2.79	0.21	1.00	2.56	0.44	1.00	1.00	1.00	1.00	0.15	0.85
Final Sat.:	1750	5221	379	1750	4815	784	1750	1900	1750	1750	269	1531
Capacity Analysis Module:												
Vol/Sat:	0.09	0.31	0.31	0.03	0.15	0.15	0.01	0.00	0.01	0.03	0.04	0.04
Crit Moves:	****			****						****		
Green Time:	16.9	34.0	34.0	7.0	24.1	24.1	10.0	0.0	26.9	10.0	10.0	10.0
Volume/Cap:	0.33	0.54	0.54	0.27	0.36	0.36	0.06	0.00	0.03	0.16	0.22	0.22
Delay/Veh:	17.5	8.3	8.3	24.9	12.7	12.7	21.1	0.0	9.3	21.7	22.0	22.0
User DelAdj:	1.00	1.00	1.00	1.00	1.00	1.00	1.00	1.00	1.00	1.00	1.00	1.00
AdjDel/Veh:	17.5	8.3	8.3	24.9	12.7	12.7	21.1	0.0	9.3	21.7	22.0	22.0
LOS by Move:	B	A	A	C	B	B	C	A	A	C	C	C
HCM2k95thQ:	6	14	14	2	7	7	1	0	1	2	3	3

Note: Queue reported is the number of cars per lane.

BART Phase II Extension Project

Level Of Service Computation Report
 2000 HCM Operations (Future Volume Alternative)
 PM - 2035 SC West Project Conditions

Intersection #1012: El Camino Real/Railroad Ave

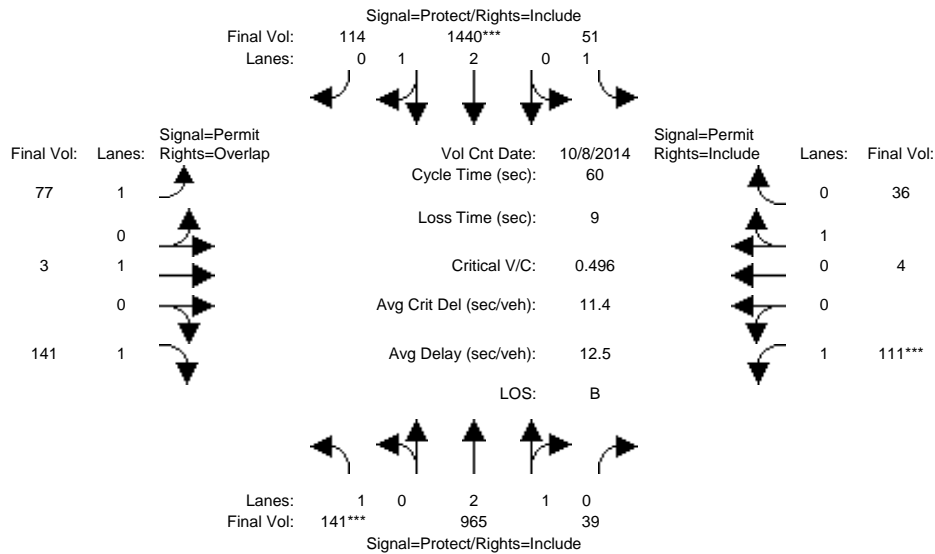

Approach:	North Bound			South Bound			East Bound			West Bound		
Movement:	L	T	R	L	T	R	L	T	R	L	T	R
Min. Green:	7	10	10	7	10	10	10	10	10	10	10	10
Y+R:	4.0	4.0	4.0	4.0	4.0	4.0	4.0	4.0	4.0	4.0	4.0	4.0
Volume Module: >> Count Date: 8 Oct 2014 <<												
Base Vol:	141	965	39	51	1440	114	77	3	141	111	4	36
Growth Adj:	1.00	1.00	1.00	1.00	1.00	1.00	1.00	1.00	1.00	1.00	1.00	1.00
Initial Bse:	141	965	39	51	1440	114	77	3	141	111	4	36
Added Vol:	0	0	0	0	0	0	0	0	0	0	0	0
PasserByVol:	0	0	0	0	0	0	0	0	0	0	0	0
Initial Fut:	141	965	39	51	1440	114	77	3	141	111	4	36
User Adj:	1.00	1.00	1.00	1.00	1.00	1.00	1.00	1.00	1.00	1.00	1.00	1.00
PHF Adj:	1.00	1.00	1.00	1.00	1.00	1.00	1.00	1.00	1.00	1.00	1.00	1.00
PHF Volume:	141	965	39	51	1440	114	77	3	141	111	4	36
Reduct Vol:	0	0	0	0	0	0	0	0	0	0	0	0
Reduced Vol:	141	965	39	51	1440	114	77	3	141	111	4	36
PCE Adj:	1.00	1.00	1.00	1.00	1.00	1.00	1.00	1.00	1.00	1.00	1.00	1.00
MLF Adj:	1.00	1.00	1.00	1.00	1.00	1.00	1.00	1.00	1.00	1.00	1.00	1.00
FinalVolume:	141	965	39	51	1440	114	77	3	141	111	4	36
Saturation Flow Module:												
Sat/Lane:	1900	1900	1900	1900	1900	1900	1900	1900	1900	1900	1900	1900
Adjustment:	0.92	0.98	0.95	0.92	0.99	0.95	0.92	1.00	0.92	0.92	0.95	0.95
Lanes:	1.00	2.88	0.12	1.00	2.77	0.23	1.00	1.00	1.00	1.00	0.10	0.90
Final Sat.:	1750	5382	218	1750	5189	411	1750	1900	1750	1750	180	1620
Capacity Analysis Module:												
Vol/Sat:	0.08	0.18	0.18	0.03	0.28	0.28	0.04	0.00	0.08	0.06	0.02	0.02
Crit Moves:	****				****					****		
Green Time:	9.2	24.8	24.8	16.2	31.8	31.8	10.0	10.0	19.2	10.0	10.0	10.0
Volume/Cap:	0.52	0.43	0.43	0.11	0.52	0.52	0.26	0.01	0.25	0.38	0.13	0.13
Delay/Veh:	25.3	12.7	12.7	16.6	9.4	9.4	22.3	20.9	15.3	23.1	21.5	21.5
User DelAdj:	1.00	1.00	1.00	1.00	1.00	1.00	1.00	1.00	1.00	1.00	1.00	1.00
AdjDel/Veh:	25.3	12.7	12.7	16.6	9.4	9.4	22.3	20.9	15.3	23.1	21.5	21.5
LOS by Move:	C	B	B	B	A	A	C	C	B	C	C	C
HCM2k95thQ:	7	9	9	2	12	12	3	0	5	5	2	2

Note: Queue reported is the number of cars per lane.

BART Phase II Extension Project

Level Of Service Computation Report
 2000 HCM Operations (Future Volume Alternative)
 AM - 2035 SC West Project Conditions

Intersection #1202: LAFAYETTE/EL CAMINO REAL

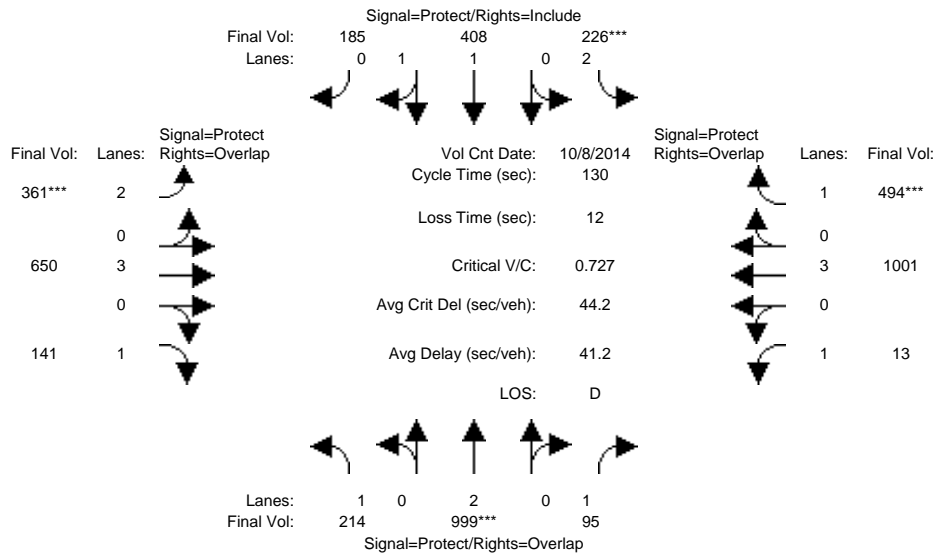

Approach:	North Bound			South Bound			East Bound			West Bound		
	L	T	R	L	T	R	L	T	R	L	T	R
Min. Green:	7	10	10	7	10	10	7	10	10	7	10	10
Y+R:	4.0	4.0	4.0	4.0	4.0	4.0	4.0	4.0	4.0	4.0	4.0	4.0

Volume Module:	>> Count Date: 8 Oct 2014 <<											
Base Vol:	214	999	95	226	408	185	361	650	141	13	1001	494
Growth Adj:	1.00	1.00	1.00	1.00	1.00	1.00	1.00	1.00	1.00	1.00	1.00	1.00
Initial Bse:	214	999	95	226	408	185	361	650	141	13	1001	494
Added Vol:	0	0	0	0	0	0	0	0	0	0	0	0
PasserByVol:	0	0	0	0	0	0	0	0	0	0	0	0
Initial Fut:	214	999	95	226	408	185	361	650	141	13	1001	494
User Adj:	1.00	1.00	1.00	1.00	1.00	1.00	1.00	1.00	1.00	1.00	1.00	1.00
PHF Adj:	1.00	1.00	1.00	1.00	1.00	1.00	1.00	1.00	1.00	1.00	1.00	1.00
PHF Volume:	214	999	95	226	408	185	361	650	141	13	1001	494
Reduct Vol:	0	0	0	0	0	0	0	0	0	0	0	0
Reduced Vol:	214	999	95	226	408	185	361	650	141	13	1001	494
PCE Adj:	1.00	1.00	1.00	1.00	1.00	1.00	1.00	1.00	1.00	1.00	1.00	1.00
MLF Adj:	1.00	1.00	1.00	1.00	1.00	1.00	1.00	1.00	1.00	1.00	1.00	1.00
FinalVolume:	214	999	95	226	408	185	361	650	141	13	1001	494

Saturation Flow Module:												
Sat/Lane:	1900	1900	1900	1900	1900	1900	1900	1900	1900	1900	1900	1900
Adjustment:	0.92	1.00	0.92	0.83	0.99	0.95	0.83	1.00	0.92	0.92	1.00	0.92
Lanes:	1.00	2.00	1.00	2.00	1.36	0.64	2.00	3.00	1.00	1.00	3.00	1.00
Final Sat.:	1750	3800	1750	3150	2545	1154	3150	5700	1750	1750	5700	1750

Capacity Analysis Module:												
Vol/Sat:	0.12	0.26	0.05	0.07	0.16	0.16	0.11	0.11	0.08	0.01	0.18	0.28
Crit Moves:	****	****	****	****	****	****	****	****	****	****	****	****
Green Time:	25.9	47.0	65.7	12.8	34.0	34.0	20.5	39.5	65.4	18.7	37.7	50.5
Volume/Cap:	0.61	0.73	0.11	0.73	0.61	0.61	0.73	0.38	0.16	0.05	0.61	0.73
Delay/Veh:	50.7	37.9	16.9	65.2	43.4	43.4	57.4	35.7	17.5	48.1	40.4	37.8
User DelAdj:	1.00	1.00	1.00	1.00	1.00	1.00	1.00	1.00	1.00	1.00	1.00	1.00
AdjDel/Veh:	50.7	37.9	16.9	65.2	43.4	43.4	57.4	35.7	17.5	48.1	40.4	37.8
LOS by Move:	D	D	B	E	D	D	E	D	B	D	D	D
HCM2k95thQ:	16	30	4	11	19	19	15	12	6	1	21	32

Note: Queue reported is the number of cars per lane.

BART Phase II Extension Project

Level Of Service Computation Report
 2000 HCM Operations (Future Volume Alternative)
 PM - 2035 SC West Project Conditions

Intersection #1202: LAFAYETTE/EL CAMINO REAL

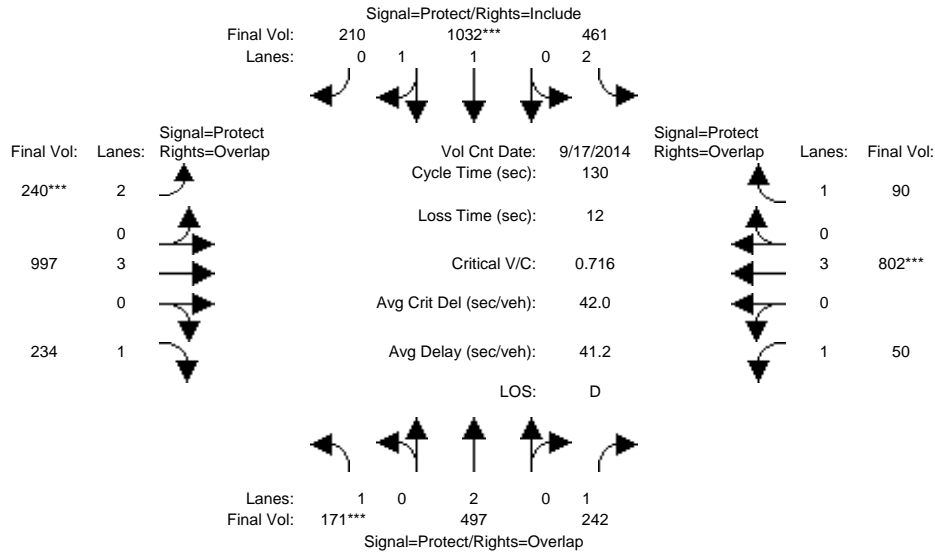

Approach:	North Bound			South Bound			East Bound			West Bound		
	L	T	R	L	T	R	L	T	R	L	T	R
Min. Green:	7	10	10	7	10	10	7	10	10	7	10	10
Y+R:	4.0	4.0	4.0	4.0	4.0	4.0	4.0	4.0	4.0	4.0	4.0	4.0

Volume Module:	>> Count Date: 17 Sep 2014 <<											
Base Vol:	171	497	242	461	1032	210	240	997	234	50	802	90
Growth Adj:	1.00	1.00	1.00	1.00	1.00	1.00	1.00	1.00	1.00	1.00	1.00	1.00
Initial Bse:	171	497	242	461	1032	210	240	997	234	50	802	90
Added Vol:	0	0	0	0	0	0	0	0	0	0	0	0
PasserByVol:	0	0	0	0	0	0	0	0	0	0	0	0
Initial Fut:	171	497	242	461	1032	210	240	997	234	50	802	90
User Adj:	1.00	1.00	1.00	1.00	1.00	1.00	1.00	1.00	1.00	1.00	1.00	1.00
PHF Adj:	1.00	1.00	1.00	1.00	1.00	1.00	1.00	1.00	1.00	1.00	1.00	1.00
PHF Volume:	171	497	242	461	1032	210	240	997	234	50	802	90
Reduct Vol:	0	0	0	0	0	0	0	0	0	0	0	0
Reduced Vol:	171	497	242	461	1032	210	240	997	234	50	802	90
PCE Adj:	1.00	1.00	1.00	1.00	1.00	1.00	1.00	1.00	1.00	1.00	1.00	1.00
MLF Adj:	1.00	1.00	1.00	1.00	1.00	1.00	1.00	1.00	1.00	1.00	1.00	1.00
FinalVolume:	171	497	242	461	1032	210	240	997	234	50	802	90

Saturation Flow Module:												
Sat/Lane:	1900	1900	1900	1900	1900	1900	1900	1900	1900	1900	1900	1900
Adjustment:	0.92	1.00	0.92	0.83	0.98	0.95	0.83	1.00	0.92	0.92	1.00	0.92
Lanes:	1.00	2.00	1.00	2.00	1.65	0.35	2.00	3.00	1.00	1.00	3.00	1.00
Final Sat.:	1750	3800	1750	3150	3074	626	3150	5700	1750	1750	5700	1750

Capacity Analysis Module:												
Vol/Sat:	0.10	0.13	0.14	0.15	0.34	0.34	0.08	0.17	0.13	0.03	0.14	0.05
Crit Moves:	****			****			****			****		
Green Time:	17.7	37.1	46.4	41.5	60.9	60.9	13.8	30.1	47.8	9.3	25.5	67.1
Volume/Cap:	0.72	0.46	0.39	0.46	0.72	0.72	0.72	0.76	0.36	0.40	0.72	0.10
Delay/Veh:	63.7	38.5	31.6	35.6	29.1	29.1	63.4	49.1	30.3	59.8	51.1	16.1
User DelAdj:	1.00	1.00	1.00	1.00	1.00	1.00	1.00	1.00	1.00	1.00	1.00	1.00
AdjDel/Veh:	63.7	38.5	31.6	35.6	29.1	29.1	63.4	49.1	30.3	59.8	51.1	16.1
LOS by Move:	E	D	C	D	C	C	E	D	C	E	D	B
HCM2k95thQ:	14	15	14	16	34	34	11	22	13	5	20	4

Note: Queue reported is the number of cars per lane.

BART Phase II Extension Project

Level Of Service Computation Report
 2000 HCM Operations (Future Volume Alternative)
 AM - 2035 SC West Project Conditions

Intersection #1204: MONROE/EL CAMINO REAL

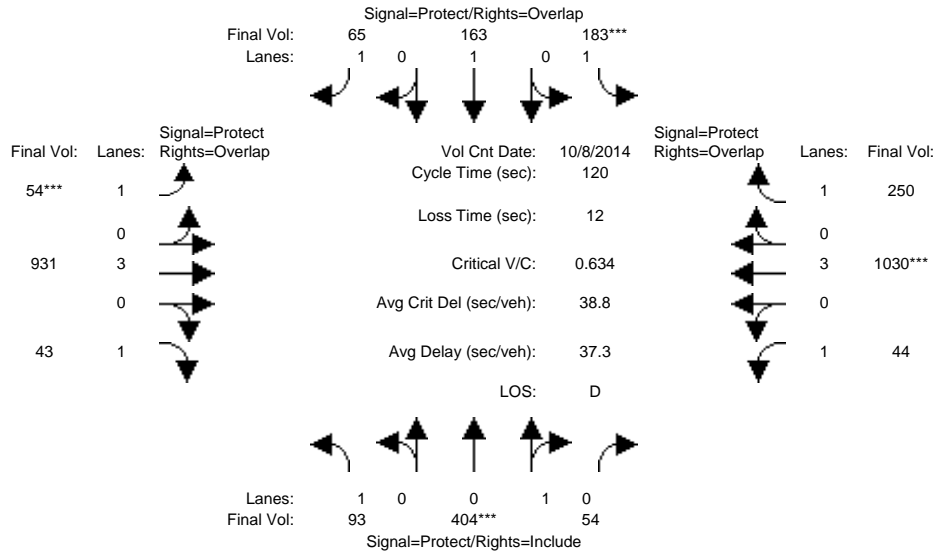

Approach:	North Bound			South Bound			East Bound			West Bound		
	L	T	R	L	T	R	L	T	R	L	T	R
Min. Green:	7	10	10	7	10	10	7	10	10	7	10	10
Y+R:	4.0	4.0	4.0	4.0	4.0	4.0	4.0	4.0	4.0	4.0	4.0	4.0
Volume Module: >> Count Date: 8 Oct 2014 <<												
Base Vol:	93	404	54	183	163	65	54	931	43	44	1030	250
Growth Adj:	1.00	1.00	1.00	1.00	1.00	1.00	1.00	1.00	1.00	1.00	1.00	1.00
Initial Bse:	93	404	54	183	163	65	54	931	43	44	1030	250
Added Vol:	0	0	0	0	0	0	0	0	0	0	0	0
PasserByVol:	0	0	0	0	0	0	0	0	0	0	0	0
Initial Fut:	93	404	54	183	163	65	54	931	43	44	1030	250
User Adj:	1.00	1.00	1.00	1.00	1.00	1.00	1.00	1.00	1.00	1.00	1.00	1.00
PHF Adj:	1.00	1.00	1.00	1.00	1.00	1.00	1.00	1.00	1.00	1.00	1.00	1.00
PHF Volume:	93	404	54	183	163	65	54	931	43	44	1030	250
Reduct Vol:	0	0	0	0	0	0	0	0	0	0	0	0
Reduced Vol:	93	404	54	183	163	65	54	931	43	44	1030	250
PCE Adj:	1.00	1.00	1.00	1.00	1.00	1.00	1.00	1.00	1.00	1.00	1.00	1.00
MLF Adj:	1.00	1.00	1.00	1.00	1.00	1.00	1.00	1.00	1.00	1.00	1.00	1.00
FinalVolume:	93	404	54	183	163	65	54	931	43	44	1030	250
Saturation Flow Module:												
Sat/Lane:	1900	1900	1900	1900	1900	1900	1900	1900	1900	1900	1900	1900
Adjustment:	0.92	0.95	0.95	0.92	1.00	0.92	0.92	1.00	0.92	0.92	1.00	0.92
Lanes:	1.00	0.88	0.12	1.00	1.00	1.00	1.00	3.00	1.00	1.00	3.00	1.00
Final Sat.:	1750	1588	212	1750	1900	1750	1750	5700	1750	1750	5700	1750
Capacity Analysis Module:												
Vol/Sat:	0.05	0.25	0.25	0.10	0.09	0.04	0.03	0.16	0.02	0.03	0.18	0.14
Crit Moves:	****			****			****			****		
Green Time:	27.2	47.6	47.6	19.6	40.0	47.0	7.0	30.1	57.3	10.7	33.8	53.4
Volume/Cap:	0.23	0.64	0.64	0.64	0.26	0.09	0.53	0.65	0.05	0.28	0.64	0.32
Delay/Veh:	38.2	31.3	31.3	51.8	29.4	23.1	60.0	41.4	16.8	52.0	38.7	21.8
User DelAdj:	1.00	1.00	1.00	1.00	1.00	1.00	1.00	1.00	1.00	1.00	1.00	1.00
AdjDel/Veh:	38.2	31.3	31.3	51.8	29.4	23.1	60.0	41.4	16.8	52.0	38.7	21.8
LOS by Move:	D	C	C	D	C	C	E	D	B	D	D	C
HCM2k95thQ:	6	26	26	13	8	3	4	19	2	3	20	12

Note: Queue reported is the number of cars per lane.

BART Phase II Extension Project

Level Of Service Computation Report
 2000 HCM Operations (Future Volume Alternative)
 PM - 2035 SC West Project Conditions

Intersection #1204: MONROE/EL CAMINO REAL

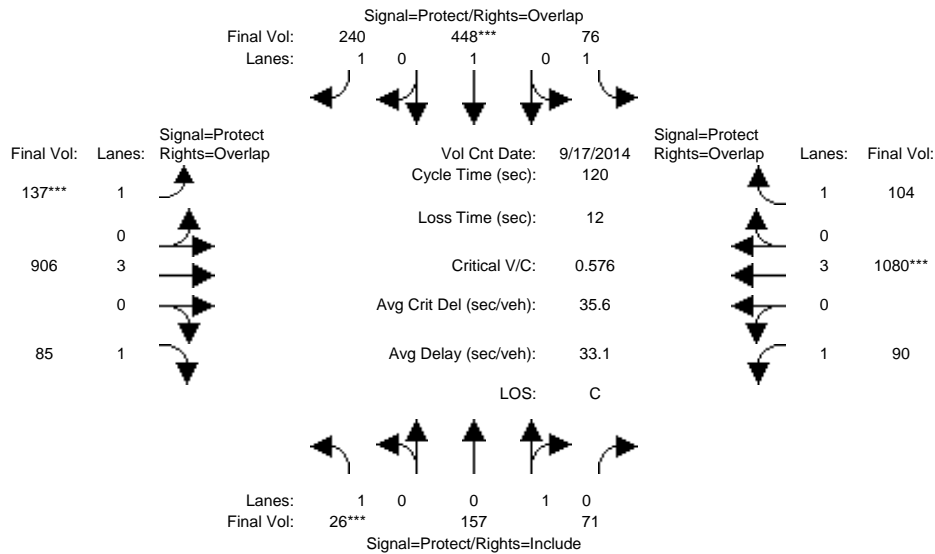

Approach:	North Bound			South Bound			East Bound			West Bound		
	L	T	R	L	T	R	L	T	R	L	T	R
Min. Green:	7	10	10	7	10	10	7	10	10	7	10	10
Y+R:	4.0	4.0	4.0	4.0	4.0	4.0	4.0	4.0	4.0	4.0	4.0	4.0
Volume Module: >> Count Date: 17 Sep 2014 <<												
Base Vol:	26	157	71	76	448	240	137	906	85	90	1080	104
Growth Adj:	1.00	1.00	1.00	1.00	1.00	1.00	1.00	1.00	1.00	1.00	1.00	1.00
Initial Bse:	26	157	71	76	448	240	137	906	85	90	1080	104
Added Vol:	0	0	0	0	0	0	0	0	0	0	0	0
PasserByVol:	0	0	0	0	0	0	0	0	0	0	0	0
Initial Fut:	26	157	71	76	448	240	137	906	85	90	1080	104
User Adj:	1.00	1.00	1.00	1.00	1.00	1.00	1.00	1.00	1.00	1.00	1.00	1.00
PHF Adj:	1.00	1.00	1.00	1.00	1.00	1.00	1.00	1.00	1.00	1.00	1.00	1.00
PHF Volume:	26	157	71	76	448	240	137	906	85	90	1080	104
Reduct Vol:	0	0	0	0	0	0	0	0	0	0	0	0
Reduced Vol:	26	157	71	76	448	240	137	906	85	90	1080	104
PCE Adj:	1.00	1.00	1.00	1.00	1.00	1.00	1.00	1.00	1.00	1.00	1.00	1.00
MLF Adj:	1.00	1.00	1.00	1.00	1.00	1.00	1.00	1.00	1.00	1.00	1.00	1.00
FinalVolume:	26	157	71	76	448	240	137	906	85	90	1080	104
Saturation Flow Module:												
Sat/Lane:	1900	1900	1900	1900	1900	1900	1900	1900	1900	1900	1900	1900
Adjustment:	0.92	0.95	0.95	0.92	1.00	0.92	0.92	1.00	0.92	0.92	1.00	0.92
Lanes:	1.00	0.69	0.31	1.00	1.00	1.00	1.00	3.00	1.00	1.00	3.00	1.00
Final Sat.:	1750	1239	561	1750	1900	1750	1750	5700	1750	1750	5700	1750
Capacity Analysis Module:												
Vol/Sat:	0.01	0.13	0.13	0.04	0.24	0.14	0.08	0.16	0.05	0.05	0.19	0.06
Crit Moves:	****			****			****			****		
Green Time:	7.0	37.2	37.2	17.1	47.3	63.0	15.7	39.3	46.3	14.4	38.0	55.1
Volume/Cap:	0.25	0.41	0.41	0.30	0.60	0.26	0.60	0.49	0.13	0.43	0.60	0.13
Delay/Veh:	55.3	33.2	33.2	46.8	30.2	15.8	53.5	32.5	23.9	50.4	35.1	18.7
User DelAdj:	1.00	1.00	1.00	1.00	1.00	1.00	1.00	1.00	1.00	1.00	1.00	1.00
AdjDel/Veh:	55.3	33.2	33.2	46.8	30.2	15.8	53.5	32.5	23.9	50.4	35.1	18.7
LOS by Move:	E	C	C	D	C	B	D	C	C	D	D	B
HCM2k95thQ:	3	13	13	5	23	10	10	16	4	6	20	5

Note: Queue reported is the number of cars per lane.

BART Phase II Extension Project

Level Of Service Computation Report
 2000 HCM Operations (Future Volume Alternative)
 AM - 2035 SC West Project Conditions

Intersection #1205: SCOTT/EL CAMINO REAL

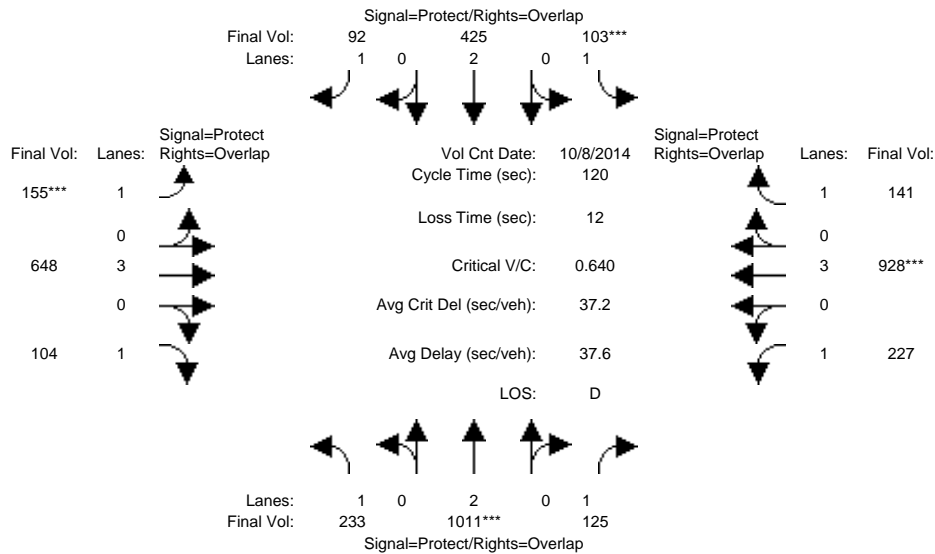

Approach:	North Bound			South Bound			East Bound			West Bound		
	L	T	R	L	T	R	L	T	R	L	T	R
Min. Green:	7	10	10	7	10	10	7	10	10	7	10	10
Y+R:	4.0	4.0	4.0	4.0	4.0	4.0	4.0	4.0	4.0	4.0	4.0	4.0
Volume Module: >> Count Date: 8 Oct 2014 <<												
Base Vol:	233	1011	125	103	425	92	155	648	104	227	928	141
Growth Adj:	1.00	1.00	1.00	1.00	1.00	1.00	1.00	1.00	1.00	1.00	1.00	1.00
Initial Bse:	233	1011	125	103	425	92	155	648	104	227	928	141
Added Vol:	0	0	0	0	0	0	0	0	0	0	0	0
PasserByVol:	0	0	0	0	0	0	0	0	0	0	0	0
Initial Fut:	233	1011	125	103	425	92	155	648	104	227	928	141
User Adj:	1.00	1.00	1.00	1.00	1.00	1.00	1.00	1.00	1.00	1.00	1.00	1.00
PHF Adj:	1.00	1.00	1.00	1.00	1.00	1.00	1.00	1.00	1.00	1.00	1.00	1.00
PHF Volume:	233	1011	125	103	425	92	155	648	104	227	928	141
Reduct Vol:	0	0	0	0	0	0	0	0	0	0	0	0
Reduced Vol:	233	1011	125	103	425	92	155	648	104	227	928	141
PCE Adj:	1.00	1.00	1.00	1.00	1.00	1.00	1.00	1.00	1.00	1.00	1.00	1.00
MLF Adj:	1.00	1.00	1.00	1.00	1.00	1.00	1.00	1.00	1.00	1.00	1.00	1.00
Final Volume:	233	1011	125	103	425	92	155	648	104	227	928	141
Saturation Flow Module:												
Sat/Lane:	1900	1900	1900	1900	1900	1900	1900	1900	1900	1900	1900	1900
Adjustment:	0.92	1.00	0.92	0.92	1.00	0.92	0.92	1.00	0.92	0.92	1.00	0.92
Lanes:	1.00	2.00	1.00	1.00	2.00	1.00	1.00	3.00	1.00	1.00	3.00	1.00
Final Sat.:	1750	3800	1750	1750	3800	1750	1750	5700	1750	1750	5700	1750
Capacity Analysis Module:												
Vol/Sat:	0.13	0.27	0.07	0.06	0.11	0.05	0.09	0.11	0.06	0.13	0.16	0.08
Crit Moves:	****			****			****			****		
Green Time:	33.1	49.9	75.0	11.0	27.8	44.4	16.6	22.0	55.1	25.1	30.5	41.5
Volume/Cap:	0.48	0.64	0.11	0.64	0.48	0.14	0.64	0.62	0.13	0.62	0.64	0.23
Delay/Veh:	37.1	28.8	9.1	61.0	40.3	25.2	54.6	46.3	18.7	46.4	40.8	28.1
User DelAdj:	1.00	1.00	1.00	1.00	1.00	1.00	1.00	1.00	1.00	1.00	1.00	1.00
AdjDel/Veh:	37.1	28.8	9.1	61.0	40.3	25.2	54.6	46.3	18.7	46.4	40.8	28.1
LOS by Move:	D	C	A	E	D	C	D	D	B	D	D	C
HCM2k95thQ:	14	26	4	8	13	5	11	14	5	15	19	8

Note: Queue reported is the number of cars per lane.

BART Phase II Extension Project

Level Of Service Computation Report
2000 HCM Operations (Future Volume Alternative)
PM - 2035 SC West Project Conditions

Intersection #1205: SCOTT/EL CAMINO REAL

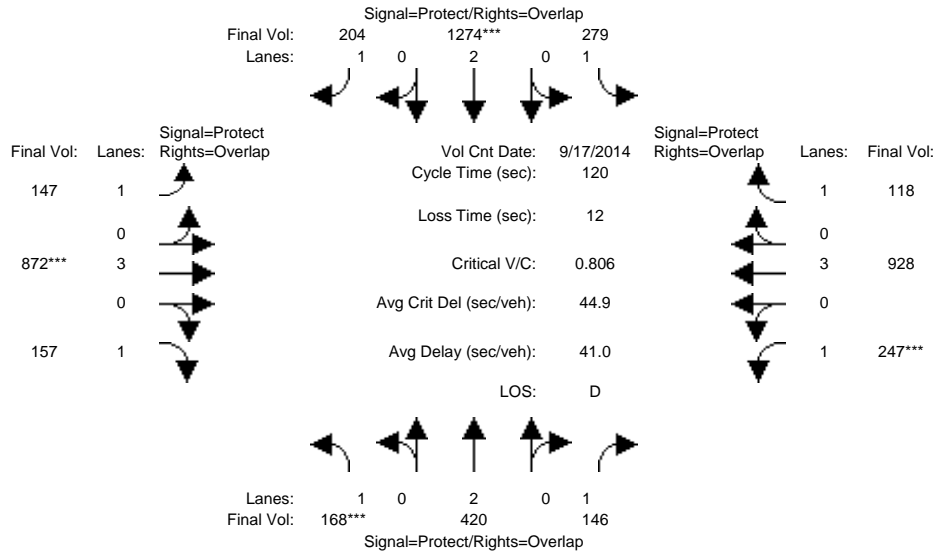

Approach:	North Bound			South Bound			East Bound			West Bound		
	L	T	R	L	T	R	L	T	R	L	T	R
Min. Green:	7	10	10	7	10	10	7	10	10	7	10	10
Y+R:	4.0	4.0	4.0	4.0	4.0	4.0	4.0	4.0	4.0	4.0	4.0	4.0

Volume Module:	>> Count Date: 17 Sep 2014 <<											
Base Vol:	168	420	146	279	1274	204	147	872	157	247	928	118
Growth Adj:	1.00	1.00	1.00	1.00	1.00	1.00	1.00	1.00	1.00	1.00	1.00	1.00
Initial Bse:	168	420	146	279	1274	204	147	872	157	247	928	118
Added Vol:	0	0	0	0	0	0	0	0	0	0	0	0
PasserByVol:	0	0	0	0	0	0	0	0	0	0	0	0
Initial Fut:	168	420	146	279	1274	204	147	872	157	247	928	118
User Adj:	1.00	1.00	1.00	1.00	1.00	1.00	1.00	1.00	1.00	1.00	1.00	1.00
PHF Adj:	1.00	1.00	1.00	1.00	1.00	1.00	1.00	1.00	1.00	1.00	1.00	1.00
PHF Volume:	168	420	146	279	1274	204	147	872	157	247	928	118
Reduct Vol:	0	0	0	0	0	0	0	0	0	0	0	0
Reduced Vol:	168	420	146	279	1274	204	147	872	157	247	928	118
PCE Adj:	1.00	1.00	1.00	1.00	1.00	1.00	1.00	1.00	1.00	1.00	1.00	1.00
MLF Adj:	1.00	1.00	1.00	1.00	1.00	1.00	1.00	1.00	1.00	1.00	1.00	1.00
Final Volume:	168	420	146	279	1274	204	147	872	157	247	928	118

Saturation Flow Module:												
Sat/Lane:	1900	1900	1900	1900	1900	1900	1900	1900	1900	1900	1900	1900
Adjustment:	0.92	1.00	0.92	0.92	1.00	0.92	0.92	1.00	0.92	0.92	1.00	0.92
Lanes:	1.00	2.00	1.00	1.00	2.00	1.00	1.00	3.00	1.00	1.00	3.00	1.00
Final Sat.:	1750	3800	1750	1750	3800	1750	1750	5700	1750	1750	5700	1750

Capacity Analysis Module:												
Vol/Sat:	0.10	0.11	0.08	0.16	0.34	0.12	0.08	0.15	0.09	0.14	0.16	0.07
Crit Moves:	****				****			****			****	
Green Time:	14.3	26.3	47.3	37.9	49.9	64.8	14.9	22.8	37.1	21.0	28.9	66.8
Volume/Cap:	0.81	0.50	0.21	0.50	0.81	0.22	0.68	0.81	0.29	0.81	0.68	0.12
Delay/Veh:	71.6	41.6	24.2	34.1	33.9	14.5	58.5	51.0	31.8	62.0	42.7	12.7
User DelAdj:	1.00	1.00	1.00	1.00	1.00	1.00	1.00	1.00	1.00	1.00	1.00	1.00
AdjDel/Veh:	71.6	41.6	24.2	34.1	33.9	14.5	58.5	51.0	31.8	62.0	42.7	12.7
LOS by Move:	E	D	C	C	C	B	E	D	C	E	D	B
HCM2k95thQ:	13	13	7	16	36	8	11	20	9	19	19	4

Note: Queue reported is the number of cars per lane.

BART Phase II Extension Project

Level Of Service Computation Report
 2000 HCM Operations (Future Volume Alternative)
 AM - 2035 SC West Project Conditions

Intersection #1213: THE ALAMEDA/EL CAMINO REAL

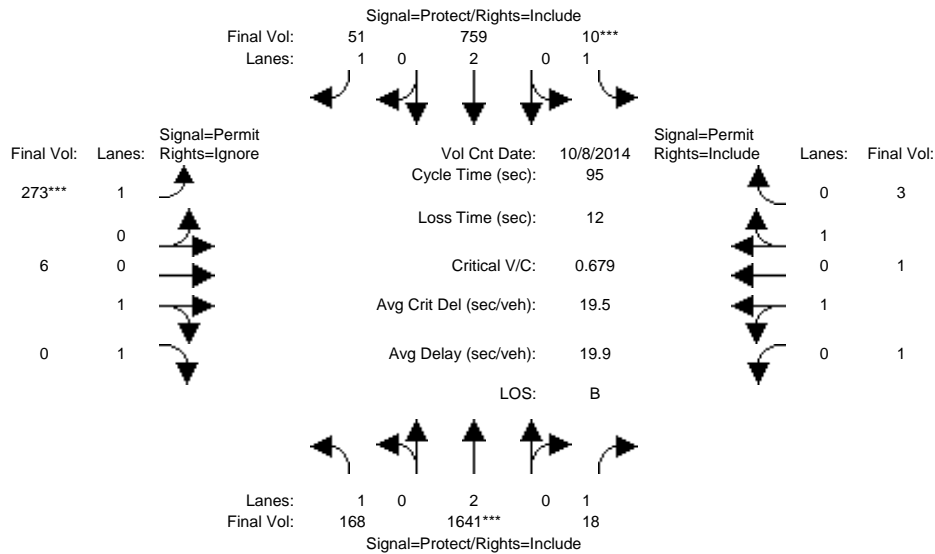

Approach:	North Bound			South Bound			East Bound			West Bound		
	L	T	R	L	T	R	L	T	R	L	T	R
Min. Green:	7	10	10	7	10	10	7	10	10	7	10	10
Y+R:	4.0	4.0	4.0	4.0	4.0	4.0	4.0	4.0	4.0	4.0	4.0	4.0
Volume Module: >> Count Date: 8 Oct 2014 <<												
Base Vol:	168	1641	18	10	759	51	273	6	225	1	1	3
Growth Adj:	1.00	1.00	1.00	1.00	1.00	1.00	1.00	1.00	1.00	1.00	1.00	1.00
Initial Bse:	168	1641	18	10	759	51	273	6	225	1	1	3
Added Vol:	0	0	0	0	0	0	0	0	0	0	0	0
PasserByVol:	0	0	0	0	0	0	0	0	0	0	0	0
Initial Fut:	168	1641	18	10	759	51	273	6	225	1	1	3
User Adj:	1.00	1.00	1.00	1.00	1.00	1.00	1.00	1.00	0.00	1.00	1.00	1.00
PHF Adj:	1.00	1.00	1.00	1.00	1.00	1.00	1.00	1.00	0.00	1.00	1.00	1.00
PHF Volume:	168	1641	18	10	759	51	273	6	0	1	1	3
Reduct Vol:	0	0	0	0	0	0	0	0	0	0	0	0
Reduced Vol:	168	1641	18	10	759	51	273	6	0	1	1	3
PCE Adj:	1.00	1.00	1.00	1.00	1.00	1.00	1.00	1.00	0.00	1.00	1.00	1.00
MLF Adj:	1.00	1.00	1.00	1.00	1.00	1.00	1.00	1.00	0.00	1.00	1.00	1.00
FinalVolume:	168	1641	18	10	759	51	273	6	0	1	1	3
Saturation Flow Module:												
Sat/Lane:	1900	1900	1900	1900	1900	1900	1900	1900	1900	1900	1900	1900
Adjustment:	0.92	1.00	0.92	0.92	1.00	0.92	0.92	0.95	0.92	0.95	0.95	0.95
Lanes:	1.00	2.00	1.00	1.00	2.00	1.00	1.00	1.00	1.00	0.50	0.50	1.00
Final Sat.:	1750	3800	1750	1750	3800	1750	1750	1800	1750	900	900	1800
Capacity Analysis Module:												
Vol/Sat:	0.10	0.43	0.01	0.01	0.20	0.03	0.16	0.00	0.00	0.00	0.00	0.00
Crit Moves:	****			****			****					
Green Time:	20.4	55.8	55.8	7.0	42.4	42.4	20.2	20.2	0.0	20.2	20.2	20.2
Volume/Cap:	0.45	0.73	0.02	0.08	0.45	0.07	0.73	0.02	0.00	0.01	0.01	0.01
Delay/Veh:	33.3	15.5	8.2	41.3	18.4	15.0	42.4	29.6	0.0	29.5	29.5	29.5
User DelAdj:	1.00	1.00	1.00	1.00	1.00	1.00	1.00	1.00	1.00	1.00	1.00	1.00
AdjDel/Veh:	33.3	15.5	8.2	41.3	18.4	15.0	42.4	29.6	0.0	29.5	29.5	29.5
LOS by Move:	C	B	A	D	B	B	D	C	A	C	C	C
HCM2k95thQ:	9	29	0	1	15	2	18	0	0	0	0	0

Note: Queue reported is the number of cars per lane.

BART Phase II Extension Project

Level Of Service Computation Report
 2000 HCM Operations (Future Volume Alternative)
 PM - 2035 SC West Project Conditions

Intersection #1213: THE ALAMEDA/EL CAMINO REAL

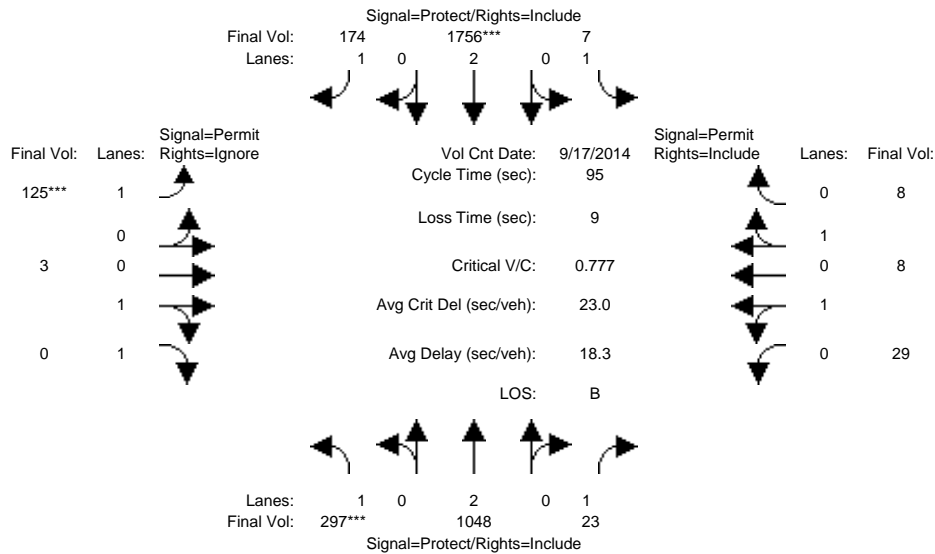

Approach:	North Bound			South Bound			East Bound			West Bound		
Movement:	L	T	R	L	T	R	L	T	R	L	T	R
Min. Green:	7	10	10	7	10	10	10	10	10	10	10	10
Y+R:	4.0	4.0	4.0	4.0	4.0	4.0	4.0	4.0	4.0	4.0	4.0	4.0
Volume Module: >> Count Date: 17 Sep 2014 <<												
Base Vol:	297	1048	23	7	1756	174	125	3	272	29	8	8
Growth Adj:	1.00	1.00	1.00	1.00	1.00	1.00	1.00	1.00	1.00	1.00	1.00	1.00
Initial Bse:	297	1048	23	7	1756	174	125	3	272	29	8	8
Added Vol:	0	0	0	0	0	0	0	0	0	0	0	0
PasserByVol:	0	0	0	0	0	0	0	0	0	0	0	0
Initial Fut:	297	1048	23	7	1756	174	125	3	272	29	8	8
User Adj:	1.00	1.00	1.00	1.00	1.00	1.00	1.00	1.00	0.00	1.00	1.00	1.00
PHF Adj:	1.00	1.00	1.00	1.00	1.00	1.00	1.00	1.00	0.00	1.00	1.00	1.00
PHF Volume:	297	1048	23	7	1756	174	125	3	0	29	8	8
Reduct Vol:	0	0	0	0	0	0	0	0	0	0	0	0
Reduced Vol:	297	1048	23	7	1756	174	125	3	0	29	8	8
PCE Adj:	1.00	1.00	1.00	1.00	1.00	1.00	1.00	1.00	0.00	1.00	1.00	1.00
MLF Adj:	1.00	1.00	1.00	1.00	1.00	1.00	1.00	1.00	0.00	1.00	1.00	1.00
FinalVolume:	297	1048	23	7	1756	174	125	3	0	29	8	8
Saturation Flow Module:												
Sat/Lane:	1900	1900	1900	1900	1900	1900	1900	1900	1900	1900	1900	1900
Adjustment:	0.92	1.00	0.92	0.92	1.00	0.92	0.92	0.95	0.92	0.95	0.95	0.95
Lanes:	1.00	2.00	1.00	1.00	2.00	1.00	1.00	1.00	1.00	1.00	0.50	0.50
Final Sat.:	1750	3800	1750	1750	3800	1750	1750	1800	1750	1800	900	900
Capacity Analysis Module:												
Vol/Sat:	0.17	0.28	0.01	0.00	0.46	0.10	0.07	0.00	0.00	0.02	0.01	0.01
Crit Moves:	****				****		****					
Green Time:	20.4	60.0	60.0	16.0	55.6	55.6	10.0	10.0	0.0	10.0	10.0	10.0
Volume/Cap:	0.79	0.44	0.02	0.02	0.79	0.17	0.68	0.02	0.00	0.15	0.08	0.08
Delay/Veh:	46.0	9.0	6.5	33.0	17.2	9.2	50.7	38.1	0.0	38.9	38.4	38.4
User DelAdj:	1.00	1.00	1.00	1.00	1.00	1.00	1.00	1.00	1.00	1.00	1.00	1.00
AdjDel/Veh:	46.0	9.0	6.5	33.0	17.2	9.2	50.7	38.1	0.0	38.9	38.4	38.4
LOS by Move:	D	A	A	C	B	A	D	D	A	D	D	D
HCM2k95thQ:	16	14	1	0	36	5	10	0	0	2	1	1

Note: Queue reported is the number of cars per lane.

BART Phase II Extension Project

Level Of Service Computation Report
 2000 HCM Operations (Future Volume Alternative)
 AM - 2035 SC West Project Conditions

Intersection #3411: AVIATION/COLEMAN

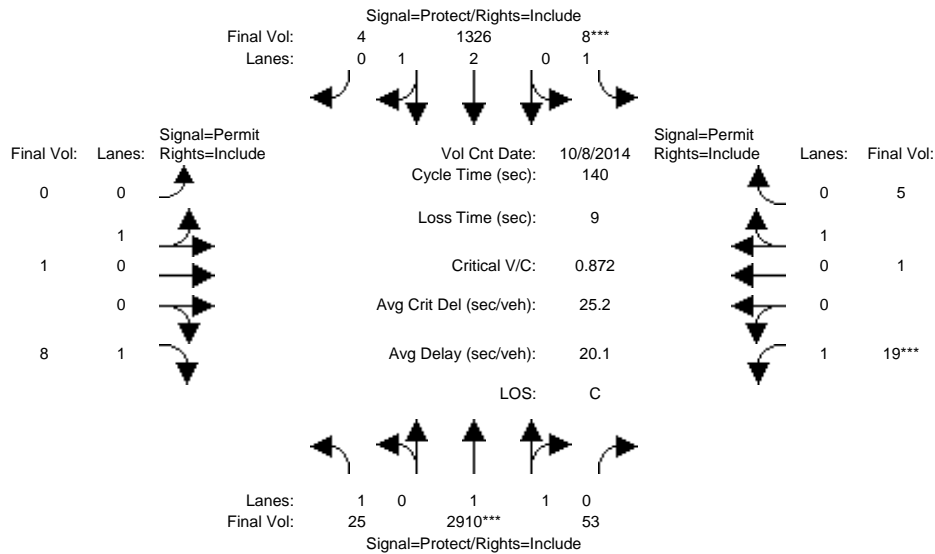

Approach:	North Bound			South Bound			East Bound			West Bound		
	L	T	R	L	T	R	L	T	R	L	T	R
Min. Green:	7	10	10	7	10	10	10	10	10	10	10	10
Y+R:	4.0	4.0	4.0	4.0	4.0	4.0	4.0	4.0	4.0	4.0	4.0	4.0
Volume Module: >> Count Date: 8 Oct 2014 <<												
Base Vol:	25	2910	53	8	1326	4	0	1	8	19	1	5
Growth Adj:	1.00	1.00	1.00	1.00	1.00	1.00	1.00	1.00	1.00	1.00	1.00	1.00
Initial Bse:	25	2910	53	8	1326	4	0	1	8	19	1	5
Added Vol:	0	0	0	0	0	0	0	0	0	0	0	0
PasserByVol:	0	0	0	0	0	0	0	0	0	0	0	0
Initial Fut:	25	2910	53	8	1326	4	0	1	8	19	1	5
User Adj:	1.00	1.00	1.00	1.00	1.00	1.00	1.00	1.00	1.00	1.00	1.00	1.00
PHF Adj:	1.00	1.00	1.00	1.00	1.00	1.00	1.00	1.00	1.00	1.00	1.00	1.00
PHF Volume:	25	2910	53	8	1326	4	0	1	8	19	1	5
Reduct Vol:	0	0	0	0	0	0	0	0	0	0	0	0
Reduced Vol:	25	2910	53	8	1326	4	0	1	8	19	1	5
PCE Adj:	1.00	1.00	1.00	1.00	1.00	1.00	1.00	1.00	1.00	1.00	1.00	1.00
MLF Adj:	1.00	1.00	1.00	1.00	1.00	1.00	1.00	1.00	1.00	1.00	1.00	1.00
FinalVolume:	25	2910	53	8	1326	4	0	1	8	19	1	5
Saturation Flow Module:												
Sat/Lane:	1900	1900	1900	1900	1900	1900	1900	1900	1900	1900	1900	1900
Adjustment:	0.92	0.97	0.95	0.92	0.98	0.95	0.95	0.95	0.92	0.92	0.95	0.95
Lanes:	1.00	1.96	0.04	1.00	2.99	0.01	0.00	1.00	1.00	1.00	0.17	0.83
Final Sat.:	1750	3634	66	1750	5583	17	0	1800	1750	1750	300	1500
Capacity Analysis Module:												
Vol/Sat:	0.01	0.80	0.80	0.00	0.24	0.24	0.00	0.00	0.00	0.01	0.00	0.00
Crit Moves:	****			****			****			****		
Green Time:	21.0	114	114.0	7.0	xxxx	100.0	0.0	10.0	10.0	10.0	10.0	10.0
Volume/Cap:	0.10	0.98	0.98	0.09	0.33	0.33	0.00	0.01	0.06	0.15	0.05	0.05
Delay/Veh:	51.4	24.9	24.9	63.9	7.6	7.6	0.0	60.4	60.9	61.6	60.7	60.7
User DelAdj:	1.00	1.00	1.00	1.00	1.00	1.00	1.00	1.00	1.00	1.00	1.00	1.00
AdjDel/Veh:	51.4	24.9	24.9	63.9	7.6	7.6	0.0	60.4	60.9	61.6	60.7	60.7
LOS by Move:	D	C	C	E	A	A	A	E	E	E	E	E
HCM2k95thQ:	2	100	100	1	13	13	0	0	1	2	1	1

Note: Queue reported is the number of cars per lane.

BART Phase II Extension Project

Level Of Service Computation Report
 2000 HCM Operations (Future Volume Alternative)
 PM - 2035 SC West Project Conditions

Intersection #3411: AVIATION/COLEMAN

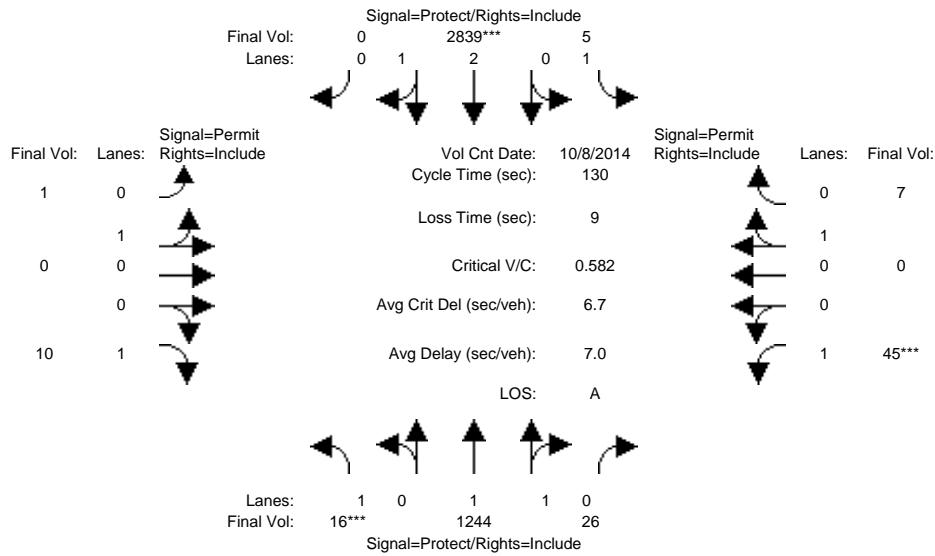

Approach:	North Bound			South Bound			East Bound			West Bound		
	L	T	R	L	T	R	L	T	R	L	T	R
Min. Green:	7	10	10	7	10	10	10	10	10	10	10	10
Y+R:	4.0	4.0	4.0	4.0	4.0	4.0	4.0	4.0	4.0	4.0	4.0	4.0

Volume Module: >> Count Date: 8 Oct 2014 <<

Base Vol:	16	1244	26	5	2839	0	1	0	10	45	0	7
Growth Adj:	1.00	1.00	1.00	1.00	1.00	1.00	1.00	1.00	1.00	1.00	1.00	1.00
Initial Bse:	16	1244	26	5	2839	0	1	0	10	45	0	7
Added Vol:	0	0	0	0	0	0	0	0	0	0	0	0
PasserByVol:	0	0	0	0	0	0	0	0	0	0	0	0
Initial Fut:	16	1244	26	5	2839	0	1	0	10	45	0	7
User Adj:	1.00	1.00	1.00	1.00	1.00	1.00	1.00	1.00	1.00	1.00	1.00	1.00
PHF Adj:	1.00	1.00	1.00	1.00	1.00	1.00	1.00	1.00	1.00	1.00	1.00	1.00
PHF Volume:	16	1244	26	5	2839	0	1	0	10	45	0	7
Reduct Vol:	0	0	0	0	0	0	0	0	0	0	0	0
Reduced Vol:	16	1244	26	5	2839	0	1	0	10	45	0	7
PCE Adj:	1.00	1.00	1.00	1.00	1.00	1.00	1.00	1.00	1.00	1.00	1.00	1.00
MLF Adj:	1.00	1.00	1.00	1.00	1.00	1.00	1.00	1.00	1.00	1.00	1.00	1.00
FinalVolume:	16	1244	26	5	2839	0	1	0	10	45	0	7

Saturation Flow Module:

Sat/Lane:	1900	1900	1900	1900	1900	1900	1900	1900	1900	1900	1900	1900
Adjustment:	0.92	0.97	0.95	0.92	0.98	0.92	0.95	0.95	0.92	0.92	1.00	0.95
Lanes:	1.00	1.96	0.04	1.00	3.00	0.00	1.00	0.00	1.00	1.00	0.00	1.00
Final Sat.:	1750	3624	76	1750	5600	0	1800	0	1750	1750	0	1800

Capacity Analysis Module:

Vol/Sat:	0.01	0.34	0.34	0.00	0.51	0.00	0.00	0.00	0.01	0.03	0.00	0.00
Crit Moves:	****				****					****		
Green Time:	7.0	95.9	95.9	15.1	104	0.0	10.0	0.0	10.0	10.0	0.0	10.0
Volume/Cap:	0.17	0.47	0.47	0.02	0.63	0.00	0.01	0.00	0.07	0.33	0.00	0.05
Delay/Veh:	59.6	6.9	6.9	51.0	5.6	0.0	55.4	0.0	55.9	58.3	0.0	55.8
User DelAdj:	1.00	1.00	1.00	1.00	1.00	1.00	1.00	1.00	1.00	1.00	1.00	1.00
AdjDel/Veh:	59.6	6.9	6.9	51.0	5.6	0.0	55.4	0.0	55.9	58.3	0.0	55.8
LOS by Move:	E	A	A	D	A	A	E	A	E	E	A	E
HCM2k95thQ:	1	19	19	0	25	0	0	0	1	4	0	1

Note: Queue reported is the number of cars per lane.

BART Phase II Extension Project

Level Of Service Computation Report
 2000 HCM Operations (Future Volume Alternative)
 AM - 2035 SC West Project Conditions

Intersection #4047: COLEMAN/NEWHALL

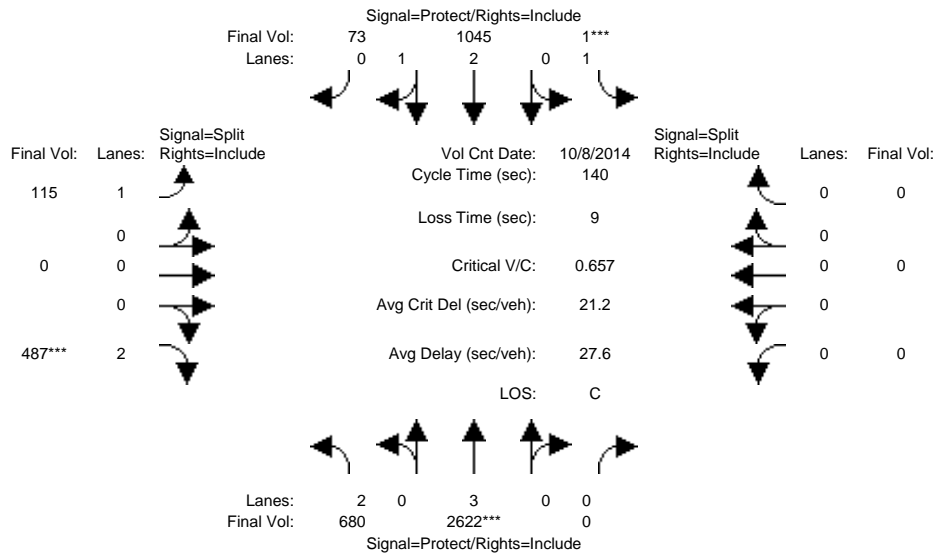

Approach:	North Bound			South Bound			East Bound			West Bound		
	L	T	R	L	T	R	L	T	R	L	T	R
Min. Green:	7	10	0	7	10	10	10	0	10	0	0	0
Y+R:	4.0	4.0	4.0	4.0	4.0	4.0	4.0	4.0	4.0	4.0	4.0	4.0
Volume Module: >> Count Date: 8 Oct 2014 <<												
Base Vol:	680	2622	0	1	1045	73	115	0	487	0	0	0
Growth Adj:	1.00	1.00	1.00	1.00	1.00	1.00	1.00	1.00	1.00	1.00	1.00	1.00
Initial Bse:	680	2622	0	1	1045	73	115	0	487	0	0	0
Added Vol:	0	0	0	0	0	0	0	0	0	0	0	0
PasserByVol:	0	0	0	0	0	0	0	0	0	0	0	0
Initial Fut:	680	2622	0	1	1045	73	115	0	487	0	0	0
User Adj:	1.00	1.00	1.00	1.00	1.00	1.00	1.00	1.00	1.00	1.00	1.00	1.00
PHF Adj:	1.00	1.00	1.00	1.00	1.00	1.00	1.00	1.00	1.00	1.00	1.00	1.00
PHF Volume:	680	2622	0	1	1045	73	115	0	487	0	0	0
Reduct Vol:	0	0	0	0	0	0	0	0	0	0	0	0
Reduced Vol:	680	2622	0	1	1045	73	115	0	487	0	0	0
PCE Adj:	1.00	1.00	1.00	1.00	1.00	1.00	1.00	1.00	1.00	1.00	1.00	1.00
MLF Adj:	1.00	1.00	1.00	1.00	1.00	1.00	1.00	1.00	1.00	1.00	1.00	1.00
Final Volume:	680	2622	0	1	1045	73	115	0	487	0	0	0
Saturation Flow Module:												
Sat/Lane:	1900	1900	1900	1900	1900	1900	1900	1900	1900	1900	1900	1900
Adjustment:	0.83	1.00	0.92	0.92	0.98	0.95	0.92	1.00	0.83	0.92	1.00	0.92
Lanes:	2.00	3.00	0.00	1.00	2.80	0.20	1.00	0.00	2.00	0.00	0.00	0.00
Final Sat.:	3150	5700	0	1750	5234	366	1750	0	3150	0	0	0
Capacity Analysis Module:												
Vol/Sat:	0.22	0.46	0.00	0.00	0.20	0.20	0.07	0.00	0.15	0.00	0.00	0.00
Crit Moves:	****			****			****			****		
Green Time:	51.9	92.8	0.0	7.0	48.0	48.0	31.2	0.0	31.2	0.0	0.0	0.0
Volume/Cap:	0.58	0.69	0.00	0.01	0.58	0.58	0.29	0.00	0.69	0.00	0.00	0.00
Delay/Veh:	36.1	15.3	0.0	63.3	38.3	38.3	45.7	0.0	53.0	0.0	0.0	0.0
User DelAdj:	1.00	1.00	1.00	1.00	1.00	1.00	1.00	1.00	1.00	1.00	1.00	1.00
AdjDel/Veh:	36.1	15.3	0.0	63.3	38.3	38.3	45.7	0.0	53.0	0.0	0.0	0.0
LOS by Move:	D	B	A	E	D	D	D	A	D	A	A	A
HCM2k95thQ:	25	39	0	0	23	23	9	0	23	0	0	0

Note: Queue reported is the number of cars per lane.

BART Phase II Extension Project

Level Of Service Computation Report
 2000 HCM Operations (Future Volume Alternative)
 PM - 2035 SC West Project Conditions

Intersection #4047: COLEMAN/NEWHALL

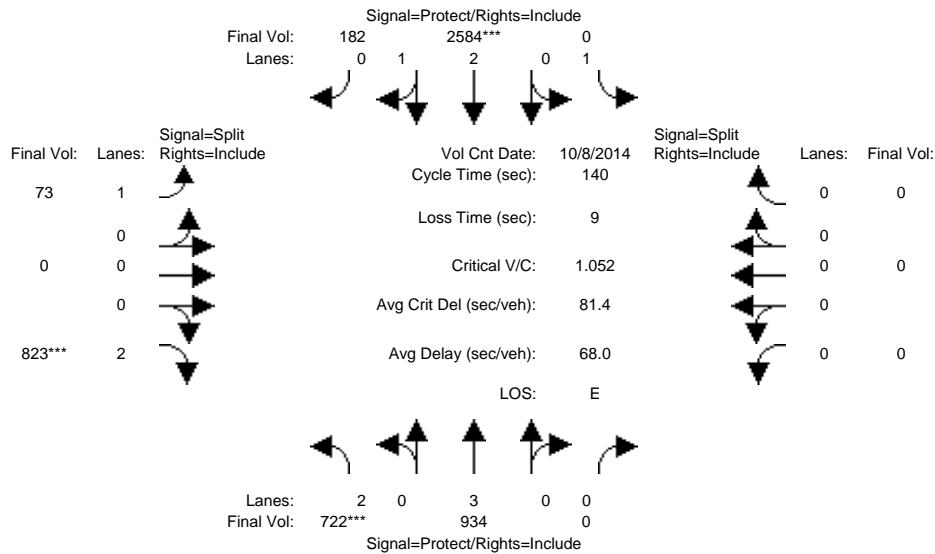

Approach:	North Bound			South Bound			East Bound			West Bound		
	L	T	R	L	T	R	L	T	R	L	T	R
Min. Green:	7	10	0	7	10	10	10	0	10	0	0	0
Y+R:	4.0	4.0	4.0	4.0	4.0	4.0	4.0	4.0	4.0	4.0	4.0	4.0
Volume Module: >> Count Date: 8 Oct 2014 <<												
Base Vol:	722	934	0	0	2584	182	73	0	823	0	0	0
Growth Adj:	1.00	1.00	1.00	1.00	1.00	1.00	1.00	1.00	1.00	1.00	1.00	1.00
Initial Bse:	722	934	0	0	2584	182	73	0	823	0	0	0
Added Vol:	0	0	0	0	0	0	0	0	0	0	0	0
PasserByVol:	0	0	0	0	0	0	0	0	0	0	0	0
Initial Fut:	722	934	0	0	2584	182	73	0	823	0	0	0
User Adj:	1.00	1.00	1.00	1.00	1.00	1.00	1.00	1.00	1.00	1.00	1.00	1.00
PHF Adj:	1.00	1.00	1.00	1.00	1.00	1.00	1.00	1.00	1.00	1.00	1.00	1.00
PHF Volume:	722	934	0	0	2584	182	73	0	823	0	0	0
Reduct Vol:	0	0	0	0	0	0	0	0	0	0	0	0
Reduced Vol:	722	934	0	0	2584	182	73	0	823	0	0	0
PCE Adj:	1.00	1.00	1.00	1.00	1.00	1.00	1.00	1.00	1.00	1.00	1.00	1.00
MLF Adj:	1.00	1.00	1.00	1.00	1.00	1.00	1.00	1.00	1.00	1.00	1.00	1.00
FinalVolume:	722	934	0	0	2584	182	73	0	823	0	0	0
Saturation Flow Module:												
Sat/Lane:	1900	1900	1900	1900	1900	1900	1900	1900	1900	1900	1900	1900
Adjustment:	0.83	1.00	0.92	0.92	0.98	0.95	0.92	1.00	0.83	0.92	1.00	0.92
Lanes:	2.00	3.00	0.00	1.00	2.80	0.20	1.00	0.00	2.00	0.00	0.00	0.00
Final Sat.:	3150	5700	0	1750	5231	368	1750	0	3150	0	0	0
Capacity Analysis Module:												
Vol/Sat:	0.23	0.16	0.00	0.00	0.49	0.49	0.04	0.00	0.26	0.00	0.00	0.00
Crit Moves:	****				****				****			
Green Time:	30.5	96.2	0.0	0.0	65.7	65.7	34.8	0.0	34.8	0.0	0.0	0.0
Volume/Cap:	1.05	0.24	0.00	0.00	1.05	1.05	0.17	0.00	1.05	0.00	0.00	0.00
Delay/Veh:	103.6	8.2	0.0	0.0	70.3	70.3	41.5	0.0	99.4	0.0	0.0	0.0
User DelAdj:	1.00	1.00	1.00	1.00	1.00	1.00	1.00	1.00	1.00	1.00	1.00	1.00
AdjDel/Veh:	103.6	8.2	0.0	0.0	70.3	70.3	41.5	0.0	99.4	0.0	0.0	0.0
LOS by Move:	F	A	A	A	E	E	D	A	F	A	A	A
HCM2k95thQ:	42	9	0	0	75	75	5	0	47	0	0	0

Note: Queue reported is the number of cars per lane.

BART Phase II Extension Project

Level Of Service Computation Report
 2000 HCM Operations (Future Volume Alternative)
 AM - 2035 SC West Project Conditions

Intersection #5335: CENTRAL EXPWY/DE LA CRUZ BLVD

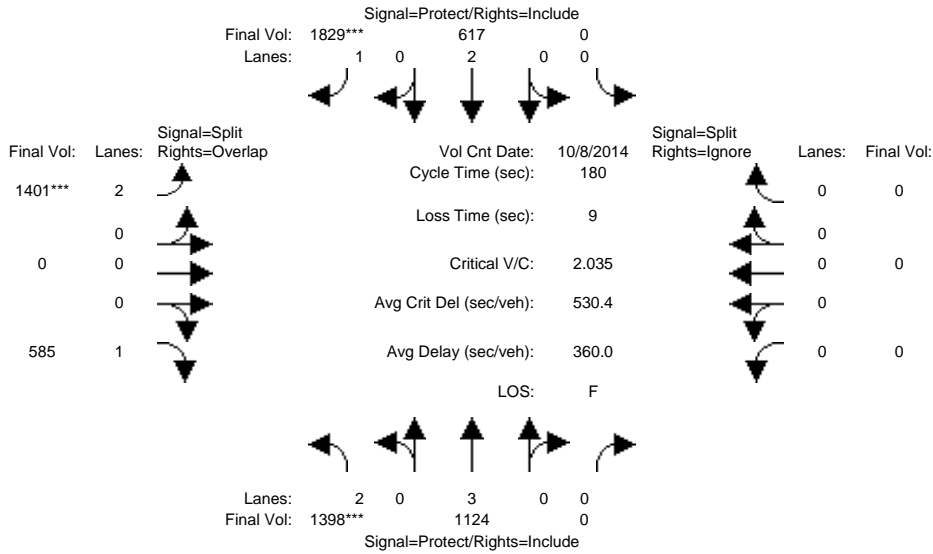

Approach:	North Bound			South Bound			East Bound			West Bound		
	L	T	R	L	T	R	L	T	R	L	T	R
Min. Green:	7	10	0	0	10	10	10	0	10	0	0	0
Y+R:	4.0	4.0	4.0	4.0	4.0	4.0	4.0	4.0	4.0	4.0	4.0	4.0

Volume Module:	>>	Count	Date:	8 Oct 2014	<<							
Base Vol:	1398	1124	0	0	617	1829	1610	0	585	0	0	0
Growth Adj:	1.00	1.00	1.00	1.00	1.00	1.00	1.00	1.00	1.00	1.00	1.00	1.00
Initial Bse:	1398	1124	0	0	617	1829	1610	0	585	0	0	0
Added Vol:	0	0	0	0	0	0	0	0	0	0	0	0
PasserByVol:	0	0	0	0	0	0	0	0	0	0	0	0
Initial Fut:	1398	1124	0	0	617	1829	1610	0	585	0	0	0
User Adj:	1.00	1.00	1.00	1.00	1.00	1.00	0.87	1.00	1.00	1.00	1.00	0.00
PHF Adj:	1.00	1.00	1.00	1.00	1.00	1.00	1.00	1.00	1.00	1.00	1.00	0.00
PHF Volume:	1398	1124	0	0	617	1829	1401	0	585	0	0	0
Reduct Vol:	0	0	0	0	0	0	0	0	0	0	0	0
Reduced Vol:	1398	1124	0	0	617	1829	1401	0	585	0	0	0
PCE Adj:	1.00	1.00	1.00	1.00	1.00	1.00	1.00	1.00	1.00	1.00	1.00	0.00
MLF Adj:	1.00	1.00	1.00	1.00	1.00	1.00	1.00	1.00	1.00	1.00	1.00	0.00
FinalVolume:	1398	1124	0	0	617	1829	1401	0	585	0	0	0

Saturation Flow Module:												
Sat/Lane:	1900	1900	1900	1900	1900	1900	1900	1900	1900	1900	1900	1900
Adjustment:	0.83	1.00	0.92	0.92	1.00	0.92	0.83	1.00	0.92	0.92	1.00	0.92
Lanes:	2.00	3.00	0.00	0.00	2.00	1.00	2.00	0.00	1.00	0.00	0.00	0.00
Final Sat.:	3150	5700	0	0	3800	1750	3150	0	1750	0	0	0

Capacity Analysis Module:												
Vol/Sat:	0.44	0.20	0.00	0.00	0.16	1.05	0.44	0.00	0.33	0.00	0.00	0.00
Crit Moves:	****					****	****					
Green Time:	39.2	132	0.0	0.0	92.4	92.4	39.3	0.0	78.6	0.0	0.0	0.0
Volume/Cap:	2.04	0.27	0.00	0.00	0.32	2.04	2.04	0.00	0.77	0.00	0.00	0.00
Delay/Veh:	541.4	8.1	0.0	0.0	25.5	513.6	541.3	0.0	41.3	0.0	0.0	0.0
User DelAdj:	1.00	1.00	1.00	1.00	1.00	1.00	1.00	1.00	1.00	1.00	1.00	1.00
AdjDel/Veh:	541.4	8.1	0.0	0.0	25.5	513.6	541.3	0.0	41.3	0.0	0.0	0.0
LOS by Move:	F	A	A	A	C	F	F	A	D	A	A	A
HCM2k95thQ:	146	13	0	0	18	341	146	0	43	0	0	0

Note: Queue reported is the number of cars per lane.

BART Phase II Extension Project

Level Of Service Computation Report
 2000 HCM Operations (Future Volume Alternative)
 PM - 2035 SC West Project Conditions

Intersection #5335: CENTRAL EXPWY/DE LA CRUZ BLVD

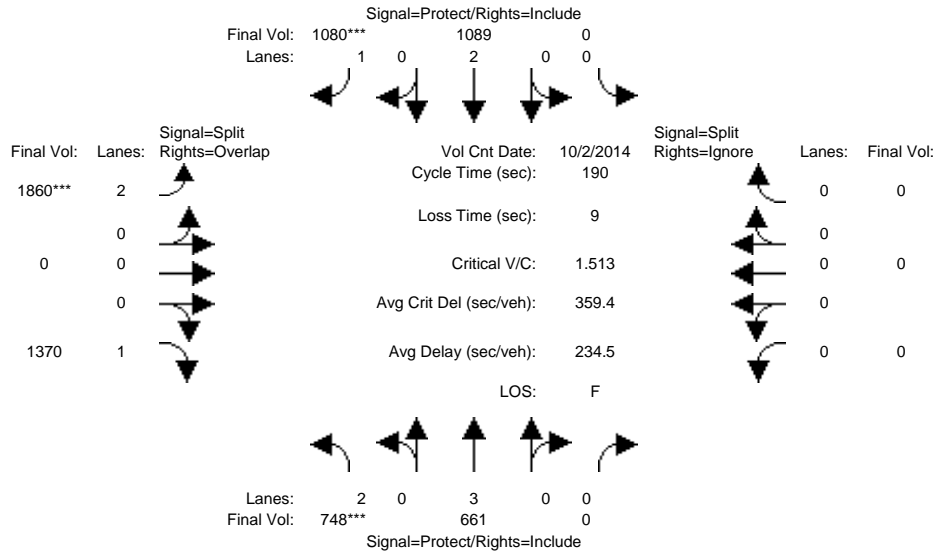

Approach:	North Bound			South Bound			East Bound			West Bound		
	L	T	R	L	T	R	L	T	R	L	T	R
Min. Green:	19	76	0	0	57	57	114	0	114	0	0	0
Y+R:	4.0	4.0	4.0	4.0	4.0	4.0	4.0	4.0	4.0	4.0	4.0	4.0
Volume Module: >> Count Date: 2 Oct 2014 <<												
Base Vol:	748	661	0	0	1089	1080	2513	0	1370	0	0	0
Growth Adj:	1.00	1.00	1.00	1.00	1.00	1.00	1.00	1.00	1.00	1.00	1.00	1.00
Initial Bse:	748	661	0	0	1089	1080	2513	0	1370	0	0	0
Added Vol:	0	0	0	0	0	0	0	0	0	0	0	0
PasserByVol:	0	0	0	0	0	0	0	0	0	0	0	0
Initial Fut:	748	661	0	0	1089	1080	2513	0	1370	0	0	0
User Adj:	1.00	1.00	1.00	1.00	1.00	1.00	0.74	1.00	1.00	1.00	1.00	0.00
PHF Adj:	1.00	1.00	1.00	1.00	1.00	1.00	1.00	1.00	1.00	1.00	1.00	0.00
PHF Volume:	748	661	0	0	1089	1080	1860	0	1370	0	0	0
Reduct Vol:	0	0	0	0	0	0	0	0	0	0	0	0
Reduced Vol:	748	661	0	0	1089	1080	1860	0	1370	0	0	0
PCE Adj:	1.00	1.00	1.00	1.00	1.00	1.00	1.00	1.00	1.00	1.00	1.00	0.00
MLF Adj:	1.00	1.00	1.00	1.00	1.00	1.00	1.00	1.00	1.00	1.00	1.00	0.00
Final Volume:	748	661	0	0	1089	1080	1860	0	1370	0	0	0
Saturation Flow Module:												
Sat/Lane:	1900	1900	1900	1900	1900	1900	1900	1900	1900	1900	1900	1900
Adjustment:	0.83	1.00	0.92	0.92	1.00	0.92	0.83	1.00	0.92	0.92	1.00	0.92
Lanes:	2.00	3.00	0.00	0.00	2.00	1.00	2.00	0.00	1.00	0.00	0.00	0.00
Final Sat.:	3150	5700	0	0	3800	1750	3150	0	1750	0	0	0
Capacity Analysis Module:												
Vol/Sat:	0.24	0.12	0.00	0.00	0.29	0.62	0.59	0.00	0.78	0.00	0.00	0.00
Crit Moves:	****					****	****					
Green Time:	18.1	72.6	0.0	0.0	54.4	54.4	108.8	0.0	127.0	0.0	0.0	0.0
Volume/Cap:	2.49	0.30	0.00	0.00	1.00	2.15	1.03	0.00	1.17	0.00	0.00	0.00
Delay/Veh:	769.1	43.1	0.0	0.0	98.4	597.2	56.5	0.0	98.9	0.0	0.0	0.0
User DelAdj:	1.00	1.00	1.00	1.00	1.00	1.00	1.00	1.00	1.00	1.00	1.00	1.00
AdjDel/Veh:	769.1	43.1	0.0	0.0	98.4	597.2	56.5	0.0	98.9	0.0	0.0	0.0
LOS by Move:	F	D	A	A	F	F	E	A	F	A	A	A
HCM2k95thQ:	90	17	0	0	59	217	115	0	174	0	0	0

Note: Queue reported is the number of cars per lane.

BART Phase II Extension Project

Level Of Service Computation Report
 2000 HCM Operations (Future Volume Alternative)
 AM - 2035 SC West Project Conditions

Intersection #5416: SAN TOMAS EXPWY/EL CAMINO REAL

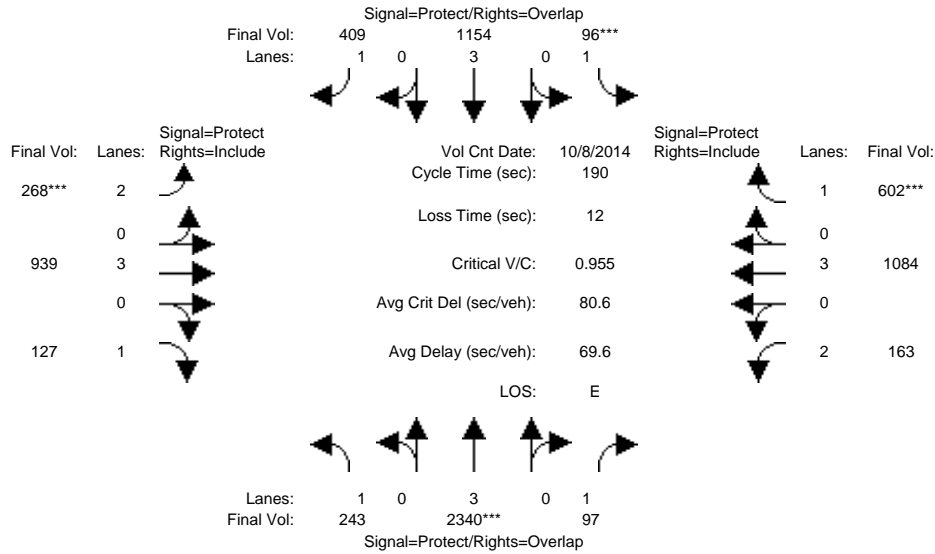

Approach:	North Bound			South Bound			East Bound			West Bound		
	L	T	R	L	T	R	L	T	R	L	T	R
Min. Green:	7	10	10	7	10	10	7	10	10	7	10	10
Y+R:	4.0	4.0	4.0	4.0	4.0	4.0	4.0	4.0	4.0	4.0	4.0	4.0
Volume Module: >> Count Date: 8 Oct 2014 <<												
Base Vol:	243	2786	97	96	1374	409	268	939	127	163	1084	602
Growth Adj:	1.00	1.00	1.00	1.00	1.00	1.00	1.00	1.00	1.00	1.00	1.00	1.00
Initial Bse:	243	2786	97	96	1374	409	268	939	127	163	1084	602
Added Vol:	0	0	0	0	0	0	0	0	0	0	0	0
PasserByVol:	0	0	0	0	0	0	0	0	0	0	0	0
Initial Fut:	243	2786	97	96	1374	409	268	939	127	163	1084	602
User Adj:	1.00	0.84	1.00	1.00	0.84	1.00	1.00	1.00	1.00	1.00	1.00	1.00
PHF Adj:	1.00	1.00	1.00	1.00	1.00	1.00	1.00	1.00	1.00	1.00	1.00	1.00
PHF Volume:	243	2340	97	96	1154	409	268	939	127	163	1084	602
Reduct Vol:	0	0	0	0	0	0	0	0	0	0	0	0
Reduced Vol:	243	2340	97	96	1154	409	268	939	127	163	1084	602
PCE Adj:	1.00	1.00	1.00	1.00	1.00	1.00	1.00	1.00	1.00	1.00	1.00	1.00
MLF Adj:	1.00	1.00	1.00	1.00	1.00	1.00	1.00	1.00	1.00	1.00	1.00	1.00
Final Volume:	243	2340	97	96	1154	409	268	939	127	163	1084	602
Saturation Flow Module:												
Sat/Lane:	1900	1900	1900	1900	1900	1900	1900	1900	1900	1900	1900	1900
Adjustment:	0.92	1.00	0.92	0.92	1.00	0.92	0.83	1.00	0.92	0.83	1.00	0.92
Lanes:	1.00	3.00	1.00	1.00	3.00	1.00	2.00	3.00	1.00	2.00	3.00	1.00
Final Sat.:	1750	5700	1750	1750	5700	1750	3150	5700	1750	3150	5700	1750
Capacity Analysis Module:												
Vol/Sat:	0.14	0.41	0.06	0.05	0.20	0.23	0.09	0.16	0.07	0.05	0.19	0.34
Crit Moves:	****			****			****			****		
Green Time:	37.7	81.7	102.1	10.9	54.9	71.9	16.9	65.0	65.0	20.4	68.5	68.5
Volume/Cap:	0.70	0.95	0.10	0.95	0.70	0.62	0.95	0.48	0.21	0.48	0.53	0.95
Delay/Veh:	77.6	70.7	27.8	167.8	77.9	69.1	127.6	49.4	44.5	80.9	48.3	84.3
User DelAdj:	1.00	1.00	1.00	1.00	1.00	1.00	1.00	1.00	1.00	1.00	1.00	1.00
AdjDel/Veh:	77.6	70.7	27.8	167.8	77.9	69.1	127.6	49.4	44.5	80.9	48.3	84.3
LOS by Move:	E	E	C	F	E	E	F	D	D	F	D	F
HCM2k95thQ:	26	74	8	14	36	39	23	25	11	10	28	63

Note: Queue reported is the number of cars per lane.

BART Phase II Extension Project

Level Of Service Computation Report
 2000 HCM Operations (Future Volume Alternative)
 PM - 2035 SC West Project Conditions

Intersection #5416: SAN TOMAS EXPWY/EL CAMINO REAL

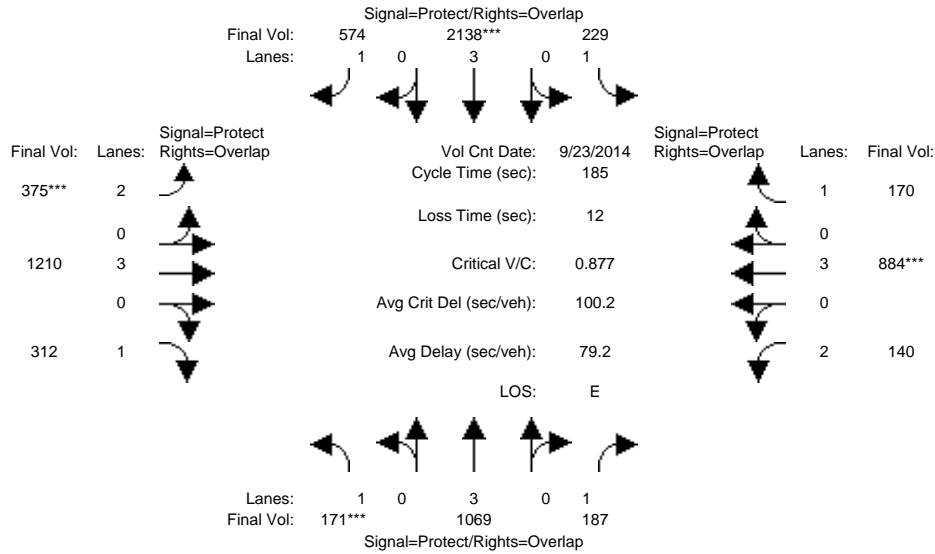

Approach:	North Bound			South Bound			East Bound			West Bound		
Movement:	L	T	R	L	T	R	L	T	R	L	T	R
Min. Green:	12	72	72	33	93	93	39	50	50	29	41	41
Y+R:	4.0	4.0	4.0	4.0	4.0	4.0	4.0	4.0	4.0	4.0	4.0	4.0
Volume Module: >> Count Date: 23 Sep 2014 <<												
Base Vol:	171	1406	187	229	2777	574	375	1210	312	140	884	170
Growth Adj:	1.00	1.00	1.00	1.00	1.00	1.00	1.00	1.00	1.00	1.00	1.00	1.00
Initial Bse:	171	1406	187	229	2777	574	375	1210	312	140	884	170
Added Vol:	0	0	0	0	0	0	0	0	0	0	0	0
PasserByVol:	0	0	0	0	0	0	0	0	0	0	0	0
Initial Fut:	171	1406	187	229	2777	574	375	1210	312	140	884	170
User Adj:	1.00	0.76	1.00	1.00	0.77	1.00	1.00	1.00	1.00	1.00	1.00	1.00
PHF Adj:	1.00	1.00	1.00	1.00	1.00	1.00	1.00	1.00	1.00	1.00	1.00	1.00
PHF Volume:	171	1069	187	229	2138	574	375	1210	312	140	884	170
Reduct Vol:	0	0	0	0	0	0	0	0	0	0	0	0
Reduced Vol:	171	1069	187	229	2138	574	375	1210	312	140	884	170
PCE Adj:	1.00	1.00	1.00	1.00	1.00	1.00	1.00	1.00	1.00	1.00	1.00	1.00
MLF Adj:	1.00	1.00	1.00	1.00	1.00	1.00	1.00	1.00	1.00	1.00	1.00	1.00
Final Volume:	171	1069	187	229	2138	574	375	1210	312	140	884	170
Saturation Flow Module:												
Sat/Lane:	1900	1900	1900	1900	1900	1900	1900	1900	1900	1900	1900	1900
Adjustment:	0.92	1.00	0.92	0.92	0.83	0.92	0.83	1.00	0.92	0.83	1.00	0.92
Lanes:	1.00	3.00	1.00	1.00	3.00	1.00	2.00	3.00	1.00	2.00	3.00	1.00
Final Sat.:	1750	5700	1750	1750	4731	1750	3150	5700	1750	3150	5700	1750
Capacity Analysis Module:												
Vol/Sat:	0.10	0.19	0.11	0.13	0.45	0.33	0.12	0.21	0.18	0.04	0.16	0.10
Crit Moves:	****				****		****				****	
Green Time:	11.3	67.6	95.2	31.0	87.3	124.0	36.6	47.5	58.8	27.6	38.5	69.5
Volume/Cap:	1.60	0.51	0.21	0.78	0.96	0.49	0.60	0.83	0.56	0.30	0.75	0.26
Delay/Veh:	403.6	54.3	32.8	101.8	90.8	37.9	73.6	73.0	57.1	75.0	75.7	42.7
User DelAdj:	1.00	1.00	1.00	1.00	1.00	1.00	1.00	1.00	1.00	1.00	1.00	1.00
AdjDel/Veh:	403.6	54.3	32.8	101.8	90.8	37.9	73.6	73.0	57.1	75.0	75.7	42.7
LOS by Move:	F	D	C	F	F	D	E	E	E	E	E	D
HCM2k95thQ:	33	31	15	27	71	50	23	40	29	9	29	14

Note: Queue reported is the number of cars per lane.

BART Phase II Extension Project

Level Of Service Computation Report
 2000 HCM Operations (Future Volume Alternative)
 AM - 2035 SC West Project Conditions

Intersection #5444: Lafayette/Lewis

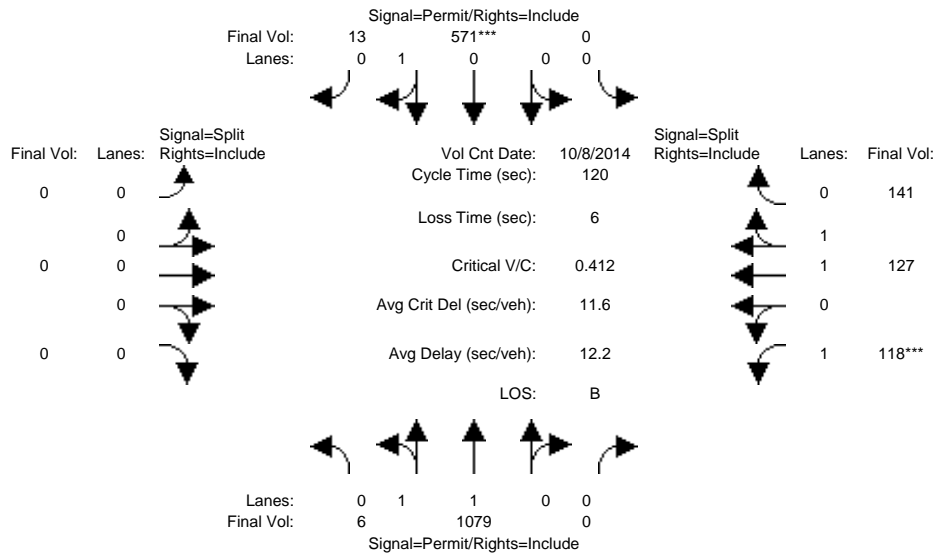

Approach:	North Bound			South Bound			East Bound			West Bound		
Movement:	L	T	R	L	T	R	L	T	R	L	T	R
Min. Green:	10	10	0	0	10	10	0	0	0	10	10	10
Y+R:	4.0	4.0	4.0	4.0	4.0	4.0	4.0	4.0	4.0	4.0	4.0	4.0
Volume Module: >> Count Date: 8 Oct 2014 <<												
Base Vol:	6	1079	0	0	571	13	0	0	0	118	127	141
Growth Adj:	1.00	1.00	1.00	1.00	1.00	1.00	1.00	1.00	1.00	1.00	1.00	1.00
Initial Bse:	6	1079	0	0	571	13	0	0	0	118	127	141
Added Vol:	0	0	0	0	0	0	0	0	0	0	0	0
PasserByVol:	0	0	0	0	0	0	0	0	0	0	0	0
Initial Fut:	6	1079	0	0	571	13	0	0	0	118	127	141
User Adj:	1.00	1.00	1.00	1.00	1.00	1.00	1.00	1.00	1.00	1.00	1.00	1.00
PHF Adj:	1.00	1.00	1.00	1.00	1.00	1.00	1.00	1.00	1.00	1.00	1.00	1.00
PHF Volume:	6	1079	0	0	571	13	0	0	0	118	127	141
Reduct Vol:	0	0	0	0	0	0	0	0	0	0	0	0
Reduced Vol:	6	1079	0	0	571	13	0	0	0	118	127	141
PCE Adj:	1.00	1.00	1.00	1.00	1.00	1.00	1.00	1.00	1.00	1.00	1.00	1.00
MLF Adj:	1.00	1.00	1.00	1.00	1.00	1.00	1.00	1.00	1.00	1.00	1.00	1.00
FinalVolume:	6	1079	0	0	571	13	0	0	0	118	127	141
Saturation Flow Module:												
Sat/Lane:	1900	1900	1900	1900	1900	1900	1900	1900	1900	1900	1900	1900
Adjustment:	0.95	0.97	0.92	0.92	0.95	0.95	0.92	1.00	0.92	0.92	1.00	0.92
Lanes:	0.01	1.99	0.00	0.00	0.98	0.02	0.00	0.00	0.00	1.00	1.00	1.00
Final Sat.:	20	3680	0	0	1760	40	0	0	0	1750	1900	1750
Capacity Analysis Module:												
Vol/Sat:	0.29	0.29	0.00	0.00	0.32	0.32	0.00	0.00	0.00	0.07	0.07	0.08
Crit Moves:	****						****					
Green Time:	91.3	91.3	0.0	0.0	91.3	91.3	0.0	0.0	0.0	22.7	22.7	22.7
Volume/Cap:	0.39	0.39	0.00	0.00	0.43	0.43	0.00	0.00	0.00	0.36	0.35	0.43
Delay/Veh:	4.9	4.9	0.0	0.0	5.3	5.3	0.0	0.0	0.0	43.0	42.6	43.4
User DelAdj:	1.00	1.00	1.00	1.00	1.00	1.00	1.00	1.00	1.00	1.00	1.00	1.00
AdjDel/Veh:	4.9	4.9	0.0	0.0	5.3	5.3	0.0	0.0	0.0	43.0	42.6	43.4
LOS by Move:	A	A	A	A	A	A	A	A	A	D	D	D
HCM2k95thQ:	13	13	0	0	15	15	0	0	0	8	8	10

Note: Queue reported is the number of cars per lane.

BART Phase II Extension Project

Level Of Service Computation Report
 2000 HCM Operations (Future Volume Alternative)
 PM - 2035 SC West Project Conditions

Intersection #5444: Lafayette/Lewis

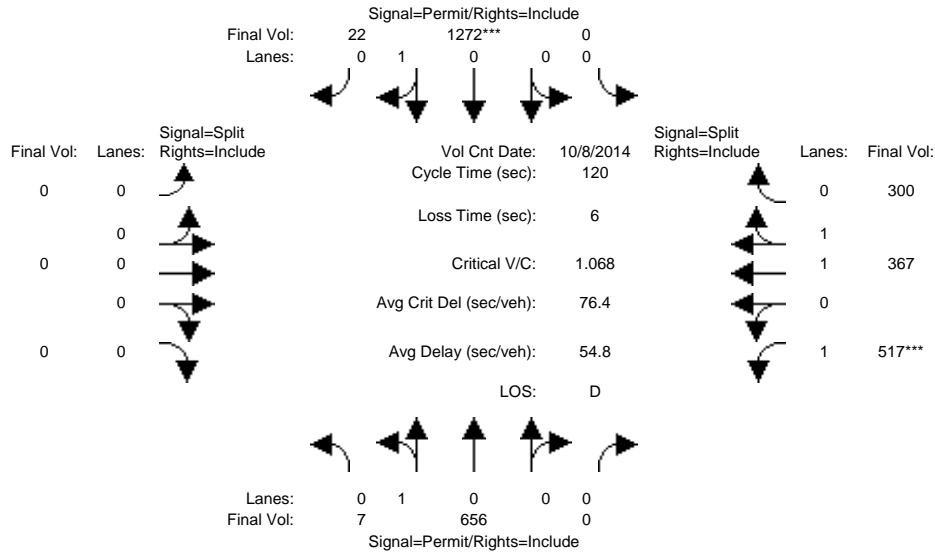

Approach:	North Bound			South Bound			East Bound			West Bound			
Movement:	L	T	R	L	T	R	L	T	R	L	T	R	
Min. Green:	10	10	0	0	10	10	0	0	0	10	10	10	
Y+R:	4.0	4.0	4.0	4.0	4.0	4.0	4.0	4.0	4.0	4.0	4.0	4.0	
Volume Module: >> Count Date: 8 Oct 2014 <<													
Base Vol:	7	656	0	0	1272	22	0	0	0	517	367	300	
Growth Adj:	1.00	1.00	1.00	1.00	1.00	1.00	1.00	1.00	1.00	1.00	1.00	1.00	
Initial Bse:	7	656	0	0	1272	22	0	0	0	517	367	300	
Added Vol:	0	0	0	0	0	0	0	0	0	0	0	0	
PasserByVol:	0	0	0	0	0	0	0	0	0	0	0	0	
Initial Fut:	7	656	0	0	1272	22	0	0	0	517	367	300	
User Adj:	1.00	1.00	1.00	1.00	1.00	1.00	1.00	1.00	1.00	1.00	1.00	1.00	
PHF Adj:	1.00	1.00	1.00	1.00	1.00	1.00	1.00	1.00	1.00	1.00	1.00	1.00	
PHF Volume:	7	656	0	0	1272	22	0	0	0	517	367	300	
Reduct Vol:	0	0	0	0	0	0	0	0	0	0	0	0	
Reduced Vol:	7	656	0	0	1272	22	0	0	0	517	367	300	
PCE Adj:	1.00	1.00	1.00	1.00	1.00	1.00	1.00	1.00	1.00	1.00	1.00	1.00	
MLF Adj:	1.00	1.00	1.00	1.00	1.00	1.00	1.00	1.00	1.00	1.00	1.00	1.00	
FinalVolume:	7	656	0	0	1272	22	0	0	0	517	367	300	
Saturation Flow Module:													
Sat/Lane:	1900	1900	1900	1900	1900	1900	1900	1900	1900	1900	1900	1900	
Adjustment:	0.95	0.95	0.92	0.92	0.95	0.95	0.92	1.00	0.92	0.92	1.00	0.95	
Lanes:	0.01	0.99	0.00	0.00	0.98	0.02	0.00	0.00	0.00	1.00	1.08	0.92	
Final Sat.:	19	1781	0	0	1769	31	0	0	0	1750	2035	1663	
Capacity Analysis Module:													
Vol/Sat:	0.37	0.37	0.00	0.00	0.72	0.72	0.00	0.00	0.00	0.30	0.18	0.18	
Crit Moves:							****						
Green Time:	80.8	80.8	0.0	0.0	80.8	80.8	0.0	0.0	0.0	33.2	33.2	33.2	
Volume/Cap:	0.55	0.55	0.00	0.00	1.07	1.07	0.00	0.00	0.00	1.07	0.65	0.65	
Delay/Veh:	10.7	10.7	0.0	0.0	65.6	65.6	0.0	0.0	0.0	103.6	39.8	39.8	
User DelAdj:	1.00	1.00	1.00	1.00	1.00	1.00	1.00	1.00	1.00	1.00	1.00	1.00	
AdjDel/Veh:	10.7	10.7	0.0	0.0	65.6	65.6	0.0	0.0	0.0	103.6	39.8	39.8	
LOS by Move:	B	B	A	A	E	E	A	A	A	F	D	D	
HCM2k95thQ:	23	23	0	0	95	95	0	0	0	48	21	21	

Note: Queue reported is the number of cars per lane.