

# 9 BIKE PATHS AND BIKE BRIDGES

## 9.1 BIKE PATHS AND TRANSPORTATION ISSUES

### 9.1.1 Terminology

The HDM uses the terms “Class 1 Bikeway” and “Bike Path” to describe a bikeway that “Provides a completely separated right of way for the exclusive use of bicycles and pedestrians with cross flow minimized”. AASHTO adopted the term “Shared Use Path” in 1999, in recognition that virtually all bike paths are also used by pedestrians of all shapes and sizes and other modes legally defined as pedestrians: joggers, roller-bladers, parents with baby strollers, people walking their dogs, non-motorized scooters and skateboards and of course the disabled. Terms such as “trail”, “off-street bikeway”, “greenway”, “multiuse trail” or combinations of these and other words also refer to bike paths in some if not most cases. This chapter uses the terms “trail” and “path” interchangeably, and assumes that multiple user-types are to be accommodated.

### 9.1.2 Pertinent Design Manuals

The primary design standards for bike paths in California are HDM Chapter 1000 and AASHTO Guide. In addition, two local references will be very useful to designers:

- *Countywide Trails Master Plan Update and the Uniform Inter-jurisdictional Trail Design, Use, and Management Guidelines* (TDMG) Santa Clara County Parks and Recreation Department, 1999.
- *Trail Planning for California Communities* Julie Bondurant and Laura Thompson, September 2009, by Solano Press.

The designer is encouraged to reference the aforementioned manuals for most design details. Two typical cross sections are presented in this chapter in order to incorporate the best practices of several manuals in one illustration. See also Section 1.3.3.

See Table 4-1 on page 4-3 for recommended frequencies of various trail maintenance activities.

### IN THIS CHAPTER:

- 9.1 *Bike Paths and Transportation Issues*
- 9.2 *Trail/Roadway Intersections*
- 9.3 *Bicycle/Pedestrian Across Barrier Connections*
- 9.4 *Bollards and Preventing Motor Vehicle Access to Bike Paths*
- 9.5 *Rural Roadside Paths*
- 9.6 *Median Bike Paths*

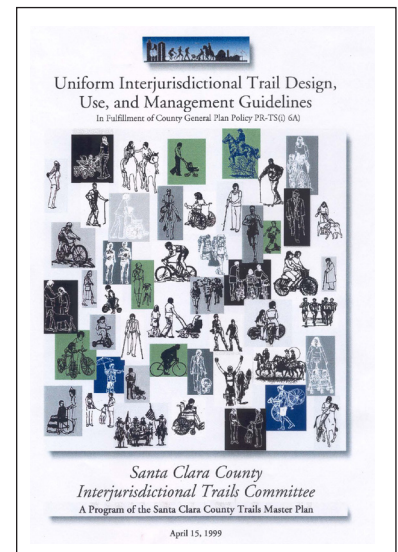

▶ See also PTG  
Section 4.2.B and Table 4.1

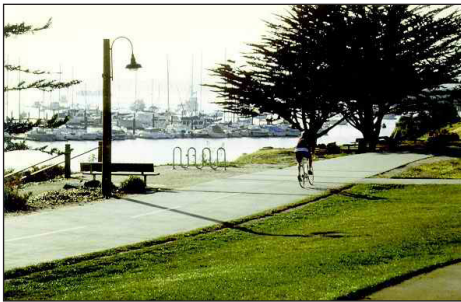

Light fixtures add an aesthetic and artistic element in addition to the obvious safety and usability elements.

**NOTE**

VTA views bike paths as part of an integrated, multimodal, countywide and regional transportation system consistent with the TEA-21 federal mandate “to develop transportation facilities that will function as an inter-modal transportation system”.

The responsible department for maintaining and operating a bike path varies from Public Works to Parks and Recreation to special districts. The issues faced by the various trail operators in keeping trails open 24 hours a day are discussed in the inset on Page 9-4.

**9.1.3 Bike Path Hours and Lighting**

**Bike Path Hours**

Bike paths that are used for transportation, (i.e. virtually all paved trails and many unpaved trails) should be open 24 hours a day just as roads are.

In addition, many transportation funding sources consider a bike path that is closed at night to be a recreational facility and therefore not eligible for funding.

**Bike Path Lighting**

**Discussion**

Optimally, bike paths should be lit at night year-round to increase safety and to maximize the number of trips made by bicycle. Cost and other inhibiting factors may place limits on the feasibility of trail lighting; see discussion in inset “Issues Facing Bike Path Operators and Bike Path Users”. If lighting is provided, special attention should be given to the design and placement of lighting on bike paths located within environmentally sensitive areas and near residential areas.

For some bike paths or trail segments, however, lighting may not be appropriate or allowed within sensitive wildlife habitat areas. In these locations, it may be worthwhile installing signs to remind bicyclists to ride with a light at night.

See the design manuals listed in Section 9.1.2 for more detailed guidance on the design of lighting; the guidance in the HDM and AASHTO Bike Guide are summarized on the next page.

**VTA Best Practice**

Where costs or other considerations might limit the hours of lighting, special consideration should be given to, at a minimum, lighting bike paths during standard commute hours during the winter months when it is dark before 8:00 am and after 5:00 pm.

Lighting is an important safety measure to provide at the intersections of bike paths with surface streets; at night. Lighting should be provided in underpasses and tunnels in the daytime as well as after dark.

Where used, lighting should be pedestrian and bicycle-scale and should meet the following criteria:

- No uplighting from any light fixture.
- All light fixtures should include shrouds (either fixed or adjustable), louvers, other shielding, or be directed in such a way as

to block direct light from all sensitive receptors (e.g. residences, wildlife habitat areas) adjacent or in close proximity to the trail.

- Stray light should be controlled through use of low-brightness fixtures with optical lens or reflector controls.

### **Caltrans Standard**

HDM- Chapter 1000

*Lighting 1003.1 (17) Lighting. Fixed-source lighting raises awareness of conflicts along paths and at intersections. In addition, lighting allows the bicyclist to see the bicycle path direction, surface conditions, and obstacles. Lighting for bicycle paths is important and should be considered where nighttime use is not prohibited, in sag curves (see Index 201.5), at highway intersections, and at locations where nighttime security could be a problem and where obstacles deter unauthorized vehicle entry to bicycle paths. Daytime lighting should also be considered through underpasses or tunnels.*

*Depending on the location, average maintained horizontal illumination levels of 5 lux to 22 lux should be considered. Where special security problems exist, higher illumination levels may be considered. Light standards (poles) should meet the recommended horizontal and vertical clearances. Luminaires and standards should be at a scale appropriate for a pedestrian or bicycle path.*

### **AASHTO Standard**

The AASHTO Bike Guide offers the following additional guidance.

*Pedestrian scale lighting is characterized by shorter light poles (standards about 15 ft high), ...closer spacing of standard (to avoid dark zones between luminaires), and high pressure sodium vapor or metal halide lamps. Metal halide lamps produce better color rendition (“white light”) than sodium vapor lamps, and can facilitate user recognition in areas with high volumes of night use.*

### **NOTE**

AB478 in 2007 expanded the requirement for bicyclists to use lights at night to include sidewalks and bike paths. CVC now states:

“A bicycle operated during darkness upon a highway, a sidewalk where bicycle operation is not prohibited by the local jurisdiction, or a bikeway, as defined in Section 890.4 of the Streets and Highways Code, shall be equipped with all of the following:

(1) A lamp emitting a white light that, while the bicycle is in motion, illuminates the highway, sidewalk, or bikeway in front of the bicyclist and is visible from a distance of 300 feet in front and from the sides of the bicycle.

(2) A red reflector on the rear that shall be visible from a distance of 500 feet to the rear when directly in front of lawful upper beams of headlamps on a motor vehicle.”

Source: California Vehicle Code-Division 11, Chapter 1, Article 4, Section 21201 (d)

## Potential Issues Related to 24 hour Access on Bike Paths

The information presented below is intended to outline the concerns and potential issues that bike path users and operators may face by allowing or not allowing extended access to bike paths for the full 24-hour day. VTA hopes that by identifying these issues and concerns and by opening a dialog, Member Agencies, VTA and other interested agencies, advocates and stakeholders can work together to resolve the concerns regarding 24-hour use of bike paths.

The BTG, as guidelines, does not require changes to existing bike paths or to the policies of a respective department or agency. However, VTA and the at-large bicycle community maintain that more bicycle trips will occur if bike paths are more fully integrated with the on-street bicycle and roadway system and are accessible at all times as are roadways and sidewalks. The concomitant benefits of more bicycle trips include improved air quality and public health, and reductions in green house gasses, global warming, and roadway congestion. Moreover, there are social justice and economic equity issues related to access to affordable transportation that argue for 24-hour access to bike paths, especially considering that many lower-income members of the community use bicycles as their primary mode of transportation, and temporal exclusion of access to key transportation corridors may have significant safety or quality of life implications and cause hardships to these groups.

### Trail Manager Issues Related to Providing 24-Hour Access to Bike Paths

- **Environmental and Regulatory Setting:**

There may be legal, environmental, regulatory, permitting or other issues related to the development of a particular bike path, bike path segment, or bike path extent that create conditions where 24-hour access may not be feasible or desirable. One intended purpose

of the Bicycle Technical Guidelines (BTG) is to provide information and tools to both users and operators that may allow the conditions to be addressed and improved over time.

- **Policies and Guidelines:** It is understood that some jurisdictions have policies and/or guidelines that limit access to bicycle trails that reside within parks or at certain locations. These policies and/or guidelines should undergo periodic review and reconsideration as local agencies develop and revise plans and ordinances.
- **Availability of Resources:** There are staffing costs associated with patrolling bike paths both if they are open and if they are closed at night. However having the trail open for 24-hour access may involve the need for additional staff and/or operating and maintenance funds. Several jurisdictions in Santa Clara County have expressed a desire to continue this dialog internally and with neighboring jurisdictions and VTA; the BTG is intended to function as a reference tool and a technical resource document in these discussions. In addition, there may be opportunities for partnerships to share resources. For example, some cities have created win-win situations by allowing police officers either in patrol cars, motorcycle, or bicycles - or a combination of all three - to use bike paths and bike bridges as a way to increase the range and response time of the police officers to calls in all areas, as well as to provide patrols of the trail itself.
- **Potential Liability:** Potential liability may exist whether a bike path is open or closed at night. VTA encourages each jurisdiction to work with its residential and business community, and with bicycle advocacy groups to identify and work to resolve bike-path-related liability issues in order to provide access and maximize use.

### **Issues Related to Closing Bike Paths at Night**

- **Inconsistent Hours:** *A bike path that travels through many jurisdictions is potentially subject to several different sets of “hours” such that a bike commuter could cross the city limit(s) on the way home from work and could enter another jurisdiction after its park had closed and thus be in violation of that jurisdiction’s ordinances.*
- **Multimodal access:** *Bicyclists who also use transit may expect trails to be open after dark in coordination with the hours of service offered by buses or light rail. (Most VTA lines operate 13 to 18 hours per day).*
- **Direct Routing and Safety:** *The trails system can, and often does, provide a more direct and safer route than the roadway network. Restrictions on hours of operation would direct cyclists and pedestrians onto alternative routes of travel at night that could result in additional travel time or less safe conditions.*
- **Connectivity:** *Ideally, the trails system would be seamlessly interconnected with the rest of the valley’s transportation system. The BTG is designed to facilitate movement toward this goal by providing best practices on planning, design, and operation of these facilities.*
- **Potential Liability:** *As discussed above, potential liability may exist whether a bike path is open or closed at night.*
- **Availability of Resources:** *As discussed above, there are staffing costs associated with patrolling bike paths both if they are open and if they are closed at night. Closing trails also involves staff time if an agency expects to successfully enforce any such ordinance.*

### **Issues Related to Lighting Bike Paths at Night**

*While appreciated by most bicyclists who must bicycle after-dark, lighting bike paths is not always feasible. State and Federal environmental laws prohibit lighting of riparian corridors as it can impact many nocturnal species. Addressing this issue is beyond the control of one local agency, and as a result, may be a long-term challenge for installation of lighting. The provision of lighting in any form (i.e., type, intensity, hours of lighting, etc.) should be carefully evaluated for each location. For example, some trails may pass through sensitive habitat areas that should remain dark at night; or the funds to construct and/or operate lighting may simply not be available.*

*It should be noted that, since 2007, the CVC 21201(d) requires bicyclists to use lights and reflectors when riding on all bikeways and sidewalks as well as roadways at night.*

### **Trail Safety**

*All of the issues above have some bearing on the issue of trail safety. Ordinances requiring bicyclists (and pedestrians) to use lights at night, restricting use of the trail to transportation purposes or to commuters with lights, implementing teen curfews, prohibiting loitering or vagrancy, and/or providing call-boxes have all been used by Member Agencies and other agencies in California to address safety issues. Moreover, a “closed” facility, with no eyes-on-the-trail may be more attractive to vagrants and loiterers than one that is open and used by cyclists (and/or pedestrians). Although most bicyclists and pedestrians, including wheelchair-bound pedestrians, and pedestrians using mobility devices, would feel safer traveling on trails with adequate lighting, the ultimate decision in where to travel is up to the individual.*

Americans with Disability Act (ADA) Note:

Compliance for the Physically Handicapped

Exception. When the grade differential of the walking surface of a pedestrian grade separation exceeds 14 feet due to required height clearance and grade conditions, and the enforcing agency finds that because of right-of-way restrictions, topography or other natural barriers, wheelchair accessibility or equivalent facilitation would create an unreasonable hardship, such accessibility need not be provided.

Source: Pedestrian Grade Separations, Memo to Designers, Caltrans June 1989

### 9.1.4 Typical Cross Section For a Transportation Bike Path

For transportation bicycling, the key is to accommodate the variety of users on a typical bike path; the variety of users essentially boils down to 4 types: fast bicyclists, slow bicyclists, fast pedestrians and slow pedestrians. A one-size-fits-all approach will not work; site constraints and right of way constraints often dictate less than optimal cross sections.

Typically 25 feet of right of way is required to accommodate the trail tread, and the required graded shoulders, signage, landscaping and offsets. The typical allocation of widths for the various components are illustrated in Figure 9-1.

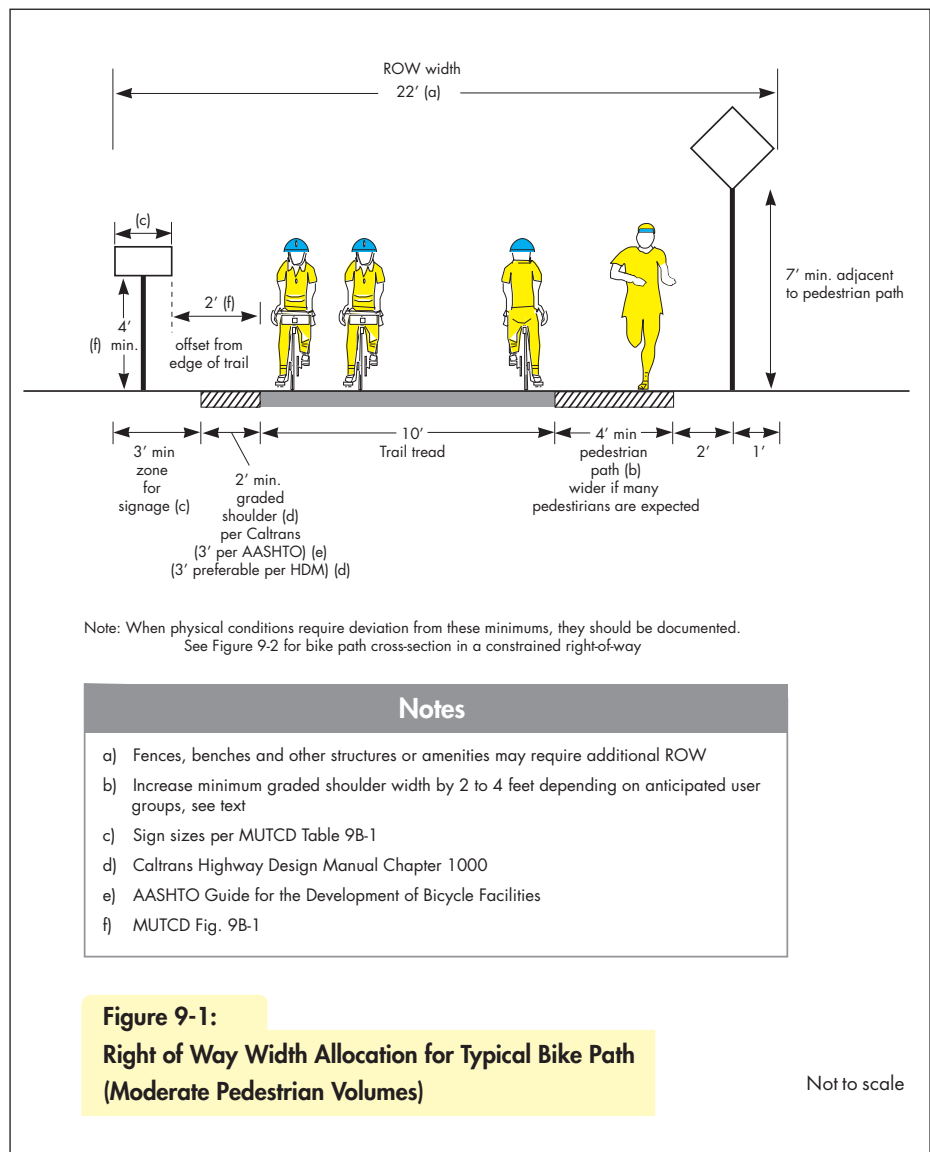

**Cross Section In Constrained Right of Way**

Occasionally a bike path is forced to be contained within a restricted right of way. This situation is illustrated in Figure 9-2.

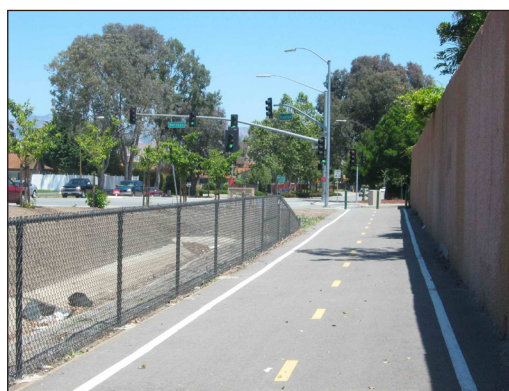
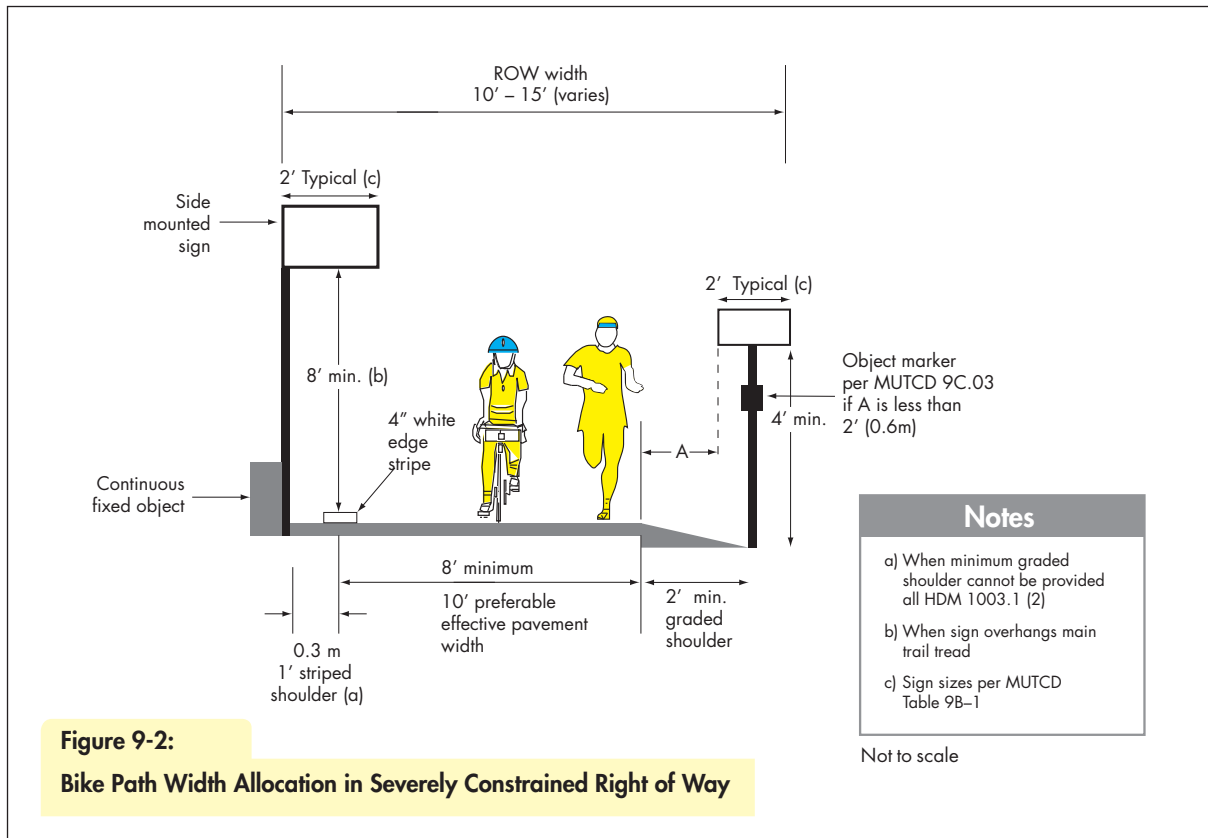

The S.R. 87 bike path is constrained by the physical environment yet still provides invaluable connections for nonmotorized travelers.

**TECH TIP**

The following elements should be included at the intersection of a bike path with a roadway:

- Lighting
- Ramp design
- Signage (including street name signs)
- Pavement markings
- Crossroad width and posted speed
- Traffic control and right-of-way



*Bike path roundabout in Davis CA.*



*Guadalupe River Trail, with its numerous undercrossings, is essentially a bicycle "freeway".*

**9.2 TRAIL/ROADWAY INTERSECTIONS****9.2.1 Intersection Design Issues**

Many design elements contribute to creating a safe intersection of a trail and a roadway; See sidebar.

The inventory checklist presented in Appendix E can help evaluate how to improve an existing intersection. Traffic control and right-of-way are discussed in more detail below in Section 9.2.2.

See also TDMG Policy UD-4.17; and Figures T-12A, T-12B, T-13A and T-14.

**9.2.2 Traffic Control and Right-of-Way at Trail Intersections**

The type of traffic control device to use at the intersection of a trail with a roadway depends on the total and relative volumes on the roadway and on the trail. Generally speaking, when a trail intersects another trail, the best way to design the intersection is with a mini roundabout.

Figure 9-3 depicts the various ways of assigning right-of-way at an intersection of a trail and a roadway. Figure 9-4 is an illustration of which method is appropriate given the relative volumes on a road and a trail.

In general, when a trail intersects a driveway, a private road or a low volume road, if sight distance is adequate, a YIELD control can be appropriate. If sight distance is not adequate, a STOP sign should be installed. If the trail volume is higher than the cross-traffic, the trail is given the right-of-way.

When a trail intersects a typical local or collector street, the right-of-way typically goes to the roadway. If, however, the trail has the higher volumes, consider assigning right-of-way to the trail as if it were the intersection of two roads. If sight distance is adequate, a YIELD sign can be used in lieu of a STOP sign as described in the MUTCD. As the volume on the roadway increases and becomes more difficult to cross, consider a median refuge and/or in-pavement flashing lights.

When a trail intersects an arterial, the pedestrian signal warrants in the MUTCD can help to assess the need for a signal. All trail users are included in the pedestrian volume.

An overcrossing/undercrossing of the arterial should be considered if trail volumes are very high and/or the arterial volumes are high enough that trail users benefit from reduced delay and so that progression is maintained on the arterial. When trails have no or few at-grade crossings with roads, they function almost as bicycle freeways where travel is uninterrupted by stop signs and traffic signals.



TRAFFIC CONTROL AT INTERSECTIONS  
Summary

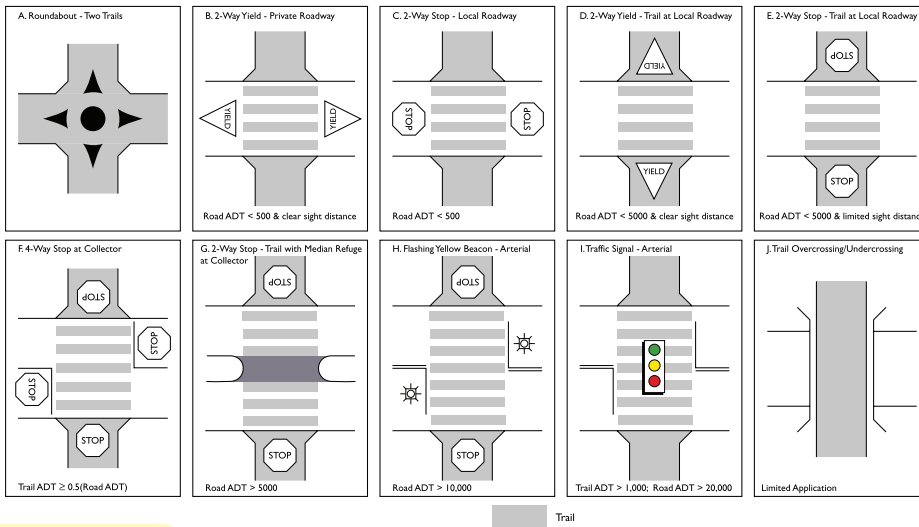

**TECH TIP**

Roundabouts have been successfully used at trail intersections on the UC Davis campus for decades. The number of collisions between cyclists and pedestrians significantly decreased upon switching from stop sign controls to a modern roundabout.

**Figure 9-3:**  
**Traffic Control Options at Trail Intersections**

Source: Contra Costa County Trail Design Resource Handbook March 2001

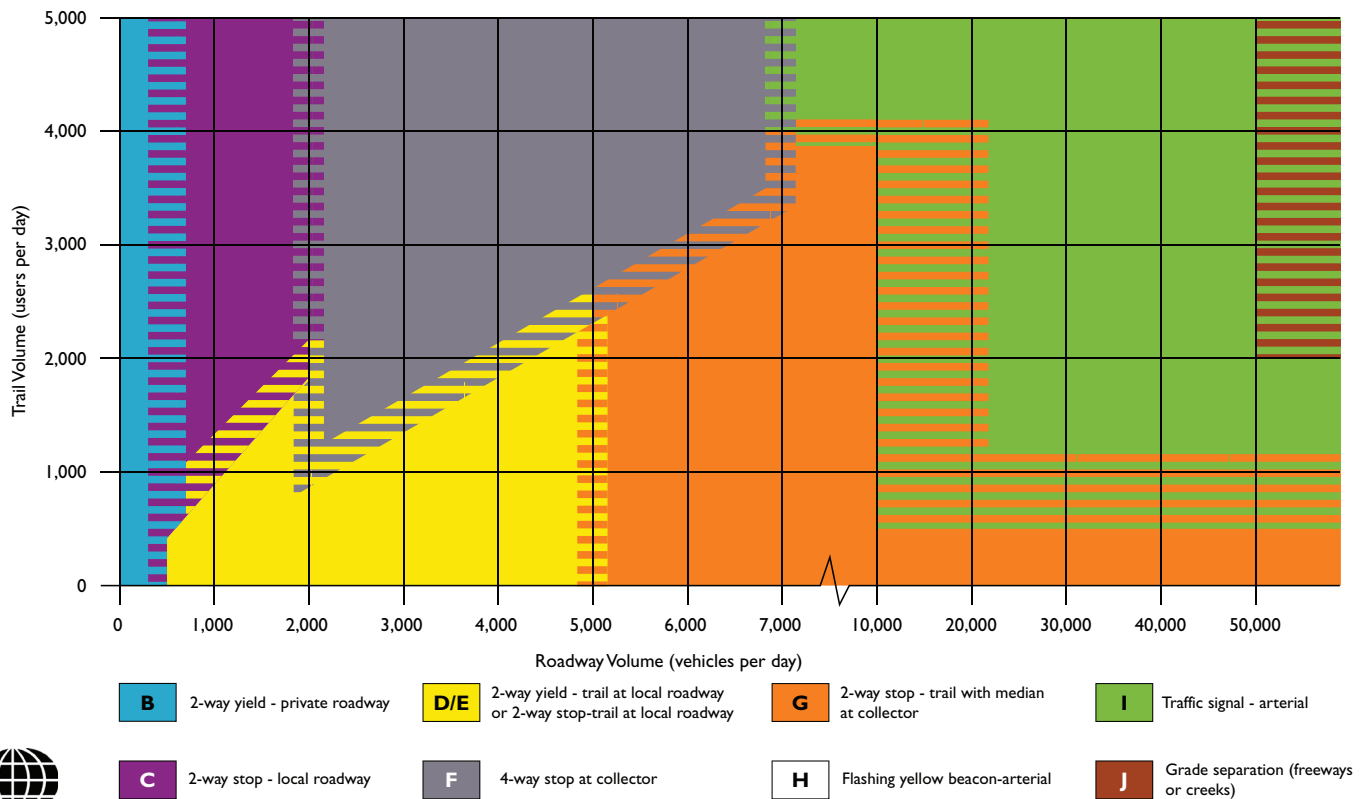

**Figure 9-4:**  
**Guidelines for Traffic Control Devices at Trail Intersections**

Source: Contra Costa County Trail Design Resource Handbook March 2001

**NOTE**

On bridges in scenic locations, belvederes can increase capacity as well as enhance the recreational experience.



*River Oaks Pedestrian/Bicycle Bridge over the Guadalupe River, opened May 2006, funded by 1996 Measure B.*



*San Antonio Station Pedestrian/Bicycle Undercrossing of Caltrain tracks, Mountain View, opened 1988.*

**9.3 BICYCLE/PEDESTRIAN ACROSS BARRIER CONNECTIONS (ABC'S) (BRIDGES/UNDERPASSES)**

**9.3.1 Terminology**

When a bike path or roadway crosses over a freeway, railroad, creek or river, it is referred to as a bridge or overpass; when it goes under, it is referred to as a tunnel or underpass. In the case of a railroad right-of-way, the crossing can also be an at-grade crossing. To refer collectively to these three types of crossings-overpass, underpass or railroad at-grade crossing, and also to future crossings where it is unknown what the facility will be, the term Across Barrier Connection (ABC) will be used.

**9.3.2 Pertinent Design Manuals**

The primary design standards for bike bridges and tunnels in California are Caltrans HDM Section 208, Caltrans *Bridge Design Specifications*, and AASHTO *Guide Specifications for Design of Pedestrian Bridges*, August 1997. Additional guidance is found in HDM Chapter 1000 and AASHTO Bike Guide.

**Innovations: Separation of Users**

If an ABC has extremely high use by pedestrians and bicyclists; consider design cues to separate users as depicted below.



*Stone Arch Bridge, Minneapolis, MN*



*University Avenue Bike Bridge, Berkeley, CA*

**9.3.3 Clear Width**

**Caltrans Standard**

1003.1(2) Clearance to Obstructions

*The clear width of a bicycle path on structures between railings shall be not less than 10 feet. It is desirable that the clear width of structures be equal to the minimum clear width of the path plus shoulders (i.e., 14 feet)*

**VTA Best Practice**

In practice it is acknowledged that pedestrian and bike ABC’s fill a variety of functions within the transportation system, thus will vary immensely in the number of users and mix of users. A one-size-fits-all approach is not recommended. A bridge over a small creek serving as a neighborhood connection like Adobe Creek in Los Altos can be narrower than an underpass of the railroad tracks that serves regional attractors and is the only way for bicyclists and pedestrians to cross safely for miles, e.g. Lawrence Ave Caltrain station undercrossing at 22’ wide and the future Santa Clara Station Caltrain undercrossing.

A clear width of 16’ -20’ is optimum where bridge has extremely high use by pedestrians and bicyclists; Consider design cues to separate users as depicted in Photo 1 and Photo 2 on facing page

A clear width of 8’ - 12’ is appropriate where bridge is a local neighborhood connector bridge and/or there are site constraints.



*Homer Avenue undercrossing of Caltrain tracks, in Palo Alto.*

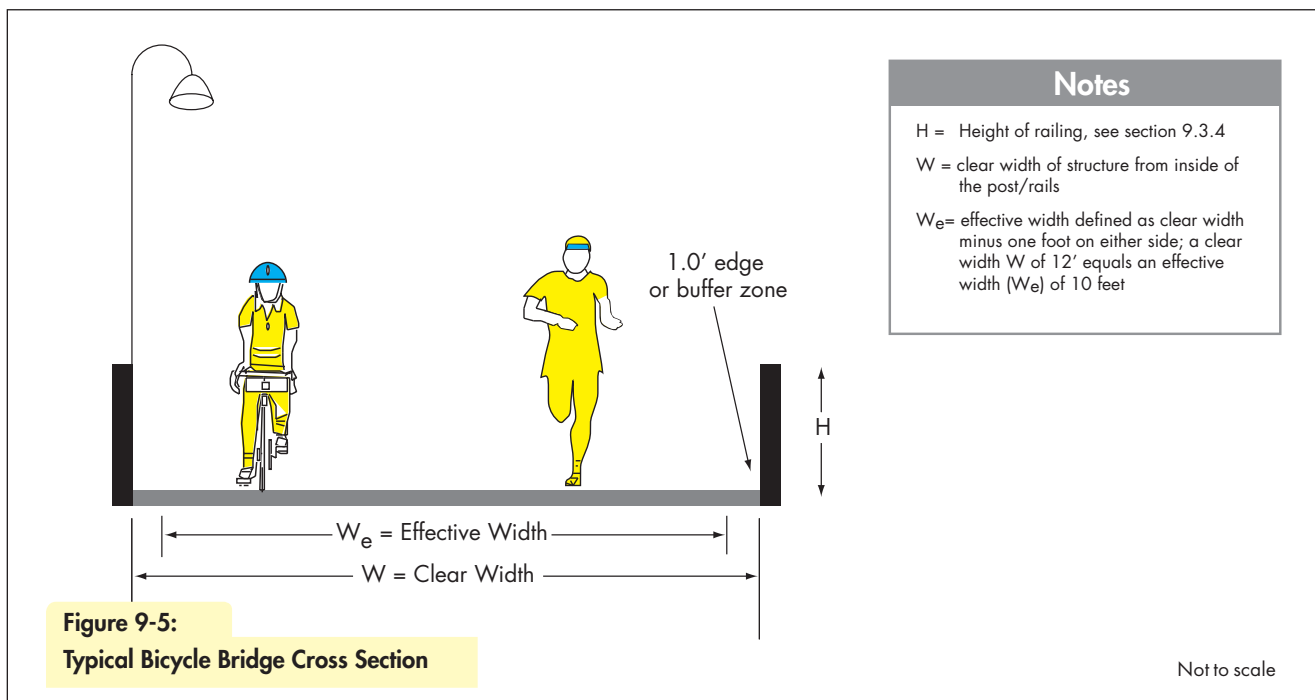



Railing between San Tomas Aquino Trail and sloped embankment to San Tomas Aquino Creek.

**TECH TIP**

On a pedestrian/ bicycle only bridge, the clear opening between elements shall be such that a 6 inch sphere shall not pass through; this applies to the lower 27 inches; above 27 inches, the minimum can be 8 inches. Source: Caltrans Bridge Design Specifications §2.7.2.2.2.



So many people crowded onto the Golden Gate Bridge during its 50th anniversary celebration in 1987 that it created the heaviest load the bridge had experienced to-date and its slight upward arch actually flattened under the weight; deflection is perfectly normal for any suspension bridge and this did not exceed the load capacity of the bridge.

SF Chronicle file photo by John O'Hara

**9.3.4 Bridge Railing Height**

**Caltrans Standard - Bridges and Grade Separation Structures**

HDM § 208.10(6) Bicycle Railing

*The minimum height of bicycle rail in certain circumstances is 48 inches; however, in most situations 42 inches above the deck surface is appropriate. Contact DES, Office of Design and Technical Services for more information. Pedestrian railings and combination railings consisting of a concrete barrier surmounted by a fence or tubular railing are satisfactory for bicycles, if a minimum 42-inch height is met.*

**VTA Best Practice**

If, due to the geometry and grade, bicyclists can approach the bridge at speeds to 30 mph and/or angle  $\geq 25$  degrees, then a rail height of 48 inches or more should be considered, as discussed in the NCHRP study; see inset on page 9-13.

For railing heights on roadway bridges with pedestrian and bicycle access, see Section 3.1.5.

**Bicycle Railing-Other Applications**

A bicycle railing can be used on a bike path as physical barrier as an alternative to dense shrubs or a fence. Rails should be placed on the outside of the graded shoulder, otherwise the effective width of the path is reduced. Typical locations where a railing might be used are:

- Bike path adjacent to parallel highways less than five feet from edge of shoulder; (HDM §1003.1(6)).
- On highway bridges, with a two-way bike path on one side of bridge: railing height between traffic lane and bikeways should be 46 inches min. (See Table 3-2).
- Between the edge of pavement and top of a slope, depending on the height of the embankment and the conditions at the bottom of the slope.

**Section 9.3.5 Bridge Ramps and Stairs**

Ramps leading to bridges are the most cost-effective way to provide ADA access to the over or undercrossing. ADA criteria govern the slope. Ramp widths should have a minimum width of 8 to 10 feet, given the variety of users expected. Stair channels on stairs are very useful for bicyclists to aid them in carrying bicycles up the stairs.

### 9.3.6 Bridge Live Load

Bike bridges live loads should allow for the passage of an occasional maintenance/service vehicle. Also, depending on the emergency service providers' routes, a bike bridge might be designed to accommodate an occasional ambulance or other emergency vehicle.

### 9.3.7 Vibrations

Considering that all bike bridges will also be open to pedestrians, the bridge performance should consider the vibrations caused by runners and walkers. See *Guide Specifications for the Design of Pedestrian Bridges*, Section 1.3.2, August 1997.

## Discussion on Railing Height

*The primary purpose of a bicycle rail is to protect bicyclists from a hazard on the other side; the height is critical so that bicyclists do not fall over the rail should they strike it. The rail height to keep a bicyclist from falling over it will depend on site-specific conditions including speed of travel, direction of travel relative to the railing and the angle of the collision between the biker and the rail. Also, the type of bicycle and the height of the bicyclist will affect the center of gravity and therefore the rail height necessary to prevent vaulting or falling over the railing.*

*Since Caltrans and AASHTO had different minimum railing height standards, in 2006 Caltrans conducted research to determine appropriate bridge rail heights for bicycles. The "Bicycle Trail Impact Study", 2008, modeled three types of bicycles (road, hybrid, and mountain), as well as variations in a bicyclist's center of gravity to determine the effects of hitting a bridge rail at different speeds and angles. This followed a NCHRP study "Determination of Appropriate Railing Heights for Bicyclists", July 2004. Both studies concluded that locations on curves where cyclists can attain high speeds need higher railings than locations where cyclists are traveling parallel to the rail and would not travel fast. Another consideration is the degree of hazard faced when falling over the edge, e.g. a precipitous drop versus falling onto a grassy slope. Caltrans bridge design guidance documents now recommend a 42-inch bridge bicycle rail for locations where the combination of high speeds and high impact angles are not likely. For site conditions where this combination is likely, a minimum height of 48 inches is recommended.*

*The NCHRP study provides the following additional guidance for when to consider a 48-inch rail height. At locations where bicyclists should be protected from a severe hazard, such as:*

- *On the outside edge of a highway bridge.*
- *Between a bike path and travel lanes on a highway bridge where the biker may fall into the path of vehicular traffic (as opposed to a shoulder).*
- *A bikeway bridge with a drop of 2 feet or greater.*
- *Along a pathway where the railing protects from cliff, water body or other such hazard*

*The NCHRP study further recommended 54 inches at locations where bicyclists should be protected from a severe hazard (see above) and have a potential to vault over the railing as a result of a high speed angular collision, e.g.:*

- *Where the radius of curvature is not adequate for the design speed or attained speed and falling over the rail would subject biker to a severe hazard (cliff, water body, etc.).*
- *Where sight distance is inadequate and a biker could take evasive action and collide with a railing at a sharp angle.*
- *At the end of a long descent where speeds of bicyclists are higher.*

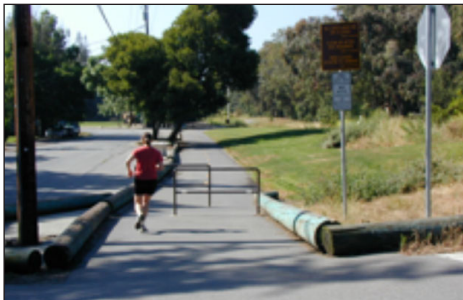

Gates such as this maze design are not recommended since they force all bicyclists to dismount and are often impossible for tandem bicycles and bicycles with trailers to pass through.



R5-3



R44A (CA)

Standard MUTCD signs for bike path entry. Minimum size R44A (CA) 12" by 24".

### 9.4 BOLLARDS AND PREVENTING MOTOR VEHICLE ACCESS TO BIKE PATHS

Trail managers are rightly concerned about unauthorized motor vehicles mistakenly or intentionally entering and using a bike path. As explained in HDM §1003.1(16), barrier configurations that prohibit motorcycles cause problems for bicyclists as well. Therefore it is not practical or possible to physically prohibit two-wheeled motorized vehicles without adversely impacting bicyclists.

#### VTA Best Practice

The best way of discouraging non-authorized motor vehicles is through design. Past solutions of installing bollards or other barrier treatments should be considered a last resort and only if there is a documented problem of encroachment by private cars.

#### 9.4.1 Optimal Bike Path Entry Design

Design elements that discourage and help prevent motorized vehicles from entering bike paths are:

1. Placemaking and entry signage
2. Prohibition signage (with associated fine for violations)
3. Ramps and bike path shoulders that look like a bike path, not a driveway
4. Split path entry into inbound and outbound lanes divided by a narrow median. This also has the added benefit of alerting cyclists about the intersection ahead and the need to slow down.

A typical recommended bike path entry design is presented in Figure 9-6.

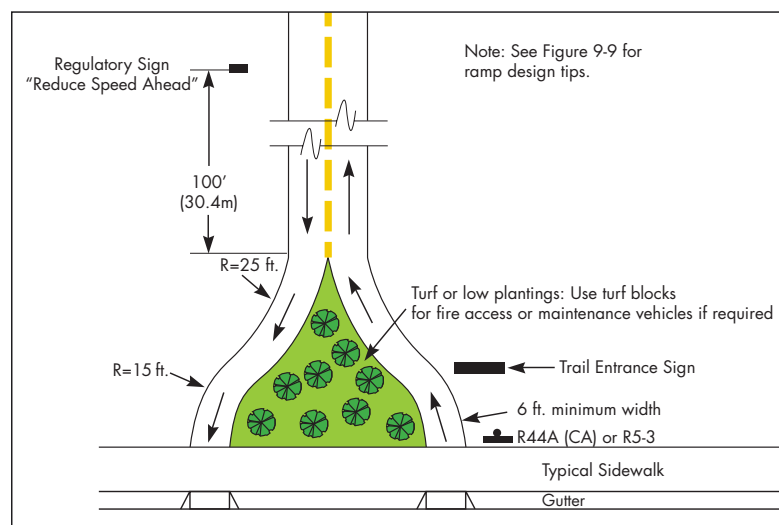

**Figure 9-6:**  
Optimal Path Entry Design to Discourage Motor Vehicle Entry

**9.4.2 Optimal Bollard Design and Layout**

Bollards should only be used where there has been a documented problem of abuse by motor vehicles on the bike path. If bollards are determined to be necessary to restrict cars and other motorized vehicles, then both bollard design and bollard placement must be addressed.

Often bike-path bollards are made of materials chosen for their aesthetic value. However bollards on bike paths are traffic control devices and must be retro-reflectorized for visibility and safety reasons.

**Caltrans Standard:**

Bollards must not be used to force bicyclists to slow down, stop or dismount.

Caltrans Standard: Bollard Design (HDM 1003.1(16))

- Foldable bollards shall not be used; they are often left in the down position, as shown in photo, which presents a crash hazard for bicyclists and pedestrians
- Removable bollards must leave a flush surface when removed;
- Bollards must be reflectorized for nighttime visibility and designed to maximize daytime visibility;

**VTA Best Practice: Bollard Design**

If used, the optimum bollard design is a flexible post channelizer shown in CA MUTCD Figure 3F-101 (CA), so that it will yield if struck by a bicyclist head-on or his handle bar, pedal or gear. It should be white with a yellow reflector as shown in Figure 9-7. It may be either surface mounted or attached to an anchor imbedded in the pavement.

If there is a location where flexible bollards have proven ineffective at keeping unauthorized motor vehicles from using the bike path, a hybrid design maybe used as shown in Figure 9-8.



Foldable bollard

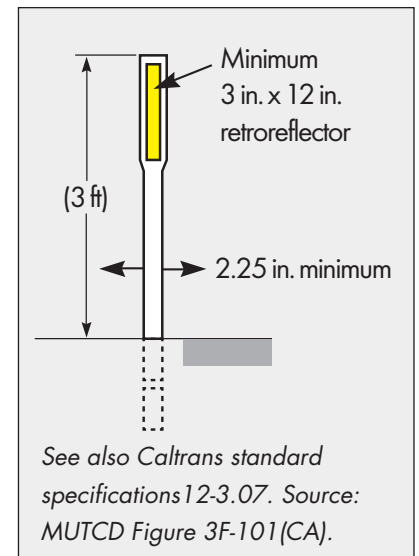
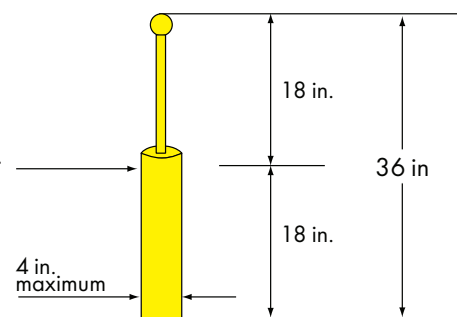

Figure 9-7:  
Preferred Bollard Design –Flexible Post Channelizer

Use permanently reflectorized material on all sides for night time visibility and light or bright-colored material for daytime visibility



**Notes**

**Optimally:**

1. The bollard segment above 18 inches is a flexible post in order to give way if stuck by handle bars.
2. The entire post is yellow to match the centerline of the path.

Figure 9-8:  
Bollard Design If Flexible Post Not Used

**Caltrans Standard: Bollard Placement**

1. Minimum clearance width of paved path are on either side of bollard = 5 feet measured from face of bollard; therefore typical path width at bollard = 10 feet four inches. (On centerline of path.)

**VTA Best Practice Bollard Placement**

The optimal layout and dimensions of a bike path entry with a bollard are shown below in Figure 9-9. Key issues are:

1. Place bollard no closer than 20 feet to the street so that bicyclists have enough reaction time to see and approach the obstacle and so that they can enter the narrowed opening at a non-skewed angle.
2. Place bollard no further than 40 feet from the street; otherwise it is ineffective at restricting motorist access. Also, any further up the path would be unexpected by bicyclists and other path users, and increases the potential for a crash.
3. Provide lighting of the area to improve visibility of the bollard.
4. One bollard placed on the centerline is usually sufficient to discourage motor vehicles from entering.
5. If more than one bollard is used:
  - path must be  $\geq 12$  ft.
  - one bollard shall be placed on the centerline, to clearly mark the path's two directions of travel
  - provide a minimum paved clear width of five feet between bollards to allow bicyclists with trailers or panniers to pass.

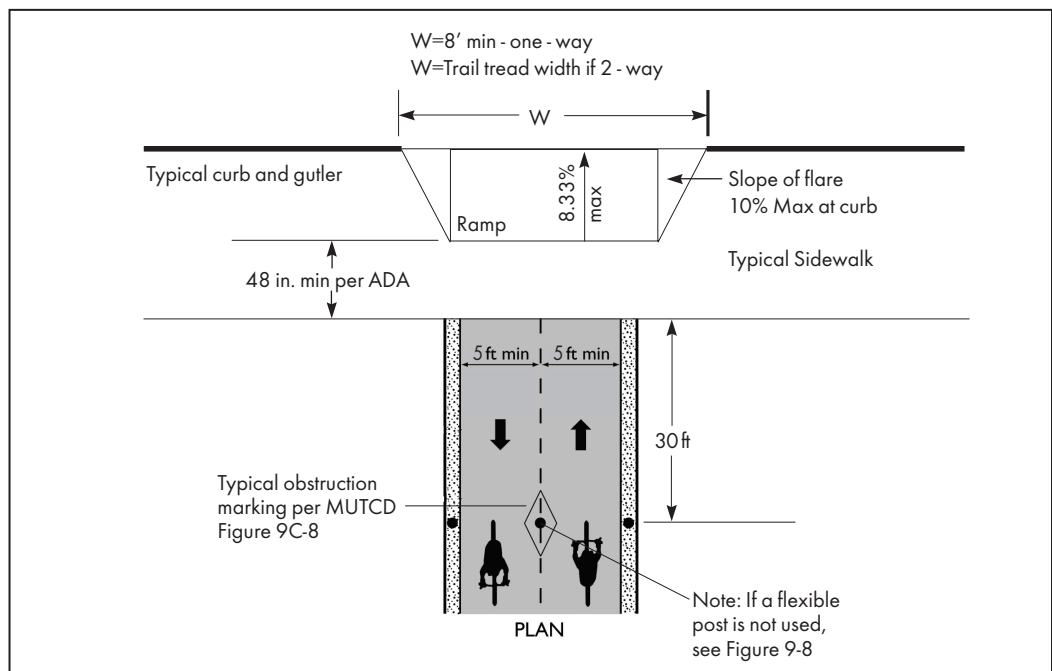

**Figure 9-9:**  
**Optimal Bollard Layout and Ramp Design**



## 9.5 RURAL ROADSIDE PATH

As discussed in Section 7.4, the two primary ways of accommodating pedestrians and bicycles in a rural or semi-rural context are on the shoulders or on a pathway separated from the road. In some contexts, both may be appropriate. Section 7.4 presents the discussion on shoulders and this section presents roadside paths.

Roadside paths are desirable where pedestrians and school-age bicyclists are expected on a daily basis. The semi-rural community of Los Altos Hills has a standard detail for a roadside path in lieu of sidewalks and / or wide shoulders. While faster and more experienced cyclists stay on the roadway, a path will be attractive to some casual cyclists and to child cyclists. It also provides a safe place for pedestrians of all ages and abilities; this has the positive side effect of improving conditions for the faster cyclists on the roadway, since pedestrians will no longer be forced to walk on the shoulder and edge of roadway where these cyclists are found.

In keeping with the rural ambience, many communities like Los Altos Hills choose a surface paving material that is semi-permeable yet hard packed, such as quarry crusher fines, so that it is usable during rainy weather and to meet ADA requirements. In California, the most common material is decomposed granite, while in Florida and other parts of the country (including a portion of the Palo Alto Baylands Trail), crushed oyster shells are used. This surface material is fine for bikes with “fat” or knobby tires, but cyclists on racing tires will prefer the roadway.

### **VTA Best Practice**

VTA’s recommended design for a roadside path is illustrated in Figure 9-10. Los Altos Hills’ standard details for a roadside path call for a width of 5 feet with 3% cross slope, and 2-foot minimum shoulder. This width is comfortable for two pedestrians walking side by side. To better accommodate two children on bikes, VTA recommends a 6-foot minimum width. This wider path also allows a bicyclist to pass a pedestrian at slow speeds; however, if significant pedestrian and bicycle traffic is anticipated and the topography is gentle, 8 feet is preferable. Optimally, such a path would be provided on both sides of the roadway, especially for the sake of bicyclists. The two paths could be signed as one-way for cyclists and two-way for pedestrians.

Given that the roadside path may not be built to Caltrans Highway Design Manual standards for a Class 1 Bike Path, it is best not to call it a bike path but rather a roadside path or pedestrian path on which bicyclists are permitted. This is not to say that a roadside path cannot be built to Class 1 Bike Path Standards, if right of way and topography allow.



*These children are walking home from school on a roadside path in Los Altos Hills.*



*This roadside path in Los Altos Hills is separated from the roadway by a guard rail within the horizontal curve.*

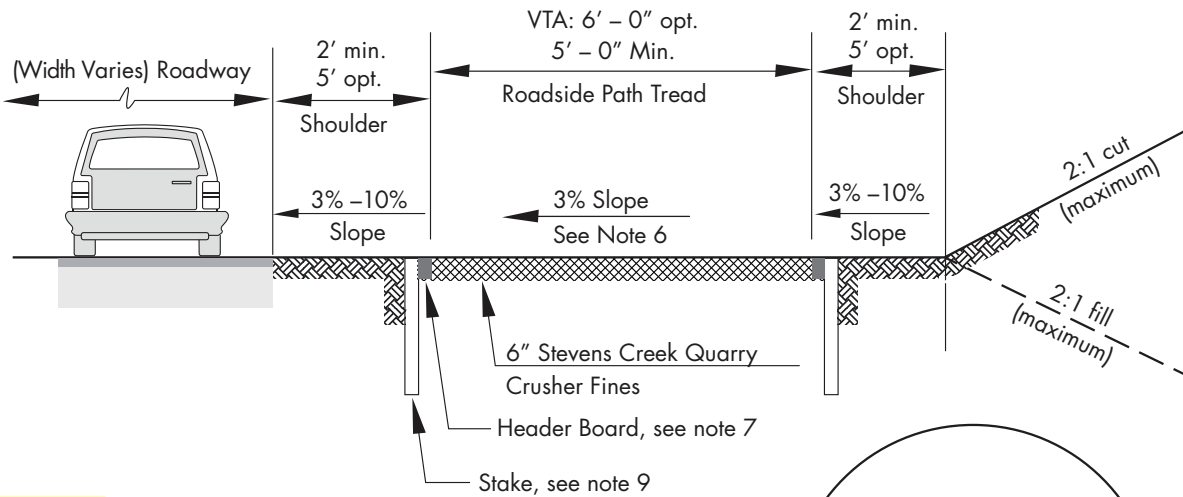

**Figure 9-10:**  
**Roadside Path with Bicycles Permitted**

**Notes**

1. Adapted from Los Altos Hills Standard Detail 24 "Roadside Path (Type2B)".
2. Pathway material and shoulders shall be compacted to 95% relative density.
3. Irrigation systems shall not be located closer than 3 feet to a pathway. No irrigation water may be directed toward or onto the pathway.
4. Trees and shrubs shall not be planted closer than 5 feet to a pathway. Ground cover may not be planted closer than 3 feet to a pathway. Path should route around existing native trees. Shrubs and ground cover with thorns, native and non-native, should be eradicated within 25 feet of the pathway.
5. No obstructions are permitted within the tread of the pathway, including but not limited to utility boxes, sign poles, utility poles, service meters, manholes, mailboxes, and fire hydrants. Pathways may meander as necessary to avoid existing obstructions. Preferred alignment is exactly parallel with the roadway.
6. 5% maximum if thought necessary by city engineer. Pathway and shoulder cross slopes shall drain toward or away from the adjacent road as approved by city engineer.
7. Header boards shall not project above the pathway or adjacent grades. Header boards shall be 2" by 6" redwood or pressure treated wood. Two 1" by 6" redwood headers may be used on curves.
8. Header boards may be omitted if immediately adjacent to a berm or curb.
9. Stakes shall be 2" by 4" and 2' long at 6' maximum spacing and at each splice. Connect stake to header with a minimum of 4-10d galvanized nails.

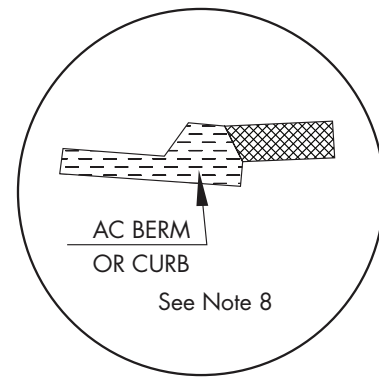

## 9.6 MEDIAN BIKE PATHS

Bike paths in medians are not typical in the United States because most roadway medians are not wide enough to accommodate a bike path that meets the design standards of this section. However, in some contexts, bike paths in medians can be an integral component of a bikeway network. Particularly in built-out areas, if wide medians are present, properly designed median bike paths can provide access and mobility to bicyclists while avoiding the edge of roadway conflicts that are present with shared-use lanes, bike lanes and side paths, namely, parked cars; weaving with buses; and conflicts with right-turns at every driveway and intersection. See photos on next page.

To be effective, a median bike path should have the following design elements as illustrated in Figure 9-11:

- Wide median (25 ft minimum to 60+ ft.)
- Separation between the travel lanes and the bike path as described in the HDM for side paths.
- Median bike paths on arterials: all cross streets with median breaks must be signal-controlled and the number of intersections should be minimized.
- Signalized intersections, should provide signal phases for the through bike movement on the median and the left-turning motor vehicles from the travel lanes by having protected left-turn phases for the highway and using Bicycle Signal Heads for the bicycle phase on the median (see CA MUTCD Part 4D.104(CA)). Alternatively left-turns from the roadway could be prohibited.
- Median bike paths on a low volume street or collector: cross streets with other low volume roads can remain unsignalized based on engineering judgment.

### NOTE

Cyclists on median bike paths do not face the typical side-of-road conflicts that bicyclists face when riding on the roadway:

- doorings from parked cars
- weaving with buses
- conflicts with motor vehicles making right turns and left turns at intersections
- conflicts with cars entering and exiting driveways

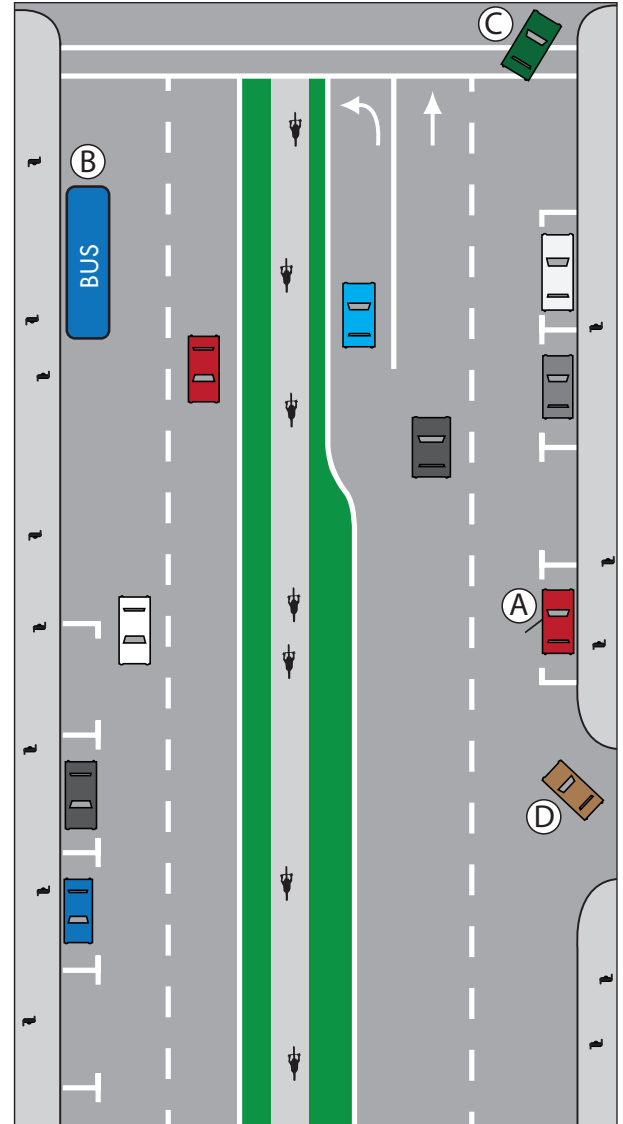

**Figure 9-11:**  
Median Bike Path

### NOTE

Examples of a median bike path that separates a frontage/local road from an arterial are the Brooklyn Greenway in New York and the Culver City Bike Path in Culver City and Los Angeles. More commonly, the median separates two opposing directions of traffic on a roadway. Places with bike paths on center medians include many Spanish-influenced countries that were laid out with wide medians, such as Peru and Mexico.

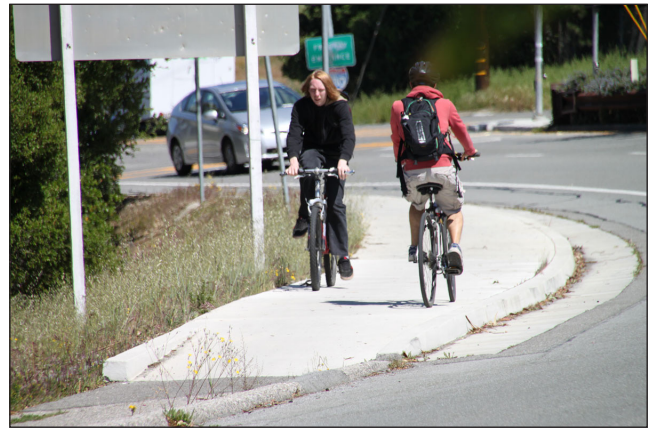

*This median path on El Monte Road connects the Foothill College entrance through the I-280 interchange enabling pedestrians and cyclists to avoid the eight high speed freeway ramps. Still, some cyclists prefer to ride on the road (left) while other cyclists choose to ride on the sidewalk (right). To be most useful as a bicycle facility, a median bike path should be at least ten feet wide and be long enough that it is worth making the effort to enter and exit the median. The El Monte Road pathway is less than half mile long. A typical adult cyclist can ride this distance in about two minutes.*

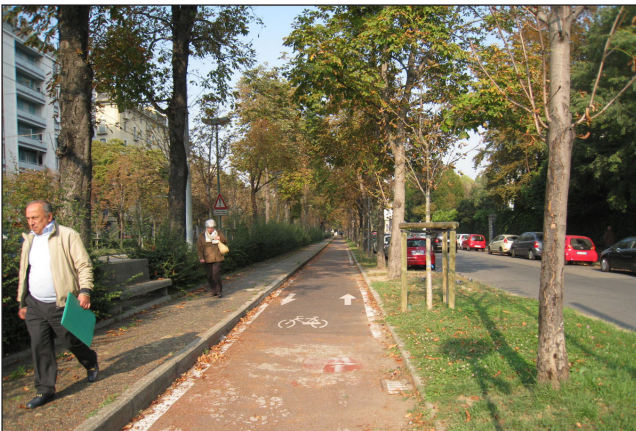

*Median bike paths in Turin Italy are often built with an adjacent sidewalk.*



*This median on Culver City Blvd. in Los Angeles has a median bike path and a parallel pedestrian path.*

# 10 BIKE PARKING

## 10.1 DEFINITIONS

### Class 1

A method of bicycle parking that protects the entire bicycle and its components from theft, vandalism or inclement weather. Class I bicycle parking is appropriate for long-term (two hours to all day) bicycle parking such as at employment sites, schools and transit stations/stops. It is also important at sites where bicycles are left overnight for several days such as airports, train stations and of course, multi-family residential units.

See Section 10.2 for a discussion on the various options for Class 1 bike parking.

### Class 2

A bicycle rack to which the frame and at least one wheel can be secured with a user-provided U-lock or padlock and cable. Racks that provide two points of contact prevent bikes from pivoting and falling over. Bike racks are appropriate for short-term parking where the typical parking duration is less than two hours. They can be thought of as serving the customer or visitor parking demand for locations such as retail stores, libraries, dental and medical offices, office buildings and at apartments/condominiums.

See Section 10.3 for discussion on the various options for Class 2 bike parking.

### Class 3

A bicycle rack designed such that only one wheel and not the frame can be locked to the rack. While still used in some situations like school yards, they are not secure. They are never recommended except in guarded areas or locked rooms where they are used in Class 1 situations.

### IN THIS CHAPTER:

- 10.1 Definitions
- 10.2 Class 1 Bike Parking Options
- 10.3 Class 2 Bike Rack Options
- 10.4 Placement Dimensions and Criteria
- 10.5 Bike Parking Quantity
- 10.6 Bike Parking Policies and Guidelines by Land Use Type



The Silicon Valley Bicycle Coalition provides free valet bike parking at many community events. This event utilized three on-street parallel spaces in downtown San Jose in order to park bicycles at the post-bike-to-work day bash in 2007.



Class 1



Class 2



Class 3



Typical mechanical bike locker with lock and key entry

**TECH TIP**

Detailed VTA Bike Locker Specifications are on file in the Service and Operations Planning Division.

- 1) Dimensions of approximately 42" wide by 75" deep by 54" high.
- 2) Must withstand minimum load of 200 lb. per square foot.
- 3) Opened door must withstand 500 lb. minimum vertical load.

**10.2 CLASS 1 BIKE PARKING OPTIONS**

Examples of Class 1 bike parking include bicycle lockers, rooms with key access for regular bicycle commuters, valet or check in parking and guarded parking areas. These and other variations should be discussed with the local jurisdiction’s Bicycle Advisory Committee. Section 10.6 presents guidance on appropriate types of Class 1 bike parking for various land uses including transit stations, office buildings, schools, commercial sites, employment centers and residential complexes.

Table 10-1 presents some of the variations of the options for Bike Lockers and their advantages and disadvantages.

<b>Table 10-1 Bike Locker Variations and Management Strategies</b>	
<b>Option 1. Reserved Lockers</b> Assign one locker per person, typically by issuing a key and requiring a key deposit (Current VTA practice). Some agencies also charge a monthly, quarterly or annual fee (Current Caltrain and BART practice).	
Advantages	Disadvantages
<ul style="list-style-type: none"> <li>a. Regular bike commuters have a guarantee that they will have a safe and secure bike parking place.</li> </ul>	<ul style="list-style-type: none"> <li>a. Lockers are not available to those who want to ride on the spur of the moment or who do not take the time and effort (and sometimes money) necessary to reserve it in advance.</li> <li>b. Space and cost-inefficient with one locker per one bicycle commuter because the locker is not available to anyone else even when the renter is not using it.</li> </ul>

<b>Option 2. First-Come First-Serve Bike Lockers (Day-use or On-demand lockers)</b>	
<b>2A Distribute key to locker user on demand at site.</b>	
<b>Advantages</b>	<b>Disadvantages</b>
<ul style="list-style-type: none"> <li>a. Available to any user without having to sign up and pay a deposit.</li> <li>b. Overall, accommodates more bicyclists with the same number of lockers.</li> </ul>	<ul style="list-style-type: none"> <li>a. This requires someone such as a security guard or parking lot attendant to be available to sign the key in and out.</li> <li>b. Due to constraint (a) above, this option may not be available 24 hours a day, 7 days a week.</li> </ul>
<b>2B Coin-operated Lockers</b>	
<b>Advantages</b>	<b>Disadvantages</b>
<ul style="list-style-type: none"> <li>a. Available to any user without having to sign up in advance and pay a deposit.</li> <li>b. Overall, accommodates more bicyclists with the same number of lockers.</li> <li>c. Available 24 hours a day, 7 days a week.</li> </ul>	<ul style="list-style-type: none"> <li>a. These have typically been removed due to continued vandalism, but they might be appropriate in certain controlled circumstances.</li> <li>b. They could also work with a token distributed as in Option 2A described above.</li> </ul>
<b>2C User provided lock – the bike locker is locked with a user-provided pad lock or U-lock</b>	
<b>Advantages</b>	<b>Disadvantages</b>
<ul style="list-style-type: none"> <li>a. Available to any user without having to sign up in advance and pay a deposit.</li> <li>b. Overall, accommodates more bicyclists with the same number of lockers.</li> <li>c. Available 24 hours a day, 7 days a week.</li> </ul>	<ul style="list-style-type: none"> <li>a. BART experienced a problem with theft and vandalism.</li> <li>b. They are easily misused for storage of property other than bicycles, requiring staff time for maintenance and property seizures.</li> <li>c. Perception by bicyclists that they are not as secure.</li> </ul>

**LOCAL PRACTICE**

City of Sunnyvale has public lockers that use bicyclist-provided locks at the library and at the Sunnyvale Caltrain station. In both locations, there are continuous issues to address and the biking public does not trust them. However the ones at City Hall for employees work well.

2D Smart Card – practice for new VTA Lockers	
Advantages	Disadvantages
<ul style="list-style-type: none"> <li>a. The locker is not monopolized by one person whether or not they use it.</li> <li>b. Overall, accommodates more bicyclists with the same number of lockers.</li> <li>c. The smart card can be used at any VTA locker system-wide, and also at lockers with similar technology Bay Areawide.</li> <li>d. Can be easily monitored. Data is gathered on how many people and how often and/or how long lockers are rented.</li> <li>e. Available 24 hours a day, 7 days a week.</li> </ul>	<ul style="list-style-type: none"> <li>a. Users will still have to sign up in advance in order to obtain the Smart Card (this will enable the user to use a locker at any location with an e-locker, not just one locker at one location).</li> <li>b. Nominal charge for bike parking to pay for the smart card technology compared to current VTA policy of free lockers.</li> </ul>



*Electronic bike locker display options*



Table 10-2 Bike Stations/Bike Rooms Management Strategies	
Option 1. Bike Stations	
1A Valet (Attended) Bike Parking	
Advantages	Disadvantages
<ul style="list-style-type: none"> <li>a. The safest most secure bike parking.</li> </ul>	<ul style="list-style-type: none"> <li>a. Nominal charge for bike parking to pay for the smart card technology compared to current VTA policy of free lockers.</li> </ul>
1B Smart-card Bike Room Parking	
Advantages	Disadvantages
<ul style="list-style-type: none"> <li>a. Provides a place to leave a bike where the general public does not have access.</li> <li>b. Can be open 24 hours a day, 7 days a week.</li> </ul>	<ul style="list-style-type: none"> <li>a. Theft of bike and bike components can still occur; although frequency is much less due to the video surveillance cameras and tracking name and time of entry through the smart card keys.</li> </ul>
Option 2. Fenced Compounds and Locked Rooms	
Advantages	Advantages
<ul style="list-style-type: none"> <li>a. Provides a place to leave a bike where passersby and/or strangers do not have access.</li> <li>b. If inside/covered then also protects bike from the elements.</li> </ul>	<ul style="list-style-type: none"> <li>a. Theft of bike and bike components can still occur although frequency is less.</li> </ul>



*Bike Station at downtown Berkeley BART station provides attended bike parking*

**LOCAL PRACTICE**

The Palo Alto Bike Station reopened on February 27, 2007 as a secure parking bike room with 24 hour access using a “smart” card key. Inside the secured building there are 96 bicycle racks which are also monitored by security cameras. Bicyclists must subscribe and can pay daily, monthly or annually.

**TECH TIP**

**Bike Racks shall be:**

- Steel or stainless steel (other metals such as brass are not recommended since they are softer and are also themselves a valuable target for thieves).
- If square tubing: 2 inch square tube, 0.188" min wall thickness.
- If round pipe: 2 inch schedule 40 pipe (OD 2.375, ID 2.067, wall thickness 0.154 inch) and rack must be designed such that bike cannot be stolen with only one cut.
- Finishes for steel: galvanized, polyester-powder coat paint, thermoplastic or PVC jacket.

**10.3 CLASS 2 BIKE RACK OPTIONS**

Typical bike rack dimensions are illustrated in Figure 10-1. Acceptable design options are presented in Figure 10-2. Some designs are more suitable for smaller installations while others are more suitable for large quantities of bikes. These designs have the following elements in common:

- Schedule 40 steel pipe or stronger (see Tech Tip sidebar)
- Two points of contact to support the bike frame
- Able to secure frame and one wheel with a U-lock

The wave or ribbon rack, while popular with some bicyclists, only provides one point of contact. It is not recommended for new installations, but it is still functional with a U-lock. It is generally not worth replacing. Class 3 “wheel bender” racks, however, should be replaced. (However, in Class 1 situations they are acceptable as described in Section 10.1.)

Guidance on where to place bike racks in specific settings is presented in Section 10.4 and illustrated in Figures 10-4 through 10-6.

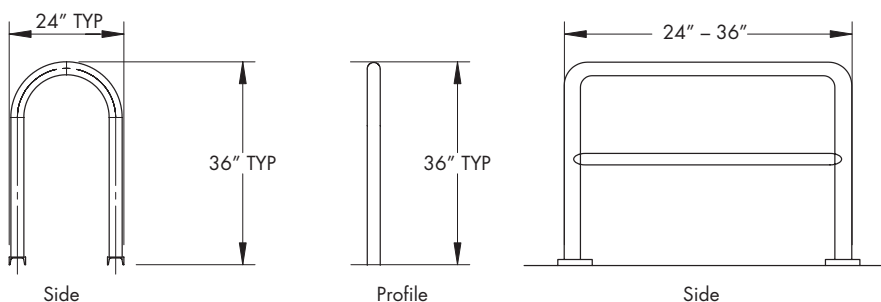

**Figure 10-1:**  
**Typical Dimensions – Inverted U and Variations**

Not to scale

▶ For more guidance on bike rack design principles, see *Bicycle Parking Guidelines* published by the Association of Pedestrian and Bicycle Professionals (APBP) available at [www.apbp.org](http://www.apbp.org)



*Inverted U-Class 2*



*Ribbon/Wave Rack*



*Class 3 Rack*

**FIGURE 10-2 BIKE RACK DESIGN OPTIONS**

**INVERTED U RACKS AND VARIATIONS – 1 or 2 bikes per rack**



Flat Top



Circle



Horse Rail



Artistic

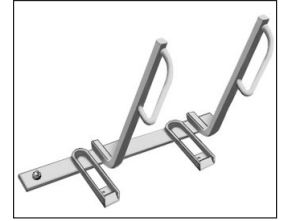

Lightning Bolt

**METER POST RACKS – Typically 1 or 2 bikes per meter**



Meter Rack



Meter Retrofit

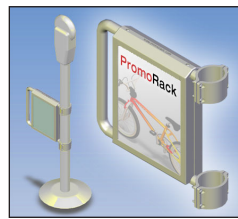

Meter Rack



Parking Meter

**HIGHER CAPACITY BIKE RACK OPTIONS – Inverted U Racks**

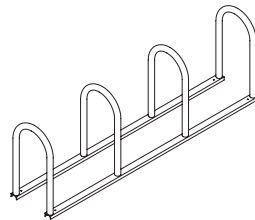
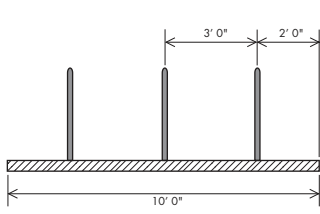

**HIGHER CAPACITY BIKE RACK OPTIONS – Spiral Racks and Artistic Racks**

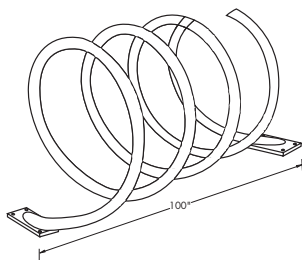

**HIGHER CAPACITY BIKE RACK OPTIONS – Coat Hanger Bike Racks**

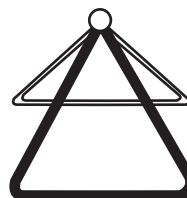
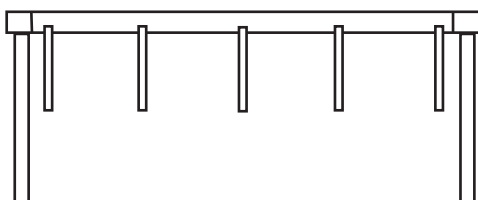



Without adequate bike racks, bicyclists are forced to park at whatever is available



Typical VTA bike locker layout

### 10.4 PLACEMENT DIMENSIONS AND CRITERIA

To be effective, bicycle racks and lockers must be placed such that:

1. Security is maximized (See Sections 10.4.1 and 10.4.2);
2. Pedestrian circulation is not adversely impacted (See Section 10.4.3); and
3. They can be used to their maximum design capacity.

Guidelines for selecting and designing the optimum site for bicycle racks and lockers are presented below. Placement dimensions and guidelines for lockers are presented in Figure 10-3 and for bicycle racks in various locations are presented in Figures 10-4 through 10-6.

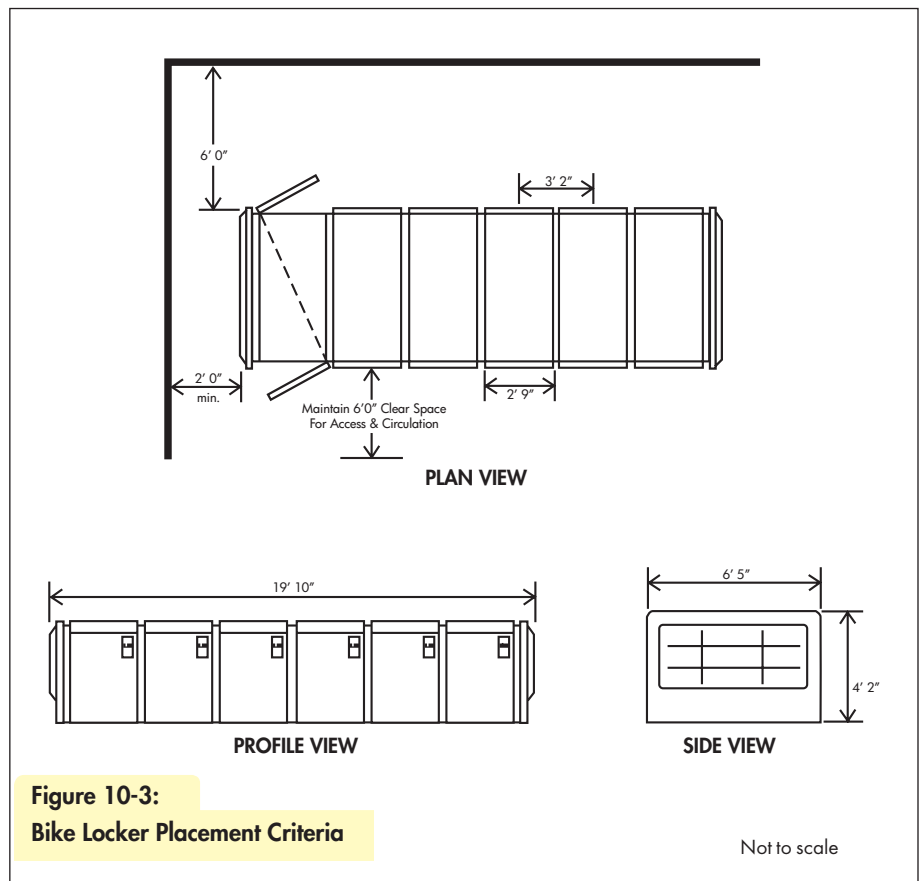

Coat Hanger Rack  
Plan View

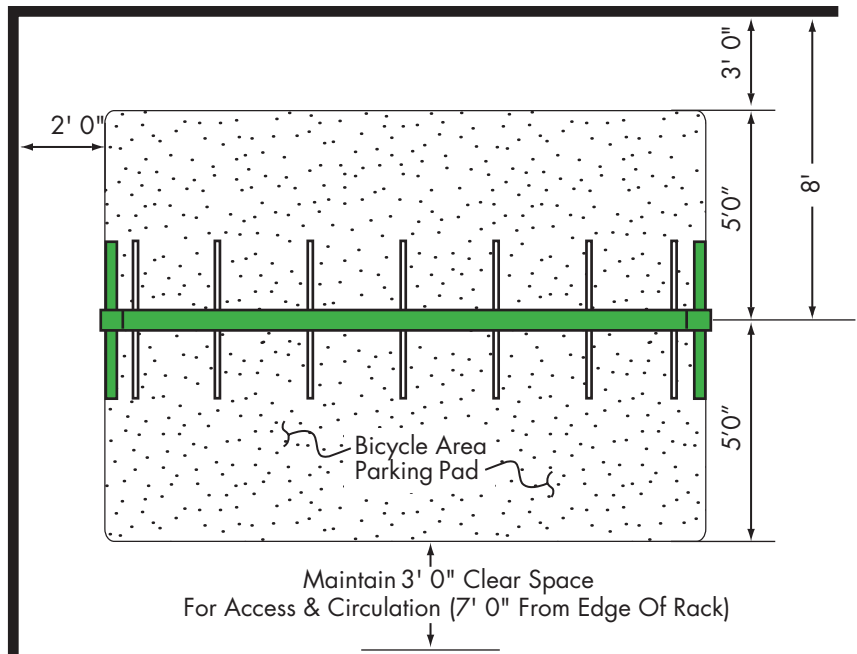

Inverted U-Racks  
Plan View



Maintain 2' clear space from any building wall or other obstruction

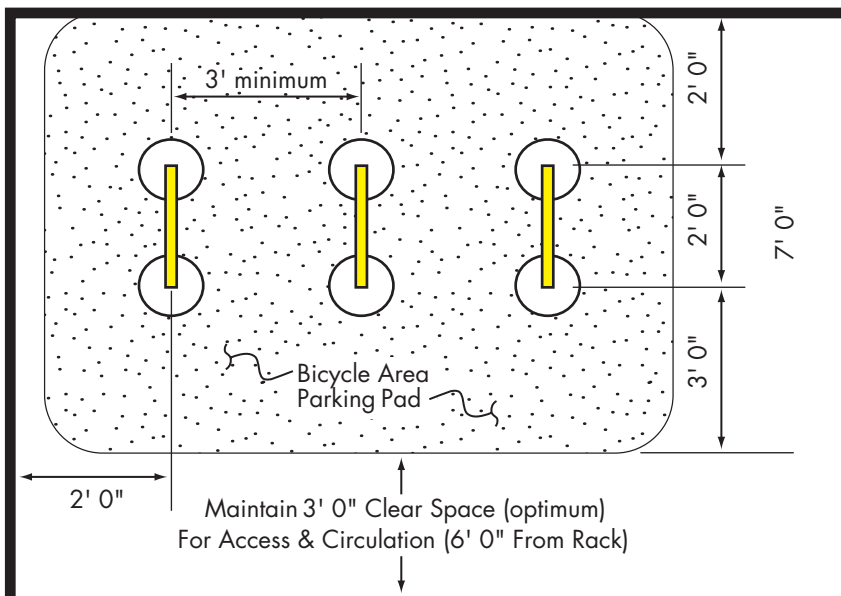

Not To Scale

**Figure 10-4:**  
Bike Rack Placement Criteria (in Plazas or near Buildings)

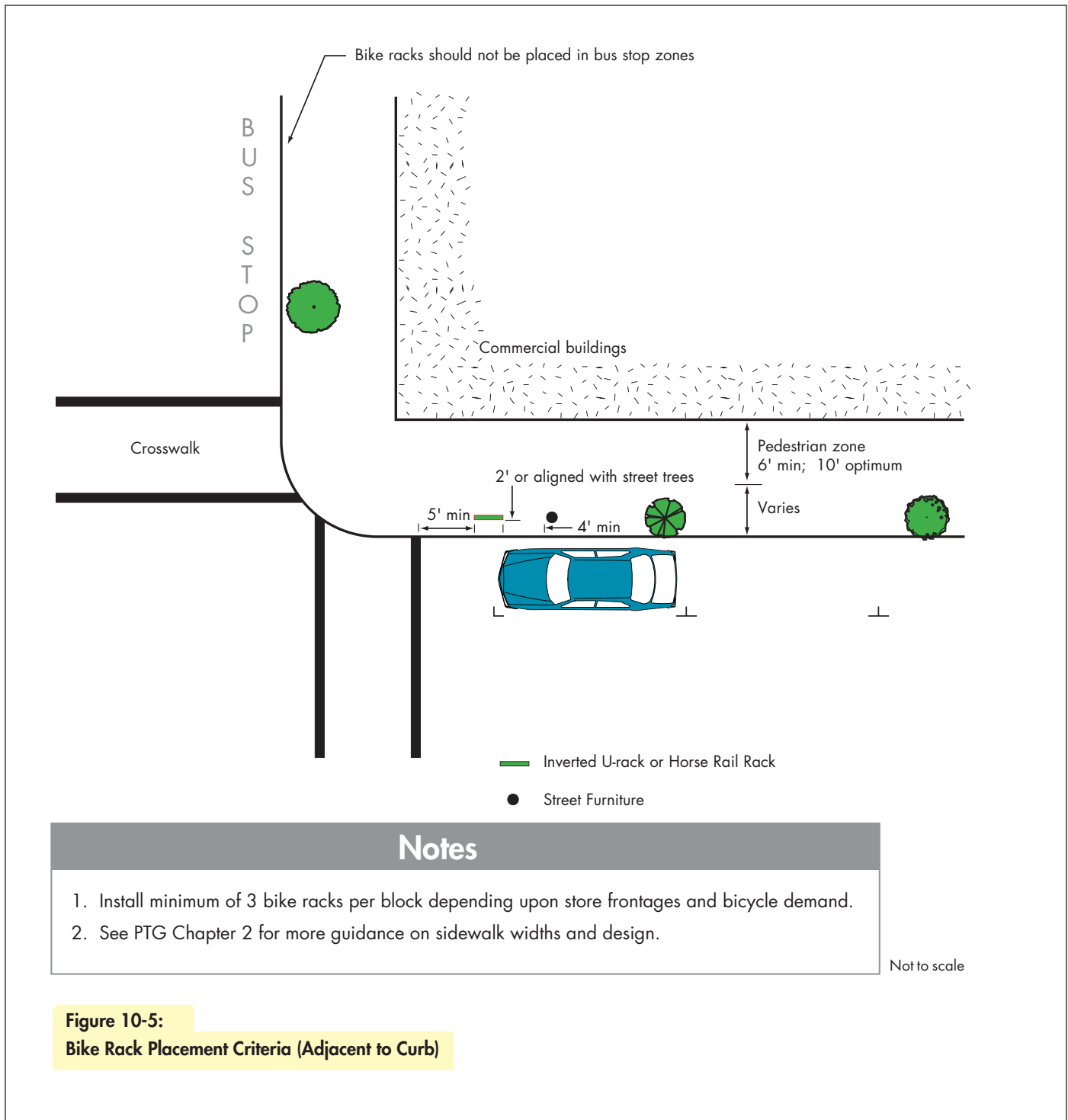

### Notes

1. Install minimum of 3 bike racks per block depending upon store frontages and bicycle demand.
2. See PTG Chapter 2 for more guidance on sidewalk widths and design.

Not to scale

**Figure 10-5:**  
Bike Rack Placement Criteria (Adjacent to Curb)

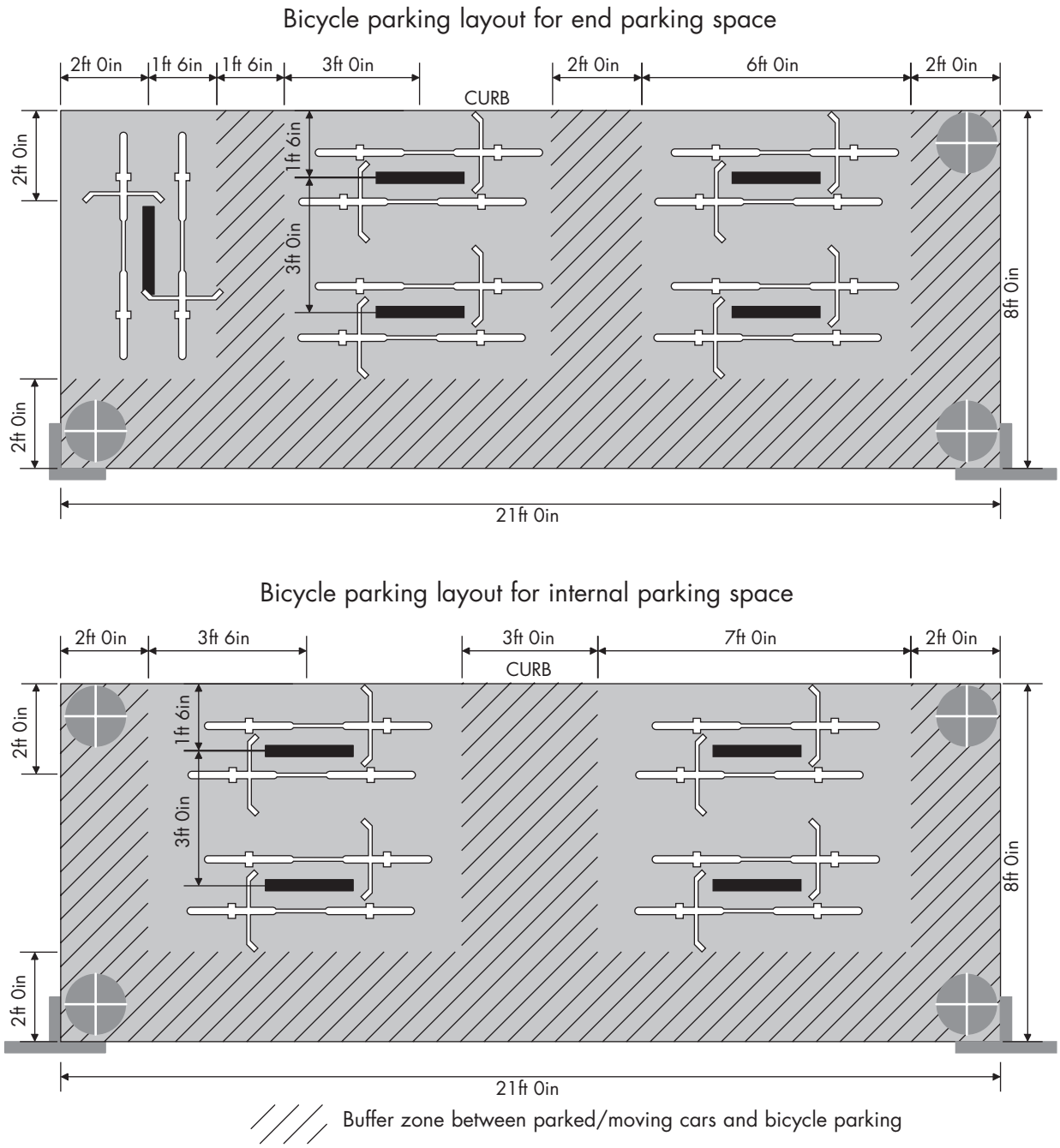

Not To Scale

**Figure 10-6:**  
**Bike Rack Placement Criteria (On-Street Parking Space)**



*Bike racks at UC Berkeley are located outside the travel path of pedestrians.*



*Overflow demand for bike parking at the Palo Alto Caltrain station.*

#### 10.4.1 Security and Theft From Vandalism

- Racks should not be obscured by landscaping, fences, or other obstructions.
- Racks should be lit at night to protect both the bicycle and the user.
- Visibility to racks should be provided to at least one of the following: security guard, station agent, parking garage attendants, clerks, vendors, or passing pedestrians.
- Unguarded shared parking areas should issue keys only to those who share an affiliation. Locker placement is more flexible, but it should still be convenient for the bicyclist. A rule of thumb is that lockers should be located at least as close as the nearest motor vehicle parking, if any.

#### 10.4.2 Utility and Convenience

- Racks should be located within 50 feet of building entrance and should be clearly visible from the building entrance and its approaches. If this is not possible, signs should be posted to direct bicyclists to the bike parking. See Section 10.4.4.
- Protection from the weather should be provided for a portion of the rack supply.
- Ground surface of the bicycle parking area should be an all-weather and drainable material such as asphalt or concrete; care should be taken when using brick, or other materials that can become slippery when wet.
- Lockers should also be placed on hard all-weather surface and locker users will appreciate a cover from the rain; lockers made of perforated metal should definitely be covered to protect the contents from the rain.

#### 10.4.3 Pedestrian and Vehicle Conflicts

- Racks shall be located outside the typical pedestrian travel path, with additional room for bicyclists to maneuver outside the pedestrian way.
- Racks shall be of minimum height so as to increase their visibility to pedestrians. See also Figure 10-1 and TDMG Figure T-7.
- Racks shall be located at a sufficient distance from motor vehicles to prevent damage to parked bicycles and motor vehicles. (See Figures 10-4, 10-5 and 10-6).



#### 10.4.4 Signage to Bike Parking

- Signage should be posted to direct bicyclists to the locations of bicycle racks that may not be readily apparent such as in parking garages.
- Similarly, signs indicating the location of bicycle parking should be posted wherever a NO BICYCLE PARKING sign is posted.

#### 10.5 BIKE PARKING QUANTITY

Recommendations for bicycle parking supply are presented in Table 10-3. Optimally, a mix of both Class 1 and Class 2 parking should be provided in virtually all locations. The parking rates in Table 10-3 are for communities with bicycle commute rates of less than 2% (the countywide average). It is recommended that the amount of bicycle parking be increased proportionately for those cities or communities whose bicycle commute rates exceed the countywide average. The parking demand-to-capacity ratio should be monitored and additional parking should be provided as needed.

**Table 10-3  
Bicycle Parking Supply Recommendations**

Use	Required Number of Bicycle Spaces <sup>(1)(2)</sup>
<p><b>Residential (such as apartments, condominiums &amp; townhouses)</b></p> <ul style="list-style-type: none"> <li>• General, multi-dwelling</li> <li>• Primarily for students &amp; low-income families, multi-dwelling</li> <li>• Primarily for residents 62 and older, multi-dwelling</li> </ul>	<p>1 Class I per 3 units + 1 Class II per 15 units. 1 Class I per 2 units + 1 Class II per 15 units 1 Class I per 30 units + 1 Class II per 30 units</p>
<p><b>Schools</b></p> <ul style="list-style-type: none"> <li>• Elementary, middle &amp; high schools</li> <li>• Colleges - Student residences</li> <li>• Academic buildings and other university facilities</li> </ul>	<p>1 Class I per 30 employees<sup>(3)</sup> + 1 spot per 12 students (50% Class I and 50% Class II) 1 Class I per 4.5 beds + 1 Class I per 30 employees 1 Class I per 30 employees + 1 spot per 9 student seats (25% Class I and 75% Class II)</p>
<p><b>Park-and-Ride Lots/Parking Garages</b></p>	<p>7% of auto parking (75% Class I &amp; 25% Class II)</p>
<p><b>Transit Centers</b></p>	<p>2% of daily home-based boardings (75% Class I and 25% Class II)</p>
<p><b>Cultural/Recreational</b> (includes libraries, theaters, museums, &amp; religious institutions)</p>	<p>Class I per 30 employees + (Class II 1,500 sq. ft. or Class II per 60 seats (whichever is greater))</p>
<p><b>Parks/Recreational Fields</b></p>	<p>1 Class I per 30 employees + Class II per 9 users During peak daylight times of peak season</p>
<p><b>Retail Sales/Shopping Center/Financial Institutions/Supermarkets</b></p>	<p>1 Class I per 30 employees + Class II per 6,000 sq. ft.</p>
<p><b>Office Buildings/Offices</b></p>	<p>1 per 6,000 sq. ft. (75% Class I &amp; 25% Class II)</p>
<p><b>Hotels/Motels/Bed-&amp;Breakfasts</b></p>	<p>1 Class I per 30 rooms + Class I per 30 employees</p>
<p><b>Hospitals</b></p>	<p>1 Class I per 30 employees + 1 Class II per 45 beds</p>
<p><b>Restaurants</b></p>	<p>1 Class I per 30 employees + 1 Class II per 3,000 sq. ft.</p>
<p><b>Industrial</b></p>	<p>1 Class I per 30 employees or 1 Class I per 15,000 sq. ft.</p>
<p><b>Day Care Facilities</b></p>	<p>1 Class I per 30 employees + 1 Class II per 75 children</p>
<p><b>Auto-Oriented Services</b></p>	<p>1 Class I per 30 employees</p>
<p><b>Other Uses</b></p>	<p>Same as most similar use listed</p>
<p><b>Notes</b></p> <p>(1) For cities with less than 2% bicycle commuter rate. Cities with different bicycle commute rates should pro-rate these accordingly.</p> <p>(2) The minimum number of required Class II Bicycle parking spaces is 4, except when the code would require 1 or less, in which case 2 bicycle spaces must be provided.</p> <p>(3) Employees = maximum number of employees on duty at any one time.</p> <p>Source: League of American Bicyclists, 1994.</p>	

## 10.6 BIKE PARKING POLICIES AND GUIDELINES BY LAND USE TYPE

### **VTA Bike Parking Policy**

1. Provide bike lockers at each Transit Center and Park & Ride lot. Work with cities to provide bike racks at each LRT station and major bus stops.
2. Existing fleet of VTA bike lockers are reserved in advance with a key deposit.
3. VTA will begin to retrofit its existing fleet of lockers to use Smart-Card technology so that lockers will be available on a first-come first-served basis, with a nominal fee.
4. Any new lockers purchased will use Smart Card technology.

### **Transit Station Guidelines**

Class 1-The Class 1 parking should consist of either lockers (preferably first-come first-serve/day-use) or guarded bicycle parking. The exact quantity will be determined by initial survey and monitoring. The initial supply of Class 1 parking should be equal to 1.5% percent of daily home-based boardings. More should be added as demand increases. The lockers should be located convenient to the transit center entrance and within sight of passengers, to discourage vandalism.

Class 2-Bicycle racks ideally should be placed in an active area close to boarding platforms. They should not be placed in obscure areas out of public view. The quantity of bike racks will depend on how much of the demand is satisfied by Class 1 parking; the total of Class 1 and Class 2 parking supply initially should be 2% percent of daily home-based boardings.

See Section 10.4 for more guidance

### **Office Buildings**

Class 1-Typical Class 1 parking for office buildings should consist of either bicycle lockers or locked rooms within the parking garage or the building. Variations include allowing employees to bring their bicycles into their own office or work area. Where city ordinance permits, bicycle parking can often be carved out of unused spaces inside buildings, such as under stairwells.

The exact quantity will need to be determined by monitoring use. The initial supply should be equal to 3% percent of the number of employees or as recommended in Table 10-3.

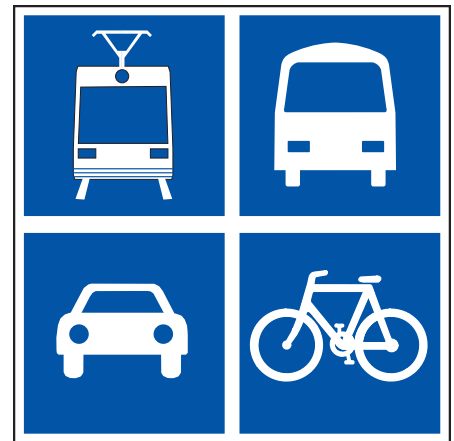

Class 2-Bicycle racks should be provided for visitors/deliveries near the front door of every building. A minimum of two to four racks should be provided, with additional capacity as recommended in Table 10-3.



*Bike parking at Stanford University; racks are found outside each building.*

### **Industrial Sites/Campus Employment Centers**

Class 1-The Class I parking should consist of either bicycle lockers or locked compounds within the parking lots or the buildings. In addition, allowing employees to bring their bicycles into their own buildings is effective Class I parking.

Class 2-Bicycle racks located near all building entrances should be provided for visitors as well as employees who travel to various buildings within the worksite/campus during the work day.

### **Stand Alone Commercial Sites**

Class 1-Class I parking should be provided for the employees of the businesses as recommended in Table 10-3.

Class 2-Racks near the building entrances should be provided at each stand-alone business. Land-uses such as grocery stores where bulky purchases are made should provide a minimum of two stalls large enough to accommodate bicycles with trailers. The quantity should comply with Table 10-3.

### **Schools and Colleges**

Class 1-Providing covered bicycle racks within a fenced locked area works well for both students and teachers at smaller campuses. These compounds at grade schools and junior high schools are typically locked during the school day by the janitor or other staff person. Depending on the number of bicycles, separate areas maybe needed for students and teachers. Where the risk of theft is particularly high, such as community colleges with large numbers of expensive bicycles, the compound should be watched by an attendant, as is the procedure at CSU Sacramento. Dormitories should provide Class 1 parking for all residents.

Class 2-Racks holding four to eight bicycles should be provided within view of the school office for visitors or those staying only a few hours or less. These racks would also be available for students who are late and are locked out of the compound. At colleges, racks should be provided at the main entrances to all classrooms, lecture halls, libraries and cafeterias.

### **Multi-Family Residential Units**

Class 1-Individual garages serve as Class 1 parking for most single-family and for some multi-family dwelling units. Where multi-family units do not have individual garages, the following options are appropriate:

1. Traditional bike lockers located on the premises (either for each unit or as requested by tenant)
2. Locked large individual storage area for each unit
3. Bike cage with limited access within the locked parking garage (such as Option 2 on page 10-5.)

### Class 2-Visitor Parking

Bike racks should be provided near the front door of a large unit with a single entrance or within a highly visible place in a development with multiple doors.

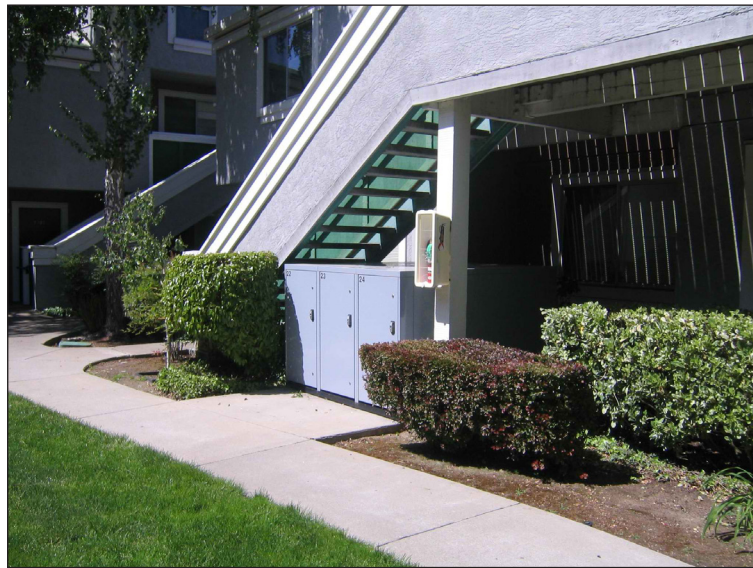

*Variations in Class 1 secure parking for multi family residential units - at left: a locked room; at right: individual bike lockers.*

*This page intentionally left blank for duplex printing*